

INFORMATION ON IMPROVED LATRINE OPTIONS

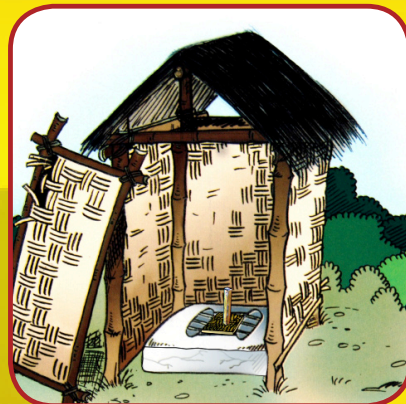

Semi-Permanent



Semi-Permanent



Permanent



Permanent



**Water and Sanitation Program
East Asia and the Pacific (WSP-EAP)
World Bank Office Jakarta**

Indonesia Stock Exchange Building Tower II/13th Floor,
Jl. Jend. Sudirman Kav. 52-53
Jakarta 12190 – Indonesia
Tel.: (62-21) 52993003
Fax: (62-21) 5299-3004

Printed in 2009

Produced in support of the Sanitasi Total dan Pemasaran Sanitasi (SToPS) projects, a partnership between the government of Indonesia, The Bill and Melinda Gates Foundation, and Water and Sanitation Program - East Asia and Pacific

INFORMATION ON IMPROVED LATRINE OPTIONS



TABLE OF CONTENTS

Part 1	Introduction	3
Part 2	what to be achieved from the CLTS Program	5
	• The objectives of this Informed Choice Catalog of Improved Latrines	5
	• The Appropriate times to use the Improved Latrine Catalog:	6
	• One Community has defined ODF	6
	• Community has defined total sanitations	6
Part 3	what do we mean by “Latrine”?	7
	• Semi - Permanent and Permanent Structures (“Jamban Sehat” and “Jamban yang Sehat”)	7
	• What are the benefits to use a latrine?	8
	• Improved latrine structure	10
	• Underground structure of an Improved Latrine	13
Part 4	Type of Latrines for special conditions	
Part 5	Some Latrine Modes in “Special Conditions”	17
	• Raised-platform of latrine	17
	• Latrine for flooding/tidal areas/houses built on stilts	18
	• Communal sanitation system for densely populated areas	19

Part 1

INTRODUCTION

We all know that having and using a latrine is not only convenient but also can protect and improve the health of our families and communities. However, all data available from rural sanitation studies and surveys in Indonesia shows that very few rural households actually have access to safe latrines. Only 37% of its rural population has access to safe sanitation according to a report from the Joint Monitoring Program 2008. Although we do not fully understand all the reasons for this, part of the explanation could be that many existing latrines are elaborate and expensive, giving the impression that they are not affordable to low-income families. This booklet was developed to show that there is a wide range of rural latrine options and latrine designs adapted for users with special needs or for use in special circumstances (flooding, high groundwater table).

Such different latrine types that can be used in rural areas are shown in pictures together with advantages and disadvantages, expected life span and needed materials. This format makes it easy to present a range of options and to discuss villagers' preferences (depending on their willingness and ability to pay). Once a choice has been made, the latrine construction manual (published separately) can be used to determine detailed construction steps, material requirements, etc.

This booklet is really meant to be useful to anyone interested in and working on sanitation programs, and raise people's awareness of options, create sanitation demand and work on actual construction of latrines. Typical users may include government health workers, NGOs, CBOs, IOs, facilitators, natural leaders, and people engaged in sanitation, and so on. We hope that this booklet may increase sanitation demand in Indonesia, and enable people to make informed choices about technically feasible and affordable sanitation options.

The materials in this booklet will explain the following:

- What a latrine is;
- The difference between wet and dry-pit latrines;
- Different parts that make up a latrine above the ground (superstructure) and under the ground (pit);
- What advantages and disadvantages are of all the choices;
- Approximate costs for each part of a latrine and its expected life span;
- Different ways in which a basic design can be adapted to users' needs or circumstances.

We leave the decision about how to best present this information to the creativity of the user. However, it makes sense to ensure that some basic ideas have been understood before moving on to more detailed subjects.

For example, make sure that everybody understands what a latrine is before discussing detailed designs.

We do hope that all stakeholders in both governmental and non-governmental agencies who are responsible for rural sanitation programs will use this Informed Choice Manual for Improved Latrine Selection to improve rural households' access to sanitation in order to achieve the MDG goals by 2015.

Part 2

WHAT TO BE ACHIEVED FROM THE COMMUNITY BASED TOTAL SANITATION (STBM) PROGRAM

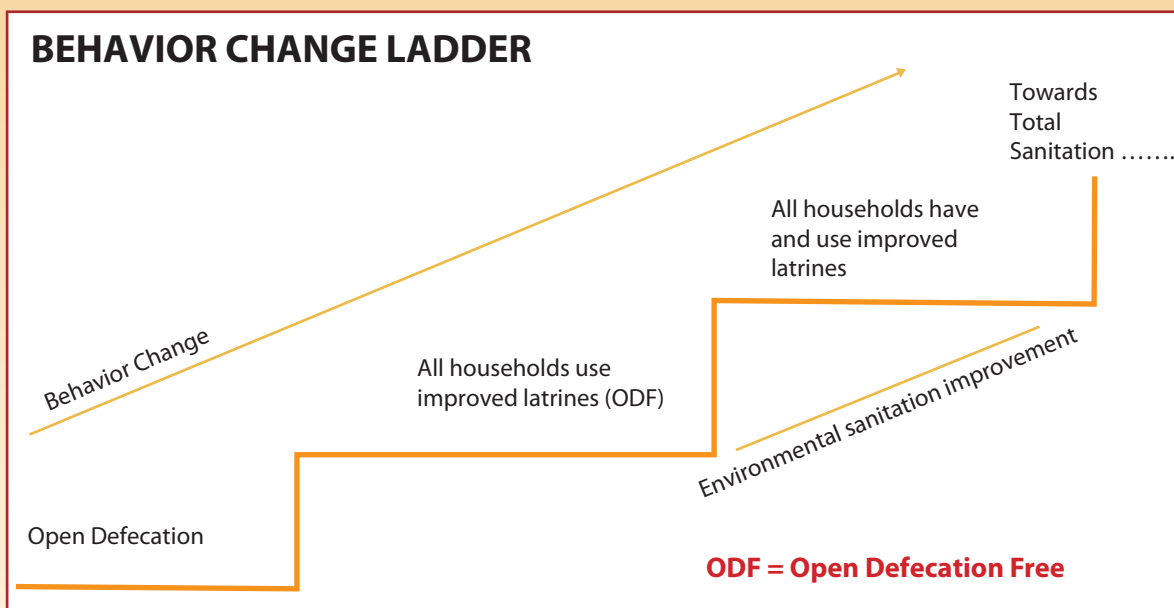

The objectives of this Informed Choice Catalog of Improved Latrines are to:

- Provide information on improved latrines to minimize contamination
- Help people to identify latrines according to their needs and ability
- Serve as a means of communication in selecting a latrine technology.

The appropriate times to use the Improved Latrine Catalog are:

- When people ask about how to build a latrine
- When people have been committed to changing their behavior and want to build a latrine.

A community has defined ODF... if:

- All households defecate only in improved latrines and dispose of babies' feces only to improved latrines. (including at school)
- No human excreta is seen around community surrounding
- There are sanctions, rules or other safeguards mechanism imposed by the community to prevent open defecation practice
- A monitoring system is in place by and for the community
- There is pathway or strategy for future effort toward total sanitation

A Community has defined total sanitation if:

- All communities have stop open defecation
- All communities have and use improved latrine and maintain it well.
- All communities has familiar to wash their hand with soap after defecating, after pouring their children after defecating, before eating, before feeding baby, and before preparing food
- All communities has managed and stored drinking water and food safely.
- Manage households wastewater and trash safely

Part 3

WHAT DO WE MEAN BY “LATRINE”?

A latrine is a safe and private place to be used for defecation. A wide range of latrines are used in households, schools, houses of worship, and other agencies.

An Improved Latrine is a defecation facility that:

- 1) Prevents contamination of water bodies
- 2) Breaks contact between humans and feces
- 3) Prevents feces exposure to insects and other vectors
- 4) Prevents unpleasant odor
- 5) Well constructed, safe and easy-to-clean slab

Semi - Permanent and Permanent Structures (“Jamban Sehat” and “Jamban yang Sehat”)

When a community is triggered, people build many kinds of self - constructed latrine, less permanent latrines with whatever materials they can find, because they urgently want to become free of open defecation (ODF). As long as the semi - permanent latrines can fulfil the 5 (five) requirements of a hygienic latrine, it can be accepted as “improved sanitation”. However, it is necessary to carefully maintain or later upgrade these structures as they may become unsafe and unhygienic over time, due to rain, flooding, collapse or breakage. For ease of communication, this catalogue classifies the semi - permanent structures as “jamban yang sehat”, and the more permanent structures as “jamban sehat”.

Please remember ...



What are the benefits to use a latrine?

Building and using a latrine gives the following benefits:

- Greater dignity and privacy
- A cleaner environment
- Reduced smell and improved sanitation and hygiene
- Improved safety (no need to go out into the fields at night)
- Saves time and money, and produces compost and biogas for energy
- Breaks the transmission cycle of sanitation related diseases.

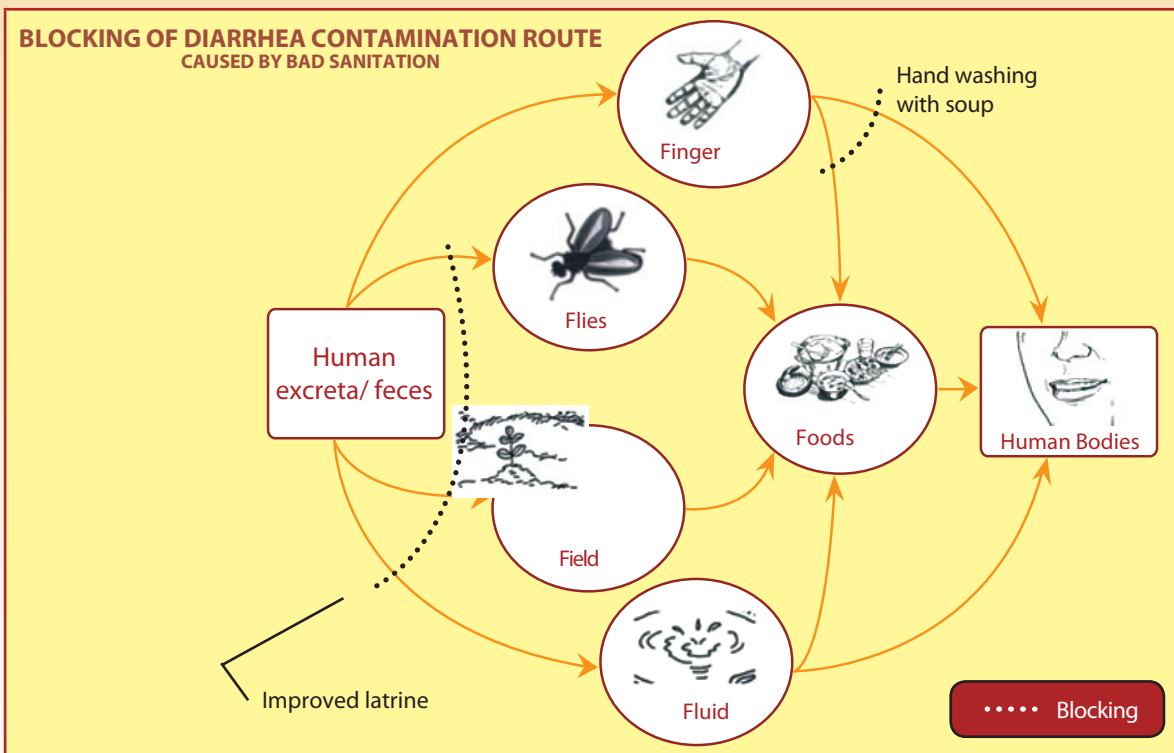
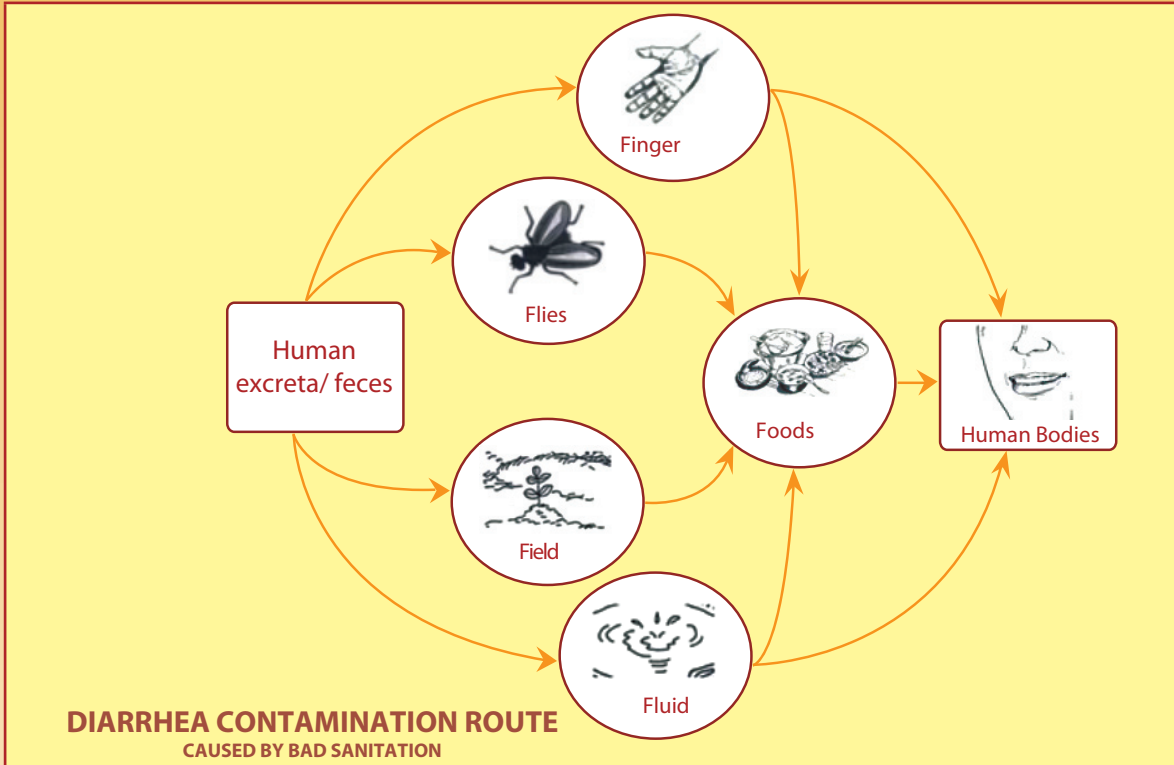

Improved Latrine Structure

A latrine consists of 3 main parts, i.e.: 1) above ground called Superstructure, labeled "A"; 2) on the ground called Slab, labeled "T"; and 3) under ground called pit, labeled "B".

Each part is described in more detail below:

1. Above-ground part (Superstructure)

This part wholly consists of roof, frame and walls. In practice, however, these required parts will depend on the ability of the local community.

- Roof gives privacy and protection to the user from the sun, wind, and rain. It can be made of leaf, roof tiles, zinc, etc.
- Frame is used to support the roof and walls. It can be made of bamboo, wood, etc.
- Walls are part of the superstructure. They give privacy and protection to the users. They can be made of leaf, mat/woven bamboo, bricks, zinc, wood, etc.

2. On-the-ground part (slab)

- Slab covers the pit, and provides footrests. It can be made of any material which is strong enough to support the users. Materials used should be long-lasting and easily cleaned such as wood, concrete, bamboo with clay, etc.
- Ash or water jar is a jar to store ash or water. Sprinkling some ashes in the pit after use reduces smell, reduces moisture content and makes it unattractive for flies to breed in. Water can be used for hand washing and general cleaning.

3. Underground part (Pit)

A pit is an underground hole that can be square, round or rectangular, but a round pit is the strongest. Maximum depth depends on the soil conditions and groundwater levels in the rainy season. In unstable soils, the pit may have to be fully or partly lined with woven bamboo, bricks, concrete rings, etc.

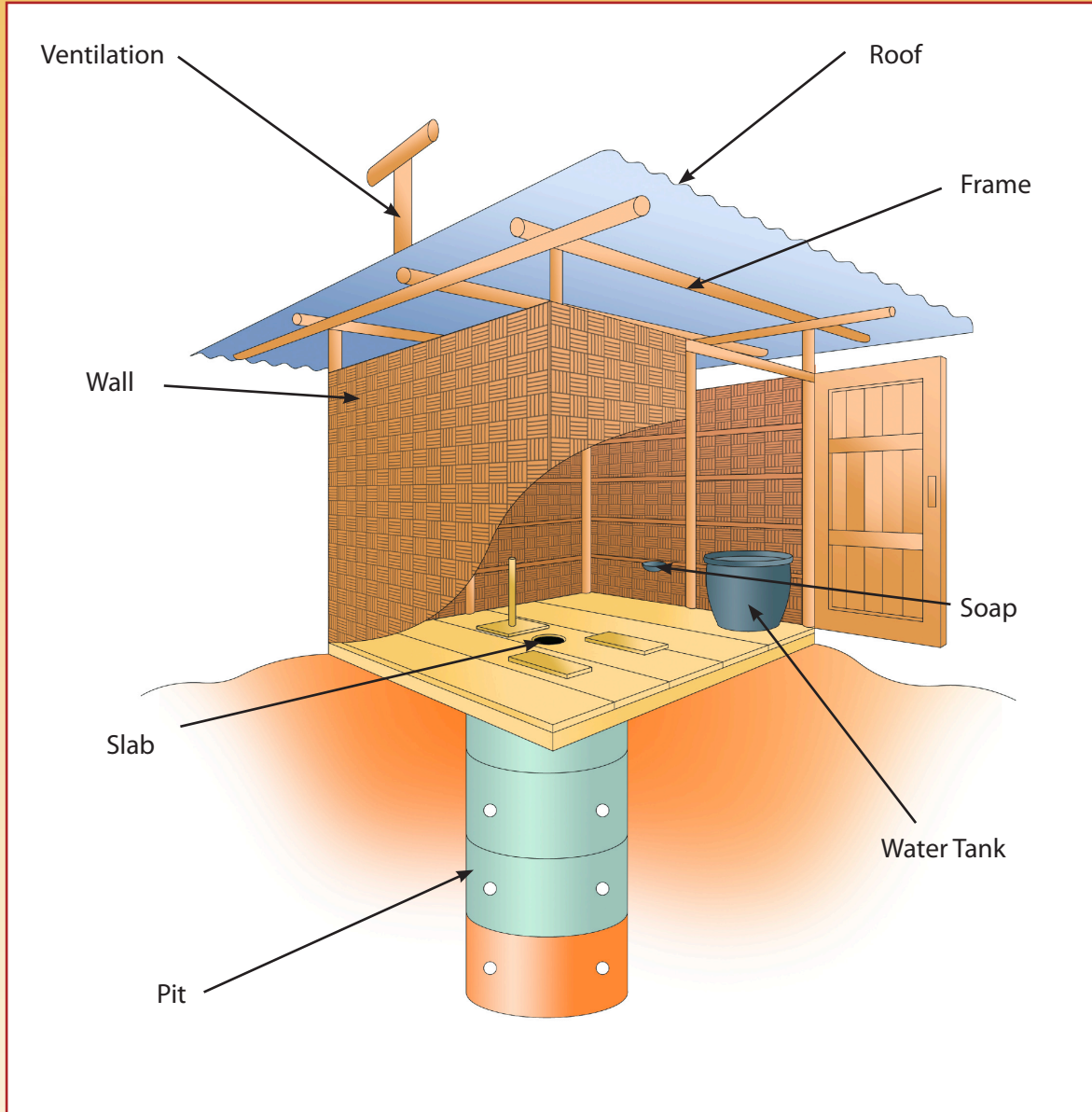

Any type of improved latrine that breaks the contact between feces and the environment will be of benefit to its users. So building and using a latrine -any type at all- is the most important step to take. For added benefit and convenience, please pay attention to the following points.

1. Above-ground part considerations

- Air circulation
- It minimizes weather-related problems, i.e. heat and rain
- Easy access at night
- It avoids possible visibility from outside
- Recommended to use local materials
- Hand washing facility is provided

2. On-the ground part considerations:

- There is a lid on the hole to prevent its exposure to insects and other vectors
- The slab is constructed by paying attention the user's safety (not slippery, collapsing and slipping into the pit, etc)
- It prevents possible unpleasant odor from excrement in the pit
- Easy to maintain
- Preferable to use local materials
- Ventilation system
- Permanent structure with a manhole

3. Underground part considerations

- Groundwater table
- Permiabile soil (type of soil)
- Structure type, distance and slope from a water source (preferably above 10m)
- Population density (land availability)
- Useful life (possible emptying, hole depth/capacity)
- Preferable to use local materials

Flowchart of the underground structure of an Improved Latrine

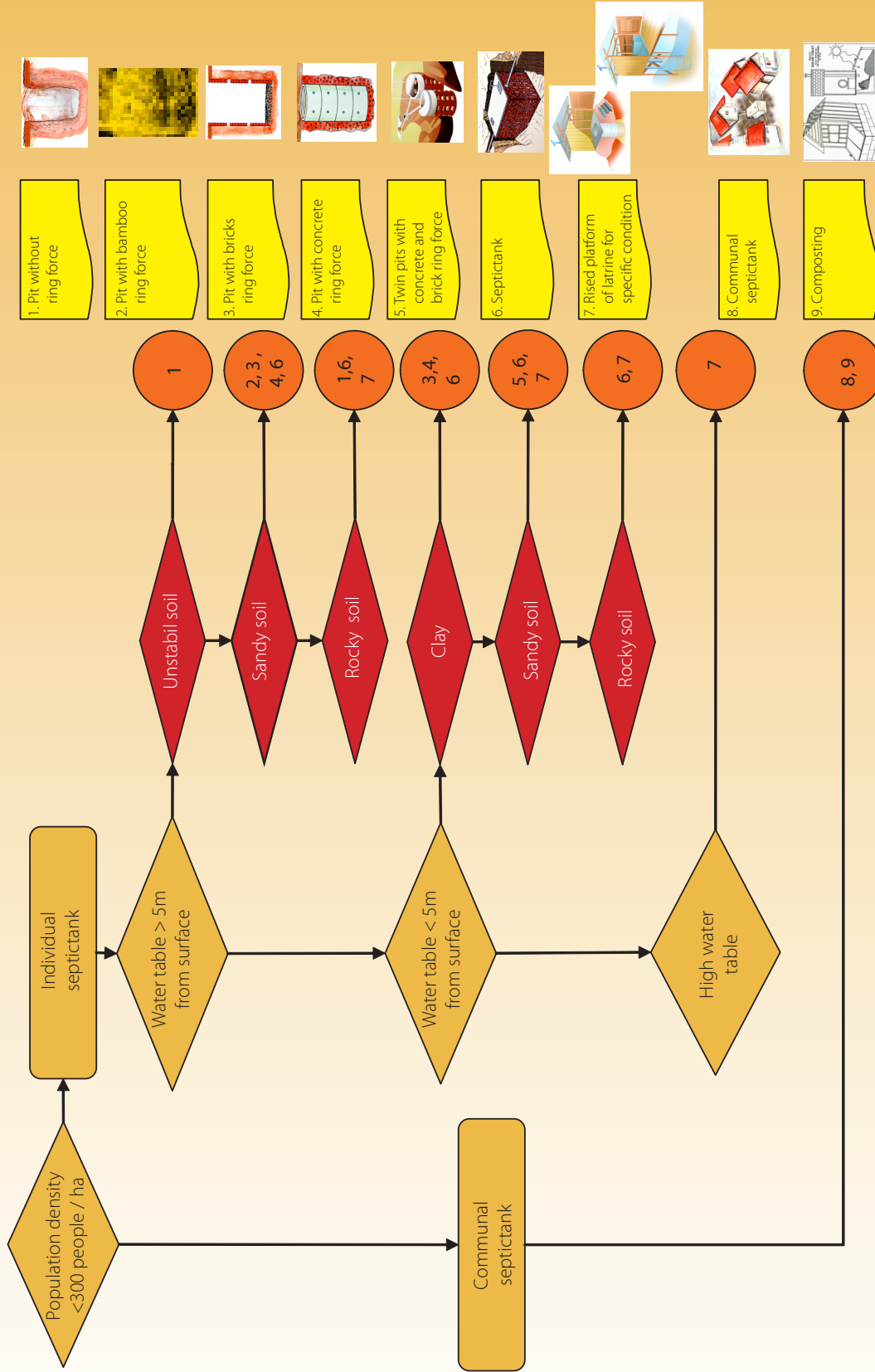

Part 4

COST OF AN IMPROVED LATRINE “FOR GENERAL CONDITIONS”

ABOVE-GROUND PART |

ON-GROUND PART |

UNDERGROUND PART |

A1 | Roofless Superstructure

Wooden frame; plastic walls; gunny sack; or bamboo mat; roofless

Advantages: Very low cost; can easily be built by family; without high skills needed; the first step to produce a better superstructure in the future.

Disadvantages: Requires frequent repair and maintenance; may be damaged in a serious storm and is less convenient during the rainy season.

Life span: Short



T1 | Bamboo clay-lined slab with a lid

Bamboo frame with clay slab and wooden lid

Advantages: Can easily be built by family; low cost; reduced smell; no much water needed for operation.

Disadvantages: Slippery when wet; flies can enter if the lid is not replaced after use; strength of bamboo may be weakened by termites and fluids; not easy to clean; slab may be holed as affected by water.

Life span: Short

Tip on construction: bamboo will be stronger if it has been soaked in water or sprayed with termite-repellent or smeared with used lubricant

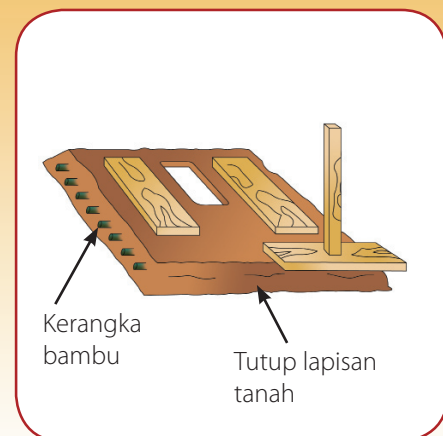

B1 | Unlined Pit

Advantages: Can easily be built by family; low cost; may last a long time depending on the pit's depth; easy to cover up when full and dig a new pit nearby.

Disadvantages: Not suitable in sandy soil; small hole; not suitable where groundwater table is (seasonally) high; groundwater pollution is more possible.

Tip on construction: Note the distance to the water source (such as a well) used by the community at a minimum of 10 m; ground slope and soil/rock type.

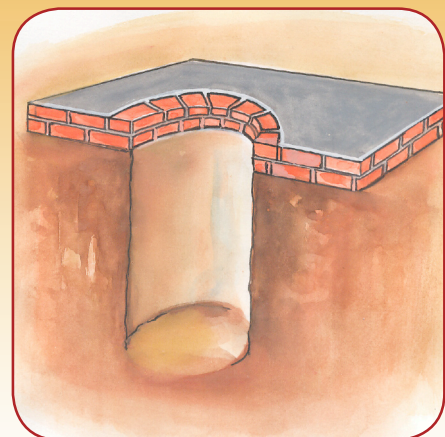

A1

No.	Material/Labor	Size on the market	Unit	Quantity	Unit Price	Total Price
Local Materials						
1	Bamboo (Mat) Walls	2x3 m ²	Sheet	1		
2	Bamboo stalks	4 m	Stalk	8		
3	Bamboo rope		m	2		
Purchased materials						
4	Nails	3 cm	kg	0.25		
Labor						
5	Self-done	-	oh	1		
Total Price						

T1

No.	Material/Labor	Size on the market	Unit	Quantity	Unit Price	Total Price
Local Materials						
1	Bamboo stalks	4 m	Stalk	12		
2	Bamboo rope		Pole	2		
Purchased materials						
3	Nails	3 cm	kg	0.25		
4	Sheets of plastic		m ²	1		
Labor						
5	Self-done	-	oh	1		
Total Price						
Note:						
<ul style="list-style-type: none"> • The average size of the slab is 100 m x 100 m (the holding space in the hole margin is ± 20 cm) • The slab is lined with clay. 						

B1

No.	Material/Labor	Size on the market	Unit	Quantity	Unit Price	Total Price
Labor						
1	Bricks	-	Piece	40		
2	Self-digging Φ 80 Cm/160 Cm	-	oh	1		
Total Price						
Note:						
<ul style="list-style-type: none"> • The pit is dug in permeable soil such as clay. 						

A2 | Superstructure with Mat Walls and Roof

Wooden frame; leaf walls and roof

Advantages: Can be used for a long time; low cost; convenient; easily built by family; fast built.

Disadvantages: Requires frequent repair and maintenance and may be damaged in a heavy rain or windstorm.

Life span: Medium



T2 | Wooden slab with a lid

Wooden platform, wooden lid

Advantages: Can be easily built and installed with minimum skills; low cost; sludge is not visible if the lid is replaced; prevent flies entering / escaping if the lid fits tightly.

Disadvantages: Requires occasional repair and maintenance; slippery when wet; flies can enter if the lid is not replaced after use; strength of wood may be weakened by termites and fluids.

Life span: Short to medium

Tip on construction: Wood will be stronger if sprayed with a termite repellent or smeared with used lubricant

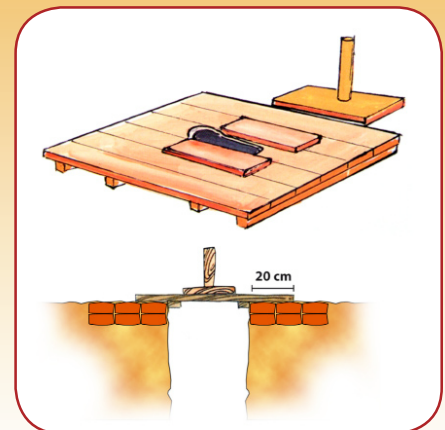

B2 | Woven Bamboo-Lined Pit

Advantages: Can easily be built by family; low cost; can last a long time depending on the pit's depth; easy to cover up when full and dig a new pit nearby; suitable for fragile soil type (sandy).

Disadvantages: Not suitable in areas where groundwater table is (seasonally) high.

Tip on construction: Bamboo will be stronger if sprayed with a termite repellent or smeared with used lubricant.

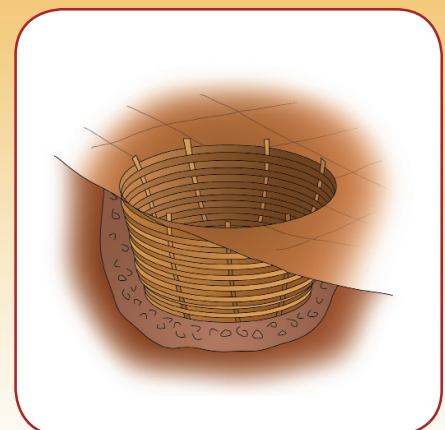

A2

No.	Material/Labor	Size on the market	Unit	Quantity	Unit Price	Total Price
Local Materials						
1	Bamboo (Mat) Walls	2x3 m ²	Sheet	3		
2	Bamboo stalks	4 m	Stalk	12		
3	Bamboo rope		m	3		
4	Leaf/Zinc Roof	Sheet		6		
Purchased materials						
5	Nails	3 cm	kg	0.25		
Labor						
6	Self-done	-	oh	2		
Total Price						

T2

No.	Material/Labor	Size on the market	Unit	Quantity	Unit Price	Total Price
Local Materials						
1	Board 3x20 Cm ²	4 m	Sheet	3		
2	Wooden rafters 4x6 Cm ²	4 m	Piece	2		
Purchased Materials						
3	Nail	3 cm	kg	0.25		
Labor						
4	Self-done	-	oh	1		
Total Price						
Note:						
<ul style="list-style-type: none"> • The average size of the wood-based slab is 100 m x 100 m (the holding space in the hole margin is ± 20 cm) • The slab is coated by lubricant or another termite repellent 						

B2

No.	Material/Labor	Size on the market	Unit	Quantity	Unit Price	Total Price
Local Materials						
1	Bamboo Stalks	4 m	Stalk	6		
2	Plastic/Bamboo rope		m	4		
Labor						
3	Self-Done	-	oh	0.5		
4	Self-digging Ø 90 Cm/160 Cm	-	Unit	1		
Total Price						
Note:						
<ul style="list-style-type: none"> • The pit hole is lined with woven bamboo (Ø 80 cm) • Choose a flexible type of bamboo 						

A3 | Superstructure with Wooden Walls and Roof

Wooden frame; wooden walls and zinc roof

Advantages: Can be used for a long time. Easily built with local skills; gives better privacy to the user.

Disadvantages: Higher cost; requires occasional repair and maintenance; strength of wood may be weakened by termites and fluids.

Life span: Medium to long



T3 | Concrete slab with a lid

Concrete slab and footrest; wooden lid

Advantages: Medium cost; stronger design more durable than a wooden slab; easy to clean.

Disadvantages: More expensive than a wooden slab; flies may enter if the lid is not replaced after use; heavier items lead to a transport problem.

Life span: Long

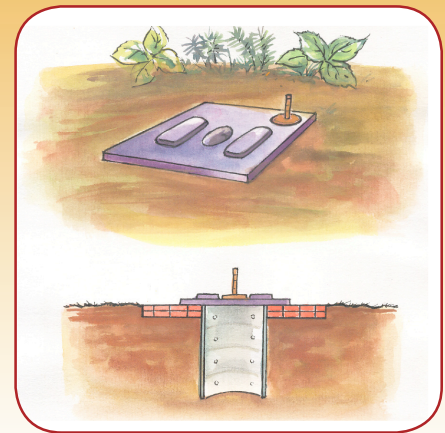

B3 | Concrete-lined pit

Three or more concrete rings up to required depth. Holes in rings for fluid soakaway.

Advantages: Can easily be built with local skills, prevents pit from collapsing; can be used for many years; suitable for fragile soils; can be used in areas with high groundwater table.

Disadvantages: More expensive option than an unlined pit, rings are very heavy items to transport, lift and maneuver; previous experience of fitting required.

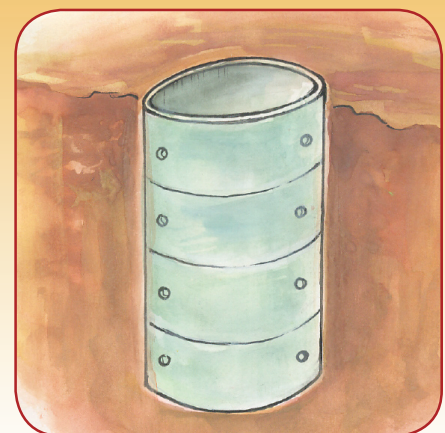

A3

No.	Material/Labor	Size on the market	Unit	Quantity	Unit Price	Total Price
Local Materials						
1	Board 4 m	3X20 cm ²	Sheet	20		
2	Wooden rafters 4m	4X6 cm ²	Piece	8		
Purchased Materials						
3	Nail	3 cm	kg	0.5		
4	Thumbtack	4 cm	kg	0.5		
5	0.3mm corrugated zinc	90X240 cm ²	Sheet	2		
Labor						
6	Self-done	-	oh	2		
Total Price						

T3

No.	Material/Labor	Size on the market	Unit	Quantity	Unit Price	Total Price
Local Materials						
1	Bricks	-	Piece	60		
2	Sand	-	m ³	0.50		
3	Stone chippings	-	m ³	0.25		
Purchased Materials						
4	Cement	50 kg	Sack	1		
5	Concrete steel Ø 8 mm	12 m	Bar	1		
6	Concrete wire (bendrat)	-	kg	0.25		
Labor						
7	Self-done	-	oh	1		
Total Price						
Note:						
• The average size of the slab is 1 x 1 m ² with a cement base						

B3

No.	Material/Labor	Size on the market	Unit	Quantity	Unit Price	Total Price
Local Materials						
1	Sand	-	m ³	0,5		
Purchased materials						
2	Cement	50 kg	Sack	0,5		
3	Concrete Ring (height 60 cm)	Ø 90 cm	Unit	4		
4	Iron pipe (Gi Light Ø 1.0")	6 m	m	0.50		
5	Tee Gi 0 1.0"	-	Unit	1		
Labor						
6	Skilled labor	-	oh	1		
Total Price						
Note:						
• The average diameter of concrete ring is 90 cm and height 60-80 cm.						

A4

Superstructure with Brick and Mat Walls and Roof

Wooden frame; half brick wall and half mat wall and zinc/asbestos roof

Advantages: Long lasting; convenient; provides good privacy and protection; fast and easily built with some skills

Disadvantages: Requires occasional repair; expensive, and zinc material will rust if in regular contact with water.

Life span: Long

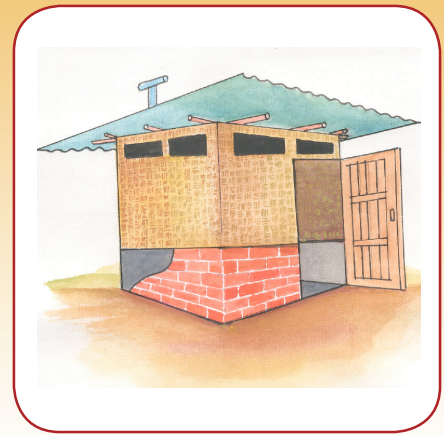

T4

Concrete Offset Slab

Advantages: Easily built; relatively low cost; easily cleaned; safer because the pit is offset from the slab.

Disadvantages: Requires a wider area

Life span: Long

Tip on construction: The offset slope should be noted; the connecting pipe should be smooth.

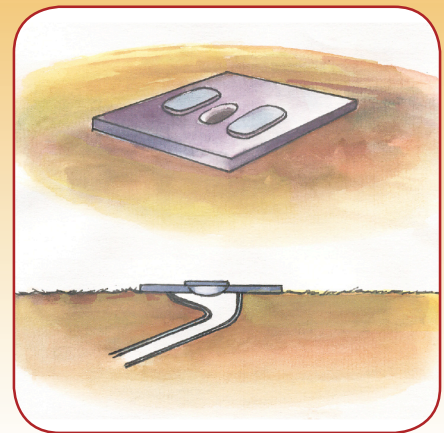

B4

Brick-lined pit

Brick-lined pit

Advantages: Prevents the pit from collapsing; can be used for many years; suitable for all soils and high groundwater table.

Disadvantages: High-cost option; takes time to build; requires skilled labor.



A4

No.	Material/Labor	Size on the market	Unit	Quantity	Unit Price	Total Price
Local Materials						
1	Bamboo (Mat) Wall	3X4 m	Sheet	1		
2	Bricks	-	Piece	250		
3	Sand	-	Cart	2		
4	Wood 4m	4X6 cm	Piece	8		
5	Board 4m (Door frame)	3 X 20 cm	Sheet	2		
6	Wood 4m	3X4 cm	Piece	6		
Purchased Materials						
7	Cement	50 kg	Sack	1.5		
8	Corrugated zinc 0.3mm/Asbestos	90 X 240 cm	Sheet	2		
9	Plywood 0.5mm	80X210 cm	Sheet	1		
10	Hinge	-	Pair	1		
11	Door bolt	-	unit	1		
12	Door handle	.	unit	2		
13	Nails	Mixed	kq	0.25		
Labor						
14	Skilled labor	-	oh	2		
Total Price						

T4

No.	Material/Labor	Size on the market	Unit	Quantity	Unit Price	Total Price
Local Materials						
1	Brick	-	Piece	80		
2	Sand	-	m ³	1		
3	Gravel	-	m ³	0.25		
Purchased Materials						
4	Cement	50 kg	Sack	1,5		
5	Pvc Pipe Type-C Ø 4"	4 m	m	1.50		
Labor						
6	Self-done	-	oh	1		
Total Price						
Note:						
• The average size of the slab is 1m x 1m with a connecting pipe.						

B4

No.	Material/Labor	Size on the market	Unit	Quantity	Unit Price	Total Price
Local Materials						
1	Brick	-	Piece	400		
2	Sand	-	m ³	1.5		
3	Palm fiber	-	Sack	0.5		
Purchased Materials						
4	Cement	50 kg	Sack	1.5		
5	Iron Pipe (Gi Light Ø 1.0")	6 m	piece	0.50		
6	Tee Gi Ø 1.0"	-	unit	1		
Labor						
7	Skilled labor Terampil	-	oh	2		
8	Self-digging Ø 100cm – 160 cm	-	unit	1		
Total Price						
Note:						
• Single pit in a spaced structure of bricks (beehive structure).						

A5 | Superstructure with Brick Wall and Roof

Wooden frame; brick wall; tiled floor and zinc roof

Advantages: Very strong and durable design; can be adapted to suit disabled access (e.g. hand support rails), offers very good privacy; requires very few repairs if built well.

Disadvantages: Expensive, requires trained builders to construct.

Life span: Long



T5 | Concrete Slab and Ceramic Pan

Advantages : Strong design, easy to keep clean and requires less water

Disadvantages : High cost

Life span: Long

Tip on construction: To clean it more easily, ceramic tiles will be used for the floor.

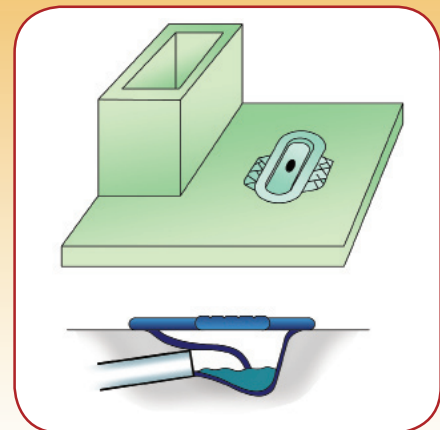

B5 | Twin Brick-Lined Offset Pits

Brick-line pit

Advantages: Prevents the pit from collapsing; can be used for many years; suitable for all soils and high ground water table; a reserve tank is available when the pit is full/being repaired; the collected excrement can be compost before it is emptied.

Disadvantages: More expensive option; takes time to build; requires skilled labor; requires a wider area.

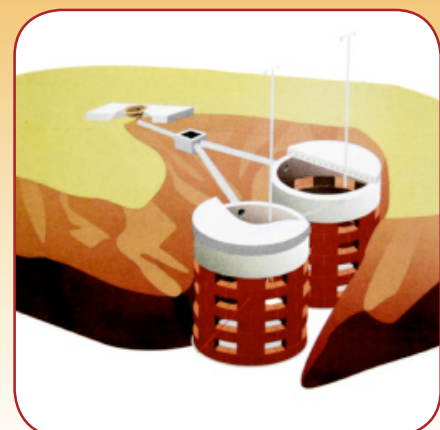

A5

No.	Material/Labor	Size on the market	Unit	Quantity	Unit Price	Total Price
Local Materials						
1	Bricks	-	Piece	700		
2	Sand	-	m ³	4.5		
3	Wooden beam 6 x 10 cm	4 m	Piece	4		
4	Wood 4x6 cm	4 m	Piece	4		
5	Board (Door frame) 3x20 cm	4 m	Sheet	2		
6	Wood 3x4 cm	4 m	Piece	6		
Purchased Materials						
7	Cement	50 kg	Sack	2.5		
8	Corrugated zinc 0.3mm/ Asbestos	90 X 240 cm	Sheet	2		
9	Plywood 5mm	80X210 cm	Sheet	1		
10	Hinge	-	Pair	1		
11	Door bolt	-	unit	1		
12	Door handle	-	unit	2		
13	Nails	Mixed	kg	0.25		
Labor						
14	Skilled labor	-	oh	4		
Total Price						

T5

No.	Material/Labor	Size on the market	Unit	Quantity	Unit Price	Total Price
Local Materials						
1	Bricks (depending on tank size)	-	buah	250		
2	Sand	-	m ³	1		
3	Gravel	-	m ³	0.25		
Purchased Materials						
4	Cement	50 kg	zak	1		
5	Water-sealed pan	-	unit	1		
6	Pipe Pvc type-C Ø 3"	4 m	m	2		
Labor						
7	Skilled labor	-	oh	1		
Total Price						
Note:						
• The average size of the slab is 0.90 x 0.90 m with a water-sealed pan and a water tank.						

B5

No.	Material/Labor	Size on the market	Unit	Quantity	Unit Price	Total Price
Local Materials						
1	Bricks	-	Piece	800		
2	Cement	50 kg	Sack	3		
3	Sand	-	m ³	2		
4	Gravel	-	m ³	0.5		
5	Palm fiber	-	Sack	1		
Purchased Materials						
6	Concrete Steel Ø 5mm	12 m	Piece	2		
7	Concrete Wire (Bendrat)	-	kg	1		
8	Pipe Pvc type-C Ø 3"	4 m	Piece	1		
9	Iron Pipe (Gi Light Ø 1.0")	6 m	Piece	4		
10	Tee Gi Ø 1.0"	-	unit	2		
Labor						
11	Skilled labor	-	oh	4		
12	Self-digging Ø 100cm	160 cm	unit	2		
Total Price						
Note:						
• Double pits in a spaced structure of bricks (beehive structure).						

B6 | Septic Tank

Advantages: Healthier; clean and no contamination; the pit is not full quickly; and can be emptied when full.

Disadvantages: Higher cost and technical skills needed.

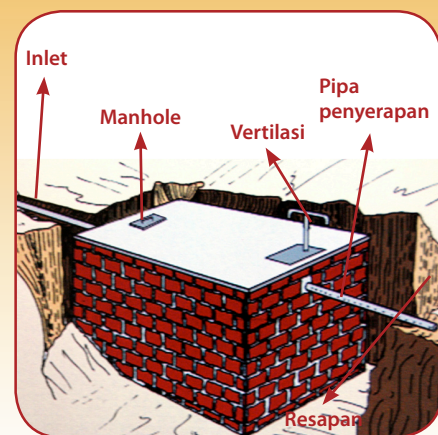

B6

No.	Material/Labor	Size on the market	Unit	Quantity	Unit Price	Total Price
Local Materials						
1	Filling earth	2,65	m ³			
2	Red bricks 5x11x22 cm	140	Piece			
3	Plain concrete steel	450	kg			
4	Dolken d=8cm/4m	48	Piece			
5	Concrete wire	9	kg			
6	Wooden beam	0,42	m ³			
7	Concrete gravel	2,82	m ³			
8	Begesting Oil	4,8	Liter			
9	Ordinary nails 2"-5"	9,6	kg			
10	Sand for preparing concrete	2,47	m ³			
11	Sand for laying bricks	0,13	m ³			
12	Sand for filling	0,14	m ³			
13	PC Cement	1164	kg			
14	Portland Cement	256,4	kg			
15	Plywood 4mm	8,4	Sheet			
Total Price						

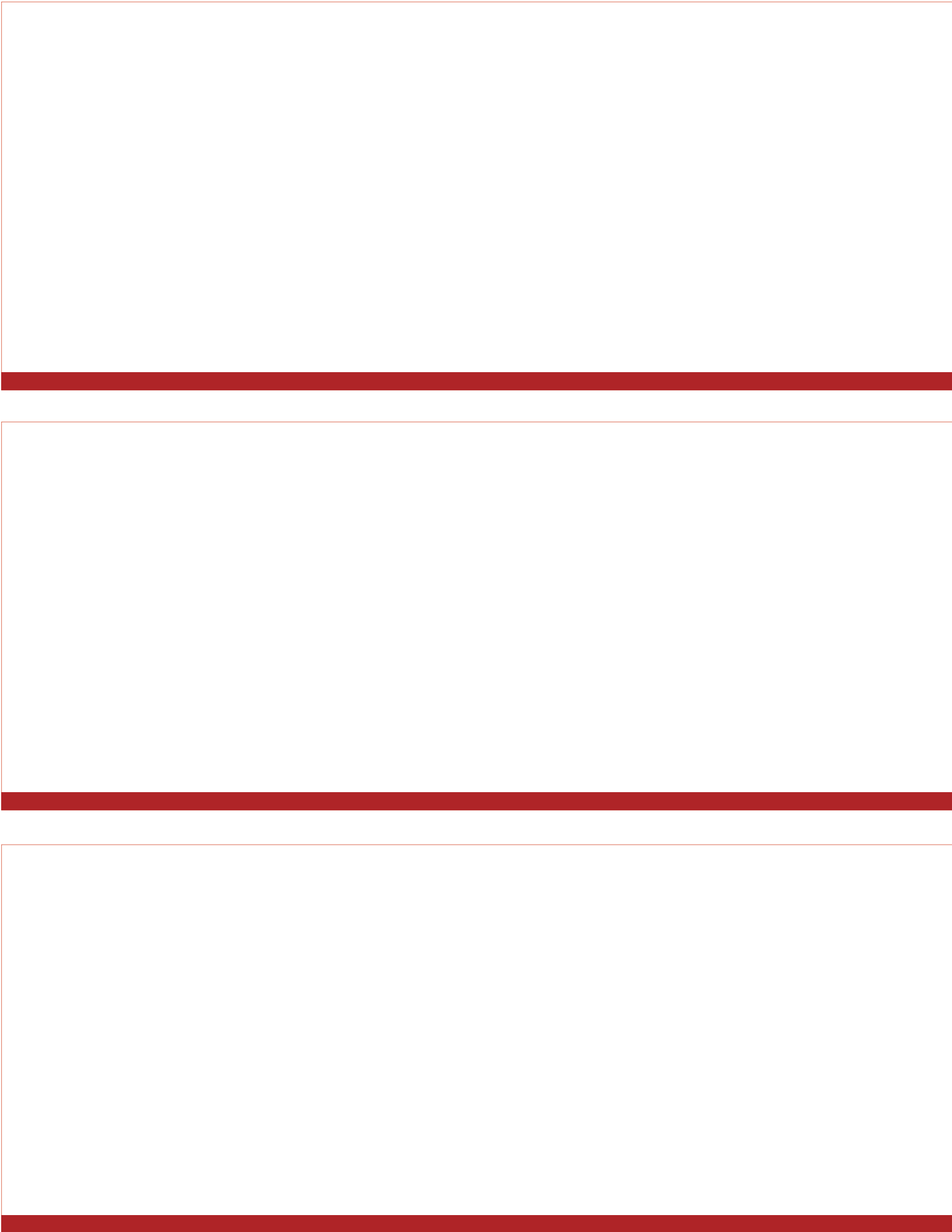

Part 5

TYPES OF LATRINE FOR "SPECIAL CONDITIONS"

1. Raised-Surface Latrine

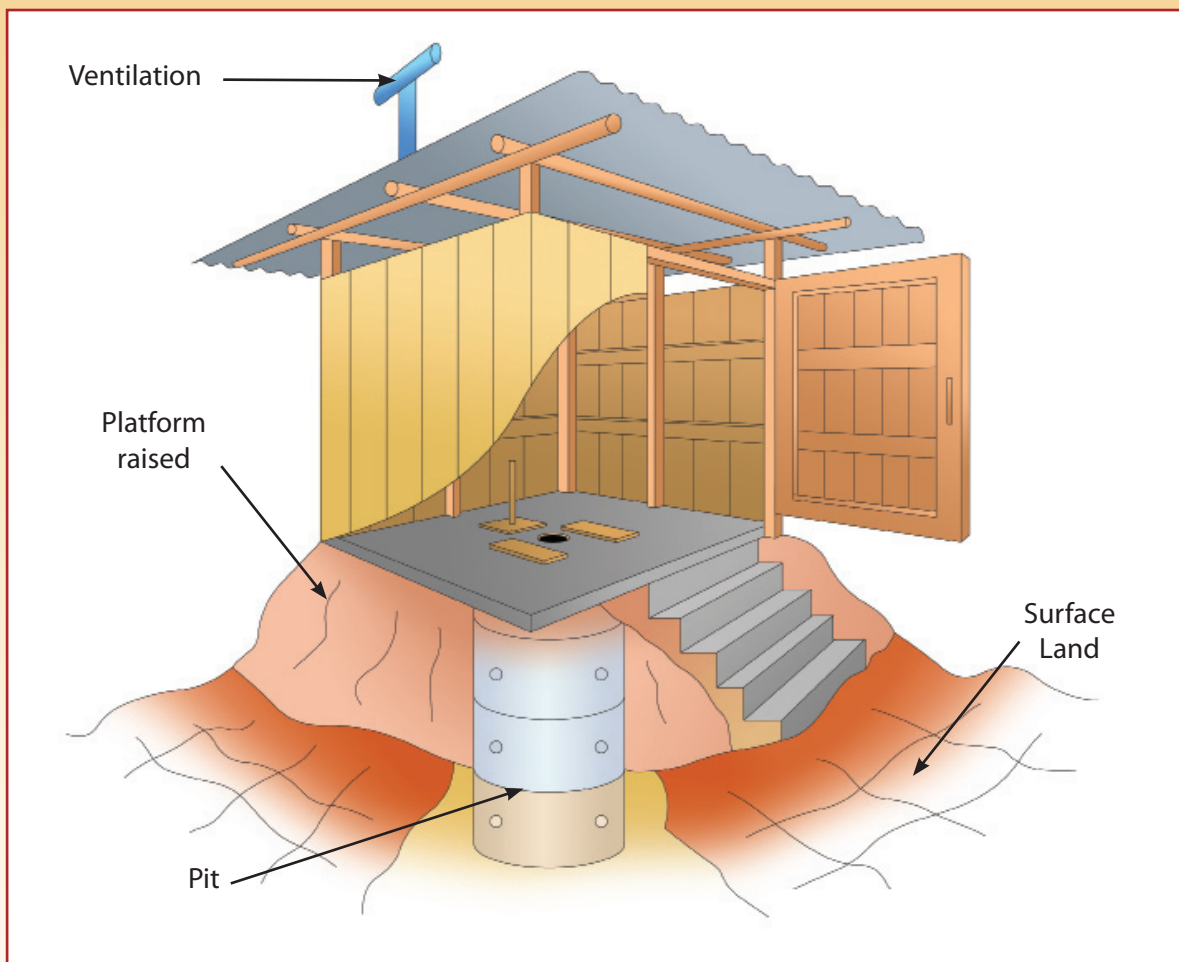

This type of latrine can be used for areas with high groundwater table, flooding areas and tidal areas.

2. Latrine for flooding/tidal areas/houses built on stilts

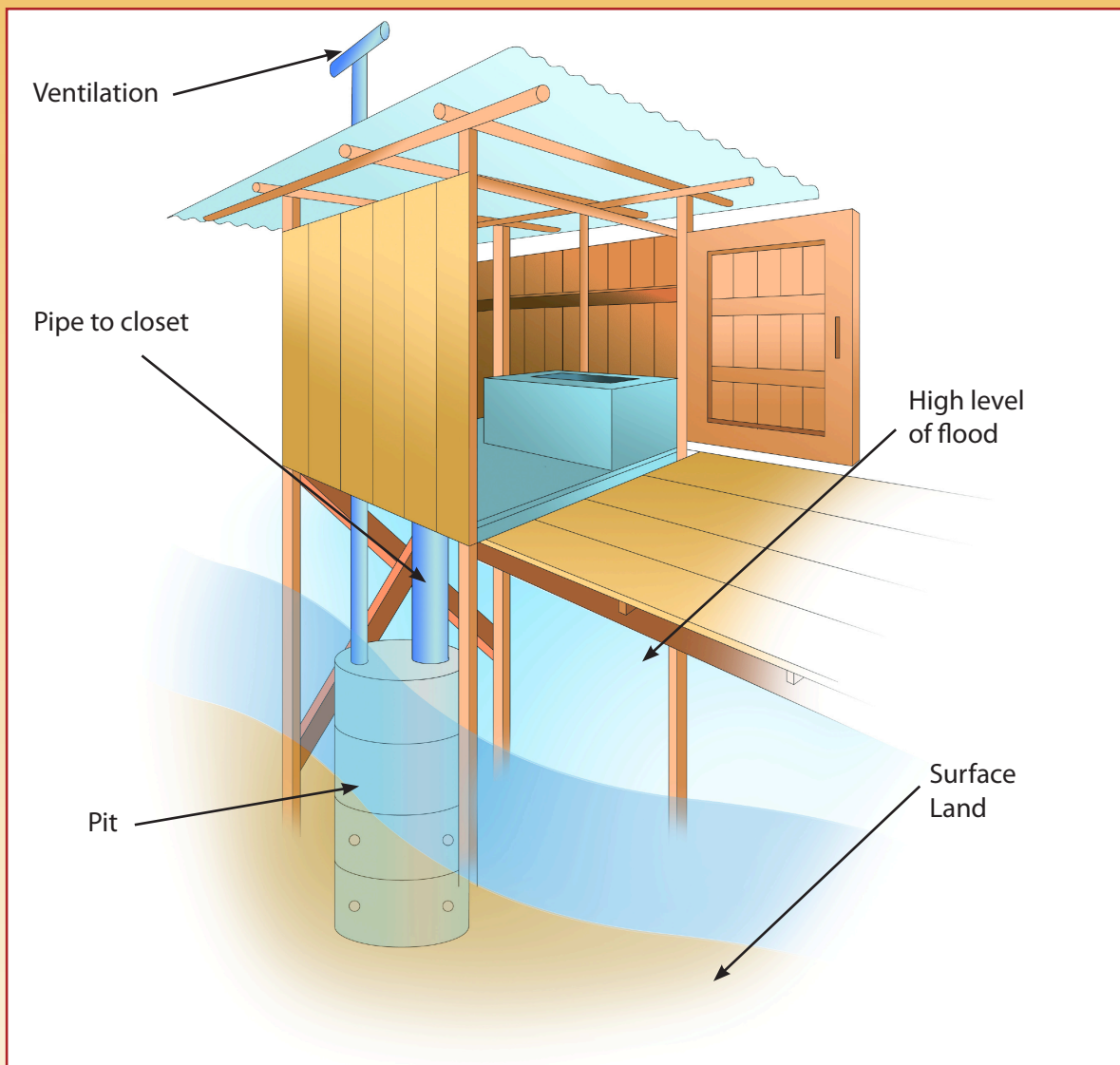

Areas that flood during the rainy season need a special approach. A pit can still be constructed, but above the ground. It should be connected to a slab and pan by a number of concrete rings and a pipe. The number of concrete rings and the length of pipe will be changed according to level of water during the flood. Since the pit will fill completely during the flooding, the only "usable" area of the tank will be the part above the flood level. The superstructure needs to be raised further above the highest flood level. Although a "dry latrine" (i.e. an open hole) is possible, the availability of water is not usually a problem in flooding areas. A flooding wet pit latrine is more expensive than other types of latrine, and building materials may be weakened from being submerged in water. Therefore, waterproof materials are needed.

3. Communal sanitation system for densely populated areas

Densely populated settlements cause septic tanks to be located near wells in an area. Such a condition worsens the quality of excrement-contaminated groundwater consumed by people in an area. In fact, some diseases are transmitted by feces such as typhus, cholera, dysentery, hepatitis A, polio, and diarrhea. Imaginably, various types of water-borne bacteria enter the bodies of people who consume them. Here we can see serious problems with individually based feces treatment system well known to and practiced by communities.

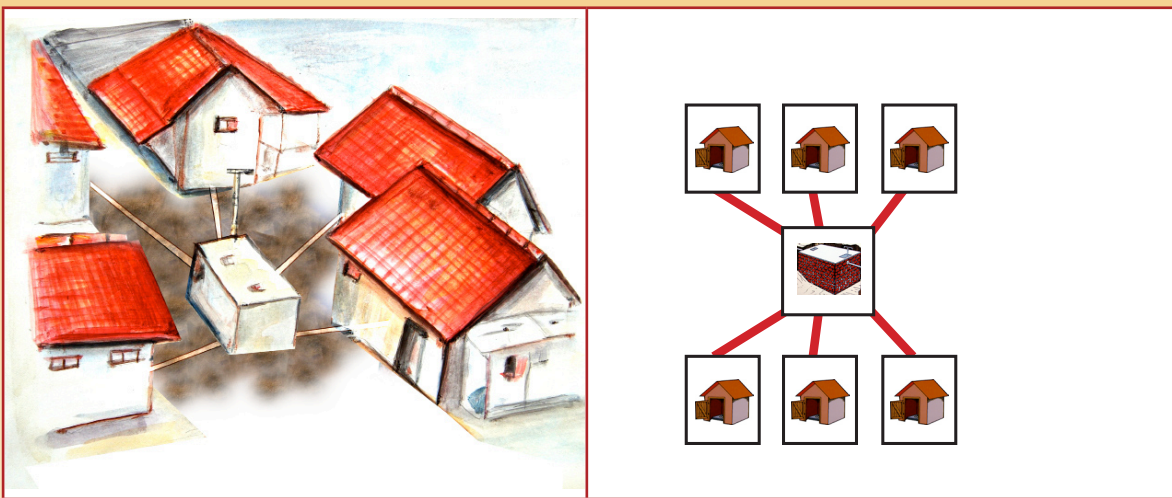

The process of disposing of wastewater or discharging wastewater from houses and other facilities, such as water coming from bathing, washing and so on, and industrial effluents is through an underground piping system that goes to a Wastewater Treatment Facility (IPAL) for centralized treatment. In the septic tank, there are two processes of treatment: sedimentation and floatation. The wastewater from the on-ground part (clear portion) flows out.

In this system, the underground facility (e.g. septic tank) will be provided for joint use. The superstructure and on-ground parts are located in the users' houses. So, a channel (usually a pipe) is needed to convey waste from houses to the septic tank.

WC-Ku Sehat



Look for WC-Ku Sehat logo for better services on hygienic latrine appropriate for you as described in this Informed Choice Catalogue.

WC-Ku Sehat gives you assurance that you will get facility that fulfil all requirements of a hygienic latrine.

Masons and sanitation providers with WC-Ku Sehat logo has received training and accreditation on sanitation aspects and hygienic latrine specifically by foremost technical institution in Indonesia.



wsp
water and
sanitation program