

Ecological Sanitation - Literature Review

LM Austin, LC Duncker, GN Matsebe,
MC Phasha & TE Cloete

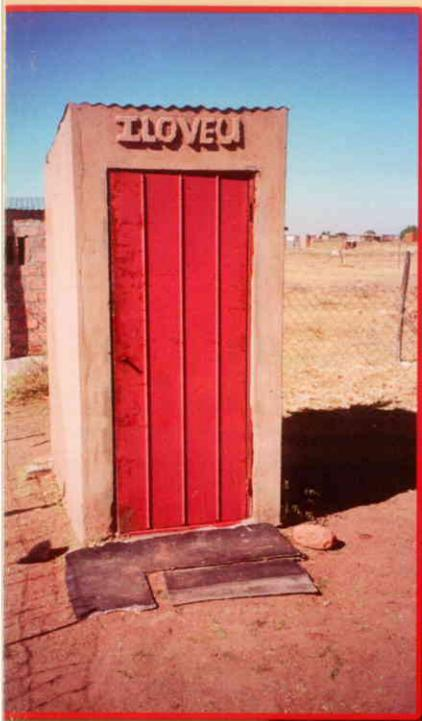

ECOLOGICAL SANITATION - LITERATURE REVIEW

Report to the Water Research Commission

by

LM Austin, LC Duncker, GN Matsebe
CSIR Building and Construction Technology

MC Phasha, TE Cloete
University of Pretoria

WRC Report No: TT 246/05

JUNE 2005

Obtainable from:

Water Research Commission
Private Bag X03
Gezina
0031

The publication of this report emanates from a project entitled:
Strategy for the furtherance of knowledge and good practice of ecological sanitation (ecosan) technology in South Africa
(WRC Project No. 1439)

DISCLAIMER

This report has been reviewed by the Water Research Commission (WRC) and approved for publication. Approval does not signify that the contents necessarily reflect the views and policies of the WRC, nor does mention of trade names or commercial products constitute endorsement or recommendation for use.

ISBN 1-77005-322-0

Printed in the Republic of South Africa

EXECUTIVE SUMMARY

Introduction

This literature review forms part of the Water Research Commission project number K5/1439 entitled “Strategy for the furtherance of knowledge and good practice of ecological sanitation (ecosan) technology in South Africa”. The aims of this research project are as follows:

- 1.1.1 To establish the current “state of the art” in ecological sanitation by means of a literature review.
- 1.1.2 To determine:
 - (a) the nature of processes taking place in the vault of a urine-diversion (UD) toilet; and
 - (b) the relevant pathogen destruction parameters in order to increase understanding of the health aspects of toilet operation and maintenance (O&M), as well as safety criteria for re-use of the processed excreta.
- 1.1.3 To explore appropriate practices for faeces collection and disposal, in order to facilitate the abovementioned safe O&M of the toilets.
- 1.1.4 To produce a research report and design/O&M recommendations, aimed at improving the future implementation of urine-diversion sanitation projects.

This literature review represents the results of the aim 1.1.1 above. The review begins with a general overview of the South African sanitation experience, with specific reference to on-site technologies and the relationship between sanitation, the environment and public health. Design and management practices for UD toilets are then investigated, with examples from both South Africa and abroad. This is followed by a review of perceptions and experiences of UD toilet users around the world in order to establish how they are affected by design, implementation practices or other factors.

Agricultural and horticultural practices that re-use human excreta are examined, with experiences from various countries being described. This is followed by a review of the health aspects of UD toilets, with particular attention being paid to the re-use of urine and processed faeces in food gardens.

General conclusions from the literature review

The final section of the literature review summarises the pertinent issues concerning ecosan and indicates what matters remain unresolved. This is followed by an assessment of how the review should influence and guide present research activities.

There is a vast amount of literature on pollution of water resources, particularly on problems caused by inadequate sanitation provision or, where sanitation exists, by poor implementation practices, operation and maintenance. An increasing awareness worldwide of the environmental problems associated with inappropriate sanitation implementation has led to the development of ecological sanitation technology. This

technology is not really new, being rather a refinement of an ancient practice. It has been promoted for environmental reasons, as well as for issues such as water conservation, recycling of nutrients to arable land, easy operation, negligible maintenance costs, dignity and convenience. Ecosan represents a conceptual shift in the relationship between people and nature. It has been implemented successfully in many countries and regions in various stages of development, and among communities of different socio-economic strata, religions, cultures and practices.

Some handling, at household level, of urine and faeces is required. The people that plan, design and build the toilets need to fully understand the basic principles involved and how they relate to local conditions, otherwise inappropriate selection of options may be made. Appropriate social interventions in the form of promotion, support, education and training are also prerequisites for successful implementation.

Human excreta are usually easier to handle when urine and faeces are kept separate, as in urine-diversion toilets. Urine may be handled in various ways, and guidelines exist for hygienic storage and agricultural use of urine.

Faeces need to be sanitised as far as possible within the toilet vaults in order to facilitate safe removal and further handling, especially where their re-use as a soil conditioner is required. Various methods can be employed to ensure this, including the use of additives such as ash, lime, sawdust, dry soil, etc, as well as the judicious use of heat-absorbent building materials, ventilation, moisture control and storage.

Human excreta, especially urine, are excellent fertilisers and soil amendments, and their efficacy has been proved in many countries, under a variety of climatic conditions. Many researchers and practitioners view ecosan as a means of returning essential nutrients such as nitrogen, phosphorus, potassium, etc. to the lands where the consumed crops were grown and harvested. As such, excreta should be regarded as a valuable resource, not simply as a waste product destined merely for disposal.

Poor handling practices may result in infection from faeces, and it is therefore essential that persons emptying the vaults and disposing of the products exercise the necessary caution. Adequate education and hygiene awareness campaigns in communities receiving ecosan toilets are therefore a prerequisite for the maintenance of public health.

Despite the vast amount of research that has been carried out on inactivation of faecal pathogens in ecosan toilets, differences of opinion still remain on the minimum storage periods and storage conditions required to ensure safety for handling and re-use. Further research is required in order to establish practical guidelines on the best designs and management methods for achieving these conditions in the vaults, which can be used with confidence in all types of settings.

Ecosan problems and challenges

The literature review indicates that ecological sanitation is firmly established as an accepted technology in many countries. There are, in most cases, no socio-economic barriers to its continuing implementation, as people of all income groups, in both developed and developing countries, have installed ecosan toilets in their homes. Also, farmers of all types, rich and poor, are successfully using human excreta in their fields and food gardens to benefit the soil and enhance crop production.

One of the major challenges of ecosan technology is to find ways of reducing the health risks attached to handling of faeces. Innovative solutions need to be found. Improved building methods and materials that encourage higher temperatures in the faecal piles should be developed. Environmentally friendly additives that enhance pathogen destruction could, if suitably priced and promoted, find a ready market in areas where electrification has replaced the need for cooking fires, or in more urbanised communities where ash may not be readily available.

Aside from the health risk, handling of excreta, especially faeces, remains a social taboo in some communities. If ways can be found to treat the faeces inside the vault such that the end product does not resemble the original material any more, it may be possible to increase the general perception and acceptance of ecosan technology. This treatment should also include the easy disposal of anal cleansing material.

In developing countries where there is a growing interest in the technology, better quality pedestals need to be introduced and actively marketed. If ecosan is going to be promoted as a superior sanitation technology, then superior fittings should be available. Good quality ceramic products will help create the perception of ecosan as an upmarket system. This is of particular importance in South Africa, where dry systems are often regarded as second class.

Implementation practices for ecosan projects presently suffer from the same shortcomings as conventional sanitation projects, in that the approaches used, coordination between implementing agencies, skills building, training, hygiene awareness, etc are often not given sufficient attention. Local authorities need to thoroughly understand the needs and interests of their communities before making investment plans, otherwise the services provided will often be inappropriate. The operation and maintenance of urine-diversion toilets, especially, is a crucial issue, and it is thus essential that proper training programmes be provided in order to ensure project sustainability.

ACKNOWLEDGEMENTS

The project team acknowledges with thanks the following persons and organisations for their contributions to the project:

- The Water Research Commission for funding the project.
- Members of the Reference Committee for their valuable advice and support:

Mr JN Bhagwan	Water Research Commission (Chairman)
Prof CA Buckley	University of KwaZulu-Natal
Prof TE Cloete	University of Pretoria
Ms MC Phasha	University of Pretoria
Mr D Gadd	Rand Water
Mr RD Holden	The Mvula Trust
Ms JM Kadiaka	Department of Health
Dr NP Mjoli	Hlathi Development Services cc
Mr I Pearson	WATSUP Development cc
Mr JL Harrison	eThekwini Water Services
Mr B Pfaff	eThekwini Water Services
Mr DA Still	Partners in Development cc
Mr G Tsibani	Department of Water Affairs and Forestry
Dr K Wall	CSIR Building and Construction Technology

TABLE OF CONTENTS

Executive summary	(i)
Acknowledgements	(iv)
Table of contents	(v)
Chapter 1: Introduction	1-1
1.1 Structure of this literature review	1-1
1.2 Sanitation: the South African experience	1-2
1.3 The need for alternative sanitation technologies	1-3
1.4 Urine-diversion technology as an alternative to pit toilets	1-4
1.5 The environment and public health: the argument for ecological sanitation	1-7
1.6 Conclusions	1-13
Chapter 2: Urine-diversion applications: examples of current practice ..	2-1
2.1 Introduction	2-1
2.2 Examples from other countries	2-1
2.2.1 Yemen	2-1
2.2.2 Vietnam	2-2
2.2.3 El Salvador	2-3
2.2.4 Ecuador	2-3
2.2.5 Mexico	2-5
2.2.6 Sweden	2-5
2.2.7 Bolivia	2-7
2.2.8 China	2-8
2.2.9 Zimbabwe	2-8
2.3 Examples from South Africa	2-9
2.3.1 Eastern Cape	2-9
2.3.2 Northern Cape	2-11
2.3.3 eThekweni, KwaZulu-Natal	2-15
2.3.4 North West	2-15
2.3.5 Johannesburg, Gauteng	2-17
2.4 Conclusions	2-17
Chapter 3: Design and management aspects of ecosan toilets	3-1
3.1 Introduction	3-1
3.2 Urine management	3-1
3.2.1 Urine diversion	3-2
3.2.2 Urine separation	3-2
3.2.3 Combined processing	3-2
3.2.4 Disposal of collected urine	3-3
3.2.5 Urine pipes and tanks	3-3
3.3 Faeces management	3-4
3.3.1 Dehydration versus composting	3-4
3.3.2 Solar heaters	3-4
3.3.3 Single or double vault	3-5
3.3.4 Disposal of anal cleansing material	3-6
3.3.5 Absorbents and bulking agents	3-7
3.3.6 Ventilation and fly control	3-7
3.3.7 Disposal of vault contents	3-7
3.3.8 Sustainability aspects	3-8
3.3.9 Possible future scenarios	3-9

3.4	Dimensions, methods and materials	3-10
3.5	Conclusions	3-12
Chapter 4:	People, perceptions and practices	4-1
4.1	Introduction	4-1
4.2	A global overview of urine-diversion projects	4-2
4.2.1	Planning	4-2
4.2.2	Marketing principles / promotion methods	4-4
4.2.3	Design	4-7
4.2.4	Health and hygiene awareness and education	4-9
4.2.5	Operation and maintenance	4-10
4.2.6	Re-use of human excreta	4-12
4.2.7	Monitoring and evaluation	4-13
4.3	Gender perspectives	4-15
4.4	Conclusions	4-16
Chapter 5:	Agricultural utilisation of human excreta from ecosan toilets.....	5-1
5.1	Introduction	5-1
5.2	Human excreta as fertilisers	5-2
5.3	Some practical examples of agricultural utilisation of human excreta	5-6
5.3.1	Japan	5-6
5.3.2	China	5-6
5.3.3	India	5-6
5.3.4	Guatemala	5-6
5.3.5	Zimbabwe	5-7
5.3.6	Ethiopia	5-8
5.3.7	Sweden	5-8
5.4	Small-scale crop experimentation in Zimbabwe	5-9
5.5	Nitrogen losses in urine	5-12
5.6	Conclusions	5-13
Chapter 6:	Health and safety aspects of ecosan toilets and excreta re-use	6-1
6.1	Introduction	6-1
6.2	Health aspects of excreta re-use	6-2
6.3	Pathogenic organisms in sanitation systems	6-3
6.3.1	Introduction	6-3
6.3.2	Urinary pathogens	6-4
6.3.3	Faecal pathogens	6-6
6.4	Transmission routes of pathogens	6-8
6.5	Survival of microorganisms in the environment	6-10
6.5.1	Introduction	6-10
6.5.2	Physiochemical and biological factors that affect the survival of pathogens in excreta and re-use systems ...	6-12
6.5.3	Contamination of soils and crops	6-14
6.5.4	Comparison of treatment efficiencies: dry sanitation technologies vs. conventional wastewater treatment systems	6-15
6.6	Existing guidelines for re-use of excreta	6-16
6.6.1	Introduction	6-16
6.6.2	Wastewater and sludge re-use	6-17

6.6.3	Dehydrated faeces re-use	6-18
6.7	Conclusions	6-18
Chapter 7:	Conclusions	7-1
7.1	General conclusions from the literature review	7-1
7.2	Ecosan problems and challenges	7-3
Bibliography	B-1

List of tables

Table 5.1:	Estimated Swedish averages for mass and distribution of plant nutrient content in urine and faeces, expressed as percentages of total mass excreted	5-2
Table 5.2:	Proposed new Swedish default values for urine and faeces	5-2
Table 5.3:	Annual excretion of fertiliser by humans, compared with the fertiliser requirement of cereal	5-3
Table 5.4:	Annual excretion of fertiliser by humans	5-4
Table 5.5:	Amounts of heavy metals, in mg per person per year, found in various recyclable nutrients	5-5
Table 5.6:	Analysis of humus (faeces, soil and wood ash) from urine-diverting toilets	5-9
Table 5.7:	Plant trials for various vegetables, tomatoes and maize	5-9
Table 6.1:	Reduction efficiency in dry ecosan toilets, with a storage time of 6 months and pH value of 9 or more	6-16

List of figures

Figure 1.1:	Schematic representation of a urine-diversion (“dry-box”) toilet	1-6
Figure 1.2:	The linear, or open flow, system	1-10
Figure 1.3:	The cycle, or closed loop, system	1-10
Figure 1.4:	The concept of ecological sanitation	1-11
Figure 1.5:	Complete household ecosan	1-12
Figure 2.1:	Section through a house in the old part of Sanaa, Yemen.....	2-2
Figure 2.2:	The Vietnamese double-vault dehydrating toilet	2-3
Figure 2.3:	(a) Dehydrating toilet with urine diversion and solar-heated vault in El Salvador	2-4
	(b) Removing the desiccated faeces for use as soil conditioner	2-4
Figure 2.4:	A solar-heated dehydrating toilet in Ecuador	2-4
Figure 2.5:	The Mexican version of the Vietnamese double-vault toilet, installed in the bathrooms of modern houses in the city of Cuernavaca	2-5
Figure 2.6:	Mexican urine-diversion pedestal cast in mortar:	
	(a) The pedestal, which can be fitted with a conventional seat and lid	2-6
	(b) The pedestal shown alongside its fibreglass mould	2-6
Figure 2.7:	Swedish urine-diversion pedestals for:	
	(a) Dry system	2-6
	(b) Flushing system	2-6
Figure 2.8:	Porcelain urine-diversion toilet made in 1880 in Sweden	2-7
Figure 2.9:	Urine-diversion toilet in El Alto, Bolivia	2-7

Figure 2.10: Urine diversion ecosan toilets in Nanning area, China:	
(a) Toilet in a house	2-8
(b) School toilet	2-8
Figure 2.11: Urine-diversion toilets in Zimbabwe:	
(a) A simple but well-built toilet with wooden superstructure	2-9
(b) Women from the community engaged in casting floor slabs	2-9
Figure 2.12: The Eastern Cape pilot urine-diversion project near Umtata:	
(a) Toilet structure	2-10
(b) Rotationally-moulded plastic pedestal	2-10
Figure 2.13: Double chamber urine-diversion toilet added onto house in Campbell, Northern Cape:	
(a) Exterior view	2-11
(b) Interior view	2-11
Figure 2.14: Double chamber urine-diversion toilets in Spoegrivier, Northern Cape:	
(a) Toilet added onto house	2-12
(b) Separate toilet structure	2-12
Figure 2.15: Commercial toilet unit made from prefabricated panels, Groblershoop, Northern Cape:	
(a) The vault may be partially beneath the ground	2-12
(b) The faeces are collected in a net under the pedestal	2-12
Figure 2.16: Conversion of bucket toilets in Campbell, Northern Cape	2-13
Figure 2.17: Urine-diversion toilets in Merriman, Northern Cape:	
(a) This toilet has been installed inside the bathroom	
(b) The vault is outside the bathroom wall	2-13
Figure 2.18: (a) Free-standing brick toilet structure in Alheit	2-14
(b) Toilet built into house, Britstown, Northern Cape	2-14
Figure 2.19: Toilets in Hanover, Northern Cape, are constructed with alternating drop-holes for the pedestal, but with a single vault	2-14
Figure 2.20: Typical double vault urine-diversion toilet provided in eThekweni	2-15
Figure 2.21: This urine-diversion toilet in Kokomeg, in the Taung Area, is well maintained. The structure has a concrete vault lid and a proper window	2-16
Figure 2.22: Urine-diversion toilets in Matsheng, in the Taung area:	
(a) Badly-fitted corrugated iron lid on the vault	2-16
(b) Blocked urine pipe	2-16
Figure 2.23: Retrofitted urine-diversion toilet in Richard Holden's house in Bellevue, Johannesburg	2-17
Figure 3.1: Three options for dealing with liquids in ecological sanitation systems	3-2
Figure 3.2: Alternative ways of handling/using urine diverted from toilets	3-3
Figure 3.3: The "pusher" used to move the faecal pile, El Salvador	3-5
Figure 3.4: Examples of simple, easily made urinals:	
(a) Using a 5 litre container	3-11
(b) Using a clay or ferrocement pot	3-11
Figure 3.5: "Kiddie-seat" adaptations for urine-diversion pedestals:	
(a) Swedish version (wood)	3-11
(b) South African version (plastic)	3-11
Figure 5.1: Arborloo in a paw-paw plantation or "sanitary orchard"	5-7
Figure 5.2: Gunder Edström of SUDEA demonstrating this FAITH garden in Addis Ababa, Ethiopia	5-8
Figure 5.3: Two basins planted with rape and spinach	5-10
Figure 5.4: Urine has a pronounced effect on maize	5-10

Figure 5.5: Total cob yield from maize planted in three 10-litre basins	5-11
Figure 5.6: A single photograph shows the effect of different amounts of urine applied to maize plants over a 3-month period	5-11
Figure 6.1: Transmission routes for pathogens found in excreta	6-9
Figure 6.2: Survival times of pathogens in untreated faecal sludges applied to fields in warm climates	6-15

CHAPTER 1: INTRODUCTION

1.1 STRUCTURE OF THIS LITERATURE REVIEW

This literature review forms part of the Water Research Commission project number K5/1439 entitled “Strategy for the furtherance of knowledge and good practice of ecological sanitation (ecosan) technology in South Africa”. The aims of this research project are as follows:

- 1.1.5 To establish the current “state of the art” in ecological sanitation (ecosan).
- 1.1.6 To determine:
 - (a) the nature of processes taking place in the vault of a urine-diversion (UD) toilet; and
 - (b) the relevant pathogen destruction parameters in order to increase understanding of the health aspects of toilet operation and maintenance (O&M), as well as safety criteria for re-use of the processed excreta.
- 1.1.7 To explore appropriate practices for faeces collection and disposal, in order to facilitate the abovementioned safe O&M of the toilets.
- 1.1.8 To produce a research report and design/O&M recommendations, aimed at improving the future implementation of urine-diversion sanitation projects.

Accordingly, this literature survey has been undertaken as a series of tasks designed to meet the above requirements. The review begins with a general overview of the South African sanitation experience, with specific reference to on-site technologies. Subsequently, the need for alternative technologies is examined. The review then explores the relationship between sanitation, the environment and public health, and links these concerns to the development of UD toilets.

Design and management practices for UD toilets in various countries, including South Africa, are then investigated, with the aim of illustrating the wide variety of methods and materials used. Operational aspects of UD toilets are subsequently addressed by examining current practices in urine and faeces management, both in South Africa and abroad. Because sanitation is for people, the review then studies the perceptions and experiences of UD toilet users around the world and attempts to identify how they are affected by design, implementation practices or other factors.

As many operational practices are associated with re-use of excreta for agricultural purposes, this aspect is then investigated in some detail, with experiences from various countries being described. The penultimate section of the review presents an in-depth investigation of the health and safety aspects of urine-diversion toilets, with particular attention to the re-use of urine and processed faeces in food gardens.

The final section of the review is devoted to a summary of the most pertinent issues identified, an indication of what matters remain unresolved, and an assessment of how the review should influence and guide the present research.

1.2 SANITATION: THE SOUTH AFRICAN EXPERIENCE

In South Africa (as in most developing countries of the world) the most commonly used sanitation technologies are waterborne sewerage at one end of the scale and pit toilets at the other. There are some intermediate technologies, such as septic tanks, but it is a fact that everybody aspires to the top-of-the-range article. This is so despite implications such as high water usage, high operation and maintenance costs, and the advanced technology and institutional capacity required for removal, treatment and disposal of the excreta. Ventilated improved pit (VIP) toilets have unfortunately also acquired the stigma of being a “poor man’s solution” to the sanitation problem, which has tarnished the image of this basically sound technology (Austin and Van Vuuren 2001).

Inadequately maintained sewer-reticulation systems in urban areas have caused adverse environmental impacts, most often as a result of leaking or blocked sewers, but sometimes also as a result of overloaded or inadequately operated or maintained treatment works and failed pumping stations. In poor areas, especially, most of the operational difficulties are concentrated at the user end of the systems, where personal cleaning materials other than proper toilet tissue paper are used, and also due to a lack of education on the proper use of cistern flush toilets (WRC 1993).

Many community sanitation schemes have been successfully implemented utilising VIP toilets. However, others have been problematic, often due to poor design and construction practices or to social factors such as a lack of community buy-in, or a combination of these. Sufficient attention is not always given to factors such as environmental impact, social issues, water-supply levels, reliability or institutional capacity (Austin and Van Vuuren 2001). The result has often been a legacy of poorly planned and inadequately maintained systems provided by well-intentioned but shortsighted authorities and developers (Austin and Duncker 2002).

South Africa’s GNP classifies it as partly developed and partly undeveloped. It is an unequal economy with large discrepancies in wealth between rich and poor. Some of its inhabitants have a high level of service; others have very little at all. The combination of these factors has brought about resistance to the use of on-site sanitation in the country, centred around issues such as (WRC 1994):

- A perception that the use of on-site sanitation implies “second class”;
- a perception that there is plenty of money in the country for a high level of service;
- a disbelief that waterborne sewerage costs as much as it does;
- a perception that waterborne sewerage is a robust system, whereas it is in fact a fragile system that is sensitive to misuse and the use of inappropriate cleansing materials. Furthermore there is a lack of appreciation of the consequences of failure of such systems;
- a perception that on-site sanitation is unhealthy, that it does not work as well as full waterborne sewerage, and will cause disease; and
- concern that on-site sanitation may pollute the country’s scarce water resources.

At all levels, the problem is related to socio-cultural, educational and institutional issues, with the lack of appropriate facilities and inadequate guidelines being a contributory factor. There is a need for new approaches and technologies that support alternative sanitation efforts (Austin and Duncker 2002).

In its 1996 draft sanitation policy, the South African government stressed that sanitation was not simply a matter of providing toilets, but rather an integrated approach that encompassed institutional and organizational frameworks as well as financial, technical, environmental, social and educational considerations. It was recognised that the country could not afford to provide waterborne sanitation for all its citizens – nor, for that matter, should it necessarily aspire to do so. The basic level of sanitation service in South Africa was defined in the Draft White Paper on National Sanitation Policy as a “ventilated improved pit (VIP) toilet in a variety of forms, or its equivalent, as long as it meets certain minimum requirements in terms of cost, sturdiness, health benefits and environmental impact” (DWAF 1996). In the September 2001 White Paper, the definition “basic level of service” has been replaced by the term “adequate sanitation”, which is judged by criteria that the service should promote health and safety, and that it should be attainable and sustainable socially, economically, environmentally and technically (DWAF 2001).

1.3 THE NEED FOR ALTERNATIVE SANITATION TECHNOLOGIES

Sanitation is an extremely complex issue. It is an issue that impacts on the daily lives of every human being inhabiting this planet, particularly in the developing countries where the level of service is either poor or nonexistent. There is no single solution that can be applied as a universal panacea and the situation will continue to worsen unless new approaches are adopted (Austin and Duncker 2002).

Simpson-Hébert (1996) proposes a number of interrelated guiding principles, among which are the following:

- The sanitation sector must continue to innovate low-cost facilities for people with different needs, from different climates, and with different customs. It is wrong to choose one or two technologies and push them as “the solution”. A particular product may be right for a certain section of the market, but not for all consumers and conditions. More research and better designs are still needed.
- There is a need in some societies to recycle human excreta as fertiliser, as has been done for centuries in various parts of the world. Human excreta can be rendered harmless, and toilet designs that do this in harmony with agricultural and social customs hold promise for the future.
- Toilets are consumer products: their design and promotion should follow good marketing principles, including a range of options with attractive designs based upon consumer preferences, and also be affordable and appropriate to local environmental conditions. Sanitation systems should neither pollute ecosystems nor deplete scarce resources. Systems should also be capable of protecting people from excreta-related diseases as well as interrupting the cycle of disease transmission.

Sanitation programmes that fulfil these principles simultaneously have a greater likelihood of long-term sustainability. Simpson Hébert (1997) consequently makes, *inter alia*, the following recommendations for implementing sanitation programmes:

- impetus should be provided for research and development for a range of systems applicable to differing cultural and environmental conditions; and

- a demand should be created for systems that move increasingly toward re-use and recycling of human excreta.

Winblad (1996a & 1996b) maintains that sanitation approaches based on flush toilets, sewers and central treatment plants cannot solve the sanitation problem. Nor can the problem in high-density urban areas be solved by systems based on various kinds of pit toilets. According to him, there exists an erroneous assumption that the basic problem is one of “sewage disposal”, while in actual fact the problem is the disposal of human faeces and urine, not sewage. This is because the human body does not produce “sewage”. Sewage is the product of a particular technology. To handle faeces and urine separately should not be a great problem, as each human produces only about 500 litres of urine and 50 litres of faeces a year. The problem arises only when these two substances are mixed together and flushed into a pipe with water to form sewage. This means that, instead of only fifty litres of problem material, it becomes necessary to deal with 550 litres of polluted, dangerous and unpleasant sewage. In a conventional waterborne system, this may use as much as 15 000 litres of pure water.

Urine diversion sanitation technology is based on the concept of keeping these two substances separate. The main advantages of this approach are, firstly, that valuable nutrients such as nitrogen, phosphorus and potassium are found in urine, and secondly, the dangerous pathogens present in faeces are more easily isolated from the environment (Austin and Duncker 2002).

According to Dudley (1996), “conventional” sanitation options may be suited to certain situations, but in other circumstances where both water and space are scarce there is a clear need for permanent, emptiable toilets which do not require water. Such circumstances are becoming increasingly common. When limits are placed on other variables, for example money and the depth of the water table, the circumstances where options such as sewers and pit toilets are viable become fewer, while the need for permanent, emptiable, waterless toilets grows.

Even if the sanitation crisis can be communicated to and understood by more people, the need to find sustainable alternatives to conventional approaches for both developed and developing countries remains. Sanitation can no longer be a linear process where excreta are hidden in deep pits or flushed downstream to other communities and ecosystems. Sustainable and ecological sanitation requires a holistic approach (EcoSanRes 2003).

1.4 URINE-DIVERSION TECHNOLOGY AS AN ALTERNATIVE TO PIT TOILETS

Many community sanitation schemes have been successfully implemented utilising VIP toilets. Unfortunately, others have failed, usually due to poor design and construction practices or to social factors such as a lack of community buy-in, or a combination of these. New or unknown technologies are often viewed with suspicion or rejected out of hand. Some cultural beliefs and practices may also make it difficult to introduce alternative technologies into a community (Austin and Duncker 2002). Attempts have been made to find simple, universally applicable solutions to sanitation problems; however, these often fail because the diversity of needs and contexts is ignored. Urban needs usually differ from rural needs, the technological options offered are limited and often inappropriate, and critical social issues such as behaviour are either ignored altogether or badly handled (Simpson-Hébert 1995). Furthermore, the scope of

environmental protection becomes so broad that the main purpose of sanitation provision is often lost. Current approaches also tend to stifle innovation.

VIP toilets, correctly engineered and implemented, are a good means of providing sanitation in areas where financial factors preclude the provision of a higher level of service. These systems are not without their problems, however. Geotechnical conditions, such as hard or rocky ground, for instance, sometimes make the choice of this technology inappropriate. In other cases, non-cohesive soils will require a pit to be fully lined in order to prevent collapse of the structure. Pits should preferably also be avoided in areas with shallow water tables, especially in aquifers with high hydraulic conductivity, where rapid transmission of pollutants is possible. These toilets are also unsuited to densely populated urban or peri-urban environments (Austin and Duncker 2002).

Full pits are a further problem. In many cases the owners will not be in a financial position to empty them, even if the toilets have been constructed with this in mind (e.g. removable cover slabs). While there may be plenty of available space in rural areas to dig further pits, this will seldom be the case in densely populated urban areas. This aspect does not even take into account the cost of digging a new pit and moving or rebuilding the superstructure, so for all practical purposes the initial investment is lost when the pit fills up. Some other solution should be sought in these cases, and the ventilated improved double pit (VIDP) toilet has gone some way in addressing this problem (Austin and Van Vuuren 2001).

If a dry toilet is designed and constructed in such a way that the faeces receptacle can be quickly, easily and safely emptied, then one of the biggest operation and maintenance problems associated with these toilets will be obviated. If the processed excreta can also be productively and safely used for agricultural purposes, and if the community is so inclined, the technology will become even more attractive. In South Africa, where many rural communities rely on subsistence agriculture, often in poor soils, and with urban agriculture becoming more common in certain communities, this is an important aspect (Austin and Van Vuuren 2001). However, re-use of the processed excreta is not a prerequisite for the implementation of this technology, as they can be disposed of without damage to the environment (Austin and Duncker 2002).

To address these shortcomings, it has been necessary to think beyond the limitations imposed by traditional methods of providing dry sanitation. There is an increasing awareness worldwide of the environmental issues associated with sanitation. Furthermore, pressure on land to produce more food to feed the ever-growing populations of developing countries has made the utilisation of valuable natural resources, including human excreta, of greater significance. The concept of ecological sanitation, or "ecosan" as it is also known, is seen as an alternative solution to some of the problems associated with pit toilets, environmental degradation and food shortages (Austin and Duncker 2002).

Problems with conventional sanitation approaches include inadequate institutional capacity to deal with the sanitation process, a fixation with providing either a full waterborne system or a VIP toilet, the social acceptability of different systems, and the perception that dry, on-site sanitation systems are inherently inferior. The basic purpose of any sanitation system is to contain human excreta (chiefly faeces) and prevent the spread of infectious diseases, while at the same time avoiding damage to the environment. If an alternative sanitation technology can perform these functions

with fewer operational and maintenance problems than those associated with conventional VIP toilets, and also produce a free, easily accessible and valuable agricultural resource for those who wish to use it, then its implementation should be actively encouraged (Austin and Van Vuuren 2001). Ecological sanitation fulfils these requirements (Austin and Duncker 2002).

The technology of ecological sanitation, or “dry box” toilets, has been used successfully for many years in a number of developing countries, e.g. Vietnam, China, Mexico, El Salvador, Ecuador, Guatemala and Ethiopia, and recently also in Zimbabwe and South Africa. Even in a highly developed country such as Sweden there is a great deal of interest in the technology (Esrey et al 1998; Hanaeus et al 1997; Höglund et al 1998; Jönsson 1997; Wolgast 1993). The most important difference between this technology and that of composting is the moisture content in the faeces receptacle. The urine is diverted at source by a specially designed pedestal and is not mixed with the faeces. A schematic representation is given in Figure 1.1. A pit is not necessary as the entire structure may be constructed above ground, or may even be inside the dwelling. Ash, dry soil or sawdust is sprinkled over the faeces after each defecation. The ash absorbs the moisture and also controls odours and flies. The dry conditions facilitate rapid desiccation of the faeces. The desiccated faeces make a good soil conditioner, while urine is an excellent source of fertiliser, being rich in nitrogen, phosphorus and potassium (Austin and Van Vuuren 2001).

Ecological sanitation systems are neither widely known nor well understood. They cannot be replicated without a clear understanding of how they function and how they can malfunction. They have some unfamiliar features such as urine-diversion pedestals or squatting plates. In addition, they require more promotion, support, education and training than VIP toilets (Esrey et al 1998).

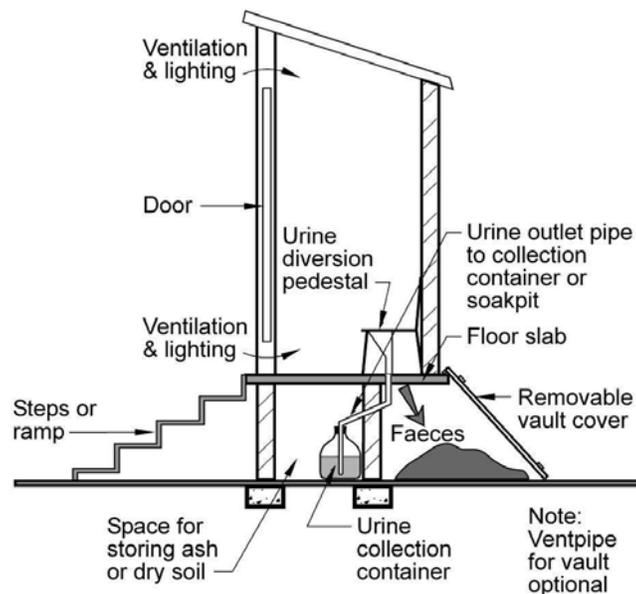

Figure 1.1: Schematic representation of a urine-diversion (“dry-box”) toilet (CSIR 2000)

A concern is often expressed that some ecological sanitation systems are too expensive for low-income households in developing countries. Ecosan systems need not cost more than conventional systems. While some systems may be sophisticated and expensive, others are relatively simple and low-cost. There is often a trade-off between cost and operation: lower-cost solutions mean more manipulation and care of the sanitation system, while with higher-cost solutions manipulation and care can be reduced. Ecosan systems need not be expensive to build because:

- the entire structure can be built above ground – there is thus no need for expensive digging and lining of pits; and
- urine is diverted, no water is used for flushing and the volume of the processing vault is fairly small, as it is emptied periodically (Esrey et al 1998).

The introduction of ecosan systems is bound to lower the total cost of urban sanitation in particular. If a waterborne system is being considered, the sewers, treatment plants and sludge-disposal arrangements will cost several times as much as an ecosan system, while for ordinary VIP toilets the institutional capacity required for desludging full pits may be nonexistent. These are important considerations for developing countries, where public institutions face stringent financial limits (Esrey et al 1998). Furthermore, households will have a wider choice of sanitation systems and thus have more freedom to decide what is affordable and most suitable for them.

1.5 THE ENVIRONMENT AND PUBLIC HEALTH: THE ARGUMENT FOR ECOLOGICAL SANITATION

As a result of faulty sanitation systems design, their incomplete implementation, poor operation and improper use, human excreta are spread throughout the environment. Vast amounts of improperly managed faeces and untreated sewage contaminate the living environment of people, soils and bodies of water. Existing systems and available resources are often inadequate to deal with the associated social and behavioural factors. This inability of existing sanitation systems to properly manage the increasing volumes of human excreta has contributed much to the worldwide escalation in ecological problems. With rapid population growth, especially in urban areas, the situation will not improve unless there is a significant change in the manner in which sanitation systems are chosen, designed and implemented (Simpson-Hébert 1997).

Environmental problems in turn undermine the process of development, which is further hampered by rapid population growth. In all developing countries, especially in sub-Saharan Africa, the population growth in the urban areas alone is outstripping the capacity of these regions to provide for basic needs such as shelter, water and sanitation. In the city of Dar es Salaam in Tanzania, to name but one example, pit toilets and septic tanks with drainfields serve about 76 % of the population, and this has caused serious faecal pollution of the groundwater, which is generally only 1 m to 3 m below ground level. Faecal coliform levels of up to 3 000/100 ml have been recorded (Kaseva 1999).

Water quality is deteriorating all over the world due to pollution. Some cities in the developing world treat only about 10 % of their sewage (Björklund 1997). Even in South Africa, reports have indicated that an alarming proportion of sewage waste in many towns and cities across the country does not reach treatment plants, but flows untreated into the rivers. This is regarded as one of the most pressing water quality

problems in the country. In many cases, even when sewage reaches the treatment plant, poor operation or malfunction of systems means that partially treated effluent is discharged to rivers. Litter and other pollutants from poorly serviced areas have also impacted the natural functioning of river ecosystems to such an extent that many rivers near urban areas have lost their ability to assimilate pollutants (DWAF 1999).

Simpson-Hébert (1997) maintains that one of the constraints to providing efficient sanitation in urban areas is the myth that the only good sanitation system in such places is conventional waterborne sewerage. While this type of sanitation system has been widely successful in controlling the transmission of excreta-related diseases in most cities of industrialised countries, it has also created severe damage to ecosystems and to natural water resources where the wastewater is inadequately treated. Since proper treatment increases the cost and energy requirements of the entire system without being essential to the day-to-day survival of the individual user, this part of the system is often omitted when financial resources are scarce. Consequently, in those cities of developing countries that have a conventional sewer system, only a very small percentage of the wastewater collected is treated at all. In many areas this has resulted in severe ecological damage, with heavy economic consequences.

Esrey et al (1998) point out that globally, sewage discharges from centralised, waterborne collection systems are a major component of water pollution, contributing to the nutrient overload of water bodies. Although waterborne systems are acceptable to the vast majority of people, they are technologically complex and require institutional capacity and skills that are not always available. Over 90 % of all sewage in developing countries is discharged completely untreated.

The success or failure of a sanitation system depends on the interaction of environmental, human and technical factors. The most important environmental aspects are climate, soil and groundwater; these vary from place to place and have a great influence on the choice of the most appropriate sanitation system. The technology selected should therefore be adapted to the local environmental conditions (Winblad and Kilama 1980).

It is better to protect the environment from faecal pollution than to undertake expensive measures to reduce pollution that has already taken place (Feachem and Cairncross 1978). The approach to the sanitation challenge should therefore be ecologically sustainable, i.e. concerned with the protection of the environment. This means that sanitation systems should neither pollute ecosystems nor deplete scarce resources. It further implies that sanitation systems should not lead to a degrading of water or land and should, where possible, ameliorate existing problems caused by pollution. Sanitation systems should also be designed to recycle resources such as water and nutrients present in human excreta (Simpson-Hébert 1997).

In many urban centres, the poorest groups face the most serious environmental hazards and are least able to avoid them or receive treatment to limit their health impact (Wall 1997). By early this century, more than half of the world's population is expected to be living in urban areas. By the year 2025, this urban population could rise to 60 %, comprising some 5 billion people. The rapid urban population growth is putting severe strains on the water supply and sanitation services in most major conurbations, especially those in developing countries (Mara 1996). In Africa today, over half the population is without access to safe drinking water and two-thirds lacks a sanitary means of excreta disposal. It is a situation in which the poor are adversely affected to a

disproportionate degree. Lack of access to these most basic of services necessary to sustain life lies at the root of many of Africa's current health, environmental, social, economic and political problems. Hundreds of thousands of African children die each year from water- and sanitation-related diseases. Despite significant improvements during the International Drinking Water Supply and Sanitation Decade (1981-1990), progress has now stagnated. More people are today without adequate services in Africa than in 1990, and at the current rate of progress full coverage will never be achieved (WSSCC 1998).

Western sanitation solutions were designed and built on the twin premises that human excreta are waste products suitable only for disposal, and that the environment is capable of assimilating the waste. Times have changed and these premises are outdated. Current sanitation interventions contribute, either directly or indirectly, to many of the problems faced by society today: water pollution, scarcity of fresh water, food insecurity, destruction and loss of soil fertility, global warming and poor human health (Esrey and Andersson 1999).

Although conventional sewage systems transport excreta away from the toilet user, they fail to contain and sanitise, instead releasing pathogens and nutrients into the downstream environment. This is considered the "linear pathogen flow" (Esrey et al 1998). These systems mix faeces, urine, flush water and toilet paper with greywater and industrial effluents, often overtaxing the design capacity of the treatment plants, if such a facility exists, as very few communities in the world are able to afford fully functional sewage systems. Flushing sanitation systems have a "dismal track record" because all sewage systems contaminate the environment (EcoSanRes 2003).

Far more common than flush sanitation is the pit toilet, primarily because it is inexpensive and requires no infrastructure. This method also fails to contain and sanitise excreta since pathogens and nutrients seep into the groundwater. Deep pit toilets also fail to recycle since the excreta are too deep for plants to make use of the nutrients. Pits are prone to periodic flooding, causing them to spill their contents, and are often poorly maintained, continuing to be a source of disease and pollution (EcoSanRes 2003).

The "linear pathogen flow" is also described as a "flush-and-discharge" sanitation system (Esrey et al 1998). For each person, some 500 litres of urine and 50 litres of faeces are flushed away each year, together with 15 000 litres of pure water. Bath, kitchen and laundry water (greywater), amounting to a further 15 000 to 30 000 litres, is then added. Further down the pipe network, heavily polluted water from industries may also join the flow. Thus at each step in the flush-and-discharge process the problem is magnified. The dangerous component, 50 litres of faeces, is allowed to contaminate not only the relatively harmless urine but also the large amount of pure water used for flushing and an equal or even larger amount of greywater. In Third World countries, 90% of this sewage is discharged completely untreated into surface waters, while in Latin America the figure is 98%. This linear, or "open" system is illustrated in Figure 1.2.

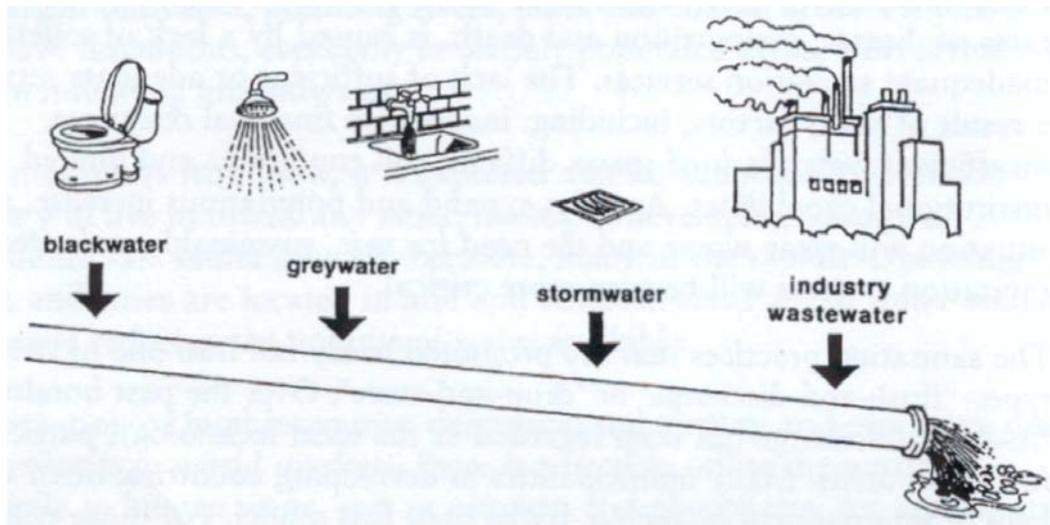

Figure 1.2: The linear, or open, flow system (Esrey et al 1998)

The ecosan approach to sanitation promotes a cycle, or “closed” system instead, where human excreta are treated as a resource. Excreta are processed on site and then, if necessary, further processed off site until they are completely free of disease organisms. The nutrients contained in the excreta are then recycled by using them as fertiliser in agriculture (Figure 1.3).

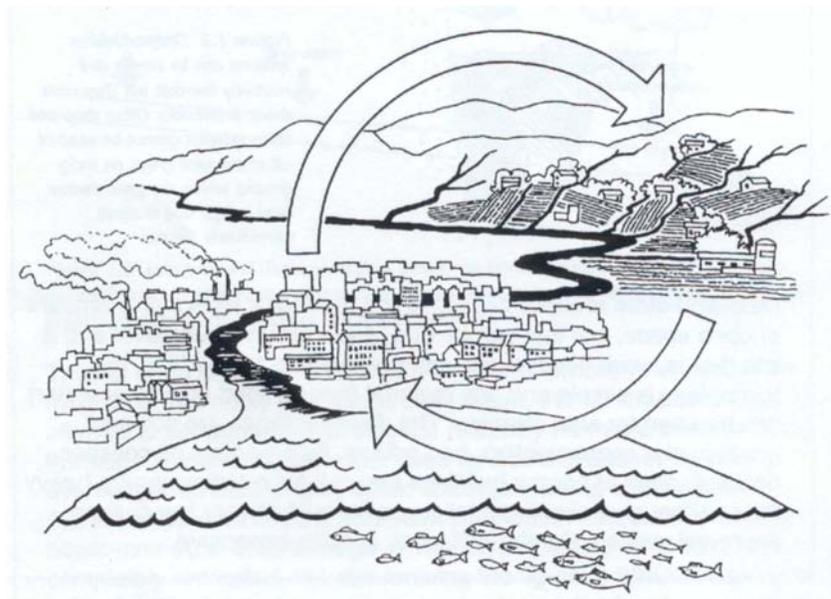

Figure 1.3: The cycle, or closed loop, system (Esrey et al 1998)

Closed-loop wastewater management and sanitation helps restore the remarkable natural balance between the quantity of nutrients excreted by people each year and the quantity required to produce their food. Ideally, ecosan systems enable the almost complete recovery of all nutrients and trace elements from household wastewater and their reuse in agriculture. They help preserve soil fertility and safeguard long-term food security. The technology employed can be simple, low-tech arrangements or sophisticated high-tech systems. These range from composting or urine-diversion dry systems to water-saving vacuum sewage systems with separate collection and subsequent treatment of urine, faeces and greywater, through to membrane technology for material separation and hygienisation. Of key importance are innovative logistics to return nutrients to farmland, marketing strategies for the recovered nutrients and directions for their safe application in agriculture (GTZ 2002).

Ecosan defined (EcoSanRes 2003)

Ecological sanitation can be viewed as a three-step process: containment, sanitisation and recycling of human excreta. The objective is to protect human health and the environment while reducing the use of water in sanitation systems and recycling nutrients to help reduce the need for artificial fertilisers in agriculture. Ecosan represents a conceptual shift in the relationship between people and the environment, and is built on the necessary link between people and soil (Figure 1.4).

Ecosan systems are designed around true containment of pathogens and provide two ways to render human excreta innocuous: dehydration and decomposition. The preferred method will depend on climate, groundwater tables, amount of space and intended purpose for the sanitised excreta.

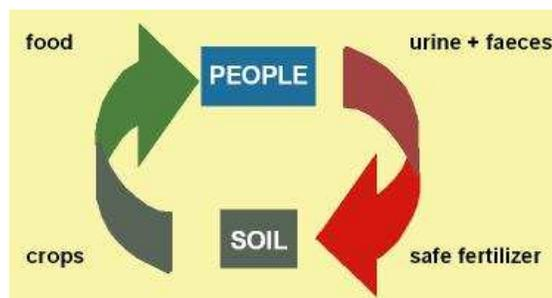

Figure 1.4: The concept of ecological sanitation (EcoSanRes 2003)

Dehydration is the chemical process of destroying pathogens by eliminating moisture from the immediate (containing) environment. Some drying materials, like wood ash, lime and soil are added to cover the fresh deposit. Ash and lime increase the pH, which acts as an additional toxic factor to pathogens if it can be raised to over 9,5. The less moisture the better, and in most climates it is better to divert the urine and treat it separately. The toilet units may be single or double-vault.

Soil composting toilets make use of the process of decomposition, a biological process carried out by bacteria, worms and other organisms to break down organic substances. In a composting environment, the competition between organisms for available carbon and nutrients continues until the pathogens are defeated by dominant soil bacteria.

Soil-composting toilets are constructed using shallow vaults where soil and ash are added after each use. The vaults are used alternately and, once sanitised and composted, the contents are removed and used in agriculture.

The ecological sanitation approach can be broadened to cover all organic material generated in households (kitchen and food wastes). If these organic materials are sorted within the home, rather than mixed with solid waste and dumped, they become valuable recyclable materials once composted. Greywater can be treated using biological systems such as evapotranspiration beds and constructed wetlands, and rainwater harvesting can be implemented to harness water for personal hygiene and irrigation. Figure 1.5 illustrates all the options in a fully functional ecosan household.

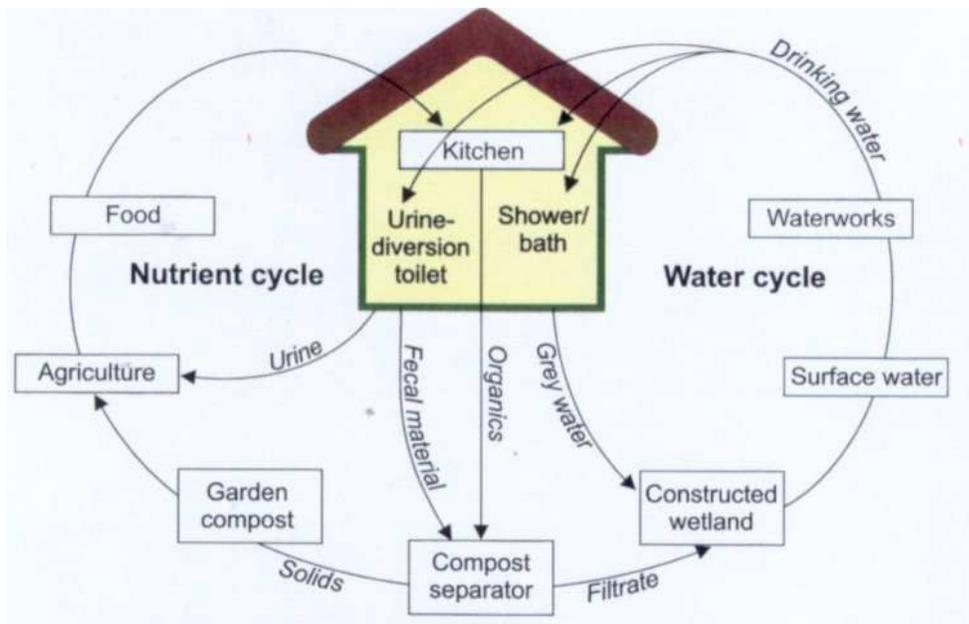

Figure 1.5: Complete household ecosan
(M. Oldenburg (Otterwasser) quoted in EcoSanRes 2003)

The Bellagio statement:

Clean, healthy and productive living: A new approach to environmental sanitation¹

In the world today, 1,2 billion people are without access to safe drinking water, 3 billion are without proper sanitation, and 50 % of solid wastes remain uncollected. Meeting at Bellagio from 1 to 4 February 2000, an expert group brought together by the Environmental Sanitation Working Group of the Water Supply and Sanitation Collaborative Council (WSSCC) agreed that current waste management policies and practices are abusive to human well-being, economically unaffordable and

¹ The WSSCC has defined environmental sanitation as: "Interventions to reduce peoples' exposure to disease by providing a clean environment in which to live, with measures to break the cycle of disease. This usually includes hygienic management of human and animal excreta, refuse, wastewater, stormwater, the control of disease vectors, and the provision of washing facilities for personal and domestic hygiene. Environmental sanitation involves both behaviours and facilities which work together to form a hygienic environment."

environmentally unsustainable. The group called for a radical overhaul of conventional policies and practices world-wide, and of the assumptions on which they are based, in order to accelerate progress towards the objective of *universal access to safe environmental sanitation, within a framework of water and environmental security and respect for the economic value of wastes*.

The principles governing the new approach are as follows:

1. Human dignity, quality of life and environmental security should be at the centre of the new approach, which should be responsive and accountable to needs and demands in the local setting.
 - Solutions should be tailored to the full spectrum of social, economic, health and environmental concerns.
 - The household and community environment should be protected.
 - The economic opportunities of waste recovery and use should be harnessed.
2. In line with good governance principles, decision-making should involve participation of all stakeholders, especially the consumers and providers of services.
 - Decision-making at all levels should be based on informed choices.
 - Incentives for provision and consumption of services and facilities should be consistent with the overall goal and objective.
 - Rights of consumers and providers should be balanced by responsibilities to the wider human community and environment.
3. Waste should be considered a resource, and its management should be holistic and form part of integrated water resources, nutrient flows and waste management processes.
 - Inputs should be reduced so as to promote efficiency and water and environmental security.
 - Exports of waste should be minimised to promote efficiency and reduce the spread of pollution.
 - Wastewater should be recycled and added to the water budget.
4. The domain in which environmental sanitation problems are resolved should be kept to the minimum practicable size (household, community, town, district, catchment, city) and wastes diluted as little as possible.
 - Waste should be managed as close as possible to its source.
 - Water should be minimally used to transport waste.
 - Additional technologies for waste sanitation and reuse should be developed.

1.6 CONCLUSIONS

Conventional waterborne sewerage systems, generally the most sought-after sanitation technology, have been responsible for widespread environmental pollution in many countries. Although socio-economic issues are often responsible for this, a lack of institutional capacity has been shown to be an important contributory factor. On the other hand, on-site sanitation systems such as VIP toilets have acquired the stigma of a “second-class solution” in South Africa and have brought about resistance to on-site

systems in general. Poorly engineered on-site systems have also contributed to pollution in many cases.

Due to sanitation being an extremely complex issue, there is no “universal solution”; new approaches need to be adopted and impetus provided for research and development of systems catering for differing cultural and environmental conditions. It has been argued that sanitation approaches based on the use of large amounts of (potable) water, as well as those based only on pit toilets, cannot solve the sanitation problem. Sanitation should no longer be regarded as a linear process – to be sustainable, a holistic approach incorporating wider issues (e.g. amelioration of poor quality soils, poverty alleviation and food shortages) is required instead.

Ecological sanitation (ecosan) has been recommended as an alternative solution to some of the problems associated with pit toilets, environmental degradation and food shortages. This technology has been used successfully in many countries, both developing and developed, for many years. It is based on a three-step process: containment, sanitisation and recycling of human excreta. It also complies with the Bellagio Principles of safe environmental sanitation within a framework of water and environmental security and respect for the economic value of wastes.

CHAPTER 2: URINE-DIVERSION APPLICATIONS: EXAMPLES OF CURRENT PRACTICE

2.1 INTRODUCTION

To address the shortcomings of VIP toilets, it has been necessary to think beyond the limitations imposed by traditional methods of providing dry sanitation. There is increasing awareness worldwide of the environmental issues associated with sanitation. Furthermore, pressure on land to produce more food to feed the ever-growing populations of developing countries has made it imperative to utilise natural resources, including human excreta, wherever possible. The concept of ecological sanitation, or ecosan as it is also known, is seen in many countries as an alternative solution to some of the problems associated with pit toilets, environmental degradation and food shortages (Austin 2000).

In the alternative approach to sanitation – ecological sanitation – excreta are processed on site, and if required, off site, until completely free of pathogens and inoffensive. The faeces are sanitised close to the place of excretion, and then applied to the soil to improve its structure, water-holding capacity and fertility. Valuable nutrients contained in excreta, mostly in urine, are returned to the soil for healthy plant growth (Esrey et al 2001).

It is a different way of thinking about sanitation: a **closed-loop approach** in which the nutrients are returned to the soil instead of water or deep pits. Ecological sanitation is not merely a new latrine design – the closed-loop approach is also a zero-discharge approach, keeping water bodies free of pathogens and nutrients (Esrey et al 2001).

Sanitation using the technique of urine diversion is applied in many parts of the world. Various examples are described in the following pages.

2.2 EXAMPLES FROM OTHER COUNTRIES

2.2.1 Yemen

In the old city of Sanaa a single chamber dehydrating toilet with urine diversion is placed in the bathroom several floors above street level (Figure 2.1). In a traditional Yemeni townhouse the upper floors have toilet-bathrooms next to a vertical shaft that runs from the top of the house down to the level of the street. The faeces drop through a hole in the squatting slab and down the shaft, while the urine drains away through an opening in the wall and down a vertical drainage surface on the outer face of the building. Personal cleansing with water takes place on a pair of stones next to the squatting slab. The water is drained off in the same way as the urine. As Sanaa has a hot, dry climate, the urine and water usually evaporate before reaching the ground, while the faeces dehydrate quickly. They are collected periodically and used as fuel (Esrey et al 1998).

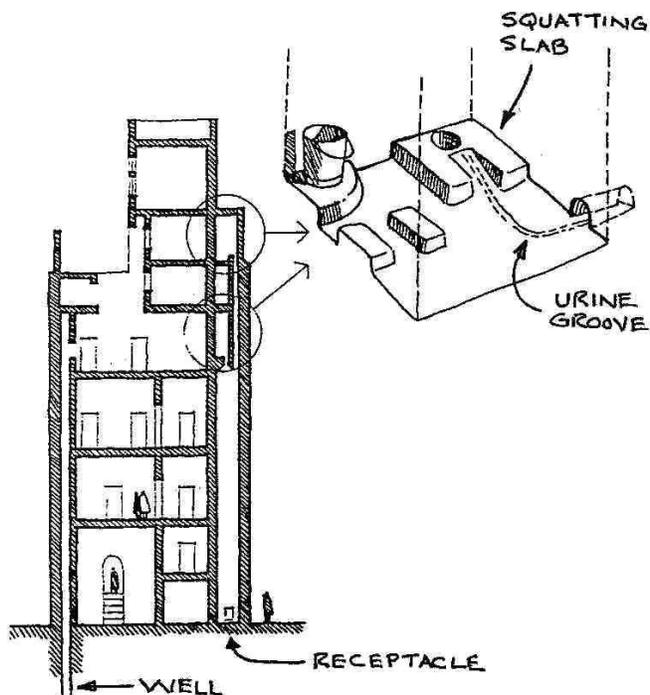

Figure 2.1: Section through a house in the old part of Sanaa, Yemen (Esrey et al 1998)

2.2.2 Vietnam

The Vietnam example is a double-chamber toilet built above ground, with drop-holes, footrests for squatting and a groove for conducting urine to a container (Figure 2.2). Faeces are dropped into one of the chambers while the other one is kept closed (i.e. the chambers are used in rotation, similar to a conventional VIDP toilet). The faeces are covered with kitchen ash, which absorbs moisture and deodorises them. Paper used for personal cleansing is put into a bucket and later burnt, while the dehydrated faecal material is used as a soil conditioner. These systems tend to be mostly anaerobic (Esrey et al 1998; Winblad 1996b).

The Vietnamese double-vault originated in the 1950s, when peasants who were using human excreta as manure found that composting reduced the smell and improved its fertiliser value. This became the key component of a rural sanitation programme for disease prevention and increased food production that began in North Vietnam in 1956. After much experimentation it was found that the addition of kitchen ash effectively neutralised the bad odours normally associated with anaerobic decomposition, and also destroyed intestinal worm ova – after a two-month composting period 85 % of the ova were found to have been destroyed (World Bank 1982). According to Van Buren et al (1984), these composting latrines produce more than 600 000 tons of organic fertiliser each year and have also been responsible for a substantial reduction in intestinal diseases.

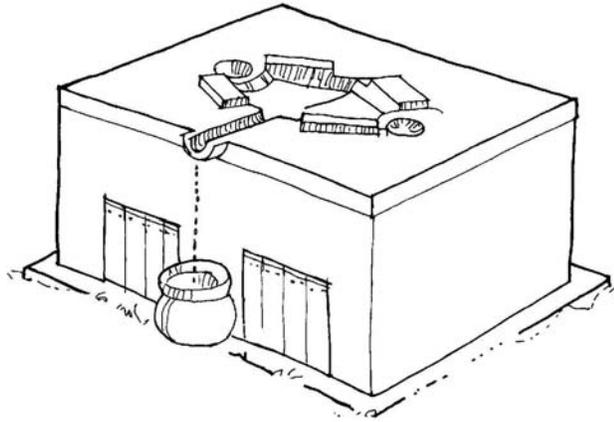

Figure 2.2: The Vietnamese double-vault dehydrating toilet, shown here without the superstructure. Each vault is about 0,8 m x 0,8 m square and about 0,5 m deep. The drop-hole not in use is closed with a stone and sealed with mud or mortar (Esrey et al 1998)

2.2.3 El Salvador

Some experimental urine diversion toilets have been equipped with a solar heater (Figure 2.3(a)). The main purpose of the heater is to increase evaporation in the chamber and thereby accelerate dehydration of the faeces. The example shown is from the community of Tecpan, near San Salvador. As there is no tradition of using human urine as fertiliser in Central America, the urine is piped into a soakpit beneath the toilet chambers. Wood ash and/or a soil/lime mixture is added to the processing vault, while toilet paper is placed in a container next to the pedestal and periodically burned. At intervals of one to two weeks the lid acting as solar heat collector is removed and the faeces/ash/soil pile beneath the pedestal raked to the rear of the vault, beneath the solar heater. This dry, odour-free pile is removed every couple of months and used as soil conditioner, as illustrated in Figure 2.3(b) (Esrey et al 1998; Winblad 1996b).

2.2.4 Ecuador

Figure 2.4 illustrates an example of a double-chamber solar-heated dehydrating toilet in Ecuador, high up in the Andes Mountains. At this altitude there is no need for urine diversion as the natural evaporation takes care of any excess liquid. The recycling system was chosen to help combat the problem of declining soil fertility in the region (Esrey et al 1998).

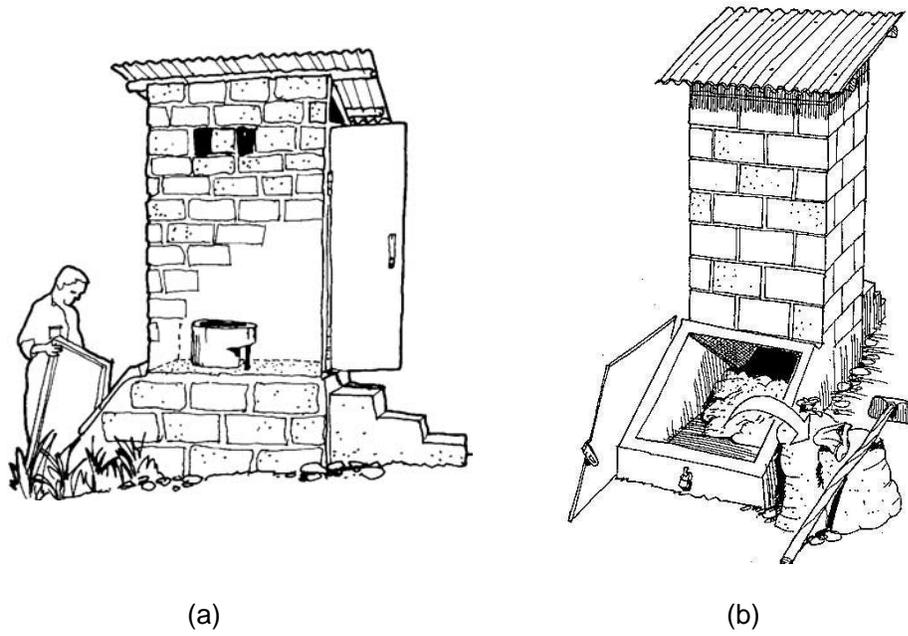

Figure 2.3
(a) Dehydrating toilet with urine diversion and solar-heated vault in El Salvador.
(b) Removing the desiccated faeces for use as soil conditioner.
 (Esrey et al 1998)



Figure 2.4: A solar-heated dehydrating toilet in Ecuador
 (Esrey et al 1998)

2.2.5 Mexico

In the Mexican city of Cuernavaca, a number of middle-class families live in modern dwellings where urine diversion toilets of a high standard, based on the Vietnamese double-vault version, are installed in-house (Figure 2.5). This urban application is of particular significance because it demonstrates that careful management of an ecosan system, resulting from high motivation and understanding on the part of the families involved, can make an extremely simple technology work very well in an urban area. When properly managed, these toilets have no smell and do not breed flies (Esrey et al 1998).

The pedestals are made of concrete polished to a high-class finish, after which they are painted. Fibreglass moulds are used for casting the pedestals (Figure 2.6).



Figure 2.5: The Mexican version of the Vietnamese double-vault toilet, installed in the bathrooms of modern houses in the city of Cuernavaca. The toilets have movable urine-diversion pedestals. The processing chambers below the bathroom floor are accessible from outside the house (César Añorve, CITA, A.C., Mexico)

2.2.6 Sweden

Sweden has advanced, modern urine-diversion sanitation systems. The pedestals are made of porcelain, in both dry and flushing versions (Figure 2.7). The flushing version is often found in high-density residential apartments or cluster housing. The urine is collected and stored in underground vaults, from where it is collected by farmers, while the faeces are flushed into a conventional waterborne sewerage system for further treatment. The reduced nutrient load of this sewage, due to the exclusion of nitrogen and phosphorus found in the urine, reduces the cost of treatment. The front compartment of the bowl, used for urine collection, is flushed with a spray of approximately 200 ml of water from a nozzle on the side of the

bowl, while the rear compartment is flushed from a conventional toilet cistern. However, this type of flushing toilet is not regarded as an ecological sanitation system, even if the urine is diverted (Austin and Duncker 2002).

The use of urine-diverting toilets in Sweden goes back to the nineteenth century. Figure 2.8 illustrates a toilet dating from 1880.

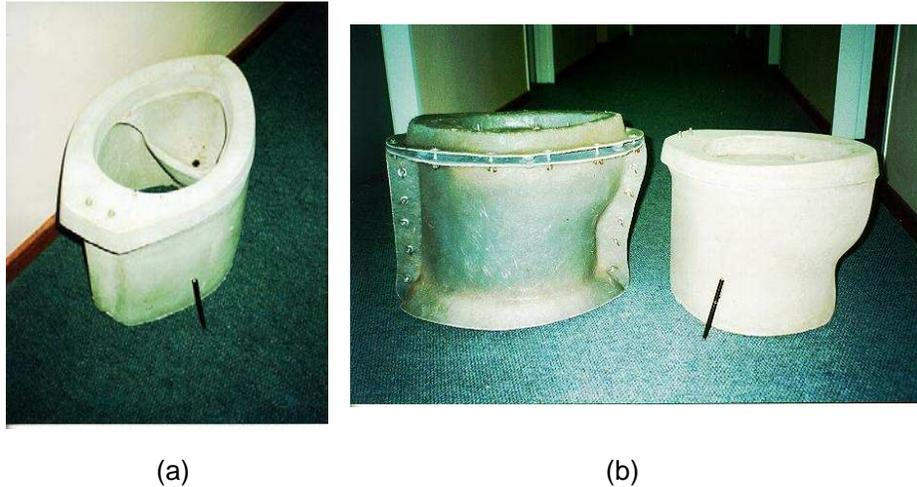

Figure 2.6: Mexican urine-diversion pedestal cast in mortar.
(a) The pedestal, which can be fitted with a conventional seat and lid.
(b) The pedestal shown alongside its fibreglass mould.
(Austin and Duncker 2002)

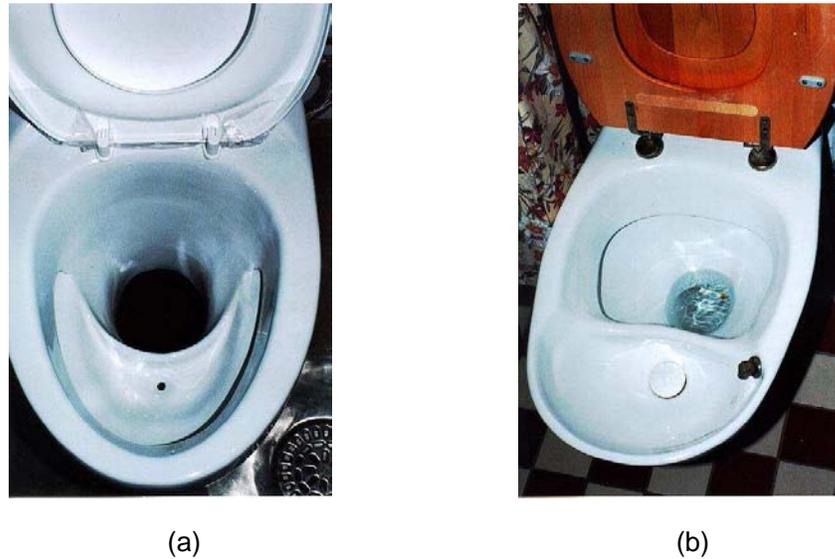

Figure 2.7: Swedish urine-diversion pedestals for
(a) dry system and (b) flushing system.
(Austin and Duncker 2002)



Figure 2.8: Porcelain urine-diversion toilet made in 1880 in Sweden
(<http://www.wost-man-ecology.se/affarsideen.html>)

2.2.7 Bolivia

Dry toilets incorporating urine diversion have been built by the community in El Alto, near La Paz, Bolivia (Figure 2.9). This is a peri-urban settlement on a plateau about 4 000 m above sea level. Locally available materials and components were used in a very simple type of construction. This type of toilet has a wooden bench seat while the urine collector consists of a wide plastic funnel. Under the hole in the seat are two buckets. Faeces deposited in the bucket are covered by a mix of ash, lime and sawdust, while used toilet paper is placed in a separate container and burned periodically. Full buckets are emptied into a bin for further storage and dehydration until safe to use on the land. Urine is collected in a container and used as liquid fertiliser.

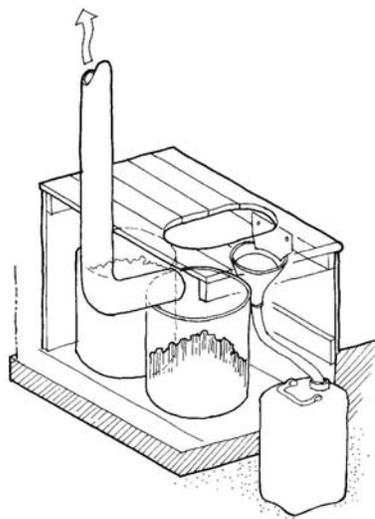

Figure 2.9: Urine-diversion toilet in El Alto, Bolivia
(Sanres 2000)

2.2.8 China

In China, many ecosan facilities have been built in Guangxi province (Figure 2.10). These are double-vault, ventilated urine-diversion toilets, built indoors. Fibreglass squatting pans were developed as part of a programme funded by the Swedish International Development Cooperation Agency (Sida) and are now produced in a factory in the city of Nanning (Sanres 2000). Porcelain squatting plates are also produced in a factory outside Beijing (Esrey et al 1998).



Figure 2.10. Urine-diversion ecosan toilets in Nanning area, China.
(a) Toilet in a house. One bucket contains ash and the other bucket is for disposal of toilet paper, while the water can is used for rinsing the urine bowl.
(b) School toilet. This version has a prototype ash dispenser. Ash or sand is stored in the “cistern” and depressing the foot-pedal spreads a small amount over the excreta deposited in the toilet. (Sanres 2000).

2.2.9 Zimbabwe

All ecological sanitation approaches in Zimbabwe are based on:

- (a) providing a means of removing human excreta safely and simply from the toilet;
- (b) preparing human excreta for use in agriculture by encouraging the formation of humus; and
- (c) reducing the pollution of groundwater and atmosphere as much as possible (Esrey et al 2001).

Various types of toilet systems are used to promote the principles of ecological sanitation in Zimbabwe, including single- and twin-pit composting systems in which the cultivation of trees and other plants, including food crops, is encouraged (Esrey et al 2001).

Mvuramanzi Trust, an organisation supporting water and sanitation initiatives in rural areas of Zimbabwe, is actively involved in promoting ecosan. Community members are enthusiastic participants and take part in the building process, which also helps them to acquire marketable skills. Urine-diverting toilets are built, consisting of a prefabricated wooden superstructure, asbestos roof, concrete floor slab, brick chamber and stairs, and a mortar pedestal similar to the Mexican version (Figure 2.11). The emphasis is on simplicity, which makes it easy for the units to be built with relatively unskilled labour (Proudfoot 2001).



(a)



(b)

Figure 2.11: Urine-diversion toilets in Zimbabwe.

(a) A simple but well-built toilet with wooden superstructure.

(b) Women from the community engaged in casting floor slabs. The slabs are simple structures, consisting of 60 mm thick concrete reinforced with barbed wire. (Proudfoot 2001)

2.3 EXAMPLES FROM SOUTH AFRICA

Since 1997, when South Africa's first urine-diversion sanitation project was implemented in three rural villages near Umtata in the Eastern Cape province, thousands of these toilets have been installed in various parts of the country. Some examples follow.

2.3.1 Eastern Cape

The Umtata pilot project consisted of 30 units, which were built for research and development purposes. They are single-vault brick structures with concrete floor slabs and zinc roofs (Figure 2.12). The pedestals are made of rotationally moulded plastic obtained commercially. Urinals were also included for the menfolk. Faeces are collected in separate wooden or plastic

containers in the chamber beneath the pedestal and are rotated when full (the toilet vaults are large enough to hold two containers). While being aware of the fertilising properties of excreta, the villagers do not actively re-use it, but simply dispose of the dehydrated faeces in their maize fields or vegetable gardens without working it into the soil, while the urine is led into shallow soakpits (Austin and Duncker 2002).

Ash from the home owner's cooking fire is stored in a plastic bin inside the toilet structure and this is sprinkled over the faeces after defecation, which effectively prevents odour and keeps flies away, as well as absorbing the inherent moisture and aiding dehydration. An additional advantage is the high pH value of the wood ash (about 10,5), which assists pathogen destruction. Another plastic bin is used for storing used anal cleansing material; this is disposed of at regular intervals by burial (Austin and Duncker 2002).

Due to the novelty of urine diversion in South Africa at the time, it was necessary to organise community workshops to facilitate understanding and acceptance of the technology. In addition, because of the low level of health and hygiene awareness in the villages, hygiene-awareness workshops were held before the completed toilets were handed over to the new owners (Austin and Duncker 2002).



(a)



(b)

Figure 2.12: The Eastern Cape pilot urine-diversion project near Umtata. (a) Toilet structure; (b) rotationally-moulded plastic pedestal.
(Austin and Duncker 2002)

2.3.2 Northern Cape

In many parts of the Northern Cape province there is only a thin layer of topsoil covering the hard, rocky material below. This makes it difficult and costly to construct any form of pit toilet, and urine diversion is a good solution to the sanitation problem in such areas (Austin and Duncker 2002). In fact, the initial marketing strategy used in the communities was that urine-diversion toilets were the only affordable option, given the geology of the area, otherwise residents would have to continue using the bucket system (Holden et al 2003).

Numerous UD sanitation projects have been implemented in various areas (Austin and Duncker 2002). Some are built as separate structures, while others are added onto the outside of a house but with the entrance from inside. Both single and double chambers are used and either a plastic or a mortar pedestal is installed. Some toilet structures are built in-situ using various types of bricks, while others consist of complete units made of prefabricated concrete panels, which are obtained commercially (Figures 2.13 – 2.19). In Campbell, many old bucket toilets have been converted to urine diversion, which is an easy and economical means of upgrading these unacceptable facilities.



(a)

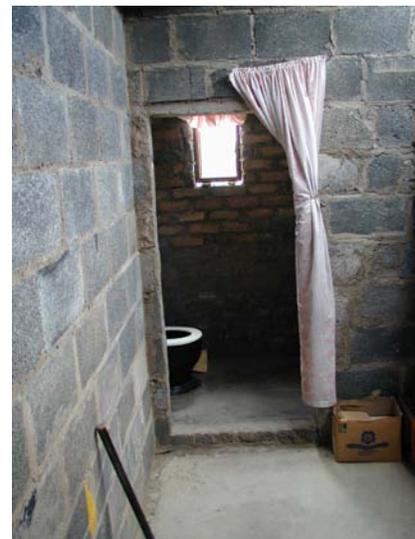

(b)

Figure 2.13: Double chamber urine-diversion toilet added onto house in Campbell, Northern Cape. (a) Exterior view; (b) interior view.

(Photographs: R. Holden, Mvula Trust)

Faeces are mostly collected on the floor of the chamber or, in the case of the prefabricated toilet units, in a net suspended beneath the pedestal. Ash or sand is sprinkled on the faeces and used anal cleansing material is deposited in the chamber. There is no culture of re-use in these areas and the desiccated faeces are often simply buried nearby. Occasionally they may be burned inside the chamber, together with the used cleaning

materials. This is an easy method of disposal, as only ash remains behind (Austin and Duncker 2002).



Figure 2.14: Double chamber urine-diversion toilets in Spoegrivier, Northern Cape. (a) Toilet added onto house; (b) separate toilet structure.

(Photographs: R. Holden, Mvula Trust)

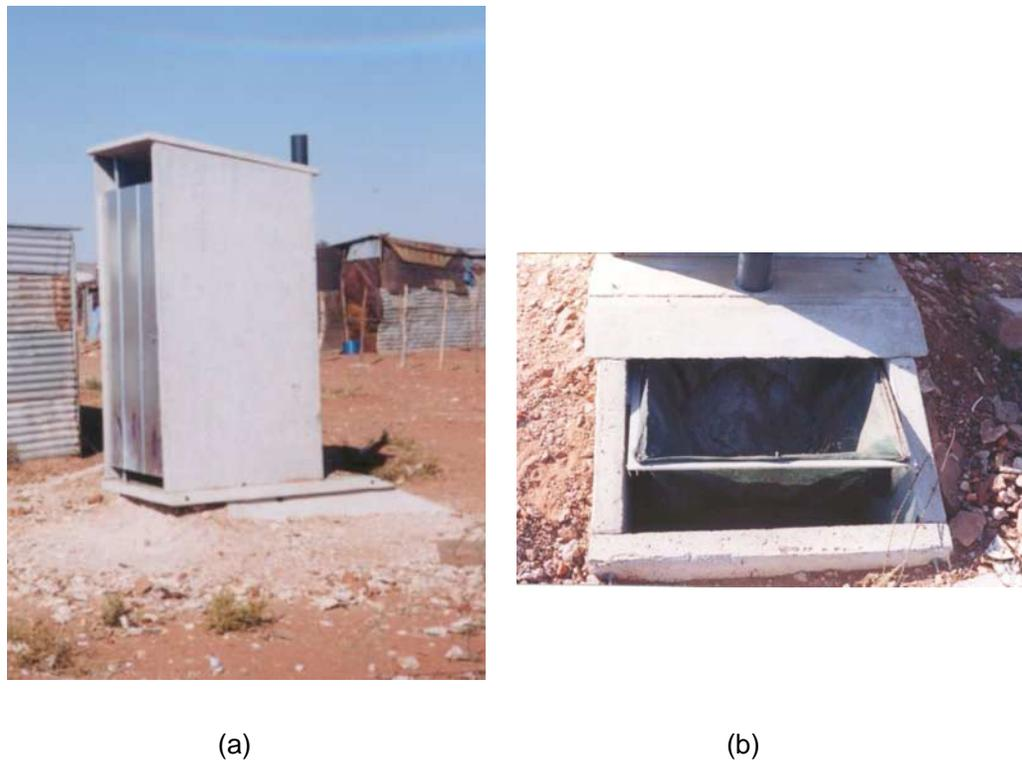

Figure 2.15: Commercial toilet unit made from prefabricated panels, Groblershoop, Northern Cape. (a) The vault may be partially beneath the ground; (b) faeces are collected in a net under the pedestal.

(Photographs: CSIR)



Figure 2.16: Conversion of bucket toilets in Campbell, Northern Cape
(Photograph: R. Holden, Mvula Trust)



(a)



(b)

Figure 2.17: Urine-diversion toilets in Merriman, Northern Cape.
(a) This toilet has been installed inside the bathroom; (b) the vault is outside the bathroom wall and has an inspection hole in the slab to enable the owner check the volume of accumulated faeces.
(Photographs: CSIR)



(a)



(b)

Figure 2.18: (a) Free-standing brick toilet structure in Alheit; (b) toilet built into house, Britstown, Northern Cape
(Photographs: CSIR)



Figure 2.19: Toilets in Hanover, Northern Cape, are constructed with alternating drop-holes for the pedestal, but with a single vault
(Photographs: CSIR)

2.3.3 eThekweni, KwaZulu-Natal

Due to logistical difficulties experienced with providing an emptying service for pit toilets in the metropolitan area, the eThekweni council decided in May 2001 that basic on-site sanitation would in future be provided in the form of urine-diversion toilets instead. By February 2004, more than 10 000 units had already been built (Harrison 2004). The toilets are of the double vault type, with the substructure consisting of prefabricated concrete panels and the superstructure of cement bricks with a zinc roof (Figure 2.20(a)). A commercially available plastic pedestal is installed on one of the vaults, while the opening for the second vault is covered with a concrete plug until it is required for use (Figure 2.20(b)). A plastic urinal is also supplied.



(a)



(b)

Figure 2.20: Typical double vault urine-diversion toilet provided in eThekweni
(Photographs: F. Stevens, eThekweni Water Services)

2.3.4 North West

In the Taung region of North West, more than 600 hundred urine-diversion toilets have been constructed in 11 villages (July 2004). These are mainly of the single vault type, with brick walls and corrugated iron roofs, and are free-standing units. The vault covers are made of either corrugated iron or concrete. The former are, however, poorly fabricated and ill-fitting. Pedestals are mainly of the concrete variety and neatly painted, but many of the urine pipes are blocked. The toilets are illustrated in Figures 2.21 and 2.22.



(a)



(b)

Figure 2.21: This urine-diversion toilet in Kokomeg, in the Taung area, is well maintained. The structure has a concrete vault lid and a proper window.



(a)



(b)

Figure 2.22: Urine -diversion toilets in Matsheng, in the Taung area. (a) Badly-fitted corrugated iron lid on the vault; (b) blocked urine pipe. (Photographs: CSIR)

2.3.5 Johannesburg, Gauteng

A urine diversion toilet pedestal may also be retrofitted into an existing house. Richard Holden of Mvula Trust lives in the suburb of Bellevue, Johannesburg. He removed the existing flushing toilet from his bathroom and replaced it with a Mexican-type urine diversion one made from mortar. The work entailed breaking through the wall and floor of the bathroom, excavating a chamber beneath and patching everything up again (Figure 2.23).



Figure 2.23: Retrofitted urine-diversion toilet in Richard Holden’s house in Bellevue, Johannesburg (Photograph: CSIR)

2.4 CONCLUSIONS (Austin and Duncker 2002)

The examples described in this section illustrate that urine-diversion toilets are suited to virtually any country and are acceptable to various cultures and income groups, rich or poor, urban or rural, squatters as well as sitters. It is clear that simplicity is an inherent feature of the technology, and this brings monetary rewards in terms of reduced capital costs, as well as simplified operation and maintenance. Both householders and local authorities will thus benefit from implementation of the technology. Simplicity is also important for active participation of a community in the organising and building phases of a project.

Possibly the biggest advantage of urine-diversion toilets is that no pits are required and that they may be installed indoors. When properly operated, there is no smell and no fly breeding, the latter being an important community health aspect. Properly constructed, they are attractive to use and easy to keep clean, both critical factors which also benefit community health in low-income areas. In addition, although not a precondition for the implementation of these systems, re-use of the excreta resource is an additional benefit for people wishing to make use of it.

CHAPTER 3: DESIGN AND MANAGEMENT ASPECTS OF ECOSAN TOILETS

3.1 INTRODUCTION

Urine-diversion ecosan toilets require a higher level of commitment from users than do other forms of dry sanitation, such as VIP toilets. The reason is that they are more sensitive to, and consequently less tolerant of, abuse. In many of the poorer and under-serviced communities in South Africa, pit toilets are often used as rubbish depositories as well. The use of anal cleansing materials other than tissue paper, such as rags, plastic bags, newsprint, maize cobs and even stones, is also common, and these objects then end up in the pits. Furthermore, wastewater may occasionally be poured into the pits. If one considers the nature of a dry-box toilet, it becomes obvious that abuse of this nature can only lead to failure of the system. However, the need for a higher level of commitment should be seen in the light of the many benefits associated with ecosan toilets when compared to pit toilets (Austin and Duncker 2002).

Urine-diversion ecological sanitation systems are neither widely known nor well understood. They cannot be replicated without a clear understanding of how they function and how they can malfunction. They require more promotion, support, education and training than VIP toilets (Esrey et al 1998).

Probably the most unfamiliar aspect of ecosan toilets is that they require some handling, at household level, of the products. While some cultures do not mind handling human excreta (faecophilic cultures), others find it ritually polluting or abhorrent (faecophobic cultures). Most cultures are probably somewhere between these two extremes and Esrey et al (1998) maintain that when people see for themselves how a well-managed ecosan system works most of their reservations disappear.

A more important point about handling is that once ecological sanitation has gone to scale and hundreds or thousands of units are in use in a certain area, individual households no longer need to handle the products at all. At that scale the output from ecosan toilets can be collected, further processed and safely disposed of by neighbourhood collection centres with trained personnel (Esrey et al 1998).

The potential advantages of ecosan systems can only be realized as long as the system functions properly. There is, particularly with a new concept, the risk that those who plan, design and build do not fully understand the basic principles involved and how they relate to local conditions. This may lead to an inappropriate selection of options. With the right system in place, the most common reasons for failure are lack of participation from the user, lack of understanding of how the system works, defective materials or workmanship, and improper maintenance (Esrey et al 1998).

The following sections provide an overview of current methods and practices.

3.2 URINE MANAGEMENT (Esrey et al 1998)

A basic question when designing an ecosan system is whether to divert urine or to receive combined urine and faeces in a single receptacle. If the latter approach is used,

effective processing will require later separation of the urine from the faecal matter. There are three options: urine diversion, urine separation and combined processing.

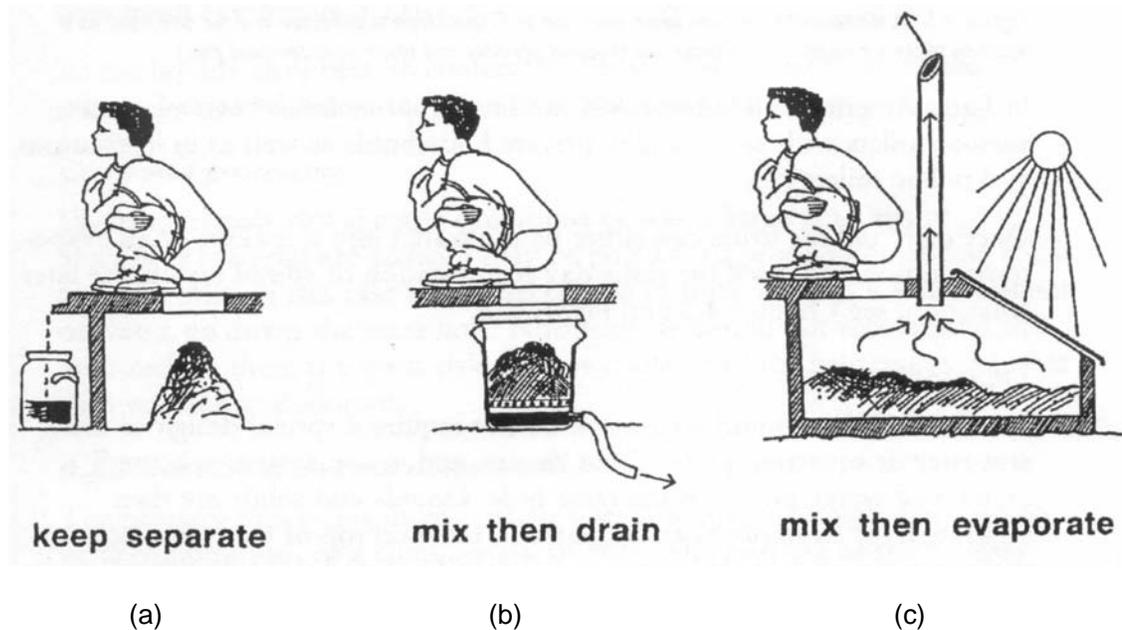

Figure 3.1: Three options for dealing with liquids in ecological sanitation systems (Esrey et al 1998)

3.2.1 Urine diversion (Figure 3.1 (a))

There are at least three good reasons for not mixing urine and faeces: it is easier to avoid excess moisture in the processing vault, the urine remains relatively free from pathogenic organisms, and the uncontaminated urine is an excellent fertiliser. However, urine diversion requires a specially designed pedestal or squat plate that is functionally reliable and socially acceptable. Once collected, the urine can either be infiltrated into a soakpit or an evapotranspiration bed, used for irrigation or stored on site for later collection.

3.2.2 Urine separation (Figure 3.1 (b))

Systems based on urine separation do not require a special design of pedestal or squat plate. Urine and faeces go down the same hole, after which the urine can be drained through a net or grille. As the urine has been in contact with faeces it must be sterilised or otherwise treated before it can be recycled as fertiliser.

3.2.3 Combined processing (Figure 3.1 (c))

Under extremely dry climatic conditions or where large amounts of absorbent material are added, it may be possible to process liquids and solids together. Also in this case, urine and faeces go down the same hole. With this system there is a risk that the contents of the processing vault become malodorous.

3.2.4 Disposal of collected urine

Various ways to dispose of the urine have been suggested, which also cater for people not interested in actively re-using it (Figure 3.2).

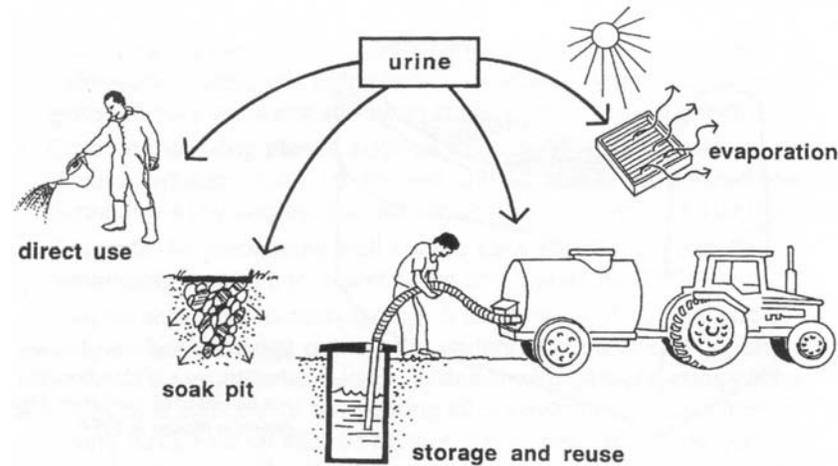

Figure 3.2: Alternative ways of handling/using urine diverted from toilets
(Esrey et al 1998)

3.2.5 Urine pipes and tanks

Jönsson (2002a) reported on a study made of blockages in urine pipes. The majority of the blockages were caused by precipitation of calcium and magnesium phosphates forming on hairs and fibres. However, these blockages could be easily cleared with a mechanical apparatus called a “snake,” or with caustic soda. The following recommendations were made concerning the design of urine pipes and tanks:

- (a) The pipes should be installed in such a way that it is possible to use a mechanical “snake” to clear them.
- (b) If a U-bend is installed, it should be easy to access and disassemble.
- (c) The system should contain no metal in contact with the urine.
- (d) Installations should be watertight.
- (e) Pipes should have a slope of at least 1% and a diameter of at least 75mm, because sludge continually precipitates from the urine. The sludge is easily flushed away, however.
- (f) It should be possible to inspect and clean the pipes.
- (g) The tanks should be filled from the bottom and have a manhole close to the incoming pipe.

3.3 FAECES MANAGEMENT

3.3.1 Dehydration versus composting

The primary processing in an ecosan system is either through dehydration or decomposition, or a combination of both. The purpose of primary processing is to destroy pathogenic organisms, to prevent nuisance and to facilitate subsequent transport, secondary processing and end use (Esrey et al 1998).

When something is dehydrated all the water is removed from it. In a *dehydrating toilet* the contents of the processing chamber are dried with the help of heat, ventilation and addition of dry material. The moisture content should be brought below 20%. At this level there is rapid pathogen destruction, no smell and no fly breeding. A requirement for dehydration is, except in very dry climates, the diversion and separate processing of urine (Winblad 1996b). The faeces chamber is solar-heated by means of a black-painted lid and small amounts of ash, sawdust or dry soil are added after each use. The faeces may be desiccated within a few weeks. The desiccation process, while not producing a material as rich as true compost, still acts to enrich soil to which it is added (Dudley 1996).

Composting is a biological process in which, under controlled conditions, various types of organisms break down organic substances to make a humus. In a *composting toilet*, human excreta are processed together with organic household residues. Optimal conditions for biological decomposition should be sought. This means that sufficient oxygen should be able to penetrate the compost heap to maintain aerobic conditions. The material should have a moisture content of 50-60% and the carbon:nitrogen balance (C:N ratio) should be within the range of 15:1 to 30:1 (Winblad 1996b).

In order to function correctly, a composting toilet requires the addition of carbonaceous (organic) matter to maintain the correct C:N ratio. Further, in order to get true composting, air must be able to reach all parts of the toilet contents. The need to turn and ventilate the heap is not just to allow oxygen to play its part in the chemical process, but also to facilitate evaporation in the depths of the heap. The most common problem with composting toilets is an excess of moisture, which slows or stops the aerobic decomposition process and leads to bad smells. On the other hand, when a desiccating toilet is well managed, the contents of the processing chamber can be reduced to an apparently innocuous state very rapidly (Dudley 1996).

3.3.2 Solar heaters

Solar heaters, in the form of a black-painted lid, can be fitted to the processing vaults in order to increase evaporation. This is more important in humid climates where urine is mixed with the faeces. It is also more important in a system based on dehydration than in one based on composting. The heater should be close-fitting so that it prevents water as well as flies from entering the processing chamber (Esrey et al 1998).

3.3.3 Single or double vault

The primary concern with a single-vault device is pathogens in fresh faeces. Although the amount of fresh faecal material at any one time is relatively small, this amount can contaminate a large pile. The management system adopted must ensure isolation of faeces until pathogens have been reduced to acceptable levels, and with single-vault toilets the faecal material is usually transferred to another pile/bin/container for further processing before being recycled. The benefits of a single-vault toilet are, however, that less space is required and construction costs are reduced (Esrey et al 1998).

An innovative method of preventing fresh faeces from contaminating an existing faecal pile was developed in Tecpan, El Salvador, which eliminates the need for opening the vault and using a rake or hoe to shift the pile away from its position beneath the pedestal. Each toilet unit incorporates a fixed “pusher” which is used to shift the faecal pile into the solar-heated processing chamber (Figure 3.3).

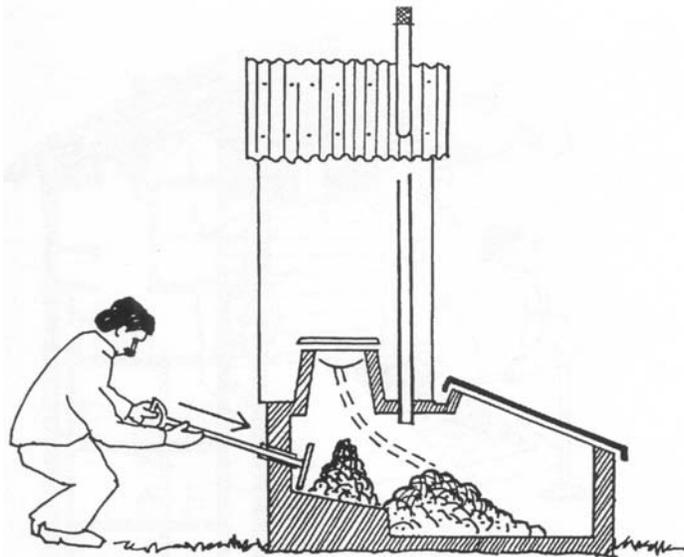

Figure 3.3: The “pusher” used to move the faecal pile, El Salvador
(Esrey et al 1998)

Many toilets have been designed with two vaults, each with its own pedestal or squatting slab. In these systems each vault is used alternately for a certain period. When the switch is made from one vault to the other, the contents of the vault that has been dormant are emptied, the assumption being that after several months without new faecal material being added, the contents should be safe to handle (Esrey et al 1998).

In single-vault systems, the faecal material needs to be collected in a way that facilitates storage and easy removal from the vault. It can be collected and stored in either of two ways - in a suitable container or in a heap on the floor of the vault. For the former method, two separate containers are required. When the first container is full, it is moved to one side and the second one moved into place beneath the pedestal. By the time the second

container is full (usually a few months, depending on the size of container and number of users) all the material in the first one should be sufficiently dehydrated to resemble a crumbly type of soil with a slight musty, not unpleasant, odour. It should then be removed from the container and stored in a sack for a further period, as there may still be vast numbers of viable pathogens present. A minimum total storage period of twelve months, from the time when the container is full to eventual use in the garden, is recommended (Austin and Duncker 2002).

The second method of collection and storage, in a heap on the floor of the vault, is recommended, although it involves a little bit of extra attention. A heap is not subject to the confines of a container, and the material is therefore able to “breathe”. This additional aeration induces a higher temperature that, in turn, leads to faster dehydration and better pathogen destruction. When the heap reaches a certain size, it should be raked to the side of the vault where it can dehydrate for a further period, until the space is needed to store further material. If possible, this heap should be turned over by spade or rake every fortnight or so – this action will further aerate the heap, with beneficial results. Further storage in a sack for a total storage period of twelve months is also recommended in this case. It is also essential that easy access to the vault be provided in order to facilitate the task as much as possible (Austin and Duncker 2002).

Due to the fact that storage time is an important factor in microbial inactivation, the size and orientation of the vaults are critical design aspects. Moe and Izurieta (2003) maintain that large, partitioned vaults with good solar exposure contribute significantly to pathogen destruction.

3.3.4 Disposal of anal cleansing material (Austin and Duncker 2002)

Various methods are practised for the disposal of anal cleansing material. It is usually recommended that these materials not be put into the vault, as the lack of moisture prevents their breakdown. A special container should be kept next to the toilet for storing used cleansing materials, which may then be periodically disposed of by burning or burial. Alternatively, where a well-operated solid waste removal service exists, the used materials can simply be enclosed in a suitable bag and disposed of in the rubbish container.

Where faecal material is re-used in the garden, some ecosan practitioners deposit toilet paper into the vault. When the faecal material is subsequently mixed in with garden soil and watered, the paper decomposes. It should be noted that only soft tissue paper can be used in this case, and the quantity may need to be restricted, depending on the size of garden and extent of re-use.

In very hot and dry climates (e.g. Northern Cape), where faeces dehydrate rapidly, people may simply deposit all cleaning paper into the vaults and periodically burn everything to ashes – paper as well as dehydrated faeces. Where reuse of the faecal products is not desired, this is a relatively easy way to dispose of the contents of the vault.

3.3.5 Absorbents and bulking agents (Esrey et al 1998)

Absorbents like ash, lime, sawdust, husks, crushed dry leaves, dry soil, etc, are used to reduce smells, absorb excess moisture, and make the pile less compact as well as less unsightly for the next user. They should be added immediately after defecation in order to cover the fresh faeces. Bulking agents like dry grass, twigs, wood shavings, etc, are also used to make the pile less compact and to allow air to enter and filter through the heap.

3.3.6 Ventilation and fly control (Austin and Duncker 2002)

Urine-diverting (dry-box) toilets function on a different principle to VIP toilets, and their operating requirements are therefore not the same. Whereas VIP toilets require specific arrangements to be made for fly control as well as ventilation of the pit and superstructure, dry-box toilets are much less of a problem. Pit toilets produce odour, due to the mixing of faeces and urine, which causes the pit contents to be wet, or at least damp, more or less permanently. In a well-operated dry-box toilet, however, the faeces are covered with ash or dry soil (or a mixture of the two), urine is diverted and moisture kept out of the vault as far as possible. The faeces therefore dehydrate rapidly, flies are not attracted, and odours are virtually, often completely, eliminated (efficiency of odour elimination depends to a large extent on proper use of the toilet). Therefore a different approach to building the toilet can be adopted.

The inside of the superstructure should be light and airy, not partially darkened as for a VIP toilet. Because there are no odours and flies are not attracted, proper windows may be provided, if desired by the owner. Should this be too expensive, or not preferred, sufficient small openings should be left in the walls to provide for light and ventilation.

A ventpipe may be provided, if desired, in order to encourage ventilation of the vault. This ventilation will then operate in a similar fashion to a VIP toilet; i.e. the air will move through the gap between the toilet pedestal and lid, through the pedestal and vault, and up the pipe. Practical experience in hot and temperate climates has shown that, as long as the toilet is operated correctly, there will be no odours or flies. Under these conditions, a ventpipe is not strictly necessary and may be dispensed with. However, its use is encouraged, as the process of pathogen destruction in the faecal material will be accelerated by the improved ventilation.

3.3.7 Disposal of vault contents

Various options are available for disposing of the contents of the vaults, which, as discussed above, may or may not contain anal cleansing material. While re-use for improving soil fertility is widely practised in a number of other countries (see Chapter 4: Agricultural utilisation of human excreta from ecosan toilets), this is not yet common in South Africa.

Two methods of dealing with the vault contents have thus far emerged in South Africa:

- (a) Burning. This has been successful in the dry Northern Cape, where hard cleaning paper is also used (Holden et al 2003). In some other parts of the country, however (for example Eastern Cape), people refuse to do this due to a belief that they will contract anal infections (Austin and Duncker 1999).
- (b) Composting or burying. This method was used from the outset in the Eastern Cape pilot project near Umtata. It is also common for the people to simply empty the contents of the containers into their fields, without consciously making an effort to mix it into the soil. The beneficial effect on the crops is evident, however (Austin and Duncker 1999). This practice also evolved in Namaqualand, where the people initially buried the faecal material, but in the course of time came to realize that a transformation had taken place and subsequently, after some encouragement, began to plant vegetables (Holden et al 2003). In eThekweni, villagers were informed from the beginning of the urine-diversion implementation process that the council regarded these systems as truly “on-site” and they were therefore expected to deal with the products themselves, on their properties (Harrison 2004).

According to Cordova (2001), the local government in León, Mexico, provides a free roadside pickup of “toilet products” twice a month. This action was decided upon due to the indiscriminate dumping by residents of bags of semi-processed faecal matter. Residents now place their bags on the kerb outside their homes, which are then collected by the garbage collection agency employed by the council, using a truck. The final destination of the bags is, however, not described.

A number of writings deal with various technologies and methods used for emptying on-site sanitation facilities such as pit toilets, bucket latrines, etc. (Gordon 1997; Gupta 1997; Kirango, Muller and Hemelaar 1997; Muller 1997; Rulin 1997; Still 2002; UWEP 1999). These publications describe neighbourhood-based systems such as MAPET (Dar es Salaam, Tanzania), VACUTUG (Nairobi, Kenya), MINIVAC (eThekweni, South Africa), animal-drawn carts (Yichang City, China and Bamako, Mali) and human scavengers (Ghaziabad, India), as well as conventional mechanised systems such as vacuum tankers. However, very few of these experiences can be considered as being applicable to emptying the vaults of urine-diversion dry-box toilets. The latter is a different process altogether, due to the nature of the biosolids and accessibility of the vaults. With a well-designed and correctly operated UD toilet, this should normally be a relatively simple manual task (Austin and Duncker 2002).

3.3.8 Sustainability aspects

As with any sanitation technology, the provision of urine-diversion toilets should be done in a manner that ensures sustainability. Holden (2001) poses the question about what is meant by sustainable sanitation delivery. He states that a sustainable service is generally understood as a system that is affordable to the community and the local authority as a whole over

the long term without having adverse effects on the environment. By affordable is meant that both the community and local authority are able to operate, maintain, extend and replace the infrastructure to ensure a reliable service, using the finance and skills available in the area. At the same time, the community must want and accept the level of service provided.

3.3.9 Possible future scenarios

Simpson-Hébert (2001) asserts that it is logical for the organic wastes from food produced in rural areas and consumed in cities to be returned to the rural areas to replenish soils. She argues that the sustainability of cities will rest upon a foundation of recycling all products, including excreta, in a systematic and healthy way, and that solid wastes should be dealt with at the place where they are created. She maintains further that city planners need to plan now for neighbourhood recycling stations, called “eco-stations”, where all wastes generated by communities can be recycled. The output of such eco-stations will be compost for urban and rural agriculture, with the objective of zero emissions and zero landfilling. Products of ecological toilets, the urine and sanitized faeces, could be collected house-to-house along with other household garbage and taken to the eco-station. Urine, which requires no further processing before collection, could be collected weekly. Dried faeces would be collected every six months, allowing time for complete desiccation and pathogen destruction. Urine, after minimal further processing, could be sold for fertiliser, while the dried faecal products could be further processed through composting with other organic products and then also sold for fertiliser and soil conditioner. There are many areas in and around cities where organic fertiliser and compost can be used, e.g. for urban and rural agriculture, parks and golf courses, mine site rehabilitation, reforestation, and for rejuvenation of waste areas such as old quarries and badly eroded land.

Simpson-Hébert (2001) goes on to say that eco-stations could be managed by municipalities, by user-cooperatives or by private enterprise. They could be labour intensive or highly mechanized. With an estimated 1 billion tons of domestic garbage and 300 million tons of human faeces being generated worldwide each year, there would be no shortage of materials. With one eco-station for every 20 000 people in urban areas, a considerable number of new jobs could be created. For the tens of thousands of people around the world already working informally as garbage pickers and recyclers, eco-stations could formalize this sector, provide safe working conditions, decent pay and job security, while giving dignity to people who would be providing an important public service. The author concludes that eco-stations could be the next step in ecological sanitation, and that they would contribute to urban sustainability.

Muller (1997) supports this viewpoint, saying that excreta collection should be an integral part of an urban waste management system, in which the collection and recycling of excreta and solid waste, as well as their final treatment and disposal, should take place in an environmentally sound and sustainable manner. She adds that excreta collection should not be an isolated activity, but rather a service that is integrated into the urban institutional system. A collection service could be operated by a combination

of different types of organizations, with small, informal enterprises taking care of the removal and first transfer of human excreta, while either the municipality or a private contractor provides the secondary transfer and disposal service. A neighbourhood transfer point, from where a secondary service transports the collected excreta to another site for treatment (e.g. as in Ghaziabad and Accra), provides a concrete example of the technical and operational interlinkages between the municipal sanitation department and private actors.

3.4 DIMENSIONS, METHODS AND MATERIALS

The illustrations in Chapter 2 of this literature review are evidence of the wide range of materials, methods and styles that can be employed in the building of ecosan toilets. It is seen that any suitable materials, including brick, stone, wood, thatch, corrugated iron, wattle and daub, gum poles, rammed earth blocks, precast concrete, ferrocement, etc. can be used for the superstructure, while seating arrangements may be plastic, concrete, porcelain or wood. Toilets may even be installed indoors, as part of a house. Austin and Duncker (2002) comment that as long as the basic principles governing urine-diversion sanitation are adhered to, the appearance and cost of the toilet units are matters of individual preference.

Building materials should meet the criteria of strength, durability and weather resistance, and have good thermal properties. Preference should, moreover, be given to locally available or traditional materials and methods, in order to encourage poorer communities to take part in self-help building schemes. Innovation is encouraged: for example, making a simple urinal from an old 5-litre plastic container or, alternatively, from a small, hand-moulded clay or ferrocement pot (Austin and Duncker 2002). Some examples are shown in Figure 3.4.

Information on dimensions is sparse. However, from a study of existing toilets in South Africa and elsewhere, it appears that the norm is to adopt the same practice as for building a VIP toilet. Internal superstructure dimensions are therefore typically 850 mm to 1 000 mm wide and 900 mm to 1 200 mm long for both single and double vault toilets. Vaults are usually 600 mm to 800 mm deep. Austin and Duncker (2002), however, state that the internal floor area should provide space for an ash/soil container, a container for used anal cleaning material if desired, and possibly also a urinal; minimum dimensions of 1 150 mm by 1 150 mm are therefore recommended.

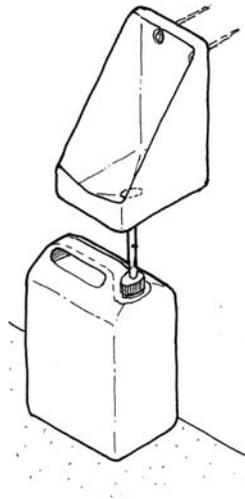

(a)

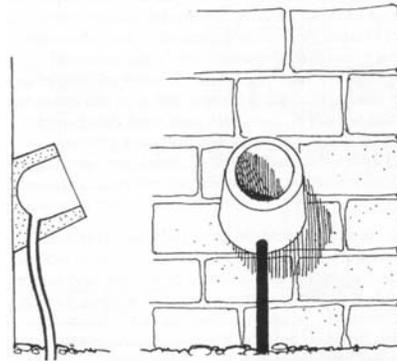

(b)

Figure 3.4: Examples of simple, easily made urinals.
(a) Using a 5 litre container and (b) using a clay or ferrocement pot
 (a) Austin and Duncker 2002; (b) Esrey et al 1998

Provision for small children is sometimes made, as they often have difficulty in defecating in the right place and consequently soil the urine bowl instead. A common adaptation to the urine-diversion pedestal in Sweden is a wooden “kiddie-seat” (Figure 3.5 (a)), while in South Africa a plastic version is available (Figure 3.5 (b)).



(a)



(b)

Figure 3.5: “Kiddie-seat” adaptations for urine-diversion pedestals.
(a) Swedish version (wood) and (b) South African version (plastic).
 (Photographs: CSIR)

3.5 CONCLUSIONS

Human excreta are usually easier to handle when urine and faeces are kept separate, as in urine-diversion toilets. It is accepted that such toilets are more sensitive to abuse than, for instance, VIP toilets, and therefore require a higher level of commitment from users. They also require a higher level of social intervention in the form of promotion, support, education and training. The many benefits associated with ecosan toilets can only be realized if the systems function properly.

As long as the basic principles of this particular sanitation technology are adhered to, the materials used, appearance and cost of the toilets are matters of individual preference. Various types of building materials may be used, and many innovative concepts are in evidence around the world.

The primary processing in an ecosan toilet may operate on either a dehydrating or composting principle, or a combination of both. Depending on which option is used, urine may be diverted and kept separate from the faeces, mixed with the faeces and drained, or mixed and evaporated. Urine may also be disposed of by using it as a fertiliser or, alternatively, draining it to a shallow soakpit.

Management of faeces is a much more critical issue. Various methods are in use for treatment and storage; these include fitting vault covers that act as solar heaters, keeping fresh and old faeces separate by moving the piles around inside the vaults, using double-vault toilets, ensuring good ventilation, and covering the faeces with bulking agents such as ash, soil, lime, sawdust, etc. Storage time is an important factor in the pathogen reduction process, and faeces management processes should aim to maximise this aspect.

Final disposal of faecal material allows various options. Re-use as a soil conditioner for food gardens, as well as in wider agricultural applications, is practised in many countries. Where communities are not disposed towards this custom, faeces (and anal cleansing materials) may simply be buried or burned. The level of local government involvement in excreta disposal is an important issue, and may impact significantly on the sustainability of ecosan projects.

The vision of community eco-stations for recycling of urban waste has been raised. This concept requires strategic input at the highest level of municipal management, as any system of excreta collection will require integration with the whole urban waste management system. However, such a concept, if successfully implemented, could enhance urban sustainability, create numerous jobs and formalise a large sector of poor people currently engaged in informal subsistence activities related to solid and organic wastes.

CHAPTER 4: PEOPLE, PERCEPTIONS AND PRACTICES

4.1 INTRODUCTION

This section of the literature review focuses on various socially oriented aspects of urine diversion sanitation systems implemented in various parts of the world, urban and rural, in both developed and developing countries.

The sanitation policy of the South African government stresses that sanitation is not simply a matter of providing toilets, but rather an integrated approach that encompasses institutional and organisational frameworks as well as financial, technical, environmental, social and educational considerations (DWAF 1996).

The White Paper on Basic Household Sanitation (DWAF 2001) is based on a set of principles where sanitation is about being a human right and about environment and health. Sanitation improvement must be demand-responsive and supported by an intensive health and hygiene programme. The programme should ensure community participation as well as integrated planning and development. The programme should also ensure co-operative governance while at the same time promoting delivery at local government level. Services provided should be affordable and sustainable for the households as well as for local government.

“Sanitation” refers to the principles and practices relating to the collection, removal or disposal of human excreta, household wastewater and refuse as they impact upon people and the environment. Sanitation is any system that promotes sanitary, or healthy, living conditions. It includes systems to manage wastewater, stormwater, solid waste and household refuse and it also includes ensuring that people have safe drinking water and enough water for washing (DWAF 2002). The focus here is on the safe management of human excreta. The basic purpose of any sanitation system is to contain human excreta (chiefly faeces) and prevent the spread of infectious diseases, while avoiding danger to the environment (Austin and Duncker 2002).

Sanitation includes both the “software” (understanding why health problems exist and what steps people can take to address these problems) and “hardware” (toilets, sewers and hand-washing facilities). Together, they combine to break the cycle of diseases that spread when human excreta are not properly managed (DWAF 2002).

Ecological sanitation is a sanitation system that turns human excreta into something useful and valuable, with minimum risk of environmental pollution and no threat to human health. It is a sustainable closed-loop system that treats human excreta as a resource, not as a waste product. Excreta are processed until they are free of disease organisms. The nutrients contained in the excreta may be recycled and used for agricultural purposes (Austin and Duncker 2002).

Urine-diversion sanitation technology has been used successfully for decades in many developing countries such as Vietnam, China, Mexico, El Salvador, Ecuador, Guatemala, Ethiopia and Zimbabwe, and, since 1997, also in South Africa. This type of sanitation system is suggested as an additional means of combating the health and environmental problems caused by inadequate sanitation in many areas (Austin and Van Vuuren 2001).

As a policy requirement, sanitation should be an integrated approach that encompasses various components, including the social component, i.e. community participation (DWAF 2001).

The most commonly used sanitation technologies in the world are waterborne sewerage (flushing toilets) and pit (VIP) toilets. According to Austin and Duncker (2002), however, various problems are associated with these technologies. VIP toilets are basically a sound technology, but their image has been dented through deficient implementation practices. The result has often been a legacy of poorly planned and inadequately maintained systems provided by well-intentioned but shortsighted authorities and developers, with very little attention being given to factors such as environmental impact, social issues, water-supply levels, reliability, upgradability, settlement patterns or institutional capacity. Both waterborne and VIP systems have often been the cause of faecal and other pollution in ecosystems (Simpson-Hébert 1997; DWAF 1999; WRC 1993).

Ecological sanitation (ecosan) is practised in various parts of the world, including South Africa, as an alternative to the two technologies mentioned above. Ecosan is based on an ecosystems approach. Duque (2002) outlined the advantages or benefits of this sanitation system as follows:

- It addresses households and requires community involvement; and
- it serves to improve the family diet and its economy, as well as the self-esteem of its members.

4.2 A GLOBAL OVERVIEW OF URINE-DIVERSION PROJECTS

This section focuses on the processes followed by various countries in the implementation of urine-diversion sanitation projects. These phases are:

- Planning;
- marketing;
- design;
- health and hygiene awareness and education;
- operation and maintenance;
- re-use of human excreta; and
- monitoring and evaluation.

4.2.1 Planning

Many failures of urine-diversion sanitation projects have occurred as a result of exclusion of the community from the implementation process (from the onset until completion). This has been the case in several countries. Some reasons for failure of the ecological sanitation toilets include (Esrey et al 1998):

- Lack of participation from the user;
- lack of understanding of how the system works;
- defective materials and workmanship; and
- improper maintenance.

Although guidelines for ecosan project planners, professionals and field workers are being discussed, there is presently no training manual on awareness-raising for community workers and no toolbox for ecosan implementation (Source 2003).

South Africa

During the planning phase of the project, the following factors need to be taken into consideration in order to ensure sustainability (Austin and Duncker 1999):

- Involvement and consultation is the first step towards full participation and empowerment of the community. During this stage, the developer or agency implementing the project should workshop the concept with the community;
- the technical aspects should be discussed to facilitate an understanding of the operation and maintenance of the toilets;
- the concepts should be illustrated or demonstrated to the community;
- the process of the proposed project should be discussed in detail;
- questions should be answered and problem areas clarified;
- cultural taboos and beliefs that need to be addressed during the implementation of the projects should be brought to the attention of the project team;
- the community members should always be consulted regarding their opinion of the proposed project and their roles in it, as well as their interest in participating in the project;
- the community as one of the stakeholders (consumers/end users) must be part of the decision-making process;
- the proposed plan should be tabled and revised according to the needs and cultural beliefs of the community, as well as the needs and requirements of the developer and or sponsor;
- the community should decide on the beneficiaries of any experimental or demonstration toilets that will be constructed, as well as the construction starting time and location of such toilets;
- options regarding the design and/or building material should be discussed with the community; and
- the issue of continuous monitoring and evaluation (to ensure proper maintenance and use) should also be taken into consideration during project planning.

Mexico

In Mexico, which has been described as the “dry sanitation capital of the world” (Peasey 2000), several experiences have been recorded relating to the implementation of ecological sanitation programmes. Some negative experiences resulted from the implementation of technologies without prior work in the communities (Duque 2002). This is often the case with unilateral initiatives taken by local governments. To some extent, these initiatives are not connected to the expectations of the population and therefore rejected. As a result, many dry toilets are used for unintended purposes (sheds or small chicken coops).

On the other hand, Duque (2002) highlighted that the more positive experiences mostly coincided with preparatory work having been carried out with user populations, including demonstration sites in the communities that had already adopted these technologies; community diagnostic workshops with an emphasis on ecological considerations; and collective analysis of problems and possible solutions in which the advantages, disadvantages, viability and freedom to adopt the technology and its methods were discussed and decided upon by each household. Furthermore, he felt that local government units should give additional incentives or assistance in order to build dry toilets, install greywater filters and collectors to catch rainwater.

Zimbabwe

Guzha (nd) presents a case study on ecological sanitation alternatives in the water-scarce peri-urban settlements of Harare, using the people's approach. He highlighted that through participatory self-appraisal, health and hygiene promotion, community development committees were formed and tasked to manage the affairs of the settlements. Community mobilisation, empowerment and participation were crucial prerequisites in implementing successful community projects, particularly in informal peri-urban situations with diverse socio-political persuasions.

The main challenge here was the need to engage the beneficiaries (community participation) throughout the process in order to ensure sustainability of the project and acceptance of urine-diversion technology.

4.2.2 Marketing principles / promotion methods

The success and acceptance of a new technology, in every situation, lies in the marketing strategies used. These strategies should be customised to suit the needs of various communities. Much work needs to be carried out to change the mindset of beneficiaries. Peasey (2000) indicated that trial periods in a community, lasting several years, are necessary to demonstrate the advantages of dry sanitation.

South Africa

When introducing a new technology, especially something as personal as a new way of going to the toilet and the handling of faeces and urine, social and cultural considerations must be uppermost in one's mind (Holden and Austin 1999). Factors found to be important in South Africa include men's urinating method (i.e. standing up), the disposal of anal cleansing materials, and the disposal of urine and faeces.

It is recommended that the following promotional programmes be considered in order to motivate people to invest in urine-diversion toilets (Austin and Duncker 2002):

- The holding of special community meetings to discuss and encourage participation;

- the use of good examples to demonstrate acceptable toilets, e.g. by building these at the local school or at the homes of prominent people in the community;
- school programmes where children are taught about the importance of good sanitation; and
- holding other community-supported events involving drama and music where sanitation is promoted.

Local health officers and support organisations could be requested to help with the compilation and presentation of a suitable promotional programme.

From their experience in the South African sanitation programme, Holden, Terreblanche and Muller (2003) contend that the marketing of ecological sanitation is no different from any other kind of sanitation technology, and that people are motivated by reasons other than health to improve their sanitation arrangements, e.g. safety, security, comfort, privacy, convenience, lack of odour, etc. Householders do not primarily choose ecological sanitation in order to close the nutrient loop, but rather because it is the technology that best satisfies their aspirations and physical requirements. The authors state that, until the proponents of ecological sanitation understand this and let people make informed choices rather than insisting on aspects such as re-use of excreta, ecosan will “remain an interesting side-show rather than a mainstream solution in the quest for sustainable sanitation.” They maintain that the introduction of urine-diversion technology in South Africa has been successful due to its marketing around social factors rather than the benefits of nutrient recycling.

Urine-diversion toilets have also been successfully implemented as part of the bucket eradication programme, as the existing infrastructure is suited to this purpose (see Figure 2.16, Chapter 2). Where VIP toilets are not a viable option (e.g. in the hard or rocky ground areas of Northern Cape) urine-diversion systems have been adopted on a large scale (Mvula Trust, nd).

Mozambique

ESTAMOS, a local Mozambican NGO, embarked on two methods to promote ecological sanitation (Dos Santos and Breslin 2001):

- Implementing model ecological toilets in family homes; and
- using radio as a social marketing tool.

The idea behind the first method was to build some toilets at the homes of influential people within the community and also some in the homes of ordinary community members, in order to demonstrate that these types of toilets are a possibility for everyone. For example, two male chiefs and one female chief received toilets, while the other recipients were regular community members. This was to ensure that other community members would visit the toilets, learn about them and, in turn, create greater interest and demand.

In the second method, an interview of about 5 minutes was taped. The interview consisted of an explanation of the principles behind ecological sanitation, followed by a talk with a community member who had received

such a toilet, in order to hear what he/she felt about the toilet. There was also an open invitation for people to visit this toilet. The programme was run for two weeks during prime listening time. However, no results were recorded regarding the impact of the radio programme.

It was recommended that better community organisation should be in place to promote ecosan toilets, which may include community events and visits to people's homes.

Source (2003) reports that many Mozambicans are investing in alternative sanitation solutions, such as ecosan, even where they already have a conventional toilet, because of advantages such as less odour, fewer flies, simple handling, stability in the rainy season, fertilising benefits and prestige.

Mexico

Mexico was successful in creating RedSeco (Ecological Sanitation Network) together with other civic organisations, small business entrepreneurs, and research institutions to promote ecological sanitation. Workshops for regional promoters were held throughout the project rather than trying to cover all issues at the beginning. Promoters shared the problems and solutions as they arose. All workshops were held in a central location. There was a feeling that rotating the workshop site among the regions would probably have improved the educational process for promoters and families. Also, designating two local promoters to attend the workshops and share responsibilities would provide a better foundation for the project as a whole. Educational materials produced for (and during) the project were very helpful. These included posters for promotion and use, a construction manual, information sheets for trouble-shooting, explanatory brochures, and a promoter's kit consisting of these materials as well as ideas for conducting workshops (Clark 2001).

Owing to an increase in the demand for dry toilets in Mexico, César Añorve (an independent entrepreneur) and Espacio de Salud (ESAC, a small NGO concerned with promoting improved health and environmental conditions among low-income groups) decided to give the highest priority to the training of community workers. As a result of this focus, they have jointly developed and produced educational and training materials including an attractive, full colour poster showing a range of dry toilet models, as well as the basic technical design drawing. ESAC responds to the communities' demands through the use of participatory methods to assist them in analysing the cause of their problems and to identify possible solutions (WEDC nd).

The Water Supply and Sanitation Collaborative Council (WSSCC) Working Group on Sanitation emphasises the importance of sanitation promotion and hygiene education in their Sanitation Promotion Kit, and links the value of excreta with ecology (Simpson-Hébert and Wood 1998, as quoted by Peasey 2000).

Philippines

The information material developed during the first phase of the project in Tingloy, Philippines, was mainly targeted at conducting training on ecological sanitation. Materials that were disseminated for use and reference after the training included:

- A colour poster with recommendations on how to use and maintain a urine-diversion toilet; and
- a monitoring sheet on use and maintenance of urine-diverting toilets (performance).

Materials disseminated for use and reference after training were translated from the original versions found in two Spanish books (one for households and the other for facilitators monitoring the visits). Because these materials were directly translated and not adapted to the Philippine context and local situation of Tingloy, they were actually not appropriate, and were not always correctly understood. Later on, this was pointed out and explained to the partner families in household visits by the project team, and the materials were not distributed anymore (UWEP 2003).

The official handing over ceremony of the toilets to respective families stimulated and encouraged the families to start using them, as until then they had been somewhat hesitant to do so because they saw the toilet as the property of the Philippine Centre for Water and Sanitation – International Training Network Foundation (PCWS-ITNF). The official handover included reading and signing a letter (by the partner family representative, project team representative and respective rural sanitary inspector, handing out a certificate with user guidelines, and photographs (UWEP 2003).

China

When ecosan toilets were introduced in Guangxi province in 1998, most of them were built inside the dwellings. The developers were initially faced with the challenge of finding a family that would agree to have a demonstration toilet built inside their house, but the idea was pursued in order to encourage community “buy-in” into the project. If the demonstration units were built outside, then all other toilets would also have had to be built outside. This would have increased the cost (there are large cost savings associated with locating a toilet indoors), and would become less convenient to use by the family and consequently difficult to maintain. In this regard, demonstration played a major role in promoting the new technology (Jiang, 2001).

4.2.3 Design

When designing the toilets, it is of vital importance to take into account the needs and cultural beliefs raised by the communities during the planning phase (Austin and Duncker 1999). The design of ecosan toilets should be tailored to suit the needs of a particular community in order to enhance the sustainability of the project. There is a wide range of materials, methods and styles that can be used.

South Africa

Austin and Duncker (2002) encourage creativity and imagination in the design of toilets, as long as the basic principles governing urine-diversion sanitation are adhered to. The appearance and cost of toilet units should be based on individual preference. They suggested further that any suitable materials may be utilised, as long as they meet the criteria of strength, durability and weather resistance, and have good thermal properties. The use of locally available or traditional materials (and methods) should be given preference. This, in turn, will encourage poor communities to participate in self-help building schemes and enable them to maintain the toilets themselves.

An example of taking a community's cultural values into account is evidenced by the design of the toilet units in the South African pilot project near Umtata, Eastern Cape. During the community liaison process that preceded construction of the toilets, the issue of the disposal of used anal cleansing material was discussed. The people indicated that they wanted to put this material into a separate container, the contents of which would be buried periodically, because burning of the material would not be acceptable for cultural reasons. Space for a plastic bucket for storing the used cleaning material was therefore incorporated into the superstructure. Other options discussed and decided by the communities were the type of brick, colour of paint, type of faeces receptacle (wood, plastic, etc), the urinal and actual locations of the toilets (Austin and Duncker 1999).

Mexico

From the lessons learnt in Mexico for sustainable replication of the toilets, it was strongly recommended that various design options should be considered with the families, enabling them to weigh the advantages and disadvantages of different alternatives prior to implementation of the project. When families were allowed to design their own toilet (with minimal technical support), they tended to build a single-vault toilet, but after considering more options, their analysis led them to the shallow-pit "arbour-loo", with responsibility for building a permanent double-vault toilet in the future (Clark, 2001).

Mozambique

From the small survey carried out by ESTAMOS among twelve families who received fossa alterna toilets, three months after starting to use them, a concern was expressed that the pits were too shallow and would fill up quickly because of the large families. This raised the issue as to whether people would manage the systems properly (Dos Santos and Breslin 2001).

The reason for the shallow pit depths of these toilets therefore needed to be explained further, which was an indication that the principles and concepts of ecological sanitation had not been fully explained to the community. This could have been due to lack of information dissemination by the field workers and/or insufficient knowledge of ecological sanitation by the fieldworkers themselves. It was thought that people's concerns about shallow pit depths might also pass with time as they became accustomed to

the new systems and actually saw that the toilets did not fill as rapidly as they initially thought (Dos Santos and Breslin 2001).

Philippines

According to the UWEP 2003 report, the Tingloy ecological sanitation pilot project was implemented in the municipality of Tingloy, Maricaban Island, Batangas Province, under an Integrated Sustainable Waste Management (ISWM) programme. During the first phase of the project, the respective partner households and community representatives were insufficiently involved in the process of designing and constructing the toilets. Construction was not supervised carefully enough and proceeded in a too-rushed way. The construction method (ferrocement technique) and materials used (moulds, ferrocement) were also unknown in the project area. Thus, the outcome of this project phase was that the demonstration toilets constructed could not be used for their intended purpose, had several operational problems and were inconvenient to use.

Learning from the design errors in Phase 1, and based on information gathered during in-depth consultation with the partner families, the PCWS-ITNF developed a new design for urine-diversion toilets. The approach followed in the final stage of this pilot project was to:

- Include participatory involvement of all actors in the process of design, development and review;
- hold meetings with a community developer and technical designer together;
- approach the participating family (recipient of a toilet) as a project partner that has rights and duties;
- explore the island and surrounding areas for local industries, workshops, craftsmen and materials that could be utilised in the design, development and scaling-up of ecosan activities; and
- believe that the outcome of the design process should be a pleasant and affordable toilet facility that sends out an environmental, health and hygiene promotion message, and which is easily replicable and adaptable by other families.

This toilet design has potential for a self-replicating effect among neighbouring households, i.e. the toilets themselves are promoters for ecosan developments in Maricaban Island. The use of local materials and expertise is also encouraged in order for the design to become the product of the community.

4.2.4 Health and hygiene awareness and education

Apart from the well-known literature on health and hygiene aspects of sanitation provision in general, and dry sanitation technologies in particular, no references to these aspects with a specific focus on ecological sanitation could be found.

In South Africa, it is generally recognised that behaviour change can come before the construction of an adequate toilet facility. PHAST tools such as contamination routes assist in the addition of a simple hand-washing facility to a toilet, improvement in water management, safe disposal of children's faeces, etc. All these actions incrementally improve health, and each one on its own is easily achievable at household level (Holden 2004).

4.2.5 Operation and maintenance

Any toilet system needs basic maintenance. Keeping it clean, understanding what repairs and replacements will be needed, and understanding its weak points, are all essential factors (DWAF, 2002). Providing information on how to use and maintain a toilet system is an integral part of any sanitation improvement programme. Proper operation and maintenance of the toilets are crucial factors in the success of any sanitation scheme, and these should be duly considered during the planning and design processes. Urine-diversion ecosan toilets require a higher level of commitment from users than do other forms of dry sanitation such as VIP toilets. The reason is that they are more sensitive to, and therefore less tolerant of, abuse. However, the need for a higher level of commitment should be seen in the light of the many benefits associated with ecosan toilets when compared to pit toilets (Austin and Duncker 2002).

South Africa

During the planning phase of the pilot ecosan project in Eastern Cape, community meetings were held in each village. The technical aspects were discussed in order to facilitate an understanding of the operation and maintenance of the toilets. The community asked questions, and problem areas were clarified. Cultural taboos and beliefs, which needed to be addressed during the implementation of the project, were brought to the project team's attention. For example, it was considered unacceptable to burn the anal cleaning materials because of a belief that anal infection could result. During the construction phase, when the first five toilets in each village had been completed, a training session on operation and maintenance aspects was facilitated, during which the various operational aspects were again discussed (Austin and Duncker 1999).

Community-level operation and maintenance is the most efficient method of ensuring a self-sustaining project. Local people should be trained in simple procedures for maintenance of urine-diversion sanitation systems. A team could be established to service and repair damage to the toilets. The following should be kept in mind when selecting eligible people for this team (Austin and Duncker 2002):

- Level of education;
- knowledge of an official language;
- knowledge of local languages;
- relevant experience or skills;
- age and sex;
- good local standing; and
- permanence in the area.

The sanitation committee (elected by the community) should be responsible for supervision and remuneration of these persons, while the community should agree to the payment/contribution of an agreed nominal fee for repair of the systems (Austin and Duncker 2002).

It is of great importance for development agencies to collaborate closely with communities from project inception, through all stages of infrastructural development, to a period of care after completion of the project. Monthly or bi-monthly visits to the area should take place after completion of the project in order to assist beneficiaries in operating and maintaining their toilets. This will ensure proper use of the toilets and therefore also the success of the project (Austin and Duncker 2002).

Mozambique

In the study conducted in Lichinga and Mandiba towns (Niassa Province) the interviewers from ESTAMOS observed that some toilets had odour problems because people did not want to put in too much ash/soil, as they were worried about the shallow depths of the pits and that they would fill up quickly. However, adding enough soil and ash is an important aspect of ecological sanitation (Dos Santos and Breslin 2001).

China

The results of a project evaluation in China indicate that ecosan toilets, when properly operated, can destroy pathogenic organisms, prevent fly breeding, are odourless, do not contaminate the environment, save water, and make possible the recovery of urine and faeces as manure (Jiayi and Junqi 2001).

Mexico

The toilets and the superstructures from the second programme in Mexico were in a better state of repair than those from the first programme. This possibly encouraged householders to maintain the toilets properly, with the used toilet paper collected, and the toilet floor, basin and urine separator kept clean. Some problems, however, seemed universal (Peasey, 2000):

- The urine separator blocked from time to time, through incorrect use of the toilet or children putting toilet paper or stones down the tube;
- small children found it difficult to use the urine separating toilet seat correctly; and
- if the urine tube was buried (led into a soakpit), then when it rained, the soil became saturated and the urine was not absorbed into the ground.

However, Espacio de Salud (ESAC) reports that the government-sponsored dry toilet installations are not always well received. The reason for this is that they are usually constructed without the homeowner's request, and with inadequate, incorrect or complete absence of instructions regarding their proper use and maintenance. Steinfeld (1999) indicated that the toilets are best accepted, used and maintained when they are voluntarily adopted by

homeowners, who fully understand the systems and receive maintenance support from a local organization.

4.2.6 Re-use of human excreta

Dry sanitation with reuse is promoted as an appropriate technology for community settings without sewerage or plentiful water. It has been heralded as solving many of the problems encountered with other sanitation systems. These include fly breeding, smell, groundwater contamination, short pit life and pit collapse. It is also claimed that sufficient destruction of disease-causing organisms (pathogens) is achieved, which enables safe handling of compost (Peasey 2000). There are other benefits too, such as the energy savings in reduced commercial fertilizer production and transport thereof to/from the centres of production and use. A further advantage mentioned is that, unlike septic tanks and pit latrines, which very often are a significant source of mosquito breeding, composting and desiccating toilets do not provide sites for this (Calvert 2000).

The enthusiasm generated by this technology seems to have overshadowed the most important issue, i.e. whether the end products from dry sanitation toilets are safe to handle and use as soil conditioners and plant fertilisers in community settings (Peasey 2000).

It is also evident that cultural taboos and perceptions in many parts of the world will have to change before people will accept using their faeces and urine as fertiliser for food crops (Source 2003).

South Africa

The owners of ecosan toilets in the Eastern Cape pilot project were not keen to collect and re-use the urine. It was therefore arranged to lead it into soakpits instead, with the option of converting to collection at a later stage (Austin and Duncker 1999). Some of the villagers disposed of the desiccated faeces in the maize fields and healthier plants were obtained (Austin and Duncker 1999). If the excreted products can be productively used in agriculture, the technology will become even more attractive. In South Africa where many communities rely on subsistence agriculture, often in poor soils, this is an important aspect (Austin and Duncker 2002).

Mozambique

The possibilities for excreta re-use were studied in two small towns in Niassa Province. The promotion of ecological sanitation in the district makes sense, as the province is primarily an agricultural area and most people (both males and females) who participated in the study were farmers. Nine of the families interviewed stated that they would use the resulting compost in their fields in the future. Two of the families said they would not use the compost because it was a very new idea. Due to the novelty of ecosan for people in Niassa, it was felt that time was needed for them to change their attitudes. Follow-up work still needs to be done with families who are using the compost in order to ascertain their opinions. This information could then

be used to help change the attitudes of people who are not using the compost on their fields (Dos Santos and Breslin 2001).

Mexico

In response to rapid inflation, high unemployment and inadequate nutrition in Mexico City, Anadeges (a network of NGOs) developed a method of growing vegetables in containers using human urine as fertiliser. The project was launched in 1998 and more than 1 200 urban households currently participate (Esrey et al 1998).

4.2.7 Monitoring and evaluation

It is of paramount importance to monitor and evaluate the entire project process, both during and after implementation, and to suggest changes where deemed necessary. The need for evaluations became apparent after repeated project failures throughout developing countries (Austin and Duncker 2002). The aim of conducting evaluation is to assess whether the intended benefits of the project have been achieved or not. In broad terms, the following aspects should be monitored (DWAF, 2001):

- The involvement of communities, the promotion of health and hygiene awareness, and education;
- the impact of sanitation improvement programmes on the health of communities;
- compliance with the integrated environmental management approach, and environmental impacts of the sanitation systems;
- the allocation, application and management of funds; and
- construction of the sanitation facilities.

South Africa

From their experience in South Africa, Austin and Duncker (2002) support the above monitoring procedure, but feel that the following aspects should also be included:

- An assessment of the appropriateness of the technology used as well as overall performance of the sanitation project;
- a comparison of people's hygiene practices and habits after completion of the project with those observed prior to its implementation;
- an assessment of people's attitudes towards their sanitation systems;
- determining the impact of the community participation and involvement process in the project; and
- the provision of feedback to developers regarding their original planning assumptions, for the purpose of modifying future project designs, if necessary, and to enable successes to be repeated in other projects.

The community should be involved in the evaluation process because valuable data will be provided and general community participation encouraged. The evaluation should be done in two parts: while the project is in progress and throughout its construction period, and after the completion of the project.

Philippines

Monitoring problems were encountered during the follow-up of the Tingloy ecosan pilot project. The construction process was only partly supervised by PCWS-ITNF staff and monitored twice: the first time during actual construction of the first toilet units and again after construction of the units was complete. During these monitoring visits one of the project team members and household members were questioned on the process of the project, and the main findings of the monitoring visits were as follows (UWEP 2003):

- The respective household and community representatives were insufficiently involved in the process of designing and constructing the toilets;
- construction was not supervised carefully enough and proceeded in a too-rushed way;
- the toilet facilities constructed could not be used as dry ecological (urine-diverting) toilets, because of the technical errors in their design; and
- the toilet facilities constructed had several operational errors and were inconvenient to use.

As a result, PCWS-ITNF decided to conduct in-depth consultations with the respective households in order to establish what needed to be done to improve the facilities so that they could be classified as dry ecological (urine-diverting) toilets and be convenient to use.

Prior to the official handing-over ceremony, PCWS-ITNF visited the project's respective partner families each time they went to Tingloy. During these visits the toilet facilities were checked for correct use and maintenance, damages, problems etc. The families were invited to express their comments and suggestions. One of the partner families was hesitant to start using their toilet facility, despite the fact that everything was ready. When asked the reason for not using it, the family members indicated that they felt ashamed that a project team member (a young girl of Dutch nationality) came to inspect their toilet and excreta products. As that seemed to be a bottleneck in the project, measures were taken to overcome this – at the point of handing over the facilities to the partner families, it was agreed with the Rural Sanitary Inspectors that they would follow up the monitoring. In case of design problems, it was agreed that PCWS-ITNF would still assist during the remaining project time.

China

In order to guarantee the quality of ecosan toilets constructed in Guangxi province, core teams were trained to direct the villagers in the construction process and proper use of the toilets. There were core teams at both county

and village levels. The county level office coordinated all ecosan work, including monitoring the progress and quality of the construction work. Team members were drawn from the county government's departments of sanitation, construction, education and information, and also from the women's union (Jiang, 2001).

4.3 GENDER PERSPECTIVES (Hannan and Andersson 2001)

The contribution of ecological sanitation to empowerment, sustainable livelihoods, poverty reduction initiatives and decentralised management systems will be significantly enhanced if gender perspectives become an integral part of future developments. Gender perspectives on conventional sanitation systems have not been well established. It is difficult to generalise on this aspect in sanitation, given that women and men are not homogenous groups and gender relations are context-specific. There are, however, a number of gender aspects that influence how women, compared with men, are involved in and benefit from improvements to sanitation. Women's perceptions, needs and priorities in relation to sanitation can be quite different from men's. In East Africa, safety (particularly for children) and privacy were found to be the main concerns of women. What men want in relation to sanitation, however, has never been specifically assessed. Sanitation programmes, as with many other development programmes, have been built around assumptions on some sort of "gender-neutral" person who does not exist in reality. Men's interests, needs and priorities in relation to sanitation may well be as neglected as women's.

Attention to gender perspectives in sanitation programmes has often been limited to analysis of women's contributions relative to men's, and the impacts on women in terms of anticipated benefits, within the framework of the existing division of responsibilities. It has also been presumed that participation in sanitation programmes is automatically positive for women. The possible socio-economic costs involved, given the multitude of other responsibilities women have, are normally not considered.

Gender perspectives on ecological sanitation have not yet been specifically explored. Women are actively involved in food crop production and concerned about food security in many countries, and would be directly affected by increased access to soil nutrients provided through ecological sanitation and the concomitant potential for increasing food production. Given women's overall prime responsibility for the health and well being of families in many areas, it could also be assumed that women would support ecological sanitation on the basis of health gains. Furthermore, since women have the responsibility for tending the cooking fires, their involvement is also needed for ensuring a supply of ashes for use in the toilets.

The claims that ecosan approaches will lead to decentralised management systems that foster social cohesion and empowerment will only be realised if the questions of socio-economic equity are addressed. In particular, there is a need to give greater attention to gender perspectives in management and governance issues linked to ecological sanitation. Ecosan approaches can only be empowering if both women and men have the possibility of influencing the direction of, participate actively in the implementation of, and benefit from, these approaches. Men also need to be sensitised to the important contributions of women in the area of sanitation and encouraged to provide more support for their equitable involvement.

Integrating gender perspectives, or giving attention to both women and men, in ecological sanitation programmes is important for securing human rights and social justice. It is also critical for ensuring that the goals and objectives of ecological sanitation, particularly in relation to sustainable livelihoods and poverty reduction, are effectively achieved.

4.4 CONCLUSIONS

Support for ecological sanitation comes from many quarters, e.g. international agencies such as UNDP and UNICEF, donors such as Australia, Germany and Sweden, international NGOs such as CARE and WaterAid, and local and national NGOs.

Achieving ecological sanitation solutions requires a change in how people think about human excreta. In some societies, human excreta are considered a valuable resource, and the handling of excreta poses no problems. Many countries have accepted these sanitation systems, although much work remains to be done on promotion, to enable people to change their attitudes on issues such as re-use of excreta for agricultural purposes. Regarding the removal of faecal matter or emptying the vaults, other avenues should be explored, particularly in cases where the household members are not willing to do so.

Operation and maintenance are further aspects requiring attention. Communities will generally accept dry sanitation programmes when sufficient time and energy are committed by the project team. However, programmes should be adaptable to local conditions and should react to a need rather than impose ideas.

There are benefits to be gained from installing some toilets in the houses of important community members. Once neighbours and others in the community realise the benefits, then they will generally also be eager to adopt the technology.

Ongoing training of the sanitation committee, fieldworkers and community members in ecological sanitation principles and practices is necessary for the sustainability and success of ecosan projects. Further marketing or promotion strategies should be developed, and those that are available should be implemented for a longer period of time. Perseverance during training is required and it should be borne in mind that it is always difficult (or it takes time) to change people's attitudes about new methods or technologies.

Ongoing monitoring and evaluation of ecosan projects should be a priority, considering that the toilets represent a new system and need to be managed correctly if the goals of ecological sanitation are to be met. It is evident that there have been problems with, and lack of support for, this aspect of the ecosan process in various parts of the world. The problems are usually caused either by a lack of sufficient involvement of the community during this phase, or because the implementing agency conducts it only partially. Lack of monitoring and evaluation poses difficulties in measuring the success of the project or impact on the community.

Attention to gender aspects, in particular taking into account the specific requirements of both women and men in ecological sanitation projects, is considered to be crucial for attaining the objectives of social justice and sustainability.

It is evident that there is a strong need for the development of guidelines for the successful implementation of ecosan projects.

CHAPTER 5: AGRICULTURAL UTILISATION OF HUMAN EXCRETA FROM ECOSAN TOILETS

5.1 INTRODUCTION

In order to grow plants that supply our food, fertilisers such as nitrogen, phosphorus and potassium and about 25 other additional elements have to be supplied. Today, artificial fertilisers account for the largest share of these nutrients but, at the present rate of use, the available resources will be rapidly depleted. Use of excreta as fertiliser has been implemented only to a limited extent. Rather, they have been flushed out into the rivers, resulting in a lack of oxygen in the aquatic resources. These resources have also been polluted with pathogenic microorganisms to the extent that many large rivers have become virus infected more or less permanently. It is thus better to create a closed system, with no pollution from bacteria or viruses, where *human* fertilisers are harvested and used to feed the following year's crops (Wolgast 1993). Nutrients are removed from fields with the harvested crops; in sustainable agriculture, therefore, the amounts of nutrients removed from a field should be returned to it (Jönsson 1997). Today, there is mainly an outflow of nutrients from farms to society. For a sustainable society, Vinnerås (2002) maintains that it is necessary to recycle these excreta back to the farms.

Ecological sanitation regards human excreta as a resource to be recycled, rather than as a waste to be disposed of. Esrey et al (1998) maintain that the notion of excreta being merely waste with no useful purpose is a modern misconception, which is at the root of pollution problems resulting from conventional approaches to sanitation. According to them there is no waste in nature, and all the products of living things are used as raw materials by others. Recycling sanitised human urine and faeces by returning them to the soil serves to restore the natural cycle of life-building materials that has been disrupted by current sanitation practices.

Where crops are produced from soil, it is imperative that the organic residues resulting from these crops are returned to the soil from which the crops originated. This recycling of all residues should be axiomatic to sustainable agriculture (Gumbo, nd).

There are many reasons for recycling the nutrients in excreta. Recycling prevents direct pollution caused by sewage being discharged or seeping into water resources and ecosystems. A secondary benefit is that recycling returns nutrients to soils and plants, and reduces the need for chemical fertilisers. It restores good soil organisms to protect plants, and it is always available locally, wherever people live (Esrey et al 1998).

However, Schertenleib (2002) recognises that excreta contain both dangerous materials (pathogens in faeces) as well as beneficial components (nutrients in urine). He states that the challenge of modern sanitation practice is to find ways to:

- (a) contain the dangerous part of the excreta in order to prevent transmission of diseases;
- (b) use the beneficial part of the excreta productively; and
- (c) avoid damage to the natural environment.

5.2 HUMAN EXCRETA AS FERTILISERS

For adult persons who maintain approximately the same mass during their lifetimes, the excreted amounts of plant nutrients are about the same as the amount eaten. The excreted amounts of plant nutrients depend on the diet and thus differ between persons as well as between societies (Jönsson 1997; Jönsson and Vinnerås 2003). Vinnerås^a et al (2003), quoting Guyton (1992), note that the volume of faeces produced per person depends on the composition of the food consumed, with meat and other foods low in fibre producing smaller volumes than food high in fibre. Table 5.1 was developed in 1997, based on the average Swedish diet and circumstances.

Table 5.1: Estimated Swedish averages for mass and distribution of plant nutrient content in urine and faeces, expressed as percentages of total mass excreted (based on Jönsson 1997)

Parameter	Urine		Faeces		Total toilet waste	
	g/p.d	%	g/p.d	%	g/p.d	%
Wet mass	900 – 1200	90	70 - 140	10	970 - 1340	100
Dry mass	60	63	35	37	95	100
Nitrogen	11	88	1,5	12	12,5	100
Phosphorus	1,0	67	0,5	33	1,5	100
Potassium	2,5	71	1,0	29	3,5	100

Vinnerås^b et al (2003) have since revised these values (Table 5.2):

Table 5.2: Proposed new Swedish default values for urine and faeces (based on Vinnerås^b et al 2003).

Parameter	Urine g/p.d	Faeces g/p.d	Toilet paper g/p.d	Blackwater (urine + faeces) g/p.d
Wet mass	1 500	140	24	1670
Dry mass	58	30	23	111
Nitrogen	11	1,5	-	12,5
Phosphorus	1,0	0,5	-	1,5
Potassium	2,7	1,0	-	3,7

Based on Tables 5.1 and 5.2 above, it is estimated that roughly 65 to 90% of the excreted nitrogen, phosphorus and potassium are to be found in the urine. Furthermore, plant nutrients excreted in urine are found in chemical compounds that are easily accessible for plants. Initially 80 to 90% of the nitrogen is found as urea, which rapidly degrades to ammonium and carbon dioxide as follows (Jönsson 1997):

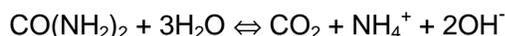

The urea degradation increases the pH value of the urine from its normally slightly acidic state (pH 6 when excreted) to a value of approximately 9. The phosphorus in the urine is in the form of phosphate, while the potassium is in the form of ions. Many chemical fertilisers contain, or dissolve to, nitrogen in the form of ammonium, phosphorus in the form of phosphate and potassium in the form of ions. Thus, the fertilising effect of urine ought to be comparable to the application of the same amount of plant nutrients in the form of chemical fertilisers (Jönsson 1997). According to Johansson et al (2000), the effect of human urine applied to a spring crop in Sweden corresponded to 80-90% of the effect with the same amount of nitrogen in the form of mineral fertiliser. Vinnerås (2002), quoting Kirchmann and Pettersson (1995), Elmqvist et al (1998) and Johansson et al (2000), notes that field trials and pot experiments have shown diverted human urine to be comparable to mineral fertilisers. It was found that for nitrogen, the fertilising effect is equal to, or just a little bit poorer than, mineral fertilisers, while for phosphorus, the fertilising effect is equal to, or just a little bit better than, mineral fertilisers.

The faeces contain undigested fractions of food with plant nutrients. However, organically bound plant nutrients are not plant available. The undigested food residuals have to be degraded before their plant nutrients become available, therefore the plant availability of the nutrients in faeces is expected to be slower than the plant availability of the nutrients in urine (Jönsson 1997).

Drangert (1996) estimates that the amount of human-derived nutrients from two persons is sufficient to produce food for at least one person. According to Wolgast (1993) the fertilisers excreted by one person are sufficient to grow 230 kg of cereal each year, as illustrated in Table 5.3. The table is based on an average human production of 500 litres of urine and 50 litres of faeces per year.

Table 5.3: Annual excretion of fertiliser by humans, compared with the fertiliser requirement of cereal (Wolgast 1993)

Fertiliser	500 litres urine	50 litres faeces	Total	Fertiliser need for 230 kg cereal
Nitrogen (N)	5,6 kg	0,09 kg	5,7 kg	5,6 kg
Phosphorus (P)	0,4 kg	0,19 kg	0,6 kg	0,7 kg
Potassium (K)	1,0 kg	0,17 kg	1,2 kg	1,2 kg
Total N+P+K	7,0 kg (94 %)	0,45 kg (6 %)	7,5 kg (100 %)	7,5 kg

As described above, Vinnerås^b et al (2003) have since revised the values of the fertiliser contents in urine and faeces. In order to enable a direct comparison with Table 5.3, these revised values are given in Table 5.4.

Human urine is seen to be the largest contributor of nutrients to household wastewater. If no phosphate detergents are used, at least 60% of the phosphorus and 80% of the nitrogen in household wastewater comes from urine. The total quantities of nutrients in human urine are significant when compared with the quantities of nutrients in the mineral fertilisers used in agriculture. For example, it is estimated that in Sweden the total yearly production of human urine contains nitrogen, phosphorus and potassium

equivalent to 15 to 20% of the amounts of these nutrients used as mineral fertilisers in 1993. Thus, by separating human urine at source, the amounts of nutrients recycled to arable land can be significantly increased while at the same time the nutrient load of wastewater can be significantly decreased (Jönsson 1997).

Table 5.4: Annual excretion of fertiliser by humans (based on Vinnerås^b et al 2003).

Fertiliser	550 kg urine	51 kg faeces	Total
Nitrogen (N)	4,0 kg	0,6 kg	4,6 kg
Phosphorus (P)	0,4 kg	0,2 kg	0,6 kg
Potassium (K)	1,0 kg	0,4 kg	1,4 kg
Total N+P+K	5,4 kg (82 %)	1,2 kg (18 %)	6,6 kg (100 %)

The fertilising effect of urine is similar to that of a nitrogen-rich chemical fertiliser, and should be used similarly. It is therefore best used on nitrogen-demanding crops and vegetables. As a rule of thumb, a concentration of 3-7 grams of nitrogen per litre of undiluted urine can be expected (Vinnerås^a et al 2003).

The fertilising effect of source-separated urine has been tested in some experiments in Sweden and appears to be almost as good as that of the corresponding amount of chemical fertiliser, provided that ammonia emission from the urine is restricted. The uptake of urine nitrogen by barley harvested at flowering stage was found to be 42% and 22% at two application rates, while the uptake of ammonium nitrate-nitrogen at the same application rates was 53% and 28% respectively. The lower uptake of urine nitrogen has been explained by higher gaseous losses of nitrogen (i.e. ammonia) from urine than from ammonium nitrate. The utilisation of urine phosphorus, however, was found to be 28% better than that of chemical fertiliser. The barley fertilised with urine derived 12,2% of the phosphorus, while that fertilised with dipotassium hydrogen-phosphate derived only 9,1% from the fertiliser. In a field experiment, the nitrogen effect of stored urine on oats was compared to that of ammonium nitrate fertiliser at three different application rates. The human urine, which was surface-spread and immediately harrowed into the ground, gave approximately the same yield as the corresponding amount of chemical fertiliser (Jönsson 1997).

Using the recycled toilet products as fertilisers will therefore save chemical fertilisers containing almost the same amount of nutrients and thus also the resources needed to produce and distribute them (Jönsson 1997). According to Vinnerås (2002), the largest single energy requirement in the conventional production of rapeseed in Sweden is the manufacture of the mineral nitrogen fertiliser used.

Jönsson (2002b) also notes that reduction of the amount of urine, and therefore the nitrogen load, in sewage, reduces the electrical energy requirements of a wastewater treatment plant by up to 36% due to the fact that less aeration is needed. He estimated further that the energy break-even transport distance for urine was approximately 95 km with a truck or 221 km with a truck and trailer. There will also be correspondingly less nutrient emissions from the plant. He states that, if all urine is diverted, the nitrogen emissions will probably decrease by 80-85% and the phosphorus emissions by 50%.

A further advantage of using human urine instead of chemical fertilisers or sewage sludge is the very low concentrations of heavy metals found in urine (Jönsson 1997). This viewpoint is supported by Hanaeus et al (1997), who state that the quality of sewage sludge is not fully trusted by agriculturalists due to the risk of hazardous compounds being present. Cadmium, for example, bio-accumulates in the food chain. According to Höglund et al (1998), human urine in Sweden contains less than 3,6 mg Cd/kg P, while commercial chemical fertilisers contain approximately 26 mg Cd/kg P. Furthermore, the sludge from the 25 largest sewage plants in Sweden was found in 1993 to contain an average of 55 mg Cd/kg P.

Vinnerås (2002) states that urine and faeces contribute only very small amounts of heavy metals to sewage, as most of these contaminants originate from greywater and other sources. This is illustrated in Table 5.5.

Table 5.5: Amounts of heavy metals, in mg per person per year, found in various recyclable nutrients (based on Vinnerås 2002).

Source	Cu	Cr	Ni	Zn	Pb	Cd	Hg
Blackwater	440	11	30	3 900	8,0	4,0	3,6
Urine	37	3,7	2,6	16	0,73	0,25	0,3
Sewage	12 000	1 400	2 100	22 000	1 600	56	36

Plant nutrients can be divided into two categories, namely macronutrients and micronutrients. The total uptake of macronutrients is approximately 100 times that of micronutrients. The macronutrients are the elements nitrogen (N), phosphorus (P), potassium (K), sulphur (S), calcium (Ca) and magnesium (Mg). Of these, yearly additions are usually needed of the first four (N, P, K, S), while the soil supply of Ca and Mg is usually sufficient provided the pH is not too low. All over the world, nitrogen is frequently the most limiting nutrient for plant growth (Vinnerås^a et al 2003).

The micronutrients found in urine are also essential for plant growth, but the uptake of these elements is in small (micro) amounts. The elements normally considered to be micronutrients are boron, copper, iron, chloride, manganese, molybdenum and zinc (Vinnerås^a et al 2003, quoting Frausto da Silva and Williams 1997). These nutrients come mainly from the degradation of organic material and erosion of soil particles. Only in special circumstances does scarcity of micronutrients limit plant growth. When human excreta are used as a fertiliser, the risk of such deficiency is minimal as excreta contain all the micronutrients required.

Although desiccated faeces contain fewer nutrients than urine, they are a valuable soil conditioner. They may be applied to the soil to increase the organic matter content, improve water-holding capacity and increase the availability of nutrients. Humus from the decomposition process also helps to maintain a healthy population of beneficial soil organisms that actually protect plants from soil-borne diseases (Esrey et al 1998). Vinnerås^a et al (2003) argue that the main contribution from the faecal matter is the phosphorus and potassium content and the increase in buffering capacity in areas where soil pH is low.

5.3 SOME PRACTICAL EXAMPLES OF AGRICULTURAL UTILISATION OF HUMAN EXCRETA

5.3.1 Japan

This country introduced the practice of reusing human excreta for agriculture in the 12th century, which lasted until the middle of the 19th century. Farmers purchased urine and faeces from people in the urban areas and, due to the country's closed policy, typhoid, cholera and other communicable diseases were virtually unknown. Farmers also used to place buckets at street corners in the towns and villages, collecting free urine from pedestrians and providing a simple public toilet at the same time (Matsui 1997).

5.3.2 China

In China, farmers have commonly used nightsoil, often untreated, to grow food. In Guangxi province, however, double-vault urine-diversion toilets have gained popularity recently, and over 30 000 toilets have been built in densely populated rural and urban areas. Rooftop gardening uses only urine to grow vegetables, such as cabbages, beans, pumpkins and tomatoes. In the fields, both urine and faeces are used to grow corn, rice and bamboo (Esrey and Andersson 2001).

5.3.3 India

In a pilot project in Kerala, urine is diverted into a growing area attached to the back of the toilet, where bitter gourds are grown. The project has met with success and there is a demand for more toilets to be built (Esrey and Andersson 2001).

5.3.4 Guatemala

In Guatemala, deforestation and erosion are serious problems throughout the highland areas. This is the result of the high population density in these zones, together with inequitable land distribution and the use of the more gently sloping and flatter lands for the cultivation of cash crops, thereby forcing the subsistence crops to be cultivated on steep slopes. To counteract this situation of increased soil loss, the use of human faecal matter as soil conditioner by subsistence farmers is of particular value. While it is recognised that this practice may not solve the area-wide problems of deforestation and soil erosion, it is regarded as an appropriate and low-cost method for improving the fertility and productivity of the soil of the individual farming family and for the country as a whole. The farmers are aware that the application of chemical fertilisers to the fields without replenishing the organic fraction leads to an impoverishment of the soil (Strauss and Blumenthal 1990).

Double-vault urine-diverting toilets were introduced here because they were regarded as the most suitable technology for the people of the area. Ash, or a mixture of ash and soil or of lime and soil, is added after defecation. This, together with the separation of urine, renders the faecal material alkaline, with a pH of around 9. This enhances pathogen die-off. The mixture of

decomposed, humus-like material of faecal origin and ash, called “abono”, is dried in the sun and then stored in bags upon removal from the vault until the farmer uses it in his fields at the time of tilling. The potassium levels of the “abono” are much higher than ordinary excreta due to the addition of ash, which is very rich in potassium. On average, the application rate of “abono” amounts to the equivalent of about 2 500 to 3 000 kg/ha for each plant cycle. With the average “abono” production rate of about 425 kg per year per family, the family’s fertilising potential for maize crops is approximately 1 900 m² on the basis of the phosphorus content of the “abono” and 2 580 m² on the basis of potassium, but only about 123 m² on the basis of the nitrogen content. The fertiliser from these toilets is therefore complemented by the collected urine, or else nitrogen-fixing crops such as legumes are planted in rotation with other crops (Strauss and Blumenthal 1990).

5.3.5 Zimbabwe

A unique tree-planting method that is combined with a composting toilet, called the *arborloo*, is used in Zimbabwe. A small hole suitable for planting a tree is dug; the size is approximately 600 x 600 x 600 mm, thus forming a shallow pit for a toilet. A lightweight, removable slab is placed over the hole and a simple toilet structure, which is also easily movable, is erected above it. The unit is fitted with a conventional pedestal or squat plate. The shallow pit fills up relatively quickly with faeces, which are covered with ash or soil. As soon as the hole is full, the superstructure is moved to another similar hole, while the first hole is topped up with soil and a fruit tree planted in it. In this way, whole orchards of productive fruit trees are grown. The most commonly planted trees are avocados, paw-paws, mulberries, mangoes and guavas (Morgan 1999).

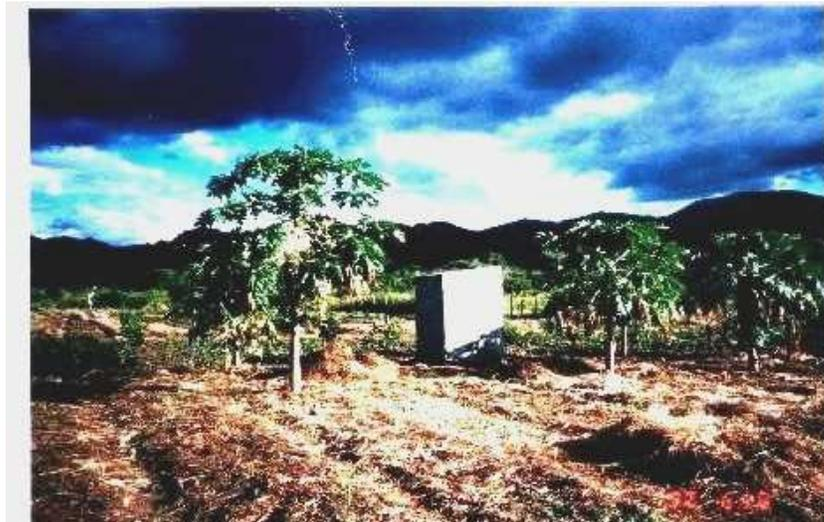

Figure 5.1: Arborloo in a paw-paw plantation or “sanitary orchard”.
(Morgan 1999)

5.3.6 Ethiopia

A popular practice here is FAITH gardening (**F**ood **A**lways **I**n **T**he **H**ome). The concept is based on a vegetable garden divided into sections that are planted in rotation, at intervals of a few weeks. Thus, while some patches are producing food, others have seed still germinating. In this way there is a constant supply of available food. The vegetable patches are well composted with “human manure” and any other suitable organic material, such as garden refuse. Urine is also used as a liquid fertiliser. Excellent results are obtained (Edström 1999).



Figure 5.2: Gunder Edström of SUDEA demonstrating this FAITH garden in Addis Ababa, Ethiopia.

(Photograph: CSIR)

5.3.7 Sweden

Sweden is probably the country with the most advanced system of collection and re-use of human urine, where it is practised by farmers on a large, mechanised scale. There are a number of settlements (called “eco-villages”) or apartment blocks in the country where the residents have ecological sanitation systems with urine-diversion toilets. The urine from all the houses or apartments is collected in large underground tanks, and what the residents do not use themselves is collected by farmers in road tankers and used for fertilising their crops. The usual practice is to spray it onto the lands while they are being prepared for planting, and then harrow it into the soil before sowing the seed.

5.4 SMALL-SCALE CROP EXPERIMENTATION IN ZIMBABWE

Morgan (2003) describes a number of experiments utilising human urine and faeces as fertilising agents for various food crops in Harare, in which he compared growth of the plants in the local poor quality sandy topsoil with that in humus from urine-diverting toilets (a mixture of faeces, soil and wood ash). An analysis of the two growing media is shown in Table 5.6, which illustrates the value of the faecal material from a UD toilet.

Table 5.6: Analysis of humus (faeces, soil and wood ash) from urine-diverting toilets (Morgan 2003).

Soil source	pH	N	P	K	Ca	Mg
UD toilet	6,72	232	297	3,06	32,22	12,06
Local topsoil	5,50	38	44	0,49	8,05	3,58

Note: N and P are expressed as ppm, and K, Ca and Mg as meq/100g

Various trials were performed on a variety of vegetables using urine diluted with water at a ratio of three parts water to one of urine as a liquid feed. Seedlings were planted in containers and irrigated with plain water for a period of one to four weeks to allow them to stabilise in their new environment (young seedlings do not react well to a urine mixture). Thereafter the 3:1 water/urine mix was applied three times per week, interspersed with regular watering at other times in order to keep the plants turgid and healthy. For the maize trials the urine was diluted in the range 3:1, 5:1 and 10:1 with water. The plants were fed with this mixture once per week and also watered regularly at other times.

After a certain growing period the crop was harvested and weighed. Some of the results are illustrated in Table 5.7 and Figures 5.3 to 5.6.

Table 5.7: Plant trials for various vegetables, tomatoes and maize (based on Morgan 2003).

Plant	Urine : water application	Duration of growth	Yield
Lettuce	Water only	30 days	230 g
Lettuce	3:1 urine, 0,5 litres x 3 per week	30 days	500 g (2 fold increase)
Spinach	Water only	30 days	52 g
Spinach	3:1 urine, 0,5 litres x 3 per week	30 days	350 g (6 fold increase)
Covo	Water only	8 weeks	135,5 g
Covo	3:1 urine, 0,5 litres x 1 per week	8 weeks	204 g (1,5 fold increase)
Covo	3:1 urine, 0,5 litres x 3 per week	8 weeks	545 g (4 fold increase)
Tomato	Water only	4 months	1 680 g (total of 9 plants)
Tomato	3:1 urine, 0,5 litres x 3 per week	4 months	6 084 g (3,6 fold increase)
Maize	Water only	3 months	6 g/cob (average)
Maize	10:1 urine, 0,5 litres x 1 per week	3 months	62 g (10 fold increase)
Maize	5:1 urine, 0,5 litres x 1 per week	3 months	138 g (23 fold increase)
Maize	3:1 urine, 0,5 litres x 1 per week	3 months	169 g (28 fold increase)
Maize	3:1 urine, 0,5 litres x 3 per week	3 months	211 g (35 fold increase)



Figure 5.3: Two basins planted with rape and spinach. The basin on the left has been fed with a 3:1 mix of water and urine, three times per week interspersed with normal watering. The basin on the right has been irrigated with water only (Morgan 2003).



Figure 5.4: Urine has a pronounced effect on maize. The plant on the right is being fed with 0,5 litres of a 3:1 mix of water and urine three times per week. The plant on the left is irrigated with water only. The difference in leaf colour is striking (Morgan 2003).



Figure 5.5: Total cob yield from maize planted in three 10-litre basins. On the left the maize was fed 1 750 millilitres urine per plant over a 3,5 month period, resulting in a crop of 954 g. A reduced crop resulted from reduced input of urine (middle). Plants on the right were irrigated with water only, and produced a very poor yield (Morgan 2003).



Figure 5.6: A single photograph shows the effect of different amounts of urine applied to maize plants over a 3-month period. On the left the plants have been fed a 3:1 mixture of water and urine at a rate of 125 millilitres per plant per week, which produced a mean cob weight of 211 g. The 3:1 mixture was applied to the next group at 40 millilitres per plant per week, which led to a mean cob weight of 169 g. A 5:1 mix was applied to the third group at 27 millilitres per plant per week, giving a mean cob weight of 138 g. The next plants on the right were fed with a 10:1 mix at 15 millilitres per plant per week, resulting in a mean cob weight of 62 g. The plants on the far right were fed with water only and produced a mean cob weight of only 6 g. 99,4% of the total cob mass shown in this photograph is derived from the nutrients provided by urine (Morgan 2003).

These trials reveal the great value of urine when used as a liquid feed for various plants, and particularly for leafy vegetables (lettuce, spinach, covo, etc). The results from an extensive series of maize trials also revealed that production of maize could be increased in poor sandy soil by the application of urine alone, but if the sandy soil had humus added, then the production increased even further. The further increase gained from the addition of humus is due to the presence of nitrifying bacteria in the humus, which convert the urea and ammonia in urine into nitrate ions, the form in which they can be taken up by the plants (Morgan 2003).

The results further show that, for a family practising subsistence agriculture, a huge increase in vegetable and maize production is possible, especially in areas where the soil is poor or access to manure or commercial fertiliser is difficult or expensive. Thus, in forming links between ecological sanitation and improved food production, good agricultural practice and a culture of soil improvement is encouraged (Morgan 2003).

A potential problem identified by Morgan (2003), however, concerned the possible accumulation of sodium chloride in the soil due to the relatively high proportion of this salt found in urine. Simons and Clemens (2003) also cautioned that urine should not be used in excess in order to avoid yield losses due to high inputs of sodium chloride.

5.5 NITROGEN LOSSES IN URINE

Source-separated urine is a highly concentrated and unstable solution. During storage, bacterial urease hydrolyses urea to ammonia and bicarbonate, causing a pH increase (the pH is related to the concentration of ammonia, NH_3). As a result, 90% of the total nitrogen is present as ammonia and the pH is near 9. After storage, urine contains a large amount of non-ionised ammonia, which can volatilise when the urine solution is agitated during transport or application as fertiliser (Udert et al 2002). Therefore the prevention of ammonia losses during storage and after soil application is important for efficient use of human urine. Hellström and Kärrman (1996) emphasise the importance of constructing the collection, storage and handling system for human urine so that losses are minimised, because the experience from storage and handling of animal urine is that nitrogen losses can be large. Hellström et al (1999) agree that losses from the spreading of animal urine can be high, but maintain that losses from collection and storage of human urine are small. Losses can be minimised, however, by preventing the decomposition of urea to ammoniacal nitrogen, i.e. the sum of $\text{NH}_4\text{-N}$ and $\text{NH}_3\text{-N}$. Because the decomposition of urea leads to an increase in pH and an increase in the concentration of ammoniacal nitrogen, there is a risk of nitrogen losses through ammonia evaporation. These losses could be reduced by preventing ventilation during storage and by injecting or harrowing the urine into the soil when spreading.

Hellström et al (1999) conclude that a decrease in pH will inhibit the decomposition of urea, and that it should be possible to use acids to reduce the pH to about 3. Because the overall objective of the source separation system is to use the urine as a fertiliser, it would be suitable to use acids with a fertiliser value, e.g. phosphoric acid or sulphuric acid. This is supported by Hanaeus et al (1996), who state that the conversion of urea to ammoniacal nitrogen during storage of urine is greatly inhibited by addition of 26 mmol of H_2SO_4 per litre of undiluted urine and a cool temperature. However, they also caution that contamination of urine with faecal matter or wastewater will significantly increase the decomposition rate of urea.

In extensive field tests, Johansson et al (2000) found that ammonia losses during the application of urine in the spring (i.e. just before planting) never exceeded 10% of the amount of nitrogen applied and were usually considerably lower. Furthermore, the ammonia losses measured after the application of urine in the growing crop were negligible, because the growing crop protected the soil surface from wind and sun. He maintains that where the system is properly designed, nitrogen losses during transportation and storage are less than 1%, while the losses associated with application may be less than 2%, depending on the technology used.

5.6 CONCLUSIONS

Artificial fertilisers currently account for most of the nutrients needed by food crops. While human excreta contain virtually all the nutrients that plants require, they have been utilised for their fertiliser value only to a limited extent. Instead, much of the nutrient value in excreta finds its way into aquatic resources, where it is responsible for, among other things, problems of oxygen depletion. Many agriculturalists maintain that it is better to create a closed system by recycling nutrients back to the farmlands from where they originated. Ecological sanitation regards excreta as a valuable resource, not simply as a waste to be disposed of.

Extensive studies have been carried out to determine the fertilising value of human excreta, for various types of crops. Humans excrete some 6,6 kg of plant nutrients in the form of nitrogen, phosphorus and potassium annually. Urine has been found to contain approximately 65 to 90% of these nutrients, and many field trials have confirmed it to be a fertiliser of virtually equivalent value to commercial chemical products. In addition, as opposed to wastewater sludge, urine contains very small amounts of heavy metals. While faeces contain much fewer nutrients, they improve the organic content and improve the water-holding capacity of soils.

Human excreta have been productively used as fertiliser and soil amendment in many countries. Although this practice is still limited if examined on a worldwide basis, it has become a popular method of increasing food production, especially among lower income communities that are dependent on subsistence farming for survival, often on poor soils. A number of scientific studies have confirmed the substantial agronomic value of excreta in recent years.

CHAPTER 6: HEALTH AND SAFETY ASPECTS OF ECOSAN TOILETS AND EXCRETA RE-USE

6.1 INTRODUCTION

Ecological sanitation (ecosan) regards human excreta as a resource to be recycled rather than as a waste to be disposed of. Recycling nutrients to soil and plants reduces the need for chemical fertilisers and restores good soil organisms to protect plants (Esrey et al 1998).

Today, the alternatives to conventional wastewater treatment include systems that separate or divert urine and faeces in order to utilise the nutrients more efficiently. In regions without a sewerage network, nutrient utilisation as well as improved sanitation is possible by not mixing the fractions and avoiding flushwater. If the faecal fraction is kept dry there will be less leaching from pit toilets and the smell will be reduced. The main reasons for separating urine and faeces are thus to recycle the plant nutrients in urine and to obtain a faecal fraction that is more practical to treat and safer to handle (Schönning 2001a).

To decrease the discharge of eutrophying substances to recipient waters and to decrease the need for fossil resources in agriculture, the two most nutrient containing fractions of wastewater, urine and faeces, can be collected separately and recycled to agricultural production. Collection of the toilet fractions can be performed separately, where the urine is diverted and the faeces are collected dry or separated from the flushwater after a short transport, or by blackwater collection, where both the urine and faeces are collected as one fraction (Vinnerås 2002).

Over the past decade, wastewater treatment systems have been criticised for their non-sustainability. Toilet waste contains virtually all the plant nutrient humans ingest through food and drink, and could theoretically be recycled to plants. Phosphorus is a finite resource, with present recoverable reserves calculated to last for less than 200 years, whereas potassium is assumed to last for 300 years (Larson et al 1997).

By using urine-diverting toilets, it is possible to collect the most nutrient-containing fraction of excreta, i.e. urine, in a concentrated way. If the urine is collected separately, the main proportion of the nutrients from the household is collected in a small fraction with a low heavy metal content (Jönsson et al 2000; Höglund et al 2000).

The goal of ecological sanitation is to safely treat human faeces and provide a low-cost fertiliser and soil conditioner for use in agriculture. Urine-diverting toilets store faeces for a period of time under conditions that are intended to promote inactivation of faecal pathogens (Esrey et al 1998).

This section of the literature review is aimed at determining what information is available to assist the understanding of environmental factors affecting the survival of excreted pathogens in faeces and urine.

6.2 HEALTH RISKS OF EXCRETA RE-USE

Development of a sustainable sanitation system includes the utilisation of nutrients from human urine and faeces in agriculture. However, the quality of wastewater sludge is not fully trusted among agriculturalists and food producers. One uncertainty is the difficulty of guaranteeing the sludge quality due to the risk of non-analysed but hazardous compounds being present. Another problem, which is indirectly related to the sewerage system, is the fact that a very large part of the population in a modern urbanised society lives on a comparatively small part of the land. Hence the food is transported from a large area to a small one, and a nutrient such as phosphorus will be accumulated near the densely populated areas and inefficiently used if it is not transported back to the areas of food production (Hanaeus et al 1997).

In developing countries, excreta-related diseases are very common, and excreta and wastewater contain correspondingly high concentrations of excreted pathogens: the bacteria, viruses, protozoa and helminths (worms) that cause disease in man. There are approximately thirty excreted infections of public health importance, and many of these are specifically relevant to excreta and wastewater re-use schemes (Feachem et al 1983).

Whether urine separation and the re-use of urine can be recommended depends on whether the associated health risks are considered to be acceptable. These risks can be balanced against benefits like the fertiliser value of human urine. Higher risks from reuse of waste products may be acceptable in areas where enteric disease is endemic and where it is more often transmitted through poor hygiene and sanitation (Blumenthal et al 2000). In areas where food is scarce, benefits from larger harvests may reduce other risks such as malnutrition, which causes immunosuppression and makes the individual more susceptible to infections (Schönning 2001b).

Several investigations regarding the impact of wastewater re-use on the health of people have been conducted. These have often focused on parasites that are endemic in the area of investigation and that are known to be persistent in the environment (Blumenthal et al 1996).

Clear evidence of increased infection rates was found in several investigations, some of them involving irrigation with untreated or poorly treated wastewater. According to Cooper and Olivieri (1998), there are no recorded incidents of infectious disease transmission associated with re-use of appropriately treated wastewater, possibly because the risk is too low for detection by epidemiological methods. In the risk assessment method used as an alternative in predicting risks for infection, viruses constituted the highest risk (Schönning 2001b).

Even though individual cases of viral infections theoretically could arise from handling urine, they would probably not be recognised by any surveillance system. The risk for an outbreak caused by direct contact with urine is low, since few persons are exposed, e.g. compared to a drinking water supply or recreational water (Schönning 2001a).

However, the agricultural or aquacultural use of excreta and wastewater can only result in an actual risk to public health if all of the following occur (Strauss and Blumenthal 1994):

- (a) that either an infective dose of an excreted pathogen reaches the field or pond, or the pathogen multiplies in the field or pond to form an infective dose;
- (b) that this infective dose reaches a human host;

- (c) that this host becomes infected; and
- (d) that this infection causes disease or further transmission.

(a), (b) and (c) constitute the potential risk and (d) the actual risk to public health. If (d) does not occur, the risks to public health remain potential only. The actual risks to public health that occur through waste re-use can be divided into three broad categories: those affecting consumers of the crops grown with the waste (consumer risk), those affecting the agricultural and pond workers who are exposed to the waste (worker risk), and those affecting populations living near to a waste re-use scheme (nearby population risk) (Strauss and Blumenthal 1994).

Both proponents and critics of composting toilets and similar waste re-use technologies agree that human health is always the primary objective of any sanitation system; it must minimise the risk of disease and be capable of destroying or isolating pathogens. Both proponents and critics also agree that well-functioning sanitation together with effective hygiene education will break the cycle of disease (Simpson-Hébert and Wood 1998). The disagreement is about the evidence establishing the safety and practicability of dry sanitation with re-use as an everyday practice (Peasey 2000).

Dry sanitation with re-use is promoted as an appropriate technology for communities without sewerage or plentiful water, and has been heralded as solving many of the problems associated with other sanitation systems, for example, smell, fly-breeding, groundwater pollution, short pit life, etc. However, Peasey (2000) cautions that insufficient studies have been carried out on the problems associated with using such technologies in community settings, or on documenting pathogen die-off. She states that “the enthusiasm which this sanitation technology has generated seems sometimes to have overshadowed the most important issue, of whether the end products from dry sanitation toilets *per se* in community settings are safe to handle and use as soil conditioners and plant fertilisers.” She argues further that it is essential for an assessment to be made of the efficiency of dry sanitation in community settings, and that a need exists for documentary evidence to support various claims about different storage periods for ensuring pathogen die-off and safe handling of the compost.

6.3 PATHOGENIC ORGANISMS IN SANITATION SYSTEMS

6.3.1 Introduction

Four major groups of microorganisms can be transmitted through the environment and cause infectious diseases: bacteria, protozoa, viruses and helminths (worms that infect humans). From a risk perspective the potential presence of pathogens in faeces should always be considered, since there are so many different types of enteric infections and the prevalence is unknown for the majority of them (Feachem et al 1983). In addition, fungi are capable of causing disease in humans and animals, even though only a fraction of the species is parasitic or opportunistic. Pathogens infecting the gastrointestinal tract causing diarrhoeas also have a major significance (Schönning 2001b).

6.3.2 Urinary pathogens

Excreted urinary pathogens are of less concern for environmental transmission than are faecal pathogens. When using a urine-diverting toilet, there is a possibility for faecal material to enter the urine part of the bowl and thus contaminate the urine in the collecting tank. Experiments in Sweden have established that, should faecal contamination of source-diverted urine occur, six months of storage time is sufficient for the destruction of pathogenic organisms (Olsson et al 1996; Höglund et al 1998).

In a healthy individual the urine is sterile in the bladder. When transported out of the body, different types of dermal bacteria are picked up and freshly excreted urine normally contains less than 10 000 bacteria per millilitre. Pathogens that may be transmitted through urine are rarely sufficiently common to constitute a significant public health problem, and are thus not considered to constitute a health risk related to the reuse of human urine in temperate climates (Schönning 2001a).

Bacteria in urine

The pathogens traditionally known to be excreted in urine are *Leptospira interrogans*, *Salmonella typhi*, *Salmonella paratyphi* and *Schistosoma haematobium*. There is a range of other pathogens that have been detected in urine but their presence is not considered significant for the risk of environmental transmission. Leptospirosis is a bacterial infection causing influenza-like symptoms with 5-10% mortality that is generally transmitted by urine from infected animals (Feachem et al 1983).

Human urine is not considered to be an important route for transmission of disease since the prevalence of the infection is low. Infections by *S. typhi* and *S. paratyphi* only cause excretion in urine during the phase of typhoid and paratyphoid fevers when bacteria are disseminated in the blood. This condition is rare in developed countries (Feachem et al 1983).

Schistosomiasis, or bilharziasis, is one of the major human parasitic infections, occurring mainly in Africa. When infected with urinary Schistosomiasis caused by *Schistosoma haematobium*, the eggs are excreted in the urine, sometimes during the whole life of the host. *Mycobacterium tuberculosis* and *Mycobacterium bovis* may be excreted in the urine, but tuberculosis is not considered to be significantly transmitted by other means than by air from person to person. *M. tuberculosis* is exceptionally isolated in nature, but has been identified in wastewater coming from hospitals (Feachem et al 1983).

Protozoa in urine

Microsporidia are a group of protozoa recently implicated in human disease, mainly in HIV-positive individuals. The infective spores are shed in faeces and urine, and urine is a possible environmental transmission route. Microsporidia have been identified in sewage and in waters, but no water or foodborne outbreaks have been documented although they have been suspected (Haas et al 1999; Cotte et al 1999).

Viruses in urine

Cytomegalovirus (CMV) is excreted in urine, but the transmission of CMV occurs person-to-person and the virus is not considered to be spread by food and water. CMV infects a large proportion of the population; 50-85% by the age of 40 was reported in USA (Schönning 2001a).

It can be concluded that pathogens that may be transmitted through urine are rarely sufficiently common to constitute a significant public health problem and are thus not considered to constitute a health risk related to the re-use of human urine in temperate climates. The inactivation of urinary pathogens in the environment reduces their ability for transmission.

Inactivation of pathogens in urine

In a urine-diversion toilet, the fate of enteric pathogens entering the urine collection container is of vital importance for the hygiene risks related to handling and re-use of urine. To determine the duration and conditions for sufficient storage of the urine mixture before its use as fertiliser, it is necessary to estimate the survival of various microorganisms in urine as a function of time. Studies have been performed where different microorganisms were added to the urine and their inactivation followed over time (Schönning 2001a).

However, only a limited amount of work has been undertaken on urine treatment other than storage, such as acidification, heating and evaporative concentration. Mainly temperature and elevated pH (9) in combination with ammonia have been concluded to affect the inactivation of microorganisms. Bacteria like *Salmonella* can be inactivated rapidly, whereas viruses are hardly reduced at all at low temperatures (4-5°C) (Schönning 2001a).

Recommendations for the reuse of human urine

For single households, a urine mixture (urine and water) is recommended for all type of crops, provided that the crop is intended for the household's own consumption and that one month passes between fertilising and harvesting, i.e. time between last urine application and consumption. This approach can probably be used for any smaller system in developing countries, whereas larger (urban) systems may have to be adapted (Höglund et al 2002).

Higher ambient temperatures in many developing country settings will, however, increase inactivation rates and add in safety. One reason for more relaxed guidelines for single households is that person-to-person transmission will exceed the risk from urine related environmental transmission (Schönning 2001a).

If the ammonia content is over 1 mg/l, the pH is over 8,8 and no fresh urine is added, storage of urine for one to six months, depending on the temperature, inactivates any non spore-forming pathogens present, so the urine can then be recycled as a fertilizer to agriculture with negligible hygienic risks (Jönsson et al 1997 & 2000; Höglund et al 1998; Schönning 2001).

Due to the degradation of the urea in urine to ammonia and carbon dioxide, the environment in the soil mixture becomes toxic towards most of the microorganisms present (Höglund et al 1999; Vinnerås et al 1999). A recommendation for urine storage to attain acceptable safety limits has been developed for Swedish conditions and use of the urine as fertiliser after storage at different temperatures, to different crops and different uses of the crops produced. These recommendations vary from shorter storage times (1 month) at 4°C where the urine can be used on crops that are processed before use as fodder or food, to longer storage times (6 months) at 20°C where the urine can be used on all kinds of crops, even those that are consumed raw by humans (Jönsson et al 2000; Schönning 2001a). From field experiments carried out in Denmark, however, Tarnow et al (2003) found evidence of some bacterial regrowth in urine storage tanks. They furthermore found that viable and infective *C. parvum* oocysts appeared to survive in the tanks even after prolonged storage.

6.3.3 Faecal pathogens

Faeces do not always contain pathogens. However, from a risk perspective, their presence should always be considered since there are so many different types of enteric infections and the prevalence is unknown for several of them. To ensure a reduction of pathogens, faeces need to be treated or stored under controlled conditions (Schönning 2001b).

Bacteria in faeces

Bacteria have generally been considered as the leading cause of gastrointestinal illnesses in surveillance systems. Of these bacteria, at least *Salmonella*, *Campylobacter* and enterohaemorrhagic *E. coli* (EHEC) should be considered when evaluating microbial risks from various fertiliser products including faeces, sewage sludge and animal manure (Schönning, 2001b).

The faeces of a healthy person contain large numbers of commensal bacteria of many species. Species of bacteria found in the normal stool, and the relative numbers of different species, will vary among communities. The most widely used indicator has been the faecal coliform *E. coli*, the main constituent of the enterobacteria, enterococci (faecal streptococci), anaerobic bacteria such as *Clostridium*, *Bacteroides* and *Bifidobacterium*. These pathogenic or potentially pathogenic bacteria are used as indicators. They most commonly enter a new host by ingestion (in water, in food, on fingers, in dirt), but some may also enter through the lungs (after inhalation of aerosol particles) or through the eye (after rubbing the eye with faecally contaminated fingers). Diarrhoea is a major symptom of many bacterial intestinal infections. The bacteria may also invade the body from the gut and cause either generalised or localised infections (Feachem et al 1983).

This invasion is characteristic of typhoid infections and other enteric fevers caused by salmonellae. During infections restricted to the gut, bacteria will be passed only in the faeces. When invasion has occurred, bacteria may be passed in the urine as well and will also be found in the bloodstream at

some stage. In areas with insufficient sanitation, cholera may occur and constitute a risk for contamination of water (Schönning 2001b).

Protozoa in faeces

Protozoan parasites are pathogens that have developed adaptations that enable them to survive for prolonged periods in the environment. Their hardiness also protects them from destruction by chemical disinfection used in drinking water production processes. The two best known protozoan enteropathogens, *Cryptosporidium parvum* and *Giardia lamblia/intestinalis*, have been studied intensively during the last decade, partly due to their environmental resistance, and have been shown to be highly infectious in humans and identified as agents for waterborne epidemics. Infectious doses are low, especially *Cryptosporidium*, and have been the cause of several large waterborne outbreaks (Schönning 2001b).

Many species of protozoa can infect man and cause disease. Among them are several species that are harboured in the intestinal tract of man and animals, where they may cause diarrhoea or dysentery. Infective forms of these protozoa are often passed as cysts in the faeces, and man is infected when ingesting them. Only three species of human intestinal protozoa are considered to be frequently pathogenic: *Giardia lamblia*, *Balantidium coli*, and *Entamoeba histolytica* (Teunis and Havelaar 2002).

Viruses in faeces

Numerous viruses may infect the intestinal tract and be passed in the faeces, whereupon they may infect new human hosts by ingestion or inhalation. One gram of human faeces may contain 10^9 infectious virus particles, regardless of whether the individual is experiencing any discernible illness. More than 120 different types of viruses may be excreted in the faeces, the most commonly identified including rotaviruses, adenoviruses (including poliovirus), hepatitis A virus, reoviruses, enteric viruses and diarrhoea-causing viruses (WHO 1989).

Enteric viruses are now considered to cause the majority of gastrointestinal infections in developed regions. Hepatitis A has also been recognised as a pathogen of concern when applying waste to land and is considered a risk for water- and foodborne outbreaks, especially where sanitary standards are low (Schönning 2001b).

Infectivity varies considerably among different types of viruses and even among different strains of the same virus. Inactivation is a rate process, and the removal of infectivity therefore depends on both the efficiency of removal and the numbers initially present. In faeces and sewage these may be higher than 10^6 per gram and 10^6 per litre respectively (Stroffolin et al 2001).

Viruses are also present in throat secretions, especially during the early stages of infection. These particles are highly infectious and can remain viable for a considerable period under suitable conditions. Infection takes place when the virus is ingested, possibly in food or water (Feachem et al 1983).

Helminths in faeces

In developing countries, helminth infections are of great concern. Many species of parasitic worms, or helminths, have human hosts. Some can cause serious illnesses, but a number generate few symptoms. Only those helminths whose eggs or larval forms are passed in the excreta are of concern to this study. Only *Schistosoma haematobium* is voided in the urine; the others examined are all excreted in the faeces i.e. *Ascaris lumbricoides*, *Fasciola hepatica*, etc (Feachem et al 1983).

The eggs of helminths like *Ascaris* are persistent in the environment, and therefore regarded as an indicator of hygienic quality (WHO 1989).

The study of helminth egg contamination is very important, as they are found in great concentrations in sewage sludge and are very resistant to most treatment processes. Their presence is associated with sanitary risks when sludge is used as an agricultural fertiliser, and processes that are able to eliminate this contamination need to be understood (Asaolu and Ofoezie 2003).

Human helminth infections are a major cause of morbidity and mortality, and are the hardest of the pathogens of interest in faecal matter intended for handling and re-use. Ascariasis is one of the most common helminthic infections globally, with an estimated one billion cases in 1983 (Feachem et al 1983).

Inactivation of pathogens in faeces

Inactivation of pathogens in faeces is a more complex issue than for urine, due to varying conditions regarding moisture, climatic factors, and construction of the sanitation system, e.g. how well the urine is diverted and whether anal cleansing is practised. During faeces collection, the addition of other material such as ash or lime also needs to be considered, as it may increase the die-off rate of pathogens. The alkalinity of different types of ashes varies, however, and it may be difficult to predict the final pH and related pathogen inactivating effect (Schönning 2001b).

6.4 TRANSMISSION ROUTES OF PATHOGENS

Health hazards associated with excreta re-use are of two kinds: the occupational hazard to those who handle the excreta, which is direct through different means of person-to-person contact, and the risk that contaminated products from re-use may subsequently infect humans or animals through consumption or handling, which is indirect and includes vehicle-borne (food, water etc), vector-borne, airborne long-distance and parenteral transmission (injections with contaminated syringes) (Schönning 2001b).

In developing countries especially, excreta-related diseases are very common, and the excreta thus contain high concentrations of pathogens that cause disease in man. Pathogenic organisms can enter the human body by a number of routes, as illustrated in Figure 6.1.

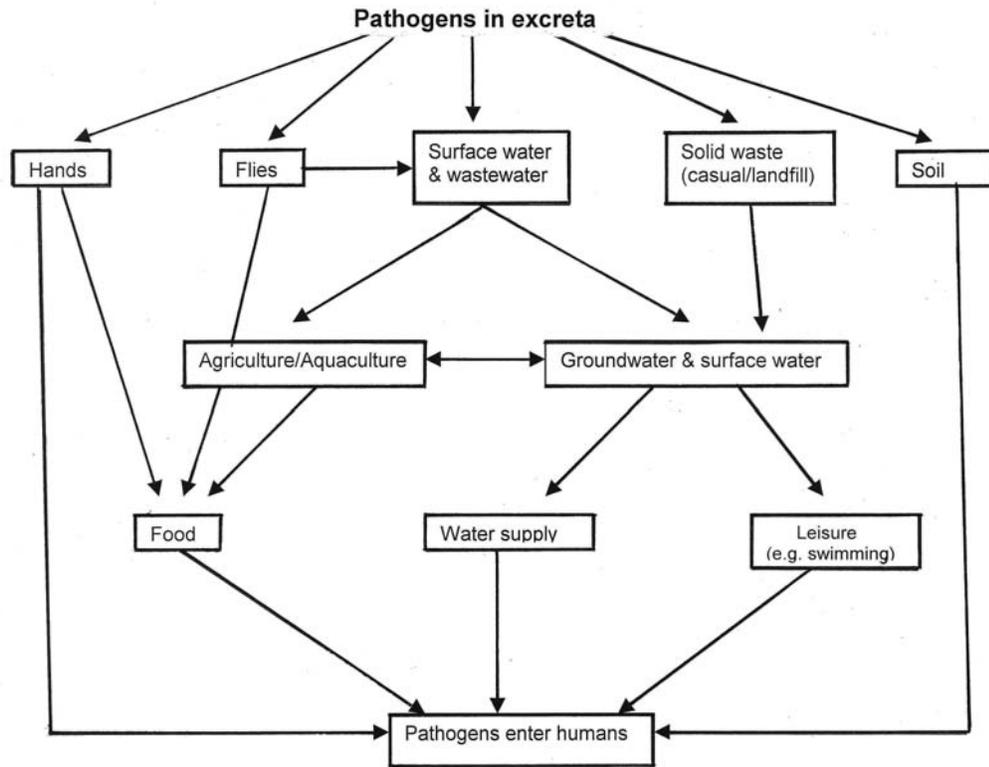

Figure 6.1: Transmission routes for pathogens found in excreta
(Franceys et al 1992).

It should be noted that poor domestic and personal hygiene, indicated by routes involving food and hands, often diminishes or even negates any positive impact of improved excreta disposal on community health (Feachem et al 1983).

Higher incidences of enteric infections in the population have been recorded in epidemiological investigations in areas where wastewater was used on crops (Cifuentes 1998; Bouhoum and Amahmid 2000). Foodborne outbreaks caused by wastewater irrigation of vegetables and fruits have also been documented (Yates and Gerba 1998).

Risk assessments have also evaluated the increased risk from wastewater-irrigated crops. Irrigation with wastewater on crops used for energy or industrial purposes may be safer, but still involves risks for transmission of disease to humans and animals in the surroundings and transport of pathogens to the groundwater (Carlander et al 2000).

The handling and re-use of all types of waste products with human or animal origins involve hygiene risks. Whether human excreta (faeces and urine) are re-used directly, diluted in wastewater (treated or untreated) that is re-used, or are a constituent of sewage sludge used in agriculture, enteric pathogens will be present and able to cause infections by ingestion of waste products or by consumption of crops that have been

fertilised. Cysts and oocysts of protozoa and helminth ova are considered to be of great public health concern since they remain viable for extended periods outside their human host. Viruses have received attention due to low infection doses and difficulties in analysing their presence in waste products (Schönning 2001b).

Many infections, in excess of fifty even if the different numbered types of viruses and serotypes of enteric bacteria are ignored, are transmitted from the excreta of an infected person to the mouth of another. The disease-causing agents (the pathogens) of these infections travel from anus (or rarely, bladder) to mouth by variety of routes sometimes directly on contaminated fingers and sometimes on food, utensils, in water, or by any other route that allows minute amounts of infected excreta to be ingested. Human excreta are the principal vehicle for transmission and spread of a wide range of communicable diseases. Some of these diseases rank among the chief causes of sickness and death in societies where poverty and malnutrition are ubiquitous (Feachem et al 1983). Diarrhoeas, for instance are, together with malnutrition, respiratory disease and endemic malaria, the main causes of death among small children and infants in developing countries. Cholera, whether endemic or epidemic in form, is accompanied by numerous deaths in all age groups, although under endemic conditions, it is children who suffer the most fatalities. Therefore the collection, transport, treatment and disposal of human excreta are of the utmost importance in the protection of community health everywhere (Strauss and Blumenthal 1994).

6.5 SURVIVAL OF MICROORGANISMS IN THE ENVIRONMENT

6.5.1 Introduction

The ability of a microorganism to survive is defined as its persistence. The persistence of microorganisms in the environment is a field that has been widely investigated (Feachem et al 1983).

As the death and survival of excreted pathogens is an important factor influencing transmission, these organisms should be destroyed or otherwise rendered harmless. In principle, pathogens die off upon excretion, as environmental conditions outside the human host are generally not conducive to their survival. Prominent exceptions are pathogens whose transitional stages multiply in intermediate hosts such as *Schistosoma* (Strauss and Blumenthal 1994). Stenström (2001) states that exposure to faecal material always constitutes a health risk, and that minimisation of direct contact is of prime importance for preventing disease transmission.

Also, some viruses, although they cannot multiply outside a suitable host cell, may survive for many weeks in certain environments, especially where temperatures are cool (less than 15°C). Another important factor is the infective dose of pathogens, i.e. the dose required to create the disease in a human host. For helminths, protozoa and viruses, the infective dose is less than 10^2 , while for bacteria it is medium to high (between 10^4 and 10^6) (Feachem et al 1993).

From the time of excretion, the concentration of enteric pathogens usually declines by the death or loss of infectivity of a proportion of the organisms. Protozoa and viruses are unable to grow in the environment, thus numbers

will always decrease, whereas bacteria may multiply under favourable environmental conditions (Feachem et al 1983).

Multiplication of bacterial pathogens is generally rare, however, and is unlikely to continue for very long. Intestinal helminths except the trematodes, which have a multiplication phase in their molluscan intermediate hosts, will decrease in numbers following excretion. The natural death of organisms when exposed to a hostile environment is of the utmost importance because it reduces the infectivity of excreta independently of any treatment process. Some treatment processes have little effect on excreted pathogens and simply allow the necessary time for natural die-off to occur. Other treatment processes create conditions that are particularly hostile to excreted pathogens and promote their rapid death. The effects of activated sludge on faecal bacteria, or of thermophilic digestion on all organisms, are of this kind. The essential environmental factors in limiting pathogens' persistence are time and temperature (Feachem et al 1983).

The success of a given treatment process in reducing the pathogenicity of an effluent or sludge thus depends in general upon its retention time and its creation of an environment especially hostile to particular organisms. The sole environmental condition likely found in a nightsoil or sewage treatment system that is most fatal to all pathogens in a reasonably short time is raised temperature (in the range 55-65°C). The only other low-cost process that causes 100% removal of pathogens is the waste stabilization pond system with its long retention times, exposure to sunlight, and good sedimentation properties. The rate of loss of infectivity of an organism also depends very much on temperature, because most organisms survive well at low temperatures (5°C) and rapidly die at high temperatures (more than 40°C). Except in sludge or nightsoil digestion processes, temperatures approximate environmental temperatures in most developing countries, generally in the range of 15-35°C and commonly 20-30°C. It is therefore useful to know the persistence of pathogens at ambient temperatures in different environments, so that the likely pathogen content of various faecal products can be predicted (Strauss and Blumenthal 1994).

The influence of the type of dry sanitation system used, and the local climatic conditions experienced, has been examined by Redlinger et al (2001). In field trials carried out in north-central Mexico, where the climate is hot and dry, they found that urine diverting dehydrating toilets produced faecal material with a lower pathogenic content than non-urine diverting biodegrading (composting) toilets. The authors pointed out that the environmental setting was a key factor in the dehydration process, since with a year-round dry climate, moisture levels in the faecal pile were lower than what would be expected in, for instance, humid, tropical environments. Also, the composting toilets could not perform well since the faecal pile rapidly lost moisture to below the critical level required to support microbiological growth.

Moe and Izurieta (2003) describe a study that was carried out on urine-diverting toilets in El Salvador (118 households with double vault urine-diverting (DVUD) toilets and 38 households with single vault solar-heated urine-diverting toilets in seven rural communities). In both types of toilets,

pH was found to be the most important single factor determining the inactivation of bacterial indicators and coliphages, while temperature was the strongest predictor of *Ascaris* die-off. The most rapid inactivation of faecal coliforms, *C. perfringens*, somatic coliphage and *Ascaris* occurred when pH was ≥ 11 and daytime peak temperature was $\geq 36^{\circ}\text{C}$. Due to the fact that faecal pile peak temperatures in the DVUD toilets were typically only 1 degree higher than the ambient temperature (average 31°C), these toilets were found to have very little impact on *Ascaris* inactivation. In contrast, peak faecal pile temperatures in the solar toilets varied between 37°C and 44°C , which resulted in no viable *Ascaris* being found. However, the DVUD toilets produced better inactivation of faecal coliforms, *C. perfringens* and coliphage, which was thought to be because of the longer average vault storage time compared with the single-vault solar toilets. The authors concluded that, in the humid climate where the study was carried out, pH and peak temperature were the most important factors affecting the microbial quality of biosolids in both types of toilets. However, they stated that double-vault toilets with long storage times (i.e. large vaults) and good solar exposure yielded the best quality biosolids overall. They also recommended that additives to raise pH levels in ecosan toilets should be strongly recommended, and added that improvements in ecosan toilet design and operation should provide a safer biosolids product for agricultural use.

Environmental factors of importance in the die-off rate of pathogens are high temperature, low moisture content and time. A high temperature, especially, is the most important consideration as all living organisms, from the simplest to the most complex, can survive at temperatures only up to a certain level. Above that level they perish. Regarding moisture content, all biological activity comes to a halt at moisture contents of 12% or less, although the process would be disastrously slowed long before that that level was reached. Generally, moisture content begins to be a limiting factor when it drops below 35 to 40%. Also time *per se* does not kill the microorganisms; rather, it is the continued exposure to an unfavourable condition that does the job (Golueke 1976). A further important factor is pH. The pH limits for the survival of *E. coli*, for example, are between 4,4 and 9,0, with the optimum between 6,0 and 7,0. In general, pH values greater than about 9,0 are detrimental to all microbial growth (Prescott, Harley and Klein 1990). In support of these observations, Peasey (2000) notes that the two most influential factors seem to be the pH of the faeces pile and the storage or resting time. The more alkaline the pile and the longer it is stored, the greater the percentage reduction in pathogens.

6.5.2 Physiochemical and biological factors that affect the survival of pathogens in excreta and re-use systems

Different factors affecting the inactivation of pathogens in the environment include temperature, pH, moisture, and competition from naturally occurring microorganisms. To obtain a fertiliser product from excreta that is safe to use, it is possible to apply treatment methods utilising any of these parameters in combination with time (Schönning 2001b).

Temperature

Most microorganisms survive well at low temperatures (5°C) and rapidly die at high temperatures (more than 40°C). This is the case for different types of media including water, soil, sewage, and crops (Feachem et al 1983).

To ensure inactivation in e.g. composting processes, temperatures around 55-65°C are needed to kill all types of pathogens (except bacterial spores) within hours. The hardiest organisms are cysts of *Entamoebae histolytica*, *Ascaris* eggs and *Mycobacterium tuberculosis*. Viruses such as bovine parvovirus and *Salmonella typhimurium* phage 28B are also considered to be heat resistant. Temperature effects might especially be of concern in temperate regions where the temperatures are quite low during a large part of the year (Schönning 2001b).

For safety reasons it would be preferable if all pathogens were killed. However, it is not possible to secure total die-off, but only determine a state where no viable organisms can be determined. If the conditions are changed, there is a risk for regrowth of pathogenic bacteria, even if only one single bacterium survives (Vinnerås 2002).

The organic material in faeces can be used to generate heat for thermal treatment. This has the advantage that when the material is degraded it is stabilised, and the risk for regrowth of organisms then decreases (Vinnerås 2002, quoting Sidhu et al 2001). The two most common treatment alternatives are incineration and thermal composting. Under aerobic conditions, microbiological digestion produces an excess of heat energy. If that heat is captured by insulating the process, either with specialised insulation material or a thick layer of organic matter, the temperature of the material increases up to 80°C (Vinnerås 2002, quoting Haug 1993 and Epstein 1997). The composting can either be dry (approximately 35-55% dry matter content) or liquid (2-10% dry matter content). However, the moisture content of the material affects the efficiency of thermal inactivation, as heat transfer to the organisms, and thus the inactivation, is more efficient when moisture is present (Vinnerås 2002, quoting Stanbury et al 1995 and Turner 2002). Obviously, this has important implications for toilets based on dehydrating principles for storage and treatment of the faecal matter.

To attain temperatures high enough for thermal inactivation of pathogens, the heat has to be kept within the material. Some parts of the material may, however, be at a lower temperature, i.e. the surface of an open heap and, where the vault is ventilated, the area around the incoming air. In such cases the material will not have a homogenous temperature and thermal disinfection will not be complete. To get all the material treated at elevated temperatures, it has to be turned so that the parts in low temperature zones are moved into high temperature zones (Vinnerås 2002).

While adding ash to the faeces is advantageous for pathogen die-off, odour elimination, fly reduction, etc, and is widely practised where urine-diversion systems are used, it also has a negative effect on heat build-up in the faecal pile. The reason is that the concentration of organic matter is decreased, which leaves less energy available to increase the temperature. To achieve sufficiently high temperatures, a high-energy amendment has to be added

to the material, for example, food waste, fruit peelings, etc. The heap also has to be well insulated (Vinnerås 2002, quoting Karlsson and Larsson 2000 and Björklund 2002). When low temperature zones are present in the heap, the pathogens will not be deactivated within all the material, and there will therefore be an increased risk for regrowth in these zones. Care must therefore be exercised when handling the material, in order to avoid direct contact. Some degree of mechanisation or automation in turning the material is advised (Vinnerås 2002).

pH

Many microorganisms are generally adapted to a neutral pH (7) even though enteric pathogens need to withstand the acidic conditions in the stomach to cause an infection. Highly acidic or alkaline conditions will have an inactivation effect on most microorganisms by the hydrolysis of cell components or denaturation of enzymes. Bacteria survival is shorter in acid soils (pH 3-5) than in alkaline soils (Feachem et al 1983). In a Vietnamese study, Chien et al (2001) found that pH was the major factor influencing pathogen destruction in faecal material. This was confirmed by Moe and Izurieta (2003) in a study carried out in El Salvador.

Moisture

Moisture content is mainly applicable to the survival of pathogens in soil and faeces. A moist soil favours the survival of microorganisms, and drying may be used as a process to sanitise excreta in dry toilets (Esrey et al 1998).

Virus survival is prolonged under moist conditions. Protozoa cysts are highly sensitive to desiccation, which may also affect their survival on plant surfaces. For *Ascaris* eggs to be inactivated, a moisture level below 5% is needed (Feachem et al 1983)

Nutrients

If nutrition is available and other conditions are favourable, bacteria may grow in the environment. Nutrient deficiencies thus only affect bacteria. Enteric bacteria adapted to the gastrointestinal tract are not always capable of competing with indigenous bacteria for the scarce nutrients available, and their ability to reproduce and even survive in the environment therefore tends to be limited (Feachem et al 1983).

6.5.3 Contamination of soils and crops

Desiccation of faeces maximises the destruction of enteric microorganisms. This greatly increases their value and manageability as an agricultural resource, as well as reducing pollutant burdens on the aquatic environment and health hazards associated with handling. Experimental data has confirmed that dry storage of faeces for a minimum period of one year usually results in a product of substantially improved microbiological quality (Wheeler and Carroll 1989). The authors assert that even the most persistent eggs, such as *Ascaris*, are usually rendered non-viable by storage for one year at moderate temperatures, e.g. 25°C.

Strauss and Blumenthal (1994) noted that temperature, dryness and UV light were important factors influencing pathogen die-off over time. When faecal sludge is applied to fields, environmental factors such as wind and sunshine come into play. Because the soil is offered a measure of protection against the elements by the leaves of the crops, pathogens tend to survive longer here than in the crops, which are more exposed (Figure 6.2).

It is possible that the product from toilets with short retention times (less than one year) carries some potential risk. The risk in epidemiological terms would depend on the extent of exposure and susceptibility to the infection. If farmers handle the fertiliser with bare hands then, depending on hygiene practices, there is a potential for transmission of infection by the oral route. This could occur in the case of helminth infections, such as *Ascaris*. Where the fertiliser is used before or at the beginning of the growing cycle of an edible crop, and dug into the soil, there would be no risk to consumers of the crop. However, in cases where the fertiliser is used in a way that brings it into contact with the edible portion of the crop, then a risk of transmission of helminth infections could occur (Strauss and Blumenthal 1990).

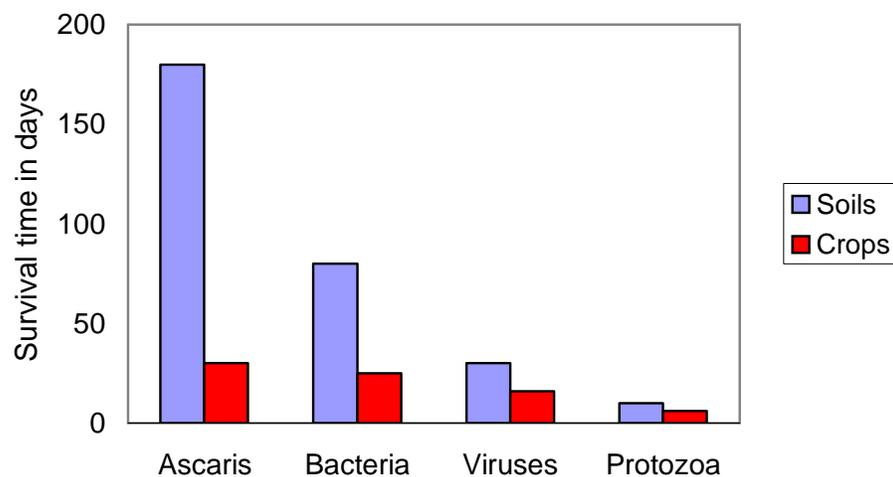

Figure 6.2: Survival times of pathogens in untreated faecal sludges applied to fields in warm climates (Strauss and Blumenthal 1994)

6.5.4 Comparison of treatment efficiencies: dry sanitation technologies vs. conventional wastewater treatment (Stenström 2001)

Investigations were carried out in a number of dry ecosan toilets in various regions of the world in order to assess the efficiency of dry sanitation in relation to the die-off of different representatives of microbial groups. Using a target time of 6 months for storage of the faecal material, analyses were done taking into account time, temperature, pH and, where appropriate, moisture. The results are shown in Table 6.1.

Table 6.1: Reduction efficiency in dry ecosan toilets, with a storage time of 6 months and pH value of 9 or more. Values are expressed as log₁₀ reductions.

Parameter	Reduction efficiency	Remarks
Bacteria (coliforms)	> 6 log	Chinese experiments
Bacteria (faecal enterococci)	4-6 log	Mexican extrapolations
Bacteriophages (index virus)	5->6 log	Chinese experiments Vietnamese experiments Mexican extrapolations
<i>Ascaris ova</i> (index parasite)	100%	Chinese experiments Vietnamese experiments

The most important result noted was the 100% reduction of *Ascaris* viability in the 6-month period. The author noted that shorter storage times resulted in partial reductions. Other observations were that viruses seemed to be reduced at a slower rate than the other pathogenic groups. Temperature was seen to be a major governing factor.

It was concluded that, as long as requirements of time, temperature, pH and, in certain circumstances, low moisture, were met, all the tested ecological sanitation treatment alternatives, independent of region, were superior to traditional wastewater treatment. A normally functioning conventional wastewater treatment plant (mechanical, chemical, biological treatment) will produce a reduction of only 1-3 logs of different groups of pathogens, depending on the type of organism. Traditional soil infiltration systems will give a similar result. From the results in Table 6.1, however, it is seen that a 6-month storage of dry faecal material at a pH of 9 will give at least an additional 3 log reduction, up to a total eradication of pathogens. While stabilisation ponds in tropical areas could, under optimal conditions, give a similar reduction, they are obviously heavily water-dependent.

The author cautioned that, despite the good results produced, regrowth of indicator organisms and bacterial pathogens may occur due to partial wetting that starts a degradation or localised composting, thus favouring short periods of growth. He concluded, however, that based on the investigations performed, on-site ecological sanitation treatment is a favourable and partly superior alternative to traditional wastewater treatment.

6.6 EXISTING GUIDELINES FOR RE-USE OF EXCRETA

6.6.1 Introduction

While extensive research has been carried out on re-use of composted faeces and sewage, and various guidelines developed over the years, re-use of dehydrated faeces has not been investigated to the same extent. Various rules of thumb regarding storage periods do exist, but there is a paucity of detailed scientific information on the subject (Austin and Duncker 2002).

The following paragraphs give a brief outline of some existing guidelines in various countries, including South Africa.

6.6.2 Wastewater and sludge re-use

In 1989, the World Health Organization published guidelines for the use of treated wastewater in agriculture (WHO 1989). For unrestricted irrigation, the recommendations were as follows:

Intestinal nematode, e.g. *Ascaris* and *Trichuris* species
and hookworms (arithmetic mean number of eggs per litre): ≤ 1

Faecal coliforms (geometric mean number per 100 ml): $\leq 10^3$

These recommendations were also supported at the time by an IRCWD report (Strauss and Blumenthal 1990). The authors additionally interpreted these guidelines as including wastewater sludges, i.e.

Intestinal nematode
(arithmetic mean number of eggs per kg wet weight): ≤ 1

Faecal coliforms
(geometric mean number per 100 g wet weight): $\leq 10^3$

However, Heinss, Larmie and Strauss (1998) suggested that wet weight was not a good basis of measurement due to the varying quantities of solids present in sludges and slurries, and stated that permissible solids loading rates should be used instead. Consequently, these authors recommended that the guideline for nematode eggs should rather be

3–8 eggs per gram total solids (TS) based on a solids loading rate of 2–3 t/ha.yr.

A more recent study published by WELL (Blumenthal et al 2000) suggested that the WHO faecal coliform (FC) value of 10^3 per 100 ml was applicable to both unrestricted and restricted irrigation, and could be relaxed to 10^4 per 100 ml where insufficient resources existed to achieve this, as long as additional protective measures were taken. The WELL study further suggested that the nematode egg guideline of ≤ 1 egg per litre was still adequate to protect consumers of cultivated vegetables spray-irrigated with effluent of consistent quality and at high temperatures, but not necessarily consumers of vegetables surface-irrigated with effluent at lower temperatures. It was concluded that a guideline of 1 nematode egg per litre may be adequate where crops with a short shelf life are grown (e.g. salad crops), but that a stricter guideline of 0,1 eggs per litre should be adopted to prevent transmission of *Ascaris* infection.

In South Africa, guidelines for unrestricted use of sewage sludge are as follows (Water Research Commission 1997):

Viable *Ascaris* ova (per 10 g dry sludge): 0
Salmonella organisms (per 10 g dry sludge): 0
Faecal coliforms (per 10 g dry sludge): 10^3

Further restrictions are that the maximum application rate should not exceed 8 t/ha.yr (0,8 kg/m².yr), and that the soil pH should preferably be higher than 6,5.

6.6.3 Dehydrated faeces re-use

Strauss and Blumenthal (1990) report some observations made from limited data obtained from double vault urine-diversion toilets in Guatemala. While die-off of bacterial pathogens was found to be high at elevated pH, it was seen that *Ascaris* eggs were very resistant – even after storage for one year at temperatures of 17-20°C they were still found to average about 300 eggs per gram. The authors inferred that a one-year storage period was not enough to achieve low or zero egg viability within the vault at these temperatures, even though the toilet contents were dry and pH was high relative to the contents in other types of toilets.

In contrast to minimum storage periods of as little as six months that are actually implemented in some countries, Strauss and Blumenthal (1990) suggest the following:

<u>Storage condition</u>	<u>Vault storage period required</u>	
	Without subsequent sun-drying	With subsequent sun-drying
• at 17-20°C average (highland, subtropical):	18 months	12 months
• at 28-30°C average (lowland, tropical):	10-12 months	8-10 months

The authors further conclude that there is no single best strategy for health protection and that each situation requires its own specific approach. Other health protection measures, e.g. crop restriction or human exposure control, should also be considered.

6.7 CONCLUSIONS

Using the products of ecological sanitation toilets in agriculture can lead to a significant cost saving, as chemical fertilisers do not have to be purchased. Compared with other sewage products, source-separated urine has hygienic advantages because few pathogens are excreted through urine.

The primary aim of sanitation is to prevent the transmission of excreta-related diseases. However, with all sanitation systems there is a risk of disease transmission related to the handling of the end product. Therefore, even a well functioning system could enhance pathogen survival and lead to an increased risk of disease transmission for those handling the end products or consuming crops fertilised with them. A greater understanding of pathogen die-off in dry sanitation toilets is required where handling and/or re-use of excreta is expected.

Relying on treatments recommended for excreta is a simpler method to ensure hygienic safety than monitoring by the analysis of microbiological parameters. Urine should be stored before use as fertiliser. The recommended period of storage is dependent on the temperature and on the crops to be fertilised. For faeces, different treatment options are possible for ensuring a hygienically safe fertiliser product.

Further research, especially concerning inactivation of microorganisms in faeces during different conditions, and risk assessments of sanitary systems, would be valuable for establishing guidelines on handling and re-using urine and faeces in a safe manner. Urine may, however, be generally considered to be a more hygienic fertiliser than faeces, and considering its larger content of nutrients, it may be recommended for re-use in most settings.

CHAPTER 7: CONCLUSIONS

7.1 GENERAL CONCLUSIONS FROM THE LITERATURE REVIEW

There is a vast amount of literature on pollution of water resources, particularly on problems caused by inadequate sanitation provision or, where sanitation exists, by poor implementation practices, operation and maintenance. All kinds of traditional sanitation technologies are subject to misuse, breakdown, blockage, leakage, stormwater damage, etc, and, as such, have been the cause of widespread environmental damage in many countries. While on-site technologies have been blamed for much of this damage, the problem is not confined to these situations only, or to any one particular type of sanitation system. Full waterborne systems are usually considered to be “top of the range” and the automatic choice for most people, yet they are possibly the most fragile sanitation technology, requiring adherence to strict operation and maintenance procedures, from the toilets up to the treatment plants. For various financial, technical and social reasons, as well as lack of capacity in many local authorities, these systems have had many adverse environmental impacts. Where implementation practices have been deficient, even robust on-site systems have failed. The problem is often exacerbated where sanitation systems depend on water for their operation. The difficulties are usually related to socio-cultural, educational and institutional issues.

An increasing awareness worldwide of the environmental issues associated with sanitation has led to the development of ecological sanitation technology. This technology is not really new, being rather a refinement of an ancient practice. It has been promoted for environmental reasons, as well as for issues such as water conservation, recycling of nutrients to arable land, easy operation, negligible maintenance costs, dignity and convenience. It represents a conceptual shift in the relationship between people and nature. The toilets are dry (meaning that no water is required for their operation) and may work by either dehydration or decomposition, and may be single- or double-vault. Dehydrating toilets make use of the principle of urine diversion. In its broadest sense, ecological sanitation can include all organic material generated in households, such as kitchen and food wastes, as well as greywater treatment and rainwater harvesting. Ecological sanitation (ecosan) has been implemented successfully in many countries and regions in various stages of development, and among communities of different socio-economic strata, religions, cultures and practices.

While the management of urine-diversion systems requires a higher level of commitment from users than do other forms of dry sanitation, such as VIP toilets, the requirements are not particularly onerous. Some handling, at household level, of urine and faeces is, however, required. With good design and construction, and also proper operation of the toilets, these duties can be minimised. The people that plan, design and build the toilets need to fully understand the basic principles involved and how they relate to local conditions, otherwise inappropriate selection of options may be made. Appropriate social interventions in the form of promotion, support, education and training are also prerequisites for successful implementation.

Human excreta are usually easier to handle when urine and faeces are kept separate, as in urine-diversion toilets. Urine may be handled in various ways. If re-use is not desired, it may simply be led into a shallow soakpit. Alternatively, if collection is

required, it may be done either by each household individually or by means of a communal system. Guidelines exist for hygienic storage and agricultural use of urine. Faeces need to be sanitised as far as possible within the toilet vaults in order to facilitate safe removal and further handling, especially where their re-use as a soil conditioner is required. Various methods can be employed to ensure this, including the use of additives such as ash, lime, sawdust, dry soil, etc, as well as the judicious use of heat-absorbent building materials, ventilation, moisture control and storage. Further treatment, e.g. by secondary composting, may still be required, depending on the particular circumstances. Good operation and management is, however, the most important obligation.

Human excreta, especially urine, are excellent fertilisers and soil amendments, and their efficacy has been proved in many countries, under a variety of climatic conditions. Many researchers and practitioners view ecosan as a means of returning essential nutrients such as nitrogen, phosphorus, potassium, etc. to the lands where the consumed crops were grown and harvested. As such, excreta should be regarded as a valuable resource, not simply as a waste product destined merely for disposal. In this way, both sanitation and agricultural practices can be made more sustainable. However, it is recognised that excreta contain both valuable nutrients and pathogenic organisms, and that a measure of diligence is required in their treatment and subsequent re-use in order to avoid disease transmission and environmental damage.

In ecological sanitation, various environmental factors play a role in the treatment of excreta. In urine-diversion toilets, the urine is generally regarded as sterile if it has not been contaminated by faecal pathogens. If contamination has occurred, six months of storage at 20°C is regarded as sufficient to render the pathogens inactive. Faeces, however, require the application of other treatment protocols in addition to storage, as the inactivation of faecal pathogens is a far more complex issue. It is necessary to create conditions inside the storage vault that are hostile to the continuing survival of pathogens, e.g. heat, dehydration, increased pH and aeration. To obtain a fertiliser product that is safe to use, it is necessary to apply treatment methods utilising any of these parameters (or a combination) together with storage time. The design and operation of the toilets are of cardinal importance in attaining the required hostile conditions inside the vaults.

Poor handling practices may also result in infection from faeces, and it is therefore essential that persons emptying the vaults and disposing of the products exercise the necessary caution. Good agricultural practices are also encouraged, in order to ensure that faeces do not come into contact with the edible portions of crops. Adequate education and hygiene awareness campaigns in communities receiving ecosan toilets are therefore a prerequisite for the maintenance of public health.

Despite the vast amount of research that has been carried out on inactivation of faecal pathogens in ecosan toilets, differences of opinion still remain on the minimum storage periods and storage conditions required to ensure safety for handling and re-use. Further research is required in order to establish practical guidelines on the best designs and management methods for achieving these conditions in the vaults, which can be used with confidence in all types of settings.

7.2 ECOSAN PROBLEMS AND CHALLENGES

Ecological sanitation is already firmly established as an accepted technology in many countries. There are, in most cases, no socio-economic barriers to its continuing implementation, as people of all income groups, in both developed and developing countries, have installed ecosan toilets in their homes. Also, farmers of all types, rich and poor, are successfully using human excreta in their fields and food gardens to benefit the soil and enhance crop production.

The primary purpose of most sanitation technologies is to contain the dangerous part of excreta in order to prevent transmission of diseases. Some technologies also aim to limit environmental pollution. However, ecosan goes a step further by encouraging the beneficial use of excreta through recycling of essential nutrients to the soil. As mentioned above, one of the major challenges of ecosan technology is to find ways of reducing the health risks attached to handling of faeces. Innovative solutions need to be found. Improved building methods and materials that encourage higher temperatures in the faecal piles should be developed. Environmentally friendly additives that enhance pathogen destruction could, if suitably priced and promoted, find a ready market in areas where electrification has replaced the need for cooking fires, or in more urbanised communities where ash may not be readily available.

Aside from the health risk, handling of excreta, especially faeces, remains a social taboo in some communities. If ways can be found to treat the faeces inside the vault such that the end product does not resemble the original material any more, it may be possible to increase the general perception and acceptance of ecosan technology. This treatment should also include the easy disposal of anal cleansing material.

In developing countries where there is a growing interest in the technology, better quality pedestals need to be introduced and actively marketed. Concrete and plastic versions have served their purpose well, and will continue to do so in certain socio-economic environments, but if ecosan is going to be promoted as a superior sanitation technology, then superior fittings should be available. Good quality ceramic products similar to those found in Sweden, for example, will help create the perception of ecosan as an upmarket system. This is of particular importance in South Africa, where dry systems are often regarded as second class. A possible problem at this stage could be convincing a manufacturer to set up a production line when, compared to conventional pedestals, the demand is still relatively small.

Implementation practices for ecosan projects presently suffer from the same shortcomings as conventional sanitation projects, in that the approaches used, coordination between implementing agencies, skills building, training, hygiene awareness, etc are often not given sufficient attention. Local authorities need to thoroughly understand the needs and interests of their communities before making investment plans, otherwise the services provided will often be inappropriate. The operation and maintenance of urine-diversion toilets, especially, is a crucial issue, and it is thus essential that proper training programmes be provided in order to ensure project sustainability.

Finally, it is necessary to investigate how communal collection services can be put in place. For ecosan to become a sustainable sanitation solution in, especially, higher density settlements, some form of institutional support for faeces disposal is likely to be necessary, as it cannot realistically be expected that every household, or even the majority of households, will be prepared to re-use their faeces on site. In order to

succeed, this service will need to be regarded as an integral facet of the municipal cleansing department's duties, and be chargeable like other municipal services such as water, electricity or solid waste disposal. The feasibility of establishing neighbourhood composting stations, as a means of encouraging safe disposal, should also be examined.

BIBLIOGRAPHY

Abbreviations:

CSIR	Council for Scientific and Industrial Research, Pretoria, South Africa
DWAF	Department of Water Affairs & Forestry, South Africa
EAWAG	Swiss Federal Institute for Environmental Science and Technology, Duebendorf, Switzerland
GTZ	Deutsche Gesellschaft für Technische Zusammenarbeit GmbH, Eschborn, Germany
SANDEC	Department of Water and Sanitation in Developing Countries, EAWAG
Sida	Swedish International Development Cooperation Agency, Stockholm, Sweden
UWEP	Urban Waste Expertise Programme, WASTE
WASTE	Advisers on urban environment and development, Gouda, Netherlands
WEDC	Water, Engineering and Development Centre, Loughborough University, UK
WELL	Water and Environmental Health at London and Loughborough, Resource Centre, WEDC, UK
WHO	World Health Organization, Geneva, Switzerland
WRC	Water Research Commission, Pretoria, South Africa
WSSCC	Water Supply and Sanitation Collaborative Council Working Group on Promotion of Sanitation (World Health Organisation, Geneva)

Asano T and Levine A D (1998). *Wastewater reclamation, recycling and reuse: An introduction*. In: Asano T (ed.) *Wastewater reclamation and reuse*. Technomic Publishing Company Inc., Lancaster, PA, USA:1-56.

Asaolu, S O and Ofoezie, I E (2003). The role of health education and sanitation in the control of helminth infections. *Acta Tropica* **86**: 283-294.

Austin, L M (2000). *Investigation into the South African application of certain alternative technologies for disposal of sanitation system wastes*. M.Eng dissertation, University of Pretoria, Pretoria.

Austin, A (2001). *Health aspects of ecological sanitation*. 1st International conference on ecological sanitation, Nanning, China. November.

Austin, A and Duncker, L (1999). Urine diversion technology in South Africa: background and case study. *IMIESA* **24** (3), March. Johannesburg.

Austin, A and Duncker, L (2002). *Urine-diversion ecological sanitation systems in South Africa*. CSIR Building and Construction Technology, Pretoria.

Austin, L M and Van Vuuren, S J (2001). Sanitation, public health and the environment: looking beyond current technologies. *Journal of the South African Institution of Civil Engineering*, **43**(1).

Björklund, G (1997). *Comprehensive assessment of the freshwater resources of the world*. News Flow, Global Water Partnership, no 1/97. Stockholm.

Björklund, A (2002). *The potential for disinfection of faecal matter by thermal composting or storage*. Minor Field Studies no. 200. Sida. Stockholm.

Blumenthal, U J, Mara, D D, Ayres, R M, Cifuentes, E, Peasey, A, Stott, R and Ruiz-Palacios, G (1996). Evaluation of WHO nematode guidelines for restricted and unrestricted irrigation. *Wat. Sci. Tech.* **33**(10-11): 277-283.

Blumenthal, U J, Mara, D D, Peasey, A, Stott, R and Ruiz-Palacios, G (2000). Guidelines for the microbiological quality of treated wastewater used in agriculture: Recommendations for revising WHO Guidelines. *Bulletin of the World Health Organisation* **78** (9): 1104-1116.

Bouhoum K and Amahmid O (2000). Health effect of wastewater reuse in agriculture. In: Chorus, I, Ringelband, G, Schlag, G and Schmoll, O (eds). *Water, Sanitation and Health. Proceedings of the International Conference, Bad Elster, Germany, 24-28 November, 1998*. IWA publishing, London, UK: 241-247.

Calvert, P (2000). *UPA, Health and the Urban Environment: Ecological Sanitation*. Contributions, September 9-15.

Carlander, A, Aronsson, P, Allestam, G, Stenström, T-A and Perttu, K (2000). Transport and retention of bacteriophages in two types of willow-cropped lysimeters. *Journal of Environmental Science and Health* **A35** (8): 1477-1492.

Carlander, A and Westrell, T, (1999). A microbiological and sociological evaluation of urine-diverting double vault latrines in Cam Duc, Vietnam. Minor field studies No. 91. Swedish University of Agricultural Sciences, Uppsala, Sweden

Cifuentes, E (1998). The epidemiology of enteric infections in agricultural communities exposed to wastewater irrigation: Perspectives for risk control. *International Journal of Environmental Health Research* **8**:203-213.

Chien, B T, Phi, D T, Chung, B C, Stenström, T A, Carlander, A, Westrell, T and Winblad, U (2001). *Biological study on retention time of microorganisms in faecal material in urine-diverting ecosan latrines in Vietnam*. Internet dialogue on ecological sanitation. [Online] <http://www.ias.unu.edu/proceedings/icibs/ecosan/bui.html>

Clark, G A (2001). *Eco-Sanitation in Mexico: Strategies for sustainable replication*. 1st International conference on ecological sanitation, Nanning, China. November.

Cooperm, R C and Olivieri, A W (1998). Infectious disease concerns in wastewater reuse. Technomic Publishing Company, Inc., Lancaster, PA, USA: 489-520.

Cordova, A (2001). *Large-scale dry sanitation programs: Preliminary observations and recommendations from urban experiences in Mexico*. HDRU Series no. 01-6. Department of National Resources, Cornell University, USA.

Cotte, L, Rabodonirina, M, Chapuis, F, Bailly, F, Bissuel, F, Raynal, C, Gelas, P, Persat, F, Piens, M A and Trepo, C (1999). Waterborne outbreak of intestinal microsporidiosis in person with or without human immunodeficiency virus infection. *The Journal of Infectious Diseases* **180**: 2003-2008.

CSIR (2000). *Guidelines for human settlement planning and design*. CSIR Building and Construction Technology, Pretoria

Dagci, H, Sednem, U, Taner, M S, Erson, G, Karacasa, F and Budak, S (2002). Protozoon infections and intestinal permeability. *Acta Tropica* **81**: 1-5.

Deverill, P. A (2000). *Learning Lessons from Sector Studies – Uganda, Tanzania, Nigeria and Kenya*. WELL.

Dos Santos, F and Breslin, L (2001). *People and systems for water, sanitation and health. Promoting ecological sanitation in two small towns*. 27th WEDC Conference. Lusaka, Zambia.

Drangert, J-O (1996). *Perceptions of human excreta and possibilities to re-use urine in periurban areas*. Stockholm Water Symposium, August 6-9, Stockholm.

Dudley, E (1996). *Technological options for dry latrines. Dry sanitation: an eco-sustainable alternative*. Workshop, San Salvador, El Salvador.

Duque, F A G (2002). *Ecological sanitation and urban agriculture*. RUAF magazine no. 8. [Online] <http://www.ruaf.org/no8/39-ecos.html>

DWAF (1996). *Draft White Paper: National Sanitation Policy*. Pretoria.

DWAF (1999). Water Affairs develops strategy to manage pollution from poorly serviced areas. *IMIESA* **24** (3). March. Johannesburg.

DWAF (2001). *White Paper on Basic Household Sanitation*. Pretoria.

DWAF (2002). *Sanitation For a Healthy Nation: The policy on basic household sanitation made easy*. Pretoria.

EcoSanRes (2003). Stockholm Environment Institute, Sweden. [Online] <http://www.ecosanres.org>

Edström, G (1999). Sudea, Ethiopia. *Personal communication*.

Elmqvist, H, Rodhe, L, Blomberg, M and Liden, B (1998). *Human urine and effluents from digestion of food refuse as a fertiliser to barley – crop yields, ammonia emission and nitrate leakage*. In: Martinez, J and Maudet, M-N (eds).

Ramiran 98 poster presentations. 8th International Conference on Management Strategies for Organic Waste Use in Agriculture. Rennes, May 1998. Rennes: Cemagref 285-293.

Epstein, E (1997). *The science of composting*. Technomic Publishing Co. Inc. Lancaster, USA.

Esrey, S, Gough, J, Rapaport, D, Sawyer, R, Simpson-Hébert, M, Vargas, J and Winblad, U (ed) (1998). *Ecological sanitation*. Sida, Stockholm.

Esrey, S and Andersson, I (1999). *Environmental sanitation from an eco-systems approach*. Vision 21: Water for People: A shared vision for Hygiene, Sanitation and water supply. [Online] <http://www.wsscc.org/vision21/docs/doc39.html>

Esrey, S A, Andersson, I, Hillers, A and Sawyer, R (2001). *Closing the loop*. Publications on Water Resources no. 18. Sida, Stockholm.

Esrey, S A and Andersson, I (2001). *Ecological Sanitation: Closing the loop*. [Online] <http://www.ruaf.org/1-3/35-37/.html>

Feachem, R and Cairncross, S (1978). *Small excreta disposal systems*. The Ross Institute Information and Advisory Board, Bulletin no 8. Ross Institute of Tropical Hygiene, London.

Feachem, R G, Bradley, J B, Garelick, H and Mara D D (1983). *Sanitation and disease: health aspects of excreta and wastewater management*. John Wiley and Sons, Washington D.C.

Franceys, R, Pickford, J and Reed, R (1992). *A guide to the development of on-site sanitation*. World Health Organisation, Geneva.

Franco-Hernandez, O, McKelligan-Gonzalez, A N, Lopez-Olguin, A M, Espinosa-Ceron, F, Escamilla-Silva, E and Dendooven, L (2003). Dynamics of carbon, nitrogen and phosphorus in soil amended with irradiated, pasteurised and limed biosolids. *Bioresource Technology* **87**: 93-102.

Frausto da Silva, J J R and Williams, R J P (1997). *The biological chemistry of the elements – the inorganic chemistry of life*. Oxford, UK.

Golueke, C G (1976). *Composting: A review of rationale, principles and public health*. *Compost Science*. Summer edition.

Gordon, J (1997). *Neighbourhood based collection of human excreta in Accra, Ghana: Case-study report*. WASTE, Gouda, Netherlands.

Gough, J (1997). *El Salvador experience with dry sanitation*. Sida Sanitation Workshop, Balingsholm, Sweden.

GTZ (2002). *Ecosan – recycling beats disposal*. Brochure produced by GTZ on behalf of the Bundesministerium für wirtschaftliche Zusammenarbeit und Entwicklung.

Gumbo, B (nd). *Non-waterborne sanitation and water conservation*. Department of Civil Engineering, University of Zimbabwe, Harare.

Gupta, K N (1997). *Neighbourhood based collection of human excreta in Ghaziabad, India: Case-study report*. WASTE, Gouda, Netherlands.

Guyton, A C (1992). *Human physiology and mechanisms of disease*. W B Saunders Company, Philadelphia, USA.

Guzha, E (nd). *Case study: Ecological sanitation alternatives in water shortage peri-urban settlements*. [Online] <http://www.i-s-w.org/mlvendre14-16.htm>

Haas, C N, Rose, J B and Gerba, C P (1999). *Quantitative microbial risk assessment*. John Wiley and Sons, Inc., New York, NY, USA.

Hanaeus, A, Hellström, D and Johansson, E (1996). Conversion of urea during storage of human urine. *Vatten* **96** (4), 263-270.

Hanaeus, J, Hellström, D and Johansson, E (1997). A study of a urine separation system in an ecological village in Northern Sweden. *Wat. Sci. Tech.* **35** (9), Elsevier Science Ltd, UK.

Hannan, C and Andersson, I (2001). *Gender perspectives on ecological sanitation*. 1st International conference on ecological sanitation, Nanning, China. November.

Harrison, J L (2004). eThekwini Water Services, eThekwini, South Africa. *Personal communication*.

Haug, R T (1993). *The practical handbook of compost engineering*. Boca Raton. Lewis, USA.

Heinz, U, Larmie, S A and Strauss, M (1998). Solids separation and pond systems for the treatment of faecal sludges in the tropics: Lessons learned and recommendations for preliminary design. *SANDEC Report no. 05/93*, Duebendorf, Switzerland.

Hellström, D and Kärrman, E (1996). Nitrogen and phosphorus in fresh and stored urine. *Environmental Research Forum* **5/6**, 221-226. Transtec Publications, Switzerland.

Hellström, D, Johansson, E and Grennberg, K (1999). Storage of human urine: acidification as a method to inhibit decomposition of urea. *Ecological Engineering* **12**, 253-269.

Höglund, C, Stenström, T A, Jönsson, H and Sundin, A (1998). Evaluation of faecal contamination and microbial die-off in urine separating sewage systems. *Wat. Sci. Tech.* **38**: 17-25.

Höglund, C, Vinnerås, B, Jönsson, H and Stenström, T A (1999). Chemical and microbial composition of source separated human urine. *Proceedings Civil and Environmental Engineering: New Frontiers and Challenges*, Nov. 8-12, Bangkok. AIT, Bangkok, Thailand.

Höglund, C, Vinnerås, B, Stenström, T A and Jönsson, H (2000). Variation of chemical and microbial parameters in collection and storage tanks for source separated human urine. *Journal of Environmental Science and Health Part A: Environmental Science and Engineering* **35**: 1463-1475.

Höglund, C, Stenström, T A and Ashbolt, N (2002). Microbial risk assessment of source-separated urine used in agriculture. *Waste Manag Res* **20** (3): 150-161.

Holden, R (2001). *Position paper on sustainable sanitation*. Appropriate Technology Conference, Johannesburg, November.

Holden, R (2004). Mvula Trust, Johannesburg, South Africa. *Personal communication*.

Holden, R D and Austin, L M (1999). *Introduction of urine diversion in South Africa*. 25th WEDC Conference, Addis Ababa, Ethiopia. September.

Holden R, Terreblanche, R and Muller, M (2003). *Factors which have influenced the acceptance of ecosan in South Africa and development of a marketing strategy*. 2nd International symposium on ecological sanitation, Lübeck, Germany. April.

Jiang, L (2001). Internet Dialogue on Ecological Sanitation: *Ecosan development in Guangxi, China*. [Online] <http://www.ias.unu.edu/proceedings/icibs/ecosan/liu01.html>

Jiayi, L and Junqi, W (2001). Internet Dialogue on Ecological Sanitation: *The practice, problem, and strategy of ecological sanitary toilets with urine diversion in China*. [Online] <http://www.ias.unu.edu/proceedings/icibs/ecosan/liu01.html>

Jönsson, H (1997). *Assessment of sanitation systems and reuse urine*. Sida Sanitation Workshop, Balingsholm, Sweden.

Jönsson, H (2002a). *Urine separation – Swedish experiences*. Urban areas, rural areas and recycling – the organic way forward. Proceedings of the NJF Seminar no. 303, Copenhagen, Denmark, August 2001.

Jönsson, H (2002b). Urine separating sewage systems – environmental effects and resource usage. *Wat. Sci. Tech.* **46 (6-7)**: 333-340.

Jönsson, H, Stenström, T A, Svensson, J and Sundin, A (1997). Source separated urine-nutrient and heavy metal content, water saving and faecal contamination. *Wat. Sci. Tech.* **35**: 145-152.

Jönsson, H, Vinnerås, B, Höglund, C, Stenström, T A, Dalhammar, G and Kirchmann, H (2000). Kallsorterad humanurin i kretslopp. VA-FORSK RAPPORT 1. Stockholm: vav. (In Swedish).

Johansson, M, Jönsson, H, Höglund, C, Richert-Stintzing, A and Rodhe, L (2000). *Urine separation – closing the nutrient cycle. Final report on the R&D project “Source-separated human urine – a future source of fertiliser for agriculture in the Stockholm region?”* Stockholm Vatten. [Online] http://www.stockholmvatten.se/pdf_arkiv/english/urinsep_eng.pdf

Jönsson, H and Vinnerås, B (2003). *Adapting the proposed Swedish default values for urine and faeces to other countries and regions*. 2nd International symposium on ecological sanitation, Lübeck, Germany. April.

Karlsson, J and Larson, M (2000). *Composting of latrine products in Addis Ababa, Ethiopia*. Minor Field Studies no. 32. Luleå University of Technology, Luleå, Sweden.

Kaseva, M E (1999). The African city in sustainable human settlement development – a case of urban waste management in Dar es Salaam, Tanzania. *Journal of the South African Institution of Civil Engineering*, **41**(1). Johannesburg.

Kirango, J, Muller, M S and Hemelaar, L (1997). *Neighbourhood based collection of human excreta in Dar es Salaam, Tanzania: Case-study report*. WASTE, Gouda, Netherlands.

Kirchmann, H and Petersson, S (1995). Human urine – chemical composition and fertiliser use efficiency. *Fertilising research* **40**, 149-154.

Larsson, M (ed.), Albertsson, B, Goldstein, B, Pettersson, O and Ulen, B (1997). *Phosphorus: essential, finite resource and an environmental problem (Fosfor livsnodvandigt, andligt och ett miljöproblem)*. Report 4735, Swedish Environmental Protection Agency, Stockholm, Sweden. (In Swedish).

Mahamud, M, Gutierrez, A and Sastre, H (1997). Biosolids management in Spain. *Water Management* **17**(7): 463-472.

Mara, D D, Ed (1996). *Low cost sewerage*. John Wiley and Sons, UK.

Matsui, S (1997). *Nightsoil collection and treatment: Japanese practices and suggestions for sanitation of other areas of the globe*. Sida Sanitation Workshop, Balingsholm, Sweden.

Moe, C and Izurieta, R (2003). *Longitudinal study of double vault urine diversion toilets and solar toilets in El Salvador*. 2nd International symposium on ecological sanitation, Lübeck, Germany. April.

Morgan, P (1999). *Ecological sanitation in Zimbabwe: a compilation of manuals and experiences*. Unpublished document, Harare.

Morgan, P (2003). *Experiments using urine and humus derived from ecological toilets as a source of nutrients for growing crops*. 3rd World Water Forum, Kyoto, March. [Online] <http://aquamor.tripod.com.KYOTO.htm>

Muller, M S (Ed) (1997). *The collection of household excreta: the operation of services in urban low-income neighbourhoods*. Urban Waste Series 6. Asian Institute of Technology, Klong Luang, Thailand.

Mvula Trust (nd). *Northern Cape Household Sanitation Programme*. Mvula Trust Case Study Series no.1. Johannesburg.

Olsson, A (1995). *Source Separated human urine: occurrence and survival of faecal microorganisms and chemical composition (Källsorterad humanurin-förekomst och överlevnad av fekala mikroorganismer samt kemisk sammansättning)*. Report 208, Department of Agricultural Engineering Sciences, Uppsala, Sweden. (In Swedish, English summary).

Olsson, A, Stenström, T A and Jönsson, H (1996). Occurrence and persistence of faecal microorganisms in human urine from urine-separating toilets. *Environmental Research Forum*, **5-6**: 409-412.

- Peasey, A (2000). *Health Aspects of Dry Sanitation with Waste Reuse*. WELL Studies in Water and Environmental Health, Task no. 324.
[Online] <http://www.lboro.ac.uk/well/resources/well-studies/full-reports-pdf/task0324.pdf>
- Prescott, L M, Harley, J P and Klein, D A (1990). *Microbiology*. W C Brown Publishers, Dubuque, USA.
- Proudfoot, D (2001). Mvuramanzi Trust, Harare, Zimbabwe. *Personal communication*.
- Redlinger, T, Graham, J, Corella-Barud, V and Avitia, R (2001). *Ecological toilets in hot arid climates*. 1st International conference on ecological sanitation, Nanning, China. November.
- Rulin, J (1997). *Neighbourhood based collection of human excreta in Yichang City, China: Case-study report*. WASTE, Gouda, Netherlands.
- Sanres (2000). Sanitation research web page maintained by Uno Winblad, Sweden.
[Online] <http://www.wkab.se>
- Schertenleib, R (2002). EAWAG/SANDEC, Switzerland. *Personal communication*.
- Schönning, C (2001a). *Evaluation of microbial health risks associated with the reuse of human urine*. Swedish Institute for Infectious Disease Control, Stockholm.
- Schönning, C (2001b). *Recommendation for the reuse of urine and faeces in order to minimise the risk for disease transmission*. Swedish Institute for Infectious Disease Control, Stockholm, Sweden.
- Schönning, C (2002). Hygienic aspects on the reuse of source-separated human urine. *Water and Environmental Microbiology*. Swedish Institute for Infectious Disease Control, Stockholm, Sweden.
- Shunchang, P et al (2001). Internet Dialogue on Ecological Sanitation: *Ecological Sanitation and Human Health*.
[Online] <http://www.ias.unu.edu/proceedings/icibs/ecosan/pan.html>
- Sidhu, J, Gibbs, R A, Ho, G E and Unkovich, I (2001). The role of indigenous microorganisms in suppression of Salmonella regrowth in composted biosolids. *Water Research* 35: 913-920.
- Simons, J and Clemens, J (2003). *The use of separated human urine as mineral fertiliser*. 2nd International symposium on ecological sanitation, Lübeck, Germany. April.
- Simpson-Hébert, M (1995). Experts discuss poor progress of sanitation in the developing world. *S A Water Bulletin*. May/June. WRC, Pretoria.
- Simpson-Hébert, M (1996). Sanitation and the seven Ps - Problems, Promise, Principles, People, Politics, Professionalism - and Potties. *Waterlines* 14 (3).
- Simpson-Hébert, M (1997). *Responding to the sanitation challenge of the 21st century*. WSSCC, Geneva.

Simpson-Hébert, M (2001). *Ecological sanitation and urban sustainability*. 1st International conference on ecological sanitation, Nanning, China. November.

Simpson-Hébert, M and Wood, S (1998). *Sanitation promotion*. WHO/WSSCC Working Group on Promotion of Sanitation, Geneva. Document WHO/EOS/98.5.

Source (2003). "Source Weekly" Special Features Edition, November.
[Online] <http://www.irc.nl/source>

Stanbury, P F, Whitacer, A and Hall, S J (1995). *Principles of fermentation technology, 2nd edition*. Pergamon, Oxford.

Steinfeld, C (1999). *Banos Ecologicos in Baja California*.
[Online] <http://www.planeta.com/99/0799bano.html>

Stenström, T A, Boisen, F, Georgsson, F, Lahti, K, Lund, V, Andersson, Y and Ormerod, K (1994). *Waterborne infections in the Nordic countries (Vattenburna infektioner I Norden)*. Tema Nord 1994: 585, Nordic Council of Ministers, Copenhagen, Denmark. (In Swedish, English summary).

Stenström, T A (1996). *Pathogenic microorganisms in wastewater systems: Risk assessment of traditional and alternative wastewater systems. (Sjukdomsframkallande mikroorganismer I avloppssystem Rskvardering av traditionella och alternativa avloppslosningar)*. Report 4683, Swedish Environmental Protection Agency and National Board of Health and Welfare, Stockholm, Sweden. (In Swedish).

Stenström, T A (2001). *Reduction efficiency of index pathogens in dry sanitation compared with traditional and alternative wastewater treatment options*. Internet dialogue on ecological sanitation.
[Online] <http://www.ias.unu.edu/proceedings/icibs/ecosan/stenstrom.html>

Strauss, M and Blumenthal, U J (1990). *Use of human wastes in agriculture and aquaculture*. IRCWD Report no. 08/90, Duebendorf, Switzerland.

Strauss, M and Blumenthal, U J (1994). *Health implications of excreta and wastewater use*. Hubei Environmental Sanitation Study, 2nd Workshop. Wuhan, China, March 3-4.

Stroffolin, T, Mele, A and Sagliocca, L (2001). Vaccination policy against hepatitis A in Italy. *Vaccine* **19**: 2404-2406.

Tarnow, I, Jorgensen, L T, Forslund, A, Enemark, H L and Dalsgard, A (2003). *Survival of faecal indicators and bacterial and parasitic pathogens in source separated human urine*. 2nd International symposium on ecological sanitation, Lübeck, Germany. April.

Teunis, F M P and Havelaar A H (2002). Risk assessment for protozoa parasites. *International Biodeterioration and Biodegradation* **50**: 185-193.

Turner, C (2002). The thermal inactivation of *E. coli* in straw and pig manure. *Bioresource Technology* **84**: 281-289.

Udert, K M, Fux, C, Münster, M, Larsen, T A, Siegrist, H and Gujer, W (2002). *Nitrification and autotrophic denitrification of source-separated urine*. International Conference "From nutrient removal to recovery", Amsterdam.

- UWEP (1999). E-mail bulletin 18. WASTE, Gouda, Netherlands.
- UWEP (2003). *Tingloy Ecosan Pilot Project*. WASTE, Gouda, Netherlands.
- Vinnerås, B (2002). *Possibilities for sustainable nutrient recycling by faecal separation combined with urine diversion*. Doctoral thesis, Department of Agricultural Engineering, Swedish University of Agricultural Sciences, Uppsala, Sweden.
- Vinnerås, B and Jönsson, H (2002). The performance and potential of faecal separation and urine diversion to recycle plant nutrients in household wastewater. *Bioresource Technology* **84**: 275-282.
- Vinnerås^a, B, Jönsson, H, Salomon, E and Richert-Stintzing, A (2003). *Tentative guidelines for agricultural use of urine and faeces*. 2nd International symposium on ecological sanitation, Lübeck, Germany. April.
- Vinnerås^b, B, Palmquist, H, Balmér, P, Weglin, J, Jensen, A, Andersson, A and Jönsson, H (2003). The characteristics of household wastewater and biodegradable solid waste – a proposal for new Swedish norms. *Submitted to Urban Water*.
- Wall, K (1997). A résumé of WASH, UNDP and World Bank water and sanitation experience. *Water SA* **23** (3). WRC, Pretoria.
- WEDC (nd). *Meeting demand for dry toilets*.
[Online] <http://www.lboro.ac.uk/departments/cv/wedc/garnet/drymex.html>
- Wheeler, D and Carroll, R F (1989). The minimisation of microbial hazards associated with latrine wastes. *Wat. Sci. Tech.* **21** (3). Elsevier Science Ltd, UK.
- WHO Scientific Group (1989). *Health guidelines for the use of wastewater in agriculture and aquaculture*. Technical Report Series 778, World Health Organisation, Geneva.
- Winblad, U and Kilama, W (1980). *Sanitation without water*. Sida, Stockholm.
- Winblad, U (1996a). *Rethinking sanitation. Dry sanitation: an eco-sustainable alternative*. Workshop, San Salvador.
- Winblad, U (1996b). *Towards an ecological approach to sanitation*. International Toilet Symposium, Toyama, Japan.
- Wolgast, M (1993). *Recycling system*. Brochure produced by WM-Ekologen ab, Stockholm, Sweden.
- WRC (1993). *Urban sanitation evaluation*. WRC report no 385/1/93, Pretoria.
- WRC (1994). *Environmental impact of on-site sanitation: A literature review with particular application to South Africa*. WRC report no KV 57/94.
- WRC (1997). *Permissible utilisation and disposal of sewage sludge*. WRC Report no. TT 85/97. Pretoria.
- WSSCC (1998). Urgent action needed by leaders in Africa. *Source Bulletin*. No 2, December. World Health Organization, Geneva.

Yates, M V and Gerba, C P (1998). *Microbial considerations in wastewater reclamation and reuse*. In: Asano T (ed.) *Wastewater reclamation and reuse*. Technomic Publishing Company, Inc., Lancaster PA, USA: 437-488.