

TACKLING THE CHALLENGES OF FULL PIT LATRINES

Volume 1: Understanding sludge accumulation in VIPs and strategies for emptying full pits

Report to the
Water Research Commission

by

David Still¹ & Kitty Foxon²

¹Partners in Development

²Pollution Research Group, University of KwaZulu-Natal



WRC Report No. 1745/1/12
ISBN 978-1-4312-0291-1
Set No. 978-1-4312-0294-2

July 2012

Obtainable from

Water Research Commission
Private Bag X03
Gezina, 0031

The publication of this report emanates from a project entitled: *Understanding the sludge accumulation in VIPs, UDs and other on-site sanitation systems, and strategies to manage desludging in the future when pits are full* (WRC Project No. K5/1745).

DISCLAIMER

This report has been reviewed by the Water Research Commission (WRC) and approved for publication. Approval does not signify that the contents necessarily reflect the views and policies of the WRC, nor does mention of trade names or commercial products constitute endorsement or recommendation for use.

© WATER RESEARCH COMMISSION

EXECUTIVE SUMMARY

Introduction

When South Africa's first democratically elected government came to power in 1994, half of South Africa's people did not have decent toilets. Access to basic water and sanitation for all became one of the priorities of the new government. Over the past seventeen years a framework of legislation, policies and guidelines has evolved to support the achievement of this goal. Responsibility for provision, operation and maintenance of basic sanitation rests with local or district municipalities designated as Water Services Authorities (WSAs). Over two million VIPs and other on-site sanitation systems have been built since 1994. But with a remaining three million households still without basic sanitation, many Water Services Authorities in South Africa are still focussed on addressing backlogs and have not given serious thought to the maintenance of the systems they have already built.

Many of the toilets that were first provided in the push to provide basic sanitation for all are expected to reach capacity in the next few years, which will result in an overwhelming demand for pits to be emptied. Without funds, policies, tools or procedures in place to manage the emptying of pits and disposal of sludge when this happens, many WSAs around the country may soon be facing a crisis.

Project scope

The goal of Water Research Commission project K5/1745 was to investigate existing management practices with regard to VIP toilets, identify challenges and lacks and develop strategies and tools for more effective management. Existing literature and current practice was explored to consolidate knowledge on pit filling, strategies and methodologies for pit emptying and the economic aspects of successful on-site sanitation management. New technologies and methods were developed for pit emptying and sustainable alternatives for the beneficial use of sludge were explored. The findings of this research have been published in three volumes as the series *Tackling the challenges of full pits*. This volume is followed by:

- *Volume 2: How fast do pit toilets fill up? A scientific understanding of sludge build up and accumulation in pit latrines*
- *Volume 3: The development of pit emptying technologies*

Challenges in on-site sanitation management

Data provided by Water Service Authorities in the course of this research (Appendix A) indicated that most pits were filling in five to nine years. This suggests that of the more than a million VIPs that have been built in the past decade many will soon reach capacity. Studies of pit filling rates across a number of communities indicated that pits generally filled at a rate of 40 litres per capita per annum, with 60 litres per capita per annum providing a safe margin for planning pit design and emptying programmes. The use of pits for solid waste disposal dramatically decreased the life span of a pit.

Some WSAs did not intend to assist householders with full pits at all. Some had invested in pit additives with the hope that it would prevent pits from filling up altogether, or increase their lifespan, although the effectiveness of these products has not been proven. And those that did plan to empty pits often assumed that they would be able to service VIP pits using the same methods they employed for septic tanks: removing the sludge with a vacuum tanker and disposing of it at the municipal waste water treatment works. These methods, however, are proving inadequate for the special challenges of pit

sludge. The dry consistency of VIP sludge and the high rubbish content that is found in many pits can present obstacles to vacuum removal. In addition, there are many households across South Africa with access only by footpaths; in these cases too it will prove impossible to empty pits with a vacuum tanker. eThekweni Municipality, which has the largest pit emptying programme in South Africa, has found manual pit emptying with long-handled tools to be the most effective method to service its 35 000 pit latrines. Clearly more appropriate technologies are needed for pit emptying. In addition, WSAs frequently assumed that they would treat VIP sludge at their waste water treatment works. VIP sludge, however, is highly concentrated and it has been found that the sludge from a small number of pits can quickly disable a treatment works entirely. Plans for managing the sludge after it had been removed frequently dealt with sludge as a waste requiring disposal. This is problematic both because waste disposal options for sludge are running out and because discarding the valuable nutrients in faeces and sludge is ultimately not a sustainable practice.

Pit filling

The rate at which sludge accumulates in a pit is determined by the amount of material entering the pit, the rate and extent to which it degrades and the conditions in and around the pit allowing liquids and degraded material to exit the pit. Degradation of biodegradable material happens through both aerobic and anaerobic processes. Volume 2 of this series, *How fast do pit toilets fill up? A scientific understanding of sludge build up and accumulation in pit latrines*, explores this in detail. A number of products now exist on the market claiming to enhance biological degradation thereby reducing or eliminating pit filling. A number of these products were tested during this study and none demonstrated any ability to reduce sludge volume. It is clear that investing in these when they have no demonstrated effectiveness represents a loss of municipal funds which could be spent ensuring that effective strategies are in place for emptying pits. A brochure on these findings, *Do additives work?*, has been produced for distribution to municipalities.

Pit emptying technologies

A review was conducted of the manual, semi-mechanised and mechanised technologies that have been developed to attempt to address the challenge of pit emptying in various contexts along with extensive discussion with engineers who have been involved in their development. The Vacutug, a pit emptying technology developed by UN Habitat, was trialled during this project with some success on low flush pits. For VIP pits, issues of access, sludge that is too dry for vacuuming and the presence of rubbish continued to present obstacles. A number of different extraction principles were explored during the course of this research with the goal of producing a technology suited to emptying pit latrines. Chains, augers, belts, pumps and vacuums were investigated. The most successful prototypes developed to date have been the motorised pit screw auger, which uses a soil auger to lift sludge from a pit, and the Nano Vac and e Vac, which use piston pumps and vane pumps to suck relatively wet sludge from pits. In addition, a pressure vessel has been developed which can be used for collecting sludge or for pumping water or air into a pit to aid removal. These technologies overcome the issue of access and proved viable when trialled on pig slurry, however the widely ranging conditions found across different pit latrines proved too challenging in some cases for effective evacuation. Prototype development and design specifications of these technologies have been published in Volume 3 of this series: *The development of pit emptying technologies*. Further development of these prototypes is needed in order to provide municipalities with a range of robust technologies capable of effectively emptying pits under the variable conditions found in the field.

As some pathogens found in pit sludge may survive for very long periods of time inside the pit, it is of utmost importance that workers, householders and household surfaces are protected from contact with sludge at all times throughout the cycle of on-site sanitation maintenance.

Disposal

If sludge is not to be buried on site after removal from a pit, it must be transported to another point for storage, disposal or processing. Disposal of pit latrine sludge has become a massive problem for some municipalities and, with a large number of pits in South Africa anticipated to reach capacity soon, is going to become an even greater difficulty. Disposal of dense pit sludge at waste water treatment works has been found to quickly overload the works in addition to being counterproductive in a number of respects. The policy of the South African government stresses the value of human excreta as a resource although utilisation must be done within strict parameters due to the hazards of contamination. This report consolidates knowledge about a number of possibilities which exist for utilising faecal sludge beneficially. Composting allows nutrients to be recovered safely if done correctly, while biogas generation accesses the energy potential of sludge – though this process produces sludge as well. eThekweni Municipality has pioneered a method for pasteurising and pelletising sludge for use as a fertiliser. A current Water Research Commission project (K5/1829) is investigating the impact of burial of sludge for use in agroforestry.

Conclusions

The task of providing adequate sanitation does not end with building toilets. On-site systems will eventually reach capacity and if a long-term plan for their maintenance, supported by a budget, is not in place, full toilets will become unusable and households will be effectively without basic sanitation once again. Water Services Authorities need urgently to assess the real requirements of the basic sanitation systems they have delivered and put plans, policies and budgets in place to maintain these systems if they are to avoid a sanitation crisis in the near future.

To date, additives currently being marketed to reduce pit filling have proven ineffective. While the potential for significantly enhancing processes already occurring in the pit seems limited, there is a need for standard methods to be established in order to investigate the effectiveness of new products. In the absence of this, municipal funds are better invested in proven methods of sludge removal.

The experience of municipalities, such as eThekweni, which have led the way in pit emptying has demonstrated that vacuum tankers are not always effective for maintaining VIP systems. The development of more appropriate technologies shows promise and prototypes designed during this research provide a strong basis for further development.

The presence of waste in the pits of toilets represents an enormous obstacle to effective pit emptying. Placing a high priority on instituting and maintaining reliable solid waste collection programmes will go a long way to solving this problem.

Sludge removed from a pit represents a resource, in terms of its nutrient content. Every effort should be made to utilise it beneficially rather dispose of it as a waste.

ACKNOWLEDGEMENTS

A number of people contributed to this research. Special mention must be made of Hans Salisbury, Frances Salisbury, and Bobbie Louton.

This project was made possible with funding from Irish Aid. Further development work on the eVac was carried out with funds from Water for People. The project team thanks the staff of eThekweni Metro Municipality for their contribution to this research. The team is also grateful to the following Engineers Without Borders volunteers from Britain who have contributed their time and expertise to the development of small mechanised Pit Emptying Technologies (PETs) for the South African context:

Mark O’Riordan
Joanna Reed
Simon McKean
India Elsdon
Rachel Pringle
Angus McBride

The project team thanks the councillors and home owners who have facilitated field trials.

The project team is grateful to the reference group which provided invaluable guidance and insight during the course of the project:

Jay Bhagwan	WRC (Chairman)
John Harrison	eThekweni Water and Sanitation
Speedy Moodliar	eThekweni Water and Sanitation
Cyprian Mazubane	Department of Human Settlements
Iris Lebepe	Department of Human Settlements
Frank Kirwan	Irish Aid
John Annandale	University of Pretoria
Eyob Tesfamariam	University of Pretoria
Richard Holden	TCTA
Ian Pearson	WATSUP Development
Gordon Borain	Umgeni Water
John Hughes	University of KwaZulu-Natal

TABLE OF CONTENTS

EXECUTIVE SUMMARY	ii
ACKNOWLEDGEMENTS	v
TABLE OF CONTENTS	vi
List of figures	viii
List of tables	x
1 INTRODUCTION	1
2 FAECAL SLUDGE MANAGEMENT IN THE SOUTH AFRICAN CONTEXT	4
2.1 Current legislation and regulatory framework.....	4
2.1.1 Responsibility for provision of basic sanitation.....	4
2.1.2 Responsibility for sanitation policy development	6
2.1.3 Funding maintenance of sanitation services.....	11
2.2 Status of faecal sludge management	14
2.2.1 Survey of all Water Services Authorities with regard to VIP maintenance	14
2.2.2 The urgent need for planning.....	19
3 WHAT'S IN THE PIT? THE COMPOSITION AND ACCUMULATION OF FAECAL SLUDGE	20
3.1 Components of faecal sludge.....	20
3.1.1 Faeces and urine.....	20
3.1.2 Pit sludge characteristics.....	21
3.1.3 Anal cleansing material.....	24
3.1.4 Rubbish	25
3.1.5 Pathogens	27
3.1.6 Other bacteria and chemicals.....	33
3.2 Sludge accumulation and degradation.....	33
3.2.1 Aerobic and anaerobic degradation	33
3.3 Do pit additives work?.....	35
3.4 Documented sludge accumulation rates.....	37
3.4.1 Using filling rates to design pits and emptying programme.....	38
3.4.2 Using a mechanistic model to design pits.....	39
4 PIT EMPTYING METHODS	41
4.1 To empty or not to empty?.....	41
4.2 Issues involved with emptying a pit.....	42
4.2.1 Consistency of sludge	42
4.2.2 Selecting an appropriate pit emptying method.....	43
4.3 Standard and innovative pit emptying methods and technologies	44
4.3.1 Manual pit emptying	44
4.3.2 Semi-mechanized emptying.....	47
4.3.3 Mechanised technologies	52
4.4 Development of new pit emptying technologies	59
4.4.1 Aid to manual pit emptying.....	59
4.4.2 The Gobbler.....	60
4.4.3 Pit screw auger.....	61
4.4.4 NanoVac: A light weight vacuum approach	62
4.4.5 Conclusions drawn on vacuum based approaches.....	67
4.5 Protecting workers and households from exposure to pathogens during pit emptying	68
5 TRANSFERRING SLUDGE TO A PLACE OF DISPOSAL	71
5.1 Manual carting	71
5.2 Mechanised carting	72

5.2.1	The UN-HABITAT two wheeled tractor	72
5.2.2	The trike	72
5.2.3	The Maquineta in Maputo	73
5.3	Modular machine	74
5.4	Transfer stations.....	75
5.5	Investigating trailers for mobile transfer	76
5.6	Solid liquid separators	76
5.7	Conclusion: Optimizing sludge transfer options.....	78
6	TREATMENT AND DISPOSAL OF PIT SLUDGE	80
6.1	Sludge as a resource	80
6.2	Regulatory framework.....	81
6.3	Existing options for the treatment and disposal of faecal sludge	82
6.3.1	Co-treatment of faecal sludge and wastewater	83
6.3.2	Specialised faecal sludge treatment works	85
	Biogas generation through anaerobic digestion.....	86
6.3.3	86	
6.3.4	Drying beds	89
6.3.5	Composting	91
6.4	Innovation in the beneficial use of sludge.....	91
6.4.1	Agroforestry: Deep row entrenchment	91
6.4.2	Injection of sludge below surface for agriculture.....	98
6.4.3	Fertilizer produced with Latrine Dehydration Pasteurisation (LaDePa) pelletizer	102
6.5	Conclusions.....	103
7	PIT EMPTYING COSTS	105
7.1	Introduction	105
7.2	Costs for emptying by vacuum tanker.....	105
7.3	Costs for manual emptying.....	107
7.4	Budget costs for dealing with movable VIP toilets.....	108
7.5	Life cycle costing.....	109
8	CONCLUSIONS AND RECOMMENDATIONS	111
8.1	Municipal waste management and full pits	111
8.2	Additives: enhancing biological activity in the pit.....	111
8.3	Preventing disease transmission during pit emptying.....	112
8.4	Effective pit emptying methods.....	112
8.5	Transport.....	112
8.6	Disposal.....	112
9	REFERENCES	114
 APPENDICES		
Appendix A:	Survey: Strategies for Management of Pit Latrine Sludge	117
Appendix B:	Do pit additives work?	126
Appendix C:	Theoretical model for understanding pit filling rates	131
Appendix D:	Specifications for Pit Screw Auger	141
	Specifications for eVac	143
Appendix E:	Draft specifications for pit emptying and sludge disposal	145
Appendix F:	Financial model	150

List of figures

Figure 2.1 Range of numbers of VIPs reported by WSAs.....	15
Figure 2.2 Distribution of reported costs of desludging VIPs.....	17
Figure 2.3 Frequency at which WSAs desludge VIPs	18
Figure 3.1 Diagram showing the different theoretical layers within a pit latrine. (Buckley et al., 2008).....	21
Figure 3.2 The moisture content of pit sludge decreases with time.	22
Figure 3.3 The COD and organic (volatile) solids of pit sludge decrease with time.....	23
Figure 3.4 The use of the pit latrine for general household solid waste disposal shortens pit life and makes pit emptying by vacuum tanker almost impossible.....	25
Figure 3.5 Where the municipal waste removal service is dysfunctional or non-existent, the use of VIP toilets for waste disposal will be more common. (The sign reads: Msunduzi Municipality. No dumping. Minimum fine R1000)	26
Figure 3.6 Rubbish removed from a pit during the course of eThekweni pit emptying programme (after the rest of the contents had been washed through into the sewer)	26
Figure 3.7 Helminths commonly occurring in faecal sludge, from left Giardia; Taenia sp.; Cryptosporidium; Trichuris trichiura	27
Figure 3.8 Prevalence of helminth and protozoan infections (Pollution Research Group, 2008)	28
Figure 3.9 Some of the stages of development of Ascaris l. in the faecal-oral cycle of transmission (Colleen Archer) Left: The hard shell of the ovum allows it to survive outside a human host; centre: necrotic ovum in the process of dying; right: fertilised egg with motile larva about to hatch.....	29
Figure 3.10 Ascaris egg viability for top (a), middle (b) and bottom (c) samples from 10 VIP latrines.	30
Figure 3.11 Ascaris total egg counts (all categories of eggs) and viability (potentially viable/total eggs) for samples collected from 10 pit latrines.	31
Figure 3.12 Taenia and Trichuris prevalence for VIP latrines 1-7 and 9-10.....	31
Figure 3.13 Zones of aerobic digestion (blue) and anaerobic digestion (orange) in the pit.....	34
Figure 3.14 Aerobic versus anaerobic conversion.....	35
Figure 3.15 Ages and intervals of emptying of pits in South Africa	37
Figure 4.1 Options for managing a full pit: emptying the existing pit versus digging a new pit.....	41
Figure 4.2 Some sites are difficult for a vacuum tanker or truck to access.....	42
Figure 4.3 Some pits are difficult for workers or equipment to access	43
Figure 4.4 Manual pit emptying in Dar es Salaam (Sugden)	45
Figure 4.5 Positive and negative aspects of manual emptying	45
Figure 4.6 The corer (Steven Sugden).....	46
Figure 4.7 eThekweni pit emptiers at work	46
Figure 4.8 Some of the hand tools developed and tested in eThekweni's pit emptying programme. The simpler tools such as long handled forks and spades proved to be more practical. The long handled grab tool pictured above left and centre was too heavy and unwieldy to be popular.	47
Figure 4.9 The Mapet (WASTE, 2009).....	48
Figure 4.10 The Gulper in action (Steven Sugden)	49
Figure 4.11 The Modified Gulper, with lever action added	49
Figure 4.12 Bangalore screwer.....	50
Figure 4.13 Early stage design idea for a double belt design (O'Riordan)	51
Figure 4.14 The Nibbler (Steven Sugden)	51
Figure 4.15 Tankers carried on a truck bed (left, EAWAG) and pulled by a tractor (right, Manus Coffey)	52
Figure 4.16 This vacuum tanker will need more than six times the vacuum power at the bottom of the pit than at the top (Coffey).....	53
Figure 4.17 Air can enter the hose and break the flow when vacuuming dry sludge (Coffey).....	53
Figure 4.18 High vacuum/ low airflow approach (Coffey)	54
Figure 4.19 Air drag system with a low vacuum/high airflow approach (Coffey)	54
Figure 4.20 Air bleed system (Manus Coffey)	55
Figure 4.21 Plug and gulp system (Coffey).....	55
Figure 4.22. Effect of fluidisation on the shear characteristics of synthetic sludges (Radford).....	56
Figure 4.23 Pit designed with built in blow/suck pipe for fluidizing and vacuuming sludge (Coffey).....	57
Figure 4.24 Micravac latrine emptying vehicle (Coffey)	57

Figure 4.25 The Dung Beetle (J.Hvidtved Larsen).....	58
Figure 4.26 The UN-HABITAT Vacutug (UN-HABITAT)	58
Figure 4.27 Actuation of enclosed spade from open to closed positions.....	59
Figure 4.28 Initial design concept for the Gobbler	60
Figure 4.29 Prototype of Gobbler with single chain and sprung scraper.....	60
Figure 4.30 Prototype of manual pit screw auger (O’Riordan)	61
Figure 4.31 Motorised pit screw auger.....	62
Figure 4.32 The original NanoVac concept. The red container would be alternately filled and emptied.....	63
Figure 4.33 Gas canister used as a pressure vessel for the NanoVac	64
Figure 4.34 The NanoVac prototype.....	64
Figure 4.35 The eVac	64
Figure 4.36 The “suck only” arrangement (left) where a removable lid is used for multiple vessels and the “suck and blow” arrangement (right) which uses a single vessel and lid.....	65
Figure 5.1 eThekwini pit emptiers cart sludge with a drumbarrow to the closest vehicle access point.....	71
Figure 5.2 Chinese two-wheeled tractor used for solid waste collection (UN-HABITAT)	72
Figure 5.3 The trike in use in Dar Es Salem (Steven Sugden)	72
Figure 5.4 System for sludge removal and transport developed by Steven Sugden	73
Figure 5.5 The Maquineta in use in Maputo (Steven Sugden)	73
Figure 5.6 A single truck which can be adapted for either refuse collection, or water delivery or vacuuming (Eawag and Sandec)	74
Figure 5.7 Transfer station in Ghana, (UN-HABITAT).....	75
Figure 5.8 The concept for a closed loop SLS where sludge is liquefied, removed from the sewage chamber and deposited into the transfer tank. The water content then re-circulates back into the pit.	77
Figure 5.9 A solid liquid separation machine (Eawag and Sandec).....	77
Figure 5.11 A solid liquid separation tank which can be deployed at the transfer station for filling	79
Figure 6.1 Theoretical options for treating faecal sludge (Heinss et al., 1998).....	83
Figure 6.2 Screening trash out of sludge at WWTW (eThekwini Municipality) – it was found that the addition of pit latrine sludge at WWTWs quickly overloaded the works and this practice was discontinued	84
Figure 6.3 Schematic diagram of the Achimota Faecal Sludge Treatment Plant in Accra, Ghana (Heinss et al., 1998)	85
Figure 6.4 Anaerobic biogas reactor built in Lesotho by GTZ (Lepofa, 2006).....	86
Figure 6.5 Schematic diagram of a pilot two-stage UASB treatment plant in Tanzania	87
Figure 6.6 Schematic diagram of ABR with different post treatment options.....	88
Figure 6.7 School toilet block with pour flush and urine diversion in Badlapur, India (Panesar and Bischoff, 2008).	89
Figure 6.8 Schematic diagram of planted and unplanted sludge drying beds	89
Figure 6.11 Pit sludge with high rubbish content buried in trenches.....	93
Figure 6.12 Eucalyptus trees at planting in February 2009 (left) and in January 2012 (right)	93
Figure 6.13 Medians of stem diameters at 1.37 m of Eucalyptus and wattle trees in rows E3, E4, E5 and E7 planted in mid-October 2009 and measured on 12 August 2011.....	94
Figure 6.14 <i>E. grandis</i> of control (left) and experimental groups (right) prior to harvest (Taylor, 2011)	95
Figure 6.15 Mean leaf area (m ²) of <i>E. grandis</i> and <i>A. mearnsii</i> measured post-harvest. Error bars shown are ±SD (n=5). Taylor (2011).....	95
Figure 6.16 Foliar N, P, K, Ca and Mg concentrations (mg.Kg ⁻¹) of <i>E. grandis</i> for control and experimental groups (n=5). Error bars shown are ±SD (Taylor, 2011)	96
Figure 6.17 Foliar N, P, K, Ca and Mg concentrations (mg.Kg ⁻¹) of <i>A. mearnsii</i> for control and experimental groups (n=4 and n=5 respectively). Error bars shown are ±SD. (Taylor, 2011).....	96
Figure 6.18 Root distribution of <i>E. grandis</i> grown above faecal sludge, shown with sludge core exposed (Taylor, 2011)	97
Figure 6.19 Design of prototype sludge injector	99
Figure 6.20 Redesigned ripper with cutting edge and angled shanks	100
Figure 6.21 Field testing the sludge injector	100
Figure 6.22 Sludge being extruded through a screen prior to heat treatment	103
Figure 6.23 eThekwini sludge pelletising plant	103
Figure 7.1 Total and running costs for various sizes of truck, assuming 50 000 km per annum usage. Figures based on the KwaZulu-Natal Department of Agriculture’s annual <i>Machinery Guide Tables</i>	105

Figure 7.2 Precast VIPs erected at Dutywa in the Eastern Cape which have collapsed due to inadequate foundation preparation.....	108
Figure 1: Zones of aerobic digestion (blue) and anaerobic digestion (orange) in the pit	127
Figure 2: Laboratory trial of two pit additives.....	128
Figure 3: Box and whisker plot of mass loss rate showing 95% confidence region (box) and min and max values (whisker).....	128
Figure 4: Sludge height in pits treated with one of two additives or water and controls measured at 3 month intervals.....	128
Figure 5: Changes in sludge height in pits treated with additive and control groups over 16 weeks.....	129

List of tables

Table 2.1 Basic services subsidies for 2011/2012.....	13
Table 3.1 Composition of VIP sludge samples.....	24
Table 3.2 Comparative characteristics of pit sludge, septage and sewage.....	24
Table 3.3 Pathogen survival periods in faecal sludge (according to IWMI & SANDEC, 2002)	28
Table 3.4: Pit filling time [years] for conditions in eThekweni municipality	39
Table 6.1 Comparison of pit latrine sludge with sewage.....	84
Table 7.1 Cost derivation where tanker empties 10 pits per day, with 200 km total travel	106
Table 7.2 Cost derivation for tanker emptying 4 pits per day, with 600 km in total travel	106
Table 7.3 Summary of costs for manual emptying of 31,856 pits, 2008-2010, eThekweni	107
Table 7.4 Life Cycle Cost	110

1 INTRODUCTION

This document represents the final report of Water Research Commission Project 1745 undertaken by Partners in Development and the Pollution Research Group at the University of KwaZulu-Natal. Additional funding was provided by Irish Aid and by Water for People. The project commenced in July 2007 and concluded in January 2012.

The project was initiated in response to the fact that over the past decade municipalities across South Africa have worked hard to roll out basic sanitation in the form of VIP toilets to the millions of households which were lacking adequate basic sanitation. These on-site sanitation systems are now approaching capacity, but few municipalities have a clear understanding of how fast their pits are filling, what challenges they will face in emptying them and potential solutions to these challenges, or what options exist for the use of sludge which has been removed from pits. The goal of this project was to contribute a clearer understanding of these aspects and provide practical strategies for the management of on-site sanitation systems. In order to achieve this goal, the project endeavoured to fulfil the following specific aims:

1. To consolidate knowledge on sludge build up and intervention strategies.
2. To audit and establishing how many pits are reaching their operational lifespan and determine the conditions thereof.
3. To describe the current situation in faecal sludge management in South Africa.
4. To analyze the institutional situation and interactions of the key stakeholders in faecal sludge management.
5. To determine sludge build-up in VIPs, UD's and other on-site sanitation systems over their life span through field investigations.
6. To analyse the financial situation based on an integrated faecal sludge management approach at a municipal level.
7. To develop a financial mechanism for integrated and sustainable faecal sludge management.
8. To develop new technologies, strategies and processes to manage desludging and its safe disposal.

The following activities were undertaken in order to fulfil these aims.

- **Literature review:** A survey of both published and unpublished literature was conducted with a focus on legislation related to sludge management, pit latrine emptying methods and methods to treat, utilise and dispose of sludge. Typically each chapter of the report begins with a discussion of the relevant findings from this review.
- **Survey of South African Water Services Authorities:** All of the WSAs in South Africa were surveyed in order to establish a comprehensive picture of VIP sludge management across South Africa. Data was collected on sludge accumulation, sludge removal and disposal practices, costs and policies. The survey results are discussed in Section 2.2 of the report. Survey data can be found in Appendix A.
- **Investigation of pit additives marketed in South Africa.** A number of laboratory and field trials were conducted as part of this research to investigate the efficacy of pit additives that are currently being marketed to WSAs in South Africa with the promise that they will reduce

or halt the accumulation of sludge in pit latrines. To date the Water Research Commission has tested approximately 20 additives and none have proven effective. These studies are covered in Chapter 3.3. An educational brochure, titled *Do pit additives work?* was produced for distribution to WSAs. The brochure can be found in Appendix B.

- **Composition and degradation of sludge.** The components of sludge were studied and aerobic and anaerobic processes occurring in the pit were studied and modelled.
- **Investigation of pit filling rates.** Previous studies of the rates at which on-site systems fill were reviewed. A number of new studies were conducted as part of this research to observe pit filling rates in different communities. This research is covered in Chapter 3.4 and is covered in detail in Volume 3 of this series, titled *How fast do pit toilets fill up? A scientific understanding of sludge build up and accumulation in pit latrines.*
- **Development of sludge accumulation model.** A model was developed to predict the rate of sludge accumulation in pits based on a number of variables in order to assist WSAs with planning of pit servicing programmes. The model can be found in Appendix C.
- **Direct learning from and collaboration with faecal sludge management experts.** This involved a number of distinct activities:
 - A representative was sent to the UN Habitat headquarters in Kenya to study the design and operation of the Vacutug.
 - A one day workshop was held with approximately 15 international experts and practitioners in faecal sludge management in order to consolidate and evaluate knowledge and experience gained to date and to identify key areas requiring further research.
 - Numerous personal communications were conducted with international experts throughout the course of this study.
- **Development of new technologies for emptying pit latrines.** Technologies that have been developed around the world for emptying pits were studied. A number of prototypes were developed and tested as part of this research to aid pit emptying:
 - Manual emptying tool
 - Manual pit screw auger
 - Mechanised pit screw auger (Specifications Appendix D)
 - The Nanovac (based on the MAPET developed by the Dutch NGO WASTE)
 - The eVac and pressure vessel (Specifications Appendix D)
 - The Gobbler (based on the Nibbler designed by Steven Sugden)
 - Testing of the Vacutug developed by UN Habitat

The development of these technologies is covered in Chapter 4 and is covered in detail in Volume 3 of this series, titled *The development of pit emptying technologies.*

- **Development of specifications for pit emptying.** Specifications were prepared to guide municipalities and contractors as follows:
 - Specification for pit emptying (health and safety precautions, depth of emptying)
 - Specification for on-site sludge disposal
 - Specification for relocating latrines

These specifications can be found in Appendix E.

- **Consolidation of knowledge of existing methods and innovations in transport, disposal and beneficial use of pit latrine sludge.** These findings are presented in Chapters 5 and 6.
- **Investigation and modelling of costs involved in servicing pit latrines.** This is presented in Chapter 7.
- **Dissemination of consolidated knowledge and new knowledge gained.** This involved a number of distinct activities:
 - A two day seminar titled *What happens when the pit is full?* was held to share and disseminate knowledge. Approximately 130 South African and international delegates attended. A summary report on the proceedings can be found at www.afrisan.org.
 - A CD compilation of presentations from the on-site faecal sludge management seminar was produced. The CD was distributed to delegates and is available from the Water Research Commission.
 - A 30 minute film, titled *What happens when pit latrines get full?*, was produced addressing key sludge management issues and strategies, including the innovations in pit emptying which were developed during the course of this project. This film was distributed to key players in the sanitation field at the Faecal Sludge Management Seminar in March 2011 and will continue to be distributed by the Water Research Commission.

The aim of this report is to bring the legislation, experience and knowledge relevant to on-site sanitation management in South Africa together with international experience and innovation and the innovations developed within the course of this research as a comprehensive resource to aid municipalities and contractors with the complex challenges of managing on site sanitation in a sustainable, safe and cost-effective way.

2 FAECAL SLUDGE MANAGEMENT IN THE SOUTH AFRICAN CONTEXT

When South Africa's first democratically elected government came to power in 1994, it was estimated that nearly half of the population did not have decent basic sanitation. In its first white paper, titled *Water Supply and Sanitation Policy*, the Department of Water Affairs and Forestry wrote:

In a country with nuclear power, cellular telephones and vast inter-catchment water transfer schemes, more than 12 million people do not have access to an adequate supply of potable water; nearly 21 million lack basic sanitation. Public action is needed to remedy this unacceptable situation, but it must be action based on a clear policy which is premised on the rights of all people to determine their own future. The goal of Government is thus to ensure that all South Africans have access to essential basic water supply and sanitation services at a cost which is affordable both to the household and to the country as a whole (DWAf, 1994).

The unacceptable status of sanitation was understood to be an outcome of the discriminatory policies of the former apartheid government and the provision of sanitation, therefore, an urgent and integral part of the work of restoring human dignity and equality in the South African context:

The fundamental issue to be addressed in the water sector is that of equity. The line which divides those with adequate access to water from those without is the same line dividing the rich from the poor, the hungry from the well fed, the line of race and privilege. It is one more example of the inequities in all spheres of our society; in health, education, housing, and land ownership. The goal of the new Department of Water Affairs and Forestry is to end the inequity in access to basic water supply and sanitation services (DWAf, 1994).

Over the past seventeen years, a framework of legislation, policies and guidelines has evolved to support the achievement of this goal.

2.1 Current legislation and regulatory framework

The fundamental objective of the South African Constitution (Act 108 of 1996) is to ensure that all South Africans are able to enjoy certain basic rights and access to basic services and a safe environment. Subsequent Acts of Parliament and the amendments to existing Acts seek to effect legislation that is both complimentary and congruent in this regard. However, as Business Partners for Development (2001a) point out, few of the provisions of the acts and bills have been tested in a court of law. As a consequence, the onus and legal obligation of ensuring and providing basic rights and services is open to interpretation until such time as legal precedents are set. The following discussion of the relevant acts and bills should be considered in this light.

2.1.1 Responsibility for provision of basic sanitation

The following legislation clarifies the roles and responsibilities of government with regard to basic sanitation, and in particular the key role played by local government:

❖ The Constitution of the Republic of South Africa (Act 108 of 1996)

The constitution requires local government to assume full responsibility for ensuring that water and sanitation services are provided.

❖ The Municipal Systems Act (Act 32 of 2000)

- Requires municipalities to draw up Integrated Development Plans (IDPs) which include budgeting, operational and development strategies
- Sets out the mechanisms by which the local authority may provide services
- Prescribes the way in which a tariff policy can be developed

❖ The National Water Act (Act 36 of 1998)

Regulates how waste water may be returned to the natural environment

❖ The Water Services Act (Act 108 of 1997)

- Includes both water supply and sanitation under the definition of water services
- Defines a Water Services Authority (WSA) as “any municipality, including a district or rural council as defined in the Local Government Transition Act, 1993 (Act No. 209 of 1993), responsible for ensuring access to water services.”
- Charges every Water Services Authority with a duty to “all consumers or potential consumers in its area of jurisdiction to progressively ensure efficient, affordable, economical and sustainable access to water services.”
- Allows the use of Water Services Providers (WSP) for delivery of services
- States that every water services authority must develop a draft Water Services Development Plan (WSDP) which details the operational plans and budgets for supplying water services to residents. This should be part of the integrated development plan for the municipality.
- Authorises the Minister of Water Affairs and Forestry to provide model bylaws to be used as a guide by water services authorities

❖ The Municipal Structures Act (Act 33 of 2000)

Allocates the responsibility for water services to either the district municipality, or to the local municipality, if authorised by the Minister of Provincial and Local Government. (For example, Msunduzi Local Municipality falls within uMgungundlovu District but has been designated as a WSA for its area of jurisdiction, while uMgungundlovu District Municipality is designated as the WSA for the other six smaller local municipalities in the district.)

❖ **The National Environmental Management Act (Act 107 of 1998)**

- Charges national and provincial departments with the responsibility for developing environmental management and development plans
- Charges provincial government with ensuring that municipalities within its jurisdiction adhere to these plans
- Suggests that municipal Integrated Development Plans should indicate how municipalities will comply with environmental plans

❖ **The annual Division of Revenue Bill**

- Determines the way in which nationally raised revenue is divided between national, provincial and local government
- Allocates funding for the ongoing delivery of basic services to poor households through Local Government Equitable Share (LGES) payments and the Municipal Infrastructure Grant (MIG)

2.1.2 Responsibility for sanitation policy development

The Department of Water Affairs (DWA) was until 2009 responsible for the development of national policy on sanitation. It published a number of documents to this end:

❖ **The National Sanitation Policy – White Paper (1996)**

- Developed by the National Sanitation Task Team which included the Ministers of Health, Housing, Education, Water Affairs, Constitutional Development and Provincial Affairs, Environmental Affairs and Tourism
- Defines the term basic level of service for a household as a Ventilated Improved Pit (VIP) toilet in a variety of forms, or its equivalent, as long as it meets minimum requirements in terms of cost, sturdiness, health benefits and environmental impact
- States that provision should be made for an ongoing programme to provide basic information about effective hygiene practices
- Emphasises community participation in decisions regarding sanitation
- Suggests that solutions must be environmentally sustainable
- States that “recurrent expenditure (operations, maintenance, replacements, administration, loan repayments) should be financed by current income, comprising consumer charges, local taxes and inter-governmental transfers”
- Promises that government will determine tariff structures within which municipalities should set their own tariffs – provided these comply with policy

❖ The Model Water Services Bylaws (DWAF, 2000)

- Published in terms of the Water Services Act
- Suggest that charges in respect of the emptying of pits cover all the operating and maintenance costs for the removal of the pit contents, transportation to a disposal site, the treatment of the contents to achieve a sanitary condition and the final disposal of any solid residues be based on the volume removed by vacuum tank or otherwise, or if the volume cannot be determined a fixed charge may be levied may be in the form of a monthly contribution or it may be levied as a single payment when the service is rendered.

❖ The White Paper on Basic Household Sanitation (DWAF, 2001)

- Emphasizes the importance of municipal IDPs as the mechanism for planning for sanitation delivery. Infrastructure Investment Plans (IIP) and Water Services Development Plans (WSDP) are components of this.
- Provincial Sanitation Co-ordinating Forums, which include representatives from national government and municipalities, are responsible for coordinating sanitation interventions at the provincial level
- National Sanitation Task Team(NSTT) is to be established as a sub-committee of the Municipal Infrastructure Task Team (MITT)
- National Sanitation Co-ordination Office (NASCO) comes under the Department of Water Affairs with the creation of a Sanitation Directorate
- Municipal Infrastructure Grant (MIG) is the mechanism for funding residential infrastructure
- Highlights the problem of cost recovery, particularly in rural areas, for water and sanitation
- Mentions the requirement for free basic level of service and suggests that the NSTT will develop guidelines for the application of this as a matter of priority

❖ The Strategic Framework for Water Services (DWAF, 2003)

- Provides a comprehensive policy document for water services including sanitation
- Sets goals for access to services, education and health, free basic services and institutional development and performance
- Emphasises flexibility in the type and scale of water services provider (WSP)
- Defines the responsibilities of water services authorities and water services providers
- Indicates that DWA will become responsible for the regulation, policy development and support for the provision of water services and will cease to operate or maintain any water services

- Indicates that WSAs must provide infrastructure, promote health and hygiene and be responsible for the cost of operation and maintenance as follows:

The challenges of providing free basic sanitation are threefold:

Infrastructure provision. The key challenge with respect to the provision of free basic sanitation is the provision of the sanitation facility itself to poor households (together with the necessary supporting infrastructure). Therefore the free basic sanitation policy is directly linked to the policies for infrastructure provision which are discussed in section 4.2.

Health and hygiene promotion must be provided in a co-ordinated manner and must be properly managed and adequately funded if free basic sanitation is to become a reality. This requires close collaboration between the district municipality responsible for environmental health, the water services authority and the water services provider.

Subsidising the operating and maintenance costs. If the basic service is to be provided free to the poor then the Water Services Authority must ensure that the costs of providing the service are covered by the local government equitable share and/or through cross-subsidies within the water services authority area. These funds must be paid to the Water Services Provider who operates the service or directly to the households. All Water Services Authorities must develop a policy to define how this will be addressed.

DWAF, 2003

- Suggests but does not prescribe appropriate technology:

Choice of technology. The definition of a basic sanitation service (see section 6.3.1) does not define the technology to be used in providing such a service. This decision, made by the Water Services authority, is the key to success in providing free basic sanitation services in a sustainable manner. The selection of technology is strongly dependent on settlement conditions. Water Services Authorities must typically address the following situations:

In urban areas, where many businesses are located and where residential densities are high, waterborne sanitation is generally the most appropriate technical solution and should be regarded as a basic level of service for the purposes of the free basic sanitation policy.

In rural areas, where housing densities are low and few businesses are located, on-site technical solutions are an appropriate basic level of service.

In intermediate areas (for example, peri-urban areas or rural areas where settlement densities are high), a Water Services Authority must decide on an appropriate technology which is financially viable and sustainable. In most instances, on-site sanitation systems are likely to be the most appropriate solution. Care must be exercised when choosing waterborne sanitation systems in this context. The Water Services Authority must ensure that the Water Services Provider will be able to maintain and operate this system sustainably over time with the available funds.

- Introduces the possibility of consumers managing their own sanitation facilities in rural areas

- Includes planning for maintenance and operation as a responsibility of the WSA:

Operating the service. The arrangements for operating the sanitation service must be properly understood before the financial arrangements for subsidising the operating costs of free basic sanitation can be addressed. In many rural areas it is unlikely in the foreseeable future that water services providers operating in these areas will have the capacity to empty or relocate Ventilated Improved Pit toilets (VIPs) and hence it will often be necessary for households to manage the sanitation facilities themselves. The subsidy arrangements need to take these factors into account.

- Promises that DWA will develop a “free basic sanitation strategy together with a set of guidelines to assist Water Services Authorities to implement the free basic sanitation policy”
- Sees tariffs for sanitation developed as a sum of sanitation charges, bulk wastewater charges and waste discharge charges
- Indicates that while tariffs should reflect all costs associated with a service, they should also be affordable for all households:

Tariffs must be set at levels that facilitate the financial sustainability of the service, taking into account subsidisation from sources other than the service concerned.

DWAF, 2003

- Suggests that tariffs for water and sanitation be set to cross subsidise any amounts above the LGES and MIG required for the provision of free basic water and sanitation.
- Emphasises the importance of the Water Services Development Plan, requiring a new plan to be drawn up every five years, and a report on progress with implementing the plan to be made public on an annual basis.
- Insists that the Water Services Development Plan must show how the Water Services Authority plans to meet its universal service obligation to provide at least a basic level of service to all people living within their area of jurisdiction.
- Defines a basic sanitation service as:

The provision of a basic sanitation facility which is easily accessible to a household, the sustainable operation of the facility, including the safe removal of human waste and wastewater from the premises where this is appropriate and necessary, and the communication of good sanitation, hygiene and related practices.

DWAF, 2003

- Introduces the principle of regulation of outcome rather than compliance with stated regulations to allow for flexibility and a focus on national government supporting Water Services Authorities and Water Services Providers so as to promote the effective delivery of water services.

- Lists the interventions available to DWA should Water Services Authorities not provide services as they are legally obliged to do.
- Sets Key Performance Indicators for Water Services Authorities (e.g. Number of households without a basic sanitation service to be reduced by 14% each year to achieve full coverage in seven years, i.e. by 2010).

❖ **The National Sanitation Strategy (DWA, 2005)**

- Concerned mainly with infrastructure delivery
- States that “the current national capacity cannot cope with the task of delivering sanitation for all by 2010”
- Reiterates that sanitation must form an integral part of Water Services Development Plans
- Suggests that business plans for sanitation projects should include operation and maintenance plans and how these will be facilitated (e.g. positioning of toilets for access for mechanical pit emptying)
- Says that the regulatory role of DWA should be strengthened
- Attempts to set out a common approach to be adopted at municipal level
- Indicates that municipalities will need to increase budgets for sanitation if the services backlog is to be eliminated
- Estimates that R2,850 million will be required to meet the backlog and provide universal coverage in South Africa by 2010
- Estimates the cost of mechanised and manual removal of toilet sludge in urban areas at between R500 to R800 per household
- Advocates schools and tertiary institutions as venues for raising sanitation awareness
- Mentions the PHAST and WASH campaigns for community participation in sanitation solutions.
- Advocates ways in which procurement processes can be relaxed in order to speed up delivery, including nominated sub-contractors and Public Private Partnerships (PPP)

❖ **The Free Basic Sanitation Implementation Strategy (DWA, 2008)**

- Revises the target of delivery of basic sanitation to all from 2010 to 2014.
- Emphasises joint responsibility of local authorities and households in improving sanitation.

- Presents a vision for water services:

All people living in South Africa have access to adequate, safe, appropriate and affordable water and sanitation services, use water wisely and practise safe sanitation.

Water supply and sanitation services are sustainable and are provided by effective and efficient institutions that are accountable and responsive to those whom they serve.

Water is used effectively, efficiently and sustainably in order to reduce poverty, improve human health and promote economic development. Water and wastewater are managed in an environmentally responsible and sustainable manner.

DWAF, 2008

- Provides a consumer-oriented planning and decision-making framework
- Provides a model for the relationship between Water Services Authorities and Water Services Providers
- Provides a comparison of technologies ranging from VIPs to full waterborne sanitation and associated capital and operations
- Provides guidelines and models for financial planning and funding of sanitation delivery and operations

The acts and policies listed above give a clear indication that government has a responsibility to provide sanitation, and that this responsibility has been devolved to the local level. DWA is responsible for the monitoring and regulation of water services, and to this end has launched a project to assess the compliance of Water Service Authorities with legislation (DWAF, 2006). An online support tool has been developed to assist Water Service Authorities with the task of compiling and submitting their Water Services Development Plans (DWAF, 2007).

In 2009, the responsibility for sanitation policy development was transferred to the Department of Human Settlements (previously known as the Department of Housing). This department is currently engaged in a review of South Africa's sanitation policy and it appears likely that settlement type (rural, urban) will be used as the framework for sanitation policy in the future.

2.1.3 Funding maintenance of sanitation services

The funding mechanisms by which these basic services will be supplied are clear: MIG grants and housing subsidies will be provided for infrastructure development, while tariff cross-subsidisation and the Local Government Equitable Share (LGES) will fund operation and maintenance.

Section 4 of the Municipal Systems Act (Act 32 of 2000) states that: "The council of a municipality has the right to finance the affairs of the municipality by (i) charging fees for services; and (ii) imposing surcharges on fees, rates on property and, to the extent authorised by national legislation, other taxes, levies and duties." This suggests that municipalities should fund basic services from revenue. This would put the burden on ratepayers, and in most cases municipalities would find themselves with inadequate means to meet national targets. National government has recognised that additional funds are required

so that municipalities can provide free basic services to poor households (National Treasury of South Africa, 2007).

❖ The Local Government Equitable Share

The Division of Revenue Bill, which is tabled annually, sets out the way in which national revenue will be divided between national, provincial and local government. Transfers are paid to municipalities through the Department of Provincial and Local Government. Apart from a variety of infrastructure grants, the main operating grant is the Local Government Equitable Share (LGES). It is an unconditional grant in terms of section 214(1) (a) of the Constitution (Act 108 of 1996), and this allows municipalities to spend it at their own discretion. The basic formula used to calculate the LGES is:

$$\text{Grant} = \text{BBAF} (\text{BS} + \text{D} + \text{I}) - \text{R} \pm \text{C}$$

Where

BBAF	is the Budget Balancing Adjustment Factor
BS	is the Basic Services Component
D	is the Development Component
I	is the Institutional Support Component
R	is the revenue raising capacity correction
C	is a correction and stabilisation factor.

The Basic Services Component (BS)

- Is provided to enable municipalities to provide free basic services to poor households
- Recognises water reticulation, sanitation, refuse removal and electricity reticulation as the core services for which poor households must be subsidised
- Defines poor households as those earning less than R800 per month, as recorded in the 2001 Census
- Provides a sum for environmental health care for all households
- Is allocated to municipalities according to the services for which they are responsible.
- Distinguishes between those households that actually receive services from the municipality, and unserved households (thus creating an incentive to municipalities to provide services)
- Is calculated using the formula:

$$\begin{aligned} \text{BS} = & \text{ [Water Subsidy 1 x no. of poor households with adequate water services +} \\ & \text{Water Subsidy 2 x no. of poor households without adequate water services] +} \\ & \text{[Sanitation Subsidy 1 x no. of poor households with adequate sanitation +} \\ & \text{Sanitation Subsidy 2 x no. of poor households without adequate sanitation] +} \\ & \text{[Refuse Subsidy 1 x no. of poor households with refuse removal +} \\ & \text{Refuse Subsidy 2 x no. of poor households without refuse removal] +} \\ & \text{[Electricity Subsidy 1 x no. of poor households with electricity supply +} \\ & \text{Electricity Subsidy 2 x no. of poor households without electricity supply] + [Environmental} \\ & \text{Healthcare Subsidy x Total number of households]} \end{aligned}$$

The average monthly basic services subsidies per poor household for 2011/2012 specified in the 2011 Division of Revenue Bill are:

Table 2.1 Basic services subsidies for 2011/2012

Service costs per month (R)	Serviced Households	Unserviced Households
Electricity	188.04	84.62
Water	125.36	56.41
Refuse	125.36	56.41
Sanitation	125.36	56.41
Total	564.12	253.85

The subsidy for environmental health care services is R12 per household. Note that, due to the lower operating costs, households using VIPs are classified as “unserved” for this calculation.

While these figures were revised after a study by the Department of Planning and Local Government in 2004, they still only define the *proportions* of the BS allocated to different services, since the actual amounts are adjusted when the budget balanced grant is calculated – in 2008 for example the average municipality received more than double the above allowances.

The Development Component is set at zero until government has decided on a measure for the developmental needs of municipalities.

The Institutional Support Component (I) is intended to support administration and governance, this component is calculated as:

$$I = \text{Base allocation} + [\text{Admin support} \times \text{Population}] + [\text{Council support} \times \text{Number of Seats}]$$

The Revenue raising capacity correction factor (R) is used to reduce the equitable share for municipalities with proven revenue-raising capacity. It is calculated at 5% of the revenue that should be available to a municipality.

The Stabilising Constraint (C) is an adjustment which ensures that municipalities receive a guaranteed proportion of the amount allocated to them in the Medium-Term Expenditure Framework (MTEF), which is the rolling three year budget cycle.

The Budget Balancing Adjustment Factor (BBAF) is applied so that all LGES grants fit within the amount budgeted by the National Treasury (NT).

The final LGES grants are substantially higher than the unadjusted amount as a result of the application of the BBAF, R and C adjustments.

The Financial and Fiscal Commission (FFC), in its submission to the National Treasury regarding the 2007 budget, suggested an urgent review of the subsidies for the BS component of the LGES grant, to take account of regional and geographical differences affecting service delivery. Government indicated that it is undertaking a review of the local government fiscal framework which will include “a study on the cost of providing a basket of essential public services to the poor.”

The regulatory framework within which water services are supplied in South Africa has developed over the past seventeen years to a point where responsibilities are clear and strategic objectives are set. Policy and legislation have converged to form a coherent picture of what the fundamental living

conditions are which South Africans should enjoy – electric light, ready access to at least 25 litres of water per person per day, regular refuse removal and the use of safe and hygienic toilet facilities. Municipalities have an unambiguous responsibility to ensure that all within their jurisdiction have these basic services, and are answerable to national government should they fail to achieve this.

It has become clear that infrastructure alone cannot guarantee a better quality of life, and there is consensus that maintenance of existing and new systems, as well as health and hygiene education, are essential components of the sanitation delivery package. Through the act of providing infrastructure, particularly when this is heavily subsidised or free, government commits itself to maintaining it. On-site sanitation is a common ingredient of the Free Basic Water Services provision, and VIPs are considered adequate infrastructure for basic service delivery. The requirement for pit emptying is an inescapable consequence of this policy. While the Free Basic Sanitation Policy is not yet available in a simple stand-alone document, the principles in the Strategic Framework for Water Services make it clear that those qualifying for free basic services should receive a basic level of service for free, and that the basic sanitation service should be maintained at government expense. Local government must allocate the funds to service this need either from national government subsidies – i.e. from the equitable share – or from their own revenue.

2.2 Status of faecal sludge management

Section 2.1 above has dealt with government's intentions and policy with respect to basic sanitation. For rural and most peri-urban areas this means some form of on-site sanitation. In the case of waterborne sanitation, Water Services Authorities are responsible for the proper treatment of the resulting sewage at wastewater treatment plants, and this role is regulated by means of mechanisms such as the Department of Water Affairs' "Green Drop" grading system. Less well understood – and at this stage still completely unregulated – is government's role with regard to the treatment and disposal of faecal wastes emanating from on-site sanitation systems, in particular VIP latrines. The proper management of faecal waste from on-site sanitation systems is the focus of this study.

2.2.1 Survey of all Water Services Authorities with regard to VIP maintenance

Several million more South African homes have access to sanitation in 2011 compared with 1994. Of these somewhere in the region of two million homes are estimated to be served by some form of basic on-site sanitation provided by local government.

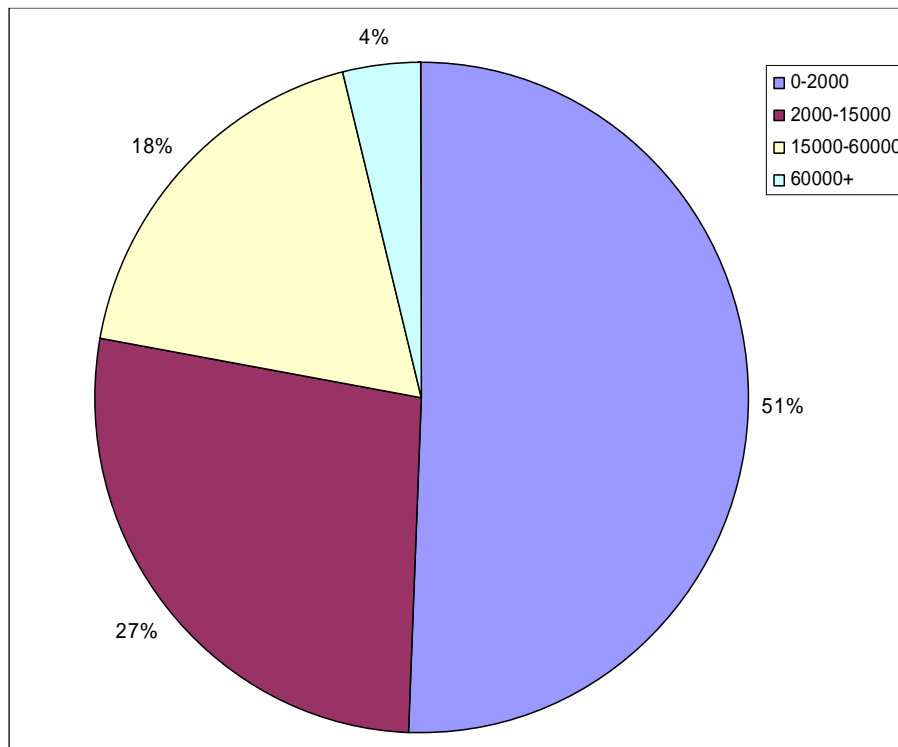

Figure 2.1 Range of numbers of VIPs reported by WSAs

In South Africa, the management of water and sanitation is organized under 154 Water Services Authorities (WSAs) (some of which are district municipalities, and some of which are local municipalities or metropolitan municipalities). In a survey conducted for this study (see Appendix A), 61% of the WSAs in South Africa indicated that they have provided basic sanitation to at least some of their citizens in the form of VIPs. Of these 4% had large numbers of VIPs (60 000 or more), 18% had between 15 000 and 60 000, and the remaining 78% had only relatively small numbers (15 000 or less).

2.2.1.1 Infrastructure

Basic sanitation models

A number of different types of sanitation systems other than the VIP were delivered in different parts of the country. Urine diversion (UD) systems were used most notably in Durban, and some communities were provided with low flush systems such as the Hungerford-Schroeder (HS) model, which seals with a flap in which excreta pass through a liquefier to a soak pit. In addition, numerous variations on the standard VIP design can be found.

❖ Top structures

While concrete block top structures were initially more common and are still standard in some areas, some municipalities had switched to prefabricated top structures to make their relocation possible when the pit fills up. Respondents at 54% of the WSAs surveyed indicated that their VIP top structures were immovable and 30% indicated that they were moveable; the rest did not know. Some municipalities reported that the movable structures were not as easily moved as had been hoped, with panels cracking and breaking when taken apart and transported. Respondents at other municipalities believed they had dealt with this potential problem through careful attention to the design and quality of the prefabricated toilets. When low flush systems were used, they were frequently installed inside the house. While this potentially represents greater convenience and safety for toilet users, saving on construction costs was a strong motivation for service providers. However in cases where toilets (of any design) were built inside small dwellings sometimes occupied by a large number of people, householders may find the indoor arrangement uncomfortable (see WRC pour flush research conducted by Partners in Development, 2011).

❖ Pit design

Pit design also varied due to terrain, but most pits were between 1.5 and 2.5 metres deep. Some VIPs used double pits with a depth of as little as one metre in areas where there was shallow soil depth or a high water table. The majority of VIPs were lined in some way to ensure stability as problems had been experienced with unlined pits collapsing. Concrete block construction with open joints allows liquid to leach out of the pit and enhances bacterial action at the soil-sludge interface, slowing the rate of accumulation in the pit. In areas with rocky soil, lining had not always been necessary. In areas where the water table is high, pits were often lined with a watertight seal in order to prevent groundwater contamination or the pit filling with water, but such sealed pits required much more frequent emptying. Alternate designs used concrete rings, ferrocement, and dry packed wedge blocks for the pit lining.

2.2.1.2 Operations and management

❖ Planning and budgeting for pit maintenance

Despite the fact that two thirds of the WSAs with VIPs indicated that they assumed responsibility for desludging at least some of their VIPs, only half of these budgeted for this and only 17% had a policy in place to guide this function.

In most cases, funds from the general operations and maintenance budget were used to maintain basic sanitation. A third of the municipalities which were currently desludging pits charged households a fee, which in some cases generated adequate revenue to cover the costs of service provision. A quarter of the municipalities with VIPs considered operations and management to be entirely the responsibility of households. However, some of these WSAs had been forced to step in due to vandalism of toilets or health risks arising from full toilets that are not emptied. In some municipalities the bulk of housing was on private farms, where farm owners were responsible for sanitation.

Figure 2.2 shows the reported municipal expenditure on desludging of VIPs per toilet per year. The distribution shows an “abnormal” curve, with most spending well above or below the median range. This may be the result of inaccurate data, indicating that most respondents did not have a firm idea of the full and actual costs of their desludging operations. Or this may simply indicate that in practice the contractual arrangements and methodologies used by municipalities for desludging vary widely.

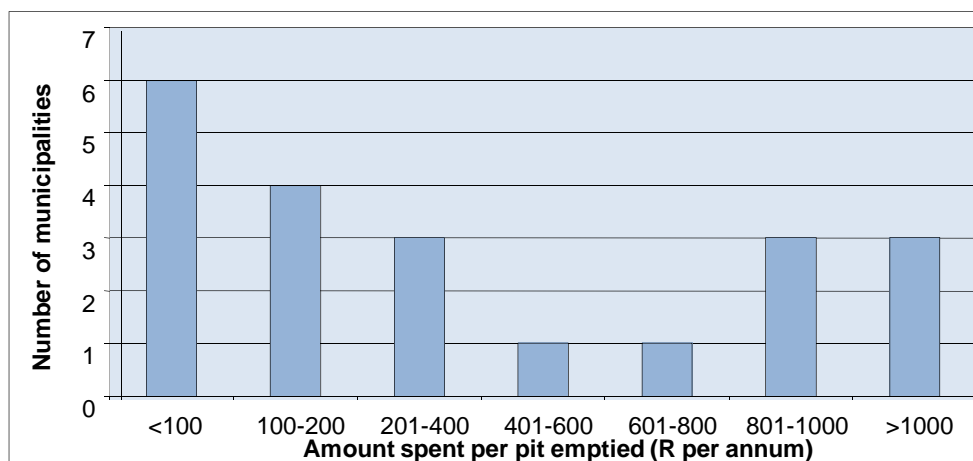

Figure 2.2 Distribution of reported costs of desludging VIPs

❖ Pit emptying

At the time of the survey, 59% of the WSAs reported that they had needed to empty pits; some of these had only needed to empty a small number of pits thus far. WSAs reported widely varying filling rates, with emptying reported as frequently as twice monthly to as infrequently as eleven years. Water table, periods of heavy rainfall and the use of the pit for disposal of household waste or wash water impact the filling rates. In some areas smaller pits had been constructed due to rocky terrain, requiring more frequent emptying.

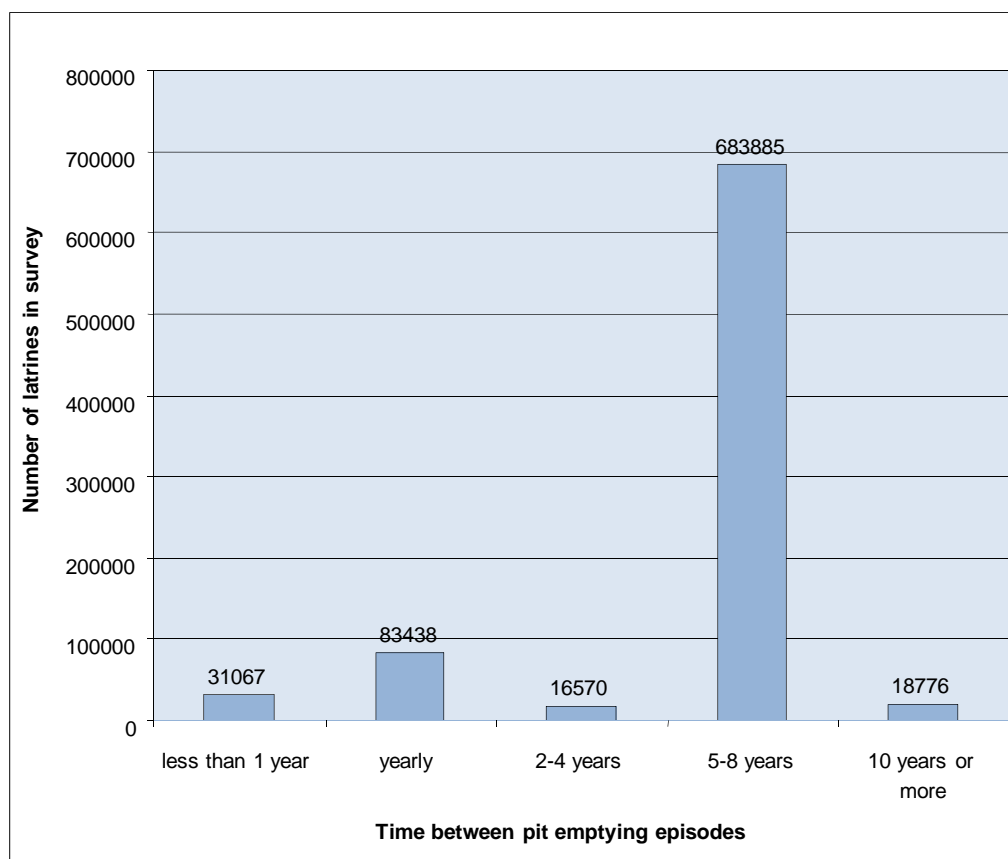

Figure 2.3 Frequency at which WSAs desludge VIPs

A third of the WSAs with VIPs used, or planned to use, their own staff and equipment exclusively to empty pits, while a quarter hired a contractor. The //Khara Hais Municipality hired residents of the target neighbourhood to remove sludge manually or move top structures, but had had incidents of residents filling the toilets with stones in order to generate employment for themselves.

Most of the WSAs used vacuum tankers to desludge pits, while a minority emptied manually, in some cases because rubbish in the pit had made it too difficult to use vacuum tankers. eThekweni (Durban) had recently completed the emptying of approximately 35 000 VIPs and had found the only practical method in terms of access was by hand.

❖ Disposal of sludge

Three quarters of the WSAs which were desludging toilets disposed of sludge exclusively at the municipal sewage works, while a quarter used on or off site burial, sea outfalls or release sludge into the sewerage lines.

❖ Health and hygiene education

While most WSAs provided a health and hygiene programme while their VIPs were being built, only 40% of the municipalities with VIPs had a long term programme. These were provided by the Departments of Water Affairs, Human Settlements or Health, by various departments within the municipality or by private contractors. Some were run by health inspectors who held community meetings or did education in the schools; in other cases there was a special week or month of educational activities planned each year or a programme that was repeated every few years.

❖ Additives

Twenty-one percent of WSAs promoted or provided bio-enzyme additives to householders. Survey respondents at some of those which did not described having used additives in the past and found them ineffective. Others expressed an interest in trying additives.

2.2.2 The urgent need for planning

It is clear from the legislation that responsibility for the provision, operation and maintenance of basic water services – water supply and sanitation – rests with the local or district municipality designated as a Water Services Authority.

Due to the strong emphasis placed by the new South African government on rectifying historic inequalities in sanitation, most WSAs have devoted their energies to the construction of new infrastructure to overcome basic sanitation backlogs. Very few have as yet engaged seriously with the challenge of keeping this infrastructure working. Most WSAs have not yet put adequate effort and resources into planning and budgeting for maintaining the sanitation systems that they have delivered. Many of the toilets that were first provided in the push to provide basic sanitation for all are expected to reach capacity in the next few years which will result in an overwhelming demand for pits to be emptied, yet many WSAs have not set aside funds, developed policies or thought through procedures for emptying and disposal of sludge when this happens. Many assume that they will be able to empty VIP toilets with the municipal vacuum tankers used to empty septic tanks, but in reality this is often not a viable option for the much denser VIP sludge which is often full of rubbish; in addition, many sites cannot be reached by a large tanker. Many WSAs are also operating on the assumption that they will be able to dispose of VIP sludge at the municipal waste water treatment works. However, WSAs such as eThekweni Water Services (see Section 6.3.1) have found that dense VIP sludge can very quickly overload the treatment works and cause operational failure. eThekweni's experience with pit emptying and sludge disposal provides many useful lessons for other WSAs and is discussed in this report in Sections 4.3.2 and 6.4.3.

There is an urgent need for South African WSAs with on-site basic sanitation to conduct an accurate assessment of the basic sanitation systems they have delivered and put plans, policies and budgets in place to maintain these systems. If they do not, South Africa will very soon find itself back in the same situation it was in at the beginning of the rollout of basic sanitation: where households have no sanitation at all because existing systems have reached capacity and can no longer be used.

3 WHAT'S IN THE PIT? THE COMPOSITION AND ACCUMULATION OF FAECAL SLUDGE

3.1 Components of faecal sludge

A number of factors affect the content of faecal sludge. No two pits will have the same contents and within a pit the contents will not be homogenous. The quantity and composition of faeces and urine depend on the diet, lifestyle and health of individuals who have used the toilet. In addition, if users are infested with faecal pathogens, part of their pathogen load will be excreted along with faeces. The material used by the household for anal cleansing (toilet and other paper, water, rags, plastic) will constitute part of the faecal sludge. If the toilet is of a pour-flush or low-flush design, flushing water (which may have been used for washing clothes or dishes or for bathing and therefore contain fats or detergents) will also comprise part of the sludge. In addition, at homes where there is no municipal solid waste collection and no soak pit for household water, the toilet will often be used as a convenient disposal site for grey water and rubbish. Depending on the depth of the pit relative to the water table at different times of the year the pit may also be infiltrated by groundwater, creating wetter and therefore possibly less oxygenated conditions which then results in a slightly different composition and volume of sludge than that degraded under dryer conditions.

3.1.1 Faeces and urine

A typical adult excretes an average of 0.4 kg of faeces per day, which comprises 0.1 kg of dry mass if the moisture content, which comprises 70-80%, is removed. Approximately 80-90% of faeces is organic matter which can degrade, and can be broken down as follows:

- undigested fibre: 30%
- bacteria (mostly non-viable): 30%
- lipids (fats): 10-20%
- protein: 2-3%
- some digestive residuals and GI shed-epithelium, trace amounts of virus, hormones, antibiotics

An adult also passes about 1.5 litres of urine per day, comprised of:

- 1.4% inorganic electrolytes (such as Na, K, Cl, SO₄, Mg, P)
- about 1.3% urea (CO(NH₂)₂)
- about 0.54% organics + 0.4% organic ammonia salts; and
- water

The percentage of each user's urine which ends up as part of the faecal sludge in the pit each day can be influenced by issues such as whether they are away from the home during the day and whether they urinate outside and not exclusively in the toilet. With the urine diversion (UD) model which has been used in eThekweni and other places, urine is diverted to a soak away or container for collection, with the result that little or no urine derived content is present in the faecal sludge.

3.1.2 Pit sludge characteristics

The most significant elements making up the organic compounds in sewage are hydrogen (H), oxygen (O), carbon (C), nitrogen (N), phosphorus (P) and sulphur (S) (Marais and Ekama, 1984). With time the organic compounds in sewage tend to decompose into CO_2 , H_2O , NH_3 and oxidised P and S, assisted by various bacteria and other living organisms that are present in the sludge and in the sludge environment. During the process of decomposition the sludge becomes more stable (less prone to further changes) due to the decrease in organic (carbonaceous) matter.

According to the theory proposed by Buckley et al. (2008), the faecal sludge portion within any pit latrine can be described in terms of four theoretical categories as shown in Figure 3.1. (i) The first category is sludge where readily biodegradable components are still present, wherein rapid aerobic degradation occurs and can be visualised as freshly deposited faeces. This layer is negligibly small and is not measurable in practice; (ii) the second category is made up of the top aerobic section of the pit. In this layer, aerobic degradation of hydrolysable organic material occurs at a rate limited by the aerobic hydrolysis of complex organic molecules to simpler compounds; (iii) the third layer is anaerobic due to the occlusion of oxygen by covering material. Anaerobic digestion proceeds at a significantly slower rate than in the layer above, and is controlled by the rate of anaerobic hydrolysis of complex organic molecules to simpler molecules; and (iv) in the lowest layer, no further stabilisation of organic material occurs within the remaining life of the pit.

This theory applies when there is relatively little movement of material in the pit after original addition, such that the age of the material in the pit (amount of time since it was deposited) increases with increasing depth and is therefore probably limited to relatively dry pits (no free liquid surface). In this case, the amount of biodegradable solid as a fraction of total solids should decrease with increasing depth for samples collected from the surface layer (i) through to layer (iii) and should remain constant in layer (iv). This would be observed as decreases in chemical oxygen demand (COD), volatile solids (VS) and biodegradability of pit latrine sludge content as a function of total solids as one digs from the surface layer down to the bottom layer of the pit. It should also be noted that depending on the household habits and local environmental conditions, and the history of these factors, there will be considerable variation in the moisture content, organic content, non-biodegradable content and microbial population of material with time as it is added to the pit, and therefore variations will occur within the pit, and similarly big variations will occur between pit latrines.

In this study, 20 pit latrines were visited and data relating to household user habits was gathered. Physico-chemical characteristics of sludge from various locations in 16 pits were measured.

The moisture content characterization results are presented in Figure 3.2. In most of the pit latrines, the moisture content showed a general decrease with increasing depth. This suggests that most of the pit latrines investigated were located in areas where most of the pit volume was above the level where free ground water can be found at the time that the pit was sampled. This implies that there was a net movement of water out of the pit. A Pearson correlation test was performed which confirms that there

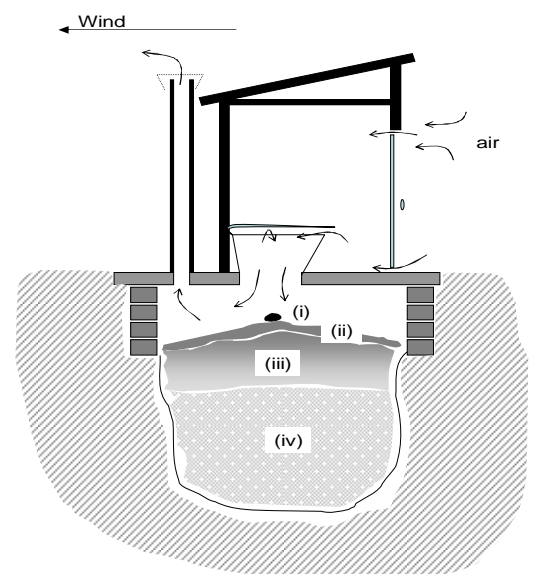

Figure 3.1 Diagram showing the different theoretical layers within a pit latrine. (Buckley et al., 2008)

was a significant decrease in moisture content with increasing depth ($P= 0.05$). The average total moisture content within each pit analyzed was about 60%, this falls within the range reported in literatures (50-60% of the total weight) to be adequate for microbial activity (Peavy et al., 1985; EPA, 1995). Hence, biological activity in most of the pits would not have ceased due to low moisture content. The general trend in the moisture content results for all pits was a decrease from the surface to 1 m depth and little to no further change from 1 m to 1.5 m. On average the mean moisture content at the surface layer of the pit was found to be 77% and at the bottom layer it was found to be 67% as shown in Figure 3.2. In 8 of the pit latrines investigated, the moisture content at the bottom was substantially higher than the moisture content of the 1 m depth sludge samples. These pit latrines may have been located such that the water table was higher than the bottom of the pit.

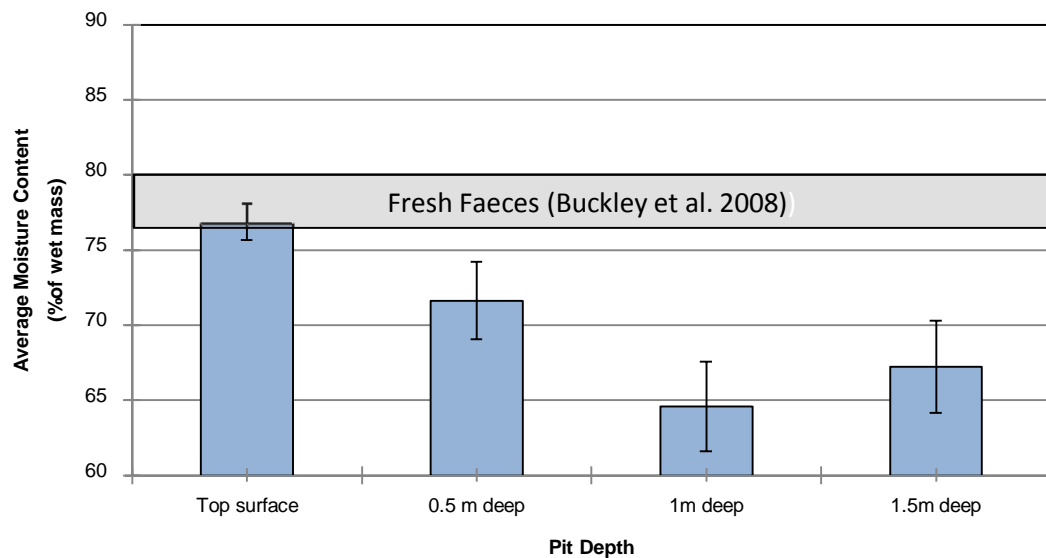

Figure 3.2 The moisture content of pit sludge decreases with time.

The fresh faeces bar indicates the range of concentration of fresh faeces. Error bars indicate 95% confidence intervals on the mean.

Various parameters are used to describe faecal sludge in order to allow comparisons of stability or biodegradability. Chemical Oxygen Demand (COD) gives a measure of the carbonaceous or organic content of faecal sludge (Marais and Ekama, 1984). This can be further divided into biodegradable and unbiodegradable COD. COD indicates the amount of oxygen required to oxidize all the organic matter into carbon dioxide (CO_2) and the extent to which organic matter has been stabilised: the higher the COD, the higher the organic matter content, and the less stable the sludge. Strauss et al. (1997) describe COD levels of 20,000-50,000 mg COD/l for fresh sludge from on-site sanitation systems, < 15,000 mg COD/litre for sludge which has been stored for several years and 500-2,500 mg/litre for municipal wastewater. In this study, two different measures of organic content were obtained; COD was measured and reported in units of gCOD/g dried sample to eliminate dilution effects due to differences in moisture content. Volatile solids were also measured; this is the fraction of a sample of dried sludge that will volatilise when the sample is placed in the furnace at 550°C and is correlated to the amount of organic material present in the sample. The results are presented as volatile solids as % of dried solids. The results of COD and volatile solids analyses are presented in Figure 3.3. These plots demonstrate the reduction of organic content at different levels of the pit as the sludge becomes progressively older indicating that biological stabilisation has occurred.

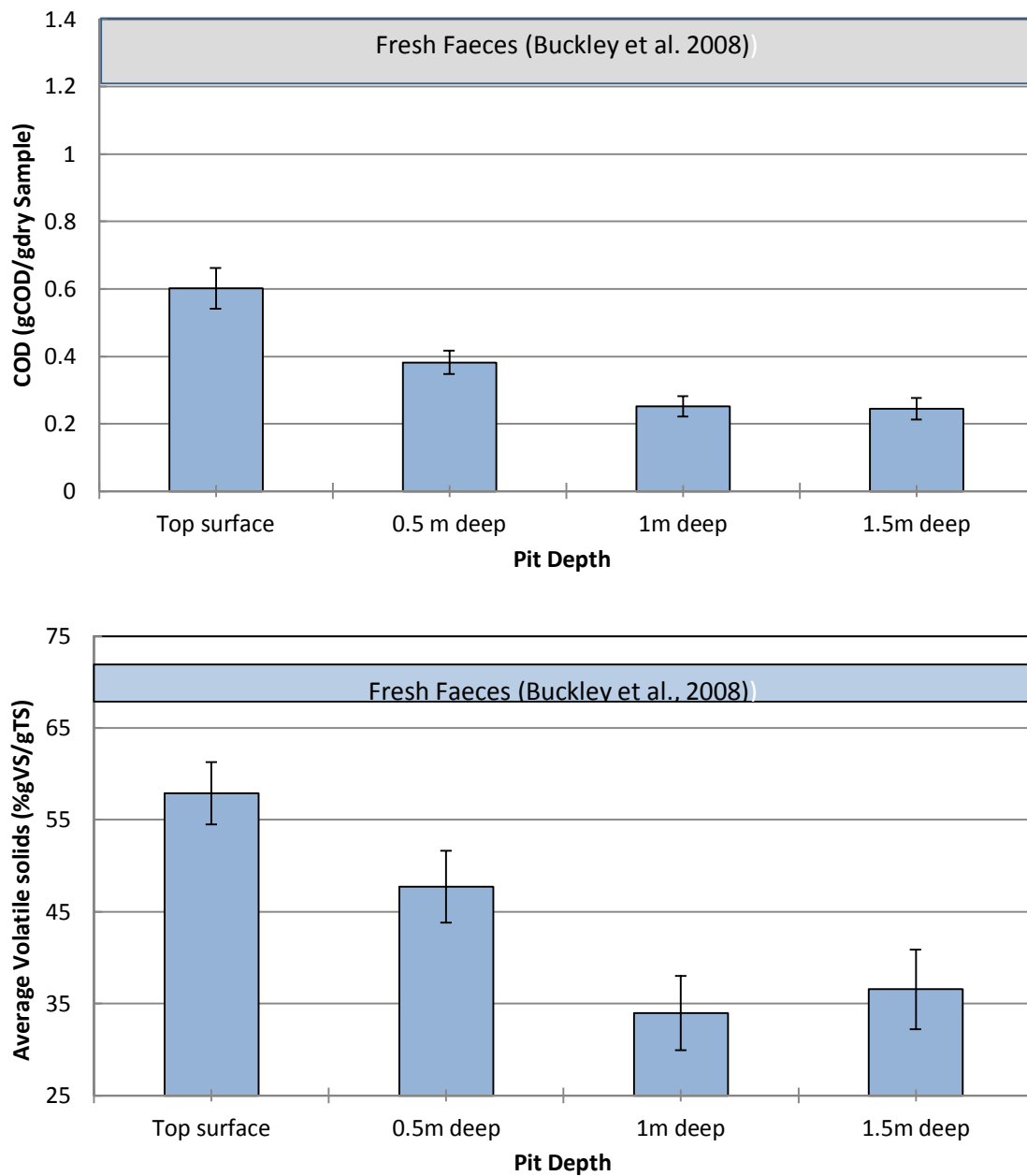

Figure 3.3 The COD and organic (volatile) solids of pit sludge decrease with time

The fresh faeces bar indicates the range of concentration of fresh faeces. Error bars indicate 95% confidence intervals on the mean.

The results of analyses conducted during this study showed that such sludge typically had a 76% moisture content and a COD of 105 mg/g when wet and 445 mg/g when dry (Table 3.1 below).

Table 3.1 Composition of VIP sludge samples

Parameter	Units	Surface	0.5 m depth	1 m depth	1.5 m depth
Moisture	g H ₂ O/g sample %	77 ± 1 [58 , 86]	72 ± 3 [30, 86]	65 ± 3 [31 , 85]	67 ± 3 [35 , 87]
VS	gVS/g dry solids %	58 ± 3 [24, 95]	48 ± 4 [4, 76]	34 ± 4 [5, 74]	37 ± 4 [4, 74]
COD	gCOD/g dry solids	0.60±0.06 [0.10, 1.23]	0.38±0.03 [0.05,0.76]	0.25±0.03 [0.10, 0.59]	0.24±0.03 [0.09,0.49]
Bio-degradability	g biodeg. COD/ g total COD%	52 ± 11 [35, 68]	41 ± 9 [27, 56]	24 ± 8 [7, 44]	17 ± 6 [8, 35]

Data are reported as mean±95% confidence interval [min,max]

Heinss et al. (1997) divide faecal sludge into high (Type A) and low (Type B) strength, the former coming from pour flush and non-flush public latrines and bucket latrines, such as those used in Ghana, and the latter from septic tanks. High strength faecal sludge also usually includes water used for toilet cleansing. Table 3.2 shows a comparison between high and low strength sludge, with figures for pit latrine sludge included for comparative purposes. Heinss et al. (1998) ascribe the low strength of septic tank sludge to its dilution with grey water and its stabilisation over time. Pit latrine sludge shows values for COD and ammonia (NH₄) on a dry matter basis ranging from those comparable with septage to those comparable with fresh faecal sludge found in public toilets and bucket latrines.

Table 3.2 Comparative characteristics of pit sludge, septage and sewage

	Pit latrine sludge	High strength sludge from bucket latrines and public toilets	Low strength sludge from septic tanks	Sewage – in waterborne sewerage systems
Source	Brouckaert and Foxon, 2008	Heinss et al., 1998		
COD(mg/ℓ wet)	90 000-225 000	20 000-50 000	< 10 000	500-2 000
COD(mg/g dry)	210-1230	571-1429	<333	50-200
N as NH ₄ (mg/ℓ wet)	9 000 (TKN)	2 000-5 000	<1 000	30-70
N as NH ₄ (mg/g dry)	100 (TKN)	60-150	<33	3-7
Total solids (%)	20	>3.5	< 3	< 1
Soluble solids(mg/ℓ wet)	220 000	≥30 000	≈ 7 000	200-700

Assumptions to allow comparison of sets of data: Ammonium/TKN fraction in Brouckaert and Foxon 0.8 mgN/mgN Density of sludge in Heinss et al.: 1 kg/ℓ, density of pit latrine sludge in B & F: 1.2 kg/ℓ.

3.1.3 Anal cleansing material

In some cultures (particularly in the Middle East and Asia) water is used for anal cleansing, but in South Africa this practice is not common. For those who use a dry material, toilet paper is not always affordable and as a result waste paper, plastic or rags may be used. Anal cleansing materials other than

toilet paper and water are slow to break down in the pit and therefore increase the rate at which the pit will fill. They also create difficulties for any sort of mechanized pit emptying.

3.1.4 Rubbish

In communities where solid waste collection is not provided by the municipality, the pit latrine is often used for solid waste disposal. From the point of view of householders, this may be the only practical and safe place to dispose of potentially hazardous materials such as disposable nappies, chemicals, broken glass or sharp metal, waste of a personal nature such as pads, tampons and condoms, or material which cannot be burned easily. The drawbacks of using a toilet for solid waste disposal, however, is that it shortens the life of the pit, as most rubbish will not degrade and also can inhibit degradation of other waste, and rubbish in a pit makes it difficult or impossible to empty to the pit with a mechanized technology (Figure 3.4). Because organic matter reduces in volume over time in the pit through degradation while rubbish does not, rubbish represents a higher and higher proportion of the contents of a pit over time. It is estimated that while rubbish represents about 5-10% of the volume entering the pit, by the time the sludge has been in the pit for 10 years rubbish will constitute 25% of the volume. It has been estimated that if the pit is not used for rubbish disposal its life can be extended by about 75% (see Section 3.4.1).



Figure 3.4 The use of the pit latrine for general household solid waste disposal shortens pit life and makes pit emptying by vacuum tanker almost impossible.



Figure 3.5 Where the municipal waste removal service is dysfunctional or non-existent, the use of VIP toilets for waste disposal will be more common. (The sign reads: Msunduzi Municipality. No dumping. Minimum fine R1000)



Figure 3.6 Rubbish removed from a pit during the course of eThekweni pit emptying programme (after the rest of the contents had been washed through into the sewer)

3.1.5 Pathogens

Depending on the health of the users faecal sludge can contain high concentrations of excreted pathogens which include bacteria, viruses, protozoa and helminths. Pathogens which are transmitted by the faecal-oral route and may be found in faeces include:

- Bacteria: Shigella (Bacillary dysentery/Shigellosis), certain strains of E. Coli (Escherichia Coli), salmonella, typhoid and cholera
- Viruses: Rotovirus, Hepatitis A & E
- Protozoa (parasitic): Giardia, Amoeba (Entamoeba Histolytica)
- Helminths (intestinal parasitic worms): e.g. Ascaris lumbricoides (roundworm), Trichuris trichiura (whipworm), Necator americanus and Ancylostoma duodenale (hookworm)

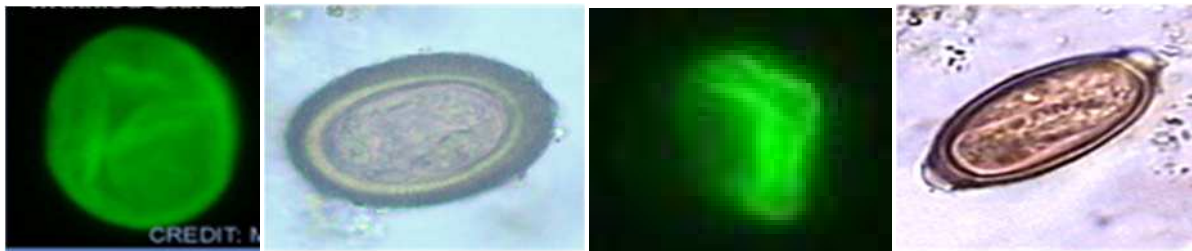

Figure 3.7 Helminths commonly occurring in faecal sludge, from left Giardia; Taenia sp.; Cryptosporidium; Trichuris trichiura

In South Africa, Ascaris, Trichuris and Taenia are the most prevalent parasites infecting humans, with sludge samples extracted from latrines located in densely populated slums often revealing massive parasite loads. An investigation into helminthic and protozoan parasites conducted by the University of KwaZulu-Natal (PRG, 2008) based on samples from VIPs used by 120 households indicated that:

- 10% of samples had neither type of parasite
- 60% had *Ascaris*
- 55% had *Giardia*
- 50% had Trichuris
- 21% had Cryptosporidium
- 11% had Taenia; and
- 60% had either Cryptosporidium or Giardia

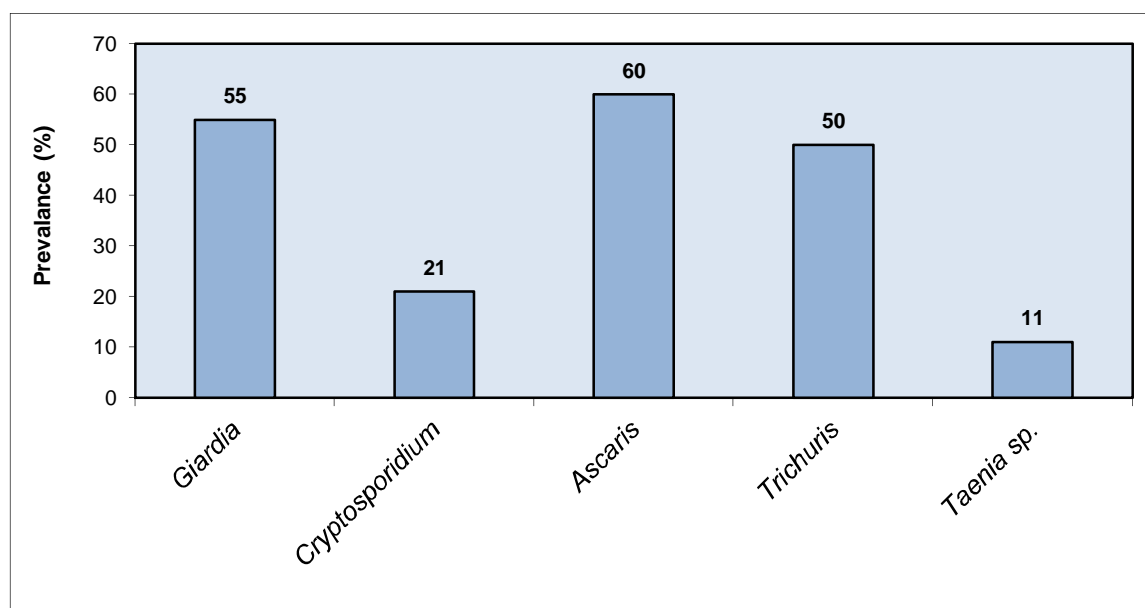

Figure 3.8 Prevalence of helminth and protozoan infections (Pollution Research Group, 2008)

In 2002, IWMI and SANDEC calculated rates for pathogen die-off in faecal sludge. The rates at which various pathogens die off are affected by variables such as ambient temperature – with more rapid die off in warmer climates – and drying, which also promotes more rapid die off.

Table 3.3 Pathogen survival periods in faecal sludge (according to IWMI & SANDEC, 2002)

Organism	Average survival time in wet faecal sludge at ambient temperature (days)	
	Temperate climate (10-15°C)	Tropical climate (20-30°C)
VIRUSES	<100 days	<20 days
BACTERIA:		
salmonellae	<100 days	<30 days
cholera	<30 days	<5 days
faecal coliforms	<150 days	<50 days
PROTOZOA:		
Amoebic cysts	<30 days	<15 days
HELMINTHS:		
Ascaris eggs	2-3 years	10-12 months
Tapeworm eggs	12 months	6 months

Ascaris lumbricoides – the common round worm – is used as a “marker” for safe re-use or disposal of human biological waste because the eggs of this parasite are extremely hardy and outlive most other pathogens (e.g. bacteria and viruses).

In 2007, the Pollution Research Group developed a manual (WRC report TT 322/08) to provide a standard method for the recovery and enumeration of helminth ova from wastewater sludge, compost and urine-diversion waste in order to facilitate the collection of data country-wide on helminths. It was found that because the eggs bond with soil particles, methods previously used may have washed out the eggs with the soil, resulting in a lower apparent prevalence of parasites than actually existed in the sludge before washing. Key to this method is the development of the AMBIC technique, so named

because a solution of Ammonium Bicarbonate is used to dissolve the bond between soil particles and ova. After this “washing” step, the sample is centrifuged to separate the large particles from the parasite eggs and smaller particles, then through flotation and sedimentation the parasite eggs are separated out. Parasites in the processed sample are then identified and counted and classified as undeveloped larvae, motile larvae, immotile larvae, necrotic larvae, and dead or infertile larvae.

Tests done with this method consistently show large counts of live *Ascaris* ova for different sludge ages, with live *Ascaris* eggs even found in sludges that were more than 15 years old. It can therefore be concluded that while survival rates of different pathogens will vary under different conditions, faecal sludge should be considered highly infectious regardless of its age in the pit.

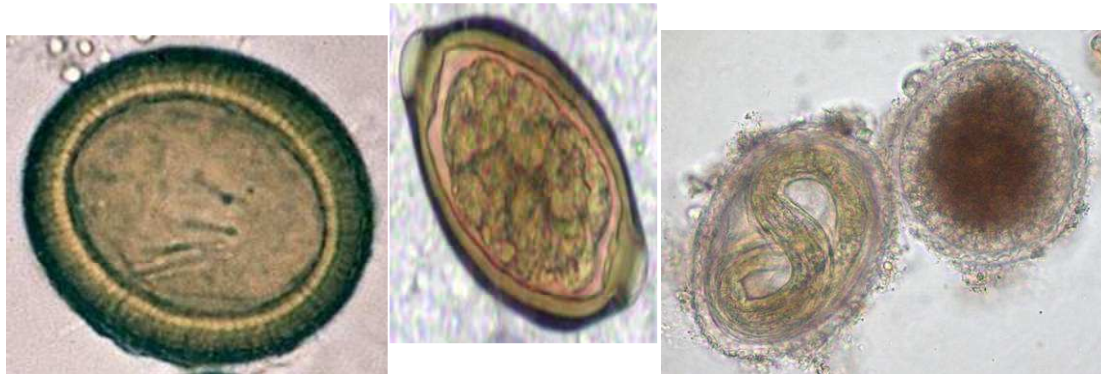

Figure 3.9 Some of the stages of development of *Ascaris* I. in the faecal-oral cycle of transmission (Colleen Archer) Left: The hard shell of the ovum allows it to survive outside a human host; centre: necrotic ovum in the process of dying; right: fertilised egg with motile larva about to hatch.

Study on prevalence of helminth eggs in pit latrines in eThekweni Municipality

As part of this research, the fate of helminth eggs in samples of pit latrine sludge was investigated. The objective was to investigate the effect of age of sludge (or depth in a pit latrine) on helminth egg load. Samples were obtained from 10 pit latrines and 3 different heights within the pit latrine (near the top, near the middle, near the bottom) (Hawksworth et al., 2005). The pit latrines were located in the Bester’s camp area in eThekweni Municipality. It was hypothesised that since different depths in the pit sludge have different ages since excretion (i.e. the age of the sludge increases as you go deeper into the pit), and that helminth eggs deactivate over a period of many years, that there would be a decrease in the number and viability of *Ascaris* eggs with increasing pit depth. In this study, each sample was divided into five 1 g replicates and the AMBIC protocol (Hawksworth et al., 2005) was used to enumerate eggs.

Ascaris eggs were reported as potentially viable (i.e. undeveloped, or containing a motile larva, or containing an immotile but “in good shape” larva), or non-infective (i.e. containing a necrotic larva, or dead, or unfertilized). An egg is recorded as being potentially viable if:

- It is undeveloped, and therefore may at some time in the future develop a larva; or
- Has a fully developed and motile larva. This is the only category that may be regarded as definitely infectious; or
- Has an immotile larva that is not obviously dead.

In the case of an immotile larva, the larva may be alive but dormant, or may have recently died but not yet become necrotic. If it has recently died, this means that it was recently infectious. It is not apparent how long a larva will remain intact after dying before it is obviously necrotic. However, it is hypothesised

that a dead larva will become necrotic within a timespan that is short compared to the length of time an egg may live in pit latrine sludge (e.g. not exceeding a few months). Thus, any egg which contains an intact larva must have been alive and therefore infectious a relatively short time prior to being sampled.

This hypothesis is important for interpreting the *Ascaris* egg data; while only the presence of motile larva in eggs confirms that the sludge tested is definitely infective, the presence of immotile larva indicates that until a short time before sampling (or even after sampling, but before examination under microscope) the sludge was definitely infective.

In terms of health risk assessment, a sludge may be allocated a binary classification as infective or not-infective. Thus, if there are a detectable number of undeveloped ova, ova with motile larvae or ova with immotile larvae per gram of sludge, it may be concluded that the sludge should be treated as infective.

The results for *Ascaris* egg viability for the 10 pits are presented in Figure 3.10.

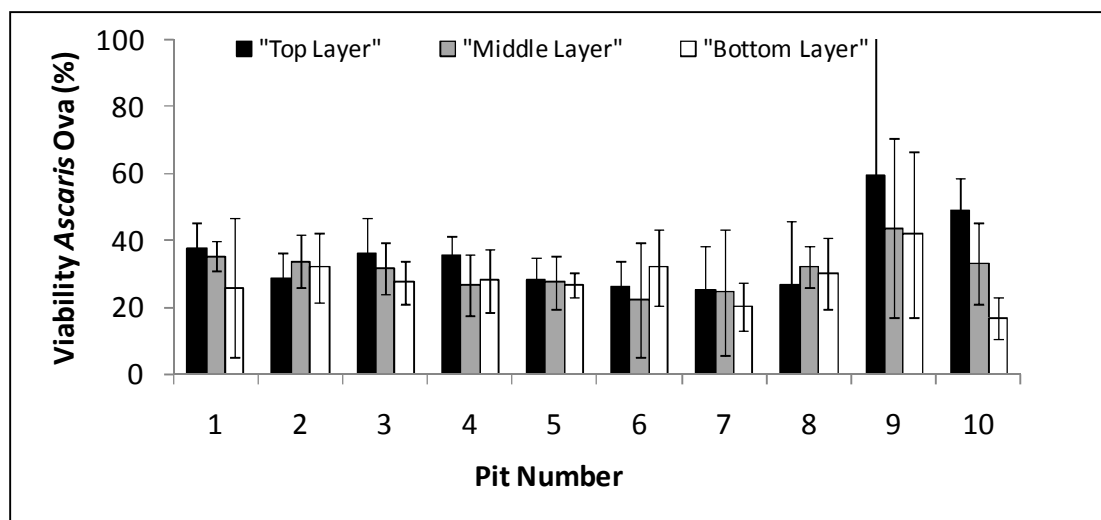

Figure 3.10 *Ascaris* egg viability for top (a), middle (b) and bottom (c) samples from 10 VIP latrines.

Error bars indicate 95% confidence on the mean.

The lowest measured *Ascaris* egg count was 142 per gram of sample (wet weight) (142 eggs/g w.w.) and the largest was 3937 eggs/g w.w. with most of the samples analysed showing a total ovum count of between 200 and 1000 eggs/g w.w.. Of these eggs, the average viability per sample varied between 20 and 40%. The high variance of the measurements (a common characteristic of this kind of measurement) resulted in large confidence intervals.

None of the samples were free from *Ascaris* eggs. The pit sample size was small (only 10 pits, and all from the same community); however, the high load of eggs indicates that ascariasis must have been rife in the community during the time of sampling and for a significant period of time before that. From Figure 3.10, although the mean values of egg count decrease with increasing depth in 6 of the 10 pits, the change is not statistically significant indicating that there is no basis to conclude that there is a relationship between number of eggs or egg viability with pit depth. These results imply that significant deactivation of *Ascaris* eggs **does not** occur during residence in the pit. Nevertheless, it is not only possible, but probable that cross-contamination of samples occurred during the pit emptying process.

In Figure 3.11, the average egg counts and the average viability across all samples within a pit are presented for each pit. Egg viability was around 30%, although significantly higher values were observed for pit 9. Egg counts were generally below 1000 eggs/g w.w., but all samples from all pits had significant numbers of eggs.

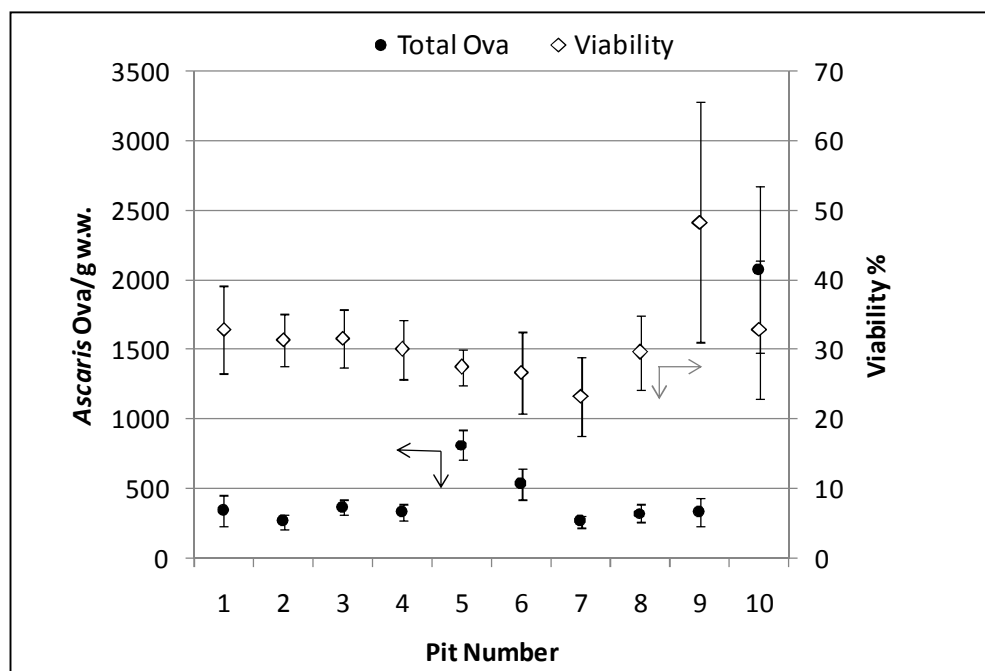

Figure 3.11 *Ascaris* total egg counts (all categories of eggs) and viability (potentially viable/total eggs) for samples collected from 10 pit latrines.

Error bars indicate 95% confidence on the mean.

In addition to *Ascaris* eggs, the AMBIC protocol recovers a range of other helminth eggs. Figure 3.12 presents data for *Taenia* and *Trichuris* prevalence in pit sludge samples. Some of each species were found in almost every sample analysed. Once again, there did not appear to be a difference in prevalence with pit depth for these species.

Figure 3.12 *Taenia* and *Trichuris* prevalence for VIP latrines 1-7 and 9-10.

Error bars indicate 95% confidence on the mean.

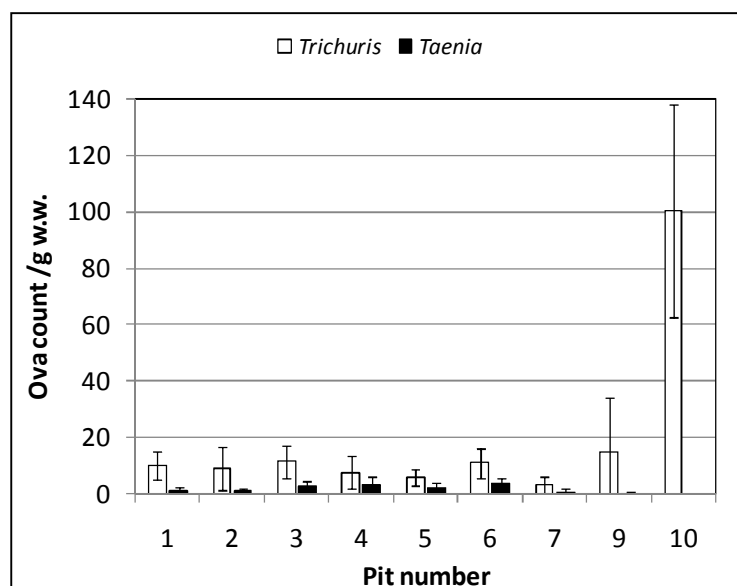

In addition, eggs of *Toxocara* worms (canine or feline roundworm) and *Enterobius vermicularis* (pinworm) were found in samples taken from pit latrine 9.

Taken in their entirety, these results suggest that helminth eggs in pit latrine sludge do not deactivate significantly during their residence in the pit latrine. This is in direct contradiction to the common perception that a period of 2 to 3 years will render pit sludge safe in terms of helminth infectiveness.

This study suggests that in communities where ascariasis is rife, pit sludge should be regarded as containing viable helminth eggs and therefore a health risk.

Impact of pathogens on health

The global priority of providing decent sanitation to all is driven by the high mortality rate among those without sanitation and particularly among children under 5 years of age due to infection by pathogens in faeces which can be dramatically reduced by containment or removal of faeces by means of a toilet. In South Africa, diarrhoeal diseases are the cause of 7.9% of the deaths of children aged 0-4 years. (WHO 2009 in Tronnberg et al., 2010). While infestations by intestinal parasites rarely prove fatal, they contribute to malnutrition, growth retardation and susceptibility to other illnesses. Children, the elderly and others whose immunity is not as strong as that of healthy adults are at greatest risk. A lower nutritional status also makes diarrhoea and vomiting more serious. While healthy adults may not be at as great a risk of dying from some of these diseases, they may lose days of work being sick or caring for sick family members, which in turn has a negative impact on the economy.

Prevention of transmission

While the provision of a toilet is a major step in breaking the faecal-oral transmission of pathogens, a few other factors bear consideration. The cleanliness of toilet facilities is important, particularly in the case of communal toilets where users are at risk of infection from other users. In addition, hand washing with soap after using the toilet is crucial. Again, it is vital that not only households but schools and other communal sanitation providers provide users with soap and water to wash their hands after using the toilet. Individuals who are infected with diseases and capable of transmitting them do not necessarily appear ill. For example, about 75% of people infected with cholera do not develop any symptoms, but the pathogens remain in their faeces for 7 to 14 days and are shed back into the environment, potentially infecting other individuals. Some of these pathogens are able to live on surfaces and in the soil for extended periods of time.

Another factor to bear in mind is the risk of exposure to pathogens when the pit has become full and has to be emptied. Pit emptiers should be in good health, follow a thorough protocol to prevent contact with pathogens – including wearing appropriate protective equipment – and should undergo regular deworming treatment. In addition, it is important that pit emptiers are trained and supervised in following stringent protocols during pit emptying to prevent contamination of household environs with sludge when a pit is emptied. Spilling of sludge as well as contact between contaminated tools, machines, clothing (gloves, boots) and surfaces (soil, walls, taps) can place householders at risk of infection with the pathogens that have been safely contained in the pit, potentially reversing the health benefits they have enjoyed as a result of improved sanitation by exposing them not only to pathogens in their own pit but possibly pathogens from other families' pits that have been serviced by the same team.

The prevalence of parasitic infections in South Africa could be drastically reduced by the local health authorities providing regular deworming treatment to vulnerable groups, especially young children. Such an intervention would be relatively simple and low cost and would significantly reduce the mortality of children and those with compromised immune systems due to diarrhoeal diseases, would improve the health status of the general population and would greatly reduce the risks faced during the emptying of pits. While South Africa was a signatory to the WHO agreement to reduce morbidity due to helminths by 2010, little progress has been made. Providing hygiene education in communities can also play a significant role in encouraging changes in behaviour in order to break the cycle of disease transmission.

3.1.6 Other bacteria and chemicals

In addition to pathogenic bacteria, a significant percentage of faecal sludge is comprised of harmless strains of *E. coli* and other bacteria which populate the human digestive tract and assist with the processing and absorption of food. Some of these bacteria assist with the further decomposition of the faecal material after it has been deposited in the pit. The fresh faeces of a healthy individual contains in the order of 100 000 faecal coliform bacteria per gram, none of which are harmful.

Chemical substances may be added to pits to reduce odours and insect activity or to improve sludge degradation and reduce the rate of filling. Nwaneri et al. (2007) mention that household bleaches and disinfectants such as Jik and Domestos (containing sodium hypochlorite), or Jeyes Fluid are often added to pit latrines to reduce odours. These have known microbiocidal properties, and may inhibit the functions of bacteria active in sludge degradation, and therefore increase the rate of sludge build up. Organophosphates and pyrethroid insecticides may be added to reduce the activity of fly maggots, which will also therefore reduce the rate of sludge break down.

3.2 Sludge accumulation and degradation

The rate at which a pit fills is determined by the interaction between a number of factors. In terms of actual excreta, an individual produces between 0.12 – 0.40 litres of faeces and 0.6 – 1.5 litres of urine per day. Averaged over a year, this amounts to 110 litres of faeces and 440 litres of urine per person per year: a total volume of 550 litres of excreta per person per year. However the number of individuals using a pit may fluctuate throughout the week and over the years, and the volume each person contributes to the pit will be affected by age, diet, whether she or he is away from the home during the day, and a variety of other factors. In addition to excreta, anal cleansing material, and other household waste that is disposed of in the pit, factors such as the design of the system and pit, geophysical factors and the character of the biological activity in the pit affect the rate at which it will fill. In South Africa, the recommended pit size for VIPs is 2 to 3 m³, while in some countries, such as Tanzania, pits may be as large as 10 m³. The amount of water that enters the pit (flushing water, grey water or rain) in combination with the drainage capacity of the pit (affected by the lining of the pit, soil conditions and water table) also influence the filling rate. If pits are extended below the water table, water will tend to drain into, rather than out of, the pits. While higher moisture content may assist the decomposition process in the sludge, flooding of pits can render them unusable and a health hazard.

3.2.1 Aerobic and anaerobic degradation

While matter cannot be created or destroyed, matter that enters the pit can exit the pit through evaporation and transportation of dissolved particles into the surrounding soil, as discussed above, and through the degradation of organic matter by bacteria present in the pit into liquids and gases (primarily methane, carbon dioxide, ammonia and nitrogen) which can then exit the pit. During this process the sludge becomes more stable (less prone to further changes) due to the decrease in organic matter. Given enough time, all *biodegradable* matter in the pit will eventually be converted to inorganic products that are either soluble or gaseous and a small amount of non-degradable organic residue. The soluble and gaseous components will “disappear” from the pit through leaching and gas evolution. As the complex range of degradation processes each depend on particular bacteria, the populations of those bacteria will grow until they are in balance with their environment. As the biodegradable material is depleted, the micro-organisms die and themselves degrade.

Where sludge in the pit has contact with air (oxygen), aerobic digestion takes place. In this process, bacteria dependent on oxygen use the nutrients in sludge and the oxygen available at the sludge surface to respire, converting sludge to biomass (more bacteria) in the pit and to carbon dioxide which then exits the pit. Figure 3.13 illustrates the area where aerobic digestion takes place (blue ring) where the surface of the sludge is in contact with air. If the pit is unlined or has open joints, aerobic digestion may also take place to a limited extent at the sludge/soil interface where bacteria can utilise oxygen found in unsaturated soil.

Anaerobic degradation has a much lower yield of biomass than aerobic processes; for each g COD of substrate consumed, only 0.05 – 0.10 g COD becomes more biomass and the remainder is converted to methane, whereas in the case of aerobic digestion the conversion to bacteria is 0.50 to 0.70 g COD biomass/g COD organics and the remainder is converted to CO₂. With time the biomass thus generated aerobically or anaerobically breaks down and becomes substrate for other bacteria, such that the biodegradable material is all eventually removed. However, the growth of micro-organisms converts a portion of biodegradable organic material to non-degradable organic cell components. These accumulate with time in the pit and do not break down further.

Both aerobic and anaerobic processes will contribute to the breakdown and removal of biodegradable organic matter in pit sludge. It is hypothesised that the greater the contribution of aerobic processes to biodegradation, the more rapidly the material in the pit will stabilise, but because of the relatively higher growth yields that are exhibited during aerobic digestion, the greater will be the amount of non-degradable residue that is generated and eventually accumulates in a pit latrine. This may partially explain why it is reported in the practitioner's literature that wet pit contents (which are predominantly anaerobic due to the occlusion of air by the water content) accumulate more slowly than dry pit latrines.

This concept is presented graphically in Figure 3.14. It is assumed that the material added to a pit latrine has the following characteristics: organic biodegradable content 54.5%; biodegradable bacterial cell mass 28%; organic unbiodegradable content 5%; Inorganic content 12.5%.

Only the first two categories are degradable. If we assume that the aerobic cell yield is 67% on a mass basis and that the generation of unbiodegradable COD as a result of growth is 15%, we land up ultimately with 14.7% of the original mass of material added as unbiodegradable organics. However, if the same feed material undergoes anaerobic digestion with an anaerobic cell yield of 8% on a mass basis and the same unbiodegradables generation factor of 15%, the unbiodegradable organic fraction that accumulates is eventually 10.2% of the original mass added. Thus for only aerobic conversion, the final amount of material remaining after soluble and gaseous components have left the pit is around 27% of the original mass, while the corresponding value for anaerobic digestion is around 21%. In the case of aerobic digestion 73% of the original mass is converted to carbon dioxide, while in anaerobic digestion 79% of the original mass is converted to methane. Note that this is a dramatic simplification of what occurs since the original material may pass through many compounding growth-death-growth-death cycles which have been represented here by a single growth yield for each route and one organic residue generation term.

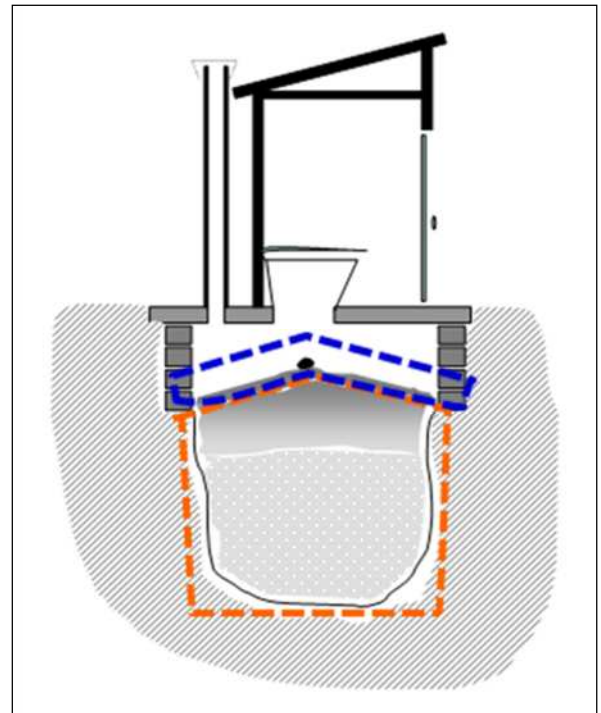

Figure 3.13 Zones of aerobic digestion (blue) and anaerobic digestion (orange) in the pit

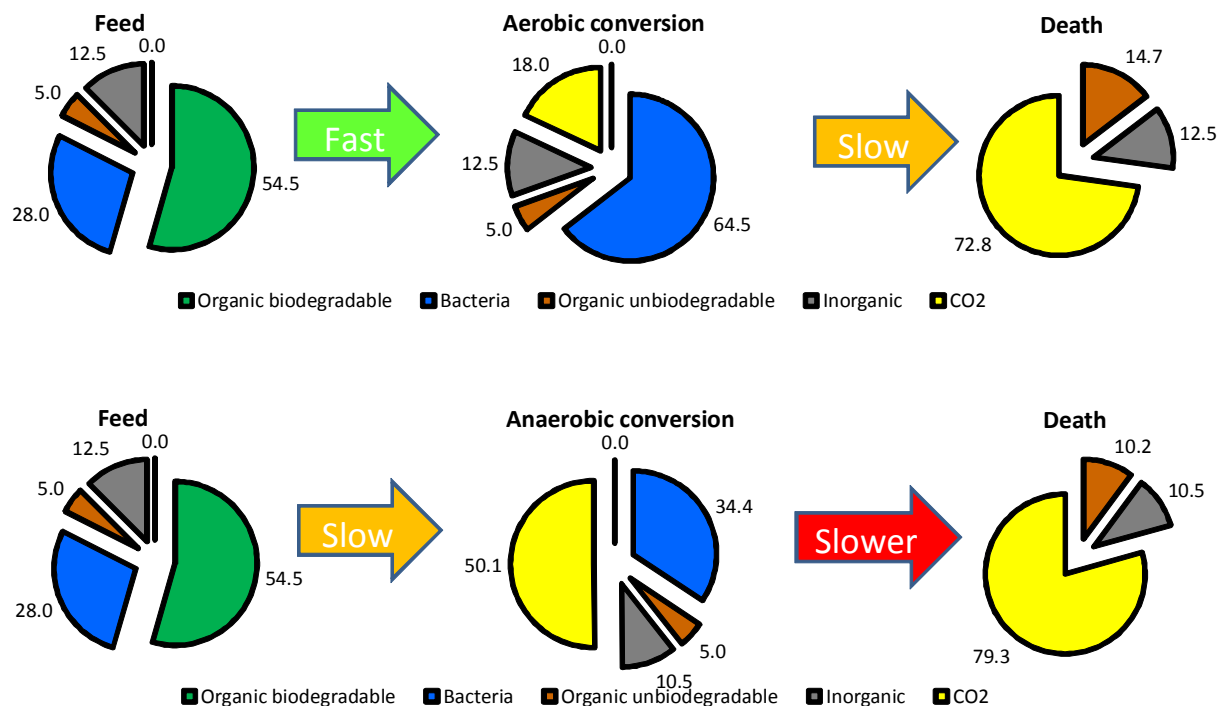

Figure 3.14 Aerobic versus anaerobic conversion

As illustrated in Figure 3.13, the zone of aerobic digestion is much smaller than the anaerobic digestion zone. This means that the bulk of pit contents at any time in pit are anaerobic. However, the much faster aerobic degradation rate on the pit surface may result in a relative contribution of aerobic digestion to the overall stabilisation process that is much larger than the volume ratio of the aerobic zone. Buckley et al. (2008) found that up to 50% of COD may be degraded under predominantly aerobic conditions on the surface of the pit. Further research is currently underway to quantify the rate of autodegradation of faeces on a pit surface.

3.3 Do pit additives work?

There are currently numerous pit additives marketed in South Africa with the claim that they will prevent pits from filling up or reduce the rate at which they fill by enhancing the degradation of sludge. Balboni (2007) describes the various methods by which pit additives are designed to improve sludge degradation and their possible limitations:

- *Microorganisms are added to increase biological activity.* It is claimed that biological activity increases through adding to the number of bacteria already present. However, if the natural increase of the bacteria already in the pit is being inhibited in the pit environment, added microbes will experience the same inhibition. Some pit additives contain aerobic microbes, which can only function on the surface of the pit and therefore cannot have a significant impact on the bulk of the contents.
- *Specific microorganisms are added to improve the efficiency of digestion if a particular stage of the process is being limited through the absence or inhibition of appropriate bacteria.* If a specific bacterium which helped to reduce sludge build up could thrive in the pit, it is highly likely that it would occur there naturally in any case. If it did not occur naturally but would thrive

in the pit, then it would not be necessary to dose the pit more than once (whereas all additives come with instructions to dose at regular intervals).

- *Enzyme addition to increase the rate of hydrolysis/solubilisation of complex organic molecules (lipases, proteases, amylases).* The cost of products that consist of enzymes is very high. They would need to produce a dramatic reduction in sludge accumulation rate to be economically viable. Many of the enzymes that naturally perform these functions are produced naturally by the micro-organisms in the pit. Since enzymes are not self-sustaining, they would be washed out and require replenishing to have any long-term effect.
- *Addition of nutrients, e.g. P, N or C to provide more substrate for bacterial activity.* These nutrients are usually already present in faecal sludges in large quantities, so adding to them does not make sense.
- *Addition of aerobic micro-organisms make the pit more aerobic and therefore degradation occurs faster.* Oxygen is the factor which determines the extent to which the pit is aerobic. This enters from the top of the pit via passive gas exchange and is assisted by the design of the vent pipe for air circulation. Oxygen is only present in significant amounts on the top surface of the pit. It is illogical to suggest that adding micro-organisms that consume oxygen will increase the amount of oxygen present in the pit.

The assumption driving the development of pit additives is that digestion is not already occurring as efficiently as it could be in the pit. However, faecal sludge contains a wide range of naturally occurring bacteria which feed on the nutrients in sludge and it is likely that the process of natural selection would ensure that the bacteria capable of the most efficient digestion of sludge would already be in the pit and would increase in proportion to the available nutrient load. Comparative examples can be found in waste water treatment. When a septic tank or a waste water treatment works is commissioned, no seeding of the plant with appropriate bacteria is needed. The necessary bacteria arrive with the incoming waste stream.

While it may be possible to manipulate the conditions in the pit to optimize bacterial activity, it is impossible for even the optimal bacteria under the optimal conditions to empty a pit completely, as there will always be some matter which cannot be transformed into gases or liquids which can then exit the pit. Aerobic bacteria consume sludge more quickly than anaerobic bacteria but (it is hypothesised) ultimately leave more non-biodegradable mass in the pit.

To date, no research has shown evidence that biological agents added to faecal sludge slowed or reduced the accumulation of mass in a pit. Carter and Byers (2006) cite Redhouse (2001) as finding that the reduction in volume in an additive trial was 5%. He concluded that this was less than that achieved by stirring the contents of the pit to allow trapped gases to escape. Currently, no formal protocol exists in South Africa for testing the effectiveness of pit additives. During the course of this study and previous research with the Water Research Commission, approximately 20 different pit additives have been tested in either the laboratory or the field or both. All trials included blank and reference experiments against which to compare the results of experiments using pit latrine additives. Absolutely no evidence was found to indicate that any of these products reduce the rates at which pits fill. A number of Water Services Authorities in South Africa are nevertheless investing money in pit additives that would otherwise be available for emptying pits because they believe that these products will prevent the need to empty pits or dramatically reduce the rate at which they fill. Budgets reported for pit additives ranged from R13 to R250 per toilet per annum.

Should a pit additive be developed which effectively prevents the accumulation of sludge in pits over time, is affordable and does not introduce other hazards, it will be of immense value. There is an urgent

need for a standardised laboratory test protocol that is able to investigate the efficacy of new products as they are developed under optimised, controlled and repeatable conditions.

3.4 Documented sludge accumulation rates

In a survey conducted for this study investigating the management of VIP toilets (see Annexure A), Water Services Authorities (WSAs) indicated that there were over one million VIPs within their jurisdiction. They estimated that 85% of these are older than 5 years and that most pits need to be emptied every 5 to 9 years.

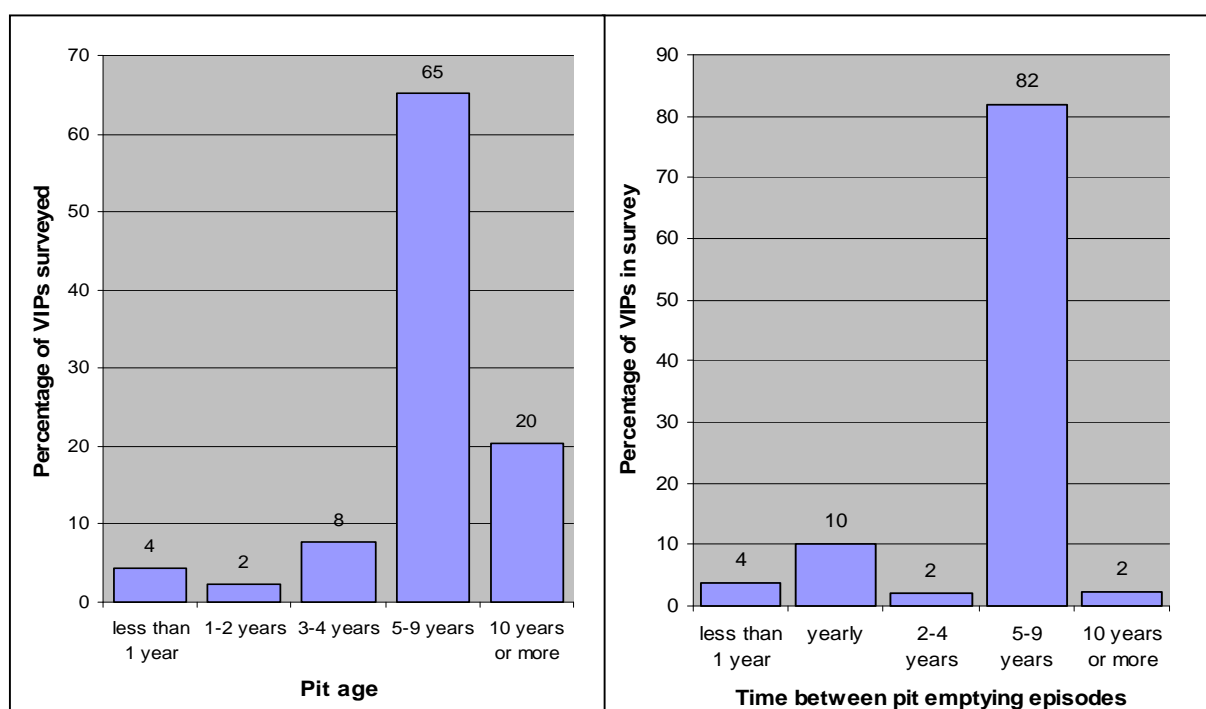

Figure 3.15 Ages and intervals of emptying of pits in South Africa

This suggests that pits are filling up more rapidly than was initially anticipated and that within the next few years WSAs which do not already have a plan, budget or programme in place for emptying pits will find themselves facing a crisis when pits reach capacity. This could result in a situation where households are effectively again without adequate sanitation. To avert such a crisis, WSAs need to be able to accurately predict the rate at which pits will become full and require emptying and rapidly develop the capacity for emptying large numbers of pits. As the factors affecting filling rates are many and complex, it is critical that data for actual observed filling rates are established against which to test any theoretical models.

The literature contains far more data on sludge build up in septic tanks than in pit latrines, with filling rates ranging widely from 22 litres per capita annum ($\ell/c.a$) to 95 $\ell/c.a$. Research conducted by the Water Research Commission shows that in South African conditions the lower end of the range (27 to 37 $\ell/c.a$) is applicable. However, as the sludge in a septic tank retains more moisture than does a dry sanitation system, these studies do not provide a reliable guideline for estimating the filling rates of dry pits.

The literature contains very little data on pit filling rates, however. Using data gathered by the World Health Organisation in the 1950s, Wagner and Lanoix (1958) estimated sludge accumulation at approximately 40 litres per person per year in wet pits and where solid anal cleansing material was used. They recommended that 60 litres per person per year be allowed for dry pits, and up to 50% more if large amounts of solid material (grass, stones, etc.) are used for anal cleansing. A study commissioned by the Water Research Commission (Norris, 2000) estimated the accumulation of sludge in pit latrines at 24 ℓ/ca. At this rate a family of 6 would accumulate 144 litres per annum, and hence a 2.5 m³ pit would last approximately 17 years.

In the course of this research new field studies have been conducted to investigate pit filling rates and the data from these have been analysed with that of a number of earlier studies. The pit filling rates in these studies fell mostly between 200 and 500 litres per annum, suggesting that 40 ℓ/c.a is a good figure to work with for design purposes. Figures of up to 60 ℓ/c.a are not unusual, however, and planning for large scale pit emptying programmes should take the higher figures into account. It was found that the presence of a large volume of rubbish in a pit could increase its filling rate significantly. In other words, the use of pit latrines to manage solid waste is significantly reducing the useful lives of much of our dry on site sanitation infrastructure.

3.4.1 Using filling rates to design pits and emptying programme

In the case where the municipality is to manage the emptying programme (i.e. householders are not responsible for emptying) the desired pit volume can be calculated as follows:

t = Frequency of emptying (assume 5 years)

r = Design filling rate for emptying at a frequency of t (assume 60 ℓ/person.year)

n = Average number of users in household (assume 6 people)

The desired useful pit volume is calculated as

$$V = r \times n \times t$$

For the assumed values,

$$\begin{aligned} V &= 60 \text{ ℓ/person.year} \times 6 \text{ people} \times 5 \text{ years} \\ &= 1\,800 \text{ ℓ} \\ &= 1.8 \text{ m}^3 \end{aligned}$$

Note that a pit typically does not fill evenly, but rather in a heap, so when calculating a pit volume at least the top half metre of the pit height should be discounted. A related consideration is that a pit toilet which is near full is more likely to smell and is more likely to be visually offensive, so the top portion of the pit should be thought of as freeboard.

Thus if the pit is designed to have width and length of 1.0 m and 1.2 m, the depth (d) of the pit should be

$$d = \frac{V}{1.2 \text{ m} \times 1.0 \text{ m}} + 0.5 \text{ m} = \frac{1.8 \text{ m}^3}{1.2 \text{ m} \times 1.0 \text{ m}} + 0.5 \text{ m} = 2 \text{ m}$$

The removal of sludge from pits deeper than 1.5 metres is impossible using manual methods (unless the emptier climbs inside the pit, which is a serious health risk), and difficult using vacuum tankers (due to the high suction pressures involved). For this reason some advocate the use of smaller and shallower

pits which should be emptied more frequently (e.g. every three years) rather than large pits to be emptied less often.

3.4.2 Using a mechanistic model to design pits

During the course of this research, a model was developed to predict sludge accumulation rates based on an understanding of the processes in a pit latrine. The main parameter considered was the percentage of biodegradable material in the VIP (as opposed to sand, ash, solid waste, etc.). The rate of degradation is affected by moisture content, soil porosity, temperature and other influences. Analysis showed that without degradation an average sized pit (2.5 m³) will fill in approximately 7 years, but with degradation the pit will fill in over 25 years. However, in practice about a quarter of the pit volume is composed of unbiodegradable household solid waste. Allowing for this the VIP will fill in about 15 years. The bottom, stabilized material in the VIP reduces to about a quarter of the volume of fresh excreta. Details of this research are published in Volume 2 of this series: *How fast do pit toilets fill up? A scientific understanding of sludge build up and accumulation in pit latrines*

The pit filling model used a constant feed addition rate and a constant degradation rate for the biodegradable components in the pit sludge and was calibrated using data from 2 pit latrines situated within eThekweni Municipality. The predictions were compared to an additional 16 pit latrines. It was clear that the model described the general processes influencing accumulation in the pit latrine well. However the very wide variation in conditions, number of users and user habits and, importantly, the fact that conditions, number of users and user habits may have changed considerably in the period in which the pit was in use meant that the model did not necessarily predict conditions in all pits well. For the same reason, it was concluded that a more sophisticated model would have no additional benefit since it would require detailed information on conditions, number of users and user habits over the life of a pit in order to be able to provide an accurate simulation of pit conditions, and this information is simply not available. This model allows a prediction of the pit filling time for different size pits, different addition rates and different fractions of biodegradable material in a pit, assuming the biodegradation characteristics in the pit are not significantly different to the eThekweni pits used to calibrate the model. Table 3.4 shows the time predicted to fill a pit to within 0.5 m of the top for three different pit sizes (1 m³, 1.5 m³ and 2 m³), three different filling rates (4 people per household, 7 people per household, 12 people per household) and three different rubbish addition rates (low rubbish estimated as 12% unbiodegradable material in feed, medium rubbish estimated as 20% unbiodegradable material in feed and high rubbish at 28% unbiodegradable in the feed). Thus the entry corresponding to the pits examined was for a 2 m³ pit for a household of 7 people with medium rubbish addition.

Table 3.4: Pit filling time [years] for conditions in eThekweni municipality

Pit size [m ³]	Slow addition			Average addition			Fast addition		
	Low rubbish	Med rubbish	High rubbish	Low rubbish	Med rubbish	High rubbish	Low rubbish	Med rubbish	High rubbish
1	16	12	10	7	5	5	3	2	2
1.5	27	21	17	13	10	8	5	4	4
2	38	29	24	19	15*	12	9	7	6

*model calibrated using data for this condition

Using the simple design equation in Section 3.4.1 it was found that the data for the medium rubbish entries corresponded to average filling rates of 18 ℓ per person per year for the slow addition scenario (4 users), 22 ℓ per person per year for the medium addition scenario (7 users) and 30 ℓ per person per year

for the fast addition scenario. These numbers were lower than the general values of 40 ℓ proposed in Section 3.4, but matched the numbers measured during a pit filling rate study in eThekweni which yielded a 95% confidence interval for pit filling rate in the areas studied of 21 ℓ per person per year to 41 ℓ per person per year. Thus the numbers presented in Table 3.4 applied to the conditions found in the eThekweni study. It is likely that the numbers for other regions may be higher due to different user practice, and also slower degradation rates expected at lower ambient temperatures.

This study suggests that a pit filling rate of 40 ℓ per person per year is reasonable, and that designing the emptying cycle for a maximum of 60 ℓ per person per year is conservative, but will ensure that virtually no pits are completely filled during the emptying cycle unless through gross abuse on the part of the users.

4 PIT EMPTYING METHODS

4.1 To empty or not to empty?

As no product currently exists which has demonstrated the ability to convert all material entering the pit into gas, liquid, or dissolved particles which can exit the pit, pits will eventually fill up. The alternatives when that happens are either to empty the pit or to dig a new pit. If there is adequate space on site, the sludge can be buried elsewhere on site so that the original pit and structure can remain in use, or the existing top structure can be moved to a new pit or a new top structure can be built. If there is not space on site, the sludge will have to be removed from the site.

In some communities local government takes responsibility for emptying pits as an integral part of sanitation provision, while in other communities (both in South Africa and elsewhere) local government considers it the responsibility of householders to empty their pits when full. Householders faced with the challenges and risks of removing, transporting and disposing of sludge may be unable or unwilling to empty their pits, with the result that they will effectively be without improved sanitation and will have to either build a new toilet or resort to using a neighbour's toilet or to open defecation. Overflowing pits present a health hazard not only to the owners but to the neighbourhood. Emptying a pit, however, presents risks of exposing households and workers to pathogens which could potentially reverse the critical health benefits gained through improved sanitation. In some places, leaving sludge buried on site may pose risks of groundwater contamination or contamination if the site is dug up further for development on the site or by later occupants who are unaware that sludge is buried on their site. But digging a new pit and moving the top structure is more costly than emptying the existing pit, and even those top structures designed to be moved can be damaged in the process.

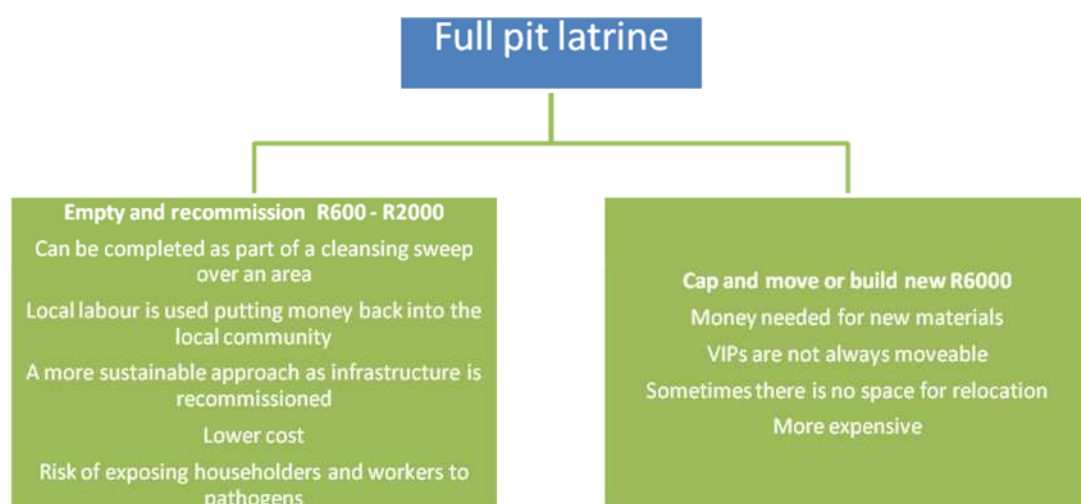

Figure 4.1 Options for managing a full pit: emptying the existing pit versus digging a new pit

4.2 Issues involved with emptying a pit

A number of issues bear consideration when planning to empty a pit. How accessible is the site and the pit for equipment and vehicles? What equipment will be able to effectively remove the sludge and how much will it cost (considering operator costs, capital and operations costs of equipment and filling/emptying frequency of pits)? How will workers and householders be protected from exposure to pathogens during the process of removing sludge from the site? Where will the sludge be disposed of and how much will disposal fees cost? How will sludge be transported to the disposal site and how much will transport cost (taking in to consideration capital and operation costs, distance to site and speed at which transport vehicle can travel)?

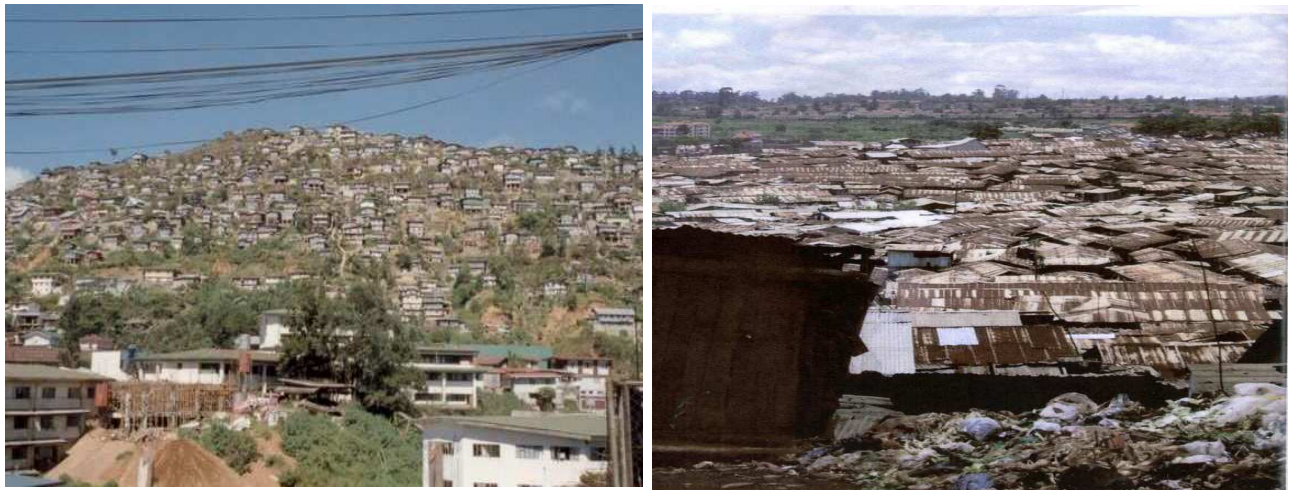

Figure 4.2 Some sites are difficult for a vacuum tanker or truck to access

4.2.1 Consistency of sludge

The consistency of the sludge in the pit is affected by the amount of water added to the pit (by flushing, disposal of grey water, or water used for anal cleansing), the ability of water to leave or enter the pit (determined by pit design, permeability of soil and level of water table relative to the pit) the type of anal cleansing material used, presence of other solid or liquid waste in the pit and diet. The density of sludge increases with decomposition and settlement over time, with waste at the top of the pit mainly water with a specific gravity of 1.0 and at the bottom of the pit with a specific gravity of 1.5 to 2.0. As a result, it is often easy to extract the low density waste from the top of the pit, while the high density sludge which progressively builds up at the bottom becomes increasingly difficult to remove. Technologies relying on suction will tend to block if the sludge is very dry or has a significant component of rubbish. The success of mechanisms using suction to remove sludge will depend also on the density, viscosity and thixotropy of the sludge as well as the static head and pipe friction of the technology. Manual emptying with spades, on the other hand, is not ideal for conditions where the sludge is wet.

Figure 4.3 Some pits are difficult for workers or equipment to access

Here the pit emptiers have had to dig alongside the pit in order to access the sludge through a hole in the wall. Pits should be designed with removable slabs to facilitate access to the sludge.



4.2.2 Selecting an appropriate pit emptying method

A number of factors specific to the site and the sanitation system must be considered when designing or selecting appropriate and effective methods and equipment for emptying:

Effectiveness: How well does this method fit the characteristics of the target sites (access), pits and sludge (does this kind of method/technology work for this kind of sludge)? How well does this method interface with options for transporting the sludge to disposal site?

Safety: What are the risks of workers being exposed to pathogens during emptying by this method? What are the risks of the household environment (ground, tools, taps, etc.) becoming contaminated by pathogens during emptying by this method?

Costs: How much will it cost to empty a pit considering labour and equipment costs (overhead, operations and maintenance), transport and disposal costs and emptying frequency?

Sustainability: Can the equipment used for this method be manufactured and repaired locally? Is it durable enough to stand up under the conditions of abuse or neglect that might realistically be expected in the actual context it will be used? Is it affordable for small entrepreneurs?

4.3 Standard and innovative pit emptying methods and technologies

This section covers standard methods used for emptying pits and a number of innovative methods that have been developed to meet the challenges of pit emptying around the world, some of which are still under development. A number of different methods are currently in use commercially to empty pit latrines. Some of these rely only on manual power with the aid of hand tools, some are semi-mechanized (using manual power transferred through a mechanism) and others are fully mechanized systems which employ power from an engine or motor. This project has involved the development of prototypes for new technologies on all three levels, which are discussed in Section 4.4.

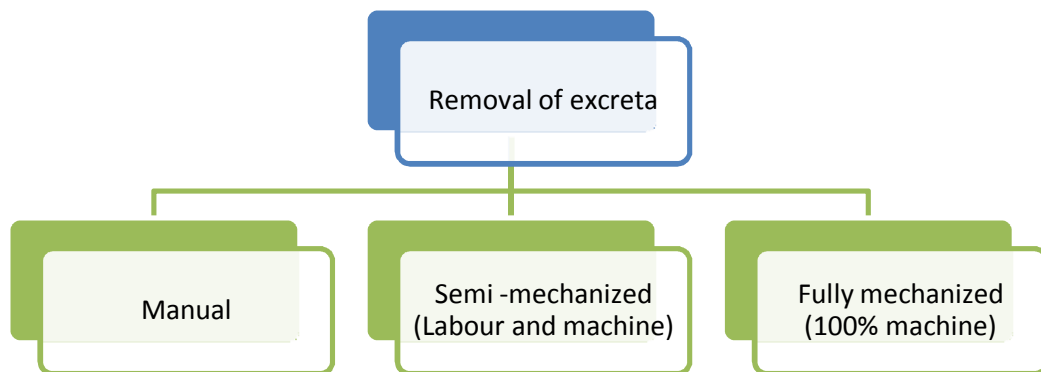

4.3.1 Manual pit emptying

The most basic approach to removing sludge from a pit is to empty it manually with the use of hand tools. One of the many disadvantages of emptying pits manually is the length of time required to empty each pit. While this varies depending on pit size, it can frequently take longer than a day to empty a single pit, resulting in the latrine and disposal hole (if one is being used) being left uncovered overnight, representing an inconvenience and potentially a danger to families.

In East Africa, pits are typically emptied manually with workers in full contact with the sludge. While the job pays well, their health is put at serious risk. In Kibera, Nairobi, pit emptying is very unpopular work. Emptiers often have to work under cover of darkness as householders find it offensive to see the work being done or their waste being carted through the streets. They are expected to cart the waste to the local sewer point, remove rubbish from the sludge and dump the sludge into the sewer. However, this is unpleasant work and if there is not adequate supervision the waste may just be dumped in a nearby open field.



Figure 4.4 Manual pit emptying in Dar es Salaam (Sugden)

The eThekweni latrine emptying programme uses local labour to manually empty latrine pits. Despite the fact that the work is unpleasant, the municipality has not had difficulty sourcing labour as workers are paid relatively well.

Despite the difficulties involved in manual pit emptying, it does have some advantages. It is a method which is very robust. Since it requires many workers, if one is ill work can still continue. In contrast, if a machine is used for emptying and it runs out of fuel or breaks, work grinds to a halt. In addition, manual emptying relies on local labour. This means that funding is spent in the community rather than tied up in expensive machinery and maintenance costs, also making it more feasible for small businesses. This brings additional benefits to the community beyond the emptying of latrines. The benefits however must be balanced against health risks and social acceptance. Figure 4.5 summarizes the positive and negative aspects of manual emptying.

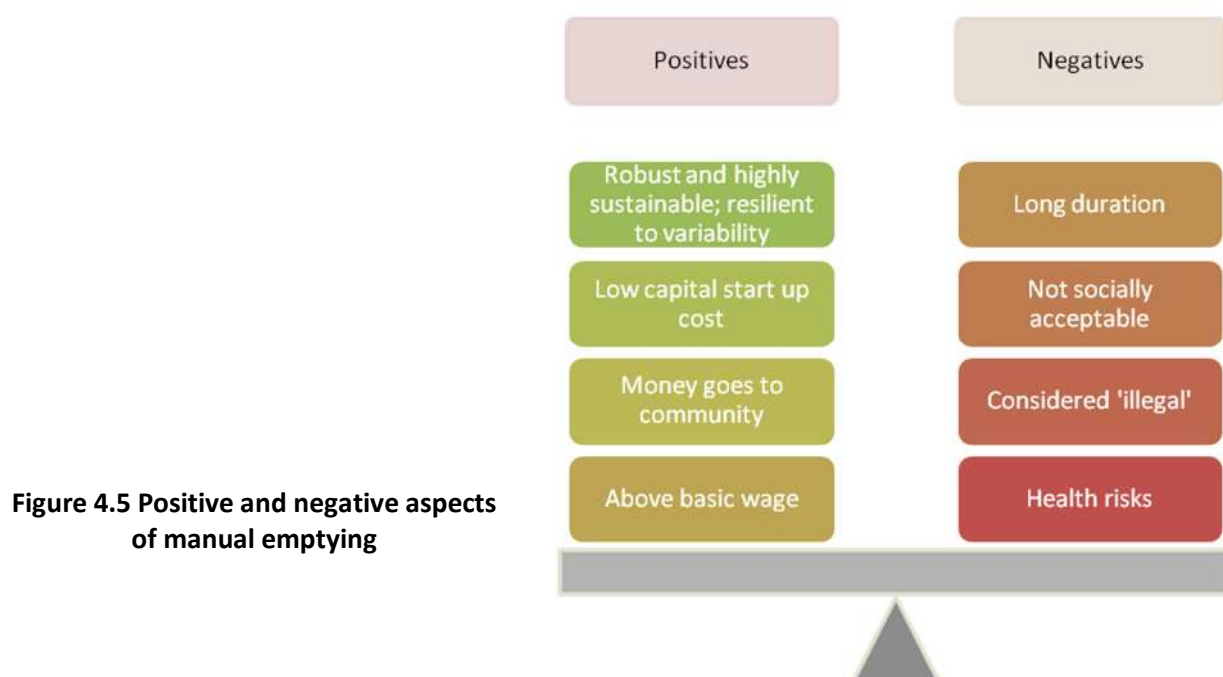

Figure 4.5 Positive and negative aspects of manual emptying

Workers emptying pits manually usually only have access to long handled rakes or spades and are typically exposed to unacceptable levels of pathogens. Tools and equipment designed specifically for manual pit emptying could make their work significantly easier and safer. Steve Sugden, at the London School of Tropical Health, designed the corer, pictured here, to aid manual pit emptying.



Figure 4.6 The corer (Steven Sugden)

❖ Case Study: eThekweni Metropolitan Municipality

In 2005/2006, eThekweni Metropolitan Municipality conducted a pilot study of 500 households with varying types of pits and in varying types of terrain to assess the most cost effective and appropriate methods for removal and disposal of sludge. The study indicated that there were approximately 35000 pit latrines in the municipality and that manual exhaustion would be the most effective method to employ. It was found that during construction of the pits adequate consideration had not been given to ensuring there was a way to access the pit for emptying or the method and costs of emptying. The council approved a plan to empty all of the pits on a five year cycle; if householders requested their pit be emptied more frequently it would be at their own expense. A managing contractor was appointed and all staff were issued with the following protective gear: uniforms, safety steel toe gumboots, gas masks, rubber gloves and hats/hard hats.



Figure 4.7 eThekweni pit emptiers at work



Figure 4.8 Some of the hand tools developed and tested in eThekweni's pit emptying programme. The simpler tools such as long handled forks and spades proved to be more practical. The long handled grab tool pictured above left and centre was too heavy and unwieldy to be popular.

4.3.2 Semi-mechanized emptying

Semi-mechanised tools and mechanisms that have been developed to aid pit emptying use manual power to operate a mechanism that moves the waste. These systems are based on the principles of pumps, augers, belts or chains. Steve Sugden from the NGO Water for People is conducting experimental work on new, low-cost manual pit emptying technologies for removing high density sludge based on existing hand pump technologies based on rope washers, indirect action hand pumps and screw augers.

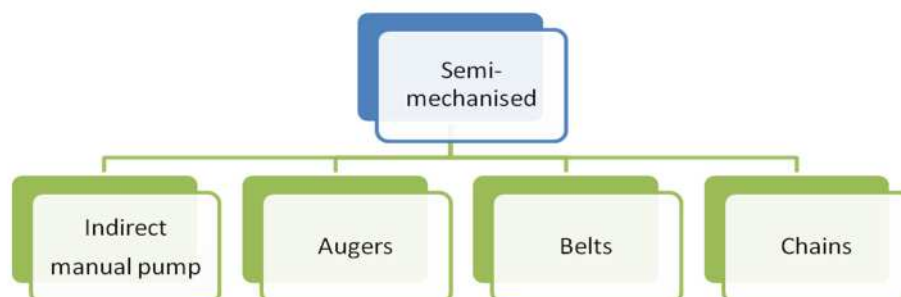

4.3.2.1 Indirect manual pumps

Technologies based on pumping hold potential for emptying pits with relatively liquid sludge.

❖ The MAPET system

The MAPET (Manual Pit-latrines Emptying Technology) system was developed by the Dutch NGO WASTE and was piloted in Dar es Salaam in the early 1990s (Muller and Rijnsburger, 1992).

The MAPET utilised aspects of existing pumping technologies but with parts that were more widely available than those required for standard vacuum or pneumatic technologies. As a human powered technology, the MAPET did not rely on fossil fuels yet could achieve a pumping head of up to 3 metres. It could be pushed along small pathways and remove sludge directly through the pedestal/squatting hole, so that there was no need to dismantle or damage the structure.

Unlike the parts of a vane vacuum pump, wearing parts were fairly low cost items which did not damage the rest of the machine when they failed. It was hoped that the city of Dar es Salaam would ultimately back the project and invest in it, but this never happened and so after the initial set of machines wore out the situation reverted to the status quo ante.

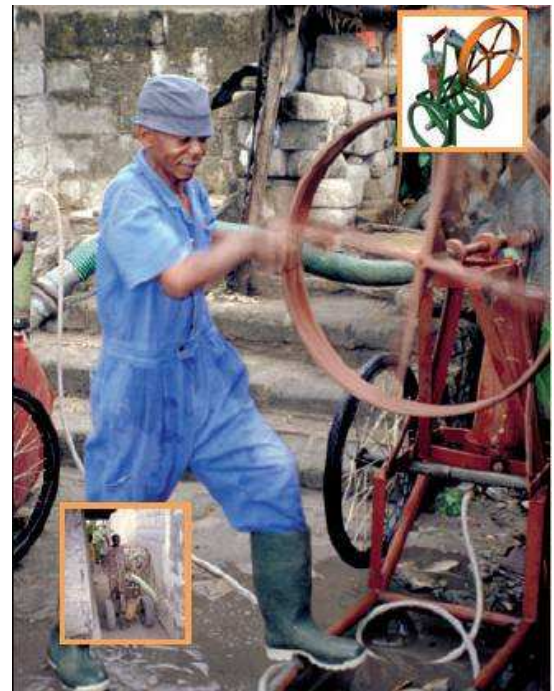

Figure 4.9 The Mapet (WASTE, 2009)

❖ The Gulper

The Gulper (see Figure 4.10) was developed by Steven Sugden of the *London School of Hygiene and Tropical Health* (also working with the NGO *Water for People*), with the aim of developing an emptying technology which was very inexpensive and highly portable. The Gulper was tested in Dar es Salaam where it proved successful with the fairly liquid sludge which is characteristic of latrines in Tanzania. Two men operate the sludge pump by moving a handle on the top of the machine up and down. This handle is connected by a long rod to the foot valve at the bottom of the pump, which is submerged in the sewage sludge. The up and down motion of the foot valve draws waste up the rising pipe and out of the outlet at the top of the pump. The pump is inexpensive, costing as little as \$100. Trials and testing continue in Dar es Salaam, Kampala and Blantyre.



Figure 4.10 The Gulper in action (Steven Sudgen)

The Gulper was modified by the eThekweni Municipality and associated contractors to include a lever action, which makes it easier to operate (see Figure 4.11 below). Initial tests were positive.



Figure 4.11 The Modified Gulper, with lever action added

4.3.2.2 Augers

Augers, or Archimedean spirals, use a screw to lift material through a pipe. While commonly used for post hole boring and other ground drilling tasks, auger-based technologies have potential for removing dry or dense sludge from pits.

❖ **Bangalore Screwer**

The Bangalore Screwer was designed and fabricated by an Indian engineering group. The photos below show the prototype design. This auger was found to be too heavy and unwieldy to be on any practical use for pit emptying.



Figure 4.12 Bangalore screwer

4.3.2.3 Belts

The concept of using flexible belts fitted with claws or grips to lift waste has not yet been explored to see if such a system could be manually driven and if belts in long enough lengths could be sourced at a reasonable price. Figure 4.13 shows an early stage CAD model of one concept using double belts.

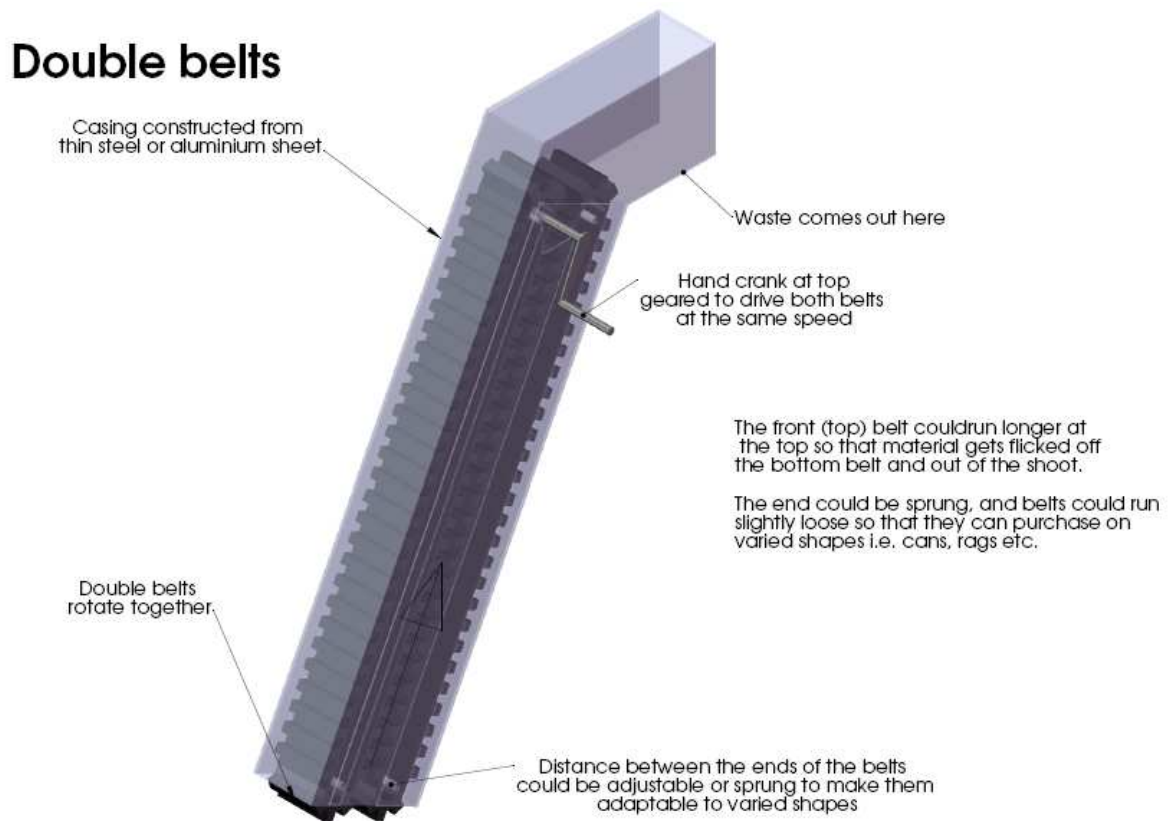

Figure 4.13 Early stage design idea for a double belt design (O’Riordan)

4.3.2.4 Chains

❖ The Nibbler

A second device developed by Steven Sugden is the Nibbler which uses a chain and scoops to draw waste up and out of the pit. A prototype design which uses steel disks welded onto a bicycle chain is shown below.



Figure 4.14 The Nibbler (Steven Sugden)

4.3.3 Mechanised technologies

4.3.3.1 Vacuum tankers and vacuum principles

The technology most commonly used for pit emptying by municipal sanitation departments and local entrepreneurs is the vacuum tanker. Often fleets of these machines will service large areas, extracting waste and carting it to treatment sites. Vacuum tankers are characterised by high capital and maintenance costs. In less industrialised countries long delays in repairs are very common and the cannibalising of broken down vehicles to obtain usable spares may be a regular practice. The typical result is a chronic shortage of tankers.

Vacuum tankers are an effective choice of technology where septic tanks and pit latrines are easily accessible and waste is fairly liquid and not mixed with solid waste. But in unplanned areas, tanker trucks often cannot reach the households which need to be serviced because roads are poor and paths are too narrow. In addition, pits in informal settlements often contain domestic refuse which blocks the vacuum hoses, making the job time consuming and messy. As a result, service providers sometimes limit servicing with a vacuum tanker to planned areas of town.



Figure 4.15 Tankers carried on a truck bed (left, EAWAG) and pulled by a tractor (right, Manus Coffey)

Theoretically, the absolute maximum vacuum that is possible is 1 bar (-10.19 m of water) pressure. However, the vacuum achievable with a new pump is typically 0.8 bar (8.0 m water), and once the pump on a tanker is worn, the vacuum is typically 0.5 bar (5.0 m. water). In comparison, the vacuum that can be achieved on a manually powered device such as the MAPET is 0.3 to 0.4 bar, while the vacuum on a domestic vacuum cleaner is 0.1 to 0.3 bar.

The static head which a vacuum tanker must overcome before it can evacuate a pit is determined by the depth below ground level at which the waste must be accessed from the pit, the position of the entry point of the vacuum hose into the tanker and the height above ground level at which waste is deposited into the tanker. The height of the tanker is therefore critical. As the pit is emptied, three factors combine which reduce the performance of the tanker:

- Waste is sucked from a greater depth
- Height of waste level rises as tanker fills
- The waste density and viscosity of material that is being sucked increases as vacuum reaches lower levels of the pit where settling has occurred

The vacuum performance of the tanker is measured at the truck and determined by suction power (in bars) and airflow (m^3/minute). Extraction inefficiencies such as pipe friction and air losses are not taken into account. In a typical situation, a vacuum truck's performance will be reduced to 0.5 bar (5.0 m water) due to wear. With a density of 1.5 sg for the sludge at the bottom of the pit and the truck filled with sludge to a height of 2.5 m above the sludge level in the pit, the achievable head would be calculated as: $5.0/1.5 = 3.2$ m. The truck's capacity to vacuum, however, would be calculated as: $3.2 - 2.5$ m = only 0.8 m below ground level. (Coffey, 2011)

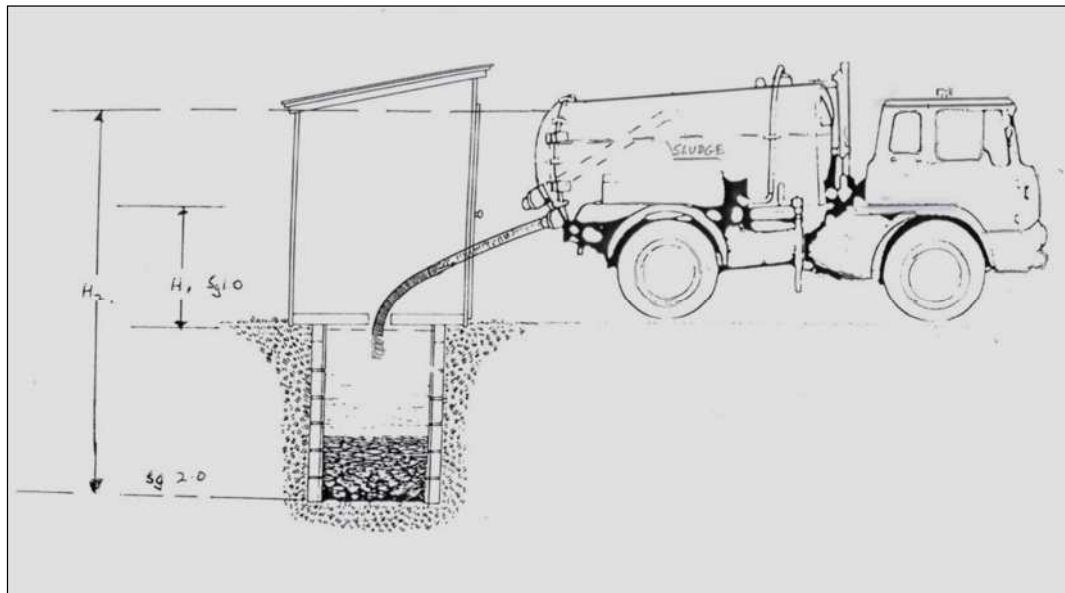

Figure 4.16 This vacuum tanker will need more than six times the vacuum power at the bottom of the pit than at the top (Coffey)

When operating on dense wastes, air can enter the hose and break the flow.

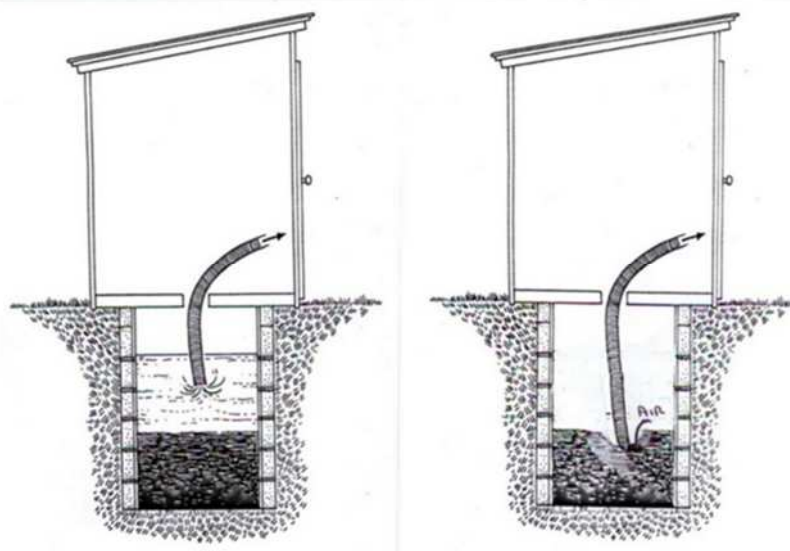

Figure 4.17 Air can enter the hose and break the flow when vacuuming dry sludge (Coffey)

Various approaches can be used to deal with this. With a high vacuum/low airflow approach, the hose is submerged deep under the sludge, and with atmospheric pressure (P_a) acting on the surface forces the sludge along the hose into the holding vacuum tank (at vacuum pressure P_y).

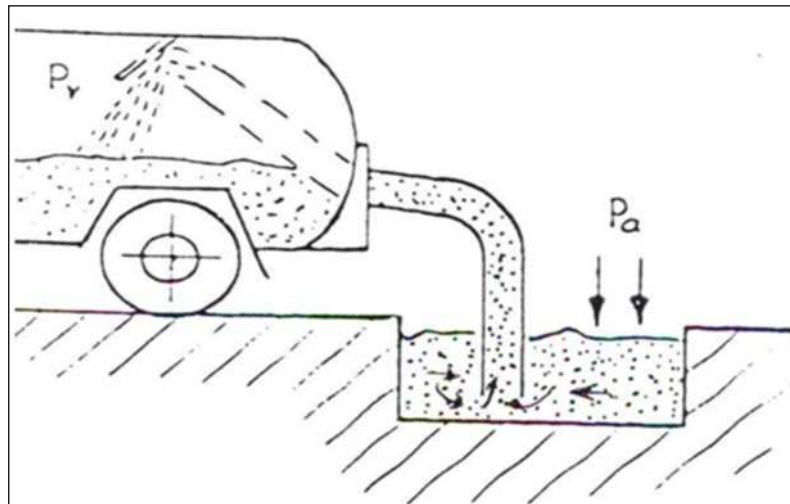

Figure 4.18 High vacuum/ low airflow approach (Coffey)

With a low vacuum/high airflow approach, air is constantly dragged through the system and particles of sludge are suspended in the very high velocity air stream and drawn along the hose into the holding tank, as with a domestic vacuum cleaner.

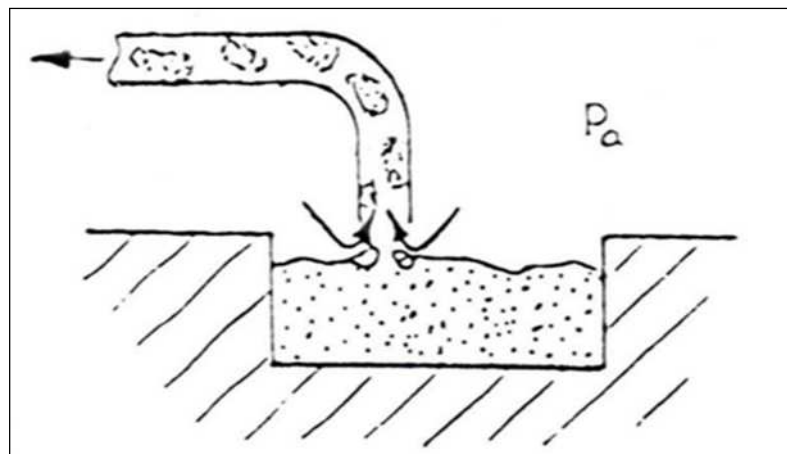

Figure 4.19 Air drag system with a low vacuum/high airflow approach (Coffey)

An air bleed system can also be used, where a pipe is inserted into the sludge. With a combination of high vacuum and medium airflow, the atmospheric pressure (P_a) forces air down the air bleed pipe and thus maintains the airflow necessary for the sludge particles to be suctioned.

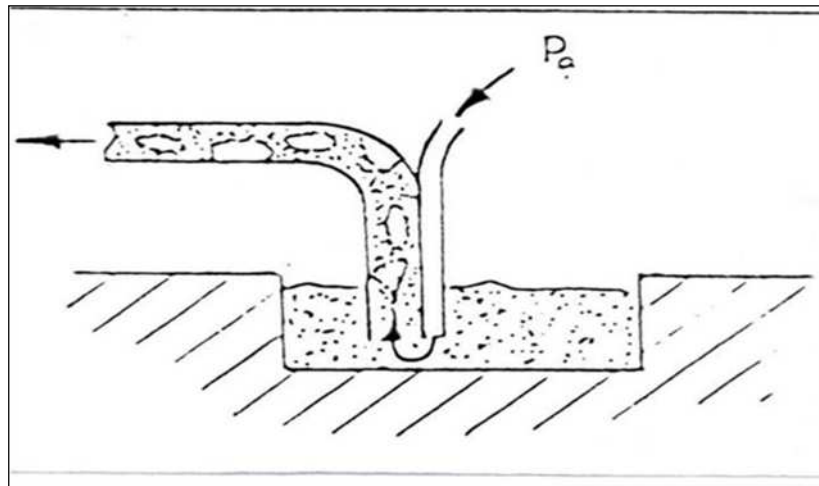

Figure 4.20 Air bleed system (Manus Coffey)

With a plug and gulp system, a combination of high vacuum and medium airflow is used, with an air drag effect obtained by raising and lowering the hose inlet in and out of the sludge. In practice this “plug and gulp” method is widely used by operators emptying denser sludges using vacuum pumps.

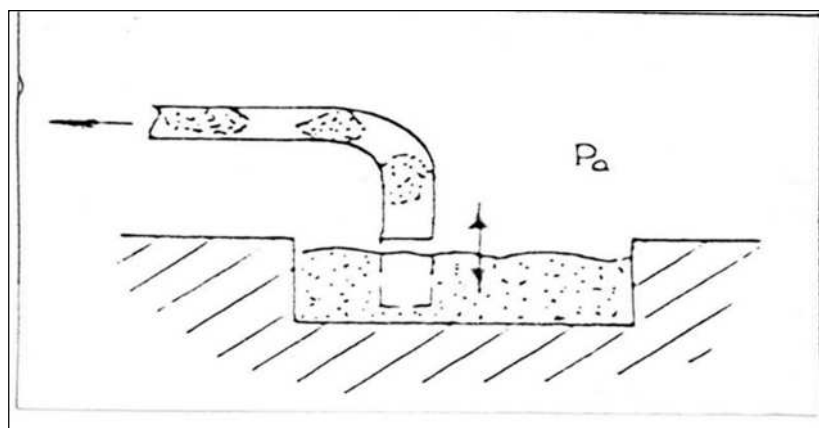

Figure 4.21 Plug and gulp system (Coffey)

❖ Fluidizing pit sludge

When pit sludge is too dense to be effectively removed with a vacuum tanker, a small amount of water and compressed air can be introduced to the pit sludge. This has a surging and mixing action which can fluidize dense wastes and make them suckable. Figure 4.22 shows the results of experimental work done by Jamie Radford on fluidizing synthetic sludge using ± 0.3 bar vacuum/pressure provided by a low cost, high powered domestic vacuum cleaner at a cost of only 10% of that of an engine powered pump. Radford found that the addition of just a few percent by mass of water to a synthetic sludge fundamentally altered the sludge’s shear characteristics, changing it from stiff to workable.

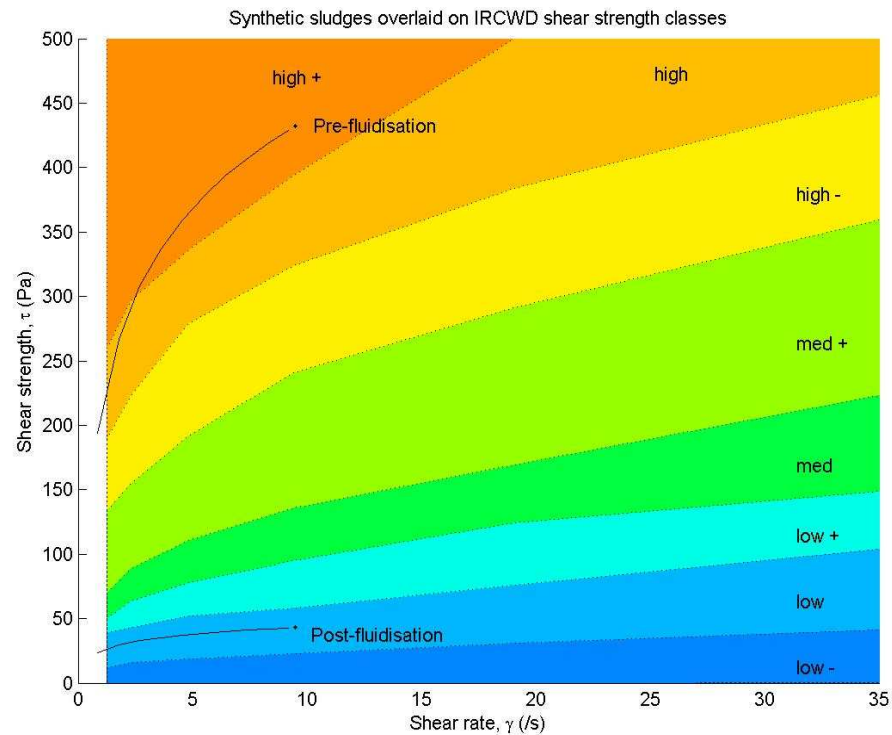

Figure 4.22. Effect of fluidisation on the shear characteristics of synthetic sludges (Radford)

❖ **Pit design to facilitate vacuuming**

Manus Coffey has designed a pit with a built in suction/blowing pipe inserted to the bottom of the pit to enable dense sludges to be removed and for a pit to be emptied from outside the superstructure without spillage. This is illustrated in Figure 4.23 below.

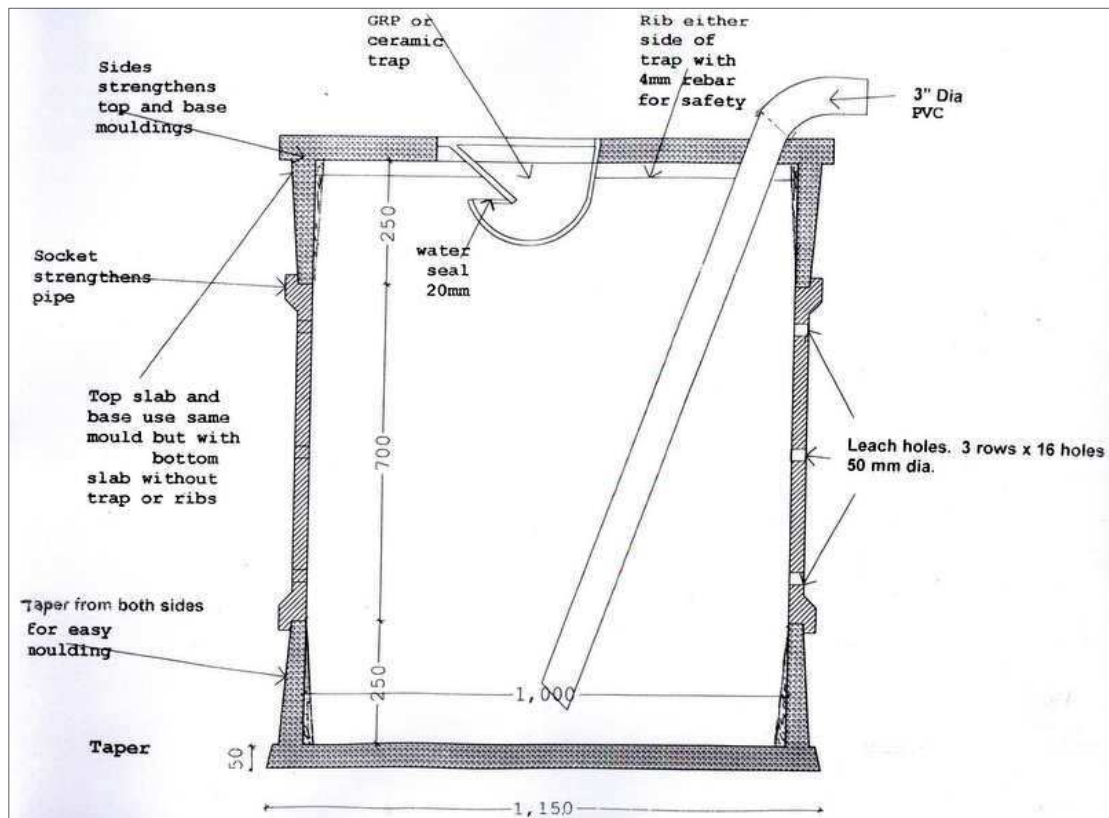

Figure 4.23 Pit designed with built in blow/suck pipe for fluidizing and vacuuming sludge (Coffey)

The following vacuum technologies have been developed for emptying pits in areas where vacuum tankers may not be suitable.

❖ The Micravac

The Micravac is a micro vacuum tanker developed by Manus Coffey for use on uneven roads and areas with poor access.



Figure 4.24 Micravac latrine emptying vehicle (Coffey)

❖ The Dung Beetle

The Dung Beetle uses a two wheel tractor based drive, with the driver sitting on the tank and steering using the long handles on the machine. It was developed by J.Hvidtved Larsen, a Dutch company, and has been used successfully for many years in Ghana.



Figure 4.25 The Dung Beetle
(J.Hvidtved Larsen)

❖ The Vacutug

The Vacutug, developed by UN-HABITAT, uses a steel vacuum tank connected to a sliding vane vacuum pump. A 4.1 kW petrol engine can be connected either to the vacuum pump or a friction roller to drive the front wheels through an adjustable belt drive. Sludge is evacuated from the pit via a vacuum hose and can be discharged under gravity or by slight pressurization of the vacuum tank by the pump.



Figure 4.26 The UN-HABITAT Vacutug (UN-HABITAT)

During initial tests in Kenya, the machine was operated on a commercial basis and during the two year trial period earned a total profit of 36% on its overheads. During 2004, UN-HABITAT partnered with NGOs in twelve different countries for field trials, including the Mvula Trust in South Africa. While the machine worked well, it was difficult to transport from site to site. For this project, the project team tested the Vacutug on pits of low flush systems. The technology proved cost effective, but rubbish even

in the pits of flush toilets proved problematic and time consuming to remove. While the Vacutug can empty a 1 m³ pit in approximately five minutes if no blockages occur, its maximum speed is 5 km/hr. The distance to the disposal site therefore dramatically impacts how many loads it can empty per day. Setting up a transfer station in the vicinity that pits are being emptied will overcome the need to travel long distances.

4.4 Development of new pit emptying technologies

For this project, a number of new technologies were developed and tested with the aim of overcoming the challenges of pit emptying that are found in the South African context. The innovative technologies discussed in Section 4.3 served as the basis for a number of these designs. The full description of the development and testing of these technologies is covered in Volume 3 of this series, titled *The development of pit emptying technologies*.

4.4.1 Aid to manual pit emptying

As part of this project, the possibility of modifying existing tools to produce an enclosed spade in order to aid manual exhaustion was explored. The design concept was that the tool should enable a pit emptier to remain outside of the pit when extracting waste and to increase the rate at which the waste is removed. In addition, the tool should be inexpensive, light weight, easy to operate and have few moving parts.

A pitch fork closes over the mouth of the enclosed spade. The pitch fork is actuated with a reversing mechanism which opens the fork when you push on the handle (put the tool into waste) and closes it when you pull (take the tool out of the waste).



Figure 4.27 Actuation of enclosed spade from open to closed positions

The design was marginally effective at lifting waste. The piercing action of the fork mouth (as opposed to a solid sheet mouth) made the reversing mechanism fairly redundant. Due to the limited success of this design, further development was stopped. The total weight of the tool was far too high due to the steel construction.

4.4.2 The Gobbler

While the Tanzanian context limited design potential for the Nibbler in terms of available parts and technology, South Africa's well developed market for agricultural machinery offered a wider range options. In 2009 the project team began development of the 'Gobbler' – a more robust version of the Nibbler which used agricultural chains.

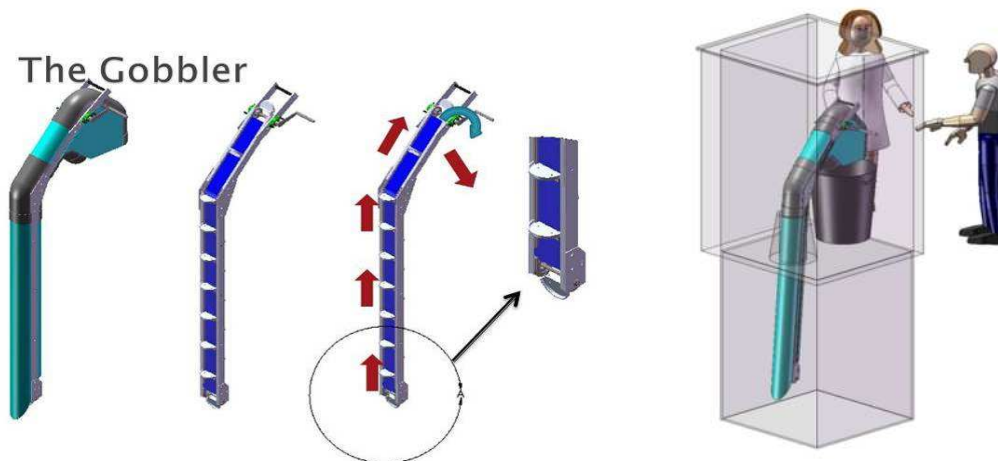

Figure 4.28 Initial design concept for the Gobbler

A 0.125 kW engine drives a chain which lifts scoops through the sludge. A sprung scraper assists with removing the waste to a container near the top of the chain.



Figure 4.29 Prototype of Gobbler with single chain and sprung scraper

While the Gobbler seemed a promising concept on paper, in reality it is awkward and heavy. Moreover the combination of moving parts with pit sludge makes it prone to frequent stoppages. After testing the device with modest success on pig slurry, further development was halted.

4.4.3 Pit screw auger

For this research, a manually powered auger was designed with the aim of producing a device that could be operated by a single person and remove dry waste from a pit through a pedestal and into a container. A post hole drilling auger lifts waste through a PVC pipe. Initially, a manually operated prototype was developed, but cranking speeds required to lift the sludge proved too high for manual operation.



Figure 4.30 Prototype of manual pit screw auger (O’Riordan)

A 1.1 kW motor was added to power the device with an offset gearbox to allow variation in gear ratios. The device is hung from a chain block. Sludge is drawn up by the screw which protrudes 15 cm below the casing, which is hinged to aid cleaning and clearing of blockages. The sludge rises to near the top of the auger where a section of reverse screw auger draws it into a 45 degree tee termination from which it exits through a flexible pipe (Figure 4.31).



Figure 4.31 Motorised pit screw auger

While the Pit Screw Auger (or PSA) seems a promising concept, like the Gobbler it is heavy, awkward, and is not very useful where the faecal waste is combined with other domestic solid waste. It was, however, able to lift a thick pig slurry (comparable to human waste) at a rate of 20 litres per minute. The problem however is that dense pit waste does not flow towards the auger point, with the result that the PSA ends up simply drilling holes in the pit contents. This is therefore not an efficient or cost-effective way to empty a pit toilet.

4.4.4 NanoVac: A light weight vacuum approach

While vacuum pumping is the method of choice for emptying pit latrines and septic tanks, this system can only be used where the pits can be accessed by a vacuum tanker. The Vacutug was an attempt to produce a small vacuum tanker that could reach pits inaccessible to normal tankers. In reality, however, the Vacutug weighed in at over a tonne (empty) and was unstable and hard to move on uneven ground. What is needed is a vacuum pumping technology which is small enough to be carried by two or three people to the emptying site.

The development of the MAPET system (Section 4.3.2.1) proved that piston pumps can achieve the vacuum pressures required for sucking liquid wastes out of latrine pits, creating possibilities for low-cost vacuum technologies which could work in parallel with technologies designed for the extraction of denser pit sludge. The image below illustrates the initial concept for a Nano Vac, based largely on the MAPET system but driven by an internal combustion engine. The objective was to create a vacuum-

based technology that was low cost, compact, easily manoeuvrable and easy to repair and maintain. As integrating exhaustion and carting systems has proven impractical unless on a large scale such as a vacuum tanker, the mechanism needed to discharge directly into a transporting container or suck sludge into a vacuum chamber and then blow it back into the transporting container. Figure 4.32 shows the NanoVac concept.

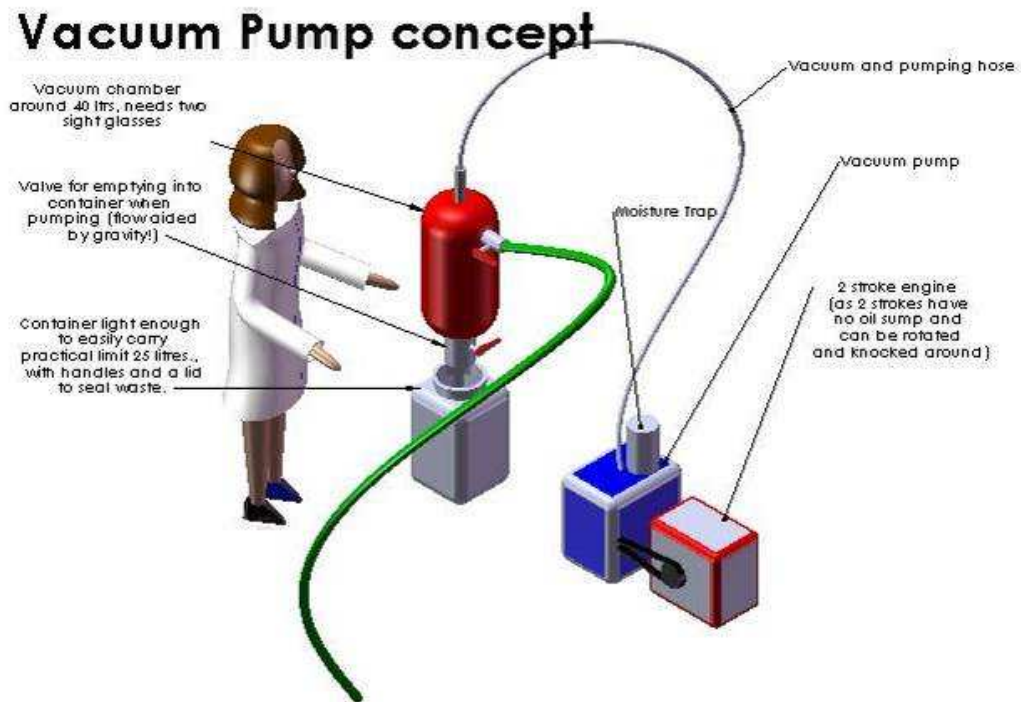

Figure 4.32 The original NanoVac concept. The red container would be alternately filled and emptied

The test rig was modified to take a 5.5 hp internal combustion engine so that it could be used in areas where electricity is not available. A tipping tank was designed using a 48 kg domestic gas canister. The tipping design eliminated the need to rotate the tank, instead allowing it to simply be tipped from one orientation for filling to the other for emptying.



Figure 4.33 Gas canister used as a pressure vessel for the NanoVac

The concept of using a piston as a vacuum pump for sucking waste that is relatively liquid has proven effective with several different arrangements. The prototype of the NanoVac was able to achieve a suction flow rate of $0.076 \text{ m}^3/\text{min}$ and a discharge flow rate of $0.112 \text{ m}^3/\text{min}$.

**Figure 4.34 The NanoVac prototype**

The Nanovac, while moderately successful on fairly liquid sludge, was nevertheless not robust enough to be a serious prospect for long term field trials. Development work then moved on to what was called the eVac, where use was made of a commercially available vane pump driven by an electric motor.

The eVac uses a 1.5 kW electric motor, which can be powered by a portable generator if power is not available on site. The pump and motor were mounted on a custom fabricated steel trolley and connected by a belt drive. The oil supply for the pump was mounted above it, as were the vacuum relief valve and the moisture trap. While the trolley unit weighed a total of 63 kg it proved stable and easily manoeuvrable across rough ground and could be lifted onto a vehicle by two people.

Sludge is collected in 47 ℓ vessels made of rotomoulded Linear Low Density Polyethylene (LLDPE), each weighing 9.6 kg. These vessels are easier to carry and were small enough to allow the waste to be extracted by “plug and gulp”, where the hose is thrust in and out of the sludge. Handles were made using short lengths of webbing held in place by very large diameter pipe clamps.

Two types of lids were designed to enable two alternatives for emptying the vessel: the “suck only” arrangement, in which sludge is sucked in to the vessel and then tipped out of the vessel into a disposal pit, and the “suck and blow”

**Figure 4.35 The eVac**

arrangement, where sludge is sucked into the vessel and then expelled through a second hose.

For the “suck only” arrangement, an interchangeable lid, with the air and sludge lines attached, is used with multiple vessels. Once one vessel is filled the lid is moved to an empty vessel and the full vessel is emptied by tipping it into a disposal pit. The lid is made of 8 mm steel plate with a thinner steel shim around the edge to enable it to sit well on the vessel. There is no attachment to the container, and the lid is held on by the force of the vacuum alone. A foam rubber strip on the underside of the lid improves the seal. The lid weighs 9.6 kg. The air line is connected to a 1” T piece attached to the lid. A 3” steel elbow connects the sludge hose to the container. The primary float valve is attached to the inside of the lid.



Figure 4.36 The “suck only” arrangement (left) where a removable lid is used for multiple vessels and the “suck and blow” arrangement (right) which uses a single vessel and lid

When working with the eVac in the suck and blow configuration, only one container is used. Rather than have an interchangeable lid which is moved between containers the lid is bolted onto the container, only to be removed for maintenance or in exceptional circumstances. This allows the container to withstand positive pressure as well as a vacuum. The container requires two air hoses: one for vacuum and one for pressure. These hoses both pass through three-way valves before entering the container. On each of the valves one side is open to atmospheric pressure and the other to a steel “T” which joins the container. The sludge inlet pipe is connected to the lid, while the sludge outlet layflat pipe is connected through an attachment at the bottom of the container. The total weight of the container is 27 kg, meaning that it can be carried by one person. As it does not need to be moved once in position its weight does not pose a problem.

The fibre glass pressure vessel developed for the NanoVac can be used for injecting water into the sludge to fluidize it. An air lance attached to the hose enabled air to be injected into the sludge to aid removal.

The eVac proved effective and efficient in the removal of relatively wet sludge which did not have a high rubbish content. It is the most promising of the small scale pit emptying technologies developed by the project team thus far.



Figure 4.37 eVac emptying a pit using multiple pressure vessels with carrying handles



Figure 4.38 Air/water lance

4.4.5 Conclusions drawn on vacuum based approaches

While vacuum-based technologies are the most widely used mechanised systems for emptying pits, the performance of any vacuum-based system is affected by the height to which sludge must be pumped into the tank, the depth, density and viscosity of the waste in the pit and the length and inside surfacing of the suction hoses. A suction system has advantages compared to other systems (such as augers, bucket systems and piston pumps) when the following constraints on pit latrine emptying are considered:

- With the mixed and variable solid characteristics, moisture content and abrasiveness of pit contents, a vacuum system works better than a system which requires sludge to pass through the pump mechanism. Diaphragm pumps can be used to extract the more liquid sludge from storage tanks but require frequent maintenance due to blockages by rubbish.
- At sites where access to both the housing plot and to pit contents is difficult, a vacuum system can be used with the main tank and power source up to 50 metres away.
- A vacuum system (as long as the pipes remain unblocked) allows contact with sludge during emptying to be more easily prevented.
- A vacuum system (as long as the pipes remain unblocked) overcomes social nuisances associated with pit emptying such as odour and fly nuisance.

In trials of various vacuum based machines, Manus Coffey and Associates found that sludge that is less than a year old is generally easy to remove by suction (Coffey, pers. comm.). Sludge that is more than two years old is often too dry and dense to be removed by suction. Attempts to fluidize older sludge by adding water to the top were unsuccessful as the water simply floated at the top. Because vacuum tanker operators often cannot remove the densest sludge from the bottom of the pit, it builds up, reducing the volume of the pit over time. This is exacerbated when householders cannot afford to have their large pits emptied completely and only have the top, lower density waste removed. These findings have resulted in design work by UN-HABITAT to develop an inexpensive concrete pit with a two year holding capacity with a built-in suction hose which would allow sludge at the bottom of pits to be removed first, preventing build up. Water could also be pumped into this hose to fluidize sludge from the bottom.

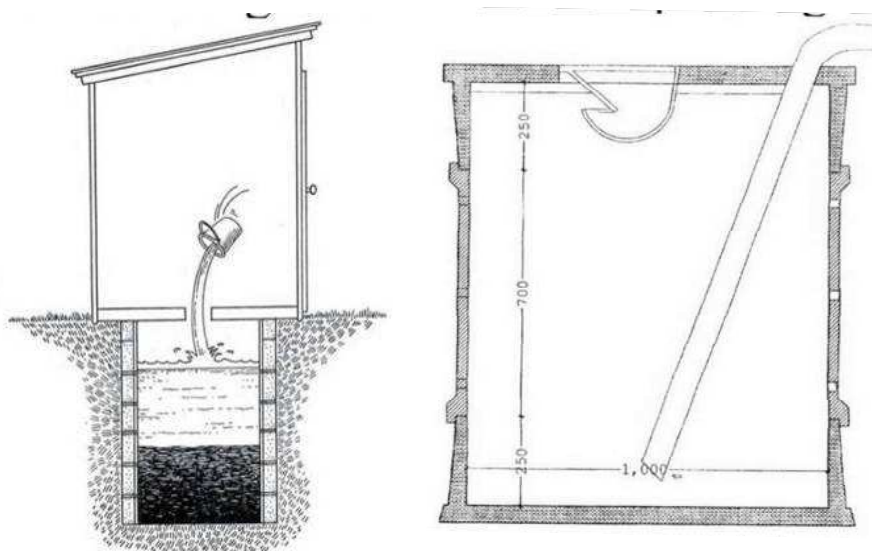

Figure 4.39 Water added to the sludge from above cannot adequately fluidize denser sludge at the bottom of the pit (left); Coffey suggests that a pre-cast concrete pit design with integrated suction hose may overcome this problem (right)

A number of benefits could be gained by designing pits for mechanised emptying:

- Reduced health risks to householders and operators compared to placing the suction hose through the pit seat which results in contamination of the area around the toilet
- Faster emptying/clean-up
- Bi-annual emptying to the level of the hose and fluidizing through the hose will prevent build-up that reduces capacity
- Risk of collapse of pit in unstable soils is eliminated
- Smaller pit design can be used in shallow soil and areas with high water table

The largest emptying contractor in Accra (Larsen Ghana) has initiated a pilot trial, replacing their pan latrines with fibre glass boxes. These boxes were fitted with a connection that allows Dung Beetles (or other vacuum tankers) to directly couple in and empty the storage boxes. This proved to be a successful and low cost method of retrofitting the UN-HABITAT modification to pit latrines.

4.5 Protecting workers and households from exposure to pathogens during pit emptying

As discussed in Section 3.1.4, sludge typically contains numerous bacteria, viruses and parasites which can infect any person who comes into contact with them, compromising their health and even threatening their lives. The provision of toilets to contain faeces dramatically reduces this risk for illnesses and infant mortality. But if workers come into contact with sludge during pit emptying, or boots or equipment that have touched sludge are allowed to contaminate household surfaces, these benefits can be lost. Pathogens can infect a person through surface contact and can also become airborne during pit emptying. The eggs of some parasites may be able to remain alive on household surfaces, clothing or equipment for a very long time – even years – meaning that the risk of infection can continue long after the pit emptying is complete.

It is essential, therefore, that pit emptiers place barriers between themselves and the sludge /air during emptying. Barriers include protective clothing, boots, masks and gloves. The Pollution Research Group (UKZN) found parasite eggs embedded in the standard masks worn by pit workers. Sludge often does not appear dangerous or even smell very offensive, and as workers struggle with the challenges of emptying pits and operating equipment, often in hot and uncomfortable conditions, they may remove protective gear at times to work more efficiently and comfortably. While removing contaminated clothing or handling contaminated equipment with their bare hands, they could come into contact with pathogens. It is important, therefore, that before beginning work as a pit emptier an employee is thoroughly educated about the pathogens found in sludge, routes of transmission/infection, implications of infection and protocol for preventing transmission. Some of the issues which protocols should address are:

- Order of putting on/removing contaminated protective gear
- Situations where equipment cannot be coupled/decoupled while wearing gloves
- Accidents where hands, face or clothing come into direct contact with sludge

- Safe transport and cleaning of clothing, boots, bins, tools and equipment in order to prevent contamination of walkways and vehicles and to prevent workers from carrying pathogens home on their clothing
- Provision of immunizations and 6 monthly deworming treatments for all workers



Figure 4.40 Some of the protective gear issued by eThekweni Municipality to pit emptiers

It is equally important that pit emptiers be trained to protect the household environment of the families whose pits they empty. Protocols should ensure that:

- The work area is protected with tarpaulins (with care taken so that the contaminated side of the tarpaulin is not placed face down, thereby contaminating the grass/soil) to prevent sludge spilling or leaking onto the site. Tools, bins and equipment must never be placed directly on the site without a barrier.
- Workers have a clear and effective procedure to follow should they contaminate the site in any way.
- Pit emptiers do not walk on or off site in contaminated boots, or touch surfaces – including taps, walls, doorknobs – with protective gloves or contaminated hands.
- Workers do not wash contaminated hands, boots, clothes or tools at the household tap (which is often the family's only water source and so is effectively the kitchen sink). Water for washing should be brought with them and washing of hands/equipment should be done over the pit so prevent contamination of soil.
- Workers do not use tools or equipment belonging to the household to aid pit emptying.
- Sludge burial sites, and any areas where contamination has occurred, are clearly demarcated with stakes and tapes. The pit emptying team should ensure that a responsible member of the household has been informed of where the sludge has been buried, that it should not be disturbed (playing, planting, burying, building), what measures were taken if contamination occurred and what to do to avoid infection. Provide the householder with a contact number

should any questions or problems arise around the emptied pit, buried sludge or site contamination.

As contamination of households can occur very easily and without the awareness of the pit emptiers, householders could also be provided with deworming tablets to be taken after their pit has been emptied. The pit emptying team could also stress to the householders the importance of handwashing with soap and seeking medical treatment immediately for a child under the age of 5 who experiences diarrhoea, in order to reduce the transmission and danger of pathogen-related diseases in the family.

5 TRANSFERRING SLUDGE TO A PLACE OF DISPOSAL

A wide variety of vehicles and systems are used throughout the world to transport sludge to the place of disposal. Carts and vehicles may be pushed or pedalled by human, animal or engine power. The system used to remove sludge from the pit may be integrated with the transportation system. The pit emptying technology may be mounted onto a transporting vehicle or may be combined with a specially developed drive system. These vehicles often travel at a lower speed, however, reducing the efficiency of pit emptying. In addition, such a system does not allow pit emptying to continue while the sludge that has already been emptied is transported by a separate means for disposal. Separating extraction and carting into distinct systems permits exhaustion into one tank while another tank is being transported to the disposal site. Integrated systems may also be required to pass road worthy tests and assessments, which can add to their costs quite significantly. In addition, it is essential that spare parts and servicing be available for a carting system. Spare parts for integrated systems would be difficult to source in most countries. Using local road worthy pick-up trucks or other vehicles to cart waste would avoid some of these potential problems.

5.1 Manual carting

The most basic way that waste is carted is for people to simply carry containers of waste from the latrines to the disposal site. The degree to which this is accepted socially varies from country to country. In South Africa it is possible to find people willing to carry drums of sludge if they are paid adequately. In Kenya, however, there is a stigma associated with removal and handling of human waste and so often it is necessary to work at night to avoid provoking public outrage. Waste is also transported on carts pushed by humans or drawn by animals.

In eThekweni Municipality, sludge is often buried on site. If it has to be disposed of elsewhere however, half-filled drums are transported with a drumbarrow to the nearest point which can be accessed by the transport vehicle.



Figure 5.1 eThekweni pit emptiers cart sludge with a drumbarrow to the closest vehicle access point

5.2 Mechanised carting

Where sludge has to be transported long distances for disposal, mechanized carting is necessary.

5.2.1 The UN-HABITAT two wheeled tractor

In conjunction with the Vacutug program, UN-HABITAT has researched ways of transporting solid waste out of urban settlements with the aim of producing an inexpensive machine able to access these areas. A Chinese tiller (two wheeled tractor) manufactured in Kenya is attached to a back axle supporting a load bed. It is able to cart 0.6 tonnes of waste and has a top speed of 25 kph.



Figure 5.2 Chinese two-wheeled tractor used for solid waste collection (UN-HABITAT)

5.2.2 The trike

Steven Sugden has been developing a low cost manual option for pit exhaustion and sludge transport for use in areas of Dar es Salaam. A locally procured motor-trike was modified to carry the Gulper and the bins for carting the waste. The vehicle was sized to carry the waste from one typical latrine pit (Sugden, pers. comm.)



Figure 5.3 The trike in use in Dar Es Salaam (Steven Sugden)

This represents a faecal waste management system which combines manual extraction, manual carting and mechanized hauling (see Figure 5.4).

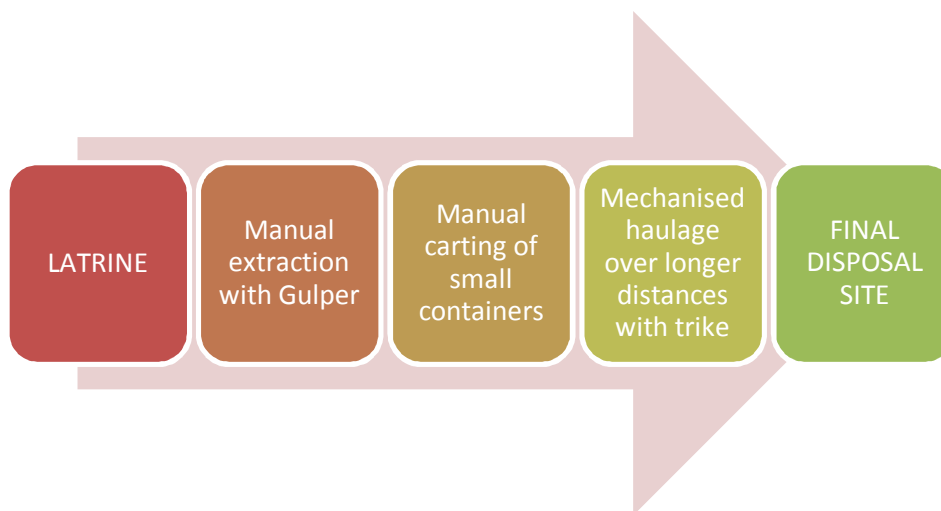

Figure 5.4 System for sludge removal and transport developed by Steven Sugden

5.2.3 The Maquineta in Maputo

At the beginning of the field trials of the Vacutug in Maputo it became clear that due to the high demand for emptying and the long haul distances between latrines and disposal sites a superior transfer option was needed. Medecins Sans Frontieres, the Vacutug project partner in Mozambique, designed the Maquineta; a 1.5 m³ transfer tank pulled by a 2-wheeled tractor. It could either service latrines directly using a small suction pump or accompany the Vacutug and be used as a mini transfer point.

The exhausted sludge would then be transported to the 15 000 litre transfer tank at the *Associacao de Desentralisemento de Agua & Saneamento d Bairro de Urbanizacao* (ASASBU). From there the sludge would be hauled another 5 km to the treatment works by one of the municipality’s vacuum tankers. If there is a bulk sewer close to the work site, the transfer tank is not used and the waste is emptied straight into the sewer line instead of carting to the ASASBU yard. The various transfer options that were available in the staged system developed by Medecins Sans Frontieres, which proved quite resilient to variation, are shown below.



Figure 5.5 The Maquineta in use in Maputo (Steven Sugden)



Or



Or



While the Vacutug was much more powerful and capable of sucking heavier contents, the Maquineta was faster in transit. The Vacutug had higher labour costs but lower operational costs than the Maquineta. The Maquineta ultimately became the preferred exhausting machine.

This trial demonstrated that the use of a low cost carting machine (the Maquineta) when combined with the Vacutug can produce a successful faecal sludge management program. When this is further integrated with a transfer station, a program with good flexibility is produced.

5.3 Modular machine

The image below shows a system developed for a multi-utility service provider of water, solid waste, and faecal sludge management.



Figure 5.6 A single truck which can be adapted for either refuse collection, or water delivery or vacuuming (Eawag and Sandec)

This design capitalises on the similarities between solid waste and faecal sludge management services:

- Solid waste management: collection, transport, treatment, disposal/recycling
- Faecal sludge management: emptying, transport, treatment, disposal/reuse

Similar equipment and institutional accountability are involved and there is the possibility of co-treatment or co-composting.

With this system, pit emptying, transportation of solid waste and carting of water are coupled into a single multi-utility service provider using three system elements: a flatbed truck, a vacuum pump and vacuum tank, and a water tank which can all be mounted on the main vehicle. This approach could be achieved with a variety of vehicles, for example a smaller four wheel drive pick-up. Pick-up trucks are common and can access the majority of areas in a typical settlement. Tractors are another option. If the system elements are designed appropriately then there would be no need for the purchase of a dedicated vehicle, but instead one could be rented locally, reducing overheads. This would also allow one vehicle to be used to transport a number of trailer-mounted exhausters between work sites and disposal points.

5.4 Transfer stations

The efficient use of transfer stations as part of the waste transportation system can significantly reduce costs. Transfer stations can facilitate a coupling of manual carting to a local deposit site with long distance mechanised carting.

Some of the project partners involved in the Vacutug trials used transfer stations to reduce carting costs. These took various forms, from large plastic containers to more expensive concrete chambers. The image below shows the Underground Holding Tank (UHT) which is used successfully in Ghana. In order to stop indiscriminate dumping of sludge by unregistered contractors, only registered emptying contractors are permitted to use the tanks.



Figure 5.7 Transfer station in Ghana, (UN-HABITAT)

While these stations have proven potential, they present a number of challenges. Already dry sludge becomes even more dense while stored at the transport station, making removal by vacuum tanker difficult. The above-ground section of the UHT must be removed by a crane when it is emptied, which is a costly process.

5.5 Investigating trailers for mobile transfer

For this project, the feasibility of using trailers for mobile transfer was investigated. Towing regulations added some complexity to this option. A standard road vehicle was permitted to tow up to 75% of its unladen weight. A high clearance two wheel drive pickup truck weighs approximately 1600 kgs, allowing it to legally tow 1200 kgs, which includes the weight of the trailer itself. Additionally, any trailer weighing over 750 kg (including its load) must have override brakes. Costs are estimated as follows:

Basic trailer to be used as a base for a tank and other additions	R11 000
Hitch upgrade and override brakes	R4 000
Modification of the trailer so that it could be tipped (to aid emptying of waste from the tank)	R1 000
Fibreglass tank	R5 000
Total (450 kg trailer/tank capable of carrying 750 kg waste)	R25 000

An efficient faecal waste management service would need several such mobile transfer tanks to serve each fixed evacuating machine.

5.6 Solid liquid separators

Existing solid liquid separators (SLS) are high tech machines which aid faecal sludge management. After removing waste from the storage tank with suction, the machine removes liquid from the sludge, reducing the volume of sludge to be carted to the disposal site. This significantly reduces carting costs as fewer trips have to be made and the mass of the transported loads is lower.

A closed loop SLS would first partially liquefy sludge for easier removal from the pit, whereafter it would be dewatered and the excess water would be routed back into the pit. The Bill and Melinda Gates Foundation (BMGF) has awarded seed funding to a number of research teams to see if such a system can be successfully developed (as part of the *Omnidigestor* project).

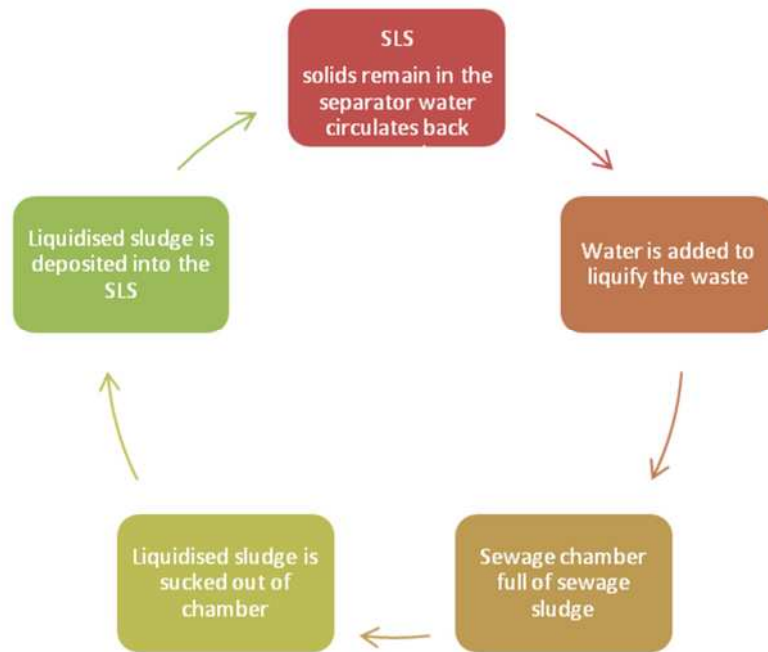

Figure 5.8 The concept for a closed loop SLS where sludge is liquefied, removed from the sewage chamber and deposited into the transfer tank. The water content then re-circulates back into the pit.

If water is available, this also provides the option of fluidising dense sludge so that it can be removed by vacuum, without increasing the volume for transport significantly. In contexts where appropriate infrastructure is available, the liquid can then be discharged into a sewer and only the remaining solid content carted for disposal. If a solid liquid separator could be integrated into a transfer station with a small bore solid-free sewer connection then a highly optimized faecal sludge management program could be produced.



Figure 5.9 A solid liquid separation machine (Eawag and Sandec)

5.7 Conclusion: Optimizing sludge transfer options

While manual carting is a feasible option where sludge is being carted a short distance either to a transfer station or to a mechanised carting system, vehicles are needed for long haul to disposal sites. Separate systems for pit emptying and carting of waste appear more efficient than integrated systems because the exhauster can continue emptying while the carting system takes sludge to the disposal site and a standard local vehicle can travel faster, have fewer issues with road regulations and sourcing of parts for maintenance and repairs.

If, in addition, modular attachments for different services can be mounted onto the transport vehicle, a multi-utility service can be produced which can accommodate the various demands of both solid waste and faecal sludge management within a viable business. If a small bore liquid-only connection to a soakaway or main sewer line is added to the transfer station, the volume and weight of waste to be transported would be significantly reduced. This solid liquid separation could occur in a stand-alone structure which is then exhausted, or more ideally could be achieved using deployed storage vessels which couple into the small bore sewer for solid liquid separation, and when full of solid waste are then towed to and from the transfer point. This would have the benefit of allowing large volumes of water to be used (to liquefy compacted sludge to help exhaustion) without significantly impacting the quantities of waste to be removed, as the added water would only go as far as the transfer station.

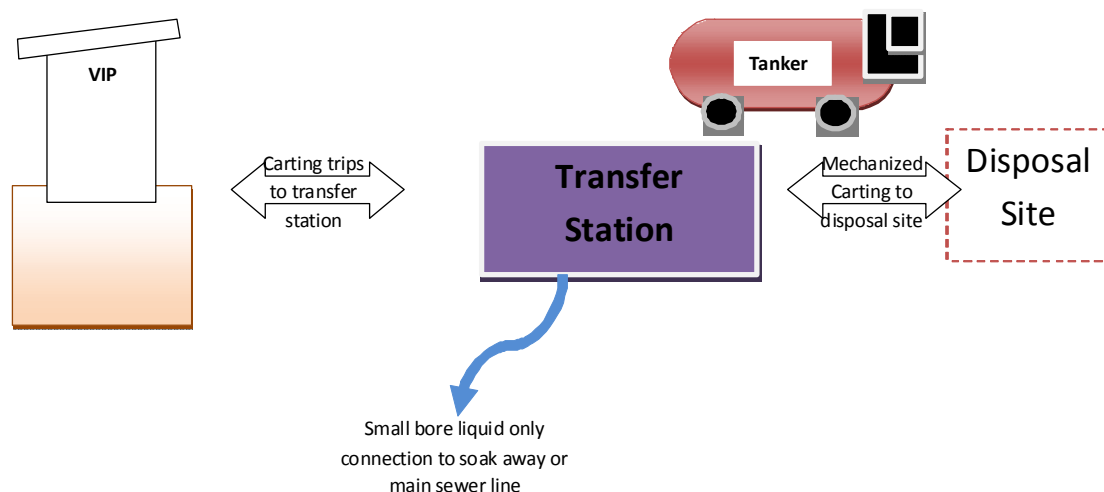

Figure 5.10 Concept for a fully optimized transfer system combining solid liquid separation with a transfer station

Furthermore, if the transfer tank was modular and if it used tanks which could be towed to and from stations and coupled into the small bore sewer then the concept could be fully optimized. This concept needs further development.

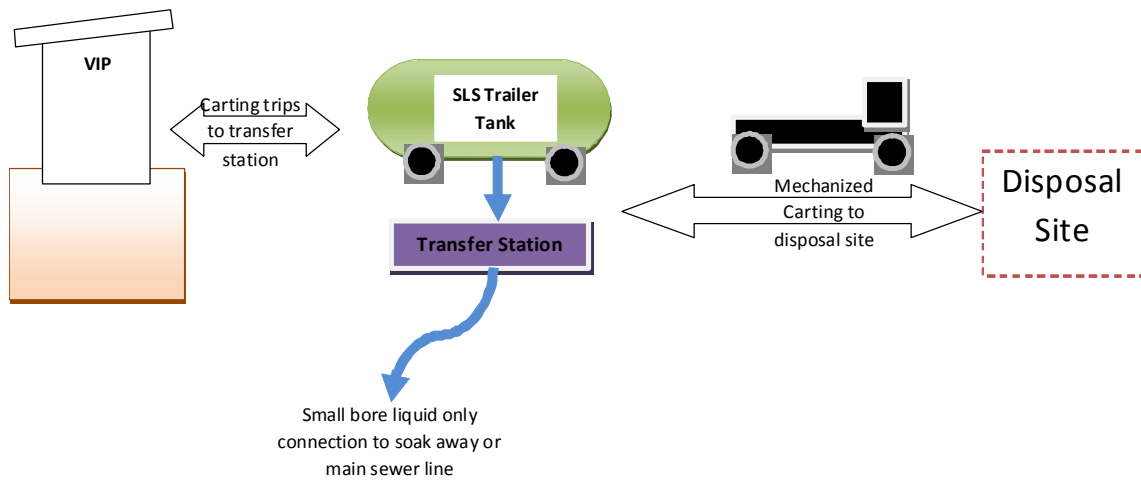

Figure 5.11 A solid liquid separation tank which can be deployed at the transfer station for filling

As it is filled the water content drains to a soak away or main sewer line. The full SLS tank is then replaced with an empty tank.

6 TREATMENT AND DISPOSAL OF PIT SLUDGE

When pit latrines become full, the contents must either be removed or a new pit must be constructed, using either the existing top structure, if it is moveable, or building a new unit. Construction costs and space limitations may make this impossible. If space is available on site, the sludge may be buried on the same premises, eliminating transport costs. Characteristics of the water table and potential contamination of water sources by pathogens from sludge may impact whether on-site disposal is a viable option. In addition, regulations or other efforts to ensure appropriate treatment and disposal of sludge may prevent the burial of sludge on-site.

The options for the disposal of pit latrine sludge if it must be removed from the site are limited by some of its characteristics. It has a lower moisture content than sewage or septage, and therefore cannot be treated in stabilisation ponds or anaerobic reactors without the addition of water. Discharging even small quantities of pit sludge directly into a sewer line can cause shock loading at the treatment plant and merely adds to the output of secondary sludge which must then be disposed of. The large amounts of non-biodegradable matter, such as plastic, metal and glass which are frequently found in pit sludge can cause blockages at treatment facilities and interfere with natural processes of stabilisation. Due to the high pathogen content of sludge, human contact with it must be strictly limited. Landfill or incineration are other possible options for pit sludge disposal.

6.1 Sludge as a resource

As emphasised in the current guidelines of the Department of Water Affairs (Snyman and Herselman, 2006) for the management of treated wastewater, there is a need for a reorientation in policy and practice away from a view of excreta as a waste and towards exploiting its potential as a resource.

One reason is the critical depletion of phosphorous reserves. Phosphorous is an element which is essential to all forms of life. The demand for synthetic fertilizers which has increased exponentially in recent years has been met by exploiting non-renewable phosphorous reserves. Ninety percent of the planet's non-renewable phosphorous reserves are controlled by just five countries, and as the remaining resources become more difficult and more expensive to extract and demand eventually exceeds supply, food prices may rise while food quality deteriorates. By some estimates the known phosphorous reserves will peak around 2030 when supply can no longer meet demand, and reserves will run out in 75-100 years (Rosemarin et al., 2009). More recent estimates indicate that the point at which the world's non-renewable phosphorous reserves become depleted may be further off, but the fact remains that there will be a global crisis when they are eventually exhausted. The phosphorous we consume is not destroyed however. Utilisation of human excreta and other organic wastes, through methods which manage the risks posed by pathogens and contaminants in sludge while recovering phosphorous and other nutrients for agriculture, may prove critically important to protecting food security and food quality in the future. In Sweden, some local councils now mandate urine-diverting toilets in new developments in order to recover phosphorus and nitrogen while in Canada, research has led to commercial scale recovery of struvite pellets from wastewater for use as fertiliser and other industrial applications (Cordell, 2010). The Business School at the University of California Berkeley is currently engaged in research for the Gates Foundation to investigate business models using the larvae of the Black Soldier Fly to consume pit sludge; the larvae can then be processed into either a high protein

animal feed or into biodiesel. (Agrawal et al., 2011). In South Africa the eThekweni Municipality has developed a method for producing pasteurised fertiliser pellets from pit sludge. As part of this research, the burial of raw pit sludge and sewage as a long release fertilizer for trees is being investigated.

Another possibility for recovering energy and nutrients from sludge is composting, which may require the addition of further material with a high carbon content. An example is municipal organic solid waste, which may be an expensive process (Cofie and Kone, 2008). Biogas digesters have been suggested as an option for converting pit sludge to methane for fuel, but the amount of biodegradable matter present in pit sludge after it is exhumed is very small and thus the methane potential is so low that there is no advantage to feeding years old pit sludge to a biogas digester. Simple agricultural applications may prove to be the easiest option for utilising sludge in terms of implementation and management for South African municipalities.

6.2 Regulatory framework

The disposal of pit latrine sludge is subject to regulation and control by the South African Department of Water Affairs (DWA) in terms of the National Water Act (Act 36 of 1998) and the Environment Conservation Act (Act 73 of 1989). The legislation, regulations and guidelines that influence the use and disposal of sludge are listed in the box below.

- *National Water Act* (Act 36 of 1998) (NWA)
- *Water Act* (Act 54 of 1956) (WA)
- *Environment Conservation Act* (Act 73 of 1989) (ECA)
- *Fertilisers, Farm Feeds, Agricultural Remedies and Stock Remedies Act* (Act 36 of 1947)
- *Conservation of Agricultural Resources Act* (Act 43 of 1983) (CARA)
- *National Health Act* (Act 61 of 2003) (HA)
- *Water Services Act* (Act 108 of 1997) (WSA)
- *National Environmental Management Act* (Act 107 of 1998) (NEMA)
- *Minimum Requirements Waste Management Series* (Second Edition, 1998): published in three volumes by the Department of Water Affairs and Forestry establishing a reference framework of standards for waste management in terms of Section 20 of the ECA:
 - *Minimum Requirements for the Handling, Classification and Disposal of Hazardous Waste*
 - *Minimum Requirements for Waste Disposal by Landfill*
 - *Minimum Requirements for Water Monitoring at Waste Management Facilities*
- *Water Use Authorisation and Registration Management System (WARMS)*. This is a registration system used by DWA for water uses
- *Guidelines for the Utilisation and Disposal of Wastewater Sludge* developed by Department of Water Affairs in 2006 to encourage the beneficial use of wastewater sludge:
 - *Volume 1: Selection of management options*
 - *Volume 2: Requirements for the agricultural use of sludge*
 - *Volume 3: Requirements for the on-site and off-site disposal of sludge*
 - *Volume 4: Requirements for the beneficial use of sludge at high loading rates*
 - *Volume 5: Requirements for thermal sludge management practices and for commercial products containing sludge*

The Department of Water Affairs formerly used a system of classifying sewage sludge based on its potential to cause odour nuisances and fly breeding as well as to transmit pathogenic organisms to man and his environment. Unstable sludge with high odour and fly nuisance potential and a high content of pathogenic organisms was classed as Type A sludge. This was followed, in increasing order of stability, by Types B, C and D sludges. These guidelines were prepared specifically with regard to waterborne sewage sludge originating from residential areas and trade and industrial premises. Despite the common use of pit latrines as a sanitation option in South Africa, pit latrine sludge was not included in these guidelines.

The guidelines for dealing with sewage have since been updated as a result of significant changes in the regulatory environment in recent years as well as the intent to come into line with the resolution of the World Summit on Sustainable Development held in South Africa in 2002. With the concept of sustainability driving the new guidelines, the emphasis is on management options that do not harm the environment in terms of depleting non-renewable resources or contributing to a build-up of substances that then pose an ecological threat. This shift in perspective has also brought a fundamental change in the classification of sludge. A new classification system has been developed for sludge treated at a waste water treatment works to reflect that reflects this shift in perspective:

Microbiological class	A	B	C
Stability class	1	2	3
Pollutant class	a	b	c

Classification of sludge under this system requires lab analysis of the sludge to characterise it in terms of:

- Physical characteristics: pH, total solids, volatile solids
- Chemical quality: nutrients, metals, organic pollutants
- Microbiological quality: faecal coliforms, helminth ova

Sludge classified as A1a will have the least restrictions applied to its usage. A sludge heavily contaminated with pathogens, with no stabilisation or vector attraction reduction and heavily contaminated with pollutants will be classified C3c. The new sludge guidelines provide appropriate management options for each specific classification.

Again, although pit latrines have been selected as the standard basic sanitation model delivered by local government in South Africa, pit latrine sludge has been excluded from these guidelines. There is clearly an urgent need for South Africa to put guidelines and protocols in place for pit sludge in order to equip municipalities to deal effectively with full pits.

6.3 Existing options for the treatment and disposal of faecal sludge

Heinss et al. (1998) suggest that options for treating faecal sludge may be divided into those where solid-liquid separation takes place and those where this does not happen.

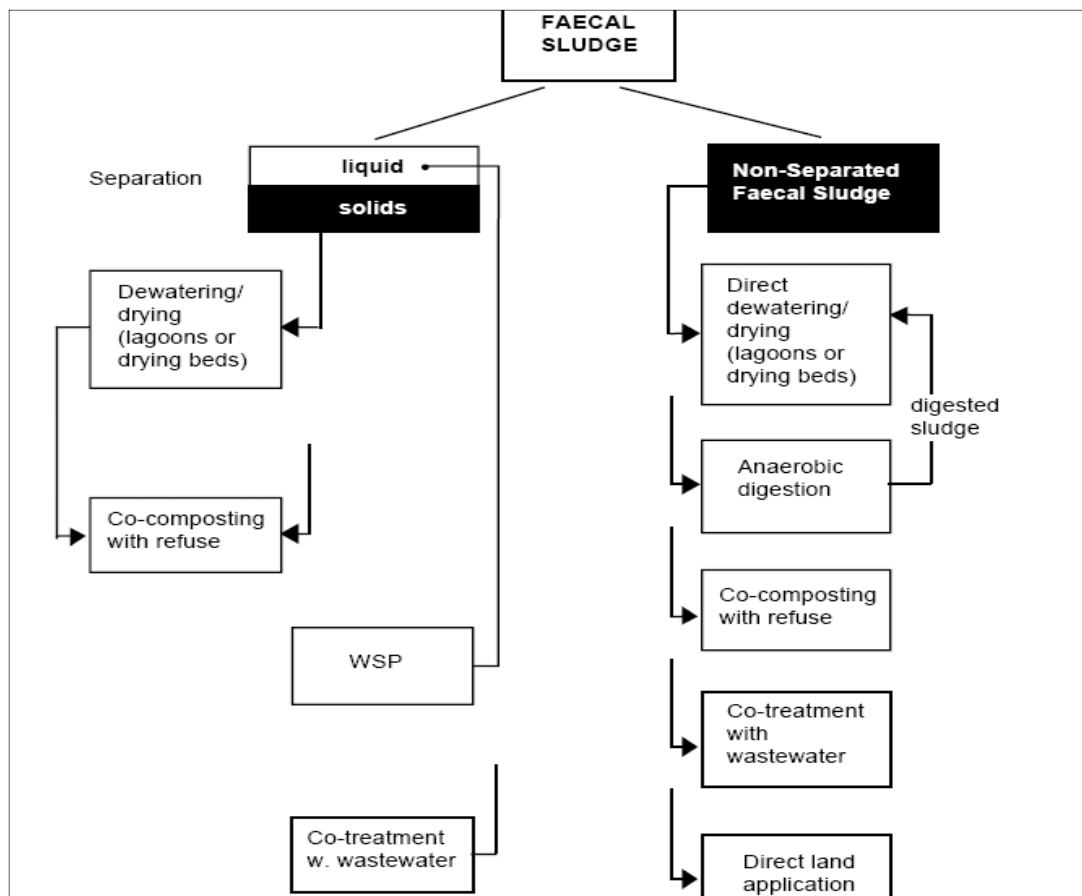

Figure 6.1 Theoretical options for treating faecal sludge (Heinss et al., 1998)

Alternately, treatment options may be classified according to whether sludge is treated separately, or co-treated with wastewater, wastewater treatment plant sludge, solid waste, or organic residues (e.g. sawdust or woodchips). If treatment is done on a community scale, classification of treatment options as centralised or decentralised would also be meaningful (Rijnsburger, 1998, cited in Aalbers, 1999).

6.3.1 Co-treatment of faecal sludge and wastewater

It may appear that because the volume of sludge collected from pit latrines is relatively small compared with municipal wastewater flows, it can be disposed of in the sewers or at the waste water treatment plant (WWTP) without having a noticeable impact. This was the method which the eThekweni Municipality intended to use when they embarked on their first major pit emptying programme in 2008 (see Figure 6.2).

However, a trial conducted at two WWTPs in eThekweni Municipality demonstrated that the critical constraints on the WWTPs are not the volume but the solids load and the nitrogen load. Because pit latrine sludge is so much more concentrated than normal sewage, these loads were very much higher than initially realised. Heinss et al. (1998) describe faecal sludge as “10 -100 times more concentrated than municipal wastewater.”

Research conducted by the Pollution Research Group at the University of KwaZulu-Natal indicates that the addition of the contents of one 1.5 m³ pit to a wastewater treatment facility will have roughly the same impact as one megalitre of sewage – the daily sewage production of 600 to 1200 families – in

terms of COD, TKN (nitrogen) and TSS (total suspended solids). Normal sewage typically has a COD of 750 mg/ℓ, a TSS of 310 mg/ℓ and a TKN of 60 mg/ℓ. In contrast, a composite sample of VIP sludge made up from eight pits emptied by a contractor on one day from an area north of Durban was found to have a COD of 157 000 mg/ℓ, a TSS of 220 000 mg/ℓ and a TKN of 22 400 mg/ℓ.



Figure 6.2 Screening trash out of sludge at WWTW (eThekweni Municipality) – it was found that the addition of pit latrine sludge at WWTWs quickly overloaded the works and this practice was discontinued

The volume of the contents of one pit are estimated at 1.5 m³. The equivalent volume of normal sewage that would provide the same COD load is thus $\frac{1.5 \times 157000}{750} = 3.14m^3$. However, the COD of pit latrine contents may not be particularly relevant to the WWTP, since it is likely that they are largely unbiodegradable. The solids load and the nitrogen load are what appeared to be the major issues during the eThekweni trial. The equivalent volume for TSS is $\frac{1.5 \times 220000}{310} = 1064m^3$ and for TKN $\frac{1.5 \times 22400}{60} = 560m^3$.

Table 6.1 Comparison of pit latrine sludge with sewage

Parameter	VIP Sludge (mg/ℓ)	Sewage (mg/ℓ)
COD	157000 (COD in pit sludge is mainly incalcitrant)	750
TSS	204000	310
TKN	42000	60

From this it can be concluded that, depending on the particular constraints at a given WWTP, the impact of receiving VIP sludge will be equivalent to between 0.5 and 1 Mℓ of normal sewage per emptied pit. A municipality must therefore keep the ratio between the number of pits emptied per day and the capacity of the plant in Mℓ per day at no more than 1 to 10 to avoid process failure of the plant.

The mechanism of WWT plant failure is not clearly understood. In one case, the removal of secondary solids from the works was limited by the number of truckloads of solids arising from secondary sludge from the plant that could be removed in a month, in terms of operating costs, and the willingness of the receiving landfill to accept the material. Thus when large volumes of fairly dry pit sludge were added to the works, with relatively little addition of biodegradable material, the solids report fairly soon as secondary sludge. The sludge could not be removed at an accelerated rate, and thus was retained in the system for an extended period. It was clearly a case of taking one solids problem and making it into another solids problem. Secondly, the very high load of nitrogen added to the works appeared to inhibit or otherwise deactivate the nitrification capacity of the works, and in this particular case, it took the works several months to recover. Thus while co-treatment in a conventional WWTP seems a convenient disposal route, it is not a sustainable or successful one. In addition it takes the potential nutrient resource of the sludge and turns it into an environmental problem.

6.3.2 Specialised faecal sludge treatment works

In Accra, Ghana, there are two treatment plants dedicated to the treatment of faecal sludges from septic tanks, bucket latrines and public toilets (Heinss et al., 1998). The Achimota Faecal Sludge Treatment Plant is shown in Figure 6.3. These faecal sludge treatment plants consist of two or three settling tanks used alternately, and a series of anaerobic and facultative ponds into which the supernatant from the settling tanks flows. The settling tanks are approximately 300 m³ in capacity, and fill after two days of loading with 150 m³ of sludge. Thereafter, the tank acts as a sludge accumulator for four to eight weeks. A parallel tank is then used, and the first tank is left to consolidate. When it is necessary to use the first tank again, it is desludged using a front-end loader.

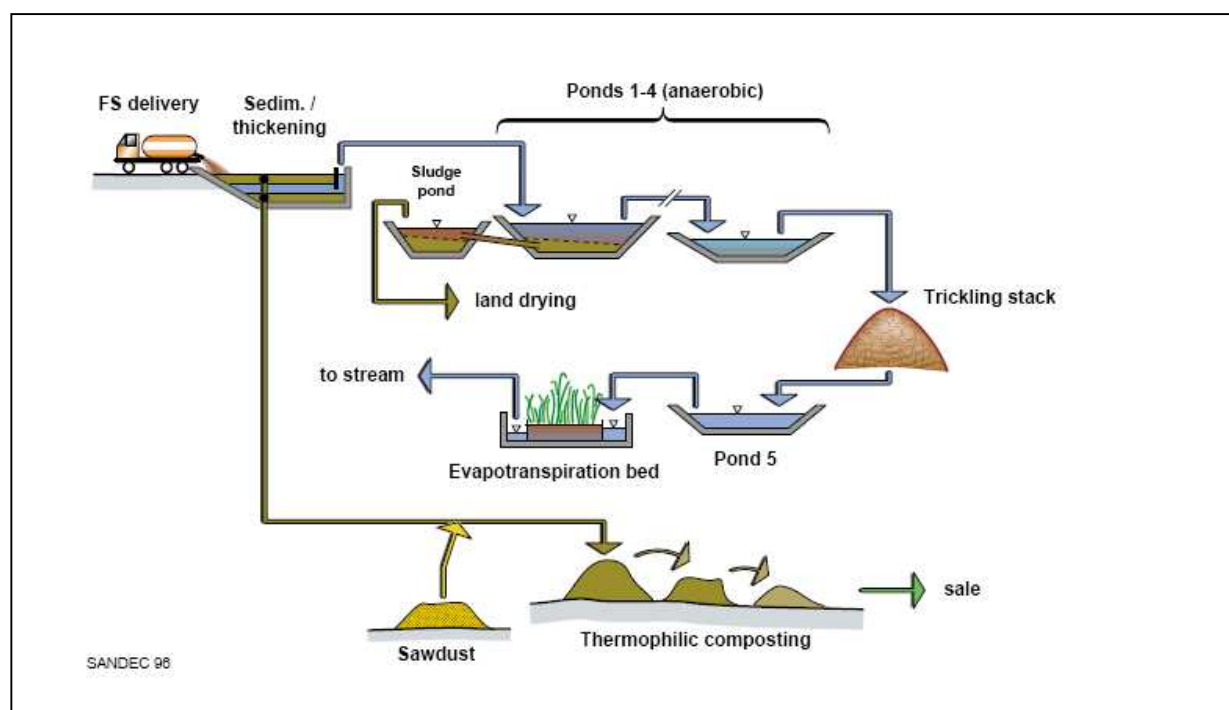

Figure 6.3 Schematic diagram of the Achimota Faecal Sludge Treatment Plant in Accra, Ghana (Heinss et al., 1998)

Heinss et al. (1998) point out that frequently desludged settlement tanks may be preferable to deeper anaerobic primary ponds often used in wastewater treatment. The high solids content would mean that ponds would either have to be very large or desludged more frequently than conventional treatment plants. Anaerobic ponds are more suitable than facultative ponds, since the latter require algal growth which is inhibited by the ammonia in faecal sludge. Strauss et al. (2000) found that BOD removal in anaerobic ponds at the Achimota plant was variable – sometimes taking place only in the settling tank and first anaerobic pond, and sometimes taking place at higher rates in the secondary and tertiary ponds. They speculated that this may be due to differing ammonia levels which inhibit methanogenesis in anaerobic systems. It should be noted that the faecal sludge treated had a much lower total solids content than pit latrine sludge, and that the authors suggest that pond treatment may not be suitable for high strength sludge.

6.3.3 Biogas generation through anaerobic digestion

The anaerobic digestion of faecal sludge produces carbon dioxide and methane. This combined gas, sometimes referred to as biogas, can be used for heating or for the generation of electricity. Van Lier et al. (1999) list the advantages of anaerobic treatment as follows:

- Low investment costs and low space requirement
- Applicable at small as well as large scale
- Low production of excess sludge which is well stabilised
- Low nitrogen and phosphorus requirement
- No, or very low, energy demand
- Production of valuable energy in the form of methane
- High loading capacity (\pm 5-10 times more than an aerobic plant)
- High treatment efficiencies
- Effluents contain valuable fertilisers (ammonium salts)



Figure 6.4 Anaerobic biogas reactor built in Lesotho by GTZ (Lepofa, 2006)

Van Lier et al. (1999) refer to upflow anaerobic sludge blanket (UASB) reactor systems as those most commonly used in the treatment of domestic sewage on a large scale, and suggest that this technology might be applied in on-site systems to improve bio-conversion. They cite research in Indonesia which

showed that 97% removal of suspended solids and 92% removal of COD could be achieved (Lettinga et al., 1993).

Mgagna (2003) investigated the application of small scale UASB reactors for the on-site treatment of domestic wastewater. He found that while a large scale septic tank removed 29% of COD the two step UASB reactor treatment removed up to 69%. His pilot plant is shown in Figure 6.5. He does mention that the removal efficiency for the septic tank was lower than those reported in the literature, usually around 45%.

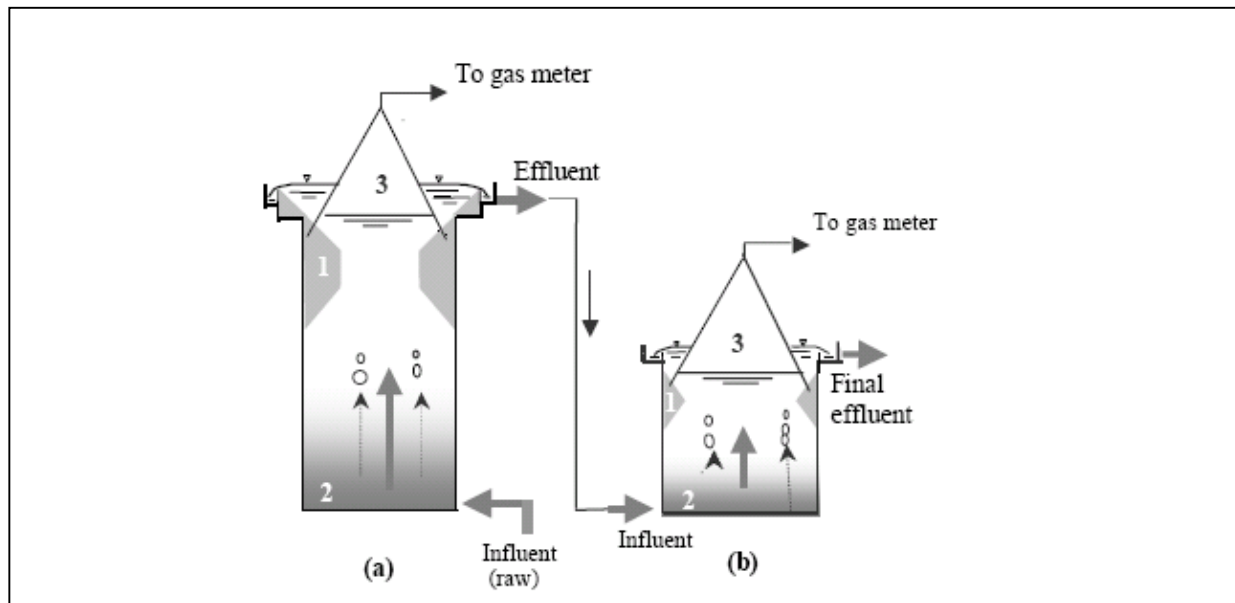

Figure 6.5 Schematic diagram of a pilot two-stage UASB treatment plant in Tanzania

Strauss et al. (2006b) suggest that anaerobic digesters are most suitable for decentralised, community level treatment of faecal sludge. They warn that technology for dealing with fresh, high strength sludge needs investigation. Chaggu et al. (2007) describe a study of anaerobic sludge stabilisation in an Improved Pit-Latrines Without Urine Separation (IMPLWUS) reactor in Dar es Salaam. They found that ammonia accumulation caused inhibition of methane production and suggested that this resulted in a lower removal of COD.

Koottatep et al. (2006) used an anaerobic baffled reactor to treat domestic wastewater. They found that 90% removal of COD could be achieved. The COD of the influent was 1000 mg/l, which is considerably lower than that of pit latrine sludge. Post treatment was necessary to achieve effluent which could meet the national effluent standards of Thailand.

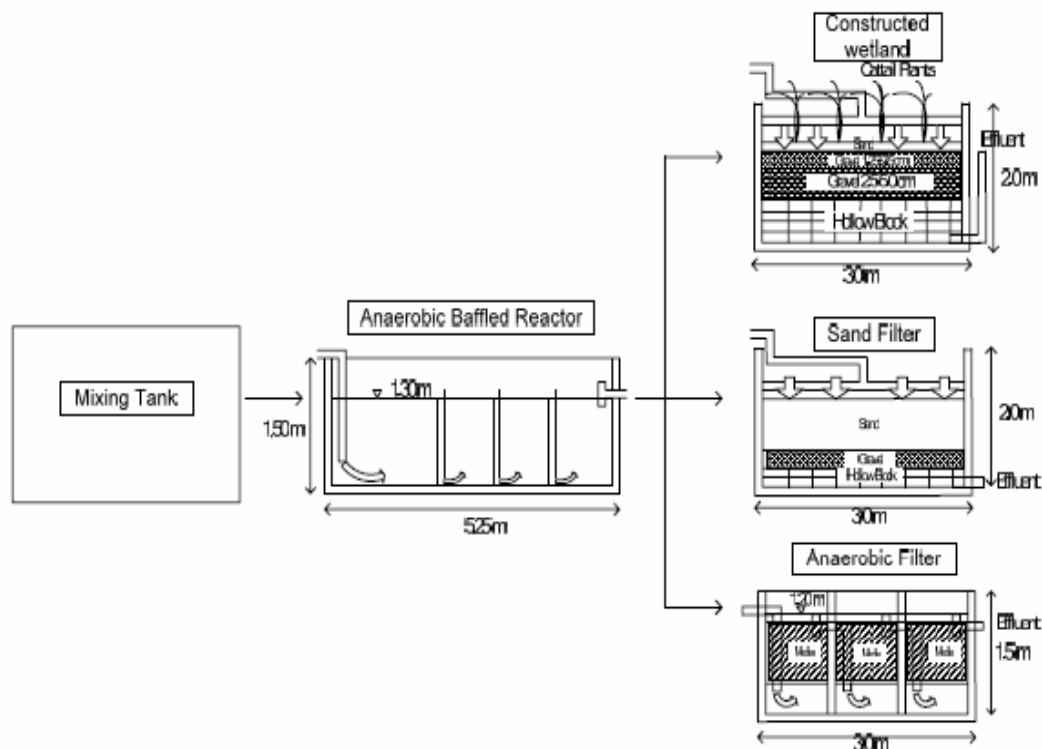

Figure 6.6 Schematic diagram of ABR with different post treatment options

Foxon and Buckley (2005) found that an anaerobic baffled reactor provided superior solids retention compared with a septic tank, and suggested that this would be a suitable treatment method to use with condominium-type sewerage or in an appropriately designed toilet block. They emphasise that further treatment of the effluent is necessary for pathogen and nutrient removal.

One of the Vacutug project partners based in India used biogas reactors for disposal. Fifty-four biogas plants were constructed on the Sulabh model. The digester is constructed underground into which excreta from public toilets flows under gravity into the underground digestors, which have a capacity of 35 to 60 m. The biogas produced used for cooking, lighting, heating and electricity and heat generation. The small Vacutug tank could be discharged into the digestors, avoided the problem of transport to distant disposal sites. In Delhi Sulabh has two large biogas plants attached to public toilets. In Badlapur, the Ecosan Services Foundation has built a pour flush system which incorporates a biogas plant and constructed wetlands to treat the effluent from the plant (Panesar and Bischoff, 2008).

A clear distinction must be made between faecal sludges that have been freshly generated (e.g. contents of conservancy tanks, or sewerage systems) and sludge which has resided in a pit or other faecal content container for an extended period. In the latter case, significant biodegradation of the faecal sludge can be expected to have already occurred; thus addition of this kind of sludge to a biogas system will have limited benefit, and possibly significant cost with no benefit. As a general rule, sludge that has been collected from on-site systems where it has been stored for more than a year will have little biogas potential. Careful pilot studies on any faecal sludge source would be recommended to ensure that the full size plant is able to generate an economically feasible amount of methane.



Figure 6.7 School toilet block with pour flush and urine diversion in Badlapur, India (Panesar and Bischoff, 2008)

6.3.4 Drying beds

When drying beds are used, sludge is typically applied in a layer approximately 20 cm deep (Heinss et al., 1998). Liquid is lost from faecal sludge in drying beds through evaporation and percolation, and also through evapotranspiration in planted drying beds. The percolate should be treated further, for example in facultative ponds.

Heinss et al. (1998) conducted studies in Ghana which showed that high strength faecal sludge exhibited much poorer dewaterability than high and low strength sludges mixed in a 1:4 ratio when unplanted drying beds were used. The undiluted high strength faecal sludge reached a total solids (TS) content of 29% after 8 days, while the mixture achieved 70% TS. They suggest that planted drying beds may be more suitable for faecal sludge drying.

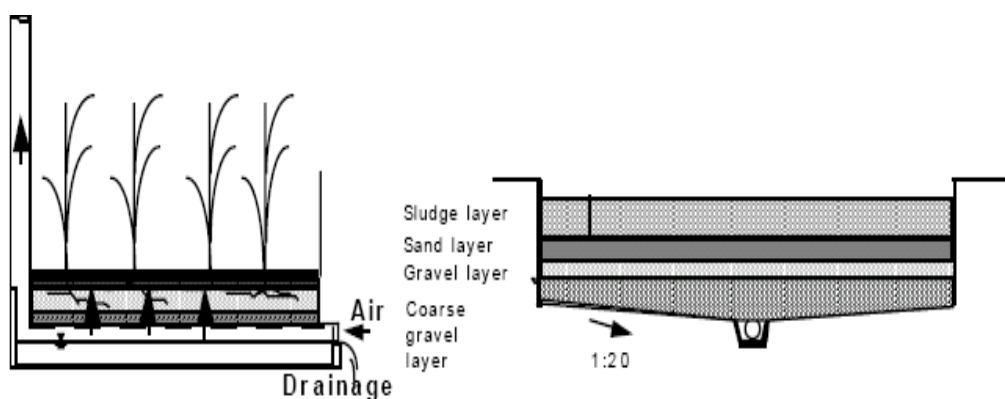

Figure 6.8 Schematic diagram of planted and unplanted sludge drying beds

Planted sludge drying beds, or constructed wetlands, produce nutrient rich effluent and dried sludge which can be used as fertiliser (Aalbers, 1999). The crop planted in the wetland is used with the sludge as “green manure”. Constructed wetlands may rely on surface flow of effluent or may be constructed to allow subsurface drainage through the substrate in which the plants are established.



Figure 6.9 Constructed Wetland (Strauss and Montangero, 2000)

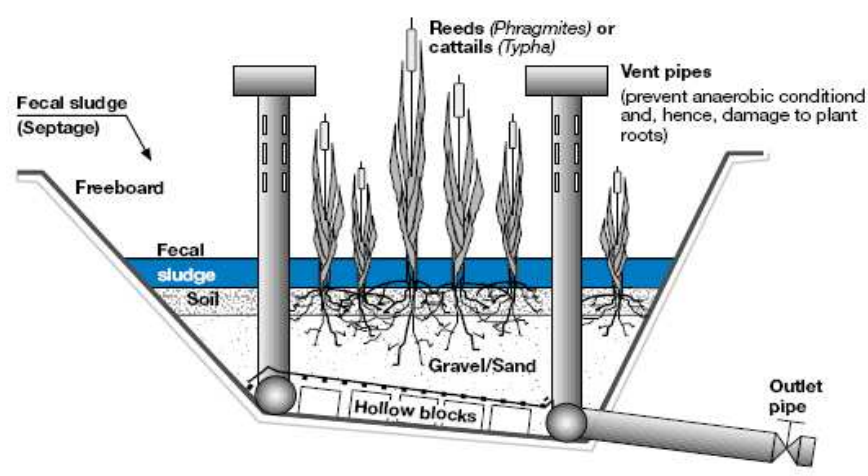

Figure 6.10 Planted constructed wetlands (Glanville, 2006)

Kootatep et al. (2002) report that constructed wetlands require far less frequent desludging than unplanted drying beds. Their studies, conducted in Thailand, used septage of a similar moisture content (20%), but lower COD (71 mg/g dry mass) than pit latrine sludge. Heinss et al. (1998) suggest that passive ventilation of the root area is particularly important in the case of concentrated faecal sludges to prevent the development of anaerobic conditions in the root zone.

6.3.5 Composting

Composting is the aerobic degradation of organic matter by microbes. Compost can be used as a fertiliser and soil conditioner. The raw material for composting should have a carbon:nitrogen ratio of approximately 30:1. Since faecal sludge has a ratio of approximately 6:1, it is necessary to add carbonaceous material to sludge to achieve an ideal composting medium. The moisture content should be 40-60%. Pearson and La Trobe (1999) used a settling tank to provide septic tank sludge of more than 5% total solids for composting, but found that pit latrine sludge could be used unsettled. They used domestic and garden refuse as a co-composting agent.

During the composting process temperatures in the heap may reach 70°C, and this eliminates a range of pathogenic organisms. Pearson and La Trobe (1999) used an insulating layer on the surface of the composting matter to maintain internal temperatures.

Frequent aeration is required to maintain aerobic conditions. Franceys et al. (1992) recommend that composting takes place in windrows 1.5 m high, and that these are turned every few days. Alternately, heaps may be actively ventilated with blowers with perforated air pipes running under the windrows (IWMI and SANDEC, 2002). Successful tests have also been carried out using passive aeration through a base of bricks, with vents to extract air from the surface of the heap (Pearson and La Trobe, 1999).

The city of Kumasi in Ghana has a population of over 1 000 000 people, of whom 38% use public latrines and 12% bucket latrines (IWMI and SANDEC, 2002). These facilities require emptying every 1-2 weeks. In addition, there are septic tanks serving 26% of the population which also require periodic desludging. Kumasi produces 500 m³ of faecal sludge, 610 tons of domestic waste and 250 tons of organic waste from the two main markets on a daily basis. A pilot project has been instituted to investigate the potential for co-composting the different types of waste to reduce landfill requirements (IWMI and SANDEC, 2002).

Where pit sludge contains rubbish, as in South Africa, this must be removed in order for composting to be effective. Removing rubbish, adding other organic matter to the sludge and regularly turning the heap costs money and requires good management and supervision. If composting is not done properly a pathogen-free end product cannot be guaranteed.

6.4 Innovation in the beneficial use of sludge

6.4.1 Agroforestry: Deep row entrenchment

In the early 1980s, researchers at the University of Maryland in the United States pioneered a technique for entrenching sludge in deep rows covered with soil. This initiative was a response to the escalating production of secondary sludge (currently estimated to exceed 1.2 million wet tons/pa) in the Washington, D.C./ Baltimore, Maryland region of the U.S.A. and the increasing cost of/ reduced options for disposal. Also, as a result of construction activity over previous decades, there were large tracts of spent sand and gravel mining spoil that were barren and biologically dead. Entrenching sludge and planting poplar trees for commercial harvest demonstrated that nutrients can be recycled and that there are no adverse effects on the groundwater (Buswell, 2006). Arresting erosion and creating a wildlife habitat provided additional benefits. In another example of beneficial use of sewage sludge, 72 000 m³ of composted sludge was used to landscape the airport in Sydney, Australia in 1995 (Kelly, 2006).

The application of sludge (referred to as “biosolids”) is now an established practise in the plantation forest industries of North America and Australia. In Australia, surface application of sludge achieved a 30% increase in the growth rates of existing pine plantations, and incorporation into the soil prior to planting improved tree height by up to 50% after 5 years. Tree diameter was increased by 85% and the density of the wood produced was not affected (Kelly, 2006).

Surface application of sludge may be associated with unpleasant odours, potential runoff into streams and the proliferation of human and animal pathogens. Deep row entrenchment contributing to the production of non-food products prevents these outcomes. Deep row sludge applications have been recommended for rehabilitating mine spoils, improving conventional forestry production, creating shelterbelts against strong winds and high noise levels (highways and airports), creating wildlife habitats for conservation and sporting purposes and growing trees for biofuel production.

The entrenchment procedure involves excavation of a trench, for example 200 m long, 600 mm wide and 1.2 to 1.5 m deep, with rows spaced 2.4 to 3 m between centres. The trench is filled with sludge to within 300 mm of the surface and then backfilled with the overburden heaped. Trees or other vegetation are planted in rows parallel to the trench. The trials conducted in Maryland have used application rates ranging from 480 to 1,443 tons/ha (20% solids) containing 20 to 60 tons/ha N (Kays et al., 2007).

Variables include trench dimensions, spacing, method of filling (layered with soil or co-composted with vegetable matter), species, composition and density of vegetation, and end purpose. The fundamental objective is for plant roots to act as a nutrient sink with little or no nutrient loss to the surrounding soil or groundwater. The trench contents should stabilise over a period of approximately six years with mineralisation, nitrification and dewatering of the sludge occurring from the top down. An odourless, peaty residue should result.

6.4.1.1 Deep row entrenchment trials in South Africa

As deep row entrenchment provides a means of sludge disposal which reduces the risk of pathogens coming into contact with people, does not require the removal of non-faecal matter from the sludge and recycles nutrients in accordance with South Africa’s current sludge guidelines, the Water Research Commission and the eThekweni Municipality are further exploring the applicability of this method. The project aims to consolidate knowledge on sludge management for land disposal, identify the critical parameters to be measured in deep-row entrenched pit latrine and secondary sludges and develop methods to sample and analyse these components. In addition, the feasibility and commercial viability of entrenchment are being explored.

The detailed results of this work will be published separately by the Water Research Commission.

❖ Entrenchment of VIP sludge at Umlazi

The eThekweni Municipality provided land for a trial at the site of former sludge treatment ponds in Umlazi, south of Durban. The land is presently valueless because it is below the 1:50 year flood line. In addition, vermiculture experts established that the soil was of little or no agricultural value. In September 2008, approximately 1200 m³ of VIP sludge were buried in trenches 2 m deep and 1 m wide in layers of various depths and capped.



Figure 6.11 Pit sludge with high rubbish content buried in trenches

In early 2009, approximately 1400 *Eucalyptus grandis*, *Eucalyptus grandis X urophylla*, *Acacia mearnsii* were planted on or between the trenches in 41 rows. While it was originally planned that every fourth row, which had no sludge, would act as a control, it became apparent that the roots of trees in these rows would be able to access the sludge in adjacent rows. Consequently an additional block of nine rows of trees was planted in August-September 2009 where only rows 2 and 3 had sludge.



Figure 6.12 Eucalyptus trees at planting in February 2009 (left) and in January 2012 (right)

An initial characterisation of the hydraulic properties of the soils and subsurface was carried out. Five background boreholes were sunk on the downslope side of the site to monitor the effect of the sludge on groundwater. Regular sampling of groundwater was done to monitor the impact of the entrenched sludge on water resources. To date no trends in groundwater quality have emerged, and all components of the groundwater have remained well within safe limits.

Sludge samples were taken periodically using a soil auger and analysed for changes in moisture content, volatile solids, COD, nitrate, phosphate and orthophosphate as well as for pathogen viability. The evidence to date suggests that after burial the sludge dewateres and breaks down to a certain extent, with the rate of break down slowing after the first year. Visually, by January 2011 the only way it could be confirmed that the auger had in fact reached the sludge was by looking for fragments of solid waste in the augered material. Indications are that no pathogens have survived longer than 30 months after burial.

When the trees became too tall for height measurements to be practical, they were compared on the basis of their diameter at chest height (1.37 m) which is a standard used by foresters. Figure 6.13 below shows the status as measured on 12 August 2011. This figure shows only Rows E3, E4, E5 and E7 as these rows were all planted in October 2009. Sludge was placed in Row E3 but none of the others. The trees in Row E7 were given commercial fertilizer at the time of planting. As can be seen in the figure, the trees in E3 have diameters so far approximately 33% larger than the trees planted in rows E4 and E5. The effect is less marked when comparing E3 with E7. Given that biomass is proportional to the square of the diameter x the height, the biomass of the E3 trees will be almost double that of the E4 and E5 trees.

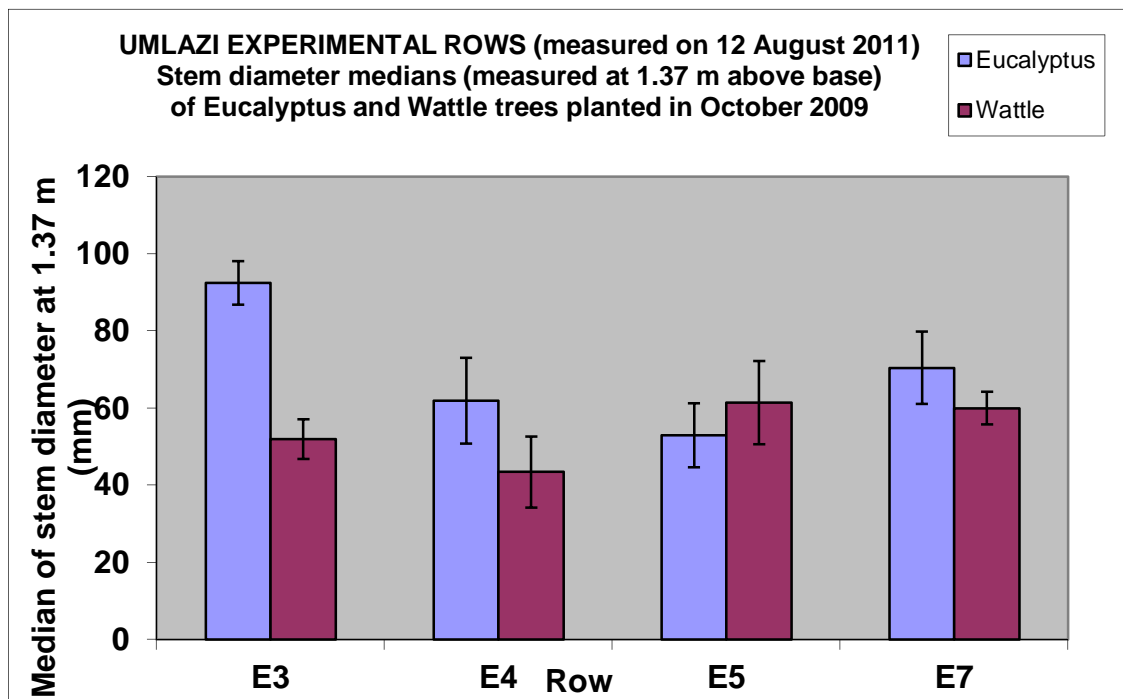

Figure 6.13 Medians of stem diameters at 1.37 m of Eucalyptus and wattle trees in rows E3, E4, E5 and E7 planted in mid-October 2009 and measured on 12 August 2011

A Water Research Commission field trial of deep row entrenchment of waste water treatment works sludge is also ongoing at SAPPI's research site in Howick.

❖ Tree tower experiments

In parallel with these large scale field tests, controlled experiments with constructed towers and pots have been conducted by Craig Taylor at UKZN, under WRC project K5-1829. These have enabled more intensive scientific investigation of tree growth over soil augmented with sludge.

Wattle and gum trees were grown in towers constructed using concrete manhole rings. The experimental trees were planted over sandy soil with a core of VIP pit sludge and the controls being planted over sandy soil. The controls were regularly fertilised using a liquid fertilizer whereas the experimental trees were given no fertilizer other than the sludge.



Figure 6.14 *E. grandis* of control (left) and experimental groups (right) prior to harvest (Taylor, 2011)

The comparative tree growth and health is most clearly shown by comparing mean leaf area. For the eucalypts the mean leaf area at the end of the 26 week trial period was 12.0 m² for the experimental trees and only 1.8 m² for the controls. For the wattles the comparative figures were 3.7 m² versus 2.0 m².

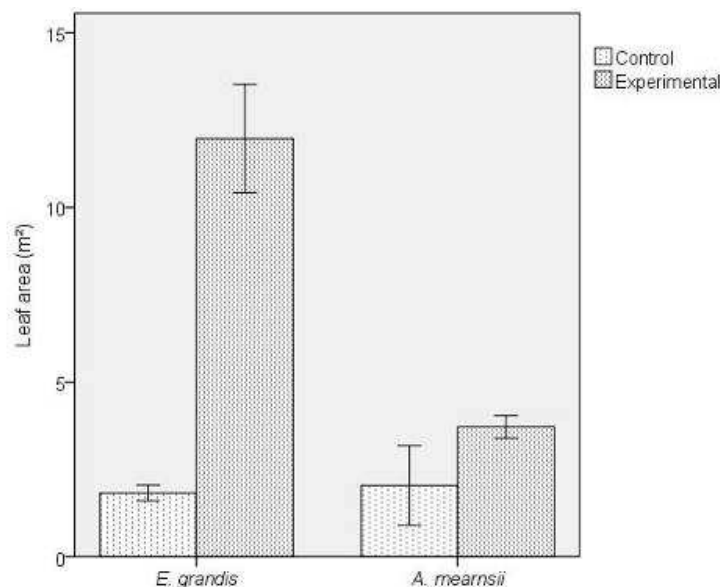

Figure 6.15 Mean leaf area (m²) of *E. grandis* and *A. mearnsii* measured post-harvest. Error bars shown are \pm SD (n=5). Taylor (2011)

Very significant differences in N, P and K uptake occurred between the experimental trees and the controls.

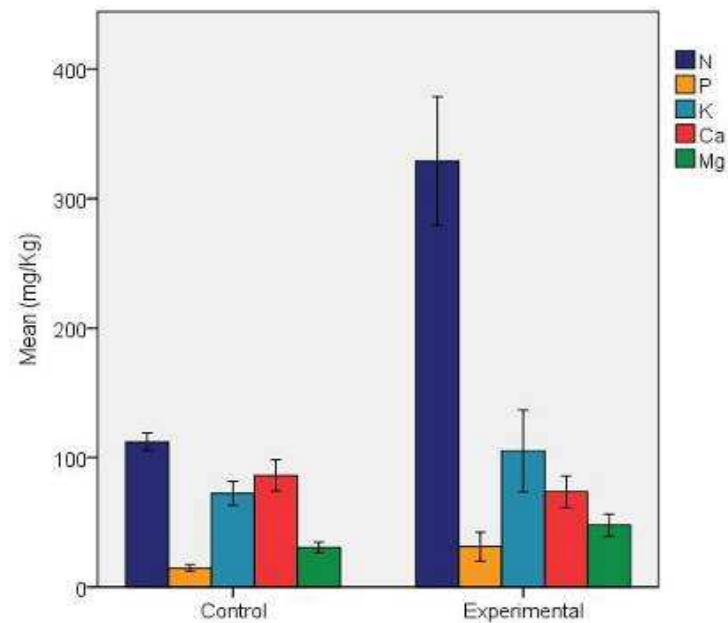

Figure 6.16 Foliar N, P, K, Ca and Mg concentrations (mg.Kg⁻¹) of *E. grandis* for control and experimental groups (n=5). Error bars shown are \pm SD (Taylor, 2011)

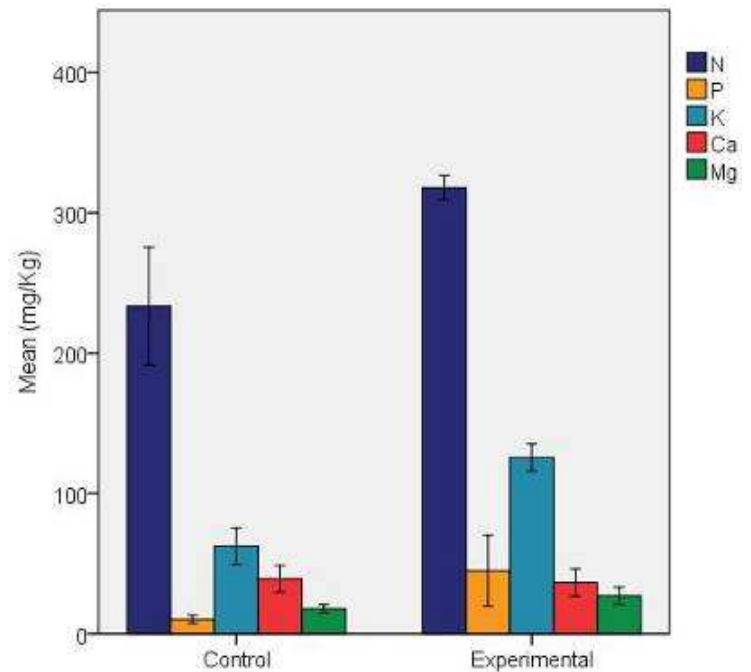

Figure 6.17 Foliar N, P, K, Ca and Mg concentrations (mg.Kg⁻¹) of *A. mearnsii* for control and experimental groups (n=4 and n=5 respectively). Error bars shown are \pm SD. (Taylor, 2011)

After the end of the 26 weeks trial period the towers were broken down to examine the root structures, and these have been mapped for all the trees. In all cases roots were found to intersect and penetrate the sludge.



Figure 6.18 Root distribution of *E. grandis* grown above faecal sludge, shown with sludge core exposed (Taylor, 2011)

❖ On-site burial of pit sludge: Inadi, Pietermaritzburg

In an earlier trial, the possibility of using on-site burial of sludge to provide nutrients to fruit trees was investigated. Two homeowners with full pits agreed to participate in the study and in August 2008. The two pits were emptied manually. The pits were not lined, and as the sides sloped inward they were found to contain less sludge than expected. Both pits were reported to have been full when they were closed and homeowners reported that only a 300-400 mm covering of earth was required to fill in the pit. As the volume of the contents of the pits reduced, more soil was added at the first household while garden waste was added at the second household. On excavating, faecal sludge was only encountered at a depth of 1.65 m (first household) and 1.15 m (second household). The depth at which the sludge was first encountered was recorded and samples taken at various depths were analysed for moisture, volatile solids (TS - Ash) and COD. The faecal contents of the pits comprised two distinct components. One was a dryer, peaty, black, odourless fraction that appeared to be well stabilised, the second was a wetter, more “fresh” looking fraction with a strong unpleasant smell. The peaty fraction was found in contact with soil whereas the malodorous fraction was found in clumps of non-biodegradable material, particularly plastic bags. Initially, the pit sludge seemed to contain a considerable quantity of non-biodegradable matter (plastic bags, cloth, bottles, etc.). However, the volume of this material amounted to only 0.08 m³ (8%) for the pit at the first household and 0.18 m³ (14%) for the pit at the second household. Non-biodegradable material was removed manually and placed in a separate pile.

Holes for the fruit trees were dug approximately 900 mm square and deep. Trees serving as a control were planted in only the soil that had come from the hole, while others were planted with a handful (approx. 40g) of super phosphate fertilizer scattered around the base of each tree and worked in superficially with a fork and others were planted with pit sludge added in 90 ℓ batches to layers of soil returned to the holes. The sludge was mixed into the soil layers with a garden fork. It was ensured that no sludge was incorporated into the top 300 mm of soil around each tree. The owners were asked to subsequently treat all trees identically with regard to watering and weeding.

Sludge samples from the pits were analysed for moisture and volatile solids by the Pollution Research Group of the University of KwaZulu-Natal. Moisture content was lower than is typical of pits in use, suggesting that some dehydration of pit contents had occurred during the four or more years during which the pit contents have been buried. There were no significant differences in volatile solids between any of the samples tested, irrespective of the height or appearance of the samples.

For the first three years the trees grew well, with those trees planted over the sludge demonstrating more vigorous growth and more fruit production. Homeowners reported that the trees produced excellent fruit and that neighbours inquired about using the same methods. However, during 2011 several of the trees were badly affected with greening disease (a common and serious citrus disease encountered in the region) and up to 50% of their branches had to be removed, making further comparisons of tree growth or nutrient value in fruit meaningless.

6.4.2 Injection of sludge below surface for agriculture

In 2010, students at the University of KwaZulu-Natal, funded under WRC project K5-1829, designed a prototype for an apparatus to inject sewage sludge beneath the soil surface in order to enhance sugar cane cultivation. A tanker truck transports sludge to the disposal site where it is pumped into a tractor mounted with a modified ripper. The ripper creates a subsurface channel into which sludge is pumped through a manifold to a metering pipe attached behind the ripper tines. The disadvantage of this method is that the surface is disturbed and additional tillage is required before planting. Alternately, a tanker equipped with an injector is mounted on a tractor which is then used to collect, transport and inject the sludge. Unless the application site is very near the collection point, this method is uneconomical as the tractor travel time is slow and collection and application cannot be done simultaneously. Heavier loads also result in compaction of the soil.

❖ Design development

Sugar cane would require an application of 20 tons of sludge per hectare on a 3 yearly cycle to supply ample nitrogen to the crop. In order to deliver 20 tons/ha sludge, an apparatus would need to discharge 2 kg of sludge per running meter at 1 m spacing. This could be achieved at a discharge rate of 2.38 l/sec at a tractor forward speed of 1 m/sec (3.6 km/h). The weight of the apparatus should not exceed 750 kg as a 56 kW tractor must be able to lift it when full. The sludge must be injected at least 300 mm below the soil surface to ensure an adequate barrier between pathogens and pollutants in the sludge and the soil surface and surface water.

Wings can be welded to the tip of the ripper shoe to create a subsurface channel into which sludge is deposited by a shaftless auger powered by a hydraulic motor controlled from the tractor, eliminating the need to add water to the sludge. An alternative is to mount a mole behind the ripper shank to form a channel for the sludge, eliminating the risk of damage to the screw when the ripper swings if a shear bolt breaks. However both these options would require a screw and discharge pipe of at least 300 mm diameter. The optimal design option was found to be using 25 mm shanks which are easily sourced and require only 26 kW. The sludge is liquefied and pumped through a discharge pipe into the channel.

To pump the sludge, lobe pumps, internal gear pumps, sliding vane pumps and submersible pumps were considered for their speed and capacity to handle materials of high density and viscosity. A submersible pump was chosen because of lower costs and because due to being immersed inside the tank it is self-priming, uses less space on the mechanism and has higher efficiency due to being cooled by the surrounding liquid. Submersible sewage pumps can handle particles of up to 25 mm in diameter, easily

accommodating the solids in sludge which have a particle diameter of roughly 3 mm. A float switch switches off the pump if the level in the tank falls to 160 mm. Sludge with a moisture content of 40-60% has a density of 1200-1400 kg/m³ and a submersible pump can handle densities within this range and discharge at the target rate (2.38 l/s) requiring 0.25 kW power.

The final prototype used a submersible pump powered by a diesel generator set to pump slurry from a 250 l plastic tank through a flexible 1 m pipe into a 25 mm discharge pipe of 400 mm in length. The discharge pipe delivered the slurry into a 50 mm channel created by 25 mm thick ripper shanks fitted with 50 mm wings with a 20 degree penetration angle. The ripper is attached to the implement with a M20 shear bolt and M24 pivot bolt. The components are mounted on a 1.6 mm plate mounted on a tractor's 3 point hitching system. The single device is used to load, transport and deliver the sludge. Frictional losses are estimated at 0.05 m with an elevation head of 1.4 m, resulting in a required total head of 1.45 m.

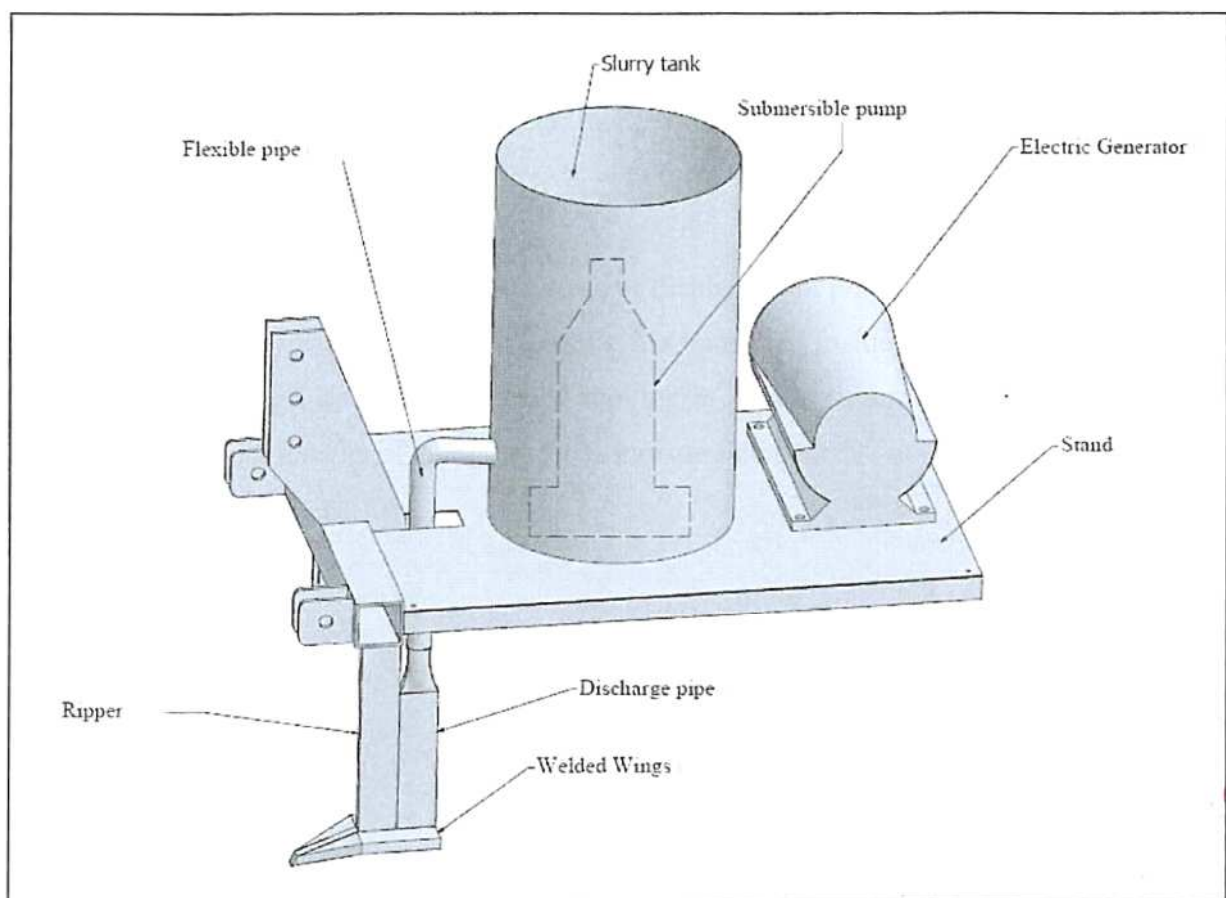

Figure 6.19 Design of prototype sludge injector

❖ Testing

The prototype was tested on clay soil using pig slurry and a 66 kW 4-wheel drive tractor. During the first trial the M16 bolt sheared when the ripper was at a depth of 200 mm indicating that the draft was higher than the 13 kN initially anticipated. It was replaced with an M20 shear bolt, however the ripper deflected beyond the acceptable range and there was significant wheel slippage, resulting in speed being reduced to 0.5 metres/sec. The ripper was redesigned with the shank width increased from 80 mm to 150 mm. In addition, the orientation of the shank on the plate was changed so that the shank would pull at 30 degrees to vertical, reducing the draft by at most 20%, and a sharpened cutting edge was welded

to the shank, reducing the draft possibly by a further 10%. The redesigned ripper was able to work at a depth of 350 mm and at an average speed of 1.1 m/s on previously tilled sandy clay soil, which met the design requirements; however on untilled clay soil it was only able to achieve an average speed of 0.78 m/s without significant wheel slip. While the ripper reached an average depth of 340-360 mm, sludge depth at some points was only 282 mm, not significantly less than the required 300 mm.

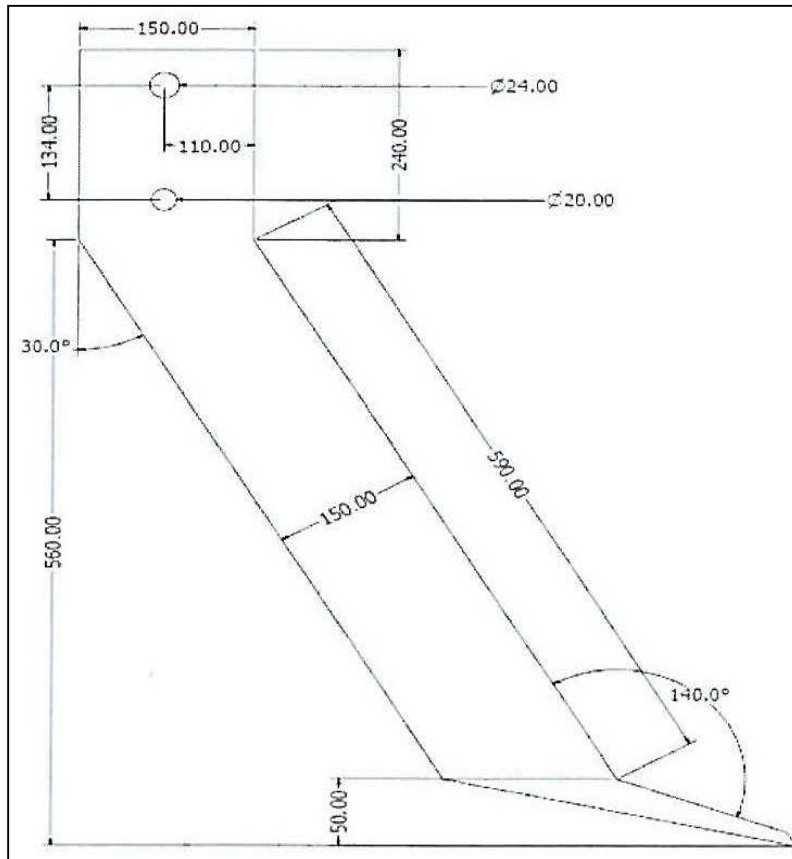

Figure 6.20 Redesigned ripper with cutting edge and angled shanks



Figure 6.21 Field testing the sludge injector

Testing of the pump with slurry of different percentages of moisture indicated that a maximum of 10-15% solids was optimal for pumping. The solids concentration in the slurry was 35%, which meant that the slurry had to be diluted, with the 220 ℓ tank filled with 100 ℓ water and 130 ℓ slurry. The design discharge of 2.38 ℓ/s could not be achieved as the flow rate of the pump decreased with solids above 10%. At 15% a flow rate of 2.12 ℓ/s was achieved. This resulted in the application rate being reduced from the required 20 tons/ha to 12.5 tons/ha.

❖ Evaluation

Based on the costs provided by the researchers, the costs for a single application done on a 3-yearly cycle would be as follows:

Item	Rate	Cost (R/hectare)
Labour Diesel	2 labourers x R10/h x 8 hours	160.00
	R10.50/ℓ x 9.41 ℓ/h x 4.8 hours	790.00
Capital and maintenance	Cost of ripper and frame, discharge pipe, wings R9000/amortization and maintenance per hectare	30.00
Transport	20 tons sludge x R3/ton/km x 25 km	1 500.00
TOTAL COST FOR A SINGLE APPLICATION		2 480.00

The estimated cost of a sludge application is thus R2480/ha (or R124/ton), while the cost of using inorganic fertilizer in current practice is R2 400/ha/annum.

The Waste Water Treatment Works which participated in this study currently disposes of sludge at a landfill site at a cost of R300/ton (50% moisture) including labour, operations, transport and land. Disposing of sludge through injection would therefore realise significant savings in current practice.

Utilisation of sludge by the sugar cane industry could potentially be cost effective for both parties if the treatment works offset the cost to the sugarcane industry.

Environmental and social impact

The injection of sludge to provide a nitrogen source for agriculture offers several benefits:

- The slow release of nitrogen compounds from sewage carries less risk of leaching than with chemical fertilizers.
- Injection of sludge under the soil surface minimises the possibility of contact between humans and pathogens in sludge, providing a safe disposal option for sludge.

- Injection of sludge under the soil surface eliminates the risks of surface water contamination by pollutants that exist with the surface application of sludge or synthetic fertilisers.
- Less reliance on synthetic fertilizers which use increasingly scarce phosphorus which, as it grows increasingly expensive, increases food prices.
- Frees up municipal land for social development rather dedicating land for sludge disposal. Savings to municipality used to offset farmer input costs to farmer may ultimately lower retail price to consumer.

❖ **Recommendations**

The following points should be considered for further development of this technology:

- The use of a holding tank at the application site would reduce refilling time.
- A pump able to handle 35% solids is required for an application rate of 20 tons/ha.
- A mechanism to agitate the sludge in the tank would prevent settling of solids.
- Soil tests and the use of a dynamometer would assist estimations of draft.

6.4.3 Fertilizer produced with Latrine Dehydration Pasteurisation (LaDePa) pelletizer

In 2008 the eThekweni Municipality commenced the emptying of 35 000 VIPs. Discharging VIP sludge into the waste water treatment works was not a viable option because of the high nitrogen content of the sludge, which compounded problems with nitrification in the process. The high organic loading was found to overload digesters, and the quality of the final effluent was lower. In addition, it was not logical to bring sludge which had already gone through digestion in the pit into the digestion process at the plant. Sludge could not be discharged into nearby water borne sewers as sludge would need to be liquefied first and in most areas served by VIPs there is often not a sewer or a water connection nearby. In addition, the solids and grit in sludge tended to settle at the bottom of sewage pipes, creating a risk of potential blockage. In rural areas it was feasible to bury sludge on site, but sites in the urban areas of the municipality were often not big enough to accommodate this. The possibility of disposing of sludge at the landfill site was explored in line with the new guidelines for digested sludge, however the municipality was not able to obtain approval from DWAF. Off-site burial and discharge to sea outfalls seemed the only practical options.

In partnership with Cape Advanced Engineering (CAE) and Particle Separation Systems Technology (PSS) a machine was designed and patented which processes sludge into pasteurised pellets which can be applied as a fertilizer. Rubbish was separated and compacted and using PSS's patented Medium-wave Infrared Radiation (MIR) drying technique pathogens were destroyed when the core of the pellets are heated to 112-130°C and the sludge was dried to 70% solids.

Figure 6.22 Sludge being extruded through a screen prior to heat treatment

A mobile plant was set up. Transportation costs were reduced as the weight of the sludge had been reduced significantly through drying. The prototype Latrine Dehydration Pasteurisation (LaDePa) pelletizer or “spaghetti machine” was able to process 2500 kg of VIP sludge (at $\pm 70\%$ solids) per 8 hour day. Working 260 days per year, one machine could service approximately 500 pits per year. To run the machine for an 8 hour day required 100 litres of diesel fuel – or 1 litre per 25 kg dried sludge. The municipality envisions setting up a franchise with several processing stations around the city. Operators would rent the plant while entrepreneurs would collect sludge and potentially purchase pellets for sale. This system of VIP sludge processing is due for full scale testing in the eThekweni municipality in 2013.



Figure 6.23 eThekweni sludge pelletising plant

6.5 Conclusions

The South African government has taken a strong position that human excreta should, wherever possible, be used safely as a resource rather than discarded as a waste. While no regulations or guidelines currently exist for the utilisation of pit latrine sludge

unless it has been treated at a waste water treatment works – a scenario which has not proven to be workable – a number of innovative options have been developed which meet the need for faecal sludge disposal while utilizing the resources contained in sludge.

The high microbial and helminth contamination of fresh or partially decomposed faecal sludge from on-site sanitation systems preclude its use in the production of edible crops and livestock grazing.

Whether sludge is co-treated with wastewater in a WWTP, or treated in a dedicated faecal sludge treatment plant, a more solid fraction and a liquid effluent are usually produced. It is desirable to remove nutrients and eliminate pathogens before discharging effluent into bodies of water. If, however, the liquid is to be used in agriculture, nutrients should be retained.

Anaerobic digestion generally produces effluent with poor removal of nutrients and pathogens, and the choice of further treatment option will depend on the intended disposal of the final effluent. The production and utilisation of biogas from the anaerobic process supports the principle of sustainable management of faecal sludge. While the value of electricity generated from biogas production may be significant, the process still produces a waste sludge which must be disposed of. Use of biogas for heating may be a more cost-effective choice. Anaerobic treatment systems may lend themselves to decentralised sludge treatment, and strategic location of plants could reduce transport requirements and supply biogas at the point of consumption.

Composting generates high temperatures which are effective in eliminating pathogens. A pre-composting separation of solids and liquids produces an effluent with the same constraints as anaerobic digestion. Pit latrine sludge may be of sufficiently high solids content to allow co-composting with carbonaceous materials without preliminary dewatering. Land requirements for windrow composting are fairly high, and odour containment may be a problem closer to urban areas.

Planted and unplanted drying beds require large land areas, and unplanted beds are particularly ineffectual with high strength faecal sludge. Planted beds or constructed wetlands offer a possible option where land is not limited. Further investigation may be required for high strength, low moisture content sludges.

While the direct application of untreated faecal sludge to agricultural land for crop production is not desirable, potential exists for deep row entrenchment of faecal sludge in agroforestry. This would involve once-off high rate application, with minimal exposure of humans to the fresh sludge. The growing period of trees is sufficient for degradation and pathogen die-off. Burying sludge eliminates the odour and vector attraction problem. Extensive work has been done on this option using secondary WWTP sludge, and the results show significant benefits. More work will be required to investigate whether pit latrine sludge is suitable for this option.

The option of using sludge as a pathogen-free fertilizer would open up many possibilities for commercial use of sludge as an alternative source of nutrients for which there may be increasing demand as phosphorous sources used for synthetic fertilizers become more scarce.

7 PIT EMPTYING COSTS

7.1 Introduction

There are many variables involved in the determination of pit emptying costs, but the variable with the greatest effect on costs is the distance between the pit and the disposal site. Figure 7.1, which is based on the KwaZulu-Natal Department of Agriculture's annually published *Machinery Guide*, shows that the cost of running a 7 tonne truck in 2011/2012 is just over R7/km (assuming that the vehicle travels 50 000 km per annum). Of this R7/km, R4.62 is the vehicle's operating cost (fuel, tyres, oil and maintenance), and the balance is the fixed costs (depreciation, interest, licensing and insurance).

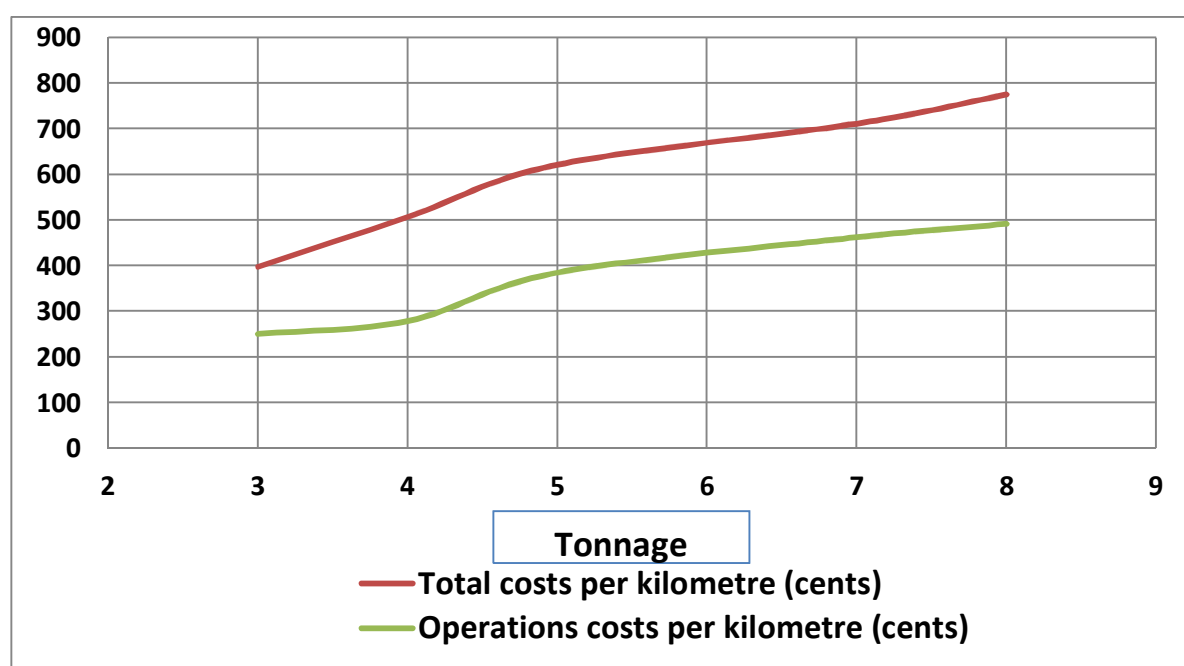

Figure 7.1 Total and running costs for various sizes of truck, assuming 50 000 km per annum usage. Figures based on the KwaZulu-Natal Department of Agriculture's annual *Machinery Guide Tables*

Not only is transport expensive, but if a vacuum tanker is being used then the time during which it is on the road is time when it is not emptying pits, so it is unproductive time. In order to contain costs it is therefore important that the sludge is disposed of at the closest suitable location. Ideally this should be on the same plot where the VIP latrine is located. In the case of the eThekweni pit emptying programme approximately 70% of the pit sludge was buried close to the pits from which it had been removed. If the plot was suitable for a VIP in the first place, there is no reason it should not be suitable for sludge disposal, as sludge can be buried in long shallow trenches rather than in a deep pit.

7.2 Costs for emptying by vacuum tanker

As indicated in the introduction above, the costs for emptying by vacuum tanker are very dependent on the distance from the pit to the sludge disposal site. Tables 7.1 and 7.2 below show the cost derivation for two scenarios for the same vacuum tanker, one where the tanker travels 600 km per day and empties just four pits, and the other where the tanker travels 200 km per day and empties 10 pits. Note

that assuming the pits are full a 5000 litre vacuum tank can only accommodate the sludge from two pits at a time.

In the case of the more efficient scenario, the cost of emptying is R402 per pit, while in the case of the less efficient scenario, the cost is more than triple, at R1 318 per pit. Allowing for a mark-up for overheads and risk, the probable contract price for these scenarios would be approximately **R550 and R1 700 per pit**.

Table 7.1 Cost derivation where tanker empties 10 pits per day, with 200 km total travel

Scenario A: 10 pits emptied per day, total travel distance 200 km	Cost per day 2011
Driver and operator	R 600
Management and supervision	R 500
Vehicle fixed costs: license, depreciation and interest spread over 150 working days per annum	R 1,000
Truck operation cost 200 km at R4.62/km	R 924
Vacuum Pump operation at R100/pit, 10 pits	R 1,000
Total cost of operation per day	R 4,024
Total cost of operation per pit	R 402

Table 7.2 Cost derivation for tanker emptying 4 pits per day, with 600 km in total travel

Scenario B: 4 pits emptied per day, total travel distance 600 km	Cost per day 2011
Driver and operator	R 600
Management and supervision	R 500
Vehicle fixed costs: license, depreciation and interest spread over 150 working days per annum	R 1,000
Truck operation cost 600 km at R4.62/km	R 2,772
Vacuum Pump operation at R100/pit, 4 pits	R 400
Total cost of operation per day	R 5,272
Total cost of operation per pit	R 1,318

By way of reference, in 2010 the Amathole District Municipality employed a contractor to empty old VIP latrines at Peddie and Glenmore. At Glenmore 780 double pits were emptied at a total cost of R844,740 or R1 083 per double pit, with disposal to a local sludge pond. At Peddie 800 units were emptied at a total cost of R472 per unit with disposal to the non-operational Peddie wastewater treatment works.

7.3 Costs for manual emptying

In December 2010 the eThekweni Metropolitan Municipality completed its first comprehensive pit emptying programme. In 2004 eThekweni had commissioned a pilot study in which pits were emptied by various methods, and concluded that the only viable option given their problems with terrain and access would be manual emptying. They employed a firm of consulting engineers as project managers, and a managing contractor and a number of subcontractors to do the pit emptying. Table 7.3 shows the breakdown of the final costs for the 30 month programme. It must be noted that as this was the first time eThekweni has been through this exercise a certain amount of the work was exploratory (for example, the sludge screening skips had to be discarded at an early stage after it was found that discharging the sludge into the sewer network was overloading the waste water treatment plants). Furthermore more efficient management structures for future phases will probably result in lower prices. The engineers responsible for the eThekweni programme believe that R1 500 per pit is a reasonable budget estimate for future phases of pit emptying. These costs include all the ancillary items such as plant hire, medical costs, health and safety inspections, insurance, quality checks and so on.

Table 7.3 Summary of costs for manual emptying of 31,856 pits, 2008-2010, eThekweni

ETHEKWINI PIT EMPTYING COSTS		31 856 pits emptied between 1/07/08 and 31/12/10	
		% of total	Average per pit
Sub-contractors	Payment to sub-contractors for pit emptying	58.8%	R 1,227
	Bulk purchases and equipment hire	9.3%	R 194
	Medical costs	1.4%	R 29
Managing Contractor	Establishment of site	1.1%	R 22
	Site foreman & accounting	2.3%	R 47
	Insurance obligation	0.8%	R 16
	Health & safety	0.8%	R 16
	Environment management	0.8%	R 16
	General costs (fixed & overhead)	0.4%	R 8
	Mark-up on sub-contractors pit emptying cost	10.3%	R 215
	Sludge screening skips (2)	0.2%	R 4
	Additional plant (tankers, trucks, etc.)	0.3%	R 6
	Skip transport, maintenance, refuse to landfill	0.2%	R 4
	Escalation less retention	1.4%	R 29
Total before project management		87.7%	R 1,832
Project Manager	Project management fee (14%)	12.3%	R 256
TOTAL (excl. VAT)		100.0%	R 2,088

eThekweni is now thinking of paying contractors per m³ of sludge brought to their disposal site, rather than per pit emptied. This may realize efficiencies in that contractors will focus on emptying the fullest toilets and will not waste time emptying toilets which are not full.

Going back to first principles, the actual labour cost to empty a pit of approximately 2 m³ volume should not be more than R300. To dig a nearby disposal pit should not cost more than R200. It should however be possible to get the pit owners to dig their own disposal pits i) as their contribution to the exercise, ii) as a way of finding out which pits most need emptying, and iii) as a way of discouraging the use of pits for the disposing of solid waste. The basic cost for emptying and disposal (assuming on-site disposal) should then be in the R300 to R500 range. Further expenses that must be allowed for are:

- Medical care for pit emptying workers
- Personal protective equipment
- Tools
- Transport
- Quality Assurance (site supervision)
- Project Management
- Overheads

With reference to Table 7.3, the total estimated cost for manual emptying can easily mount up to **R1 250 per pit emptied**, depending on programme efficiencies. The only way to accurately understand the costs will be to start working and to keep good records.

7.4 Budget costs for dealing with movable VIP toilets

Many Water Service Authorities have opted for movable precast VIPs for the balance of their sanitation backlogs. Given the hazards, costs and unpleasantness associated with the emptying of fixed VIPs, and where space for the relocation of VIPs is not a constraint, this is a sensible option. However it would be a mistake to assume that precast VIPs can be moved at some point in the future at no cost to a municipality. Figure 7.2 shows what can happen to precast VIPs when they are erected without due care for the correct foundation preparation.



Figure 7.2 Precast VIPs erected at Dutywa in the Eastern Cape which have collapsed due to inadequate foundation preparation

The work entailed in moving a pre-cast toilet is as follows:

- A new pit must be dug with the correct dimensions to match the precast VIP structure
- Some form of foundation and collar must be constructed on which the precast toilet will rest
- The precast toilet must be dismantled without damaging any of its components (which means that any bolts and nuts should preferably be stainless steel otherwise dismantling after a number of years may not be possible)
- If any of the components are damaged or broken during the dismantling process, these must be fixed or replaced
- The structure must be re-erected over the new foundation and pit
- The old pit must be filled in and covered

While it would be worth waiting to see if homeowners do start to move their toilets of their own accord without any mishaps, it would also be wise to budget to assist with the process if necessary. Allowing for labour, materials, supervision and management a cost of **R1000 per site for moving** a pre-cast latrine should be achievable.

7.5 Life cycle costing²

The life cycle cost can be related directly to the frequency with which a latrine must be moved or emptied. Table 7.4 illustrates the expected life cycle cost for different latrine options assuming on site disposal of waste. The capital cost of the fixed structures is set to zero as this is existing infrastructure. The Net Present Value of maintaining the different options is considered over a 30-year cycle for varying pit volumes.

It should be noted that the life cycle costing considers small pit volumes of a little as 0.5 m³. For unlined pits, it is considered unsafe to empty the pit contents below the collar as the saturated soil may collapse thereby undermining the superstructure. The life cycle cost of unlined pits must therefore consider the impact of more frequent emptying. The NPV calculation confirms that if the useable pit volume is 0.5 m³ it is cheaper to replace the latrine for a moveable structure.³ However, if the useable volume is 1 m³ or more it is cheaper to empty the pits.⁴

A specification for pit emptying is included in Appendix E. Pits should not be excavated more than 1.5 m below the slab level. Deeper excavation is not normally practical by any of the pit emptying methods and as such after the first emptying the useful pit volume is likely to be reduced to 1.5 m³ depending on the pit design. **A budget of R282 per household per annum can be budgeted for a fixed VIP Latrine with a useful pit volume of 1.5 m³.**

The Double Pit VIP latrine is designed to enable the pit contents to dry and decompose while the second pit is filling, in theory reducing the health risks associated with the handling of the waste. Where homeowners take full responsibility for emptying pits, this provides an attractive option. However, where the WSP must pay for pit emptying, a slight reduction in faecal contamination has little impact in the emptying cost. In this instance it is estimated that emptying pits simultaneously when both are full would save R171 per latrine per annum since it is more cost effective to empty both pits simultaneously

² The contribution of Jonny Harris of Maluti GSM to this section is gratefully acknowledged.

³ Unless the cost of providing this infrastructure is greater than R7500

⁴ Unless the capital cost of the moveable structure was less than R3500, which is considered un-achievable for recent sanitation programmes which have typical costs of R6000 to R7000, including all management and overheads.

than make more frequent visits. **A budget of R225 per household per annum can be budgeted for Double Pit VIPs with a combined volume of 2 m³.**

The cost savings associated with larger pits can be effectively realised for movable structures. **A budget of R155 per household per annum can be budgeted for a moveable structure with a pit volume of 2.5 m³.**

The annual maintenance cost of a movable VIP latrine is therefore estimated to be R127 per household per annum less than the cost of an equivalent fixed VIP latrine.

Table 7.4 Life Cycle Cost

Description	Capital Cost	Pit volume m ³	Filling Rate (years)	Maintenance Cost		NPV 30-year
				(per empty)	(annual)	
Moveable structure	R 4 925	1.5	4.2	R 925	R 222	R 8 151
	R 5 000	2	5.6	R 1 000	R 180	R 7 616
	R 5 075	2.5	7.0	R 1 075	R 155	R 7 325
	R 5 150	3	8.3	R 1 150	R 138	R 7 156
Fixed block structure	R 0	0.5	1.4	R 1 025	R 738	R 10 726
	R 0	1	2.8	R 1 100	R 396	R 5 755
	R 0	1.5	4.2	R 1 175	R 282	R 4 099
	R 0	2	5.6	R 1 250	R 225	R 3 270
	R 0	2.5	6.9	R 1 325	R 191	R 2 773
	R 0	3	8.3	R 1 400	R 168	R 2 442
Double pit	R 0	1	2.8	R 1 100	R 396	R 5 755
	R 0	2	5.6	R 1 250	R 225	R 3 270

A comparison between the maintenance costs of a 2 m³ pit with a 3 m³ pit provides some indication of the potential saving that can be achieved through eliminating trash in the pit, which has been assessed to extend the pit life by as much as 50%. Elimination of trash from VIPs could save R57 per household per annum for a fixed VIP latrine.

The life cycle cost of the different options is fundamentally related to pit volume and filling rates. The economic benefit of having larger pits free from trash can be significant. Increasing the pit volume from 2 m³ to 3 m³ will save R42 per household per annum for an additional capital cost of R150.

An Excel model for calculating pit emptying costs has been developed and is available from Partners in Development. More information on this model can be found in Appendix F.

8 CONCLUSIONS AND RECOMMENDATIONS

In South Africa, with hundreds of thousands of VIPs expected to reach capacity in the near future while some municipalities have already begun to stockpile pit sludge, it is a matter of urgency that municipalities and Water Services Authorities accurately assess their existing on-site sanitation and put realistic plans and budgets in place to maintain systems, empty pits when needed and treat and dispose of sludge effectively, safely and – wherever possible – beneficially.

8.1 Municipal waste management and full pits

Investigations conducted during this research indicated that appropriately sized pits could take as long as 25 years to fill under optimal conditions. The most significant variable determining whether a pit fills in 5 years or 25 years is whether it is used for disposal of rubbish. Many municipalities in South Africa still do not provide effective or reliable solid waste collection to all of their residents, leaving householders with few safe and discrete options for disposal of their hazardous and personal waste other than the pit. Well-run solid waste collection programmes therefore have a significant impact on sanitation requirements. Rubbish also blocks emptying equipment, resulting in delays and additional maintenance costs during emptying.

In addition, if housing provided by municipalities does not provide for the disposal of household wastewater, this may also be disposed of in the pit. Depending on the permeability of the soil, this may contribute to the rate at which the pit fills, and cleaning agents present in grey water may impede biological degradation in the pit.

8.2 Additives: enhancing biological activity in the pit

Research on a number of additives has found them to be ineffective in reducing sludge volumes or slowing sludge accumulation. As the bacteria necessary for degradation are already present in faeces and increase to the extent that conditions allow, it is unlikely that adding bacteria could significantly enhance the efficiency of processes already occurring in the pit. In addition, the more rapid degradation that is achieved by aerobic bacteria ultimately leaves more non-degradable biomass in the pit. Should a product be developed which does significantly impact sludge accumulation, however, it could greatly aid the management of on-site sanitation.

There is an urgent need for a standardised laboratory test protocol that is able to investigate the effects of additives under optimised, controlled and repeatable conditions. A test protocol will elucidate any catalytic or other processes that the product may enhance and inform how best to recreate or augment these conditions in the field. Manufacturers, consultants, DWA, SALGA, *etc.* should be encouraged to provide input that assists in the development of a suitable protocol. Researchers should avoid a test procedure that attempts to mimic the field situation in the lab (there is no "standard" field situation).

The Farm Feeds and Fertilizers Act (Act 36 of 1947) requires that all fertilizers, farm feeds and supplements are tested and registered in terms of the Act. This Act was promulgated in order to prevent sellers from making unsubstantiated claims and deceiving consumers. Similar legislation is required to prevent sellers of bio-additives from making unsubstantiated claims about their products.

Until a standard test protocol is developed and put into force, the onus should be placed on manufacturers to demonstrate where and under what circumstances their products have worked.

It is unadvisable for sanitation departments to spend money on costly additives when it is extremely unlikely that this will slow the filling of pits.

8.3 Preventing disease transmission during pit emptying

Sludge typically contains a range of bacteria, viruses and human parasites which pose a health threat. Some of these can survive for long periods of time in sludge or in the environment and can be transmitted through the air or through contact with surfaces that have been contaminated. With diseases transmitted from faeces still a major cause of death among children under the age of five, it is of utmost importance that workers, householders and household surfaces are protected from contact with sludge at all times during pit emptying. Sanitation departments should ensure that workers are provided with immunisations and regular deworming and are provided with the equipment and clothing necessary to protect themselves and the site from contamination. Training in prevention of disease transmission, protocols to handle spills and correctly transport and disinfect clothing and tools is also recommended.

8.4 Effective pit emptying methods

The moisture content of pit sludge may vary depending on factors such as soil conditions, disposal of water in the pit and rainfall/water table, but in general pit sludge is relatively dry and cannot easily be removed with a vacuum tanker. The presence of rubbish frequently complicates vacuuming of pit sludge as well. eThekweni Municipality conducted an assessment to determine the most effective method of emptying pit latrines and concluded that until technologies exist which are better matched to the characteristics of pit sludge, manual emptying is the most effective method for pit emptying. Where wetter sludges are found, vacuum tankers may successfully empty pits. This may be aided by raking out rubbish beforehand. Liquefying pit sludge by adding water to the top has not proven very successful, but some success has been found by pumping air mixed with water into the sludge below the surface.

Other factors that may limit the success of vacuum tankers are dense settlement patterns or terrain that does not allow a tanker access to the site at a suitable elevation.

Further development of small machines suitable for pit emptiers such as the eVac may lead to technologies which can be made widely available.

8.5 Transport

A transfer station allows sludge to be brought to a point near to the sites being emptied using a short haul vehicle such as a tractor, from where it can be collected and transported to the eventual disposal site using a suitable long haul vehicle. If it is possible to dewater the sludge before carrying out long haul transport, that will increase efficiencies and reduce costs.

8.6 Disposal

Disposal of pit latrine sludge has become a massive problem for some municipalities and, with a large number of pits in South Africa anticipated to reach capacity soon, is going to become an even greater difficulty. Treatment of dense pit sludge at waste water treatment works has been found to quickly

overload the works. In addition, adding water to a dry sludge and putting it through a stabilisation process when it is already relatively stable and will then need to be dewatered is counterproductive.

While the South African government has taken steps to reorient the management of waste water treatment sludge away from disposal to beneficial use, pit sludge has not been included in these recommendations. With VIP toilets the standard model for basic sanitation in South Africa, clear and practical guidelines need to be developed to equip municipalities to manage this type of sludge.

Existing options include composting, which allows nutrients to be used safely if done correctly but may prove costly. Biogas generation utilises the energy potential of sludge, while still producing a sludge by-product, though much reduced. eThekweni Municipality has pioneered a method for pasteurising and pelletising sludge for use as a fertiliser; this shows promise for wider application. A current Water Research Commission project is investigating the impact of burial of sludge for use in agroforestry, which could prove to be an effective solution for the disposal of both pit sludge and sludge from treatment plants. The need of low income households in South Africa for greater food security and improved nutrition are compelling reasons to explore possibilities for the safe and beneficial use of sludge by householders – an option which would also eliminate the need for transport of sludge off site. Further research into both the benefits and risks of burying sludge for growing fruit trees, as well as simple and reliable methods for households to convert sludge into a pathogen-free compost which could be safely used for growing vegetables, would be of value.

9 REFERENCES

- Aalbers, H. (1999) *Resource recovery from faecal sludge using constructed wetlands*. WASTE, Netherlands.
- Agrawal, N., Chacko, M., Ramachandran, M. and Thian, M. (2011) Report to the London School of Hygiene and Tropical Medicine: *Assessing the Commercial Viability of Black Soldier Fly as Biodiesel & Animal Feed*. University of California Berkeley – Haas School of Business.
- Balboni, E. (2007) *Investigation into mechanisms of VIP additives* In Progress report (Jan 2006 to Jan 2007). WRC Project K5/1630.
- Brouckaert, C.J., Foxon, 2008, unpublished report, *Comparison between VIP sludge and sewage*.
- Business Partners for Development (BPD) (2001) *Sanitation provision in low-income areas of Pietermaritzburg*, Msunduzi Local Authority
- Buswell, C. (2006) *Fate and Transport of Nitrogen at a Deep Row Sludge Application Hybrid Poplar Tree Farm*. Masters Thesis, University of Maryland.
- Carter, R. and Byers, M. (2006) *Landscaping and Review of Approaches and Technologies for Water, Sanitation and Hygiene: Opportunities for Action*. Bill and Melinda Gates Foundation.
- Chaggu, E.J., Sanders, W. and Lettinga, G. (2007) *Demonstration of anaerobic stabilization of black water in accumulation systems under tropical conditions* Bioresource Technology 98 (2007) 3090-3097 Available: www.sciencedirect.com
- Coffey, M. (2006) *Off-Site Disposal of Latrine Wastes*. 1st International Symposium and Workshop on Faecal Sludge Management (FSM) Policy.
- Coffey, M (2011) Presentation to the first Faecal Sludge Management seminar FSM1, Durban, 2011
- Cofie, O. and Kone, D. (2008) *Co-composting of faecal sludge and solid waste for urban agriculture*. Sustainable Sanitation Alliance.
- Cordell, D. (2010) *The Story of Phosphorus: Sustainability implications of global phosphorus scarcity for food security*. PhD thesis, Linköping University Press.
- Department of Water Affairs and Forestry (1994). *White Paper: Water Supply and Sanitation Policy*. South Africa.
- Department of Water Affairs and Forestry (2005) *National Sanitation Strategy: Accelerating Sanitation Sector Delivery* Available: www.dwaf.gov.za/Documents/
- Department of Water Affairs and Forestry (2006) *Report Of The Department Of Water Affairs And Forestry, 1 April 2005 to 31 March 2006*. Available www.dwaf.gov.za/Documents/
- Department of Water Affairs and Forestry (2007) *Water Services WSDP Support Tool*. Available: www.dwaf.co.za/dir_ws/WSDP

Departments of Agriculture, Health, and Water Affairs (1997). *Permissible Utilisation and Disposal of Sewage Sludge. Edition 1.* WRC Report No. TT85/97.

Ethekwini Municipality Water and Sanitation Unit (EWS) and UWP Consulting Unit (2004). *Pit Latrine Evacuation study completion report.*

Foxon, K.M. and Buckley, C.A. (2005). *The ABR Concept: A holistic approach to managing wastewater from low-income communities and institutions.* Third International Conference on Ecological Sanitation.

Franceys, R., Pickford, J., and Reed, R. (1992). *A Guide to the Development of On-site Sanitation.* World Health Organisation: Geneva.

Heinss, U., Larmie, S.A. and Strauss, M. (1998). *Solids separation and pond systems for the treatment of septage and public toilet sludges in the Tropics – Lessons learnt and recommendations for preliminary design.* EAWAG/SANDEC Report No. 05/98.

Heinss, U, Strauss, M. and Larmie, S.A (1997) *Tons of excreta and ways to treat them.* 23rd WEDC Conference Durban, South Africa.

Herselman, J.E. and Snyman, H.G. (2007) *Guidelines for the utilisation and disposal of wastewater sludge Volume 4: Requirements for the beneficial use of sludge at high loading rates.* Water Research Commission.

IWMI and SANDEC, 2002. *Co-composting of Faecal Sludge and Solid Waste.* Swiss Federal Institute of Aquatic Science (EAWAG), Switzerland.

Kays, J. S.; Felton, G. K.; Buswell, C. U.; Flamino, E. J. (2007) *Deep Rows Incorporation of Sludge to Grow Hybrid Poplar Trees on Sand and Gravel Mine Spoils in Southern Maryland.* Water Practice, Volume 1, Number 1, April 2007, pp. 1-15(15)

Kelly, G. (2006) *Recycled Organics in Mine Site Rehabilitation: A review of the scientific literature.* Department of Environment and Conservation NSW [Online] www.environment.nsw.gov.au

Koottatep, T., Polprasert, C., Nguyen T.K.O., Surinkul, N., Montangero, A. and Strauss, M. (2002). *Constructed Wetlands for Septage Treatment – Towards Effective Faecal Sludge Management.* In: Proceedings, 8th International Conference on Wetland Systems for Water Pollution Control Arusha, Tanzania, Sept. 16-19. [Online] Available: <http://www.sandec.ch/FaecalSludge/Documents>

Lettinga, G., der Man, A., van der Last, A. R. M., Wiegant, W., Knippenberg, K., Frijns, J. and van Buuren, J. C. L.. (1993) *Anaerobic treatment of domestic sewage and wastewater.* Wat. Sci. Tech., 27(9), 63-73.

Magagna, D. (2006) *Definition of a model structure for a Ventilated Pit Latrine (VIP).* In Progress report (Jan 2006 to Jan 2007). Water Research Commission Project K5/1630.

Marais, G. v R. and Ekama, G.A. (1984). *Theory, Design and Operation of Nutrient Removal Activated Sludge Processes.* Water Research Commission.

Muller, M.S. and Rijnsburger, J. (1992): *MAPET. A neighbourhood based pit emptying service with locally manufactured hand pump equipment in Dar es Salaam, Tanzania.* Gouda.

National Treasury of South Africa (2007) *Division of Revenue Bill, Annexure E.* Available www.treasury.gov.za

Norris, J.A. (2000). *Sludge Build-Up in Septic Tanks, Biological Digesters and Pit Latrines in South Africa.* WRC Report No. 544/1/00.

- Nwaneri, C., Mkhize, S., Buckley, C.A. and Foxon, K.M. (2007) *Research into the processes occurring inside the pit of Ventilated Improved Pit Latrines*. In Progress report of WRC Project K5/1630, Scientific support for VIP design and operation.
- Panesar, A., Bischoff, J. (2008). *Sustainable sanitation in India – Examples from Indo-German Development Cooperation*. GIZ, Germany.
- Pearson, I. & La Trobe, B. (1999). *Co-Disposal and Composting of Septic Tank and Pit Latrine Sludges with Municipal Refuse*. WRC Report No. 599/1/99.
- Radford, J. (2011) *Fluidisation of synthetic pit latrine sludge*, Final year research report, Cambridge University
- Rosemarin, A. and de Bruijne, G. (2009). The next inconvenient truth: Peak phosphorus. *The Broker*, 15.
- Snyman, H.G. and Herselman, J.E. (2006a). *Guidelines for the utilisation and disposal of wastewater sludge Volume 1: Selection of management options* Water Research Commission.
- Snyman, H.G. and Herselman, J.E. (2006b) *Guidelines for the utilisation and disposal of wastewater sludge Volume 2: Requirements for the agricultural use of wastewater sludge*. Water Research Commission.
- Strauss, M. and Montangero, A. (2000) *Cities without sewers*. EAWAG News 48.
- Strauss, M., Koné, D., and Saywell, D. (2006b). Proceeding of the 1st Int. Symposium and Workshop on Faecal Sludge Management (FSM) Policy. EAWAG/SANDEC IWA.
- Strauss, M., Larmie S. A., Heinss, U. (1997). *Treatment of Sludges from On-Site Sanitation: Low-Cost Options*. Water Science and Technology, 35(6).
- Strauss, M., Larmie S. A., Heinss, U. and Montangero, A (2000). *Treating faecal sludges in ponds*. Water Science and Technology Vol 42 Nos 10-11 pp 283-290 [Online] Available: <http://lequia.udg.es/lequianet/WatSciTech/04210/0283/042100283.pdf>
- The United Nations Children’s Fund (UNICEF)/World Health Organization (WHO)(2009). *Diarrhoea: Why children are still dying and what can be done*.
- van Lier, J.B., Zeeman, G., van Buuren, J.C.L. and Lettinga, G. (1999) *Decentralised sanitation concepts: perspectives for reclamation of domestic sewage for agricultural production by using low-cost treatment technologies*. EP & RC Foundation, Wageningen, The Netherlands.
- Wagner, E.G. and Lanoix, J.N. (1958). *Excreta disposal for rural areas and small communities*. World Health Organisation Monograph no. 39.
- WASTE. MAPET in narrow street in Tanzania . [Online] akvo. [Cited: April 14 , 2009].

Appendix A: Survey: Strategies for Management of Pit Latrine Sludge

QUESTIONNAIRE NUMBER:
<p>Background</p> <p>The Water Research Commission has commissioned a research project to develop strategies for the management of sludge from on-site sanitation systems, principally Ventilated Improved Pit latrines (VIPs). Most VIPs in South Africa are constructed with a pit volume of between 2 and 3 cubic metres, and are used by between 4 and 12 people. This means that after between five and ten years, most VIPs are full, and need to be moved, rebuilt or emptied. The South African government's commitment to provide free basic services, including sanitation, to all poor people, means that municipalities have to come up with strategies and budgets for either emptying or replacing VIPs and other on-site sanitation systems. The cost of this work is provided for as part of the Equitable Share grant which all municipalities receive each year. This survey forms part of the WRC project which aims to assist municipalities to develop plans and strategies to manage this process.</p>
<p>Scope of the survey</p> <p>In summary this survey will cover the following:</p> <ul style="list-style-type: none"> • Consolidation of knowledge on faecal sludge build-up and intervention strategies • Establish first order estimate of how many pits are reaching the end of their operational lifespan • Establish to what extent Water Services Authorities have begun to plan and/or budget to either empty VIPs or replace them.

MUNICIPAL CONTACT DETAILS

Date of interview/visit				
Province				
WSA Name				
WSA Contact Person				
Contact Person's Position				
WSA Contact numbers	[Tel]		[Fax]	
WSA E-mail address				
WSA Web Address				
WSA Postal Address				
WSA Physical Address				
Questions by interviewer	Responses			
1. VIP top structures (approximate numbers)	No. of Moveable		No. of Immoveable	
2. Who is responsible for O&M?	Householders	Municipality	Shared responsibility	
3. Do you have a policy regarding the emptying or moving of VIPs?	Yes	No		

4. Does your municipality currently budget for the emptying or moving of full pit latrines?	Yes	If so, approximately how much per annum?		No
5. If your answer to question 4 above was no, do you expect this to change in the next five years?	Yes	No	Don't know	
6. Does your municipality charge the public for the emptying of full pit latrines?	Yes	If so, how much?	No	
7. How many pit latrines do you plan to empty each year?	Where the emptying is paid for by the municipality		Where the emptying is paid partially by the municipality	
8. Who does the pit emptying?	Own staff and equipment %		External contractors %	
9. What method of emptying do you utilize?	Vacuum tankers %		Manual methods %	
	Sludge pumps %		Other (describe) %	
10. If you do empty latrines, which of the following methods do you use for pit sludge disposal?	on site burial %	off-site burial %	disposal in sludge drying beds %	disposal into sewage works %
	disposal into sewer system %		other (please describe)	
11. On average, how often are pits emptied?	Every 3 years	Every 5 years	Every 7 years	Every 10 years
12. On average are pit substructures lined and stable enough to ensure no risk of collapse on emptying?	Yes (%)	No (%)		
13. Do you have a long term health and hygiene user education and awareness programme in place?	Yes	No		
14. Does your municipality support the use of additives (i.e. enzymes, powders, bio-augmentation, etc.) for the	Yes	No		

reduction of pit latrine contents?				
15. If you answered “yes” to Question 15, do you endorse a particular product?	Yes	No		
16. If you answered “yes” to Question 15, do you subsidise the use of a particular product?	Yes – Free Issue	Yes – price of product is subsidized by municipality	No – Users pay full price. We only recommend its use.	
17. If you do subsidize the use of any pit additives, how much does your municipality spend on this support per annum?				
18. If you do subsidize the use of any pit additives, approximately how many sites benefit from this treatment on a monthly basis?				

Summary of data collected on the majority of survey questions

NB: "New" indicates a response that the VIPs had not yet needed to be desludged since being built and decisions regarding desludging were still pending or it was too early to know yet how frequently they would need to be desludged.

MUNICIPALITY	VIPs: moveable/ immoveable	Age of first VIPs	Responsible: municipality/ householder	Policy	Budget	Health programme	No. emptied/yr	Frequency	Emptied municipality/ contractor by:	Cost to household	Additives
EASTERN CAPE (EC)											
<i>The following 5 WSAs indicated that they do not have VIPs: Blue Crane Route, Ikwezi, Koukamma, Ndlambe, Nelson Mandela Metro</i>											
Alfred Nzo	20 000 (I)	5	H/M	N	R130 000 for additive	Y	0	4-5 yr	none	0	Y
Amathole	39 976 (I)		H/M	Y	Y: R222 000	Y	293	5 yr	M	0	Y
Baviaans	45 (I)	8	M	N	N: in 5 yr Y	No:plann ing	180	3 mo	M	0	N
Buffalo City	15 000 (I&M)	12+	H	N	N	N	0	5 yr	none	N/A	N
Camdeboo	200 (I)		H	N	N	N	?	5 yr	M	Y: varies	Y
Chris Hani	45 520 (I)		?	N	N	N	?	5 yr	C	Y: varies	pendin g
Kouga	1100 (I) digester		M	Y	Y	Y	?	3 yr	M	0	N
Makana	2100 (M)	2	M	N	?	N	?	1 mo	M/C	0	N
OR Tambo	119 263 (I)	8	H	N	N: in 5yrs Y	N	new	5 yr	Pendi ng	pending	pendin g
Sunday's River Valley	2000 (I)	+6	H/M	N	N:phasing out	N	1 200	6 mo- 2 yr	M	R26	N
Ukhahlamba	14 000 (M)	5	H	N:dr aft	N:drafting	No:plann ing	0	7 yr	none	N/A	N
FREE STATE (FS)											
<i>The following 9 WSAs indicated that they do not have VIPs: Masilonyana, Nala, Metsimaholo, Kopanong, Mohokare, Naledi, Tswelopele, Mafube, Matjhabeng</i>											
Dihlabeng	3372 (I)		H	?	N	N	0	0	none	N/A	N
Letsemeng	900 (I)	3	H/M	N	N:conver ting	No: planning	new	new	M	0	N
Maluti-a-Phofung	5000 (I)	5	M	N	N: R480 000	Y	0	0	?	0	Y
Mangaung	34 000 (I+M)	6	M	N	N	?	34 000 /need	1 yr	M/C	Flat rate	?
Mantsopa	200 (I)	0	Farmer s	Y	N/A	N	0	0	none	N/A	N
Moqhaka	1600 (M)	3	H/M	N	N:conver ting		new	?	M	0	N

MUNICIPALITY	VIPs: moveable/ immoveable	Age of first VIPs	Responsible: municipality/ householder	Policy	Budget	Health programme	No. emptied/yr	Frequency	Emptied municipality/ contractor by:	Cost to household	Additives
Ngwathe	2 000 (M)		H/M	N	Y	N	As need ed	5 yr	M	0	Y
Nketoana	747 (l)		H/M	N	Y: converting	Y	?	6 mo- 1 yr	C	0	Y
Phumelela	120 (M)	0	M	N	Y: R40 000	Y	120	1 yr	M	0	Y
Setsoto	1602 (l)	6	M	N	N (R800- 1000/VIP) converting		1600	1 yr	none	0	Y
Togologo	2796 (M)	0	M	Y	N:won't empty	N	0	0	none	N/A	pen ding
GAUTENG (G)											
<i>The following 4 WSAs indicated that they have no VIPs: Ekurhuleni, Kungwini, Randfontein, Emfuleni</i>											
Johannesburg	40 326 (M)	4	H/M	N	Y: R15.6m/yr	Y: New Services Dvlpmt Dept	40 300	1yr	C	0	N
Lesedi	1 200 (M)		H/M	N	N	N	new	new	new	0	N
Midvaal	Not available		H	N	N	Y	0	N/A	none	N/A	Y - TLC
Mogale City	1 500 (M)		H/M	N	N: Y 5 yrs	N	?	4 yr	C	0	N
Nokeng Taamane	300 (l)	8	H/M	N	N	N	0	8 yr	C	R1200	Y
Tshwane	8 000 (l) (3 000 UD & 5 000 VIP)	8	H:6000 M:2000	Y	N	Y	2 000	1 yr	C	0	N
Westonaria	7 859 (l)	3	M	Y	Y:converting	Y	15 600	6 mo	M	0	N
KWAZULU-NATAL											
Amajuba	2 945	5	H	N	Y	Y	?	?	C	pending	N
eThekweni	50 000		M	Y	Y:R18m/yr	Y	10 000	5 yr	C	0	N
iLembe	35 000	8	H/M	N	N: pending	N	few	5 yr	C	0	N
Msunduzi	20 000 (l)		H	N	N	N	0	0	none	N/A	N
Newcastle	7000 (l)	14	M	Y	Y	Y	14 000	6 mo	C	0	N
Sisonke	11 850		H	N	N	N	0	new	none	N/A	N
Ugu	69 000 (M)	6	H/provi nce	N	N: converting	Y	?	5 yr	C	0	N
uMgungundlovu	22 000	9	H	draf	N: in 5 yrs	planning	0	0	none	N/A	N

MUNICIPALITY	VIPS: moveable/ immoveable	Age of first VIPs	Responsible: municipality/ householder	Policy	Budget	Health programme	No. emptied/yr	Frequency	Emptied municipality/ contractor by:	Cost to household	Additives
				t	Y						
uMhlatuze	5 400 (M) UD (2 pit)	2	M	N	N: pending	Y	new	5 yr	new	pending	N
Umkhanyakude	40 000 (M) 10 900 (I)	6	H/M	N	N: new	Y/N	0	N/A	none	N/A	N
Umzinyathi	40 000 (M/I)		H/M	N	N: 5yrs Y	Y: Dept Health	?	7 yr	C	0	N
Uthukela	29 000 (I)	9	H	N	N	Y	0	5 yr	M/C	0	N
Uthungulu	4 500 (M) 12 000 (I)		H	N	N: 5yrs Y	Y	0	0	none	pending	pen ding
Zululand	70 000 (I)	10+	H	N	N	N	0	0	none	N/A	N
MPUMALANGA (M)											
<i>The following 2 WSAs indicated that they do not have VIPs: Steve Tshwete, Delmas</i>											
Albert Luthuli	11 000 (I) 11 000 (M)		H	N	N	N	none	non e	none	N/A	N
Bushbuckridge	1 200 (I)	2	M	N	N: Next yr Y	Y: DWAF starting	?	2.5 yr	C/M	Part of R50/mo fees Businesses/loa d	N
Dipaleseng	88 (I)	0	H	?	N: district does Y from '09	N	new	new	M	0	N
Emakhazeni	1 087 (I)	0	M	N	Y R6m/yr	Y	new	2 wk	M	0	N
Emalaheni	2 000 (I)	4	M	Y	Y R8m/yr	N	new	5yr	C	0	N
Govan Mbeki	3 500 (M)		M	N	N: convertin g	N	7000	6 mo	C/M	0	N
Lekwa	64 (M)		H	N	N	Y – in urban	0	N/A	none	N/A	N
Mbombela	9 500 (I)	0	M	N	Y	Y	new	new	C	0	N
Mkhondo	?	10	M	Y	N	?	0	0	none	N/A	pen ding
Moroka	57 800 (M)	20+	H M if indige nt	N	Y: R6m	Y	?	5 yr	M	R80 0:indigents	N
Msukaligwa	484	0	M	N	N: in 5 yrs Y	N	new	new	M	0	N
Nkomazi	90% pop		H/M	draft	N: Y in 5 yr	Y	0	5 yr	none	0	N
Pixley ka Seme	2 500 (M) 1 500 (I)		H-600 M- 3400	Y	Y	N	800	10 yr	M	Y	N

MUNICIPALITY	VIPS: moveable/ immoveable	Age of first VIPs	Responsible: municipality/ householder	Policy	Budget	Health programme	No. emptied/yr	Frequency	Emptied municipality/ contractor by:	Cost to household	Additives
Thaba Chweu	5 598 (I)	10	H	N	N	N	N/A	N/A	none	0	N
Thembisile Hani	4 500	1	H/M	Y	Y	Y	?	?	M	Y	N
Umjindi	550 (M)	3	TBA	N	N: DPLG pays	N	300	1 yr	C	0	Y
NORTHERN CAPE (NC)											
<i>The following 5 WSAs indicated that they do not have VIPs; Sol Plaatje, Ga-Segonyana, Phokwane, Magareng (only Envirolloos on farms), Ubuntu</i>											
Dikgatlong	No records		M	draft	Y	N	?	1 yr	M	R150 non- indigent	N
Emthanjeni	200 UD	2	H/M	N	N: converting	pending	400	6 mo	C	Y	N
Gamagara	1000 (I)		M	N	N: converting	N	none	non e	none	0	N
Hantam	350 (I)	5	H	N	Y: R60/VIP	Y	350	1 yr	M	R10	N
!Kai! Garib	2000 (I)	10+	H	N	N	Y	30	5 yr	M	0	N
Kamiesberg	723 VIP (I) 1 108 UD	10+	H/M	N	N	N	5	10+	M	R90	N
Kareeberg	850	15	H	N	N	Y	none	non e	none	0	Y
Karoo Hoogland	400 (I) UD		H/M	N	N: In 5 yr Y	Y	50/wk	2 wk	C	R35	N
Kgatelopele	6 pourflush		H/M	N	N	N:planni ng	12	6 mo	M	R65	N
Khai-Ma	400 (M)	4	H	N	N	N	0	6-12 mo	?	N/A	N
//Khara Hais	4000	10+	M	N	Y: R100 000	Y	50	10 yr	M	0	N
!Kheis	53 (I)	10+	H	N	N Fees cover	N	?	10+	M	Per load	N
Mier	480 (I)	16	M	N	N: In 5yr Y	N	300	5 yr	M	0	N
Moshaweng	1500 UD/VIP (M) 909 now	3	M	N	N: in 5yrs Y	N	new	new	new	0	N
Nama Khoi	600 UD	3	M	N	N Fees cover	N	cycle	2 yr	C	R14/mo	N
Renosterberg	120 (I/M)	5	H/M	N	Y: from district	Y contracte d	new	new	new	0	N
Richtersveld	150	10+	H/M	N	N: in 5yrs Y	Y:Dept Health	?	3 yr	M	varies	N
Siyancuma	800 VIP 360 UD	4	H/M	N	Y: converting R85/toilet	N	300	1 yr	M	0	N
Siyathemba	650 (M)		H/M	N	Y: R258/toilet	N	150	3 yr	M	R21/mo	N
Thembehle	690 (M)	2	H/M	N	N: R60/toilet	N	700	1 yr	M	0	

MUNICIPALITY	VIPS: moveable/ immoveable	Age of first VIPs	Responsible: municipality/ householder	Policy	Budget	Health programme	No. emptied/yr	Frequency	Emptied municipality/ contractor by:	Cost to household	Additives
					N: In 5 yr Y						
Tsantsabane	365 UD/VIP 50 bacterial		M	N	Y: R840/bact erial toilet, R100/VIP	N	?	3 mo	M	0	N
Umsobomvu	1 600 (l)	3	M	N	N: in 5yrs Y	N	?	2.5 yr	C	0	Y
NORTHWEST (NW)											
Bophirima	24 000 (M)		M	N	N: in 5yr Y	N	0	non e	none	0	Y
Central District	107 086	5	H/M	N	N	N: pending	960	7 yr	M	R100	N
Kgetlengrivier	600 (l)		M	N	Y	N	?	1 mon th	M	R300/load	Y
Madibeng	600 (l)	1	H	N	N	Y	new	new	new	pending	N
Maquassi Hills	800 (l)	10+	M	N	Y	Y	3 200	3 mo	M	R20	N
Matlosana	400 (M)	3	Schoo ls	N	N	N	0	non e	none	N/A	N
Merafong	3 000 (M)	5	M	draft	Y: R62 mill	Y: other dept	1 200	3 mo	M/C	0	Y
Moretele	4 500 (l)	3	M	N	N: pending	N	new	new	new	pending	N
Moses Kotane	10 000 (M/l)	5	H	N	N	Y	0	4 yr	none	N/A	N
Rustenburg	5 000 (M)	10+	H	N	N	N	0	7	pendi ng	pending	p e n d i n g
Tlokwe	29 (M) 104 (l)		M	N	N	Y	1595	1 mon th	C	0	Y
Ventersdorp	1 000 (l)	0	H	Y	N: In 5 yr Y	Y	0	non e	none	N/A	N
WESTERN CAPE (WC)											
<i>The following 16 WSAs indicated that they do not have VIPs: Matzikama, Cedarberg, Bergrivier, Saldanha Bay, Stellenbosch, Breede Valley, Breede River/Winelands, Overstrand, Bitou, Prince Albert, Cape Agulhas, Knysna, Witzenberg, Swellendam, Swartland</i>											
Beaufort West	88 (l)		M	N	N	N	0	non e	none	N/A	N
Cape Town	400 (l) conservancy tanks		M	Y	Y: R360,000/ yr	Y	2 400	2 mo	C	0	Y
Drakenstein	8 (l) Conservancy tanks		M	Y	Y	N	16	6 mo	C	0	Y

MUNICIPALITY	VIPS: moveable/ immoveable	Age of first VIPs	Responsible: municipality/ householder	Policy	Budget	Health programme	No. emptied/yr	Frequency	Emptied municipality/ contractor by:	Cost to household	Additives
George	4000 (I)		M/H	N	N:converting	Y: housing	?	7 yr	M/C	0	Y
Hessequa	60 (I)		H/M	N	N: In 5 yr Y	N	10	7 yr	C	0	N
Kannaland	15	0	M	Y	N: phasing out	Y:Water Affairs	new	2 yr	M	0	N
Laingsburg	31 (I)		M/H	N	Y: R50 000	N	?	3	M	0	N
Mossel Bay	294 (M)		M	Y	Y: R450 000	Y	294	3 yr	?	0	Y
Oudtshoorn	1200		H/M	N	N: In 5 yr Y	N	225	5 yr	C	0	N
Theewaterskloof	30 (M)		M	N	N:Y in 5yrs	N	?	3	M	R142.50/half hr	Y
LIMPOPO (L)											
<i>The following 5 WSAs indicated that they do not have VIPs: Capricorn, Mookgopong, Modimolle, Thabazimbi, Belabela</i>											
Greater Sekhukhune	7000 (I/M)	1	H/M	draft	N	N	new	?	C	0	N
Lephalele	388 (I)	3	H	N	N: In 5yr Y	Y	new	3 yr	?	0	N
Mogalakwena	10 000 (I)	11	M	draft	draft	planning	new	11+	pending	pending	N
Mopani	37 146 (I)		H/M	N	N: In 5 yr Y	Y	0	none	none	N/A	N
Polokwane	800 (M)	0	H	Y	R315000 '08	N	9 600	1month	C	0	N
Vhembe	25 000 (I)		M	N	draft	N	few	7 yr		0 for indigents	Y

Appendix B: Do pit additives work?

Studies conducted by the Water Research Commission to date indicate that products marketed to slow or halt the filling of pit latrines do not work. A fifth of South African municipalities indicate that they purchase additives as part of their sanitation management programme. A typical additive treatment costs up to three times as much (R20-35/month) as manually emptying a pit over a 5 year cycle (R500-R1,500). If an additive does not effectively reduce the rate at which pits fill, the cost of dosing pits with these products has no benefit, and reduces the available municipal resources available for effective pit sludge management through mechanical emptying of the pit.

What are pit additives?

There is a large potential market for commercial pit latrine additives consisting of packaged micro-organisms and/or enzymes that are understood to assist in biological degradation processes in pit latrines. These products are marketed on their purported ability to either reduce the pit filling rate, or to actually decrease the volume of material in the pit. Some products also claim to reduce odour and insect problems.

Table 1 gives a list of claims supporting the use of pit latrine additives; these include accelerated sludge breakdown, accelerated removal of pathogenic micro-organisms, destruction of odour-causing components, degradation of specific sludge components, elimination of fly larvae, and changing pit conditions to promote sludge breakdown. Until recently, there was virtually no reliable scientific literature on the subject.

A series of WRC projects have tested a wide selection of pit latrine additives on pit sludge under a range of field and laboratory conditions. None of these studies have indicated that the additives make any difference to the rate at which sludge accumulates in the pit latrine, or to the odour or fly problems of the pit latrine.

What controls pit filling rates?

The filling rate is determined by the difference between how fast material is added to the pit and how fast degraded by-products leave the pit, which is in turn controlled by the rate at which solids are broken down to liquid and gas products by biodegradation processes. The filling rate can be calculated as:

$$\text{filling rate} = \text{addition rate} - \text{biodegradation rate}$$

Therefore, in order to decrease the filling rate, either the amount of material added must be decreased, or the biodegradation rate must be increased.

Material entering the pit: addition rate

A single adult produces approximately 110 ℓ of faeces and 440 ℓ of urine per year. Added to this volume is anal cleansing material – toilet paper, newspaper or other materials. If municipalities do not provide reliable solid waste collection, the pit latrine is also likely to be used for disposal of household rubbish. Thus, a single adult could add between 600 and 800 ℓ of faeces, urine, anal cleansing material and rubbish to the pit each year or 160 to 360ℓ of solids per year.

Faeces and kitchen waste constitute the main biodegradable components in the pit sludge. Faecal matter itself is made up bacterial cells constituting between 40 and 60% dry mass or up to 80% of wet mass of fresh faeces (Stephen and Cummings, 1980; Carboje et al., 1990) although many of these are not active.

Material exiting the pit

As material accumulates in a pit, micro-organisms from the sludge and the soil break the sludge down into gases, liquids and inorganic matter. The gases escape from the pit into the air and liquid leaches into the surrounding soil, transporting dissolved components (acids, ammonia, soluble organic material) with it.

Where oxygen is present in the pit – usually on the sludge surface and to a limited extent in the upper reaches of the soil around the walls of the pit (blue zone in Fig. 1) – aerobic micro-organisms metabolise available biodegradable material from faeces and kitchen waste, converting it to more bacterial cell matter and soluble

and gaseous by-products. Dead bacterial and human intestinal cells are also a food source for active bacteria, although not all components of a cell are biodegradable.

The bulk of the pit contents are anaerobic since oxygen cannot penetrate into the sludge. (Orange zone in Fig. 1) Anaerobic micro-organisms operate in this region: these micro-organisms break down organic material in the absence of oxygen to end-products of CO₂ and methane and some soluble intermediate products. These micro-organisms metabolise slowly. A significant amount of breakdown occurs aerobically while sludge is exposed to air on the surface of the pit. Below the surface, slow biodegradation occurs until the material is completely stabilised.

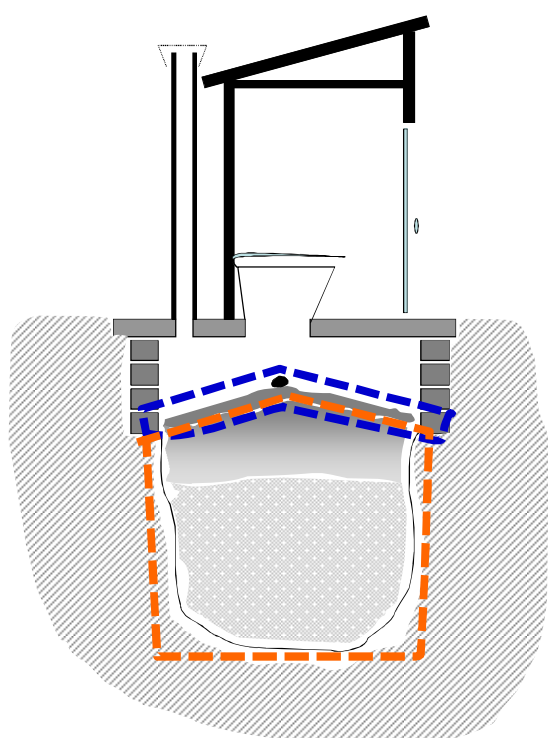

Figure 91: Zones of aerobic digestion (blue) and anaerobic digestion (orange) in the pit

Thus material exits the pit through the leaching of urine and other liquid components through the walls and base of the pit and as gaseous CO₂ and methane as a result of biological activity.

Filling rate = materials in - materials out

Of the 600ℓ or more of material per householder per year added to the pit (of which 160ℓ or more are solid), measurements on real pits indicate that only 20 to 60ℓ of pit sludge eventually accumulate. An average pit fills at a rate of 200 - 500 ℓ per year, depending on the number of users, and the volume of rubbish disposed of in the pit. Thus between 63% and 94% of material added

to a pit eventually disappears as a result of natural processes, depending on how much of the material is biodegradable.

How efficiently and rapidly these processes take place depends on factors such as temperature, pH, moisture and oxygen. Fungi, maggots, and other organisms also play a role in helping material break down. Cleaning products and insecticides applied to control breeding of flies may kill micro-organisms in the pit and impede the rate of degradation. There will always be some material which cannot degrade and as long as the pit is in use this will continue to accumulate until the pit is full.

Have any additives been proven to reduce filling rate?

The Water Research Commission has tested 20 different additives currently on the market in South Africa but none has been found to have a statistically significant effect on the degradation of sludge.

Laboratory trials

Two batches of laboratory trials were undertaken between 2007 and 2010. In the first trial, 11 additives were tested and 2 additives were tested in the second trial. In each trial, samples of VIP sludge were taken from the surface of the pit beneath the pit pedestal and were dosed at the rate indicated by the manufacturer. There were two control treatments: one in which only water was added, and one in which nothing was added.



Figure 92: Laboratory trial of two pit additives

The jars were incubated for 30 days at approximately constant temperature and the rate of mass loss as a result of biological activity in the jar was monitored.

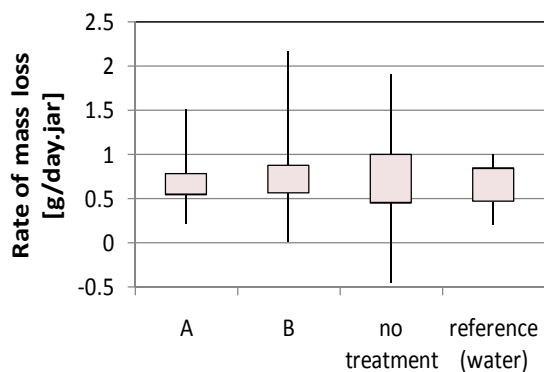

Figure 93: Box and whisker plot of mass loss rate showing 95% confidence region (box) and min and max

Significant mass loss was observed in all treatments. This was due to natural processes, not to the additives.

Field trials

A field trial was conducted in 2009/2010, consisting of 30 pits divided into 4 treatments: two additives (A and B); a reference group to study the effect of adding 10ℓ water to pit contents weekly; and a control group that did not receive any treatment.

Measurements were taken at 0, 3 and 6 months using a laser distance measure. These measurements were repeated at 3 and then 6 month intervals, and the difference in the height of the sludge heap was calculated to determine the sludge accumulation rate. There was no significant difference in sludge accumulation rates between the two additive treatments and the group dosed only with water.

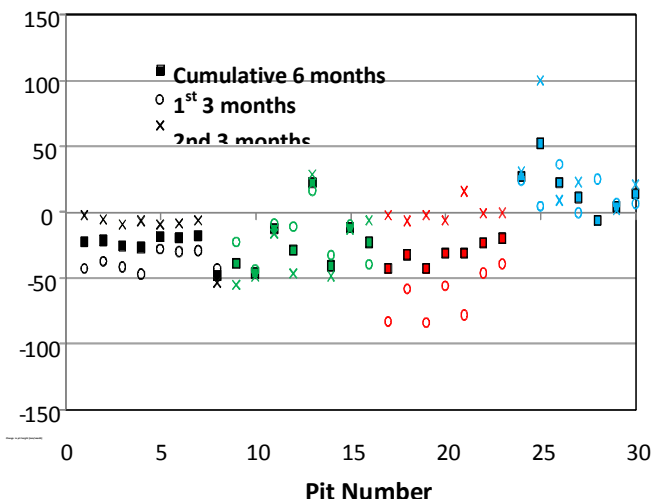

Figure 94: Sludge height in pits treated with one of two additives or water and controls measured at 3 month

Figure 94: Sludge height in pits treated with one of two additives or water and controls measured at 3 month

The group of pits that served as the control (nothing added) seemed to experience higher accumulation rates (Fig. 4). However, it was proven that the apparently reduced filling rates of the additive and water treatments was due to flattening of the sludge heap as a result of constant water addition.

In a field trial on a different pit additive in 2010, similar results were obtained; filling rates were measured for pits treated with an additive, coloured water, molasses and water or nothing for 16 weeks. For the first 8 weeks, the additive was dosed at the rate specified by the manufacturer; thereafter, it was dosed at double the recommended rate. There was no difference in accumulation rate between treatments (Fig. 5).

While all users in the first three treatment groups indicated that there had been a reduction in odour since the start of the trial, the researcher found at least two latrines with bad odours in each group, suggesting that user feedback may sometimes reflect what the user wishes to be true, what the user believes about the product, or what the user believes the researcher wishes to hear, rather than the reality.

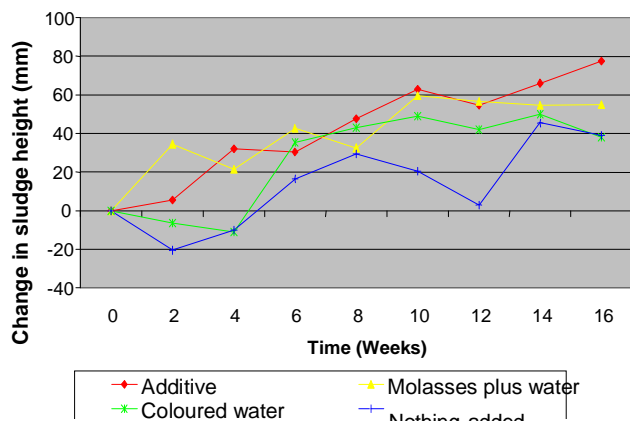

Figure 95: Changes in sludge height in pits treated with additive and control groups over 16 weeks

Similar results have been found in an independent study (Redhouse, 2001, cited in Carter and Byers, 2006).

How can the effectiveness of pit additives be verified before they are put on the market?

South Africa does not yet have an independent standards board for testing new additives that come on

Myth busting - why pit additives don't work

The assumption driving the development of pit additives is that digestion is not already occurring as efficiently as it could be in the pit. But pits already contain many of the micro-organisms needed to break down sludge and these metabolise the sludge naturally to the extent that the conditions of the pit allow. Additives that are dosed to the pit will be limited by the same conditions experienced by the micro-organisms originating from faeces or the surrounding soil.

The main reason why pit additives do not change the pit filling rate is that *the quantity of bacteria introduced to the pit by dosing additives is insignificant compared to the number already present in the faecal sludge*. Similarly, while some additives operate on the logic of adding more nutrients to the sludge to feed bacteria and encourage their growth, faecal sludge is already rich in nutrients.

the market. This means that when a manufacturer puts a product on the market which claims to reduce pit contents, this has not been verified. An independent standards board with a standardised laboratory test protocol is needed in South Africa in order to assess each new pit additive that comes onto the market to determine whether it has any effect on pit contents and under what conditions. Legislation is also needed to prevent sellers of pit additives from making unsubstantiated claims about their products.

The future of pit additives

To date, no additives have been proven effective and the presence of the necessary bacteria in the pit already suggests that it is unlikely that an additive will ever enhance processes already happening in typical pits in a significant way. However, the biology and dynamics of pits are complex, and should a product be developed which significantly impacts the filling rate of pits, it would be of enormous significance, reducing the costs and health risks associated with manual pit emptying.

Table 1: Claims made for pit latrine additives, and the reasons why these are not true.

Claim	Reality
Products contain micro-organisms that can biologically break down the material in the pit to harmless compost products and or CO ₂ and water.	The amount added in a dose of pit additive will be many millions of times smaller than the amount of active micro-organisms already in the pit.
Nutrients present in the additive ensure optimal growth conditions for micro-organisms to break down pit contents.	Pit sludge has no nutrient limitation; all nutrients required to sustain microbial life (nitrogen, phosphorus, potassium etc.) are present in excess of the growth requirement of micro-organisms.
Chemicals or biochemical additives stimulate the micro-organisms in the pit to break down pit sludge faster.	Micro-organisms work as fast as they can in any given system. There is no chemical or biochemical product that will alter the system, i.e. pit conditions such that the general conditions are more conducive to rapid growth.
Addition of aerobic micro-organisms create aerobic conditions in the pit that result in rapid degradation.	A system is aerobic or anaerobic depending on how much oxygen is present, NOT on how many oxygen-utilising micro-organisms are present. Addition of aerobic micro-organisms does not add extra oxygen!
Accelerated breakdown of pit sludge prevents fly larvae from growing in the pit sludge.	There is no evidence of accelerated sludge breakdown. However, even if there were, this would not prevent flies from laying eggs in the top layers were fresh material is constantly being added.
Addition of non-pathogenic bacteria in the sludge out-compete and in fact eat disease-causing pathogenic micro-organisms in the pit sludge, rendering it safe.	Pathogenic micro-organisms bacteria and viruses usually do not survive outside of their host (the human) for an extended period, especially under pit conditions. The major health hazard of pit sludge that has been in the ground for an extended period is helminth (worm) eggs. These have been shown to be able to survive conditions in pit latrines for periods exceeding 10 years and are impervious to pit additives.
Odours are reduced as a result of accelerated sludge breakdown.	In all the research undertaken as part of the WRC projects, researchers did not notice any reduction in odour, even when householders claimed that odours were less.

References

- M. C. L., Lopez-Guisa J. M., Shinnick F. L. and Marlett J. A. (1990). Neutral Sugar Composition and Gravimetric Yield of Plant and Bacterial Fractions of Feces. *Applied and Environmental Microbiology*, **56**(6) 1786-1792
- Carter, R. and Byers, M. (2006) *Landscaping and Review of Approaches and Technologies for Water, Sanitation and Hygiene: Opportunities for Action*. Bill and Melinda Gates Foundation.
- Foxon, K.M., Brouckaert, C.J., Rodda, N., Nwaneri, C., Balboni, E., Couderc, A., Buckley, C.A. (2008). *Scientific support for the design and operation of ventilated improved pit latrines (VIPs) and the efficacy of pit latrine additives*. Research Report No.TT 357/08, WRC, South Africa.
- Foxon KM; Mkhize S; Reddy M; Buckley CA (2009). *Laboratory protocols for testing the efficacy of commercial pit latrine additives*. Water SA Manuscript, South Africa.
- Stephen A. M. and Cummings J. H. (1980). The microbial contribution to human faecal mass. *J. Med. Microbiol.* , 13 45-56

Appendix C: Theoretical model for understanding pit filling rates

K. Wood, C.J. Brouckaert and K.M. Foxon

School of Chemical Engineering, Pollution Research Group, University of KwaZulu-Natal, Durban, 4041, South Africa, (E-mail: brouckae@ukzn.ac.za)

INTRODUCTION

The Ventilated Improved Pit latrines (VIPs) in eThekweni Metro Municipality are lined single-pits and include the four necessities of a VIP: a pit 1.5 m deep (or deeper), a foundation and cover slab, a superstructure and a vent pipe with a fly screen (Mara 1984). The pit is for the collection of excreta, the superstructure provides shelter and privacy, the foundation and cover slab prevent collapse and the vent pipe reduces odour by providing airflow and reducing the presence of flies by trapping them in the pit and attracting them away from the toilet entrance.

Of the approximate 3.3 million inhabitants in the eThekweni municipality, about 206 000 households are without basic sanitation (EWS 2011). Most of these households are located in informal settlements in the suburbs. Just outside major economic centres, the level of development drops quickly and poverty is prevalent. Despite these statistics and the recent urban development in localized areas, approximately 100 000 households in the eThekweni municipality currently use pit toilets as their primary mean of human excreta disposal, although many of these are user-built rudimentary pits that do not qualify as adequate sanitation. eThekweni Municipality has undertaken the task of emptying all pit latrines on a 5 year cycle. During the first round of emptying, it was found that the average age of the pits was approximately 14 years, and many of the pits were full or overflowing and in urgent need of emptying. The municipality proposed that a 5 year cycle should be used for emptying since this was possible from an organisational point of view, and most pits are expected to require more than 5 years to fill. In addition, 5 years is the amount of time that a standard pit servicing an average family (5.5 people per household) will receive a volume of material equal to the holding volume of pit, or, in other words, the average pit will fill completely in 5 years if no degradation of pit contents occurs. The cost of emptying a pit, depending on removal method, content disposal location, accessibility of pit, and terrain, ranges between R600 and R1 000 per pit (WIN-SA 2006 values). The cost of pit emptying is more closely aligned to the number of pits emptied than to the volume of pits emptied. Thus, from an economic point of view, a better understanding of pit filling rates would assist in more cost-effective design of the pit emptying program.

Four processes occur within a pit that will impact the rate at which it will fill: the addition of new material into the pit, the transfer of water into and out of the pit, biological transformations, and pathogen die-off (Buckley et al., 2008). The pit contains a range of substances including faeces, urine, anal cleansing material, and general solid waste. The contents of a VIP have an aerobic surface layer, but anaerobic conditions prevail in deeper layers. Thus the exposed surface of pit contents, especially newly added material, will be subject to aerobic biological processes. As the pit contents are covered over and oxygen supply is limited, conditions in the pit become anaerobic, and anaerobic biological processes will dominate. The amount of time faecal sludge spends under aerobic conditions depends on the rate at which material is added to the pit, and pit dimensions (Buckley et al., 2008).

MATERIALS AND METHODS

Overview

A simple material-balance model of the filling and degradation processes occurring in a pit latrine was developed, and compared with field measurements. The model divided the contents into three fractions: biodegradable organic matter, matter that was originally un-biodegradable when deposited into the pit, and un-biodegradable matter formed by the biodegradation process. The originally un-biodegradable material is conceptualised as a combination of the un-biodegradable fraction of faecal material and any other un-biodegradable household rubbish. Because of the heterogeneous origin of the material, the model is formulated on a volume basis, to avoid complexities associated with density variations.

Two pit latrines were examined for this study: the pits were located in the same community (Savana Park) in the eThekweni Municipality, and had very similar user profiles, geography, climate, design and construction. Both VIPs selected were filled to within 0.2 m of the top of the pit, the reported average number of users of each pit was 7 and the pits were located on slopes. VIP 1 was on the top of a steep slope while VIP 2 was on the hillside. Both pits had the same concrete block construction and were in approximately the same condition with an intact superstructure. Neither pit had ever been emptied previously. Samples were collected at the top of the pit, after the top 0.5 m of material was removed, (0.5 m down), 1.0 m down and the bottom of the pit, approximately 2.0 m below the original pit content level.

Since there is a great deal of uncertainty about the filling process over the history of the pits, the results from these two pits were compared to less intensive data from a study by Bakare (2012) from a further 16 pits located in various settlements in the eThekweni area in order to assess to what extent the results could be considered typical or anomalous.

PIT FILLING MODEL

Consider a volume of material which initially consists of v_{b0} m³ that is biodegradable and v_{u0} m³ that is un-biodegradable. Each m³ of biodegradable material degrades to form k m³ of new un-biodegradable material. The volume of new un-biodegradable material is represented as v_n m³, with initial value $v_{n0}=0$.

The rate of degradation is given by, $\frac{dv_b}{d\theta} = -r \cdot v_b$

Then, after the material has remained in the pit for time θ , the un-biodegradable material formed by degradation is $v_n(\theta) = kv_{b0}(1 - e^{-r\theta})$, and the original un-biodegradable material present is $v_u(\theta) = v_{u0}$

The total volume present at age θ is

$$v(\theta) = v_b(\theta) + v_n(\theta) + v_u(\theta) = v_{b0} \cdot e^{-r\theta} + k \cdot v_{b0}(1 - e^{-r\theta}) + v_{u0} = v_{u0} + k \cdot v_{b0} + (1 - k)v_{b0} \cdot e^{-r\theta}$$

The ratio of the total volume present to the volume of originally un-biodegradable material is:

$$\phi(\theta) = \frac{v(\theta)}{v_u(\theta)} = \frac{v(\theta)}{v_{u0}} = 1 + k \frac{v_{b0}}{v_{u0}} + (1 - k) \frac{v_{b0}}{v_{u0}} e^{-r\theta} \quad \dots (1)$$

The fraction of biodegradable material present is:

$$\beta(\theta) = \frac{v_b(\theta)}{v(\theta)} = \frac{v_{b0} \cdot e^{-r\theta}}{v_{u0} + k \cdot v_{b0} + (1-k)v_{b0} \cdot e^{-r\theta}} = \frac{\frac{v_{b0} \cdot e^{-r\theta}}{v_{u0}}}{1 + k \frac{v_{b0}}{v_{u0}} + (1-k) \frac{v_{b0}}{v_{u0}} \cdot e^{-r\theta}} \quad \dots (2)$$

Ash content is measured on a mass fraction basis, and is a sub-fraction of the originally un-biodegradable fraction. Assuming that the ash fraction has density ρ_a and the remainder of the material in the pit has density ρ_0 , and the volume fraction of ash in the originally un-biodegradable material is F_a , then the volume of ash associated with volume $v(\theta)$ is $F_a v_{u0}$, and its mass is $m_a = \rho_a F_a v_{u0}$. The mass contained in volume $v(\theta)$ is:

$$m(\theta) = \rho_a F_a v_{u0} + [(1 - F_a)v_{u0} + k \cdot v_{b0} + (1 - k)v_{b0} \cdot e^{-r\theta}] \rho_0$$

The mass fraction of ash is then

$$\frac{m_a}{m}(\theta) = \frac{\rho_a F_a v_{u0}}{\rho_a F_a v_{u0} + [(1 - F_a)v_{u0} + k \cdot v_{b0} + (1 - k)v_{b0} \cdot e^{-r\theta}] \rho_0} = \frac{F_a \frac{\rho_a}{\rho_0}}{F_a \frac{\rho_a}{\rho_0} + [(1 - F_a) + k \frac{v_{b0}}{v_{u0}} + (1 - k) \frac{v_{b0}}{v_{u0}} \cdot e^{-r\theta}]} \quad \dots (3)$$

The fraction of the organic material present that is biodegradable is:

$$\frac{v_b}{v_b + v_u}(\theta) = \frac{v_{b0} \cdot e^{-r\theta}}{v_{b0} \cdot e^{-r\theta} + (1 - F_a)v_{u0} + k v_{b0}(1 - e^{-r\theta})} = \frac{\frac{v_{b0}}{v_{u0}} \cdot e^{-r\theta}}{(1 - F_a) + k \frac{v_{b0}}{v_{u0}} + (1 - k) \frac{v_{b0}}{v_{u0}} \cdot e^{-r\theta}} \quad \dots (4)$$

It is assumed that this ratio will be the same whether expressed in volume, mass or COD units, since the biodegradable and un-biodegradable organic fractions have the same density and COD.

The age distribution of material in the pit is determined by the history of when it was deposited and the reaction transformations that consumed or generated it. However, the age distribution of the originally deposited un-biodegradable material depends only on the deposition history, as it undergoes no transformations.

This originally un-biodegradable material in the pit will have a residence time distribution (RTD) density function $f_u(\theta)$ where θ is the age of the material (the time since it was deposited). $f_u(\tau)$ is defined by $f_u(\tau) = \frac{dF_u(\tau)}{d\tau}$ where $f_u(\tau)$ is the fraction of originally un-biodegradable material which has age $t < \tau$.

The total volume of the originally un-biodegradable material is given by:

$V_u(T) = \int_0^T R_u(t) dt$, where $R_u(t)$ is the rate of addition of un-biodegradable material at time t (m^3/d), and T is the time since the pit started filling. The RTD function $F_u(\tau)$ is given by

$$F_u(\tau) = \frac{\int_0^\tau R_u(t) dt}{\int_0^T R_u(t) dt}$$

For the case where the rate of addition is constant,

$$R_u(t) = R_u, \quad V_u(T) = R_u \cdot T, \quad F_u(\tau) = \frac{\tau}{T}, \quad \text{and} \quad f_u(\tau) = \frac{1}{T}$$

Equation 1 implies that a volume $d v_u$ of originally un-biodegradable material of age between τ and $\tau + d\tau$ will be associated with a volume $\phi(\tau) d v_u$

Thus the total volume of material in the pit is:

$$V(T) = \int_0^T R_u(\tau) \cdot \phi(\tau) d\tau$$

For a constant addition rate this becomes:

$$\begin{aligned} V(T) &= R_u \cdot T \int_0^T f_u(\tau) \cdot \phi(\tau) d\tau = R_u \cdot T \int_0^T \frac{1}{T} \cdot \phi(\tau) d\tau = R_u \int_0^T \phi(\tau) d\tau \\ &= R_u \int_0^T \left[1 + k \frac{v_{b0}}{v_{u0}} + (1 - k) \frac{v_{b0}}{v_{u0}} e^{-r\tau} \right] d\tau \\ V(T) &= R_u \left[\left(1 + k \frac{v_{b0}}{v_{u0}} \right) T + \left((1 - k) \frac{v_{b0}}{v_{u0}} \right) \frac{(1 - e^{-rT})}{r} \right] \end{aligned} \quad \dots (5)$$

Equation 5 applies to the entire contents of the pit at age T since the pit started filling, and can be used to calculate the height of pit contents (given pit dimensions) when the pit has been in use for a time period of length, T.

In order to establish a profile of age vs. level below the surface, consider the volume with ages between t and T where $0 < t < T$

$$V(t, T) = R_u \cdot T \int_t^T f_u(\tau) \cdot \phi(\tau) d\tau = R_u \left[\left(1 + k \frac{v_{b0}}{v_{u0}} \right) (T - t) + \left((1 - k) \frac{v_{b0}}{v_{u0}} \right) \frac{(e^{-rt} - e^{-rT})}{r} \right] \quad \dots (6)$$

Since material of age T corresponds to the bottom of the pit, equation 6 can be used to calculate the level in the pit of material of age t. The fraction of biodegradable material at this age or level can be calculated using equation 2.

In this form, the model assumes that the feed characteristics and feed addition rate are constant and that biodegradable material all degrades at a single constant rate.

Experimental procedure

Samples of sludge from the Savana Park pit latrines were collected in May 2010. During pit emptying, it was recorded that approximately 25% of the contents was non-faecal matter, a value similar to other studies (Still, 2002). Samples were dug out of the vault through the back top slab using rakes and spades. The top layer sample was collected from the very first shovel-full taken from the surface of the pit contents, and probably contained some material less than a day old. The depth of the pit was measured with a graduated rod, with 0.5 m, 1.0 m and 2.0 m noted. When the centre of the pit reached the next marked height, another sample was taken. The emptying process disturbed the layering of the material, and frequently the pit content collapsed around holes as they were dug. While sampling, the emptiers attempted to maintain as much order in the sludge layers as possible. Nevertheless it was estimated that the uncertainty of the depth measurement was approximately 300 mm for the levels of the middle two samples. This uncertainty in depth did not apply to the top or bottom samples, but it was probable that the sample removed from the bottom of the pit was contaminated by samples from higher up the pit. The samples were screened to remove large, obvious, non-faecal material, such as plastic bags, cloth and broken glass, which meant that the samples did not represent the rubbish content of the material. Samples were stored in pre-labelled, sanitized and lined plastic containers with lids.

The samples were analysed for total solids, moisture content, volatile solids, alkalinity, pH, COD fractions, free and saline ammonia (FSA), Total Kjeldahl Nitrogen (TKN), total phosphate and orthophosphate. All analyses were performed according to Standard Methods (APHA 1995). All

analyses were performed in triplicate. The mass measurements were recorded to 1 mg precision, and the volume measurements to ± 1 ml. Due to the heterogeneous nature of the pit contents, it is expected that significant differences between samples from within the same layer will exist. To obtain an indication of the average composition of material from each layer, a 50 g composite sample was prepared by collecting smaller masses of material from different parts of each sample. Data for fresh faeces from Buckley et al. (2008) and Nwaneri (2009) were compared with the measurements from samples of the surface layer in the pits.

Interpreting experimental data in terms of the model

The distribution of material in the pit is determined by the entire history of what was disposed into it. This depends on the history of the users' behaviour, about which we have almost complete ignorance. Modelling the process therefore inevitably involves sweeping assumptions, such as considering the rate of deposition of material into the pit and its characteristics to remain constant for the entire period. Furthermore, even if detailed information were available, more detailed assumptions probably would not be particularly useful, since they would only be applicable to the specific pits investigated. In view of these uncertainties, one can only expect a rough correspondence between the model and measured data.

Two issues were evident in the experimental data that could not be directly accounted for in the model:

The first was the observation that the COD/volatile solids ratio of fresh faeces from Buckley et al. (2008) was more than twice that of the surface material. This means that either (i) non-faecal organic matter disposed of in the pit has a much lower COD than faeces, therefore the COD content of pit sludge is diluted relative to that of faeces; or (ii) that the faecal matter loses a significant fraction of COD in the interval during which it is exposed to air before being sampled; or (iii) the faeces of the users of the pit latrines studied had a lower COD concentration than those used in the study by Buckley et al. (2008). Given the semi-solid state of pit sludge, it is believed that a combination of (ii) and (iii) are responsible for the differences observed. Without any way of determining to what extent the difference was due to a high rate of degradation on the surface, the surface degradation was not modelled in this study. Rather the characteristics of the material on the surface of the pit (the top sample characteristics) were considered to be the effective feed to the pit.

The second issue was the fate of water in the pit. The data clearly showed that water is not conserved in the pit, and indeed it would be surprising if it were, since the pits are not sealed. There is an exchange of water between the pit and the surrounding soil that cannot be characterised from the data measured in this study. To get around lack of knowledge about the water movement, the model was compared with the measured compositions on a water-free basis. However, the volume of pit contents must reflect the volume of water, so the modelled volumes of dry material were scaled up using the average measured value for the water content of the pits. For this study, 16 sets of rough measurements (from Bakare, 2012) and 2 sets of detailed measurements (this study) were used. Figure 1 shows the volume fraction of water (moisture content on a volume basis) for 7 of the 18 pits that seem to fit the assumptions of the model relatively well.

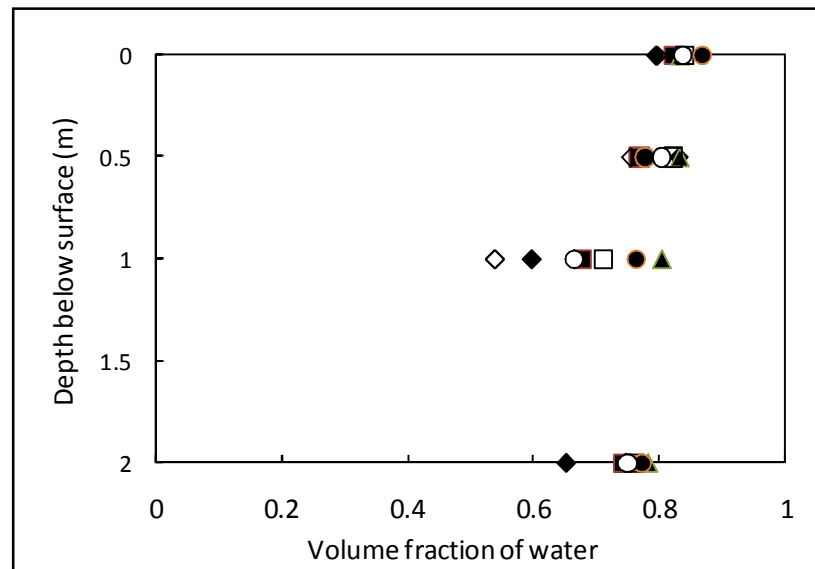

Figure 1. Volume fraction of water data for 7 pits.

Parameter estimation

The model parameters that were adjusted to fit the data were:

- The rate of addition of un-biodegradable material: $R_u = 3.964 \times 10^{-5} \text{ m}^3/\text{d}$ (dry basis)
- The ratio of biodegradable to un-biodegradable material fed: $\frac{v_{b0}}{v_{u0}} = 3.8315 \text{ m}^3/\text{m}^3$
- The fraction of un-biodegradable material that is ash: $F_a = 0.6748 \text{ m}^3/\text{m}^3$
- The yield of un-biodegradable organic material from degradation of biodegradable material: $k = 0.1 \text{ m}^3/\text{m}^3$
- The rate constant for bio-degradation: $r = 0.0025 \text{ d}^{-1}$
- The density of the ash was assumed to be 2500 kg/m^3 , and all other material (including water) to be 1000 kg/m^3 , giving $\frac{\rho_a}{\rho_0} = 2.5$
- The average water content of the pits was taken as $0.8064 \text{ m}^3/\text{m}^3$.
- COD was assumed to be directly proportional to the organic volume (whether biodegradable or un-biodegradable).

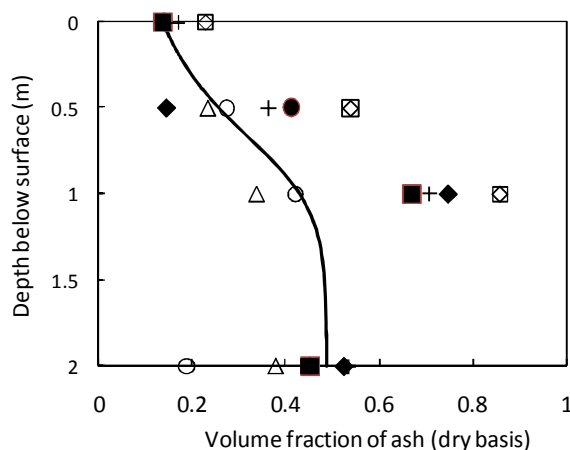

Figure 2: Distribution of ash with pit depth.

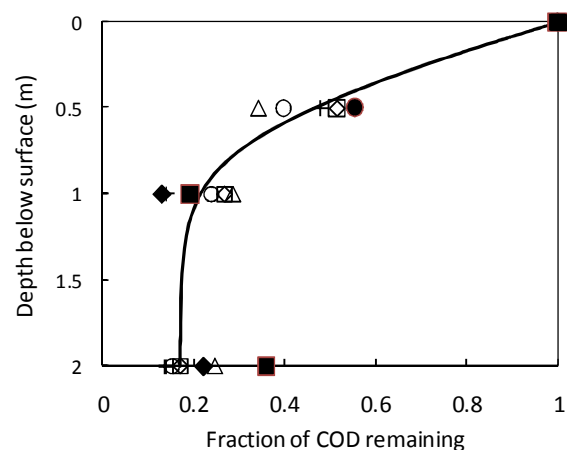

Figure 3: Distribution of COD with pit depth.

Figures 2 and 3 show the fit of the model to measured data for the same 7 pits as in Figure 1. The fraction of COD remaining is calculated as the ratio of the COD measured at a depth over the COD at

the surface. The filled symbols represent the 2 pits in Savana Park which were used in determining the model parameters, and the open symbols are for 5 of the other 16 pits. These 5 are those that seemed to correspond reasonably well to the assumptions of the model. The equivalent data for the remaining 11 pits is shown in figures 4 and 5.

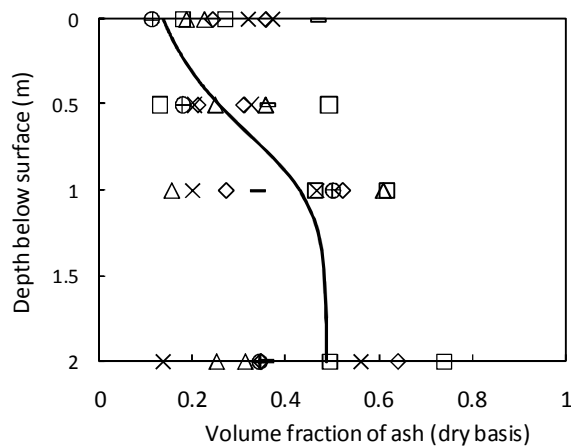

Figure 4: Distribution of ash with pit depth.

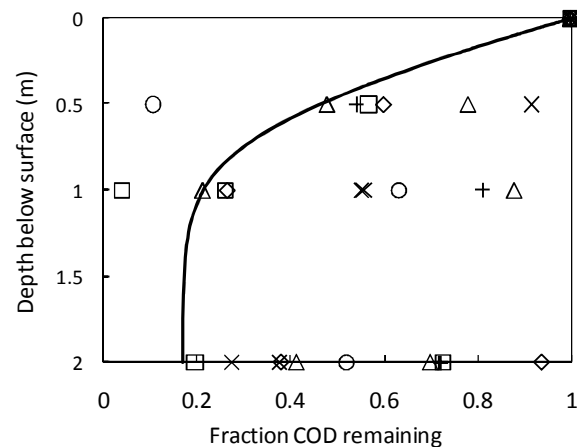

Figure 5: Distribution of COD with pit depth.

DISCUSSION

The purpose of developing the pit filling model is primarily to assist municipal planners to formulate strategies for managing low cost sanitation services based on pit latrines. However, it is necessary to examine its applicability carefully, given its sweeping assumptions and limited fit to the experimental data. It is also necessary to consider the limitations of the data themselves.

It may be concluded from the consideration of the measured data that the model shows a reasonable correspondence with a substantial proportion of pits in the eThekweni area (7 out of 18 in the sample considered), but more than half do not fit the model. However, the data for those that do not fit the model show no discernible trend at all, and might merely reflect unpredictable user behaviour. It is possibly significant that all but two of this set of pits have ash contents at the surface that are substantially higher than those which were used to determine the model parameters, indicating that the pits may have been used for disposal of material other than excreta and toilet tissue that may have influenced the filling rate and general characteristics of the pit samples..

Since the sampling procedure excluded large objects such as plastic bags, cloth and glass, their volume is not properly accounted for in the model. Thus the model deals with the accumulation of material which is visually approximately homogeneous, with a maximum particle size of about 5 mm. However, the disposal of larger objects into the pit is a completely independent process, which needs to be estimated separately on an entirely different basis in any case.

A similar argument applies to water content, since the movement of water into and out a pit depends on site-specific factors. Since water occupies about 80% of the pit volume, it does have to be accounted for, but there does not seem to be any better option than using the average value. It should be noted that researchers with experience of pit latrines in Asia and other parts of Africa consider those found in eThekweni to be unusually dry, so the average value used in this study probably needs to be adjusted for other localities.

The assumptions of uniform feed composition and uniform degradation rate over the life of the pit are clearly unrealistic in themselves, but there is no way that they could be improved in practice, and probably no advantage for policy planning that could be derived from a more detailed treatment.

There is good reason to believe that there is a much higher rate of biodegradation of material on the surface of the pit where conditions are aerobic than for material that has become submerged. However the measured data do not provide any information which could be used to estimate this. For this reason the surface material was taken as the effective feed to the pit, ignoring any processes taking place on the surface. As a result, the filling rate cannot be directly related to the actual input but has to be inferred from the level in the pit and the time that it has been in operation. However, a separate investigation found no correlation between filling rates estimated from pit-emptying records and the reported number of users per household, so it appears that there may be no better approach to the problem than the one adopted here.

If the model is accepted as the best estimate available for a process filled with uncertainties, the following scenarios illustrate how it might be used to evaluate strategies for designing a sanitation service based on pit latrines. Figure 6 considers how the volume in the pit will vary with time for various proportions of un-biodegradable material in the feed (these proportions are on a water-free basis, whereas the volume is based on the average water content as discussed above). The solid black line (20%) corresponds to the parameter values that fitted the pit data of this investigation. The 7.8% line is calculated for zero ash content, and represents an asymptotic (but improbable) case. The model clearly shows the impact of increasing the amount of non-biodegradable material in the pit on the filling rate: increasing the unbiodegradable fraction from 15% to 25% will reduce the amount of time required to accumulate a volume of 1.5 m³ by more than 5 years. This highlights the importance of keeping solid waste out of pit latrines to maximise pit life-span. Figures 7 and 8 examine the characteristics of pit contents averaged over the entire volume, representing what would be taken out the pit when emptied, assuming that the stratified contents would become mixed during emptying. Figure 7 shows the volume fraction of material that is still biodegradable, and figure 8 its ash content. These plots indicate that the longer material is left in a pit, the greater the degree of stabilisation of the pit contents when it is exhumed. Using the parameters obtained from the model fitting exercise (biodegradable:unbiodegradable volume addition ratio = 3.8:1) the average fraction of biodegradable material in accumulated pit contents would reduce from nearly 80% to less than 40% over a 10 year period. Depending on the final fate of the pit sludge, this information might be important for designing pit size and emptying frequency to ensure that the exhumed sludge has appropriate characteristics for burial, composting, etc.

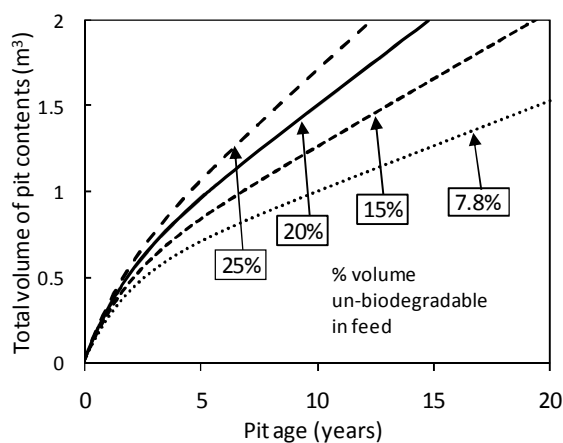

Figure 5: Volume of pit contents for four different scenarios.

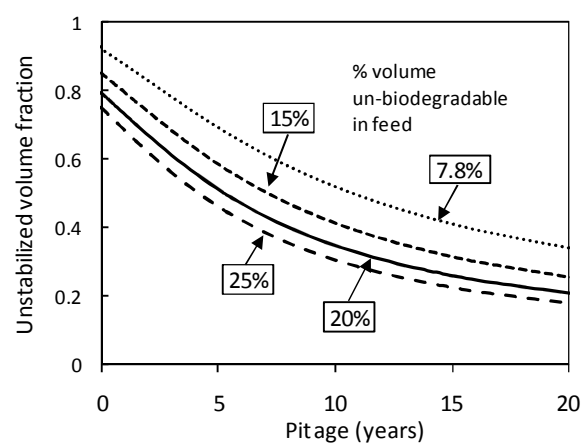

Figure 6: Overall biodegradable content of pit for four different scenarios.

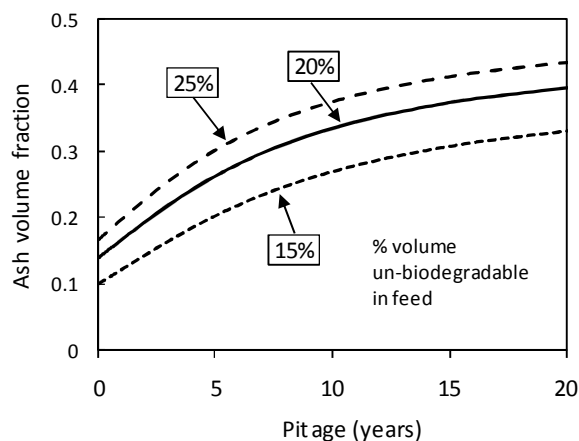

Figure 7: Average ash content of pit for various scenarios.

CONCLUSIONS

Given the uncertainties involved, it seems unlikely that the design of a pit latrine based sanitation service would be driven primarily by the factors described by the model, but rather by considerations of logistics, human resources and cost. However, the model may be useful to estimate some of the implications of any chosen system design. Nevertheless, the following conclusions may be drawn from the results of the modelling study:

- The quality of the data obtainable from sampling pit latrines is by nature very scattered, such that more sophisticated modelling of the processes in pit latrines is not justified
- There appears to be a systematic variation of organic content and ash with depth, in that at least 7 of 18 pits showed decrease in COD with corresponding increase in ash content relative to surface samples with increasing depth.
- The model predicts that the influence of addition of non-degradable material on the filling rate is significant. Thus, if the intention of the system design is to maximise the life of the pit or to minimise the pit filling rate, an effective solid waste management system must also be implemented within the community.
- The average biological stability of the pit sludge increases with time. Pit design and emptying frequency may be designed around the required stability of the sludge when the pit is emptied

ACKNOWLEDGEMENTS

The authors thank the Water Research Commission, eThekweni Water and Sanitation Services and Partners in Development for financial and technical support of this work.

REFERENCES

APHA (1998). Standard methods for the examination of water and wastewater. 20th Edition

Bakare B.F. (2012 – under examination) Scientific and management support for ventilated improved pit latrines (VIP) sludge content. PhD thesis. School of Engineering, University of KwaZulu-Natal, South Africa

Buckley C. A., Foxon K. M., Brouckaert C. J., Rodda N., Nwaneri C., Balboni E., Couderc A. and Magagna D. (2008). Scientific Support for the Design and Operation of Ventilated Improved Pit Latrines (VIPs) and the Efficacy of Pit Latrine Additives. Water Research Commission. Report No. TT357/08.

eThekweni Municipality Water and Sanitation Unit (2011). Draft Water Services Development Plan Version 19

Nwaneri C. F (2009). Physico-Chemical characteristics and biodegradability of contents of Ventilated Improved Pit latrines in eThekweni Municipality. Master of Science dissertation. School of Biological and Conservation Science. University of KwaZulu-Natal. South Africa

Still D. A. (2002). After the pit latrine is full...What then? Effective options for pit latrine management. Proceedings: WISA Biennial conference, ICC Durban, South Africa

Appendix D: Specifications for Pit Screw Auger

Component	Details
Motor	1.1 kW electric motor, with controls to allow for both forward and reverse movement
Gearbox	1:70 reduction
Drive	Chain
Screw	100 mm diameter, 100 mm pitch, 1.5 m long
Casing	125 mm diameter PVC pipe
Support	Custom steel support with 4 chains, to connect to a tripod
Discharge	135 degree 125 mm diameter connection piece. Reverse screw inside to force sludge out
Intake cage	Optional

❖ Safety

When dealing with human waste, it is vital that the proper health and safety procedures are followed. When using the PSA, the proper protective gear must be worn at all times. This includes; eye protection, durable water proof gloves, face mask, appropriate overalls, and sturdy covered shoes. Lifting the PSA is a two man job and should never be attempted alone. The discharge bucket should also only be lifted by two men. Care must be taken at all times that the operators do not come into contact with the human waste.

❖ Maintenance

The following maintenance procedures should be followed:

- Keep the gearing and bearing lubricated.
- Clean regularly after each use. Remove the PVC pipe and spray down the screw with water and a brush. Use appropriate disinfectant.
- Store the PSA in a dry secure location.

Operational Flow Chart

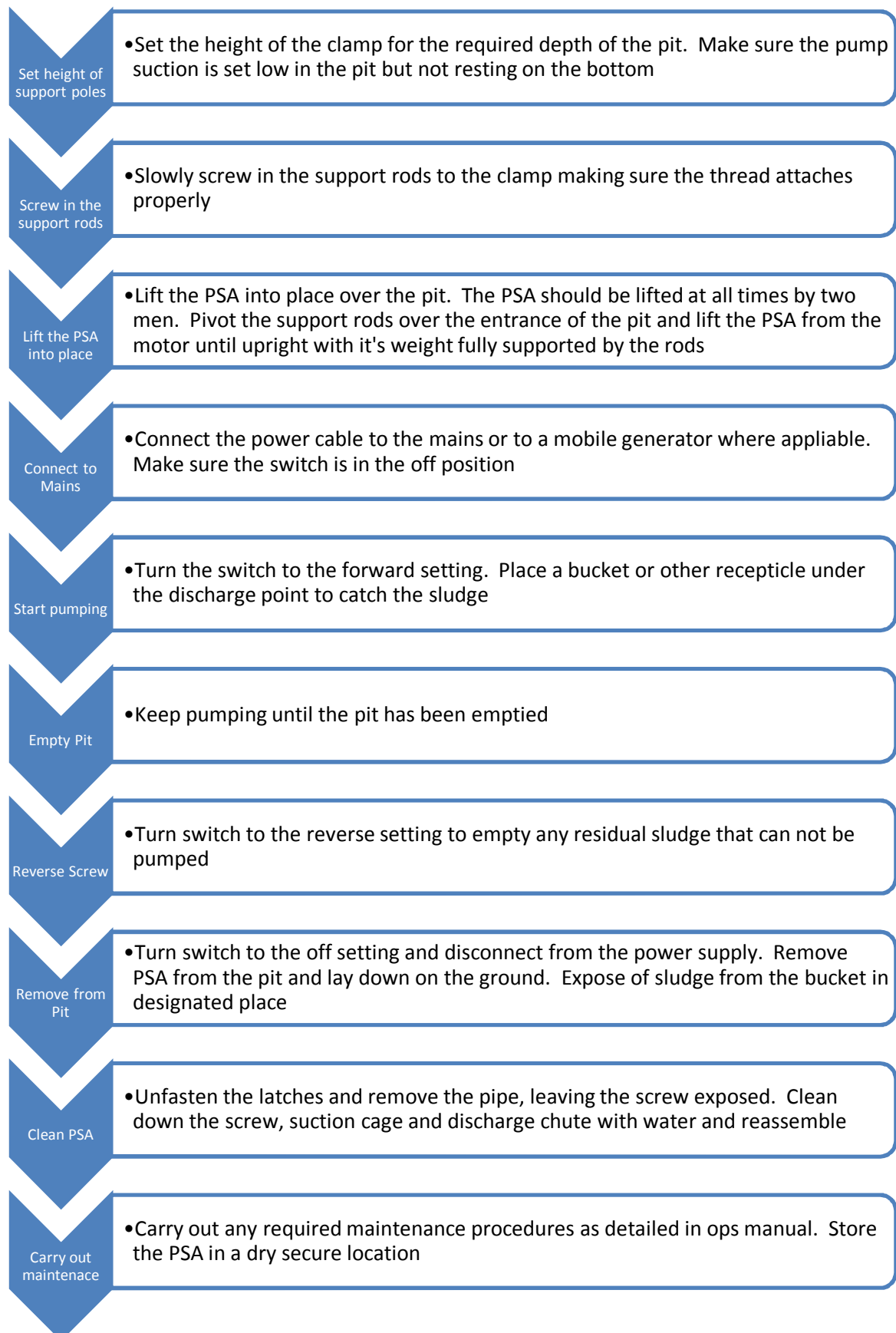

Specifications for eVac

Part	Specification	Notes
Motor	1.1 kW electric motor	Powered by a generator on-site (Fig 1)
Pump	Vane pump, (300 ℓ/min at 0.5 bar vacuum), supplied by DeLavaal Belt driven Oil lubricated	Can be used for both suction and pressure (Fig 2)
Vacuum release valve	Supplied by DeLavaal	Can be used to prevent excessive vacuum in the containers (Fig 4)
Moisture Trap	140 mm diameter, 320 mm high Clear PVC pipe with end caps Float valve can block the suction line Brass check valve allows the trap to empty automatically when suction released	Placed on suction hose before the pump. Prevents moisture entering the pump. (Fig 3)
Air Hose	1" 3 hoses of between 1 and 3 metres	Contain vacuum between the pump and container, and carry pressurized air between the pump and the air lance
Sludge Hose	3" x 3 m long	Has a pole attached to the end so that it can be controlled inside the pit, and a plastic bushing at the end to narrow the end to prevent material from entering the pipe which could block it.
Fittings	Cam Lock 1" fittings for the air hose and Cam Lock 3" fittings for the sludge hose	Would consider using alternative fittings for sludge hose as Cam Locks are difficult to operate when dirty.
Containers	47 ℓ LLDPE custom roto-moulded, with an open top Diameter: 310 mm Height: 770 mm Thickness: 15 mm	Currently 3 are used, allowing the emptying to continue whilst one of the containers is being emptied. The container is very thick as a thinner model could not withstand the vacuum required. Tested to a vacuum of 0.8 bar.
Container Lid	8 mm steel. Suction hose has a float valve to close it when tank is full Rubbery sealant used on underside to create good seal with containers	Interchangeable self-sealing lid can be moved quickly between containers A thinner steel could probably be used
Trolley	Painted steel, with motor, pump, vacuum release valve and moisture trap mounted to it	
Air Lance	3 m long 15 mm diameter stainless steel pole	Used for loosening material in pit



Fig 1 – eVac motor



Fig 2 – eVac pump



Fig 3 – eVac moisture trap



Fig 4 – eVac vacuum release valve and oil reservoir

Appendix E: Draft specifications for pit emptying and sludge disposal

Specification for pit emptying

The specification below does not prescribe to contractors how to do the job, i.e. what tools to use, or whether to use a vacuum tanker or not. It only deals with the required outcomes, and worker and public safety. The Contractor must select an appropriate methodology to achieve this specification.

Specification	Notes
<p>Pit emptying workers must wear personal protective equipment while engaged in pit emptying and sludge transport. Minimum requirements are:</p> <ul style="list-style-type: none"> • Overalls • Steel toe capped gumboots • Heavy duty rubber gloves • Gas masks 	OHSA requirement and for the workers' protection
<p>Pit emptying workers will be medically screened before and after employment, and will be treated with deworming medication every six months and six months after termination of employment. Those with highly compromised immune systems should not be selected for this work.</p>	Even with the use of PPE, pit emptying workers are at a high risk of infection and should be looked after.
<p>Deworming medication should be administered to families where pit emptying has taken place six months after emptying.</p>	Even if workers are careful it is hard to empty a pit without making a mess. A course of deworming medication taken six months after the exercise will deal with possible infection.
<p>Pits should be emptied to a depth of 1.5 metres below the pit cover, or to the bottom of the pit if this is less than 1.5 m deep.</p>	This is a cost-efficient emptying depth. It is impossible to empty below this level manually without climbing into the pit (which should be discouraged). Vacuum tankers typically cannot empty below this depth either due to the increasing suction head with depth.
<p>Pits shall not be emptied below the depth of the pit lining or pit collar</p>	Emptying below the pit lining or collar may result in the saturated soil around the pit collapsing inwards, which will cause the collapse of the superstructure.
<p>Spillage and mess around the emptying site must be kept to a minimum. Any sludge spillage in or around the emptying site will afterwards be washed down with a 3.5% sodium hypochlorite solution (household bleach).</p>	Spillage and mess endangers the health of the family where the emptying is taking place.

Specification for on-site sludge disposal

The specification below does not prescribe to contractors how to do the job, i.e. what tools to use, or whether to use a vacuum tanker or not. It only deals with the required outcomes, and worker and public safety. The Contractor must select an appropriate methodology to achieve this specification.

Specification	Notes

No sludge should be disposed of on the surface of the ground.	Surface disposal poses maximum risk to the environment, both in terms of exposure of humans and animal to pathogens, and in terms of the wash off of nutrients such as nitrogen and phosphorus into the streams and rivers.
Disposal pits or trenches should not be deeper than the pit from which the sludge is removed	The point is that the disposal pit should not pose a higher threat to the groundwater compared with the pit from which it has been removed.
The entire contents of the pit toilet should be placed in the disposal pits or trenches, i.e. including any domestic waste found in the sludge	Domestic solid waste in general poses no threat to the soil or groundwater, neither will it affect the future usefulness of the buried sludge as a slow release fertilizer source for trees. If it is dug up again years later the waste will be clean and easy to separate.
Freeboard of at least 200 mm must be left between the top of the sludge and the top of the pit or trench.	The buried sludge must not be too close to the surface to ensure pathogens are well separated from humans and animals.
The backfill must be heaped at least 300 mm high above the surface of the pit or trench	Due its high moisture content the sludge will undergo very significant settlement and compaction after burial. Heaping the backfill over the sludge ensures that the resulting ground surface is not dished (which would encourage surface water ingress).
If the sludge has a very high moisture content (e.g. where a vacuum tanker has been used for sludge removal) the disposal pit or trench site must be cordoned off with a suitable barrier to prevent access until the soil over the disposal site is firm enough to take an adult's weight.	After very wet sludge has been disposed of in a pit and covered with soil, the resulting mix has no bearing strength. If you stand on it you will sink right in.
Sludge disposal pits or trenches should not be located within 30 metres of a handpump or 75 metres of a production borehole, and not directly upstream from a handpump or borehole.	The guidelines given in DWA's <i>Groundwater Protocol</i> for the siting of pit latrines apply to the disposal of pit sludge. It is the same thing, although the pit sludge is more stabilized and is already mostly biodegraded relative to pit sludge, so poses less threat to the groundwater compared to a pit latrine.
Disposal pits or trenches should not be sited in areas where the groundwater is less than one metre from the ground surface.	As per the <i>Groundwater Protocol</i> .
Any trees planted above or near the sludge disposal site should be fenced off, either individually or together, to protect them from accidental or animal damage.	Without fencing the goats will eat the young saplings before they have a chance. A simple circular fence can be made with two stakes and two metres of fencing mesh
All workers must wear personal protective equipment identified in the Pit Emptying Specification and should receive the specified medication and screening	As per Specification for Pit Emptying

Specification for Relocating Latrines

The specification below does not prescribe to contractors how to do the job, i.e. what tools to use,

or whether to use a vacuum tanker or not. It only deals with the required outcomes, and worker and public safety. The Contractor must select an appropriate methodology to achieve this specification.

Specification	Notes
Workers must wear personal protective equipment while engaged in relocating latrines. Minimum requirements are: <ul style="list-style-type: none"> • Steel toe capped gumboots • Heavy duty gloves • Hard Hats 	OHSA requirement and for the workers' protection
Workers will be medically screened before during and after employment, and will be treated with deworming medication every six months and six months after termination of employment. Those with highly compromised immune systems should not be selected for this work.	Even with the use of PPE, pit emptying workers are at a high risk of infection and should be looked after.
Deworming medication should be administered to workers after 6 months.	A course of deworming medication taken six months after the exercise will deal with possible infection.
Relocation pits should not be located within 30 metres of a handpump or 75 metres of a production borehole, and not directly upstream from a handpump or borehole.	The guidelines given in DWA's <i>Groundwater Protocol</i> for the siting of pit latrines apply to the relocation of latrines.
Relocation pits must be a minimum of 3 meters away from the current pit.	Separation between the two pits is required for soil stability.
Collar and lining to be provided in accordance with the latrine construction specification.	A suitable collar or lining is required to prevent pit collapse and potential failure of the top structure.
Latrine to be fully dismantled before moving. Panels should be stacked tightly together in an upright position	Unless a specialist moving equipment is used, attempts to move panels together is hazardous for workers and will place excessive stress on the joints.
Latrine to be erected in accordance with the latrine construction specification. Damaged or missing bolts to be replaced.	
Freeboard of at least 200 mm must be left between the top of the sludge and the top of the pit. Where the pit is full above this level, the excess sludge should be disposed in accordance with the Specification for on-site sludge disposal	The buried sludge must not be too close to the surface to ensure pathogens are well separated from humans and animals.
The backfill must be heaped at least 300 mm high above the surface of the pit or trench	Due its high moisture content the sludge will undergo very significant settlement and compaction after the pit is capped. Heaping the backfill over the sludge ensures that the resulting ground surface is not dished (which would encourage surface water ingress).

Appendix F: Financial model

A financial model has been created in Excel which can be used to estimate the cost of a pit latrine emptying project, run either by a municipality or by a private entrepreneur, and to determine what factors affect the cost most. This model is available from the Partners in Development.

The model uses optimistic and pessimistic assumptions to create a range of possible costs (Figure 1): this is because the value of each assumption will change between projects, and will not necessarily be known even in the planning stages of a project. The model can compare the effect of changing an assumption against a range of variables: from the cost per latrine emptied (Figure 3) to the number of latrines emptied per day.

Pit Latrine Emptying Cost Model

= editable cell

= dropdown cell

Assumptions	Unit	Optimistic				Pessimistic			
		General	eVac	Hand	Tanker	General	eVac	Hand	Tanker
Pit Emptying Teams			10	10	5		2	2	1
Size of Pit latrine	m3	1.5				2.4			
Volume of waste that can be transported	m3		1	1	5		0.8	0.8	5
Emptying Rate	m3/hour		1	1	6		0.5	0.5	4
Morning Loading Time	hours		0.25	0.1	0.1		0.5	0.25	0.25
Setup time at latrine	hours		0.25	0.25	0.1		0.25	0.25	0.25
Latrine Cleanup time	hours		0.25	0.25	0.1		0.5	0.5	0.25
Afternoon Cleaning / putting away equipment	hours		0.25	0.1	0.1		0.5	0.25	0.25
Distance to or from site	km	10				30			
Distance to disposal location	km	0				30			
Distance between latrines	km	3				10			
Driving Speed	km/h	50				40			
No. teams served by vehicle			2	2	1		1	1	1
Disposal happens concurrently with pit emptying?	(yes/no)		1	1	0		1	1	0
Supervisors	per team		1	1	1		1	1	1
No. Drivers	per team		1	1	1		1	1	1
No. Labourers	per team		2	3	0		2	3	0
Working Day	hours	9				9			
Working Days per month	days	25				25			
Cost Assumptions									
Management	per Day	R 300				R 500			
Advertising	per Day	R 200				R 300			
Machine monthly maintenance	per Machine		R 500	R 0	R 0		R 500	R 0	R 0
Vehicle monthly fixed costs	per Vehicle		R 6,000	R 6,000	R 13,000		R 6,000	R 6,000	R 13,000
Monthly health interventions	per Worker	R 200				R 500			
Machine emptying running cost	per cube		R 25	R 0	R 50		R 40	R 0	R 60
Variable vehicle costs	per km		R 2	R 2	R 5		R 2	R 2	R 5
Pit repair	per pit repair		R 0	R 0	R 0		R 100	R 100	R 0
Driver	per Worker	R 150				R 150			
Labourers	per Worker	R 120				R 120			
Supervisor	per Worker	R 300				R 300			
Disposal	per cube	R 0				R 50			

Figure 1 – Model Assumptions Input

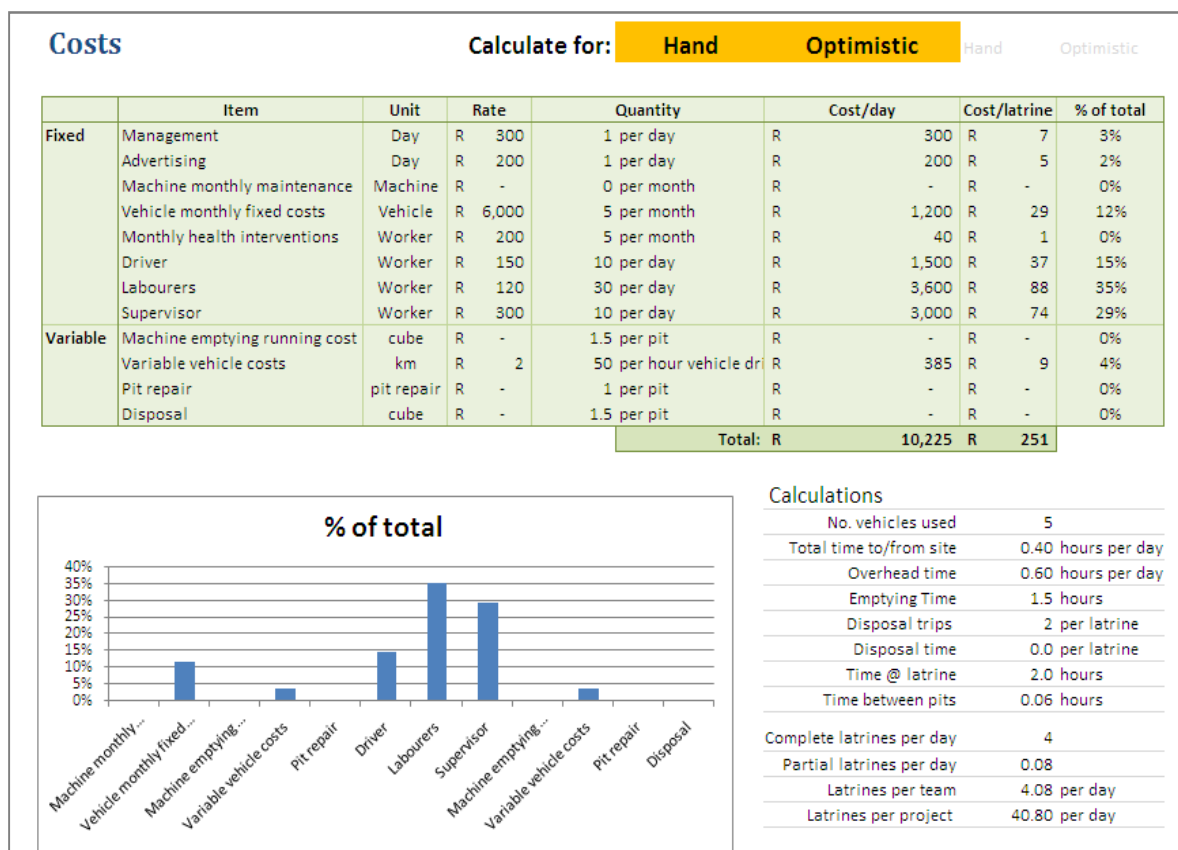

Figure 2 – Model output for a particular set of assumptions

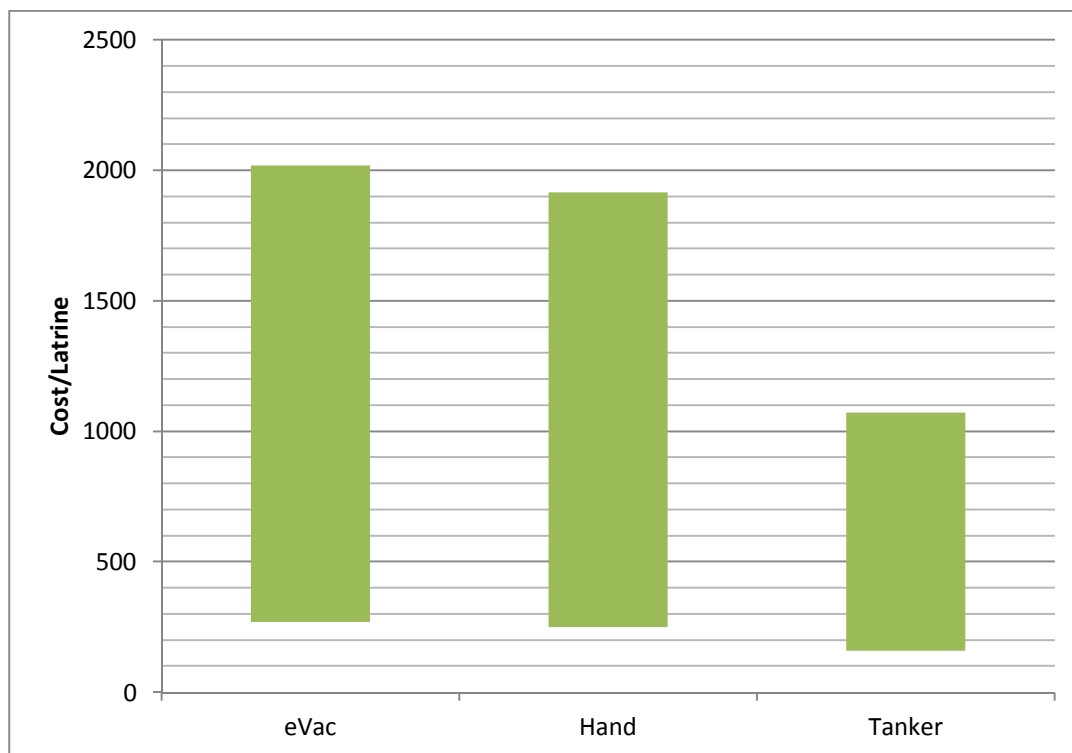

Figure 3 – Cost range for pit latrine emptying using different methods

Fixed Costs

Fixed costs are incurred regardless of the number of pit latrines emptied, and include:

- Management, administrative and office costs
- Advertising, in the case of private enterprises, or community liaison, in the case of public emptying
- Equipment purchasing
- Health interventions
- Labour costs

These costs will be affected by the method used to empty the latrines and the number of teams that are operating in the project, particularly when using a high maintenance/capital intensive method, such as emptying by tanker. The costs will however remain largely unaffected by the number of pit latrines emptied (Figure 4).

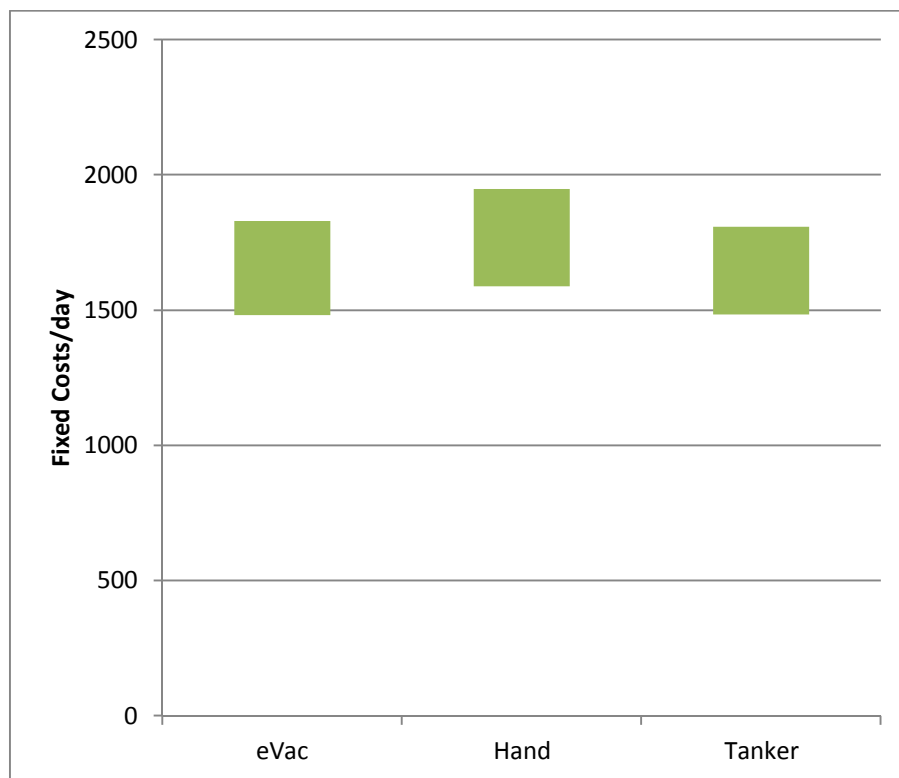

Figure 4 – Range of likely fixed costs per day assuming 1 emptying team

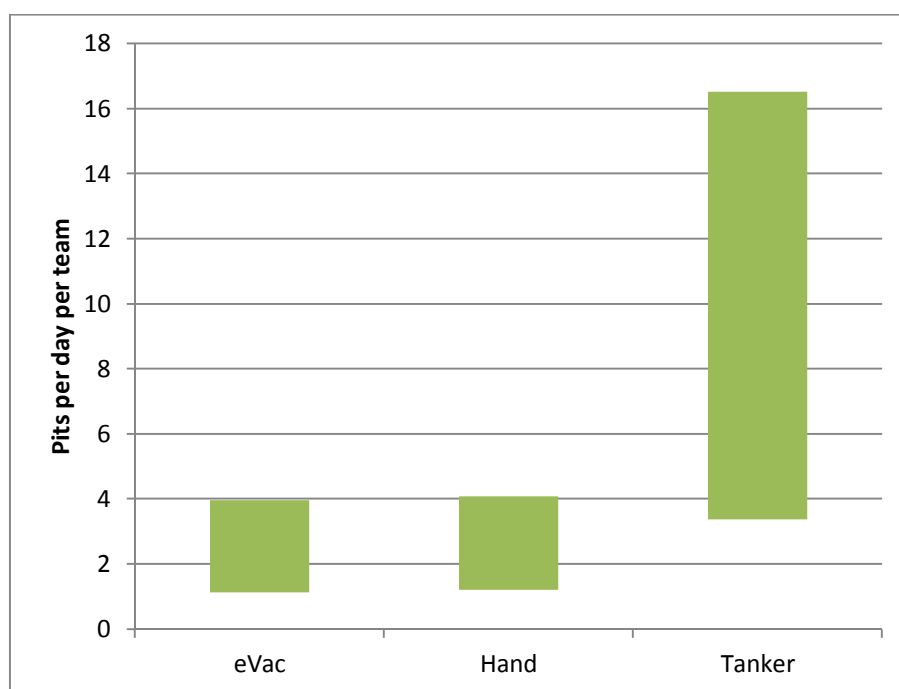

Figure 5 – Range of pit latrines per day that can be emptied

Increasing the number of pit latrines that can be emptied per day is instrumental in reducing the contribution of fixed costs to the cost of emptying each pit latrine. The number of pit latrines that can be emptied each day is sensitive to several factors (Figure 5). These factors include:

- **Time taken in the morning and afternoon to load/clean/store equipment**

All of these activities reduce the length of useful working day on site. Using methods that require less cleaning and less equipment may help cut down on this.

- **Time taken to travel to and from site**

There is a trade-off between the cost of more depots for the storage of equipment, and the cost of having to travel further to reach the pit latrines.

In the case of several teams of emptiers working together, the teams can travel together, reducing the amount of transport required.

- **Time to empty the pit**

There are a multitude of factors that affect the time it takes to empty a pit latrine. The removal rate is of course crucial, and this is affected by the consistency of the sludge. When the sludge is removed with a pump the pump characteristics and placement of the pump relative to the latrine both affect the flow rate.

The size of the pit and the volume of sludge removed are also crucial in determining the time taken to empty the pit. It may be more attractive for both the latrine users and those removing the sludge if only some of the sludge is removed. For the latrine user, this service is likely to cost less than emptying the full pit latrine, and for the emptier the top layer of the sludge is likely to be less compacted and therefore have a higher water content and be more easily extracted. This may be a false economy for the pit latrine user as the fresher waste at the top will not have degraded as completely as the waste at the bottom. The waste at the bottom will be the most compacted and so, if not removed, the latrine will fill again quickly.

There will also be time required to set up the equipment at the start and to clear up the equipment at the end of the on-site process. If the pit has been damaged during the emptying (for example slabs being removed to access the latrine) then this will have to be repaired. The ability to access the latrine without damaging it will speed this up greatly. This can be achieved only by accessing the latrine through the squat hole/toilet pedestal or by removal of a slab at the back where the latrine has been constructed to allow this.

- **Time taken to dispose of the contents**

The sludge can either be disposed of on site, or at a centralised disposal location. Disposing of the sludge on site is always going to be quickest, assuming the latrine user can contribute by digging an appropriate disposal trench in advance. Where off-site disposal is necessary the influence on the time taken to empty the pit latrine is affected greatly by whether the sludge pumping must stop (in the case of a vacuum tanker) or whether disposal can happen concurrently with the emptying of the pit, which is possible either emptying by hand or using the eVac. When pit emptying must stop to dispose of the contents the time taken is also very dependent on the distance that needs to be travelled to dispose of the sludge (Figure 6).

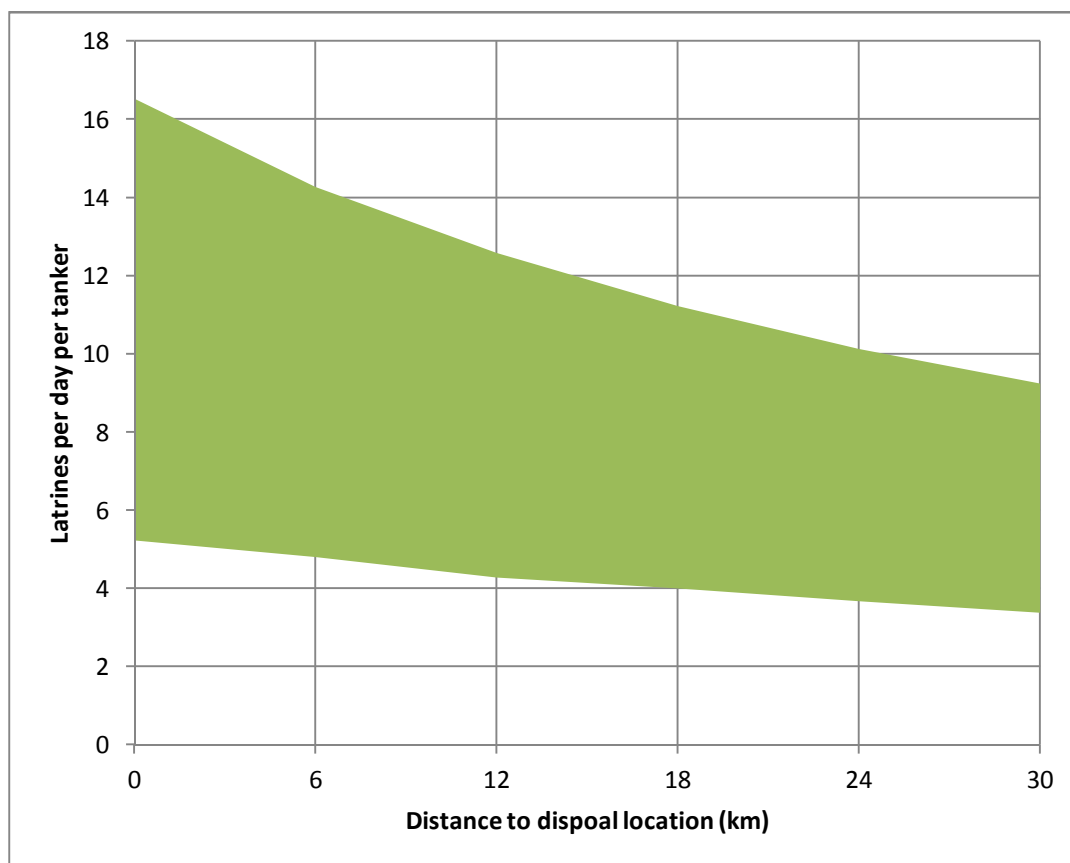

Figure 6 – Variation in the number of pit latrines emptied per day by a tanker

Variable Costs

Variable costs range far more widely than fixed costs and are incurred mostly on a per pit basis. They can include:

- Fuel costs incurred from transport
- Fuel costs incurred from emptying

- Machinery maintenance
- Repairing of latrines that had to be damaged to be emptied
- Disposal of removed sludge

The fuel costs incurred during the pit emptying are linked to the method in which the pit is emptied and the time spent emptying the pit. The transport costs are linked mostly to the distance travelled between pits and distance travelled to dispose of sludge. If the sludge is disposed of off-site then the cost of doing so could vary greatly - it is even possible that the nutrient content of sludge could make it profitable to sell.

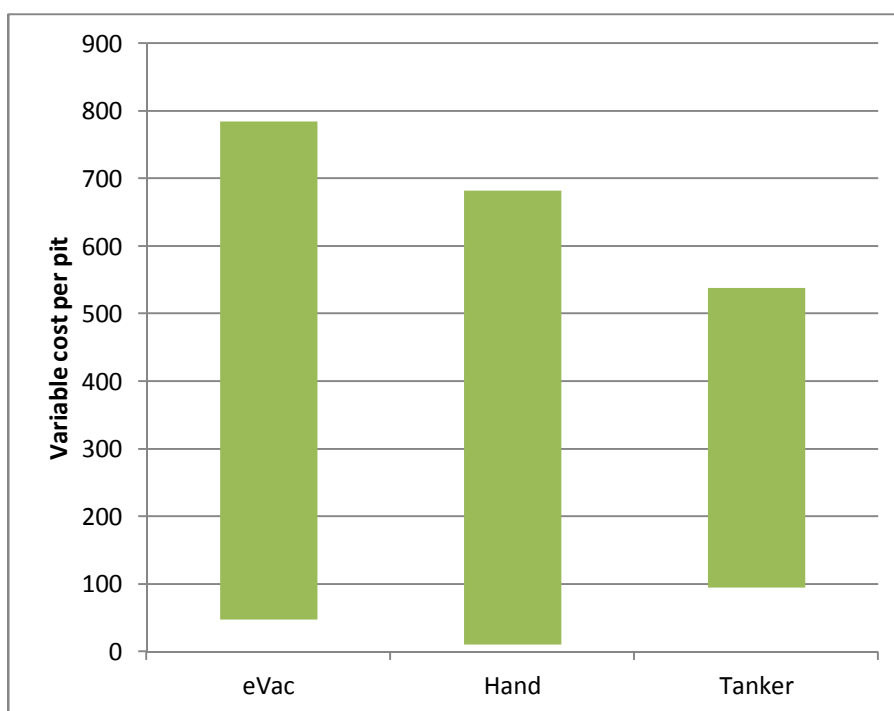

Figure 7 – Range of variable costs per pit

Other considerations

The availability of capital is not included in the model. A tanker requires by far the greatest capital expenditure whilst emptying latrines by hand requires almost none. Whilst this may be less important to government departments, it could be crucial to a small start-up business.

The decision of what method to use must be dictated by more than just cost, and there are practical considerations to consider. If the pits are difficult to access this will rule out a tanker, whilst the health risks associated with emptying pit latrines favour the use of a tanker.

The availability of spare parts and the expertise required to maintain any machine should also be considered.

The costs calculated by the model do not include mark-up, project management fees or tax. It also does not consider what the consumer might consider an acceptable price to pay to have a pit latrine emptied.

References

Bakare BF, Nwaneri CF, Foxon KM, Brouckaert CJ, Still D, Buckley CA (2010) "Pit latrine additives: laboratory and field trials" *Proceedings WISA Biennial Conference & Exhibition, Durban ICC, South Africa, 18-22 April 2010*

Maluti GSM & Partners in Development (2011), "Maintenance Plan for Ventilated Improved Pit Latrines", Amathole District Municipality

M. Mbéguéré, J.B. Gning, P.H. Dodane, D. Koné (2010) "Socio-economic profile and profitability of faecal sludge emptying companies" *Resources, Conservation and Recycling* Volume 54, Issue 12, October 2010, Pages 1288-1295