



## THE ZERO OUTFLOW MUNICIPALITY



One key idea in Sustainable Water Management is to integrate water supply, wastewater treatment and reuse. Actually it is about abandoning the concept of "waste" water, because on one hand there is no water to waste, and on the other disposal is a poor concept, which so far has proved very unsafe. From a disposal problem we should shift to an asset.



### MULTICRITERIA ANALYSIS



In order to decide the best water management solution in a given area, we need to compare the effects of possible alternative choices. Multicriteria Analysis provides a transparent and integrated view of the effects of different alternatives.

### TECHNICAL AND DEMONSTRATION CENTERS



Technical and Demonstration Centers have been built in Egypt, Morocco, Tunisia and Turkey. The overall goal was to attain a conceptual assessment of several technical options, their modifications to adopt local conditions to improve efficiencies and to make innovative developments.

### DISSEMINATION



Information on sustainable water management and ecological sanitation is spread to multipliers in the Mediterranean countries by means of workshops and courses.



As far as Zer0-M is concerned, the MEDA Water programme has allowed the introduction of the concept of Sustainable Water Management (SWM) in four MEDA partner countries and, indeed, through exchange and dissemination, beyond these four countries. The project is now drawing to its end. It is time, thus, for a review of the project and its achievements. This is done in the present issue of the journal produced by the Zer0-M project.

The project and the programme as a whole have also yielded a few lessons, which should be taken into consideration in order to guarantee sustainability of the results:

- Change towards a sustainable approach to water and sanitation will take time.
- The countries need more examples, to test and prove the systems and not least to get information about cost.
- In order to achieve this, it is of paramount importance to invite other EC bodies to provide support (e. g. the EC Delegations by considering the MEDA Water results in bilateral funding negotiations).
- Whereas the MEDA Water programme relied on non-profit organisations, it will be important for an implementation phase to include engineering competence, to rely on experts who were trained in Zer0-M and invite more consultants to trainings.

It is therefore suggested to carry on the work started with the MEDA Water programme in two main directions. On one side the development has to be continued and expanded and must again be combined with dissemination in order to spread the new approach including related techniques to implementing organisations and their personnel. This should also include further networking of the involved research organisations, the partners of Zer0-M and other institutions, which have already shown their interest.

On the other side a specific effort must be directed towards implementation of concrete examples, in order to respond to the pressing need of the populations of the countries involved to become served in sanitation and to gain experience at a larger scale.

Do not hesitate to visit the homepages of the Sustainable Sanitation Alliance and of Zer0-M ([www.zer0-m.org](http://www.zer0-m.org)), if you want to see more about this topic. You are also welcome to contact us directly.

Martin Regelsberger  
([m.regelsberger@aee.at](mailto:m.regelsberger@aee.at))

This journal, "Sustainable Water Management", is an initiative of the project "Sustainable Concepts towards a Zero Outflow Municipality (Zer0-M). The project is part of the Euro-Mediterranean Regional Programme For Local Water Management (MEDA Water) of the European Union and the countries bordering the Mediterranean Sea.

## LIST OF FUNDING ORGANISATIONS

- European Union, Meda Water Program of EuropeAid Co-operation office
- Austrian Federal Ministry for Foreign Affairs
- Agenzia regionale per la protezione ambientale della Toscana, Italy
- Acque S.p.A., Italy
- Tübitak-Marmara Research Center, Turkey
- National Research Centre, Egypt
- Secrétariat d'Etat à la Recherche Scientifique et de la Technologie, Tunisia
- Population of El Attaouia, beneficiary of pilot plant, Morocco
- Technische Universität Berlin, Germany
- Zentrale Einrichtung für Weiterbildung, Germany
- fbr association and member companies, Germany



<b>Zer0-M: Shifting Wastewater from a Disposal Problem to an Asset</b> <i>By Martin Regelsberger</i>	3
<b>Greywater Reuse: A Step Towards Closing Domestic Water Loops</b> From the Zer0-M Training and Demonstration Centre in Rabat to El Attaouia Pilot <i>By Bouchaib El Hamouri and Martin Regelsberger</i>	7
<b>Greywater Treatment as an Option for Effective Wastewater Management</b> <i>By René Scheumann, Fabio Masi, Bouchaib El Hamouri, Matthias Kraume</i>	11
<b>Integrated Approach to Water Saving – A Practical Example in a Student Residence in Tunisia</b> <i>By Latifa Bousselmi, Mouna Lamine and Ahmed Ghrabi</i>	16
<b>Multicriteria Analysis for Water and Wastewater Management in Small Rural Areas</b> <i>By Giulio Conte, Makram Anane, Andrea Goltara, Iliana Principi and Hamadi Kallali</i>	20
<b>Use of Membrane Bioreactor Technology within the Sustainable Water Management Concept</b> <i>By Selda Murat Hocaoglu, Elif Atasoy and Ahmet Baban</i>	25
<b>Let's talk about the sanitation scandal!</b> PRESS STATEMENT <i>World Water Day 2008 / 20 March 2008</i>	30
<b>An Overview for the Technical and Demonstration Centres of the Zer0-M Project</b> <i>By Ahmet Baban, Latifa Bouselmi, Bouchaib El Hamouri and Hussein Abdel Shafy</i>	31
<b>Outline of Constructed Wetlands in Zer0-M</b> <i>By Fabio Masi, Bouchaib El Hamouri, Hussein Abdel Shafi, Ahmet Baban, Ghrabi Ahmed and Martin Regelsberger</i>	36
<b>Sustainable Water Management Technologies in Turkey</b> A Seminar in Gebze <i>By Gerd Wach, Erwin Nolde, and Elif Atasoy</i>	40
<b>TDC Contact Addresses</b>	43
<b>Zer0-M Partners</b>	Backcover

## IMPRINT

Eigentümer, Herausgeber und Verleger / Published by  
**AEE – Institut für Nachhaltige Technologien / Institute for Sustainable Technologies**

A-8200 Gleisdorf, Feldgasse 19, Tel.: +43 (0)3112 / 5886  
Redaktion / Editors team: Elif Atasoy, Irene Bergmann, Barbara Regelsberger, Martin Regelsberger

"Sustainable Water Management" wird im Projekt Zer0-M vor allem für Wasserfachleute und Entscheidungsträger in den Projektländern herausgegeben. Bis zum Ende des Projekts erscheinen zwei Hefte pro Jahr.

"Sustainable Water Management" is issued within the Zer0-M project mainly for water experts and decision makers. Throughout the project it will come out twice a year.

**Bankverbindung / Banking account:**  
Raiffeisenbank Gleisdorf, Kto.-Nr. 104.430, BLZ 38103, IBAN: AT09 3810 3000 0010 4430, SWIFT-BIC-CODE: RZSTAT2G103

WWW: <http://www.aee-intec.at>, <http://www.zer0-m.org>

Typo, repro & design by STEINHUBER INFODESIGN, Graz

**Druck und Versand / Printed and mailed by:**

Universitätsdruckerei Klampfer, 8160 Weiz

Printed with soy based inks.

Auflage / Number of copies: 5.700



# ZERO-M: SHIFTING WASTEWATER FROM A DISPOSAL PROBLEM TO AN ASSET

By MARTIN REGELSBERGER\*

Zer0-M, short for “Sustainable Concepts Towards a Zero Outflow Municipality”, is a project financed by the MEDA Water programme of the European Union (EU). Zer0-M aims at spreading concepts and developing technologies to achieve optimised close-loop usage of all water flows in small municipalities or settlements (e. g. tourism facilities) — the Zero Outflow Municipality.

\* Martin Regelsberger heads the water department at AEE INTEC, Gleisdorf, Austria, [m.regelsberger@aee.at](mailto:m.regelsberger@aee.at)

◀ Figure 1:

TDC AT THE MARMARA RESEARCH CENTER AT GEBZE, TURKEY

**W**e have to face the fact that in dry climates with a high pressure on water resources, wastewater is reused anyhow if possible, whether it is allowed or treated to the necessary quality or not. From a wider perspective in the closed system of the earth there is always somebody on the receiving end. Some have thus replaced the concept of disposal by unplanned reuse, as opposed to planned reuse, which Zer0-M is advocating together with other organisations and projects working at Sustainable Water Management (SWM). The far end of the process would be to design substance flow cycles which allow upcycling of water and nutrients, instead of downcycling especially water until it cannot be further used.

## NO WATER TO WASTE

One key idea in SWM is to integrate water supply, wastewater treatment and reuse. Actually it is about abandoning the concept of “waste” water, because on one hand there is no water to waste, and on the other disposal is a poor concept, which so far has proved very unsafe. From a disposal problem we should shift to an asset, which has to be developed.

## RÉSUMÉ

### CONCEPTS DURABLES VERS UNE MUNICIPALITÉ SANS EFFLUENT

Zer0-M, une abréviation pour “Sustainable Concepts Towards a Zero Outflow Municipality” (Concepts durables vers une municipalité sans effluent), est un projet dans le programme régional méditerranéen pour la gestion locale de l’eau de l’Union Européenne. Zer0-M a pour but de diffuser des concepts et de développer des techniques permettant une utilisation optimisée des eaux domestiques d’agglomérations — la municipalité sans effluent — et leur contenu en boucles plus ou moins fermées. Le projet a pu réaliser des installations pilotes et de démonstration et ainsi démontrer la faisabilité de l’approche d’une gestion durable, centrée sur le ménage et utilisant les avantages de collecter et de traiter des fractions d’eaux usées séparément. Ces techniques permettent de faciliter la réutilisation. Dans une prochaine étape il faudra généraliser les résultats obtenus par d’avantage de réalisations et pousser plus loin dans la recherche de solutions nouvelles et intéressantes. Les techniques utilisés présentent une nouvelle chance pour les pays de la Méditerranée, connaissant une pression particulièrement forte et croissante sur leur ressources en eau et qui pourtant ont tablé jusqu’ici sur des technologies d’eau développées dans des régions beaucoup plus arrosées et sur des bases qui datent d’il y plus d’un siècle.

Purpose	Techniques
Substitute water	Dry toilets, waterless urinals
Substitute potable water / diversify resources	Collection of rainwater and use for laundry, showering, irrigation, toilet flushing
Save water	Water saver fixtures, water efficient flushing toilets, household appliances (dishwasher, washing machine)
Separate collection, treatment and reuse	<ul style="list-style-type: none"> <li>• Separate collection of different components/fractions e.g. greywater (from bathroom and sink) and blackwater (from toilet), urine</li> <li>• In-house greywater treatment and reuse for toilet flushing, showering, laundry, outside uses</li> <li>• Reuse of urine as a fertiliser</li> <li>• Composting of faeces and addition to soil</li> </ul>
Low energy treatment	Ponds, constructed wetlands, SBR greywater treatment systems, sludge composting reed beds, composting
Treatment with energy recovery	Anaerobic wastewater treatment with biogas production, possibly combined with organic waste
Reduce climate change	Carbon sequestration in soil, with reconstitution of organic matter from wastewater, reduction of nitrous oxide output through reuse of nitrogen in agriculture

▲ *Table 1:*  
**MEASURES AND CORRESPONDING TECHNIQUES (NON COMPREHENSIVE) TO INCREASE SUSTAINABILITY**

Another key idea of SWM is the “household centred approach”. This means that every problem is dealt with at the smallest possible level, starting from the household, if possible. If not, the problem is reported for solution to the next larger level, the building, then the neighbourhood, the town, etc. In industry this is what cleaner production does: processes, factories, industrial zones are designed in order to allow reuse of substances and energy available.

A consequence of these two aspects is demand control and source separation. Source separation is already widely practiced in solid waste management and eases the treatment and reuse of mass flows. This advantage needs to be exploited in liquid substance flows, too. **Table 1** shows a series of possible measures assisting in the creation of closed-loop local water management and related techniques that are already available. The techniques, however, are not limited and especially open to further developments.

## ACHIEVEMENTS

In order to encourage implementation of SWM in real systems, Zer0-M has built so-called training and demonstration centres (TDCs, see **figure 1**) in each of the four MEDA partner countries, Egypt, Morocco, Tunisia and Turkey (see also article of Ahmet Baban et al., **page 31**). These centres exhibit a great variety of different techniques at small scale, which have been and are further tested and shown.

In Tunisia the TDC is built at a student residence. The concept includes rainwater harvesting and treatment for shower water, collection of greywater, treatment by various processes (constructed wetland, sequencing batch reactor and membrane bio-reactor) and reuse for toilet flushing. The toilet outflow is again treated and used for landscaping of the area around the residence. Thus the water is used three times, the de-



▲ *Figure 2:*  
**VISIT OF THE TUNISIAN TDC BY INTERESTED ENGINEERS AND WATER EXPERTS DURING A TRAINING**

mand from the water mains can be reduced to 40% and in the ideal case no outflow reaches the sewer system. The example shows that the approach is possible also in urban settings.

At the Institut Agronomique et Vétérinaire Hassan II in Morocco one example is to collect greywater from a sports club and treat it in a two stage constructed wetland. It is then disinfected in a UV-unit and used for toilet flushing at the building of the Department for Rural Engineering and landscaping. The results from that research were used to upscale the system for a 60 m<sup>3</sup>/day greywater plant at a public bath, a hammam, in a small town near Marrakech. The treated wastewater there is used for irrigation of the town parks.

Such real scale pilot plants were designed and are built in three countries to implement and demonstrate the techniques tested at the TDCs under normal life conditions (see **figure 3**).

## TDC: VISIBLE RESULTS

Zer0-M has reached a phase in the promotion of SWM where results are visible. These results comprise among others the physical realisations, which can be shown to an interested public in the respective countries. The implementations also help in assessing the suitability of the technical solutions provided and in adapting them, if necessary, to local particularities. At the same time they are used to make future water experts familiar with the concepts of sustainable water systems through trainings (see **figure 2**), research work and theses prepared under the supervision of the project partners.

The results also include consolidated data about particular wastewater fractions, i. e. greywater and blackwater, of the partner countries. These come to complement the existing databases and will be useful in dimensioning respective treatment systems. The TDCs and pilot plants will continue to provide data even beyond the project.



◀ *Figure 3:*  
**CONSTRUCTED  
 WETLAND FOR  
 PRODUCTION OF  
 IRRIGATION  
 WATER ET SEKEM,  
 EGYPT**

## DISSEMINATION

The project approach has been successfully disseminated through a journal and a homepage ([www.zer0-m.org](http://www.zer0-m.org)), a number of workshops in each partner country, three conferences organised by Zer0-M itself and the participation of Zer0-M partners at numerous other conferences and water related events. Several videos have been produced, broadcast and distributed to show the approach and possible technical solutions to a wide public of potential users.

The partners in the MEDA countries are all well established national institutions. They have themselves a great interest in the exchange among partners and the results achieved. It can be expected that they carry on the work started through the project even after its end. To this purpose they have decided to establish a network, which shall include other organisations around the Mediterranean Sea. Their direct involvement in the national water policy design, development of technical solutions for the nationally identified problems and the education of future generations of water experts is a guarantee for the achieved results to gradually become part of the standard practice in water management of the region.

The implementations were carried out with local water and wastewater utilities, which will be able to use the experience gained and carry on with sustainable water management. In their work they will have the active support of the Zer0-M partners in each country.

## LESSONS LEARNED

With all optimism, however, it is clear that five years of even intensive work is a short period to redirect such a wide region as the MEDA countries in their attitude towards sanitation techniques, even for a whole programme of the European Union. It is true that there is a high pressure on this region to continuously increase the efficiency of their water systems and to reduce pollution through wastewater. Nevertheless it will take a longer period to introduce modern sustainable sanitation techniques, especially given the sensitivity of this aspect of human life, which involves everybody in a very personal way and can only be optimised with the concurrence and active contribution of all people together.

The developed know-how was so far applied in small scale demonstration systems and upscaled to a few real size pilot plants in each country.

## FURTHER QUESTIONS

The authorities and implementing organisations are now asking for the Zer0-M partners' support for wider application of the developed systems. On the other hand the project has also shown that for wider application further questions have to be tackled, which could not be included in the current phase. The answers to these questions will partly come from experi-

► *Figure 4:*  
**EXCURSION  
 AFTER A  
 CONFERENCE  
 ORGANISED BY  
 ZERO-M AND  
 MEDAWARE AT  
 MARRAKECH**



ences with additional real scale implementations, partly from further technology development efforts.

Some of the questions are:

- How to optimise the reuse of nutrients in agriculture? Work with agronomists and agro-economists on this issue will be needed.
- Can the developed SWM systems, especially the household centred approach, be transferred to the urban context with its generally higher domestic water needs?
- How to organise a large number of decentralised rural (or urban) systems?
- How to adapt regulations, which are focusing on water presently, for nutrient reuse?

These issues should be dealt with in the near future to proceed with SWM while further pilot plants and a multiplication of implementations consolidates the achievements and furthers the present effort.

## OUTLOOK

The MEDA Water programme has a co-ordination office, the Regional Monitoring and Support Unit (RMSU) based in Marseilles and Amman. This unit allows joint efforts to present the contributions of the programme as a whole for a sustainable management of water resources. It can therefore be expected that the project work is perceived as part of a whole programme with a reach over all the Mediterranean region and seen in the more comprehensive framework

of the MEDA Water Programme. For the sustainability of the results achieved they will have to be appropriated not only by the countries directly involved in Zer0-M but also by the European Union and the Commission itself in their further support of sustainable water management in the region.

The new approach will hopefully help the Mediterranean region to better cope with the increasing water scarcity, compared to solutions developed from techniques of the 19<sup>th</sup> century for much more humid regions. In a next step the experiences gained and the demonstration of the advantages of the sustainable approach should lead to its general establishment as a new paradigm for urban water systems.



◀ Figure 1:

### EXPERIMENTAL GREYWATER TREATMENT PLANT AT THE TDC IN RABAT

# GREYWATER REUSE: A STEP TOWARDS CLOSING DOMESTIC WATER LOOPS

FROM THE ZERO-M TRAINING AND DEMONSTRATION  
CENTRE IN RABAT TO EL ATTAOUIA PILOT

By BOUCHAIB EL HAMOURI and MARTIN REGELSBERGER\*

Nowadays, many countries are facing water scarcity issues and increasing stress due to water supplies, all of which restrains their development objectives. Together rainfall rarefaction in many regions of the world and intensive water use for irrigation and for domestic and industrial activities are at the origin of the continuous rise in demand. This situation is expected to deteriorate in the next decades since water mobilisation has more or less reached its limits in most of the areas concerned.

**Bouchaib El Hamouri**, Department of Water Environment and Infrastructures, Institut Agronomique et Vétérinaire Hassan II (IAV), Rabat, Morocco, [b.elhamouri@iav.ac.ma](mailto:b.elhamouri@iav.ac.ma)  
**Martin Regelsberger** heads the water department at AEE INTEC, Gleisdorf, Austria, [m.regelsberger@ae.at](mailto:m.regelsberger@ae.at)

**W**ater demand management and the application of new sustainable concepts towards closing the water loop, are among the approaches examined to tackle at least part of the problem. For instance, greywater (GW) recycling for site specific, non-potable urban uses such as toilet flushing and landscaping is gaining in popularity. GW is collected from washbasins, showers, baths and washing machines. It represents 30% in households, 60% in commercial buildings and almost 100% in hammams (public baths).

The public bath or hammam is a cultural heritage of the Mediterranean civilization and is a major support for health care and hygiene in the developing countries of this area. Often, families do not rely on household facilities but visit the hammam to have a wash once or twice a week. Visiting the hammam is a social event in the southern Mediterranean area particularly for women. In wintertime, the lack of household heating systems deters people, even those with bath facilities, from washing at home since they prefer the steam-heated atmosphere of the hammams.

This paper describes the way the idea of using GW for usages that do not need drinking quality water was put into practise by the Zer0-M Project between 2004 and 2008. A two-step approach was adopted. It went from the small training and demonstration centre

## RÉSUMÉ

L'approche "Zer0-M" entre dans le cadre de la réduction de la demande de l'eau. Elle introduit la nécessité d'une utilisation rationnelle de l'eau comme le montre l'exemple de la ville d'El Attaouia (22.000 habitants), située à 80 km au nord-est de Marrakech.

Cette ville est maintenant dotée d'une station d'épuration des eaux grises de son plus grand hammam. L'originalité du projet réside tant dans l'idée de traiter les 60 m<sup>3</sup>/j d'eaux grises du hammam, que dans le choix d'une station qui n'occupe que 200 m<sup>2</sup> et qui se distingue à peine de l'espace vert où elle est placée.

Désormais, 60 m<sup>3</sup>/j d'eaux grises remplacent ceux pompés à 50 m de profondeur pour des usages qui ne nécessitent pas la qualité d'eau potable. Depuis le démarrage du projet la surface des espaces verts a été multipliée par trois étant donnée la disponibilité de l'eau grise traitée ce qui a amélioré la qualité de vie des citoyens.

Les 200 m<sup>3</sup> rejetés par les cinq hammams de la ville occupent, à eux seuls, 2.000 m<sup>3</sup> sur les 7.000 de la station d'épuration de la ville. Envoyer l'eau grise des hammams directement dans les stations d'épuration des eaux usées des villes Méditerranéennes est un non-sens doublé d'un gaspillage d'eau et d'argent.



▲ Figure 2:  
**GROWN-UP  
GREYWATER  
TREATMENT  
PLANT FOR THE  
HAMMAM IN  
EL ATTAOUÏA**

(TDC) GW recycling facility (10 m<sup>3</sup>/d) to the large scale hammam GW reuse for landscaping in the small town of El Attaouia (60 m<sup>3</sup>/d).

**STEP 1: THE MODEL**

Ten m<sup>3</sup>/d of shower GW were collected, treated, disinfected then recycled for toilet flushing in the IAV campus. This was implemented in the TDC constructed by Zer0-M in March 2005. This was aimed at comparing the efficiency of advanced, compact technologies to that of natural, low-cost systems for GW treatment. Intensive systems were studied with the objective of helping their use in remote tourist facilities while the study of low-cost units was oriented toward the implementation and dissemination of large scale decentralized GW treatment for urban reuse in small communities.

**STEP 2: THE LARGE SCALE PILOT OF EL ATTAOUÏA**

The town of El Attaouia with 22,000 inhabitants was chosen to harbor the Zer0-M pilot project on GW treatment and reuse. This town is located 80 km North-east of Marrakech in the arid zone where rainfall is around

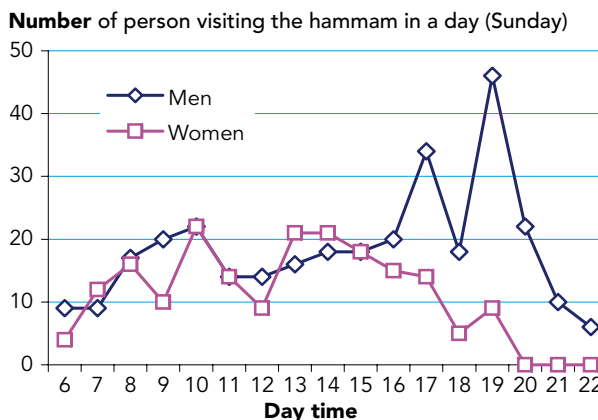

► Figure 3:  
**PROFILE OF  
THE NUMBER OF  
MEN AND WOMEN  
VISITING THE  
HAMMAM IN  
ONE DAY**



▲ Figure 4:  
**THE HORIZONTAL CONSTRUCTED WETLAND THREE MONTHS LATER**

300 mm/year. El Attaouia was also chosen because it already has a sewage treatment plant and a 40-ha-irrigation reuse area both operating since 2003.

Design parameters were worked out from a two-year intensive monitoring of the TDC installation (step one) and used for the construction of a 200 m<sup>2</sup>-intra-muros, decentralized plant to treat greywater collected from the Attaissir hammam, the largest hammam of five in the town of El Attaouia. Following this, 60 m<sup>3</sup> of greywater are to be collected per day to be reused for landscaping instead of pumping 50 m-deep drinking quality water.

**TECHNICAL SETUP  
HAMMAM “ATTAISSIR” OF EL ATTAOUÏA**

Hammam ATTAISSIR is the largest and the most recent hammam of the town of El Attaouia. It includes two separate parts of equal size. One is used during the opening hours by women only and the other by men. A few hammams still operate in the way that a common space is used for some periods of the day by men exclu-

▼ Figure 5:  
**SAND GRANULOMETRY**

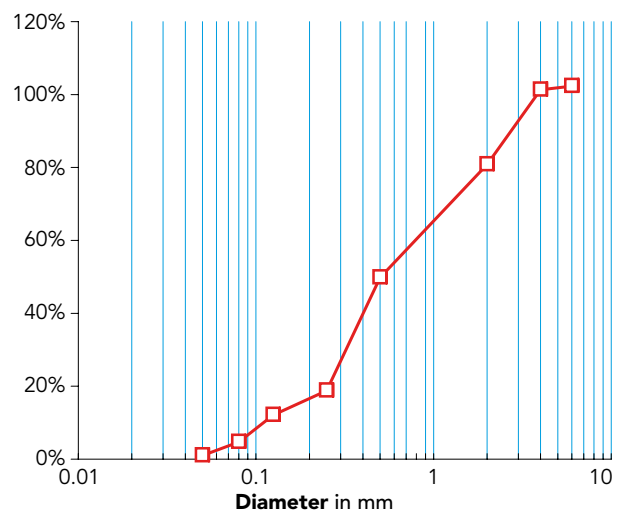





▲ Figure 6:  
**MUNICIPALITY WORKER IN DUTY IN THE GW TREATMENT PLANT**

sively and other spaces by women. Hammam Attaissir produces 60 m<sup>3</sup>/day of greywater.

Consumption ratios and week frequentation were monitored to determine the GW production profile (figure 3.) and also to fine-tune the design of a solar heating system which will save part of the 1.2 tons of forest wood burned daily in the hammam. This part of the pilot project will be implemented between June and August 2008. An area of 375 m<sup>2</sup> of solar collectors and a storage reservoir of 25 m<sup>3</sup> shall be used to provide more than 60% of the heating energy requested by the hammam.

## THE TECHNIQUE CHOSEN FOR THE TREATMENT OF THE HAMMAM'S GW

The chosen system was tested first in the TDC installation for three consecutive years before its scaling up for the Hammam GW treatment. The chosen constructed wetland/sand filter unit had three components: a horizontal-flow constructed wetland (CW) planted with Phragmites, a self-primed siphon and a vertical-multilayer slow-sand filter.

The 200 m<sup>2</sup> plant was constructed in a green space along the main street of the town. It is located 1,500 m away from the Hammam. Raw GW is subject to coarse material removal using two screens in series prior to its pumping to the treatment site using an automatically controlled submersible pumping unit.

It was decided to construct two identical parallel treatment lines, instead of having one line with the same surface area, for maintenance reasons (figure 5). The self-primed siphon was constructed to flood the vertical sand filter in a short time for homogeneous hydraulic loading.

The CW unit was constructed in reinforced concrete and had the following characteristics (per line): length 10 m, width 4.0 m, depth 0.8 m, cross sectional area 3.2 m<sup>2</sup> and bottom slope 2%. The bed filling material was limestone aggregates 2 to 8 mm. The uniformity coefficient (UC;  $d_{60}/d_{10}$ ) was 1.5, the porosity 42%. The bed was planted with reed; Phragmites sp. (figure 5).



▲ Figure 7:  
**PROJECT INAUGURATION**

The vertical-multilayer slow-sand filter was also made in reinforced concrete also with a length of 10 m and 4 m wide. The sand layer had a thickness of 0.80 m with particle sizes of 0.25 mm and a uniformity coefficient (UC;  $d_{60}/d_{10}$ ) of 2.85 (figure 5). Drain pipes were covered with a layer of gravel 2 to 8 mm.

A reservoir of 60 m<sup>3</sup> (one-day water production) was constructed under ground, from which treated effluent is pumped through an irrigation network.

## FOLLOW UP AND ADVANTAGES

The performance and behaviour of the plant are to be followed up for the next coming months to improve the system and fine-tune its operation. Also, economic parameters shall be determined in order to work out the operation costs for dissemination purposes.

## CONCLUSION

To our knowledge, the El Attaouia project is the first experiment of this size dealing with the GW from a hammam. Such an approach could be adopted for a better domestic water management inside the Mediterranean cities. Landscaping and other urban needs could be satisfied using hammams' GW and an equivalent volume of drinking water could be saved.

The 60 m<sup>3</sup> per day of Hammam Attaissir in El Attaouia can be increased to 200 m<sup>3</sup> when considering the four other hammams of the town. Sent to a sewage treatment plant, this volume would request the construction of 6,000 m<sup>3</sup> of ponds of a retention time of 30 days. Sending hamamas GW to the sewage plant is therefore a pointless action and mainly a waste of water and funds.

The public garden area of El Attaouia was simply multiplied by three since treated GW of the hammam is daily available for landscaping (March 2008). Soon, a plant nursery is to be put into service to reduce the cost

► *Figure 8:*  
**“MUNICIPALITY  
 OF EL ATTAQUIA,  
 TREATED  
 GREYWATER NOT  
 SUITABLE FOR  
 DRINKING”**



▼ *Figure 9:*  
**TRAINING  
 COURSE AT THE  
 GREYWATER  
 TREATMENT  
 PLANT AT THE  
 TDC IN RABAT**



of the expected extension of public gardens in the town. The area along the main avenue is becoming now the late-afternoon area for walking, in which the GW treatment plant is just a part of the landscape.

## ACKNOWLEDGEMENTS

The authors would like to thank the Municipality of El Attaouia and the Council for their support, their commitment to this project and co-funding (20%). Many thanks to the Commission of the European Union (MEDA water program) for funding the project Zer0-M and to the Ministry of Agriculture for its support to the IAV Hassan II.



◀ Figure 1

The applications are perfectly suited to operation in remote areas or small communities with tourists depending on the variation of discharged wastewater flows. The advantage in the general sustainable water management approach of each treatment option will be shown, the technologies will be compared in terms of robustness and effluent quality and a first conclusion will be drawn for the field of application in small communities.

It is an accepted practice and also a community expectation in sewerred areas that there is a supply of tap water and that wastewater is drained to a sewer to promote sanitation and hygiene in the home. However, the demands are contradictory to the limited water supplies and rising costs as the population increases. The expansion of water supply catchments and the adequate central wastewater treatment may become difficult, especially for metropolitan areas. Therefore, domestic greywater from single sewerred premises may be considered as a potential resource. Greywater is generally defined as low polluted wastewater originating from bathtubs, showers, hand washing basins and washing machines excluding wastewater from the kitchen and the toilet flushing system (Nolde, 1999). Greywater contains impurities and micro-organisms derived from household and personal cleaning activities and it shows a wide range of pathogenic and other liquid waste materials, which people normally want to eliminate from the inside of their homes (Birks et al., 2004; Friedler, 2004; Ottoson and Stenstrom, 2003; Veneman and Stewart, 2002). Those varieties in greywater quality should be taken into consideration when setting appropriate risk-based standards for reuse. It may be reused on-site for irrigation purposes, toilet flushing, and laundry use depending on the type of greywater and its level of treatment. In single house systems, the favourable option for the reuse of greywater is toilet flushing, because the amount of water required equals the amount of greywater produced for hygiene purposes such as washing, showering and bathing (Birks et al.). It reduces the demand on high quality drinking water by around 35%.

# GREYWATER TREATMENT AS AN OPTION FOR EFFECTIVE WASTEWATER MANAGEMENT

By RENÉ SCHEUMANN, FABIO MASI, BOUCHAIB EL HAMOURI and MATTHIAS KRAUME\*

This paper presents the results of four different investigations where greywater is treated with low technology realised with a constructed wetland and a gravel and sand filter as well as with a high-tech option: the membrane bioreactor.

\* René Scheumann, Matthias Kraume, Technische Universität Berlin, Department of Chemical Engineering, Germany; Corresponding author: René Scheumann, TU Berlin, FG Verfahrenstechnik, 13355 Berlin, [rene.scheumann@tu-berlin.de](mailto:rene.scheumann@tu-berlin.de)  
Fabio Masi, Ambiente e Lavoro Toscana ONLUS, via Pier Capponi 9, Florence, 50132, Italy  
Bouchaib El Hamouri, Department of Rural Engineering, Institut Agronomique et Vétérinaire Hassan II, Rabat, Morocco

## RÉSUMÉ

Ce document présente les résultats de quatre enquêtes lorsque les eaux grises (sans des matières fécales) sont traitées à faible technologie comme réalisé par un station d'épuration de plants et d'un filtre à sable et de gravier ainsi que d'une option de haute technologie: le bioréacteur à membranes. Les applications sont parfaitement adaptées pour être utilisées dans les régions éloignées ou des petites localités touristiques avec des variations en fonction des flux d'eaux usées. L'avantage dans la gestion durable de l'eau de chaque option de traitement sera affiché, les technologies seront comparées en termes de robustesse et de la qualité des effluents et la première conclusion qui sera tirée pour le domaine d'application dans les petites communautés.

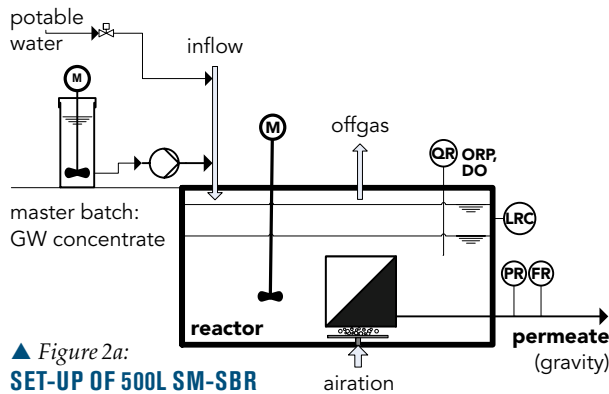

▲ Figure 2a:  
SET-UP OF 500L SM-SBR

Lately, the greywater treatment and reuse option have been widely studied, especially in Europe, Australia, Japan and California. Still, long term investigations are rare, even though Nolde (1999) reported a ten year experience in greywater reuse for a multi storage building. Only a few full-scale plants are in operation to draw enough conclusions from their operation (Friedler, 2004). Therefore, it is essential to study this topic further and to pay enough attention to protect public health as well as to be consistent with the principles of ecological sustainable development, which does not decrease the amenity of the local community.

This paper presents the results of our own experiments on a lab scale and pilot plants, which then are compared among each other and to literature findings with a focus on the differences in greywater treatment.

## MATERIALS AND METHODS

### EXPERIMENTAL SET-UP

Four different technical options to treat greywater have been investigated. On the one hand there are the “low-cost”, “low-tech” treatments of horizontal flow reed beds, vertical flow reed beds, as well as sand-gravel filters and on the other hand there are the results from a “high-cost” “high-tech” solution (the 500 L pilot scale SM-SBR). One is on a pilot scale and operated with synthetic greywater, while the other three were operated under real conditions; set-up B+C are also on pilot scale. Table 1 gives an overview of the four different set-ups.

**Set-up A:** A 500L SM-SBR (figure 2a) was fed with synthetic GW according to (Scheumann et al., 2007). It was designed to represent the GW of a four-person household. Furthermore, it could be shown that the composition is comparable to real GW from the shower effluent of a Moroccan sports club (Merz et al., 2007). The reactor was operated in an SBR mode with a vol-

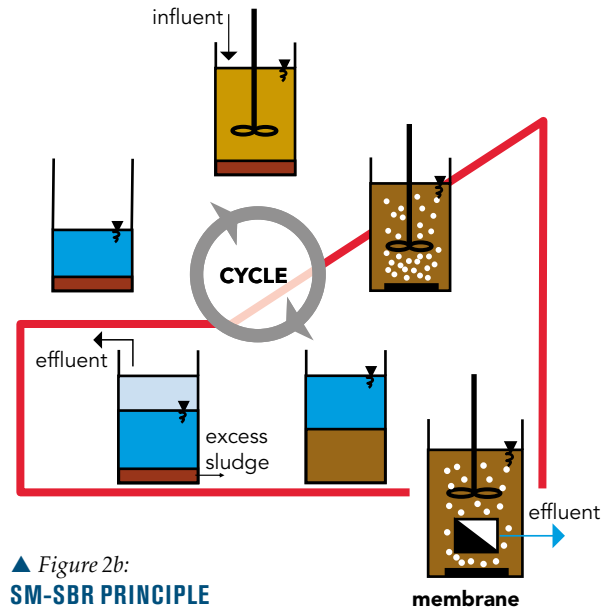

▲ Figure 2b:  
SM-SBR PRINCIPLE

ume exchange ratio of 25% and with cycle lengths of 8, 6, 3, and 2 hours. With the latest set-up, the SBR cycle, as shown in figure 2b, began with a filling phase of 5 min, which was included in the one hour anoxic phase. The aerated reaction phase consisted then of a period of 60 min, including the idle phase. The permeate withdrawal started with the start of aeration.

**Set-up B:** The gravel & sand filter (GSF, figure 3) was taken into operation in June 2005 at the premises of the IAV in Rabat, Morocco to treat greywater coming from a sports club sanitary facility. This comprises ten showers as well as several washing basins which are connected to the greywater collection system. The greywater was screened by a 1 cm × 1 cm-screen and collected in a reservoir made of concrete. At the filter inlet it was passed through a second 1 cm × 1 cm-screen to have reliably removed large particles which might block the filter. The screens were cleaned manually every day. The GSF was constructed as a horizontal and vertical flow filter. It underwent all the variations in flow and load, which came in discrete waves during the day according to the activities in the gym. The gravel material was made of limestone. This purification step was followed by vertical filtration through a multi-layer sand (95% silicium) filter which consisted of four layers of differently sized sand. The diameter of the grains increased from top to bottom. The total hollow volume of the gravel and the sand compartment together was 2.78 m<sup>3</sup> and 4.06 m<sup>3</sup> when the receiving ditches at the inlet of each compartment were included. The GSF received an average flow of 8 m<sup>3</sup>d<sup>-1</sup> with  $Q_{\text{COD}} = 0.8 \text{ kg}_{\text{COD}}\text{d}^{-1}$  on workdays and a theoretical HRT at 0.3 Ls<sup>-1</sup> of 3.8 h.

► Table 1:  
DESCRIPTION  
OF THE FOUR  
DIFFERENT  
TECHNOLOGIES  
IN THIS STUDY

name	reactor type	wastewater	location
Set-up A:	pilot scale 500L submerged membrane sequencing batch reactor (SM-SBR)	synthetic greywater	TUB in Berlin, Germany
Set-up B:	pilot scale unplanted sand & gravel filter (GSF)	real greywater (showers effluent)	IAV in Rabat, Morocco
Set-up C:	pilot scale planted sand & gravel filter	real greywater (showers effluent)	IAV in Rabat, Morocco
Set-up D:	horizontal flow (HF) constructed wetland	secondary treatment of greywater (80 p.e)	camping site, Tuscany, Italy

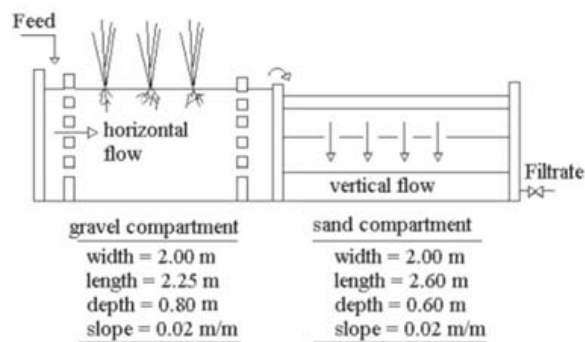

▲ Figure 3:  
SET-UP OF THE GRAVEL SAND FILTER; SET-UP B WITHOUT PLANTS, SET-UP C WITH PHRAGMITES AUSTRALIS

Complete sets of analyses were performed on samples taken at the beginning of the midday wave, i.e. from the most highly polluted influent. Effluent sampling was immediate, i.e. HRT was not taken into consideration.

**SET-UP C:**

One line of the GSF as described in set-up B was planted with *Phragmites australis* in the autumn of 2005, which refers to the operating day 195. 40 shoots were planted in 5 rows of 8 plants each. This resulted in a planting density of 8.9 m<sup>-2</sup>.

**SET-UP D:**

A small camping site “La Cava” in Arezzo, Italy was recently established, and designed according to the Sustainable Water Management principles (water saving, reuse, recycling). As visualised in figure 4, the black- and greywater were segregated into two parallel lines for a separate treatment as follows: greywater is treated at a hydraulic loading rate (HLR) of 8.26 cm d<sup>-1</sup> (equals a flow of 9.5 m<sup>3</sup> d<sup>-1</sup> passing through a HF wetland cell with a surface area of 115 m<sup>2</sup>). The treated greywater was recycled for toilet flushing. The camping complex covered a surface area of about 20,000 m<sup>2</sup> with wood, green terraces and parking places for a total

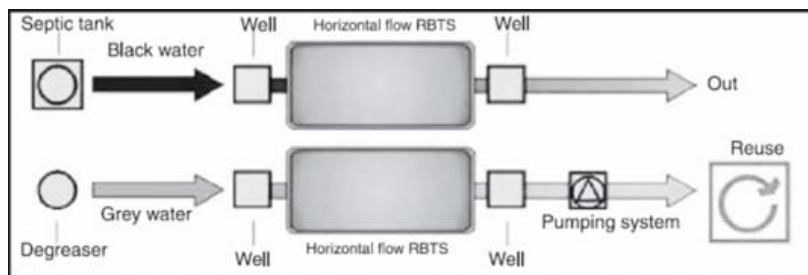

▲ Figure 4:  
SCHEME OF THE CW AT THE CAMPING SITE “LA CAVA”

of 25 cars. The CW area occupies only 3.5% (700 m<sup>2</sup>) of the camp surface area.

**RESULTS AND DISCUSSION**

**GW CHARACTERISTICS**

GW (cf. table 2) was characterised regarding the proportion of readily biodegradable COD (expressed as the ratio BOD<sub>5</sub>/COD) and the nutrient fraction (expressed as the ratio COD/NH<sub>4</sub> N/PO<sub>4</sub>-P). In the literature the ratio BOD<sub>5</sub>/COD varied between 0.25 for GW (Jefferson et al., 2000) and 0.44 for domestic low strength wastewater (Metcalf and Eddy, 2003). The BOD<sub>5</sub>/COD ratio of GW in three studies was within this reported range with a value of 0.25 for set-up A, and a value of 0.43 for set-up B and C. The average ratio of COD/NH<sub>3</sub>/TP has been reported typically with 100/5/1 for domestic wastewater (Metcalf and Eddy, 2003). Kargi and Uygur (2003) calculated an optimum COD/NH<sub>3</sub>/PO<sub>4</sub>-P for a maximum nutrient removal in the activated sludge process for synthetic wastewater with a five-step SBR of 145/5.87/1, whereas Jefferson et al. (1999) measured a COD/NH<sub>3</sub>/TP ratio up to 1030/2.7/1 for GW, indicating a macro-nutrient limitation. The synthetic GW in set-up A had a COD/NH<sub>3</sub>/PO<sub>4</sub>-P ratio of 121/5.69/1, which is very close to the optimum ratio found by Kargi and Uygur. For the highly diluted GW from set-up B and C the ratio of COD/NH<sub>3</sub>/TP was determined at 127/9.13/1 as favourable for biological treatment with no limitation concerning the macro nutrients.

	average values ± standard deviation			average literature values	
	Set-up A	Set-up B & C	Set-up D	Jefferson et al., 1999	Nolde, 1999
pH	7.5±0.3	7.6±0.4	7.6±0.4		
BOD <sub>5</sub> , mgL <sup>-1</sup>	50±11	53±16	53±16	104±45	50-100*
COD, mgL <sup>-1</sup>	209±80	122±21	502	207±115	100-200
TN, mgL <sup>-1</sup>	17.3±6.7			9.6	5-10
TKN, mgL <sup>-1</sup>		15.2±4.5	2.5	3.91±4.72*	
NH <sub>4</sub> -N, mgL <sup>-1</sup>	7.3±5.4	11.8±4.2	1.7		
NO <sub>3</sub> <sup>-</sup> -N, mgL <sup>-1</sup>	0.9±0.9		0.32		
TP, mgL <sup>-1</sup>		1.6±0.53	6.6	3.67±3.88	0.2-0.6
PO <sub>4</sub> <sup>3-</sup> -P, mgL <sup>-1</sup>	0.74±1.6	1.0±0.4			
BOD <sub>5</sub> /COD	0.25	0.43			
COD/NH <sub>3</sub> /TP	121/5.69/1**	127/9.13/1		1030/2.7/1	
Conductivity, µs cm <sup>-1</sup>		855±191			
Faecal Coliform, 100mL <sup>-1</sup>		2.48*10 <sup>5</sup> ± 1.2*10 <sup>5</sup>			10 <sup>-1</sup> - 10 <sup>1</sup>

\* measured as BOD<sub>7</sub>; \*\* as COD/NH<sub>3</sub>/PO<sub>4</sub>-P

◀ Table 2:  
GREYWATER CHARACTERISTICS

## EXPERIENCES FROM THE OPERATION OF GW TREATMENT PLANTS

The SM-SBR was put into operation in January 2006 with a volumetric exchange ratio of 0.25 and started off with an HRT = 33 h. Investigations of COD and nitrogen removal within one cycle, combined with the on-line measurements of DO, ORP and the flux of the membrane module showed possible optimisation potentials in terms of time reduction for the aerated and anoxic phase. After 80 days, the HRT was reduced to 24 h and has been since reduced in consecutive steps down to 8 h. A short HRT is desirable because **Hu (2002)** found the optimal HRT for GW treatment to be around 1.5 h. With an HRT = 8 h and the last modification to gravity flow the permeability is on average of  $360 \text{ L}(\text{m}^2\text{hbar})^{-1}$  (flux =  $25 \text{ Lm}^2\text{h}^{-1}$ ) for the UF-module and of  $660 \text{ L}(\text{m}^2\text{hbar})^{-1}$  (flux =  $35 \text{ Lm}^2\text{h}^{-1}$ ) for the MF-module. In studies on municipal and domestic wastewater flux values for submerged membrane modules between 5 and  $40 \text{ Lm}^2\text{h}^{-1}$  was found (**Stephenson et al., 2000**).

The mean organic loading rate for the GSF in set-up B&C was low with  $L_{\text{org}} = 0.29 \text{ kg}_{\text{COD}}(\text{m}^3\text{d})^{-1}$  compared to the value of  $1.09 \pm 0.73 \text{ kg}_{\text{COD}}(\text{m}^3\text{d})^{-1}$  found by **Jefferson et al. (2000)**. However, it has to be taken into consideration that, especially in the sand filter, only a part of the volume was actually used. If the effectively used reactor volume was taken as a reference, the organic loading rate would be higher. The evolution of the reed in set-up C was that in the first two rows this grew significantly faster than in the last three rows. This is explained by the gradual decrease of the water level in the gravel due to head loss. The roots of the plants in the first rows reached the water earlier or in the case of the first row were submerged into it from the beginning. Thus these plants needed root growth only for anchoring and could invest more energy in the development of emergent plant mass. It appears that planting did not have an overall optimising effect on the GSF. This observation, however, might be due to the fact that results achieved with the unplanted filter were already satisfactory. A negative effect of planting was the decrease of hydraulic conductivity and a subsequent overflowing of the receiving ditch at times with high inflow rates. Phosphorus uptake by the plants may explain the increase in total phosphorus removal with respect to the previous year. However, as total phosphorus concentration in the influent was low this was not a critical issue.

The wastewater production at the camping site "La Cava" has a high weekly fluctuation in the range of  $0.3$  to  $7.0 \text{ m}^3\text{d}^{-1}$ . The inlet chemical composition of the segregated greywater is high in comparison to other reported values for greywater. This is probably due to the concentrating effect obtained with the various water saving measures in operation resulting in average influent concentrations three times higher than measured in the other places (**Masi et al., 2007**).

**Table 3** shows the removal efficiencies for COD, TN and  $\text{NH}_4\text{-N}$  for the different set-ups, as well as the average feed and permeate concentrations over the operation period. Each cycle time reduction of the SM-SBR enhanced the removal efficiency and with an HRT of 8 h a first optimised cycle time seems to be reached. The TN removal of 81% achieved under the latest HRT compared to the removal of 73% for the HRT of 33 h illustrated the success of an optimised cycle. The treatment efficiency of the CW was rather impressive according to the high inlet COD of  $503 \text{ mgL}^{-1}$  with a removal efficiency of approximately 90%. Moreover, the treatment performances of the horizontal flow CW for greywater treatment fulfilled the stringent Italian water quality limits for treated wastewater reuse.

## REUSE OPTION AND ITS BENEFIT FOR SMALL APPLICATION PURPOSES

One of the most common solutions for the reuse of greywater is garden watering, the irrigation of vegetable and crops as well as the use for toilet flushing. Garden watering for example accounts for around 34% of the total household water budget in Melbourne, Australia, with a highly seasonal demand (**Christova-Boal et al., 1996**). However, it should be noted that with many of the larger scale schemes, which may include rainwater, the recycled water can be employed for other urban uses such as park irrigation, street cleaning etc. (**Lazarova et al., 2003**).

The reuse of the treated GW from the SM-SBR is applicable for in-house use, cleaning purposes, like washing cars and irrigation. The biggest advantages of an effluent with a high hygienic quality and a small footprint of the reactor come into play for tourism-attractive centres. The CW as well as the GSF have their share in the sustainable water management approach due to their low investment and operational costs. The treatment performance is excellent, when correctly de-

► **Table 3:**  
**AVERAGE CONCENTRATIONS OF PERMEATE AND THE ACHIEVED REMOVAL EFFICIENCIES**

	Mandatory values ( $\text{mg L}^{-1}$ )	Set-up A (HRT = 8h)		Set-up B		Set-up D	
		Permeate ( $\text{mg L}^{-1}$ )	Removal efficiency	Effluent ( $\text{mg L}^{-1}$ )	Removal efficiency	Effluent ( $\text{mg L}^{-1}$ )	Removal efficiency
Turbidity	/	/	/	1.7 NTU	0.93		
COD	30 <sup>1</sup>	18.9	0.91	38	0.81	53	0.89
TKN	/	4.1 <sup>3</sup>	0.81	9	0.39	1.1	0.56
$\text{NH}_4\text{-N}$	0.39 <sup>2</sup>	0.37	0.97	5.8	0.62	0.13	0.92
$\text{NO}_3\text{-N}$	11.3 <sup>2</sup>	3.66	/	/	/	0.46	/

<sup>1</sup> Directive (75/440/EEC) <sup>2</sup>Directive (98/83/EC) <sup>3</sup>measured as TN

signed, but can fail fast, when underdesigned. Maybe an additional UV disinfection is needed here.

## CONCLUSION

Greywater reuse is next to rainwater harvesting the first decision which should be considered both by individuals and the community when it comes to the reuse of water. The results obtained from the CW provide the excellent treatment of greywater with variable peak flows. Therefore it can be recommended that this configuration are used as a benchmark design for other hot climate remote areas or small communities needing to improve and preserve the quality of open water bodies. The SM-SBR is an option where space is limited and a high hygienic quality is needed. The unplanted GSF is a very simple technology for low polluted greywater, but needs to be carefully designed to avoid clogging. All of the technologies described should be considered as solutions to gain advantages from a sustainable water management with its many reuse options.

## ACKNOWLEDGEMENTS

This study is partially funded by the European Commission under the MEDA programme, project "Zer0-M" N° ME8/AIDCO/2001/0515/59768 and under the Fifth Framework Programme, contributing to the implementation of the Key Action "Sustainable Management and Quality of Water" within the Energy, Environment and Sustainable Development Programme, project "SWAMP" N° EVK1-CT-2000-00071. The authors are solely responsible for the content of this paper, which does not represent the opinion of the Community. The European Community is not responsible for any use that might be made of data appearing therein.

## REFERENCES

- Birks, R., Colbourne, J., Hills, S. and Hobson, R. (2004). "Microbiological water quality in a large in-building, water recycling facility." *Water Sci Technol* 50(2), 165-72.
- Birks, R., Hills, S., Diaper, C. and Jeffrey, P. "Assessment of water savings from single house domestic grey water systems." 2007.
- Christova-Boal, D., Eden, R. E. and McFarlane, S. (1996). "An investigation into greywater reuse for urban residential properties." *Desalination* 106(1-3, Desalination and Water Reuse), 391-397.
- Friedler, E. (2004). "Quality of individual domestic greywater streams and its implication for on-site treatment and reuse possibilities." *Environmental Technology* 25(9), 997-1008.
- Hu, B. (2002). "The most optimal retention time for greywater bio-chemical treatment." *Huanjing Wuran Zhili Jishu Yu Shebei* 3(7), 30-31, 60.
- Jefferson, B., Judd, S. and Diaper, C. (2000). Treatment methods of grey water, In: P. Lens, Decentralised Sanita-



▲ Figure 5:  
**500 L PILOT SCALE  
SM-SBR FOR THE  
TREATMENT OF  
GREYWATER AT THE  
TECHNISCHE  
UNIVERSITÄT  
BERLIN, GERMANY**

tion and Reuse - Concepts, Systems and Implementation. Chapt. 17, IWA publishing.

- Lazarova, V., Hills, S. and Birks, R. (2003). "Using recycled water for non-potable, urban uses: a review with particular reference to toilet flushing." *Water Science & Technology: Water Supply* 3(4), 69-77.
- Masi, F., Martinuzzi, N., Bresciani, L., Giovannelli, L. and Conte, G. (2007). "Tolerance to hydraulic and organic load fluctuations in constructed wetlands." *Water Science & Technology* 56(3), 39-48.
- Merz, C., Scheumann, R., El Hamouri, B. and Kraume, M. (2007). "Membrane bioreactor technology for the treatment of greywater from a sports and leisure club." *Desalination* 215, 37-43.
- Nolde, E. (1999). "Greywater reuse systems for toilet flushing in multi-storey buildings - over ten years experience in Berlin." *Urban Water* 1(4), 275-284.
- Ottoson, J. and Stenstrom, T. A. (2003). "Faecal contamination of greywater and associated microbial risks." *Water Res* 37(3), 645-55.
- Scheumann, R., Besançon, A., Jefferson, B. and Kraume, M. (2007). Biological Parameters in Greywater Treatment with a Submerged Membrane Sequencing Batch Reactor. 4th International Water Association Conference on Membranes for Water and Wastewater Treatment (15-17 May 2007), Harrogate, Großbritannien.
- Stephenson, T., Judd, S., Jefferson, B. and Brindle, K. (2000). *Membrane Bioreactors for Wastewater Treatment*, IWA Publishing.
- Veneman, P. L. M. and Stewart, B. (2002). Greywater characterization and treatment efficiency. Massachusetts, The Massachusetts Department of Environmental Protection: Bureau of Resource Protection.



# INTEGRATED APPROACH TO WATER SAVING

## A PRACTICAL EXAMPLE IN A STUDENT RESIDENCE IN TUNISIA

By LATIFA BOUSSELMI, MOUNA LAMINE and AHMED GHRABI\*

According to experts of water, the efforts made on the mobilization of hydraulic resources in Tunisia will support up to 2030, a balance between supply and demand [1].

It is thus necessary to control any reasons for water over-consumption as they arise and to act to save water. Among the origins of water over-consumption we can count the out-datedness of the water distribution network, water leaking from the sanitary equipments such as flushing systems and the strong not optimized water demand. Indeed this water demand can reach 800 L/d-bed in the hospitals, 100 L/d-agent in the public administrations, 550 L/d-resident in the hotels and 300 L/d-student in the universities [1].

\* Latifa Bousselemi, Mouna Lamine, Ahmed Ghrabi, Centre de Recherches et Technologies des Eaux, Technopole Borj Cedria, Tunisia, [Latifa.bousselemi@certe.rnrt.tn](mailto:Latifa.bousselemi@certe.rnrt.tn)

◀ Figure 1

Households and public buildings use 54%, industry 33% and tourism 13% of total potable water [1]. To prevent this situation, it is necessary to modernize the hydraulic equipments as a result of installing water saving devices and to rationalize water consumption in economic activities. In the same way, it is necessary to implement the local management of water, integrating wastewater which will be regarded as resources and not as waste, as quickly as possible.

The aim of this paper, developed in the framework of the Zer0-M project, is to study (i) water consumption in a public sector building (urban area), (ii) the possibilities of water savings and (iii) the contribution of the implementation of local water management.

### PRESENTATION OF THE STUDY CASE

The case study considered is a student building comprising a ground floor and three floors with a maximum capacity of 212 students considered in this work to be constant. Table 1 summarizes the local distribution of the sanitary facilities as well as providing photos of the available equipments. The shower room is located on the ground floor, the toilets and the wash-hand basins are located on each floor.

In order to work out how much water could be saved, it is necessary to first know how much water is used. Water meters are implemented on the ground floor which is inhabited by 26 students. Water consumption is monitored at three levels:

- Hot and cold waters demand for showering;
- Water used in the wash-hand basins by students for sanitary needs or for washing some utensils and clothes;
- Water for toilet flushing.

The first monitoring was carried out from April to May 2007, and then at different periods corresponding

### RÉSUMÉ

L'objectif de l'étude est d'étudier la consommation en eau au niveau d'une institution publique, les possibilités d'économies d'eau et l'apport d'une gestion locale de l'eau. L'étude de cas intéresse un foyer universitaire formé de 3 étages et un rez-dechaussée ayant une capacité maximale de 212 étudiantes. Le suivi de la consommation en eau au niveau des différentes utilisations permet d'identifier celles qui enregistrent une consommation élevée en eau et d'agir pour y remédier. Une fuite au niveau des chasses d'eau peut multiplier les quantités d'eau par cinq. La mise en place d'équipements d'économie d'eau peut permettre un gain supplémentaire (73%) et/ou permettre une gestion optimale (faible maintenance, faible risque de fuite d'eau). Enfin, un traitement des eaux grises en vue de leur recyclage dans les chasses d'eau permettra une économie d'eau importante et une gestion durable l'eau.



to the introduction of technical modifications to the distribution network.

## WATER MONITORING RESULTS

The survey results don't include holidays as students leave the building. The number of students decreases during the weekends, but as this is not possible to predict, the total number of students is presumed to be constantly 212 during the whole time. This leads to an underestimation of the calculated water consumption expressed as L/student (L/St).

## WASH-HAND BASINS AND SHOWERS

The water consumption at the wash-hand basins is 0.7m<sup>3</sup>/day (figure 2, left) corresponding to 27 L/St-day. Based on the total number of students, the overall consumption rises to 5.7m<sup>3</sup>/day. It corresponds to multi-daily uses.

All showers are concentrated on the ground floor. The use of cold water is dependent on the temperature of the hot water. Students use an average of 7.41 m<sup>3</sup>/day corresponding to 35 L/St-day (figure 2, right). The average frequency of use is estimated to be equal to three times per week (81 L/St-shower).

## TOILET FLUSHING

The monitoring of water demand for toilet flushing on the ground floor, during the same period, showed a high consumption of 6,36 m<sup>3</sup>/day corresponding to the first slope of figure 3. It is equivalent to 244 L/St-day. In the light of this situation, the managers of the student building started maintenance work during the holidays in relation to the flushing system to avoid any leaking. The work undertaken makes it possible to reduce consumption to 1.14 m<sup>3</sup>/day (second slope of the figure 3) and clearly demonstrates the importance of a good maintenance. Thus the student building consumption for toilet flushing decreases to 44 L/St-day (9,3 m<sup>3</sup>/day).

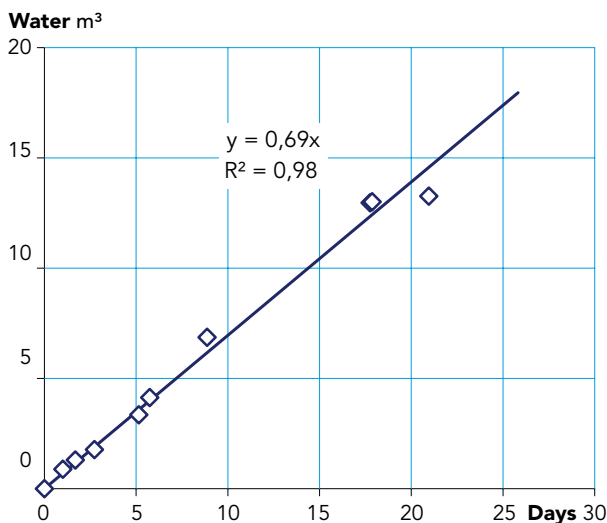

	Wash hand basins	Shower	Toilet
Rez-de-chaussée	10	18	5
Each floor	20	0	10
Total	70	18	35
Equipment			

Based on the monitoring results, the total water demand of the student house building is 22.4 m<sup>3</sup>/day (106 L/St-day) and the percentages of distribution based on the uses are 25.5%, 33% and 41.5% respectively for wash-hand basins, shower and flushing. The percentage of black water corresponding to toilet wastewater is 41.5% and grey water related to wastewater from wash-hand basins and showers is 58.5% whereas in general the latter account for 73% and black water 27% [2]. It should be noted that in this case, grey water does not comprise wastewater from the kitchens and only a small part of the wastewater is related to the washing of clothes. The obtained water consumption of 106 L/hab-day is close to the Tunisian household average and then remains rather high. However in the absence of good maintenance, it reaches 306 L/St-day. This value is equivalent to the one presented in the introduction.

▲ Table 1: SANITARY FACILITIES, REPARTITION, NUMBER AND EQUIPMENT.

## IMPLEMENTATION OF WATER SAVING DEVICES

In order to save more water, the administrators of the student building implement saving devices in showers and flushing toilets systems. The corresponding technical characteristics are summarized in table 2.

The water flow is measured for the showers and the average value is 6 L/min, for flushing, the average capacity is 5.4 L corresponding to a water flow average of 0.9 L/s. The difference between these values and table 2 could be linked to the dynamic pressure of the water distribution network. Nevertheless, water flows ap-

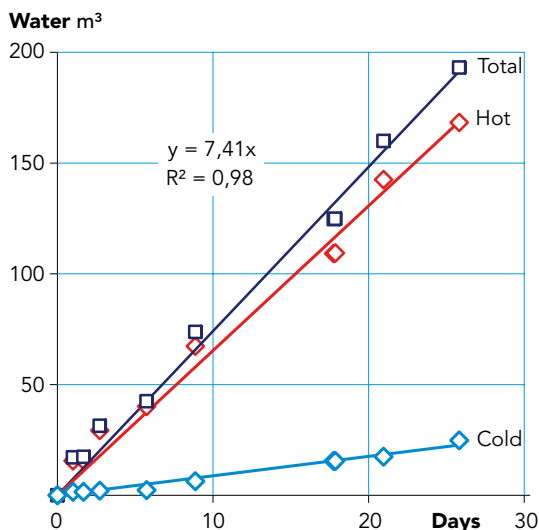

◀ Figure 2: WATER CONSUMPTION HAND WASH BASINS (LEFT) AND SHOWERS (RIGHT), MONITORING PERIOD: 18/4-24/5/2007

► **Figure 3:**  
**WATER CONSUMPTION, FLUSHING TOILETS MONITORING PERIOD: 14/4 - 1/6/2007**

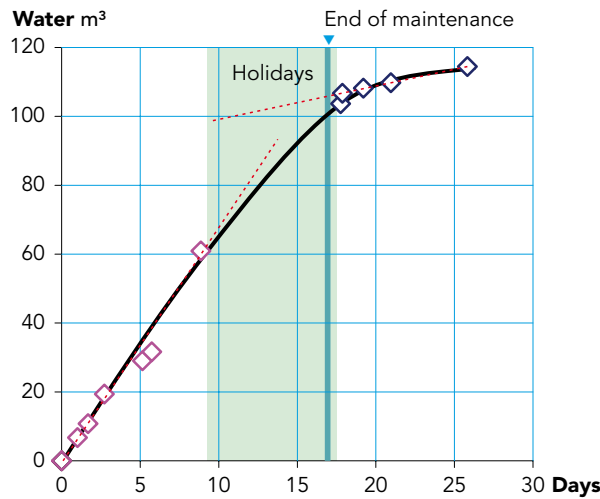

pear fixed by the administration to low limits according to **Table 2**.

The monitoring of water consumption during showering shows a major reduction. Water demand is now estimated as 2 m<sup>3</sup>/day or 9.4 L/St-day very far from the previous value of 35 L/St-day. This new rate can be explained by the strong reduction of the flow rate and the temporisation effect which could have an important impact on water management during showering. Producers of equivalent water saving devices claim that water saving ratios equal to 70% can be achieved. This will save water and energy costs as hot water consumption represents 87% of the total demand (**figure 2**). However in this case, a longer monitoring period is necessary to confirm this conclusion which should be associated with a study of the acceptance to determine if the low water flow provides a comfortable stream of water with good wetting and rinsing characteristics (**figure 4**).

Concerning the toilet flushing water demand, a short survey leads to 1.05 m<sup>3</sup>/day used for this purpose on the ground floor (40 L/St-day). No notable variation is observed since the flushed water volume remains equivalent to that of the precedent flushing system shown in **table 1** with a capacity of 5 to 6 L. However, the main advantage of the new system with water saving devices is the low risk of water leakage and a low level of maintenance work.

The maximum total water consumption after implementing the water saving devices is equal to an average of 16.2 m<sup>3</sup>/day with 52% used for toilet flushing. The next step to be considered is the wash hand basins representing 37% of water consumption and which are not yet integrated in this water saving strategy.



▲ **Figure 4:**  
**SHOWER HEAD**

▼ **Table 2:**  
**WATER SAVING DEVICES CHARACTERISTICS**

	For Toilet flushing	For shower
Equipment	Time delayed taps	Time delayed mixer taps
Volume / flow rate	6 - 9 L	6 - 12 L / min
Dynamic pressure	1 - 5 bar	2 - 5 bar
Temporisation time	6 s	30 s ± 10 s

## CONTRIBUTION OF LOCAL WATER MANAGEMENT APPROACH FOR WATER SAVING

In order to decrease the quantity of water used for flushing, the grey water from showering is treated by biological processes: membrane bioreactor (MBR) or sequencing batch reactor (SBR) with UV disinfection, before recycling for toilet flushing [3, 4]. The grey water quality obtained before the implementation of a water saving device has already been presented [3]. Water saving devices increase the concentration of pollutants due to the decrease of water demand. The average values obtained during February 2008 are 193 mg/L, 14 mg/L and 7.8 mg/L respectively for COD, KTN and PO<sub>4</sub><sup>3-</sup>. A reactors' performances analysis [5] demonstrated that the average COD obtained after treatment by MBR is 33 mg/L. Treated grey water was recently injected for toilet flushing and, as a first experience, only one toilet is concerned by this recycling for monitoring and further improvement. The treated flow rate is equal to 1 m<sup>3</sup>/day. The finalization of this recycling process will lead to an equivalent water saving. Rainwater harvesting is also implemented for feeding one shower for further saving and demonstration purposes [4].

## DISCUSSION AND CONCLUSION

The monitoring of water consumption linked to the different uses in the student building makes it possible to identify those which record a high water consumption and to act to reduce it. The elimination of water leakages from the flushing toilet system leads to an 82% water saving ratio. The installation of adapted hydraulic equipments can allow 73% water savings for showering and/or an optimal management (low maintenance, low risk of water leakage).

In order to determine the efficiencies of the undertaken actions in this study case and to compare them with the potential contribution of a local water management approach (decentralized system) different measures are considered. **Figure 5** summarises the water demand and discharged water production (L/St-day) function of the different situation or actions already undertaken (**A to D**) and some others possibilities which could be envisaged (**E to G**):

- A:** Initial situation
- B:** Maintenance work on flushing system
- C:** Saving devices implementation in showers and toilets flushing
- D:** C + Grey water treatment and the recycling of 1m<sup>3</sup>/day in toilet flushing
- E:** C + Total grey water treatment and recycling in toilet flushing
- F:** D + Saving devices implementation on wash hand basins with expected water savings of about 70%, due to automatic 15 sec shut-off delay and 6 L/min pre-set flow rate (producer information)
- G:** F + total grey water treatment and recycling

From action A to D, a water saving of 76% is achieved. The ratio grey water/toilet water demand is

equal to 0.9 (action C) which allows the strong decrease of toilet flushing water demand after grey water treatment and recycling (action E), 47% water saving. The comparison between action E and F demonstrates that the result achieved by greywater recycling is more interesting than action F related to saving devices implementation on wash hand basins. This action leads to a decrease in wash hand basin water demand, but also a decrease of grey water production and the amount of recycled water. As a consequence, the flushing toilet demand increases in G by comparison to E, but the total water consumption stays constant. Situations E and G correspond both to the minimum of demand (40 L/St-day) and integrate total greywater treatment and recycling (no discharge). The difference is the implementation of water saving devices in wash hand basins. This additional cost could be balanced by the lower grey water volume to be treated (52% lower). The development of low-cost efficient treatment technology is an important issue for the application of a decentralised approach.

### ACKNOWLEDGEMENTS

The authors would like to acknowledge the director of the student house building "cité des Jardins", Tunisia for her efficient cooperation.

### REFERENCE

- [1] TAP, TUNIS, 30 mars 2006, Séminaire SONEDE : mobilisation des ressources hydrauliques durant les cinquante dernières années, [http://www.tap.info.tn/fr/index.php?option=com\\_content&task=view&id=4741&Itemid=205](http://www.tap.info.tn/fr/index.php?option=com_content&task=view&id=4741&Itemid=205)
- [2] Friedrich Gerhard Wach, sustainable water management, local train the trainer course (TtT) organized by Zer0-M project, Tunis 14 - 16 November 2005
- [3] Regelsberger, M., Baban, A., Bousselmi, L., Abdel Shafy, H., El Hamouri, B. (2007). Zer0-M, sustainable concepts towards a zero outflow municipality. *Desalination*, 215, 64-72
- [4] F. Arnold, L. Bousselmi, Local waters treatment and reuse in a students' residence hall – a study on acceptance, *Zer0-M Journal* 2007-2
- [5] Ahmet Baban, Latifa Bousselmi, Bouchaib El Hamouri, Hussein Abdel Shafy, Outlook – Training and demonstration Centres, *Zer0-M journal* 2008-2

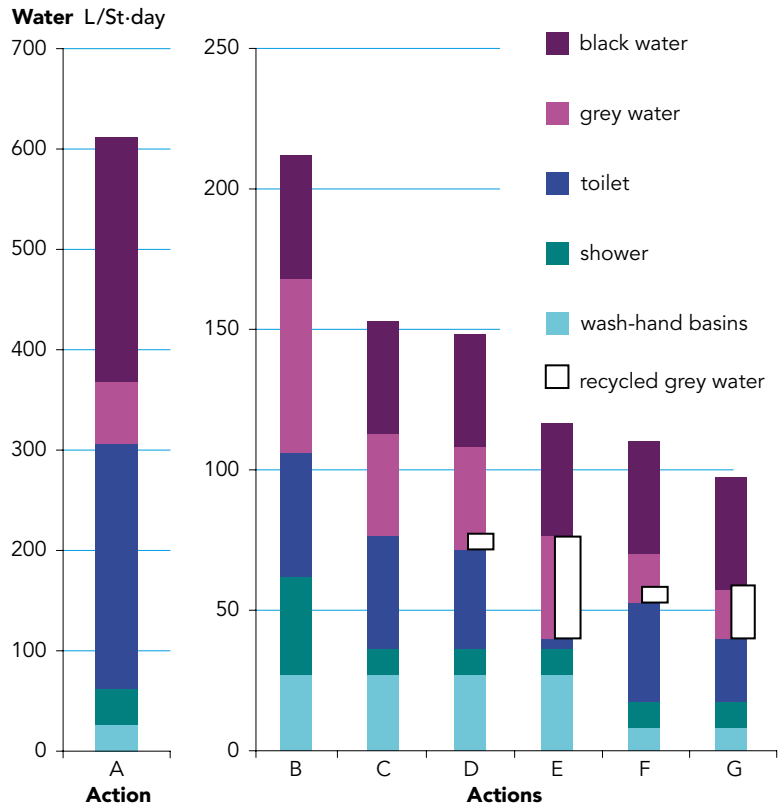

▲ Figure 4: WATER DEMAND AND DISCHARGED WATER PRODUCTION FUNCTION OF DIFFERENT ACTIONS, (A) INITIAL SITUATION, (B) MAINTENANCE WORK, (C) SAVING DEVICES SHOWERS AND TOILETS FLUSHING, (D) C + GREY WATER RECYCLING 1m<sup>3</sup>/day, (E) C + TOTAL GREY WATER RECYCLING, (F) D + SAVING DEVICES WASH HAND BASINS, (G) F + TOTAL GREY WATER RECYCLING

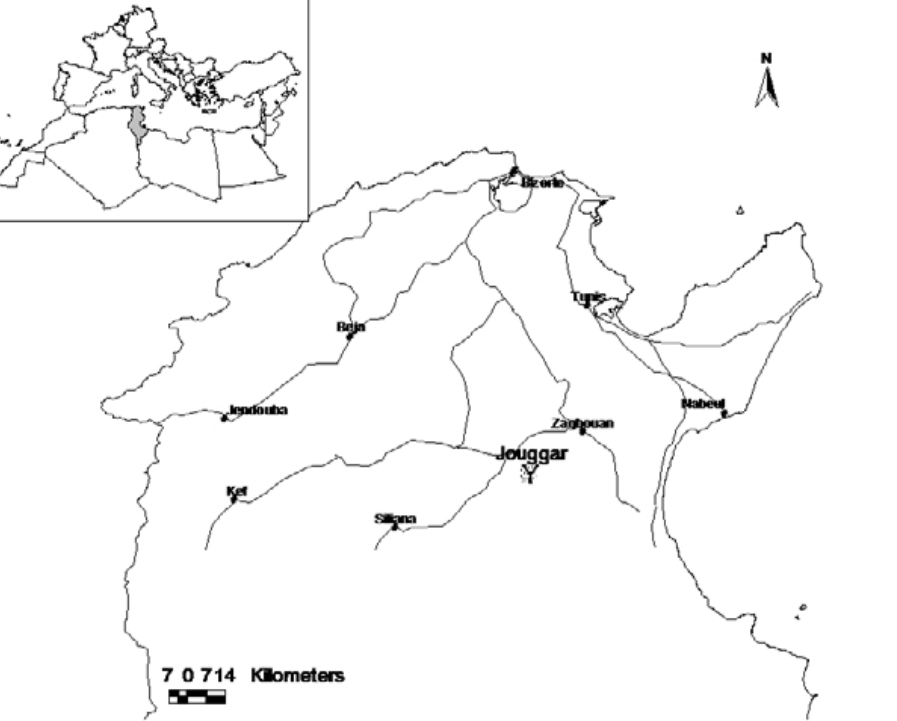

◀ Figure 1:  
LOCATION OF JOUGGAR IN TUNISIA

With the help of the Zer0-M Decision Support System, five different alternatives of wastewater management in a small Tunisian village have been designed. Advantages and disadvantages of each alternative have been assessed through Multi Criteria Analysis. The results show that the wastewater reuse for agriculture can nowadays be considered as a “conventional” component of water management in Tunisia, but more sustainable solutions—such as greywater separation—are considered too expensive and could be accepted only when, among decision criteria, water conservation is given a higher importance than costs.

In order to decide the best water management solution in a given area, we need to estimate and compare the effects of possible alternative choices. Multi Criteria Analysis (MCA) provides a transparent and integrated view of the effects of different alternatives, based on all the relevant criteria the decision makers want to take into account. At the same time Geographic Information Systems (GIS) provide a powerful tool to quicken the preliminary design of water management schemes. Both MCA and GIS functionalities were integrated in a computer aided Decision Support System (DSS), developed within the Zer0-M project, that will soon be freely available on the web ([www.zer0-m.org](http://www.zer0-m.org)). The DSS has been tested to compare different possible wastewater management schemes in a small rural Village in Tunisia.

## THE VILLAGE

Jouggar is a village of 800 inhabitants located in the mountain region of Zaghuan (semi-arid climatic zone), around 100 Km south of Tunis in Tunisia (figure 1). The village borders the “Jouggar aquifer”, an important underground water reserve, that supplies water to Tunis, through the Roman aqueduct.

# MULTICRITERIA ANALYSIS FOR WATER AND WASTEWATER MANAGEMENT IN SMALL RURAL AREAS

By GIULIO CONTE, MAKRAM ANANE, ANDREA GOLTARA, ILARIA PRINCIPI and HAMADI KALLALI\*

Different approaches to tackle water and wastewater management in a small rural area: comparison of advantages and disadvantages based on a multicriteria analysis

\* **Giulio Conte**, Biologist, has worked for 20 years as a professional consultant in the field of sustainable water and river basin management; since 2003 he has been with ALT (an Italian environmental NGO) on the Zer0-M project, [conte@altnet.it](mailto:conte@altnet.it)

**Andrea Goltara**, Environmental engineer, works as a freelance consultant in the fields of sustainable water management and river restoration, for private firms, public bodies, including the EC, and NGOs. At present he is the general manager of the Italian NGO CIRF (Italian Centre for River Restoration), [a.goltara@cirf.org](mailto:a.goltara@cirf.org)

**Makram Anane** received his PhD on remote sensing and agriculture from Lérida University (Spain) in 2004. He is currently Associate Professor at Wastewater Treatment and Recycling Laboratory at Water Research and Technologies Centre, Tunisia, [makram.anane@certe.nrnt.tn](mailto:makram.anane@certe.nrnt.tn)

**Hamadi Kallali** is Chief Engineer of Rural Engineering, waters and Forests and Assistant researcher at Wastewater Treatment and Recycling Laboratory (LTREU) of Tunisian National Institute for Scientific and Technical Research (INRST), Hammam-Lif, Tunisia, [Kallali.Hamadi@inrst.nrnt.tn](mailto:Kallali.Hamadi@inrst.nrnt.tn)

## RÉSUMÉ

Avec l'appui du système d'aide à la décision de Zer0-M, cinq alternatives ont été conçues pour la gestion de l'eau usée dans une petite localité tunisienne. Les avantages et les inconvénients de chaque alternative ont été évalués par une analyse multicritère en combinant des critères économiques, environnementaux et sociaux. Les résultats obtenus montrent que la réutilisation de l'eau usée en agriculture qui fait partie du schéma conventionnel de gestion de l'eau en Tunisie est dans les circonstances actuelles la solution la plus adéquate. Cependant des solutions plus durables, telles que la séparation des eaux grises, sont encore considérées chères et elles ne peuvent être acceptées que lorsque la notion de la conservation de l'eau aura une importance supérieure à celle de son coût.

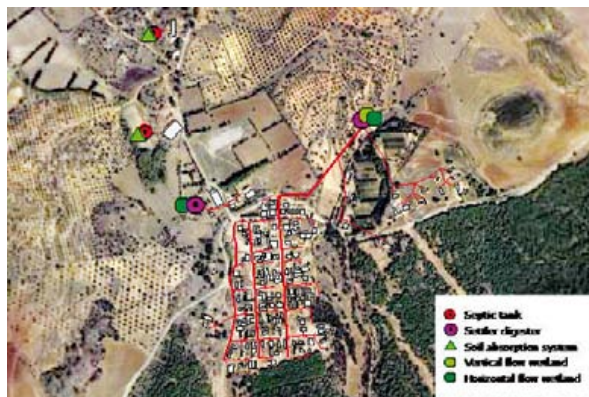

◀◀ *Figure 2:*  
**EXISTING  
SEWERAGE SYSTEM  
IN JOUGGAR,  
TUNISIA**

◀ *Figure 3:*  
**AN EXAMPLE OF  
THE USE OF GIS  
TO DESIGN  
ALTERNATIVES**

The village is served by a water distribution network and by a sewerage system that collects most of the wastewater (151 of 175 houses), except for the scattered houses (figure 2) served by individual systems (septic tanks). The main sewerage network of the village is connected to a constructed wetland. All the pipes, made of compressed concrete, have a single diameter of 300 mm, determined “blindly” without previous studies: as a result the sewerage doesn’t work properly and needs to be restored and partly replaced. The constructed wetland was designed several years ago, and would need to be rebuilt according to a more advanced technical design.

## WASTEWATER MANAGEMENT ALTERNATIVES

To check the possibility to introduce innovative SWM solutions in Jouggar’s water management system, five different alternatives related to water and wastewater management have been designed at a preliminary-feasibility-stage: two more “conventional” ones adopted centralized systems (with mixed or separate sewers for black and white waters); other alternatives were “decentralized”, including the in-house separation, treatment and reuse of black and greywaters.

All of the alternatives involve the complete rebuilding of the sewerage network and of the treatment system of the main cluster of houses (151 houses); the reuse of treated water and nutrients for local agriculture use is also envisaged for all the alternatives, even if this is with different technical options which allow different “reuse performances”.

To design the alternatives, the Zer0-M Design Support System was used: geographical information was partly based on the “carte agricole”, an official spatial database set up to support planning farming activity, partly on information freely available on the internet (google earth).

### ALTERNATIVE 1

It is the most “conventional” solution: the main village sewerage is rebuilt (mixed sewer gravity line) and connected to a settler digester (primary treatment) discharging into a hybrid constructed wetland (CW); scattered houses are treated through smaller digesters and wetlands or septic tanks and then wastewater is discharged into the soil.

Due to the mixed sewer, during rain events overflow will be diverted before the WWT system and will not be reused: no reservoir for the storage of water in the rainy season is included. All sludge collected in the primary systems (two septic tanks and two settler digesters) is composted and reused for agriculture.

Outflow from all of the four WWT systems (except for the evaporation fraction) is directly used for irrigation from April to October. No rain water/greywater storage systems are considered. No greywater reuse or rain water collection systems are designed within the users.

### ALTERNATIVE 2

This alternative envisages the same general architecture of alternative 1, but the sewerage system is designed as two separated gravity lines, one for black and greywater and the other for rainwater collection. Thanks to the separated sewer, rain water is collected and stocked in an open reservoir and used for irrigation. In addition to this, outflow from the WWT system (except from the evaporation quote) is also stored in the reservoir and used for irrigation.

### ALTERNATIVE 3

Each house in the village has a rain water harvesting system. Rain water is re-used within the house lowering potable water demand. Greywater is collected, treated and stored (in the same tank of rain water) within the house and used for irrigation during the dry season. Greywater treatment is carried out through SBRs. No sewers are considered. Toilets are composting toilets with urine separation. Urine and composted faeces are collected through a municipal service (once every two weeks) and used for agriculture.

### ALTERNATIVE 4

Alternative 4 differs from alternative 3 only in the greywater treatment system adopted: roughing filters instead of SBR.

### ALTERNATIVE 5

This is an intermediate solution between alternative 2 and alternative 4: every house has a rain water harvesting system and greywater treatment (through a roughing filter) and reuse. Only black water from toilet flushing will be collected and treated in WWT plants.

	ALT 1	ALT 2	ALT 3	ALT 4	ALT 5
<b>Sewer</b>	Mixed	Separated	No sewer (composting toilet)	No sewer (composting toilet)	only BW
<b>Treatment</b>	Centralized (CW)	Centralized (CW)	Individual, only Greywater, SBR	As for ALT 3, treat by roughing filters	BW centr.CW, GW as ALT 4
<b>Rain harvesting</b>	No	Yes (centralized)	Yes (indiv.)	Yes (indiv.)	Yes (indiv.)
<b>Greywater reuse</b>	No	No	Yes	Yes	Yes
<b>Wastewater reuse</b>	Yes	Yes	Yes	Yes	Yes

BW: Black water, CW: Constructed Wetlands, GW: Greywater

▲ *Table 1:*  
**SYNTHESIS OF THE FIVE ALTERNATIVES DEVELOPED**

## MULTICRITERIA ANALYSIS

To compare the “performance” of the five alternatives, a set of criteria have been addressed, taking into account economic aspects (investment and management costs), environmental ones (the amount of water used, pollution produced, impacts on landscape, level of nutrient reuse) and socio-cultural (technical feasibility, acceptability) ones.

Each criterion was measured through an appropriate indicator (quantitative or qualitative) and an estimation was done to predict the effect of each alternative, in

▼ *Table 2:*  
**“EVALUATION MATRIX”, REPRESENTING THE NORMALISED VALUE OF EVALUATION INDICATORS CORRESPONDING TO THE ANALYSED ALTERNATIVES**

	ALT1: mixed sewer	ALT 2: separated sewer	ALT 3: Zer0-M (SBT)	ALT 4: Zer0-M (trickling)	ALT 5: separated plus reuse
Total water flow extracted per person	0.20	0.26	1.00	1.00	1.00
Flow of water available for irrigation	0.28	0.70	0.21	0.21	0.18
Degree of Nutrients reuse (N, P)	0.81	0.81	0.94	0.94	0.81
Energy employed (per person)	0.03	0.03	0.99	1.00	0.51
Quality-pressure on sinks	1.00	1.00	1.00	1.00	1.00
Landscape quality (worsened or improved by the project)	0.50	0.50	0.50	0.50	0.50
Local Mastering of technologies adopted	1.00	1.00	0.50	0.50	1.00
Socio-cultural acceptability of solution adopted	1.00	1.00	0.00	0.00	1.00
Nuisance (mosquitoes, smell)	1.00	0.50	0.50	0.50	1.00
Present (discounted) value of total costs (all technical options)	1.00	0.88	0.00	0.63	0.86
Investment costs (all technical options)	1.00	0.87	0.00	0.63	0.83
Operation and maintenance (O&M) costs per year (all technical options)	1.00	0.98	0.91	0.00	0.03

terms of values of the different indicators. To allow the comparison of heterogeneous criteria among the different alternatives a further step was carried out: the normalisation of indicator values, in order to convert them onto the same scale, comprised between 0 (worst possible value) and 1 (best possible value).

## RESULTS

The results of the analysis are shown through the “evaluation matrix” (table 2) expressing the performance of each alternative, in relation to each criterion. Looking at the table one can immediately notice that the best alternatives to reduce the amount of water needed are 3, 4 and 5, but alternative 3 is also by far the most expensive in terms of investment, while alternatives 4 and 5 require high operation and maintenance costs.

The results given in table 2 are not sufficient, though, to compare the whole alternatives and take a decision: in fact, not all the criteria have the same importance for the decision maker. To translate this into the decision process we need to assign a weight to each criterion according to its importance.

Within the Jougar case study analysis, it was decided to simulate this last step by adopting two different approaches: the first is the classical approach giving more importance to the economic aspects; the second is the approach, promoted by Zer0-M, giving special importance to the volume of water extracted from the source (i.e.: taking into account the need to protect a scarce resource for the future, even though the recognised economic value of it does not yet reflect this need).

These two approaches are reflected by different weights given to each criterion (table 3).

▲ *Table 3:*  
**WEIGHTS GIVEN TO EACH CRITERION ACCORDING TO THE TWO DIFFERENT APPROACHES: ONE FAVOURING THE MINIMISATION OF COSTS, THE OTHER THE “SUSTAINABILITY”, I. E. THE MINIMISATION OF THE USE OF RESOURCES**

	Minimum use of resources approach	Minimum cost approach
Total water flow extracted per person	10	6
Flow of water available for irrigation	2	6
Degree of nutrients reuse (N, P)	4	4
Energy employed (per person)	4	4
Quality-pressure on sinks	4	5
Landscape quality (worsened or improved by the project)	4	5
Local mastering of technologies adopted	0	7
Socio-cultural acceptability of solution adopted	0	8
Nuisance (mosquitoes, smell)	6	4
Present (discounted) value of total costs	6	9
Investment costs (all technical options)	6	9
Operation and maintenance (O&M) costs per year	7	10

	ALT1: mixed sewer	ALT 2: separated sewer	ALT 3: ZerO-M (SBR)	ALT 4: ZerO-M (trickling)	ALT 5: separated plus reuse
Min. use of resources approach	0.70	0.64	0.63	0.66	0.72
Minimum cost approach	0.79	0.77	0.48	0.51	0.71

▲ Table 4:  
**RESULTS OF THE MULTICRITERIA ANALYSIS ACCORDING TO THE TWO APPROACHES**

After the weighting of each criterion according to the two different approaches, and aggregating single values into a whole performance index, two new evaluation matrixes were produced: the resulting final scores are shown in **table 4**.

According to the minimum use of resources approach alt 5 shows the best performance, with the highest value of the performance index, and alt 1 has the second highest index, which is very close to the alt 5's one. According to the "classical" approach, the "conventional" alternatives (alt 1 and alt 2) have the best performance, being alt 1 (mixed sewer) the best one, followed by alt 2 (separate sewers). The three alternatives with "innovative" aspects have the lowest index; alt 5 is the highest with an index closer to alt 1 and 2 than to alt 3 and 4.

## SENSITIVITY ANALYSIS

The sensitivity analysis is a kind of "final check" of the whole process, in order to judge how "robust" the choice is which results from the analysis. It is required to understand whether a slight change in the weights given could change the final ranking and lead to the selection of a different alternative.

## MINIMUM USE OF RESOURCES APPROACH

As shown in **table 4**, alt 5 has the best ranking with the highest index and alt 1 has the second highest index, which is very close to the alt 5's one. In this section we determine which criteria and which corresponding weight could change the ranking between alt 5 and alt 1, so that alt 1 would be the best one (**table 5**).

Only five criteria could influence the ranking changing the weight given: total water flow extracted per person, energy employed (per person), present (discounted) value of total costs, investment costs (all technical options), operation and maintenance (O&M) costs per year. A decrease of 12% in the weight of the first criterion, or a 14% increase in the weight of the last criterion are enough to determine a change in the final ranking, by which alt 1 becomes the best. For the other three alternatives a variation of more than 50% is needed to induce the same shift in the ranking. The other criteria have no influence whatever the weight given.

	Weights	Changes for alt 1 to be the best	% of change required
Total water flow extracted per person	0.189	0.166	12%
Flow of water available for irrigation	0.038	-	
Degree of nutrients reuse (N, P)	0.075	-	
Energy employed (per person)	0.075	0.033	50%
Quality-pressure on sinks	0.075	-	
Landscape quality (worsened or improved by the project)	0.075	-	
Local mastering of technologies adopted	0.000	-	
Socio-cultural acceptability of solution adopted	0.000	-	
Nuisance (mosquitoes, smell)	0.113	-	
Present (discounted) value of total costs	0.113	0.256	56%
Investment costs (all technical options)	0.113	0.256	56%
Operation and maintenance (O&M) costs per year	0.132	0.151	14%

▲ Table 5:  
**RESULTS OF SENSITIVITY ANALYSIS (MINIMUM USE OF RESOURCES APPROACH)**

## MINIMUM COST APPROACH

As shown in **table 6**, the "classical" alternatives have the highest performance values, being alt 1 (mixed sewer) the best one, followed by alt 2 (separated sewers). The three alternatives with "innovative" aspects have the lowest performance; alt 5 is the highest ranked, with an index value closer to alt 1 and 2 than to alt 3 and 4. In this section we are going to see which criteria could influence the ranking, shifting alt 5 from the third position to the first, and which weight should be given to doing so.

Only three criteria could change the ranking: total water flow extracted per person, energy employed (per person), and operation and maintenance (O&M) costs per year. To determine this change, the following variations are needed: 62% decrease in the weight of the last criterion, 122% increase in the weight of the first one, or 304% increase in the weight of the second one. The remaining criteria have no influence whatever the weight given.

▼ Table 6:  
**RESULTS OF SENSITIVITY ANALYSIS (CLASSICAL APPROACH)**

	Weights	Changes for alt 5 to be the best	% of change required
Total water flow extracted per person	0.078	0.173	122%
Flow of water available for irrigation	0.078	-	
Degree of Nutrients reuse (N, P)	0.052	-	
Energy employed (per person)	0.052	0.210	304%
Quality-pressure on sinks	0.065	-	
Landscape quality (worsened or improved by the project)	0.065	-	
Local mastering of technologies adopted	0.091	-	
Socio-cultural acceptability of solution adopted	0.104	-	
Nuisance (mosquitoes, smell)	0.052	-	
Present (discounted) value of total costs	0.117	-	
Investment costs (all technical options)	0.117	-	
Operation and maintenance (O&M) costs per year	0.130	0.050	62%

## RESULTS OF THE STUDY

Looking into the results of the case study analysis, we can underline a few aspects. First of all, we have to consider that even the most “conventional” alternative analysed (alt 1) has an important environmental feature, the reuse of treated water for agriculture, that presently appears to be the most important aspect that cannot be renounced. Given that there will be a productive use of wastewater, in the absence of particular reasons to reduce the amount of water available—e.g. the evidence that the groundwater layer is decreasing—it is reasonable that cost-effectiveness guides the choice of

the best solution. And this solution appears to be the classical centralized option. This is due mainly to the high costs of single household decentralized solutions, which suffer from a lack of large scale cost reductions.

However, even when using the conventional ranking approach (costs as most important choice criteria), the simple decentralized greywater treatment and reuse solutions (alt 5) are not very far from showing the best performance: this means that a slight improvement in the cost effectiveness of such technologies could in the near future significantly raise the interest in their application.

## ANNOUNCEMENT



### International Conference **Water Efficiency in Urban Areas** Concepts, Technologies, Socio Economics

Würzburg, Germany  
Thursday, January 29<sup>th</sup>, 2009  
Friday, January 30<sup>th</sup>, 2009



[www.otti.de](http://www.otti.de)

**T**he 1<sup>st</sup> International Conference Water Efficiency in Urban Areas in Würzburg, Germany, January 29<sup>th</sup>/30<sup>th</sup>, 2009 is a non mainstream international conference aiming at the global challenges regarding sustainable drinking water supply and wastewater management in urban areas. To cope with the challenges, fresh thinking and an integrated approach is required to cover a wide portfolio of measures to improve water efficiency ranging from urban planning, to architecture, to water resources management and water treatment technologies. An exhibition will round off the conference.

### THE TOPICS OF THE CONFERENCE ARE:

1. Climate Change - Boundary Conditions
2. Planning/Strategy
3. Technical Options
4. Economics/Finance
5. Implementation of Strategies

### CONFERENCE FOCUS:

- On the interface between energy and water
- Water Reuse - Which quality of water for what?
- Increase of water efficiency
- Water management
- Water purification
- Urban planning
- Integrated systems for large buildings or residential areas
- Know-how Transfer

### YOU WILL MEET:

Planners housing industry, urban planners, architects, utilities, waste water administration unions, engineers and scientists active in the field of water efficiency, politicians, building technicians, consultants, other attendees.

The two-day programme for this conference will comprise of invited oral presentations and posters.

Posters are invited on the above topics. Each poster presenter will get 3 minutes to present the highlights of his project the plenum. Deadline for Submissions of Abstracts: June 13<sup>th</sup>, 2008

### THE CALL FOR POSTERS AND FURTHER INFORMATION ARE AVAILABLE AT:

<http://www.otti.de/pdf/wea3091.pdf>





◀ Figure 1

## WATER MANAGEMENT AND MEMBRANE TECHNOLOGIES

In practise the sustainable water management concept is based on collecting and treating the different wastewater flows. Separation is done to optimise the potential for reuse. **Otterpohl et al., 1997, 1999** reported four different qualities of wastewater at household level such as black water, grey water, rainwater and non-biodegradable solid waste.

Greywater is defined as household wastewater coming from bathtubs, showers, hand washing basins and washing machines. Wastewater coming from the kitchen is also included as a greywater resource in some of the cases (**Nolde E., 1999**). If we measure the water use in a house, it is clearly seen that water use in bathtubs, showers, washing machines and hand washing basins composes most of the water consumption in a house. In other words grey water is the largest stream in the amount of total household wastewater by about 65 - 70% (**Henze M., 1997**). Compared with domestic wastewater, lower organic matters and fewer pathogens are found in greywater. If properly managed,

# USE OF MEMBRANE BIOREACTOR TECHNOLOGY WITHIN THE SUSTAINABLE WATER MANAGEMENT CONCEPT

By SELDA MURAT, ELIF ATASOY and AHMET BABAN\*

\* Selda Murat, Elif Atasoy and Ahmet Baban  
TUBITAK-Marmara Research Center, Chemistry and Environment Institute, Gebze, Kocaeli, 41470 TURKEY,  
[Selda.Murat@mam.gov.tr](mailto:Selda.Murat@mam.gov.tr)

## RÉSUMÉ

### UTILISATION DES BIOREACTEURS A MEMBRANE DANS LE CONCEPT DE GESTION DURABLE DES EAUX

D'après la récente approche décentralisée, la gestion durable des eaux est considérée comme étant la solution aux problèmes liés à l'eau. Dans ce contexte, la division des eaux domestiques en eaux grises, noires et jaunes joue un rôle majeur. Les bioréacteurs à membrane, qui présentent plusieurs avantages par rapport aux méthodes de traitement conventionnelles dites à boues activées ou autres procédés biologiques, sont de plus en plus utilisés en raison de leur caractère compact ainsi que de leur haut degré d'efficacité. Les bioréacteurs à membrane servent également au traitement avancé des eaux grises et noires à des fins de réutilisation notamment. Plusieurs enquêtes sont en cours en vue d'améliorer cette technologie et de l'adapter aux différentes situations. Ce document traite d'un bioréacteur à membrane installé et fonctionnant à long terme pour le traitement et la réutilisation des eaux grises à TUBITAK MRC. Les eaux grises faisant l'objet de cette étude ont été produites par des habitations. Les résultats ont révélé que 96% de DCO, 92% de nitrogène total, 99% de particules totales en suspension et 100% de bactéries coliformes totales et bactéries coliformes fécales étaient atteignables. Les eaux traitées peuvent être réutilisées à diverses fins. Dans le cas présent, elles ont été réutilisées pour l'irrigation de terrains. Le travail expérimental a été réalisé dans le cadre du projet Zer0-M.

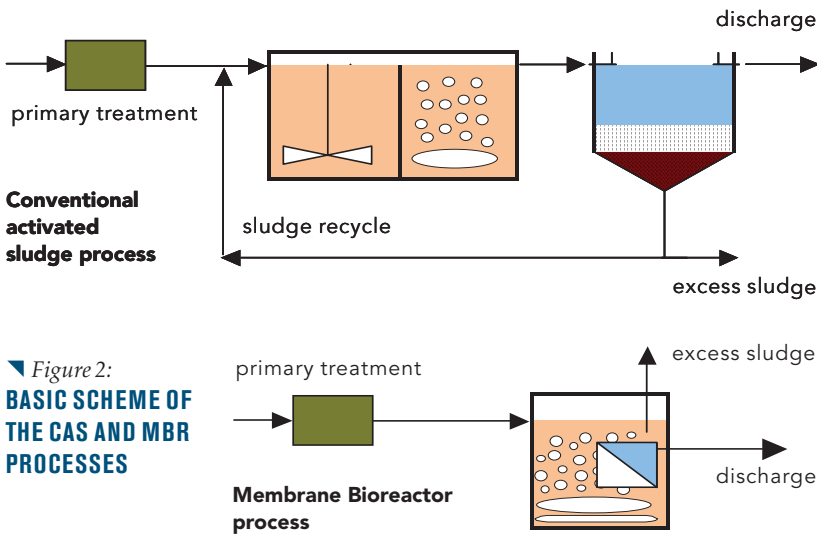

Figure 2:  
**BASIC SCHEME OF THE CAS AND MBR PROCESSES**

greywater can be reused for various purposes such as irrigation, flushing toilets etc. and has the advantage of being less polluted.

Freshwater demand increases as the population increases. Furthermore pollution and the ineffective use of water resources increase the stress on water resources. Moreover, water resources are not scattered equally and the water scarcity is an urgent problem in some parts of the world. Most countries in the Near East and North Africa suffer from acute water scarcity, as do the countries of Mexico, Pakistan, South Africa, and large parts of China and India. It is also emphasized that irrigation is usually first affected by water shortage and as a result food production per capita will be decreased in these countries (UN, report, 2006). It is necessary to develop new concepts and technologies to solve the water scarcity problems of today and tomorrow in accordance with the sustainable development and millennium development goals.

Treated wastewater reuse can contribute to large savings in water from water resources. It can be considered as an important water source especially in urban and suburban areas. A drinking water quality is not required for all kind of uses and drinking water should not be used for toilet flushing for the effective use of water (Otterpohl R., 2003)

Recently Membrane Bioreactors (MBR) have been gaining in popularity for greywater treatment because of their compactness and superior water reuse potential due to the complete disinfection achieved by the mi-

cro- or ultra-filtration membranes (Lesjean and Gnriss, R., 2006, Rosenberger S., et al.,2002, Melin, T.,2006).

Activated sludge processes are commonly used for the removal of the organics and nutrients from wastewaters. Conventional activated sludge processes (CAS) consist of a biological reactor where biological reactions occur and a sedimentation tank where the activated sludge is separated from the treated water phase. Hence, the satisfactory treatment cannot be accomplished without the effective separation of activated sludge from the water phase. A Membrane Bioreactor (MBR) is the combination of the activated sludge and membrane processes. A membrane in MBRs provides the separation of activated sludge from the treated water phase. The biomass retains in the reactor and sludge recycle is not needed in MBRs. Some of the advantages of membrane bioreactors are a good effluent quality with high hygienic standards, the biomass concentration is as high as possible, a reduced reactor volume, smaller footprint and reduced net sludge production (Jefferson, B., 2001 Melin, T.,2006). However, an MBR requires a high aeration rate to prevent clogging of the membrane pores and the energy requirements of MBRs are higher than at CAS.

The basic scheme of the conventional activated sludge process and the membrane bioreactor process is given in figure 2. As seen in the figure, the MBR configuration is simple compared with the CAS.

## MBR OPERATIONS IN TUBITAK-MRC

Pilot scale submerged membrane bioreactor units were installed in the Training and Demonstration center (TDC) and operated to treat greywater generated from the lodging houses of the TUBITAK MRC Campus. The training and Demonstration Center is designed and operated within the context of the European Union funded Zer0-M project (Baban A. et al., 2005, Regelsberger M. et al., 2007). The center consisted of various applications of decentralized wastewater treatment and reuse alternatives. Among these, greywater treatment with different technologies, such as CW, SBR, RBC and MBR is being investigated. The results of grey water treatment by a pilot scale MBR for the reuse purpose is discussed in this article.

Raw greywater used in the study was collected from lodging houses of TUBITAK MRC Campus. Two lodging house buildings, comprising 28 apartments, were connected to a holding tank. The holding tank serves as a storage tank and coarse matter separator for pretreatment with 6 and 3 mm screens. The water originates from the 17 people permanently living here and the people temporary living in 11 guest apartments.

The study was carried out operating a pilot scale submerged MBR installed on the site. The effective volume of the reactor is around 600 L. KUBOTA's plate and frame membrane module, having 0.4 micron pore size was used. The properties of the membrane are given in table 1 below. The module is placed in the biological re-

Properties	
Membrane material	PEC (Polyelectrolyte Composite)
Nominal pore size	0.4 $\mu\text{m}$
Membrane area, $\text{m}^2$	5
Number of membranes	12
Resistance - pH range	1.5 to 10
Resistance - $\text{H}_2\text{O}_2$ (NaOCl)	3000 - 5000 $\text{mgL}^{-1}$ (normal: 500 $\text{mgL}^{-1}$ )
Resistance - temperature	< 50°C
Resistance - pressure	98 mbar - 294 mbar (normal: 98 mbar)

Table 1:  
**PROPERTIES OF THE MEMBRANE MODULE**



▲ Figure 3: MEMBRANE MODULE

actor; the membrane accomplishes treated water and biomass separation.

Membrane module is shown in the picture given below (figure 3).

The MBR is controlled with a PLC. An air blower supplies air to the MBR. Coarse and fine bubble membrane diffusers are used to provide air for the biological reactions and membrane air scour. Coarse bubble air is used for the membrane scour and it provides cross flow filtration on the membrane. figure 4 shows the fine and coarse bubble aerations.

The MBR was operated in batches, which means filling; reaction and discharge phases were applied sequentially. Four cycles were set for the MBR operation. A high energy consumption is one of the drawbacks of the MBRs. Batch aeration was applied as 50 minutes air break and 10 minutes aeration when the level is low in the reactor to reduce the energy consumption.

Usually a pump is not necessary for the separation of permeate for the plate and frame membrane type modules. The necessary transmembrane pressure (TMP) difference is applied by the water head above the membrane. The average TMP was about 120 mbar.

Greywater samples were taken under mixing conditions from the holding tank after the screen. All of the analyses for a conventional characterization were performed as defined in Standard Methods (APHA, AWWA, WPCP, 2005).

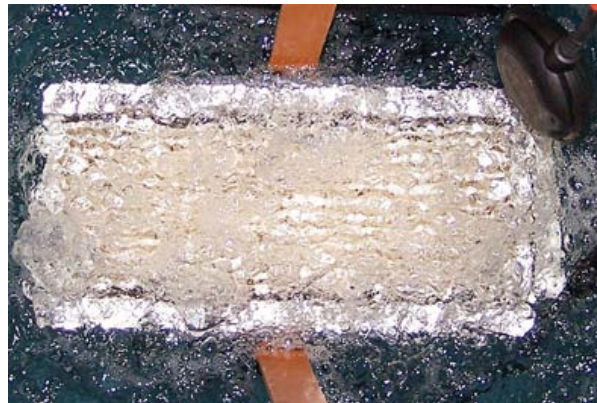

◀ Figure 4a: FINE AND ...  
▲ Figure 4b: ... COARSE BUBBLE AERATIONS

## RESULTS AND DISCUSSION

The greywater fed to the MBR showed the typical greywater characteristics with an average COD of 270 mgL<sup>-1</sup>. Total and fecal coliform was measured as around 14,000 and 4,000 per 100 mL respectively. The average conductivity was 525 μscm<sup>-1</sup>. The results of the characterization study of greywater are shown in figure 5 as average concentrations of the conventional pollutants. The BOD<sub>5</sub>/COD ratio of the greywater was around 0.41, which is slightly lower than the ratio of 0.44 given in the literature for domestic wastewater (Metcalf and Eddy, 2003). The difference can be explained with the higher concentration of soaps and detergents in greywater, which are known as slowly biodegradable. The total phosphorus concentration of the greywater was also high compared to the literature values indicat-

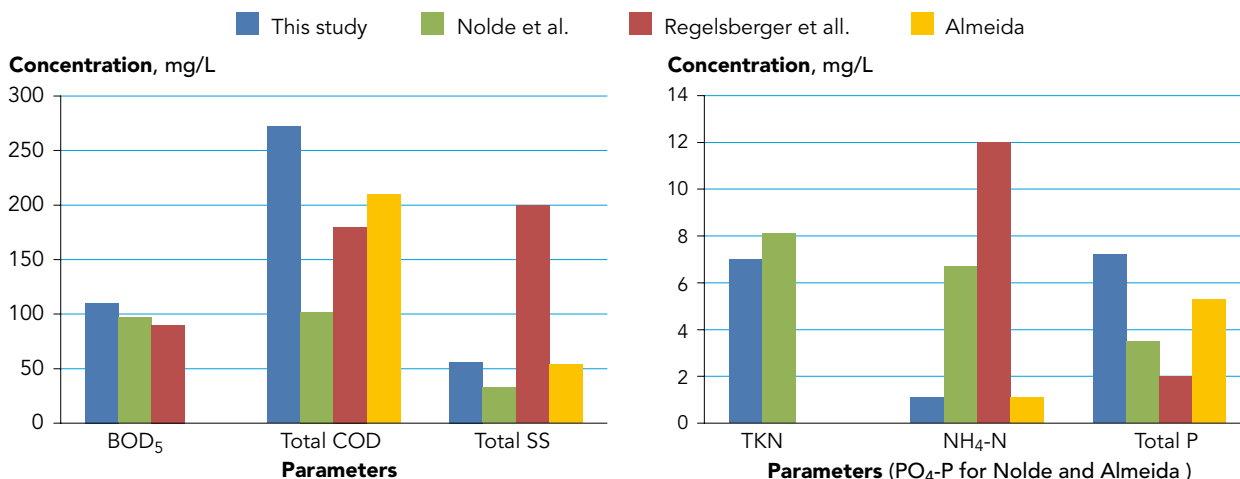

◀ Figure 5: POLLUTANT CONCENTRATIONS IN RAW GREY-WATER

► **Figure 6:**  
**RAW GREYWATER**  
**AND EFFLUENT OF**  
**THE MBR**



ing that phosphorus rich detergents and soaps were used in the apartments (Henze M., 1997).

One of the drawbacks of the MBRs is the decrease in flux, which is an indicator of the clogging. During the first 50 days of operation, the average permeability was around  $280 \text{ Lm}^{-2}\text{h}^{-1}\text{bar}^{-1}$  and dropped to  $125 \text{ Lm}^{-2}\text{h}^{-1}\text{bar}^{-1}$  in the following 140 days.

The MBR was operated at various temperatures from 8 to 28°C. However there was not a significant difference in the effluent quality of the reactor and a satisfactory performance was attained under various temperatures.

## EVALUATION OF EFFLUENT QUALITY IN TERMS OF REUSE

BOD<sub>5</sub> was almost completely removed in the reactor; the average BOD<sub>5</sub> concentration in the effluent was less than  $5 \text{ mgL}^{-1}$ . Average total COD concentration in the treated effluent was about  $11 \text{ mgL}^{-1}$ , corresponding to an overall COD removal efficiency of 95%. TSS was almost completely removed; The TSS concentration in the treated effluent was less than  $2 \text{ mgL}^{-1}$ . The hygienic performance of the reactor was good, no total coliform and fecal coliform was detected in the effluent. The influent and effluent appearance is shown in figure 6.

▼ **Table 2:**  
**EFFLUENT**  
**QUALITY OF THE**  
**GREYWATER**  
**TREATMENT BY**  
**MBR IN TERMS**  
**OF REUSE**

Parameters	Effluent	EPA Suggested Guidelines for water reuse, 2004			Turkey <sup>1</sup>
		Urban Reuse	Agricultural reuse*	Agricultural reuse**	Irrigation
BOD <sub>5</sub> , mgL <sup>-1</sup>	< 5	≤ 10	≤ 10	≤ 30	≤ 100
Total COD, mgL <sup>-1</sup>	11	NA	NA	NA	NA
TSS, mgL <sup>-1</sup>	< 2	≤ 5	≤ 5	≤ 30	≤ 45
Turbidity, NTU	0.3	NA	NA	NA	NA
Tot. Coliform./100 mL	0	NA	NA	NA	NA
Fecal Coliform./100 mL	0	ND	ND	< 200	≤ 100

<sup>1</sup> Water Pollution Control Regulation (WPCR)

NA: not available, ND: not detectable

The effluent quality of the greywater treatment by MBR in terms of reuse is presented in table 2.

The result of this experimental study showed that the effluent quality of treated greywater by the MBR complied with the reuse criteria for different purposes.

## CONCLUSION

The submerged membrane bioreactor was verified to be appropriate for greywater treatment at a variable temperature with the purpose of reuse in the content of a sustainable water management approach. Average removal efficiencies of greywater treatment by MBR were 96% for COD, 92% for Total Nitrogen and higher than 99% for TSS. The effluent was free of total and fecal coliform. The results showed that the MBR technology can be an alternative to the greywater treatment and treated water can be reused for different purposes.

## ACKNOWLEDGEMENTS

This study was conducted as a part of Zer0-M project financed by the European MEDA WATER program (ME8/AIDCO/2001/0515/59768). The authors would like to thank all the partners of the project.

## REFERENCES

- Nolde, E., (1999). Greywater reuse systems for toilet flushing in multi-storey buildings-over ten years experience in Berlin, Urban Water, Vol.1, pp. 275-284.
- Henze M., (1997). Waste design for households with respect to water, organics and nutrients, Water Science and technology, Vol. 35, No.9, pp. 113-120.
- Australian Guidelines for water recycling (2006), National Guidelines for Water Recycling: Managing Health and Environmental Risks.
- Nolde, E., (2005). Greywater recycling systems in Germany-results, experiences and guidelines, Water Science and technology, Vol. 51, No.10, pp. 203-210.
- Lamine M., Bouseselmi L., Ghrabi A., (2007), Biological treatment of grey water using sequencing batch reactor, Desalination, Vol.215, pp. 127-132.
- Lesjean, B., Gnriss, R., (2006), Greywater treatment with a membrane bioreactor operated at low SRT and low HRT, Desalination, Vol.199, pp. 432-434.
- Rosenberger, S., Kruger, U., Witzig, R., Manz, W., Szewzyk, U. and Kraume, M. (2002). Performance of a bioreactor with submerged membranes for aerobic treatment of municipal wastewater. Wat.Res., Vol 36, pp. 413-420.
- Melin, T., Jefferson, B., Bixio, D., Thoeye, C., De Wilde, W., De Koning, J., van der Graaf, J., and Wintgens, T., (2006). Membrane bioreactor technology for wastewater treatment and reuse, Desalination, Vol 187, pp. 271-282.
- Jefferson, B., Laine A.L., Stehenson T., and Judd S.J., (2001). Advanced biological unit processes for domestic water recycling, Wat. Sci.&Tech., Vol.43, No.10, pp. 211-218.



▲ Figure 7: **MEMBRANE BIOREACTOR**

- Baban, A., Gunes, K., Ayaz, S., Murat, S., Atasoy, E., Dogan, O., and Dikec, S., (2005). Sustainable water management practices in the Training and Demonstration Center of TUBITAK-MRC, 1<sup>st</sup> Zer0-M Conference on Sustainable Water Management, Turkey.
- Regelsberger M., Baban A., Bouselmi L., Shafy H. A., Hamouri B. E., (2007) Zer0-M, Sustainable concepts towards a zero outflow municipality, *Desalination*, Vol 215, pp. 64-72.
- APHA, AWWA, WPCP (2005), *Standard Methods for the Examination of Water and Wastewater*, (Edited by Clesceri, L.S., Greenberg A.E., Eaton, A.D.), 21<sup>th</sup> edn. APHA, Washington, D.C.
- Metcalf&Eddy (2003), *Wastewater Engineering Treatment and Reuse*, Mc Graw Hill
- Almeida M.C., Butler D., Friedler E., (1999), At-source domestic wastewater quality, *Urban Water*, Vol.1, pp. 49-55.
- EPA, *Guidelines for Water Reuse* (2004), U.S. Environmental Protection Agency / U.S Agency for International Development, Washington D.C, USEPA/625/R-04/108
- WPCR, *Water Pollution Control Regulation of Turkey* (Technical Procedure Notification), 1991.
- WHO (2006), *Guidelines for safe use of wastewater, excreta and greywater*, Vol.4.

## ANNOUNCEMENT

### BBC VIDEO: WASTE NOT WASTE



On 25 - 30 January 2008 the Report Waste not Waste was airing on the TV-Channel BBC WORLD. This video has been produced in the framework of the Zer0-M-Project <http://zer0-m.org>

### CONTENT OF THE VIDEO:

Every flush of the toilet sends till 11 litres of precious drinking water down the drain. Dry toilets seem to provide the perfect answer—especially in arid North Africa. EARTH REPORT visits Morocco and Tunisia where water is scarce, and human waste management a top priority.

**THE VIDEO CAN BE ORDERED AT THE FOLLOWING LINK:**  
<http://www.tve.org/mp7/details.cfm?l=e&fid=3146>



# LET'S TALK ABOUT THE SANITATION SCANDAL!

## PRESS STATEMENT

World Water Day 2008 / 20 March 2008

**“The International Year of Sanitation as well as the World Water Day are a unique opportunity to openly discuss a silent scandal that costs the lives of thousands and that affects the lives of billions every single day in a way, people in the industrialised countries cannot even imagine. If as many people were killed in wars or accidents everybody would be outraged. Politicians would not dare to ignore the causes of this violation of the public peace.”, Dayanand Panse from the Indian Water Works Association one of the SuSanA partners summarises: “We have to use this opportunity, talk about sustainable sanitation and its benefits for society and environment and finally make a change.”**

**S**ince 2008 is the International Year of Sanitation, this year's World Water Day is dedicated to sanitation. But why should we focus on human excreta and wastewater when billions of people are still without access to safe drinking water? Isn't sanitation the problem of lower priority?

It is not, according to Christine Werner, head of the German development programme on ecological sanitation and one of the coordinators of SuSanA. “Sanitation is in fact one of the major issues of our time, and its importance cannot be overstated,” she says. “It was not without reason that sanitation was elected the most important medical milestone in a survey of the British Medical Journal in 2007. Protection against health hazards is invariably the best way to improve population health.”

Still 90% of sewage and 70% of industrial waste in developing countries are currently being discharged into watercourses untreated — often polluting the available water supply. Water-related diseases kill more than 2 million people every year, which is more than ten times the number killed in wars. They take a child's life every fifteen seconds. Today around 2.6 billion people do not have access to a decent, safe and environment-friendly sanitation system.

Arno Rosemarin from the Stockholm Environment Institute, which is also a partner of SuSanA: “Sustainable sanitation not only protects human health but also the environment and natural resources. And, appropriately managed, sanitation systems can also contribute to food security and increased income, for example if the nutrients in human excreta are used as fertilisers after adequate treatment. Many appropriate low-cost solutions are at hand.”

Poverty reduction, health, protected ecosystems, clean drinking water, biogas, more food — all of these could be gained by sustainable sanitation. However, sanitation rarely receives the required attention and is given low priority by politicians and civil society alike.

For improving the global sanitation situation, it is not enough to provide more toilets only, but also to ensure the safe collection, treatment and reuse or disposal of human excreta and wastewater. The SuSanA partners therefore stress that certain basic principles should always be met, when sanitation systems are planned and implemented. The “Bellagio Principles” for example call for a planning and implementing approach that puts human dignity, the quality of life and environmental security in the centre, and which stands in line with good governance principles. Waste should be considered a resource, and its management should be holistic and be part of an integrated water resources management scheme. Finally, the domain in which environmental sanitation problems are resolved should be kept to a minimum practicable size (household, neighbourhood, community, town, city) and decision-making should involve participation of all stakeholders, especially the consumers and service providers.

### FOR MORE INFORMATION, VISIT THE FOLLOWING WEBSITES:

[www.sustainable-sanitation-alliance.org](http://www.sustainable-sanitation-alliance.org)

[www.sanitation2008.org](http://www.sanitation2008.org)

## SUSANA

The overall goal of the SUSTAINABLE SANITATION ALLIANCE (SuSanA) is to contribute to the achievement of the Millennium Development Goals by promoting sanitation systems which are taking into consideration all aspects of sustainability. The MDGs and the UN's “International Year of Sanitation 2008” are focal points of the SuSanA as they provide a broad base to put sanitation higher up on the political agenda.

The main focus of the work of the “Sustainable Sanitation Alliance” is it to promote the implementation of sustainable sanitation systems in large-scale water and sanitation programmes.

SuSanA is an informal network of organisations working along towards a common goal. Participation is open to those who want to join and be active in the promotion of sustainable sanitation systems.

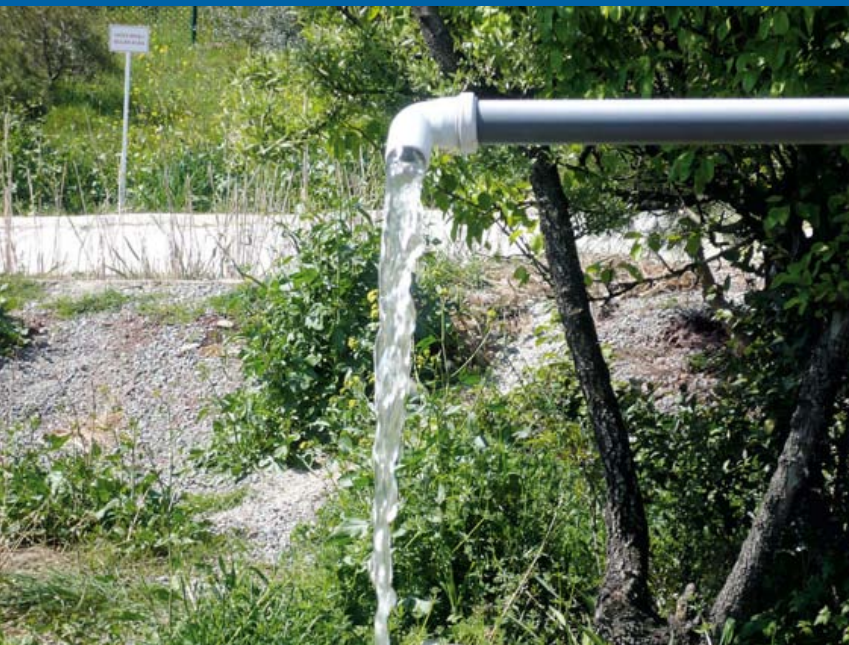

# AN OVERVIEW FOR THE TECHNICAL AND DEMONSTRATION CENTRES OF THE ZERO-M PROJECT

By AHMET BABAN, LATIFA BOUSELMI, BOUCHAIB EL HAMOURI and HUSSEIN ABDEL SHAFY\*

Water scarcity plays a vital role with regard to our socio-economic life and in all cases for the development trend of the countries. Several innovative approaches have been tried or proposed to solve the water-related problems. Along these lines, Sustainable Water Management (SWM) practices were investigated, implemented and operated to a large extent within the context of the Zer0-M Project.

\* **Ahmet Baban** is researcher at the TUBITAK Marmara Research Center, Chemistry and Environment Institute, 41470 Gebze, Kocaeli, Turkey, [ahmet.baban@mam.gov.tr](mailto:ahmet.baban@mam.gov.tr)  
**Latifa Bouselmi**, CERTE, Tunisia, [latifa.bousselmi@certe.mnrt.tn](mailto:latifa.bousselmi@certe.mnrt.tn)  
**Bouchaïb El Hamouri**, Institut Agronomique et Vétérinaire Hassan II (IAV), Département du Génie Rural, Rabat, Morocco, [b.elhamouri@iav.ac.ma](mailto:b.elhamouri@iav.ac.ma)  
**Hussein Abdel Shafy**, Water Research & Poll. Control Departm., National Research Centre NRC, El-Behouth st., Dokki, Cairo, Egypt, [hshafywater@yahoo.com](mailto:hshafywater@yahoo.com)

◀ *Figure 1:*  
**TREATED GREY WATER USED FOR IRRIGATION**  
**(TUBITAK MRC EXPERIMENTS)**

The basic idea was the development of an integrated approach for Mediterranean SWM practices through the operation of several technical options (TOs) in Technical and Demonstration Centers (TDC) in four different Mediterranean countries: Egypt; Morocco; Tunisia and Turkey. The overall goal was to attain a conceptual assessment of several TOs, their modifications to adopt local conditions to improve efficiencies and to make innovative developments. Furthermore, the other achievements throughout the study may be summarized as

- enhancing collaboration,
- sharing the implementation results,
- working on common problems with regard to setting up the systems and the problems encountered in the operation phases,
- assessment of regional distinctions on the basis of several parameters such as the water usage, wastewater flows and characterizations for segregated streams,
- a discussion of possible solutions,

## RÉSUMÉ

Les outils d'une gestion durable de l'eau (SWM) ont été largement étudiés et mis en application dans le contexte du projet Zer0-M. L'idée fondamentale est le développement de l'approche intégrée pour une application à l'échelle méditerranéenne de SWM par la mise en place de plusieurs options techniques (TOS) aux centres techniques et de démonstration (TDC). Le principe du TDC est basé sur la ségrégation des eaux usées en grises, noires et parfois jaunes et de les considérer comme une source d'eau et non un déchet. La collecte des eaux de pluie en vue de recyclage est aussi envisagée. Parmi les TOs mis en place, le réacteur anaérobique à deux étapes (TSUARs), une combinaison de différentes zones humides (CWs), réacteurs biologiques membranaires (MBRs) et réacteur biologique séquentiel (SBR). Le choix de la technologie est fonction de la qualité de l'eau et de l'objectif de réutilisation.

Les options de réutilisation mis en place sont plusieurs tel que l'utilisation des eaux grises traitées pour alimenter les chasses d'eau, les machines à laver le linge et/ou l'irrigation d'espace vert. Les eaux noires traitées, riches en nutriments, sont utilisées principalement pour ce dernier objectif. Les eaux jaunes contiennent des fertilisants solubles. Les eaux de pluie peuvent être recyclées dans les chasses d'eau ou servent à alimenter une douche

L'expérience obtenue à partir des TDCs a indiqué que le concept de SWM peut être appliqué avec succès par l'utilisation de plusieurs TOs. En plus, l'approche appliquée aux TDCs développe une gestion responsable de ressources rares. Un cycle de formation basé sur les TDCs est en cours pour un effet multiplicateur.

- further modifications on a conceptual or technological basis through the long-term simultaneous experimental study of the approach in various regional locations and cultures.

## TDC DESCRIPTION AND OVERVIEW OF OPERATIONAL EXPERIENCES

The application of the concept to local water management on a wide scale requires the adaptation and the development of powerful technologies of water treatment. The principle of the TDC operations was based on the segregation of grey water, black water, sometimes yellow water and their reuse respectively. Hence, wastewater is considered a useful product after being treated satisfactorily.

The collection and reuse of rain water was also utilized as an alternative innovative resource for TDC design. The rain water could also be utilized for toilet flushing purposes. A reduction in water consumption was achieved using several water saving devices. In addition to that, various types of toilets, including composting toilets, urine separation toilets and waterless urinals were employed. The reuse options for the treated wastewaters were flushing the toilets with treated water, the irrigation of green zones and the reuse of nutrients from nutrient-rich urine or using wastewater treatment sludge as compost. Anaerobic treatment processes were used for mainly black water treatment and the biogas produced was intended to be exploited for heating purposes. Hence, the applied sustainable measures experimentally set-up and assessed in the TDC's of the four partner countries cover a wide angle, from the low cost, easily applicable technologies to the highly sophisticated advanced treatment or tertiary treatment devices. In this context, a conceptual diagram illustrating some of the TOs for treatment and reuse in general is given in [figure 2](#).

The TDCs were utilized for demonstration and training purposes as well as research activities. The results were continuously exchanged between the partner organizations in a collaborative way. Technical discussions on the results were carried out and in accordance with the discussions modifications were made on the operational parameters, sampling and analysis strategies and test methods. These issues were thought to

help the development of an integrated SWM concept via technical, social and economic means.

## WASTEWATER SEGREGATION

Wastewater generated from the settlement areas or buildings of each TDC was segregated to grey, black and yellow water parts (for some cases). Among the components grey water has received extensive attention due to the high volume discharges, relatively easy treatment methods as well as the high potential for reuse. In the conceptual design of the TOs to be tested these features of grey water generated from the partner countries are to be taken into account. Hence, during the implementation and assessment phase of the project, a great number of the TOs were devoted to the grey water treatment and reuse alternatives. This issue and the results were discussed among the partners extensively. Treated grey water was used for flushing and/or the irrigation of green areas.

## EXPERIMENTED TECHNICAL OPTIONS

Whereas, for the black water treatment and reuse Two Stage Upflow Anaerobic Reactors (TSUARs), various types of constructed wetlands (CWs) and Membrane Bio-reactors (MBRs) were among the TOs tested. The technology employed for the black water generally focused on energy production and recycling the rich organic content of black water and other excess sludge generated from the biological processes. It was intended to obtain valuable products in the form of compost and to achieve biogas with a high methane content out of anaerobic digestion processes for energy recovery to be further utilized in the form of heating or electricity generation purposes. The treated black water is utilized only for landscape irrigation purposes.

A comprehensive characterization was made for the segregated wastewater components. In addition to that, the performance of each TO was monitored. For this purpose, composite samples were taken from influent and effluent streams of TOs on a weekly basis. The monitored parameters were COD, BOD<sub>5</sub>, pH, SS, TN, NH<sub>4</sub><sup>+</sup>, NO<sub>2</sub><sup>-</sup>, NO<sub>3</sub><sup>-</sup>, P, turbidity, color, total and faecal coliform, conductivity and alkalinity. Furthermore, the operational parameters such as the sludge characteristics of the biological treatment systems (mixed liquor suspended solids, MLSS, and mixed liquor volatile suspended solids, MLVSS) were closely monitored.

For some of the cases, yellow water segregation and reuse and nutrient recovery from yellow water was also investigated as a TO. In this field, the separate collection of yellow water by means of waterless urinals. The collected yellow water was stored and kept in containers for further utilization as a valuable soil fertilizer. In this case, a comprehensive characterization for yellow water, as well as the change in characterization as a function of storage time was monitored. Investigations are still being carried out with regard to the use of zeolites and diluting the yellow water to determine the

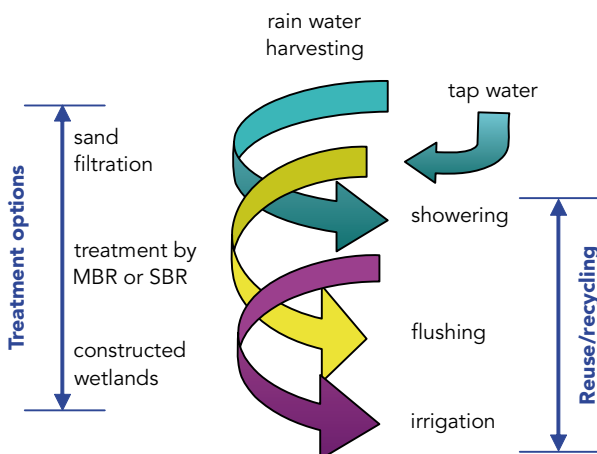

► Figure 2:  
GENERIC  
ILLUSTRATION OF  
THE TDC CONCEPT  
FOR TREATMENT  
AND REUSE



efficient way of applying recycled yellow water as a valuable fertilizer for various plantations.

Rainwater harvesting and reuse studies were also researched in the TDCs. Rainwater was collected from the roofs in the vicinity and stored. Vortex type filters were utilized for the purpose of dirt separation from the rainwater. Characterization studies on a seasonal basis were carried out for the collected rainwater samples. In this case, along with the conventional parameters, the heavy metal content of the rainwater collected was also investigated. Heavy metals were thought to be caused by the air pollution originating in the areas with industrial activities. The microbiological content of the rainwater samples was also measured to help decide various reuse options. In general the collected and reused rainwater was intended to be reused for toilet flushing purposes, for cleaning purposes in washing machines (under investigation) and for the purpose of landscape irrigation during the dry seasons. However, in Tunisia, filtered rainwater is used to feed one shower as an experiment. This reuse possibility is well accepted by the users.

Apart from the treatment and water reuse systems, several toilets were employed to cover the full range of the SWM concept. Some of these toilet systems were utilized also to test flushing with reused water. Furthermore, these toilets served as training materials during the courses organized for the dissemination of the SWM concept. Water consumption rates and segregated wastewater components flows were measured by different techniques. In this context it is worth mentioning the tipping bucket system installed for one of the TDCs for the purpose of the accurate measurement of flow rates for grey and black water discharges as a function of the time of the day. Several water saving equipments were used to assess the efficiency and contribution to the SWM approach. Water consumption was determined both with and without the usage of water saving devices. Furthermore, for the purpose of the detailed monitoring and assessment of the TOs, online automatic monitoring and recording systems, such as flow rate measurement for some individual equipment, Oxidation Reduction Potential Control (ORPC), trans-membrane pressure (TMP), pH and temperature were implemented.

The data obtained was regularly uploaded in the Zer0-M project web-site in the partners' area and a regular discussion was conducted among the scientists using communication facilities, skype meetings, exchanging e-mails and frequently organized specific work package meetings. An economic assessment of the TOs was also made by collecting data during the operational phase of the TDCs. In this manner, it would be possible to compare various TOs utilized for the achievement of the SWM concept under different conditions and operating in four countries.

## OPERATIONAL EXPERIENCES – RESULTS

The shared results, so far implicated that the TOs, depending on the operational conditions and proper mon-

Type of wastewater component/comments	TOs experimented in the TDCs	Reuse
<b>Grey Water</b> Low in nutrient content, normally organic content is low compared to the composite domestic wastewater flow rate is high	<ul style="list-style-type: none"> <li>Series of constructed wetlands (CW) in the form of horizontal flow (HF), and free water surface systems (FWS),</li> <li>Planted gravel-sand filter,</li> <li>Roughing filter,</li> <li>Sequential Batch Reactors (SBR),</li> <li>Membrane Bio-reactors (MBR),</li> <li>Rotating Biological Contactor (RBC)</li> <li>Septic tank</li> <li>UV disinfection</li> </ul>	Toilet flush irrigation
<b>Black Water</b> High in organic matter content, energy recovery is an option	<ul style="list-style-type: none"> <li>MBR</li> <li>Two Stage Upflow Anaerobic Reactor (TSUAR)</li> <li>CWs in the form of HF and VF (vertical flow) combinations</li> <li>Septic tank</li> <li>Sludge drying bed</li> <li>Compost bed</li> </ul>	Irrigation
<b>Yellow Water</b> Rich in nutrients	<ul style="list-style-type: none"> <li>Separate collection, storage (dilution, physico-chemical treatment)</li> </ul>	Nutrients addition
<b>Rain Water</b> Renewable source	<ul style="list-style-type: none"> <li>Rainwater collection systems (roofs)</li> <li>Dirt separation filters</li> <li>Rainwater storage</li> </ul>	Flushing, irrigation, washing machines, showering

itoring, comply with reuse criteria for several purposes. The operations of the TOs are still carried out and the relevant data is collected and relevant assessments are made. The construction and operation experiences for the systems are proving to be promising for Mediterranean conditions so far. Especially, grey water treatment TOs comply with reuse regulations extensively.

Depending on the TOs employed, the pollutant load, operational conditions, as low as 20 - 30 mg/L effluent COD, 2 - 4 NTU turbidity, 2 - 10 mg/L suspended solids, 1 - 2 mg/L  $\text{NH}_4\text{-N}$  and 0 T. coliform/100 mL sample were obtained for the grey water TOs. For the black water, this was as low as 40 - 60 mg/L COD, suspended solids of 2 mg/L and again 0 T. coliform/100 mL sample were obtained. It should be noted that TSUARs used for the pretreatment of black water also proved to be quite efficient and very easy to operate. It should certainly be considered a sustainable and reliable option for black water pretreatment. Some of the operational

▲ Table 1:  
**OVERVIEW OF TOS**

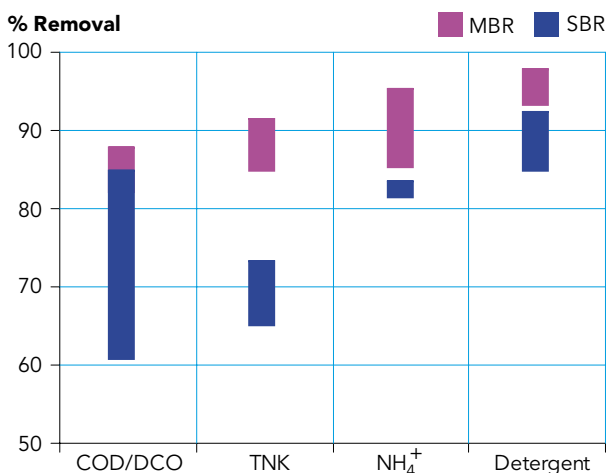

◀ Figure 3:  
**SOME OPERATIONAL RESULTS OBTAINED FOR GREY WATER TOS (CERTÉ-TUNISIA FEB. 2008)**

► **Figure 4:**  
**GRAY WATER TREATMENT RESULTS BY SBR, MBR AND CW (IAV-MORROCO)**

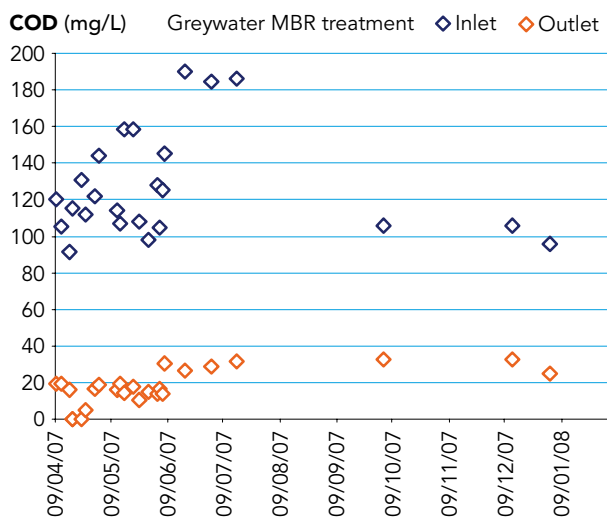
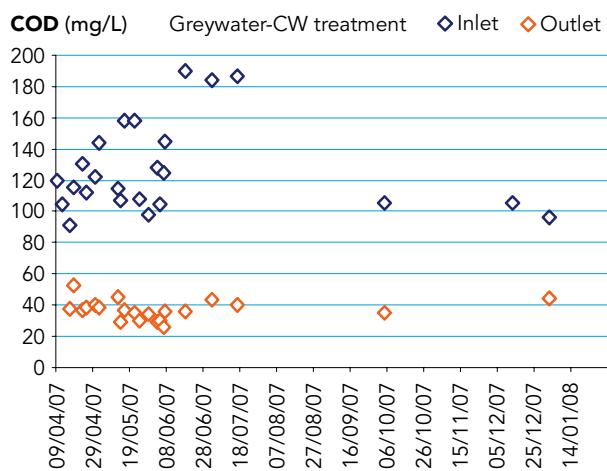
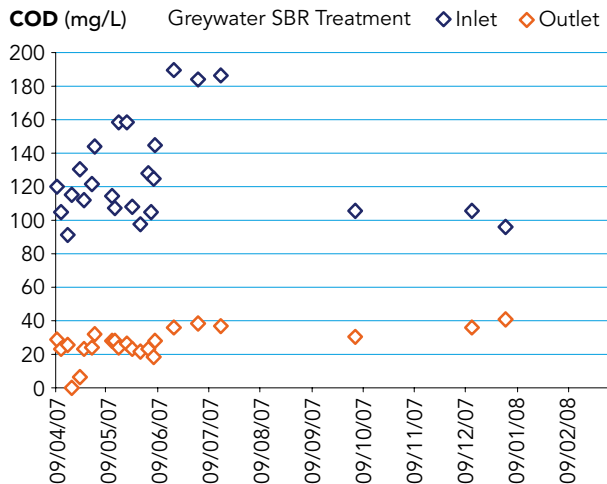

results obtained for the TDC experiments are indicated in figures 3 - 5.

### TDCs ROLE FOR CAPACITY BUILDING

The TDCs were also used for the purpose of disseminating knowledge and experiments through the courses organized during the project.

Hence, the implemented TDC over the project period has demonstrated and proved several positive im-

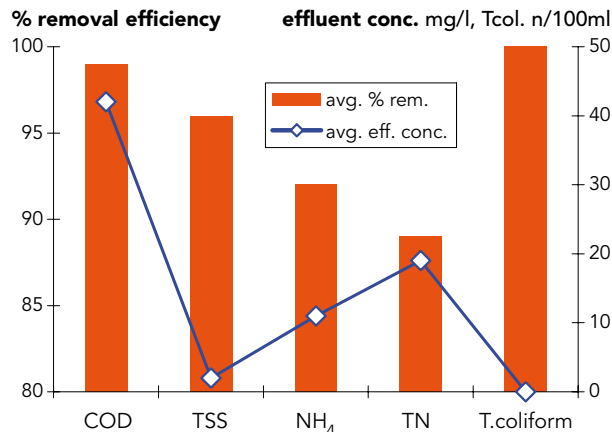

▲ **Figure 5:**  
**BLACK WATER TREATMENT RESULTS BY MBR (TUBITAK MRC-TURKEY)**

pacts along with the technical developments. Among them, it is worth underlining the following issues.

- Assessment of the feasibility of local water management on the urban scale and the benefit on water savings and nutrient reuse thanks to the development of adapted technologies.
- Development of research capacity to master implemented technologies and tools in a local context and gain experience for young research personnel.
- Dissemination of knowledge through courses organized for engineers, researchers, journalists, water and environment enterprises and NGOs, increasing awareness and concerns regarding SWM and the reuse. The attendees of the courses visualize much better and understand comprehensively the concept as well as the unique application areas thanks to the help from TDCs in partner countries.

The expectations of the attendees with regard to the dissemination activities, by making use of TDCs, were always taken into account at the country level. These issues are naturally relevant to the problems experienced in the country. In this manner, TDCs were helpful for the point of awareness rising, discussions of the problems and the development of conceptual solutions. Since the target groups consist of people directly involved in decision making, teaching, learning and implementation activities, the multiple effect of the attempts will be realized in the near future.

### CONCLUDING REMARKS

The experienced obtained from the implementation and operation of the TDCs revealed that the SWM concept can be successfully accomplished by the use of several TOs. Close and fruitful collaboration between the partners was especially very useful for the point of improving the operational conditions of the TOs, the assessment of the results and making modifications to comply with local conditions. The teamwork among the partners included the evaluation of the situation, the assessment of the problems, the evaluation of social economic and environmental issues, in accordance

with these issues the selection of the TOs to be implemented, the collaborative design of the TOs, working together on the construction work, monitoring and assessing the results obtained in the relevant countries. Hence, a broad knowledge gained and developed for the partners which, is considered to be a valuable experience.

In addition to that as a technical issue, in terms of arid areas, the approach of the TDC allows the development of a responsible management of rare resources. Along these lines, special attention is given to capacity building, training and awareness aspects to assess the future applications and the multiplying effects of the concept.



◀ *Figure 6:*  
**TDC VIEW FROM  
NRC, EGYPT**



◀ *Figure 7:*  
**TECHNICAL AND  
DEMONSTRATION  
CENTERS HAVE BEEN  
ESTABLISHED IN  
FOUR DIFFERENT  
MEDITERRANEAN  
COUNTRIES: EGYPT,  
MOROCCO, TUNISIA  
AND TURKEY**



◀ **Figure 1:**  
**TDC AT THE MARMARA RESEARCH CENTRE IN ISTANBUL, TURKEY**

**T**here are nowadays few experiences worldwide of CWs treating grey water and black water separately, and it is of extreme importance to increase the knowledge about their behaviour and performances, because the wastewater segregation and separate treatment seems to produce great advantages in terms of the reuse of the effluents. The comparison of the results obtained in the different treatment schemes can provide a clear idea about the optimised design of such CW systems for this particular application.

## DESCRIPTION OF THE IMPLEMENTED CW SYSTEMS

The CW treatment systems details are summarized for each location:

### TURKEY

The TDC is located in Gebze (Istanbul), inside the Marmara Research Centre (MRC) Campus, and CWs have been operating since June 2007 (see [figure 1](#)). The wastewater produced by a residential building is segregated and black and grey water treated in different lines.

- **Black water:** TSUAR (two stage upflow anaerobic reactor) + 2 VF CW in series (Vertical submerged flow CW) + FWS CW (Free Water System CW).

# OUTLINE OF CONSTRUCTED WETLANDS IN ZERO-M

By **FABIO MASI, BOUCHAIB EL HAMOURI, HUSSEIN ABDEL SHAFI, AHMET BABAN, GHRABI AHMED** and **MARTIN REGELSBERGER\***

Several Constructed Wetland (CW) systems have been implemented, with different pretreatments, in the four Technological Demonstration Centers (TDCs) realized by the Zer0-M project team in Turkey, Egypt, Tunisia and Morocco, together with three full scale pilot plants located in the last three countries. This paper will focus mainly on those systems which treat segregated domestic wastewater.

\* **Fabio Masi**, Ambiente e Lavoro Toscana ONLUS, via Pier Capponi 9, Florence, 50132, Italy

**Bouchaïb El Hamouri**, Institut Agronomique et Vétérinaire Hassan II (IAV), Département du Génie Rural, Rabat, Morocco,  
[b.elhamouri@iav.ac.ma](mailto:b.elhamouri@iav.ac.ma)

**Hussein Abdel Shafy**, Water Research & Poll. Control Departm., National Research Centre NRC, El-Behouth st., Dokki, Cairo, Egypt,  
[hshafywater@yahoo.com](mailto:hshafywater@yahoo.com)

**Ahmet Baban** is researcher at the TUBITAK Marmara Research Center, Chemistry and Environment Institute, 41470 Gebze, Kocaeli, Turkey,  
[ahmet.baban@mam.gov.tr](mailto:ahmet.baban@mam.gov.tr)

**Ahmed Ghrabi**, Centre de Recherches et Technologies des Eaux, Technopole Borj Cedria, Tunisia

**Martin Regelsberger** heads the water department at AEE INTEC, Gleisdorf, Austria, [m.regelsberger@aee.at](mailto:m.regelsberger@aee.at)

## RÉSUMÉ

### DÉLIMITATION DES ZONES HUMIDES ARTIFICIELLES À ZERO-M

Plusieurs systèmes de zones humides artificielles ont été mis en place, avec différents traitements préliminaires, dans les Centres de démonstration technologique, réalisés par l'équipe du projet Zer0-M en Turquie, Egypte, Tunisie et au Maroc. Par ailleurs, trois usines pilotes à échelle de grandeur 1/1 ont été bâties dans les trois derniers pays mentionnés. Dans ce document, nous nous intéresserons principalement aux systèmes traitant les eaux domestiques séparés. Peu d'expériences ont été acquises de nos jours, dans le monde, au niveau de l'utilisation des zones humides artificielles pour le traitement séparé des eaux grises et noires. Par conséquent, accroître les connaissances sur leur comportement et leurs performances revêt une importance capitale, sachant que la séparation des eaux usées et leur traitement séparé semble présenter d'importants avantages en termes de réutilisation des effluents. Lorsque l'on compare les résultats obtenus dans les différents procédés de traitement, il est possible de discerner clairement la manière dont ces zones humides artificielles doivent être améliorées pour cette application particulière.

- **Grey Water:** HF CW (Horizontal submerged flow CW) + FWS (Free Water System CW).

**MOROCCO**

The TDC is located in Rabat on the campus of the Hassan II Agronomy and Veterinary Science Institute of Rabat (IAV). Grey water produced by the nearby Club of the “Association Culturelle et Sportive de l’Agriculture” (ACSA) is treated with different degrees of technology, one of them being CWs. The system has been in operation since March 2005.

- **Grey water:** HF CW + VF CW + UV disinfection.

A full scale pilot plant has been implemented in the city of El Attaouia for treating the greywater produced by the municipal public bath (a so called hammam). The treatment system consists of an HF CW followed by a small low flow sand filtration unit (216 m<sup>2</sup> of total surface for treating 30 m<sup>3</sup>/d of greywater). The effluent is fully reused for urban landscaping.

**EGYPT**

The TDC is located in the NRC Campus in Dokki (Cairo). Domestic wastewater produced by a nearby residential building is segregated and black and grey water are treated in different lines with the following schemes:

- **Black water line 1:** Three chambers septic tank + HF CW + VF CW.
- **Black water line 2:** Three chambers septic tank + VF CW.
- **Grey water:** HF CW.

A full scale pilot plant has been implemented in SEKEM Farm, located to the east of Sharquiya Governorate, to treat the wastewater produced by the campus school and some houses (200 m<sup>2</sup> HF CW for treating 20 m<sup>3</sup>/d of mixed wastewater). The effluent is completely reused for timber irrigation in the farm area.

The SEKEM farm produces natural drugs by means of growing various herbs and extracting the active substances from them by an industrial cycle that ends up in the final products. It’s a community, a few hundred people live and work there, and there’s also a school for about 500 students. The target area for the pilot project comprises the school of the farm, a few buildings, the



◀ *Figure 2:*  
**TDC AT THE HASSAN II AGRONOMY AND VETERINARY SCIENCE INSTITUTE OF RABAT, MOROCCO**

campus kitchen and a laundry room. The wastewater is composed of 100% domestic wastewater. In the past, the wastewater was treated in a hybrid constructed wetland, comprising primary treatment and a sequence of vertical filter (VF) plus a horizontal filter (HF) plus a storage tank. In former times, the effluent contained in the storage tank was pumped to fields for irrigation. The vertical flow CW was clogged due to massive undersizing. The whole treatment system was bypassed in this way. The raw wastewater was used for irrigation, being pumped directly from the septic tank to the fields. The septic tank itself was in a dire state. The Zer0-M project, therefore, suggests the design described below for a pilot wastewater treatment plant as a solution for the efficient treatment of wastewater.

The intention of the plant is to increase the available water for agricultural purposes and at the same time solve the problem of uncontrolled wastewater disposal in the targeted area. A “sludge treatment constructed wetland” for treating and composting the sludge allows the reuse of the nutrients in the form of a high quality fertiliser on the farm.

▶ *Figure 3 a and b:*  
**CONSTRUCTED WETLAND 1 AND 2 ON THE SEKEM FARM LOCATED IN THE NRC CAMPUS IN DOKKI, CAIRO, EGYPT**



Some of the troubles, which occurred in the present treatment system, are due to a lack of maintenance of the mechanical components (e.g. pumps). For this reason it seemed advisable to design a robust system, as "simple" and "low-tech" as possible.

**TUNISIA**

The TDC is located at the Centre of Water Research and Technology (CERTÉ)—Laboratory of water treatment and recycling in Tunis (LTREU). The student house buildings present a facility which segregates grey and black water. Only black water is treated by CWs with the aim of reusing this for the landscape.

▼ Figure 4:  
**DESIGN OF THE TDC IN CHORFECH, TUNISIA**

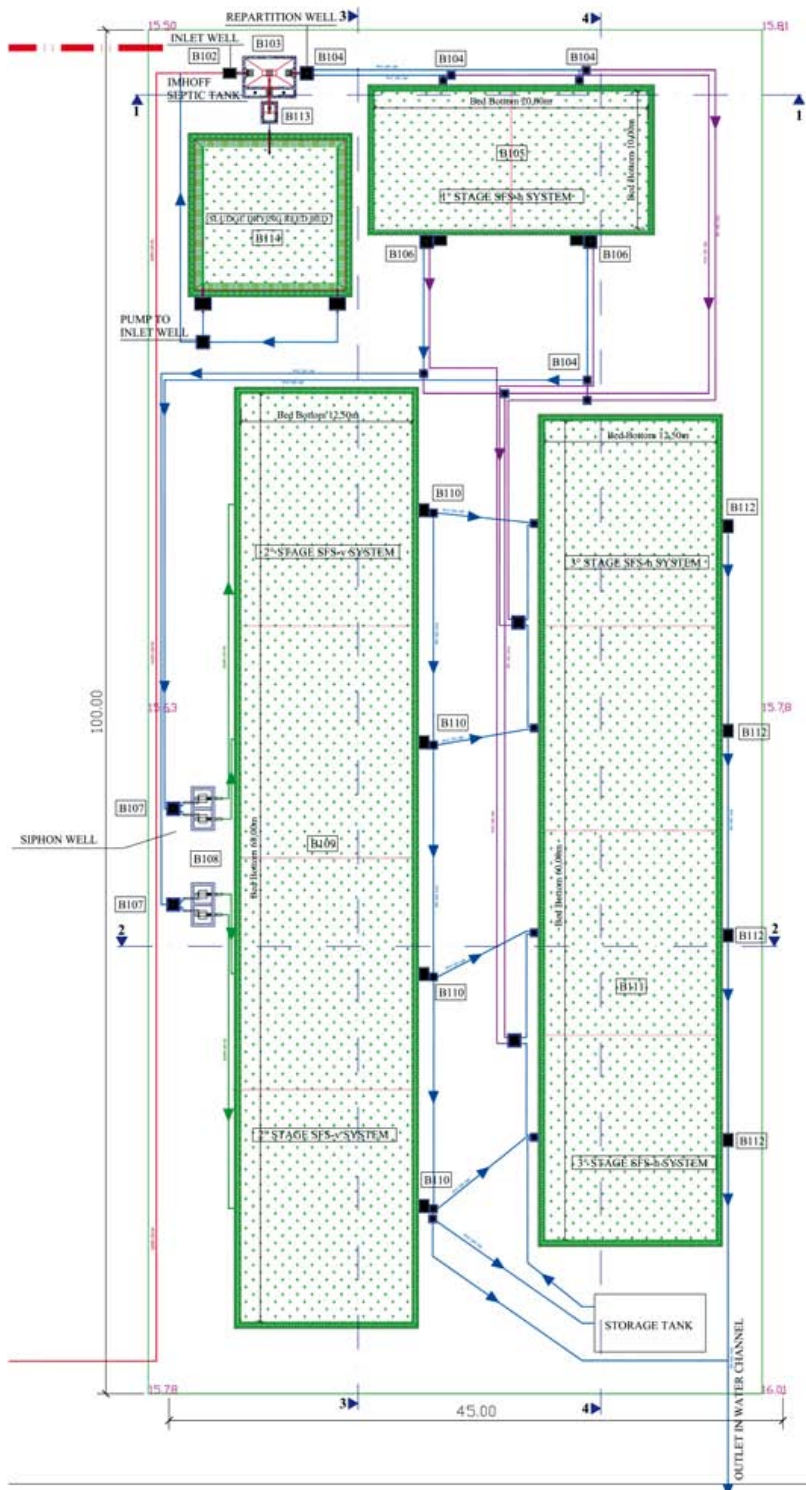

- **Black water:** three chambers septic tank +HF CW + VF CW. The treated water is stored in a tank for green area irrigation.

A full scale pilot plant is going to be implemented in the community of Chorfech for the treatment of 700 pe domestic wastewater, with the following scheme: Imhoff tank + HF CW + VF CW + HF CW; a storage tank will collect the effluent for agricultural reuse.

The pilot activity is mainly meant as a demonstration of sustainable water management solutions as suggested by Zer0-M (low-cost wastewater treatment), which shall prove that these solutions work under real conditions and ultimately allow the further spreading of the techniques demonstrated. The pilot activity will also help to gain experience with the techniques implemented under real conditions and improve them if necessary until they can be recommended for wide application in rural settlements in Morocco, Tunisia and Egypt.

Last but not least, the Tunisian pilot plant shall help to ease the difficulties in water and wastewater management faced by the fast growing community of Chorfech, a rural settlement in a semi-arid climate with a constantly increasing water consumption and very limited financial resources for the supply and sanitation services. Chorfech is a rural settlement of about 50 houses numbering 345 inhabitants. It is located to the North-West of Tunis about 24 km (national road GP8) between Tunis and Bizerte. The main activity at Chorfech is agriculture. The village has a conventional sewerage network linked to a septic tank. The diagnosis of the network, carried out by the ONAS in spring 2007, reveals some problems:

- problem of slope and quality of connection,
- rainwater entrance into the sewerage network,
- isolated houses not connected to the network,
- grey water collected separately and discharged directly out of the house.

There are, in total, 49 connecting points to the sewerage network and the last collector discharges the raw wastewater into the septic tank before discharging into a drainage channel.

The pilot plant should provide the possibility for the safe reuse of the wastewater treated, and the systems will be operated as a demonstration and a good example of rural settlements in Tunisia with low-costs.

**SEGREGATED WASTEWATER TREATMENT BY CWs: OBTAINED RESULTS**

The segregation of domestic wastewater into black and grey water produces a highly concentrated black water, with an organic content (as COD) ranging from 500 to 2,000 mg/L. The approach used in Turkey for the primary treatment by a TSUAR has showed a good performance, with about 80% removal of TSS and 78% for COD (the mean inlet concentration in the monitored period was 865 mg/L), so as to ensure an adequate inlet quality for the following VF CW (mean inlet concentrations of 170 mg/L for COD and 140 mg/L for NH<sub>4</sub><sup>+</sup>). The 2 VF CW provide adequate and satisfactory removal

rates both for the organic content as well as for ammonium, reaching outlet concentrations in the range of 0.5 mg/L  $\text{NH}_4^+$ . As a first result, the hybrid CW system obtains a FWS effluent with a concentration of less than 5 mg  $\text{O}_2$ /L  $\text{BOD}_5$ , 10 mg  $\text{O}_2$ /L COD, 0.2 mg/L  $\text{NH}_4^+$ , 1 to 2 mg/L TSS and 10 cfu/100 mL Total Coliforms. The presence of VF beds in the treatment scheme is essential for the removal of the high ammonium content, which is typical for this kind of wastewater.

The hybrid VF+HF CW systems in Cairo and Tunis are expected to reach the reuse standards for irrigation. At the moment these systems are in the start-up phase.

Grey water treatment by CWs seems to be an efficient and economic way of obtaining an effluent which needs only further disinfection for unlimited reuse. In these experiments, the inlet concentrations for grey water were in the range of 180 to 500 mg/L for COD, 1 to 8 mg/L for  $\text{NH}_4^+$ . The removal rates obtained in the Turkish HF + FWS CW were very high for all of these parameters, with effluent concentrations generally below 10 mg/L for TSS, 40 mg/L for COD, 15 mg/L for  $\text{BOD}_5$ , 1 mg/L for  $\text{NO}_3^-$ , 0.5 mg/L for  $\text{NH}_4^+$ . The final FWS provides a good final disinfection, with 4 to 6 logs of removal and final concentrations of Total Coliforms in the range of 1 to 200 cfu/100 mL, even though it produces sometime a light increase in the organic content in the final effluent due to the formation of some algae in it during the warm season.

The performance of the two-step (HF+VF) gravel/sand filtration unit in Morocco was quite satisfactory too. The effluent turbidity was reduced from 28 to 2 NTU. Removal rates of COD and  $\text{BOD}_5$  were 75 and 80% respectively. The outlet  $\text{BOD}_5$  concentration is on average 10 mg/L. Half of the nitrogen was nitrified during the filtration process. The removal rate of phosphorus was almost 50% while anionic surfactants were removed at a rate of 97%. On the contrary, the planted gravel/sand filter performance in FC removal was low and did not exceed one log unit and UV disinfection was needed to obtain the appropriate quality for reuse in toilet flushing in the Sports Club itself.

Also the Egyptian CWs reveal good removal performances both for grey and black water, ranging respectively from 58 to 98% of removal for COD and 93% for  $\text{NH}_4^+$  in the black water line and 22 to 98% for COD and over 90% for TSS in the grey water line.

The conclusions we can draw from these first results are the following:

- As expected, grey water has shown in all our monitored systems a high organic content, up to 700 mg/L COD, and a very low nitrogen content, always below 10 mg/L  $\text{NH}_4^+$ .
- Considering that for the VF CWs it's good practise to not load the bed with more than 20 gr COD/m<sup>2</sup>.d, in order to avoid clogging, and that HF beds can obtain good performances in organic content removal even with very high inlet concentrations, over 1,500 mg/L, as published in many papers related to the food industry wastewater treated by CWs, this configuration appears to be the ideal first stage for greywater treatment; if the desired quality of the effluent has to reach really low

concentrations of biodegradable organic matter, a further treatment by filtration (both low flow sand filters or VF CWs can work properly) or by a well designed FWS can easily bring this to the target removal; furthermore, HF beds (reed beds) can provide several removal pathways for the organic removal, having inside the "reactor" simultaneous conditions like aerobic, anoxic and in some zones almost anaerobic, providing a good stability for the treatment even with the occasional loads of unusual substances mixed with the greywater (oils, liquors, alcoholics drinks, aggressive surfactants formulas, ...).

About the pilot plants, at the moment only the first two months of monitoring of the Sekem CW in Egypt are available. The HF CW was recently planted so the root zone is not well developed yet, but the obtained results are anyway quite interesting. The HF CW, with an HRT of about 2.5 days, is already obtaining 78% removal for  $\text{BOD}_5$ , 71% for COD and 85% for TSS. Ammonia removal is instead almost absent at the moment, with outlet concentrations to the tune of 50 mg/L and quite close to the inlet ones. A straight increase in the performance of the system is expected for the end of the year 2008.

## CONCLUSIONS

The wastewater segregation into black and grey water components offers several advantages for their treatment by Constructed Wetlands and the reuse of the effluents. The experiences collected in this research provide useful knowledge about the chemical nature of the raw wastewaters produced in quite different sources located in Turkey, Egypt, Tunisia and Morocco and also the good efficiency of Constructed Wetlands for the treatment of segregated water has been proven. The comparison between the different treatment schemes has also provided a preliminary indication for the design concepts that have to be applied for the use of CWs in this kind of applications.



# SUSTAINABLE WATER MANAGEMENT TECHNOLOGIES IN TURKEY

## A SEMINAR IN GEBZE

By GERD WACH, ERWIN NOLDE, and ELIF ATASOY\*

One of the tasks of the Zer0-M-project is to spread information on sustainable water management and ecological sanitation to multipliers in the Mediterranean countries.

\* **Friedrich Gerhard Wach** is organizing the public participation of the European Union Water Framework Directive at three river basin areas in Northern Germany for the NGO Bund fuer Umwelt und Naturschutz Deutschland and is working at the University of Hanover for the Zer0-M-project, [f.g.wach@apc.de](mailto:f.g.wach@apc.de)

**Erwin Nolde** is the owner of the Berlin engineering firm Nolde and Partner – Technology Consultants for Innovative Water Concepts and has been an active member of the executive board of the German Association for Rainwaterharvesting and Water Recycling (fbr) since its foundation in 1995, [Erwin.Nolde@t-online.de](mailto:Erwin.Nolde@t-online.de), [www.nolde-partner.de](http://www.nolde-partner.de)

**Elif Atasoy** is a researcher at the TUBITAK Marmara Research Center, Chemistry and Environment Institute, 41470 Gebze, Kocaeli, Turkey, [Elif.Atasoy@mam.gov.tr](mailto:Elif.Atasoy@mam.gov.tr)

◀ *Figure 1:*  
**TDC IN GEBZE**

The Marmara Research Centre (MRC) in Gebze, about 60 km from Istanbul, decided to carry out another two training courses and invited experts from Italy and Germany who have long-term experience in the field of constructed wetlands, greywater recycling, rainwater harvesting, water saving devices and non-conventional sanitary appliances such as dry toilets and waterless urinals.

## WORKSHOPS FOR DECISION MAKERS

Wastewater reclaiming and membrane bioreactors were additional topics before the participants visited the Training and Demonstration Centre (TDC) at MRC, where various technical options of conventional and sustainable water concepts were presented and discussed. At the end of the seminar, a case study was worked out by the participants.

More applications have been received than the course and the centre facilities can accommodate. Nearly 50 participants took part in two, 2-day courses between 16<sup>th</sup> to 19<sup>th</sup> of April 2007. The first course targeted the academic and scientific public while the second course addressed decision makers from ministries, industry as well as water and wastewater undertakings and private companies.

The courses were run within the scope of the EU-financed MEDA project and were free of charge. The

## RÉSUMÉ

### TECHNOLOGIES DE GESTION DURABLE DE L'EAU EN TURQUIE – SÉMINAIRE À GEBZE – ATELIERS DESTINÉS AUX PRENEURS DE DÉCISION

Une des missions du projet Zer0-M consiste à diffuser des informations portant sur la gestion durable de l'eau et l'assainissement écologique à des multiplicateurs dans les pays méditerranéens. Le Centre de Recherche Marmara (MRC) à Gebze, situé à environ 60 km d'Istanbul, a décidé d'effectuer deux cours de formation supplémentaires et invité des experts venus d'Italie et d'Allemagne, jouissant d'une expérience de longue date en matière de zones humides artificielles, recyclage des eaux grises, collecte des eaux de pluie, systèmes de récupération des eaux de pluie et équipements sanitaires non conventionnels tels que toilettes sèches et urinoirs sans eau. Les sujets que sont la récupération des eaux usées ainsi que les bioréacteurs à membrane ont également été abordés avant que les participants aient visité le Centre de formation et de démonstration du MRC où diverses options techniques pour les systèmes de gestion de l'eau conventionnelle et durable ont été présentés et discutés. A la fin du séminaire, une étude de cas a été élaborée par les participants.



course started with a questionnaire on the estimated personal water consumption and the major problems related to water in Turkey from the point of view of the participants, followed by several technical lectures and it ended with a case study that was worked out in small groups.

## LACK OF WATER POLICY

When the participants were asked what in their opinion are the major problems related to water in Turkey, the first group's answers (ranked by participants according to significance) were water policy, water quality and quantity, lack of education/know-how and inefficient water use. The second group's answers were inefficient water use, water/environment policy, lack of education/know-how and unplanned urbanisation. Although the first group included mainly university students and academics while the second group comprised mainly professionals from the water sector, the results of the two groups were more or less the same.

## INEFFICIENT WATER USE

According to questionnaire results, the personal water consumption of the first group was 10 to 300 L/day with an average of 147 L/day. Similarly the second group's personal water consumption ranged between 13 to 445 L/day with an average of 115.8 L/day. It can be concluded that on an individual basis there is a lack of concern about how much water is consumed daily but on average, the results are close to realistic values.



## HIGH INTEREST AND ENTHUSIASM

The lecturers attested the participants a high interest in innovative water technologies. They also contributed significantly during discussion sessions. Participants from the water and wastewater undertakings as well as industry demonstrated a positive attitude towards water recycling and rainwater harvesting, especially constructed wetlands, as a nature-oriented wastewater treatment technology. Representatives of industry showed much enthusiasm in obtaining more detailed information which could be profitable to their business. During the breaks, there were repeatedly questions regarding investment and operation costs related to the situation in Turkey.

We could recognise that not only products, but also know-how was sought by the participants. Many of the participants were also happy to learn of the availability

▲ *Figure 2:*  
**A FILLED  
SEMINAR ROOM  
TILL THE END OF  
THE COURSES.**

▼▲ *Figures 3a, b:*  
**URINE  
SEGREGATION AND  
COMPOSTING OF  
HOUSEHOLD AND  
GARDEN  
WASTES—SOON  
ALSO IN TURKEY?**





▲ *Figure 4:*  
**TDC IN GEBZE—  
AN IDEAL PLACE  
TO INSPECT THE  
DIFFERENT  
TECHNOLOGIES  
ON SUSTAINABLE  
WATER  
MANAGEMENT  
(SEE ALSO  
FIGURE 1)**

of several practical methods to deal with water in an economic way, and as a result to reduce the water costs without any comfort loss. It was also possible to visually inspect some of the water-saving devices and this was welcomed by the participants. Some degree of reservation on the part of the participants was observed when dealing with compost or urine separating toilets (this also applies to Germany). This is understandable since many of the participants come from Istanbul with 12 million inhabitants and only a few have a garden where they could form a compost pile. Concepts which work well for rural areas are not necessarily practicable for urban areas. For the exploding metropolises of the world, sustainable and low-cost technologies are needed that are highly accepted by the users.

A highlight of the course was the excursion to the TDC, where composters, rainwater harvesting, urine separation, water-saving devices, different blackwater and greywater treatment technologies like constructed wetlands, sequencing batch reactors, membrane bioreactors and rotating biological contractors are be-

▼ *Figure 5:*  
**PARTICIPANTS  
DISCUSSING SWM  
TECHNIQUES IN  
SMALL GROUPS**



▲ *Figure 6:*  
**A GROUP PHOTO OF PARTICIPANTS AND EXPERTS AT THE  
END OF SEMINAR**

ing researched and could be inspected by the participants.

## RESULTS OF CASE STUDY

The course ended with a case study and it was found that the participants tried to realise a decentralised system as one tool of sustainable water management. After working in small groups and discussing three given alternatives: connection to a public WWTP, blackwater and greywater segregation and compost toilets, the participants were asked to vote for their preference. In the first group, nobody voted for the connection to the public WWTP compared to one vote in the second group. On the other hand, there were several votes for the third alternative in the first group but no votes in the second group, indicating that especially the young generation are more open to new concepts and ideas. In both groups the second alternative was voted for most.

One requirement to the understanding of the course contents was the translation of all English slides into the Turkish language by MRC. Additional questions and inquiries from the public were also simultaneously translated by MRC staff members when needed.

Slides should be presented in English only when it is clear that all of the participants can follow the lecture in the foreign language. Otherwise, the language of the participants should be the working language. Group discussions should be in the participants' language so that everybody will have the chance to participate.

The experience made during the course raises hope that sustainable technologies are truly sought after world-wide. However, it also shows that for their realisation there is still a long way to go.

## ACKNOWLEDGEMENTS

The Zer0-M project is funded by the European Commission under the MEDA Water Programme, project "Zer0-M" Contract-No ME8/AIDCO/2001/0515/59768.

# TDC CONTACT ADDRESSES

If you are in Egypt, Morocco, Tunisia or Turkey and you want to see sustainable sanitation techniques at work contact the Zer0-M partners there and visit their Training and Demonstration Centre.

## EGYPT

**Mr. Hussein I. Abdel-Shafy**  
Water Research & Pollution Control Department  
National Research Centre  
Tahreer street  
Dokki, Cairo (postal area 12311)  
EGYPT  
Tel: 0020 2 76 25 349  
Email: [hshafywater@yahoo.com](mailto:hshafywater@yahoo.com)

## MOROCCO

**Mr. Bouchaïb El Hamouri**  
Institut Agronomique et Vétérinaire Hassan II  
B.P. 6202  
Rabat  
Marokko  
Tel: 00212 37 77 75 64  
Email: [b.elhamouri@iav.ac.ma](mailto:b.elhamouri@iav.ac.ma)

## TUNISIA

**Mrs. Latifa Bousselmi**  
Centre de Recherches et des Technologies des Eaux  
Laboratoire Traitement et Recyclage des Eaux usées  
BP. 273  
8020 Soliman  
Tunisien  
Tel: 00216 71/788 436  
Email: [Latifa.Bousselmi@certe.rnrt.tn](mailto:Latifa.Bousselmi@certe.rnrt.tn)

## TURKEY

**Mr. Ahmet Baban**  
TÜBİTAK-Marmara Research Center (MRC-CEI)  
41470 Gebze  
Kocaeli  
Turkey  
Tel: 0090 262 677 29 04  
Email: [Ahmet.Baban@mam.gov.tr](mailto:Ahmet.Baban@mam.gov.tr)





# ZERO-M

MEDA Water



## SUSTAINABLE CONCEPTS TOWARDS A ZERO OUTFLOW MUNICIPALITY

CONTRACTING AUTHORITY

EUROPEAN COMMISSION / Delegation of the European Commission in Jordan

PROGRAMME

EURO-MEDITERRANEAN PARTNERSHIP

Euro-Mediterranean Regional Programme For Local Water Management

BUDGET LINE B7- 4100

### APPLICANT:



**AEE INTEC**

**AEE – Institute for Sustainable Technologies**

Feldgasse 19, 8200 Gleisdorf, Austria

**Martin Regelsberger**, tel: 03112 5886 –50, [m.regelsberger@aee.at](mailto:m.regelsberger@aee.at)

Barbara Regelsberger, tel: 03112 5886-50, [b.regelsberger@aee.at](mailto:b.regelsberger@aee.at)

### PARTNERS:



**ALT**

Associazione Ambiente e Lavoro Toscana –

O.N.L.U.S.,

Via Pier Capponi 7, 50132 Firenze, Italy



**MRC**

Tübitak-Marmara Research Center,

Gebze, Kocaeli, Turkey



**NRC**

Water Research & Pollution Control Department,

National Research Centre,

Tahreer street, Dokki, Cairo, Egypt



**CERTE  
(LTREU)**

Centre de Recherche et des Technologies des Eaux

Laboratoire Traitement et Recyclage des Eaux Usées

BP. 273, 2050 Hammam Lif, Tunisia



**IAV  
(WTRU)**

Institut Agronomique et Vétérinaire Hassan II,

Wastewater Treatment and Reuse Unit,

Madinat Al Irfane, Rabat, Morocco



**IGR  
(Univie)**

Department of Geography and Regional Research,

University of Vienna,

Universitätsstr. 7, 1010 Vienna, Austria



**TUB-  
kubus  
+ TUB-  
VT**

Technische Universität Berlin,

Zentraleinrichtung Kooperation and

Institut für Verfahrenstechnik,

Franklinstr. 28/29, 10587 Berlin, Germany



**wB**

Universität Hannover, Zentrale Einrichtung

für Weiterbildung (weiterBILDUNG),

Schlosswenderstr. 5, 30159 Hannover, Germany



**fbr**

Fachvereinigung Betriebs- und Regenwasser-

nutzung e.V.

Havelstr. 7a, 64295 Darmstadt, Germany

**Fabio Masi,**

tel: 0039 055 470 729,

[masi@altnet.it](mailto:masi@altnet.it)

**Ahmet Baban,**

tel: 0090 262 677 2904,

[Ahmet.Baban@mam.gov.tr](mailto:Ahmet.Baban@mam.gov.tr)

**Hussein Abdel Shafy,**

tel: 0020 2 76 25 349,

[hshafywater@yahoo.com](mailto:hshafywater@yahoo.com)

**Ahmed Ghrabi,**

tel: 00216 71 410 740,

[ahmed.ghrabi@certe.nrnt.tn](mailto:ahmed.ghrabi@certe.nrnt.tn)

**Bouchaib el Hamouri,**

tel: 00212 37 77 75 64,

[b.elhamouri@iav.ac.ma](mailto:b.elhamouri@iav.ac.ma)

[elhamouri@menara.ma](mailto:elhamouri@menara.ma)

**Karel Kriz,**

tel: 0043 01 4277 48641,

[karel.kriz@univie.ac.at](mailto:karel.kriz@univie.ac.at)

**Gisela Prystav**

(geb. Hoffmann),

tel: 0049 30 314 24617,

[gisela.prystav@zek.tu-berlin.de](mailto:gisela.prystav@zek.tu-berlin.de)

**Martin Beyersdorf,**

tel: 0049 511 762 4745

**Erika Villa**

tel: 0049 511 965 99 707,

[villa@targetgmbh.de](mailto:villa@targetgmbh.de)

**Dietmar Sperfeld,**

tel: 0049 6151 33 92 57,

[info@fbr.de](mailto:info@fbr.de)