

एक नया शौचालय, एक नयी सोच

# REINVENT · THE · TOILET FAIR

MARCH 2014 • INDIA

## Technical Guides





# Thank you for your participation!

This booklet provides you with brief organization and technology overviews of each of the exhibitors presenting at the Reinvent the Toilet Fair: India. These “guides” are intended to offer a summary of some of the key features of the exhibits, for more information please ask the exhibitors directly.

All the information in this booklet was supplied by the exhibitors. As the majority of technologies on display at the fair are still at the developmental stage, values may be estimates.

We encourage you to speak with the team members at each exhibit. Primary contact information for each team can be found on the following pages.

## Reinvent the Toilet Fair: 2014 - Exhibitor List

- |    |   |    |   |
|----|---|----|---|
| 5  | Aerosan   | 53 | IRC International Water and Sanitation Centre   |
| 7  | American Standard Brands  | 55 | Janicki Industries  |
| 8  | Arghyam   | 57 | Loowatt   |
| 11 | Asian Institute of Technology   | 59 | Loughborough University   |
| 13 | Beijing SunnyBreeze Technology Inc.   | 61 | National University of Singapore (NUS)  |
| 15 | Biofilcom   | 63 | North Carolina State University   |
| 17 | California Institute of Technology (Caltech)  | 65 | Pollution Research Group, University of KwaZulu-Natal; eThekweni Water and Sanitation, eThekweni Municipality |
| 19 | Centre for Advocacy and Research (CFAR)   | 67 | Population Services International (PSI), Water For People, and PATH   |
| 21 | Centre for Environmental Planning and Technology (CEPT) University  | 69 | RTI International   |
| 23 | Center for Study of Science, Technology and Policy (CSTEP)  | 71 | Sanergy   |
| 25 | Centre for Policy Research, New Delhi   | 73 | Santec  |
| 27 | Climate Foundation, Cornell University, Sanergy, Tide Technocrats, and the Prasino Group                  | 77 | SCOPE   |
| 29 | Cranfield University  | 75 | Sesame Workshop   |
| 31 | Defence Research Laboratory, DRDO, Indian Ministry of Defence   | 79 | Stone India Limited   |
| 33 | Delft University of Technology  | 81 | Sulabh International Social Service Organisation (SISSO); Sulabh Sanitation & Social Reform Movement          |
| 35 | Department of Industrial Design, SPA Delhi  | 83 | UNICEF India  |
| 37 | Duke University   | 85 | Unilever  |
| 39 | Duke University and the University of Missouri  | 87 | University College London and ifak  |
| 41 | Eawag (Swiss Federal Institute of Aquatic Science and Technology), Design by E00S                         | 89 | University of Colorado Boulder  |
| 43 | Eram Scientific Solutions Pvt. Ltd.   | 91 | University of Toronto   |
| 45 | FSOI Development Firms: AGI Engineering, Beaumont Design, DCI Automation, and Synapse Product Development | 93 | University of the West of England (UWE), Bristol  |
| 47 | Fundación In Terris and Critical Practices LLC  | 95 | WASH United and World Toilet Organization   |
| 49 | Indian Institute of Technology Kanpur   | 97 | World Bank Water and Sanitation Program, International Finance Corporation, and Kenyan Ministry of Health     |
| 51 | Institute for Financial Management and Research (IFMR) and Quicksand Design Studio                        | 99 | 3S – A Division of Saraplast Pvt. Ltd.  |



# Aerosan

## Aerosan: Low-Cost Sanitation for Emergencies

Aerosan has developed a four-toilet array as well as a separate single-unit cubicle. Key to the design is the use of enhanced passive ventilation for both control of odors and also drying of excreta. The material can be subsequently composted. The low-cost construction approach using re-purposed vinyl billboard fabric allows for a large plenum (a space provided for air circulation and venting), which, driven by a Venturi is able to move more air through the system than would normally be available in a typical 4" (100 mm) vent pipe. The design puts the outlet of the plenum 15' (4.3 m) above the ground, so odors are released at a higher elevation than typical vented toilet cubicles.

Several units have been deployed for field testing in Haiti and are operating at a high level.

The unit shown at the Delhi toilet fair is fully functional and will be an improved design from the one shown at the first toilet fair in Seattle in 2012. Design improvements have focused on reducing the weight, cost, and improving the wall and plenum structures. Also, the whole design will be available in kit form for use in emergencies.

### How it works

The primary technical feature of this toilet is the design of a passive ventilation system which draws more air than is necessary for simple odor control. In this way, a degree of drying takes place which reduces volume accumulation of excreta and thus increases the number of users that can use the system per maintenance period. Ventilation is both wind and solar-driven, but all passive.

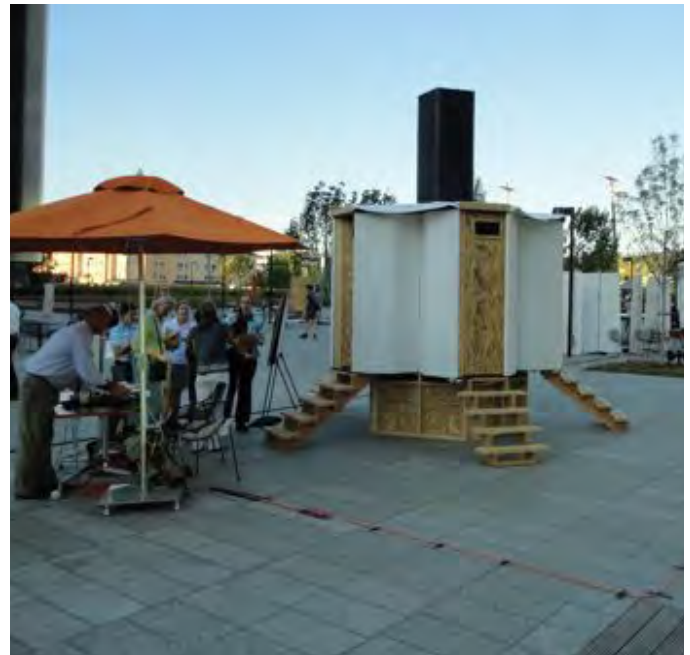

*Inexpensive construction and reuse of vinyl billboard fabric provides an innovative approach to toilet cubicle design.*

## Key Features

### Pathogen Treatment Success

### No Pathogen Treatment Provided

Daily Operating Cost	\$0.033 - \$0.14 per user/day
----------------------	-------------------------------

Water/Fertilizer/ Energy creation/capture	Water: None Fertilizer: Compost recovery potential Energy generated: None
---	---

Business Opportunity	Direct sales are anticipated to be the most effective business model
----------------------	--

*\*One unit is one toilet cubicle*

## How does the system work?

<b>Are chemical processes used?</b>	No.
<b>Are mechanical processes used?</b>	Yes, passive ventilation and passive solar heating for dewatering.
<b>Are biological processes used?</b>	No.
<b>Does the system require the use of water?</b>	No.
<b>Does the system require the use of electricity?</b>	No.
<b>Does the system use other consumable materials?</b>	No.
<b>Does the system require any waste to be processed off-site?</b>	Yes. The material is subsequently composted at high temperatures, rendering pathogens ineffective. This can be done either on or off site.
<b>Does the system require any waste to be dumped in adjacent soil?</b>	No.

## What are other key features of note?

<b>What is the current status of the system?</b>	System demonstrated in an operational environment
<b>What technical challenges remain?</b>	Minor design modifications and field testing are required.
<b>What is the system life expectancy?</b>	4 - 8 years
<b>How many users can the system accommodate?</b>	10 - 20 users per toilet per day
<b>What is the estimated daily operations cost per user?</b>	\$0.035 - \$0.14/user/day
<b>How much energy will be recovered?</b>	None.
<b>How much usable water will be recovered?</b>	None.
<b>How much fertilizer will be produced or recovered?</b>	With suitable compost cover material, 80g/user/day.
<b>What is the estimated business opportunity or revenue potential?</b>	Direct sales are anticipated.



Vinyl fabric allows for easily cleanable interior surfaces. The current model utilizes much less wood and therefore can be produced at a lower cost.

# AEROSAN

**Aerosan**  
Andrew Larsen, Director

6948 S. 800 E.  
Salt Lake City, UT 84047  
USA  
P: 801-895-9838  
E: info@aerosan.net  
www.aerosan.net



# American Standard Brands

## Affordable, Aspirational Sanitation Products for Sub-Saharan Africa

### Building on Success in Bangladesh

In 2012, one of the most respected toilet manufacturers in the world partnered with the Bill & Melinda Gates Foundation to develop the SaTo®, a sanitary toilet pan designed to improve sanitation and reduce the spread of disease in Bangladesh. Now, American Standard Brands has received a grant from the foundation, with a focus on addressing sanitation issues in Sub-Saharan Africa

### Product Development for Sub-Saharan Africa

Scarcity of water in Sub-Saharan Africa presents a different challenge than Bangladesh and will require the development of a new latrine concept. The American Standard team, again in collaboration with iDE, is now applying its design and manufacturing expertise to this new challenge. The key is to understand what people need, determine what's possible to manufacture locally and economically, and find the match that works.

Beginning with an initial research trip in Zambia, the project strategy is to replicate the sanitation product development model that American Standard successfully used to create the SaTo. This time the objective will be to develop a hygienic toilet pan that can operate in an environment where water is less abundant. Prototypes will be tested in the field to obtain feedback from local residents on the effectiveness of the toilet pans during a subsequent trip to Africa.

The original SaTo toilet pans received extremely positive feedback in field testing by improving the sanitation and quality of life for users in Bangladesh. These cost effective, hygienic toilet pans create both a mechanical seal and airtight water seal to close pit latrines off from open air, reducing disease transmission and improving the user experience by reducing odor.



**SATO® LATRINE PAN**

**OVER 30,000 SOLD IN BANGLADESH.**

**RECOGNIZED IN POPULAR SCIENCE**

**“BEST OF WHAT’S NEW 2013”**



**James M. McHale, Ph.D.**

Vice President, Research, Development, & Engineering

American Standard Brands  
865 Centennial Avenue  
Piscataway, New Jersey 08854, USA  
P: 1-732-369-4065  
E: mchalej@americanstandard.com  
www.americanstandard-us.com  
www.flushforgood.com





# Arghyam

## Description

Arghyam strongly advocates the community driven sanitation service delivery in a bid to ensure sustainability. Arghyam has awarded a grant to the Center for Urban and Regional Excellence (CURE), to build a socially coherent community in the slums of Tajganj, the historic city centre of Agra. The program is designed to revitalize the heritage wells in the area and develop an Integrated Urban Watershed Management System (IUWM) through integration of appropriate sanitation solutions. The program will rebuild the Tajganj communities enabling them to take informed and sustainable environmental actions and actively engaging them in the planning, design and management of the sanitation solutions.

The Tajganj project is inspired from CURE's sanitation initiative in Kuchpura slum. A DEWATS technology was envisaged in Kuchpura, Agra, located on the west bank of River Yamuna. The methodology adopted involved the construction of a bio-remedial system using appropriate plant species for the treatment of wastewater.

The source of wastewater was from the slums and settlements upstream carrying direct toilet discharge, sludge and kitchen wastewater through open surface drains into the River. The dirty drain was affecting the health of the people and the areas' with tourism potential for tourism that provide economic stability.

The treated wastewater is reused for non-potable purposes within the local ecosystem; the treated waste water also is recycled through recharging of groundwater and has improved the quality of discharge into the River Yamuna.



## Key Features

1. Social Mobilization to create community understanding and ownership of its natural resources/ecology,
2. Community Dialogue, Trust Building, Volunteerism and Leadership Nurturing to facilitate their involvement in the design, implementation and sustainability of responsible interventions
3. Technical Assistance and Local Capacity Building to enable communities to be effective partners with the city in the successful implementation of desired sanitation process
4. Alignment with Government's investments on slum development in Agra

**Pathogen Treatment Success** **Yes**

Capital Cost (INR) ` 20 Lakhs ( in Year 2010)

Lifespan of unit (Years) 25 Years

Designed to serve how many people per day 3621

Daily Operating Cost ` 0.30/Household/day

Water/Fertilizer/Energy creation/captured The treated water is used for agriculture and construction activities

## How does the system work?

Are chemical processes used?	No
Are mechanical processes used?	Yes
Are biological processes used?	Yes
Does the system require the use of water?	Yes, as the process is based on treating the waste water and reused.
Does the system require an external source of electricity?	NA
Does the system use any other "consumable" materials?	The technology is based on Natural Biological System that uses plant species for waste water treatment.
Does the system require any off-site waste processing?	No. The system is installed to address issues within the local community.
Does the system require any waste to be dumped or infiltrated in adjacent soil?	No. The sludge mixed with soil may be used as manure.

## What are other key features of note?

What odor control measures are included?	NA
What is the estimated capital cost of the system?	` 20 Lakhs
What is the system life expectancy?	25 years
What is the expected daily user cost?	` 0.30/household/day
How much energy will be recovered?	NA
How much usable water will be recovered?	0.04 MLD
How much fertilizer will be produced or recovered?	NA
What is the estimated business opportunity or revenue potential?	NA



The slum development in Tajganj ensures sustainability of end to end sanitation service delivery designed around community as the strong link in the entire value chain of sanitation system



**Neelima Thota**  
Director – Urban Programme

Arghyam  
#599, 12th Main, HAL 2nd Stage, Indiranagar, Bangalore, Karnataka, India, Pin-560008  
P: +91 (080) 41698941/42  
E: info@arghyam.org  
www.arghyam.org

*Socially Coherent Community –  
the Critical Link to Sustainable Sanitation Solution*

## Solar Septic Tank and Hydrocyclone Toilet

Asian Institute of Technology (AIT) is working on two new technology advancements in their quest to resolve some of the world's sanitation needs. First, AIT is developing a modification of conventional septic tank technology by establishing thermophilic anaerobic conditions within the Solar Septic Tank. The thermophilic conditions, which primarily consist of applying high temperature (50-60°C) to septic waste, will offer faster degradation rates and greater disinfection efficiencies compared to conventional septic tanks. The system consists of two main components: a top-floor standard flush toilet system, and a lower-level solar septic system. The thermal reactor will be heated through heat exchange device by circulating hot water surrounding the reactor. This water is itself heated by use of a solar panel, so no external electrical source is required.

Additionally, AIT is presenting a black water separator toilet called the Hydrocyclone Toilet. The application of a solid-liquid separator is a common unit of operation in many other fields. However, in the case of onsite sanitation systems its application is limited and challenging due to the unpleasant characteristics of fecal materials. In this regard, AIT is endeavoring to develop an efficient separator and appropriate onsite solid and liquid disinfection technology. The Hydrocyclone offers several desirable characteristics, including no energy and low maintenance requirements.

Separated solids will be treated primarily by heat application. By a certain degree of temperature and duration of exposure, the separated solids will be disinfected and released from the heating unit. Heat will be produced by solar energy. The separated liquid will be further disinfected by using electrochemical technology. The appropriate conditions and specific configuration of the treatment technology are being investigated.

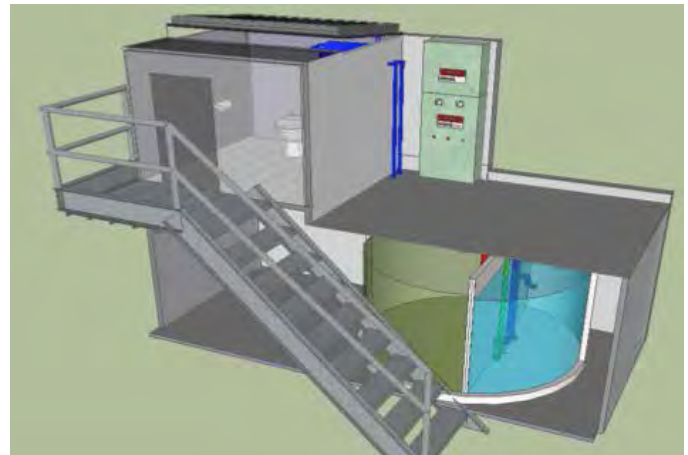

Solar septic tank

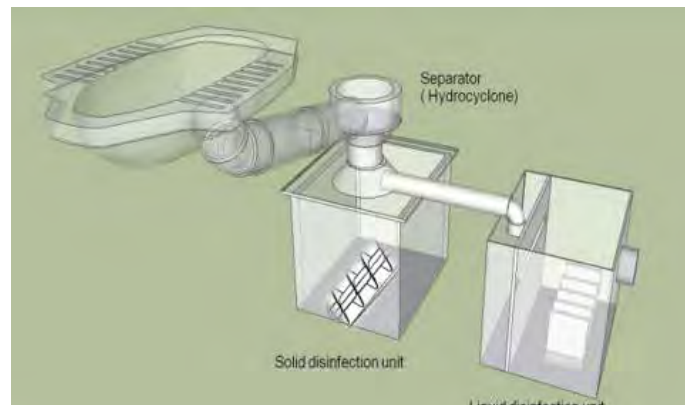

Hydrocyclone Toilet

### Key Features

<b>Pathogen Treatment Success</b>	<b>&gt;99.9% reduction</b>	<b>&gt;99.9% reduction</b>
Daily Operating Cost	\$0.03-0.15 user/day	\$0.04-0.10 user/day
Water/Fertilizer/ Energy creation/capture		
Water for reuse :	~70% recycled for internal use	~80% recycled for internal use
Fertilizer:	None	100 g/user/day (wet wt basis)
Energy generated:	LPG 12g/day	

## How does the system work?

<b>Are chemical processes used?</b>	No
<b>Are mechanical processes used?</b>	Yes, in particular for the Hydrocyclone separator, it works by centrifugal force and gravity. Minimal mixing is required in the disinfection unit. For the Solar toilet, no mechanical process is used.
<b>Are biological processes used?</b>	Yes, anaerobic digestion is a main process for the Solar toilet; however, no new biological elements will be introduced. No biological processes are required for the Hydrocyclone toilet.
<b>Does the system require the use of water?</b>	Yes, water will be heated to regulate process temperatures. No water is required for Hydrocyclone toilet.
<b>Does the system require an external source of electricity?</b>	No external source of electricity for heating as it is powered by solar collector panel for the thermal toilet. Electricity requirement will be minimized in Hydrocyclone toilet
<b>Does the system use any other "consumable" materials?</b>	No.
<b>Does the system require any off-site waste processing?</b>	No.
<b>Does the system require any waste to be dumped in adjacent soil?</b>	No.

## What are other key features of note?

<b>What is the current status of the system?</b>	Subsystem components tested in a laboratory environment.
<b>What is the system life expectancy?</b>	10+ years
<b>How many users can the system accommodate?</b>	4-10 users.
<b>What is the estimated daily operations cost per user?</b>	\$0.03-0.15 (Solar toilet) \$0.04-0.10 (Hydrocyclone toilet)
<b>How much energy will be recovered?</b>	Approx. LPG 12 g/day can be produced as Biogas from the Thermal toilet.
<b>How much usable water will be recovered?</b>	Average 15 L/user/day from both toilets
<b>How much fertilizer will be produced or recovered?</b>	Approx. 20 g/user/day (wet wt.) from Hydrocyclone toilet
<b>What is the estimated business opportunity or revenue potential?</b>	User fees



**Dr. Thammarat Koottatep**  
Associate Professor

Environmental Engineering and Management  
Asian Institute of Technology  
P.O. Box 4, Klong Luang,  
Pathumthani 12120, Thailand  
P: +662 524 6188  
E: thamarat@ait.ac.th



# Beijing SunnyBreeze Technology Inc.

## Waterless Toilet & On site Waste Processor

Beijing Sunnybreeze is developing a waterless toilet with a complete Mini Waste Processor (MWP) that dries and sterilizes human waste in an automatic system. The liquid portion of the human waste is evaporated and the solid portion of the fecal sludge is heated in the evaporator/dryer/sterilizer of the MWP. This unit removes the pathogens and transforms the waste into a dried form that is usable as a fertilizer. The toilet consists of two main assemblies: the Mini Waste Processor with attached toilet bowl and an improved Solar Thermal Air Blower for sunny countries.

The on-site waste processor has two purposes. The first is to dry the fecal sludge and the second is to heat the sludge to kill the pathogens. The key to rapidly drying the sludge with high temperature air is to increase the surface area of the sludge over which the hot air blows so that the sludge dries more rapidly.

The evaporator/dryer is a vertical screw assembly on the backside of the toilet bowl that lifts balls and sludge out of the fecal sludge reservoir. The balls are designed using shaped indentations and cavities in which the fecal sludge is carried up the column. The hot air flow and the speed of the screw mechanism is adjusted so that the balls at the top of the screw assembly are dry. A solar vacuum tube provides sterilization and storage for the dry sludge.

The balls, which now have a coating of dried sludge, exit the top of the vertical screw assembly and enter a shaker assembly followed by a mechanism to deform the balls. This is done to dislodge the dried fecal material from the balls. As the dried fecal material is disinfected, this dried fecal material can be used as a fertilizer.

For sunny countries an improved solar air thermal collector is proposed. For non-sunny countries, the hot air is provided from electricity from wind, water, or the local electric grid. An industrial electrical dryer is bolted to the mini waste processor instead of the solar heated air input to provide the hot air or drying and sterilization



### Key Features

#### Pathogen Treatment Success

#### Confirm total pathogen removal

Daily Operating Cost

\$0.01/user/day

Water/Fertilizer/ Energy creation/capture

Water for reuse:  $\geq 5$  liters upon requires  
Fertilizer:  
150-200g/user/day  
Energy generated:  
none

Business Opportunity

Country / Regional Sales / Service Agents

# Beijing SunnyBreeze Technology Inc.

## How does the system work?

Are chemical processes used?	No.
Are mechanical processes used?	Yes, the screw and ball assembly is used to move fecal waste through the drying process.
Are biological processes used?	No.
Does the system require the use of water?	No.
Does the system require an external source of electricity?	In non-sunny climates, external electricity may be required.
Does the system use any other "consumable" materials?	No.
Does the system require any off-site waste processing?	No.
Does the system require any waste to be dumped in adjacent soil?	No.

## What are other key features of note?

What is current status of the system?	System demonstrated in a relevant environment
What technical challenges remain?	Further design refinements and testing are required.
What is the system life expectancy?	10 years.
How many users can the system accommodate?	5-6 users.
What is the estimated daily operations cost per user?	0.01 (daily operations cost is 0, Some savings as maintenance costs)
How much energy will be recovered?	None.
How much usable water will be recovered?	None.
How much fertilizer will be produced or recovered?	150-200 g/user/day



**Jing Ning**  
CEO

900, Haiyuncang Building  
#1 HaiyuncangHutong  
Dongcheng, Beijing 100022  
86-10-52482653  
sunnybreeze01@gmail.com  
www.nowatertoilet.com

## Biofil Toilet System

At the core of the Biofil Toilet System technology is the Biofil Digester, which completely decomposes the feces on-site, without any chemical agents. The digester can be installed onto an existing in-home sanitation setup, or can be part of a new community sanitation solution.

After each toilet flush, the porous filter in the digester immediately separates the water from the fecal matter, and in the closed environment of the digester box, the solid waste is decomposed in perfectly aerobic conditions. The decomposition of the solid waste is by a self-perpetuating population of natural macro-organisms (earthworms, beetles, snails, black soldier fly etc.) and micro-organisms. The water that has been separated from the solid matter (effluent) is discharged into the ground under soil cover, returning nutrients into the soil and not into water bodies. The effectiveness of filtration in removal of pathogens is currently under independent evaluation.

Under these aerobic conditions, the end product of decomposition is water (and the nutrients it carries) and carbon dioxide, both of which are odorless, harmless, and economically valuable.

The system can be installed in all soil conditions, including heavy clay, shallow or exposed rock beds, and locations with high water tables.

Using this technology, the Biofil Toilet System is

- odor free
- decomposes the solid matter 30 times faster than anaerobic treatments on-site
- not requiring disposal of waste, or any further treatment
- no discharge of waste or other residue into water bodies or streams
- no operational and maintenance costs
- covers a small dimensional area (typically 1.5m<sup>2</sup>)
- can be installed in a day, requiring minimal site excavation.



## Key Features

Capital Cost of: Biofil Toilet System	\$1000-1200 USD including digester, toilet bowl, wash bowl and super structure and installation
Daily Operating Cost:	No operation and minimal maintenance costs (\$0.00 – 0.01 /day)
Water/Fertilizer/Energy creation/capture:	Watering plants Fertilizer: Dry compost Energy generated: None
Business Opportunity	Direct sales or user fee models can be pursued

## How does the system work?

Are chemical processes used?	No.
Are mechanical processes used?	No.
Are biological processes used?	Yes, the Biofil toilet system utilizes earthworms, snails, beetles, and black soldier flies in feces digestion.
Does the system require the use of water?	Yes, for flushing purposes.
Does the system require an external source of electricity?	No.
Does the system use any other "consumable" materials?	No.
Does the system require any off-site waste processing?	No.
Does the system require any waste to be dumped in adjacent soil?	Yes, approximately 20% of total waste is returned to the soil in the form of compost.

## What are other key features of note?

What is the current status of the system?	System is designed and qualified through test and demonstration
What is the estimated capital cost of the system?	\$1000 – 1200 USD
What is the system life expectancy?	10 – 20 years
How many users can the system accommodate?	10 – 20 users/day
What is the estimated daily operations cost per user?	\$0.00 – 0.01/user/day
How much energy will be recovered?	None
How much usable water will be recovered?	None
How much fertilizer will be produced or recovered?	None
What is the estimated business opportunity or revenue potential?	Revenue can be generated from direct sales to users or from user fees in community installations



Biofil micro-flush toilet bowl plumbed to a wash basin. The grey water from hand washing creates a water seal to prevent any smell from the digester.

Our Mission:  
**“A TOILET IN EVERY HOME.”**



**Caleb Kweku Ansah**  
 Senior Sales Engineer

Street Address: C81/14 Forest Avenue, Dzorwulu  
 City: Accra, Ghana-West Africa  
 Phone: +233-302774489  
 Email: info@biofilcom.org  
 Website: www.biofilcom.org



## Caltech's Self-Contained, PV-Powered Domestic Toilet and Wastewater Treatment System

Researchers at the California Institute of Technology (Caltech) have built a toilet that uses the sun to power an electrochemical reactor. The reactor breaks down water and human waste into fertilizer and hydrogen, which can be used in hydrogen fuel cells as energy. The treated water can then be reused to flush the toilet or for irrigation.

The Caltech system is an onsite wastewater treatment and recycling unit that can be powered by solar panels or by connection to the electrical grid. The fully integrated treatment system includes:

- in-situ disinfection
- by-product extraction
- the generation of hydrogen as a by-product of waste treatment
- a solar energy battery storage system
- solar arrays, and
- a microfiltration component for final polishing of the water before reuse and recycling.

### Prototype Presentation

Caltech will present two prototypes at the Delhi Fair in March, 2014.

Prototype 1: Caltech's Treatment System integrated with Kohler fixtures

This prototype will be a 20-ft long shipping container with a modern Kohler bathroom as the "user interface" and Caltech's treatment system connected to it. In addition to Caltech's electrochemical treatment technology, the system will include an array of Microbial Fuel Cells developed by Bristol Robotics Laboratory at UWE.

Prototype 2: Caltech's Treatment System connected to ERAM's E-Toilet

The treatment unit will be constructed in 3m x 2.5m x 2.5m space located in a modified shipping container. The unit will be connected to the E-Toilet interface developed by India technology company Eram.



The key component of the Caltech system is an electrochemical reactor with an array of anodes and cathodes in its center. The treatment process is a multistep oxidation of the organic waste and the bacteria present in the mixture.

**Pathogen Treatment Success**

**Complete pathogen elimination achieved**

Daily Operating Cost

\$0.03-0.10/user/day

Water/Fertilizer/Energy creation/capture

- Water for reuse  
- Fertilizer  
- Energy generated  
Quantities TBD

Business Opportunity

User fees or leasing of the unit anticipated, sale of usable water and energy expected

**KOHLER**



# California Institute of Technology (Caltech)

## How does the system work?

<b>Are chemical processes used?</b>	Yes: electrochemical oxidation processing of the wastewater
<b>Are mechanical processes used?</b>	No
<b>Are biological processes used?</b>	Yes: pretreatment in the holding tank and possible use of a microbial fuel cell (for urine treatment)
<b>Does the system require the use of water?</b>	Yes: 160L of flush water is required to initiate the process. After initiation, water recycled from the toilet operations is used for flushing purposes. Tap water, seawater, or wastewater may be used for initiation.
<b>Does the system require an external source of electricity?</b>	Yes: backup power of 2 kW is recommended in case of failure of the photovoltaic panels.
<b>Does the system use any other "consumable" materials?</b>	Yes: one-time loading of 10kg of standard or industrial grade NaCl (salt) is used to improve electrolysis efficiency.
<b>Does the system require any off-site waste processing?</b>	Yes: approximately 10% of the waste handled would be processed elsewhere.
<b>Does the system require any waste to be dumped in adjacent soil?</b>	No. There is no need for waste infiltration in nearby soils.

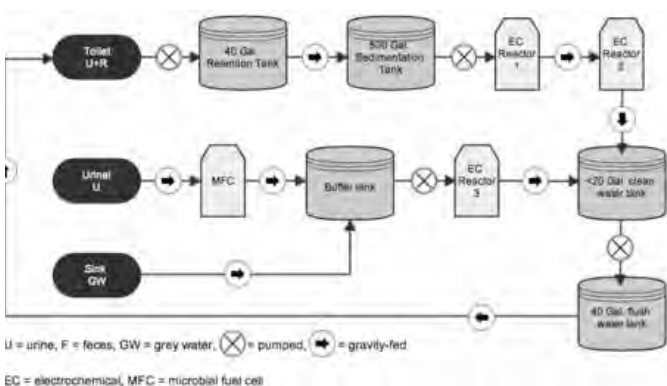

Simplified flow and energy diagram for Caltech's Self-Contained, PV-Powered Domestic Toilet and Wastewater Treatment System.

## What are other key features of note?

<b>What is the current status of the system?</b>	System demonstrated in an operational environment
<b>What is the system life expectancy?</b>	20 years
<b>How many users can the system accommodate?</b>	5-50 users
<b>What is the estimated daily operations cost per user?</b>	\$0.03-0.10 /user/day
<b>How much energy will be recovered?</b>	390kJ /user/day in Hydrogen Net Calorific Value
<b>How much usable water will be recovered?</b>	>90%
<b>How much fertilizer will be produced or recovered?</b>	Phosphates and Nitrates quantity TBD
<b>What is the estimated business opportunity or revenue potential?</b>	Leasing, treatment unit for public toilets, sale of water and energy byproducts



**Dr. Michael R. Hoffmann, NAE**  
James Irvine Professor of Environmental Engineering

1200 E California Blvd  
Linde-Robinson Room 204 (131/24)  
Pasadena, CA 91125  
P: 626-395-4391  
E: mrh@caltech.edu  
<http://hoffmann.caltech.edu>

# Centre for Advocacy and Research (CFAR)

## Partnering with mission convergence an innovative governance reform programme in delhi, strengthening and expanding women-led empowerment strategies

The vision of the project, spread across three cities of Delhi, Jaipur and Kolkata covering 39 settlements with approximately 30584 households is to facilitate a process of strong and effective advocacy led by women's forums and community structures supported and mandated by the government aiming at the development of women-friendly sanitation services. And in keeping with the policy commitment to guarantee special "focus on hygienic, affordable sanitation facilities for women and urban poor."

Guided by this vision the thrust of our intervention across the cities has been to advocate in coordination with both provider and user on improving sanitation services for the most marginal and at-the-risk communities living in highly precarious conditions.

In doing so two core components of the intervention has been, community participation and involvement and consistent active interface between the official agencies such as the Delhi Urban Slum Improvement Board-DUSIB, Municipal Corporation of Delhi-MCD, Jaipur Municipal Corporation, the local Municipality and community structures that are both officially mandated such as the Gender Resource Centres set up by Mission Convergence in Delhi and Women and User Forums that are evolving in all the settlements we are working in.

Today Women's and Adolescent Forums have emerged across the cities. There are 13 Forums across the cities that have emerged with a membership of 193 women and adolescent girls, out of these approximately 56 women and girls being active members leading negotiations with stakeholders, filing petitions, planning and strategizing. Till date these forums have submitted about 50 petitions on range of issues related to sanitation.

In effect the government departments, Municipal bodies have responded positively that have led to small but significant service provisioning. For instance the DUSIB in Delhi has approved of 20 community toilet complexes for construction benefitting more than 5000 residents of these areas.



**Akhila Sivasdas**

H-2B First Floor  
Kalkaji, New Delhi  
New Delhi- 110019





# Centre for Environmental Planning and Technology (CEPT) University

## Performance Improvement Planning (PIP) Model

This model uses Service Level Benchmarking (SLB) indicators and additional PAS indicators for improvement planning. It consists of three basic modules: Performance Assessment, Action Planning and Financial assessment. Plan options can be assessed for their service levels and financial impacts. Customised output reports with financial and phasing implications can be generated from the model.

### Performance Assessment

Performance indicators are used for assessing service performance. With appropriate inputs, the model assists in simulating service levels for a plan period (up to 10 years). It uses 'traffic light analysis' to highlight results. Comparisons are made in relation to peer groups and benchmarks. Different action plan options are evaluated in relation to their phasing and performance impacts.

### Inter Sectoral Action Planning

Priority improvement actions can be calibrated as individual project proposals. Final action plan combines actions on all three sub sectors (water, waste water and solid waste) and helps arrive at costs (capital and O&M) and performance benefits. Model also enables an assessment of phasing of different actions

### Financial Assessment

The model can be used to forecast financial health of ULB based on past trends and key ratios. Financial impact of each action is also assessed. For each selected plan action the model helps to generate a feasible financing plan by assessing tariffs, collection efficiency,

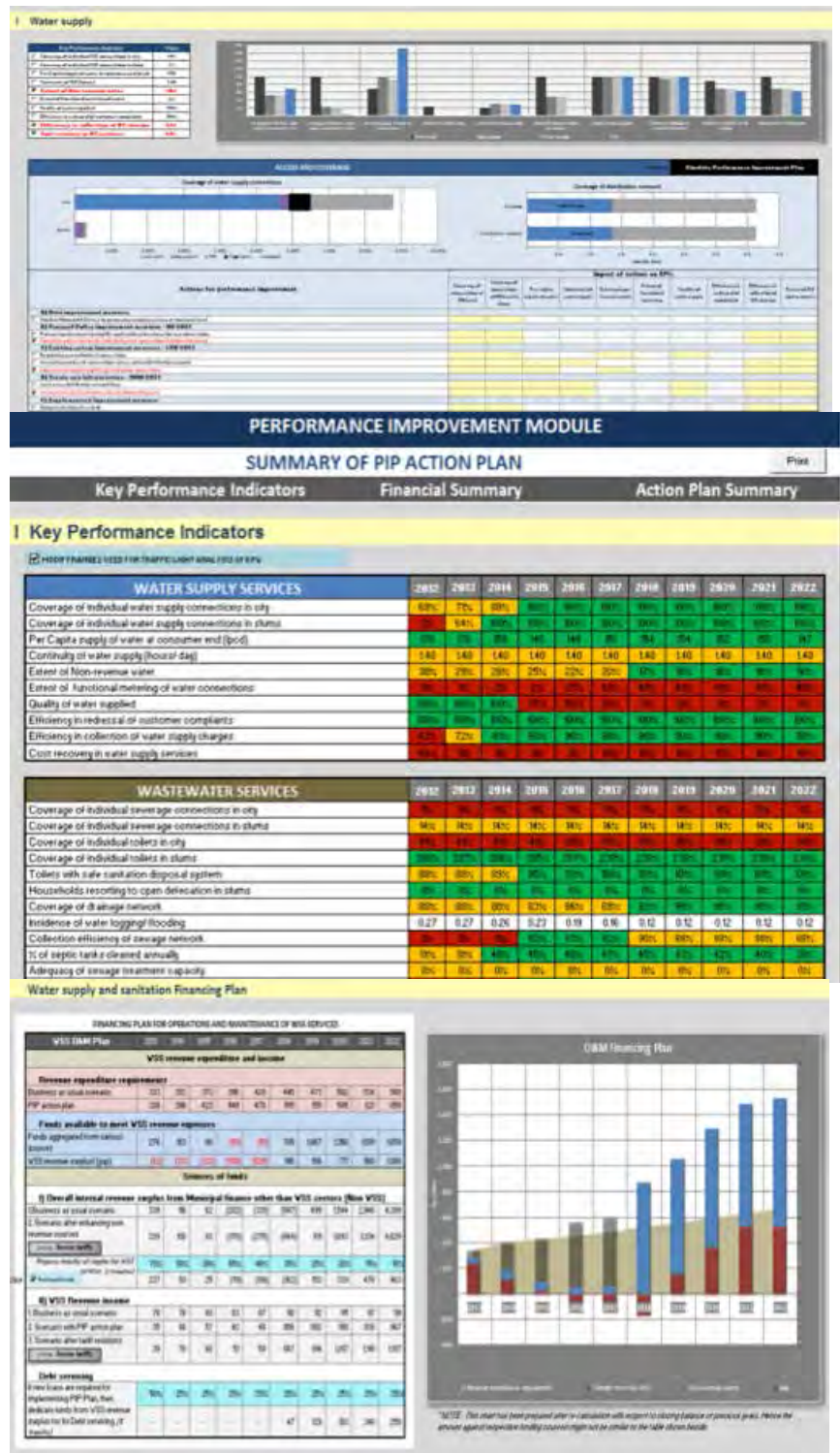

PAS is being implemented by CEPT University in partnership with Urban Management Centre (UMC), Ahmedabad and All India Institute of Local Self-Government (AIIILSG), Mumbai. To know more about the PAS Project, please visit [www.pas.org.in](http://www.pas.org.in) (Tele: +91-79-26302470, Fax: +91-79-26302075) or write to CEPT University ([pas@cept.ac.in](mailto:pas@cept.ac.in)) or AIIILSG ([contact@aillsg.org](mailto:contact@aillsg.org)) or UMC ([info@umcasia.org](mailto:info@umcasia.org)).

## Sanitation Initiatives under PAS Project

PAS Project promotes a city-wide approach based on the full value chain for sanitation planning. This approach and its applications are illustrated through support for City Sanitation Planning for small towns in India. Specific support under the Project is also being provided to cities in achieving an Open Defecation Free (ODF) status. In addition, studies have also been initiated to understand policy provisions, regulations, institutional mechanisms and market opportunities that govern and manage On-site Sanitation solutions.

### Framework for City-wide Sanitation Assessment and Planning

PAS Project has developed a framework for city-wide assessment of sanitation. Unlike usual approaches that focus on excreta management, PAS approach incorporates management of grey water, storm water and solid waste. The framework is used to derive a more comprehensive sanitation ladder to assess cities. The framework also enables planning and investment decisions.

### City Sanitation Improvement Plans and Open Defecation Free City Plans

Plans have been prepared for small towns through several consultative workshops with key stakeholders.

### On-site Sanitation Studies

A number of studies have been initiated to understand governance and institutional aspects of on-site sanitation.

### Innovative Financing in Sanitation

Sanitation improvement in cities in developing countries is largely dependent on grants from donors and governments. Innovative financing approaches that can leverage public funds are being explored.



To know more about the PAS Project, please visit [www.pas.org.in](http://www.pas.org.in) (Tele: +91-79-26302470, Fax: +91-79-26302075) or write to CEPT University ([pas@cept.ac.in](mailto:pas@cept.ac.in)) or AILSG ([contact@aillsg.org](mailto:contact@aillsg.org)) or UMC ([info@umcasia.org](mailto:info@umcasia.org)).

#### Dhruv Bhavsar

Research Associate, PAS Project  
 CEPT University, Ahmedabad-380009, Gujarat, India  
 M: +91 922 72 30713 | O: +91 79 26302470 ext: 467  
[planeerdhruv@gmail.com](mailto:planeerdhruv@gmail.com) | [www.pas.org.in](http://www.pas.org.in)  
[f fb.com/pas.cept](https://www.facebook.com/pas.cept) | [in linkedin.com/in/pascept](https://www.linkedin.com/in/pascept)

#### Maitri Patel

Research Associate, PAS Project  
 CEPT University, Ahmedabad-380009, Gujarat, India  
 M: +91 93 77 203015 | O: +91 79 26302470 ext: 467  
[maitree.patel@gmail.com](mailto:maitree.patel@gmail.com) | [www.pas.org.in](http://www.pas.org.in)  
[f fb.com/pas.cept](https://www.facebook.com/pas.cept) | [in linkedin.com/in/pascept](https://www.linkedin.com/in/pascept)



## A Platform for Integrated Sanitation Investment Planning:

### Proof-of-Concept

The pace and nature of urbanisation in India present a significant challenge for Urban Local Bodies (ULBs) to effectively service the needs of the urban population. As a result of inappropriate planning and management, infrastructure has not been able to keep up with the demands of the growing urban population. Most cities in India are currently facing an infrastructure gridlock. In this scenario, poor sanitation and its effects on the spread of diseases and pollution cannot be neglected.

In order to address the current and future sanitation needs of cities, the sanitation research community recognises the need for a portfolio approach to sanitation emphasising the importance for decision makers to think beyond networked sewer systems to non-networked decentralised/on-site solutions.

In this context, CSTEP is developing a Proof-of-Concept (PoC) decision support tool to facilitate an integrated approach to the sanitation investment planning process for urban local bodies in India. This “tool”- seeks to address the above challenges by enabling users to understand and improve the sanitation situation of a city/ward. This will be facilitated through an interactive visual interface which will allow a comparison of existing and new sanitation systems. The user will be able to choose the system for targeted households. The costs and benefits of the systems will be evaluated by a set of performance indicators. Benefits to environment, health and society will be indicated while costs of each system, including time costs on health and environment (due to unavailability of a system) will also be assessed.

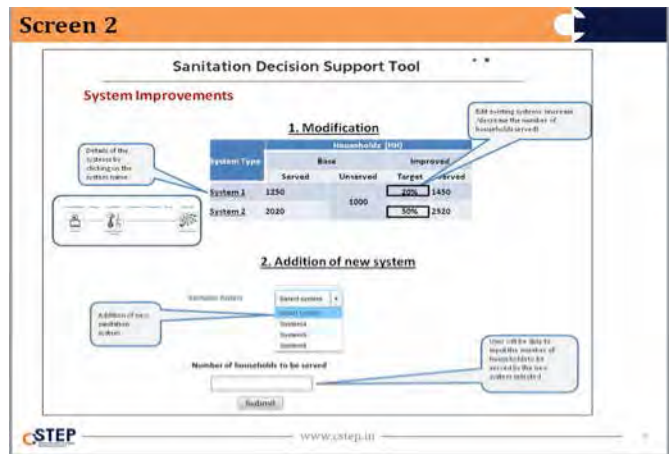
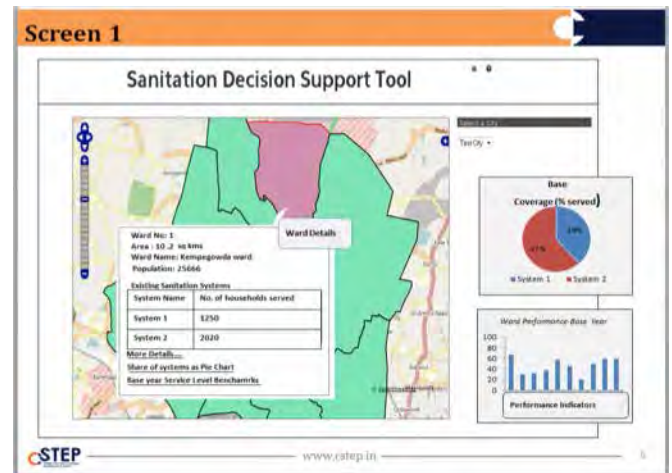

## Key Features of the decision support tool

- GIS enabled user interactive interface for the sanitation system planning for a city
- Allow decision-makers to enter various inputs and examine its impact on the performance of the sanitation system
- Allow assessment of the impact of various sanitation systems
- Facilitate collaboration and consultation with the partners, stakeholders and decision-makers within this sector
- Allow comparison of the cost/benefits of various systems options for sanitation.



## How does the system work?

<b>Ward</b>	<ul style="list-style-type: none"> <li>• Population</li> <li>• Soil type</li> <li>• Topography</li> <li>• Water supply</li> <li>• Groundwater table</li> <li>• Land availability</li> <li>• Susceptibility to natural disasters</li> <li>• Average household income range</li> </ul>
<b>System - Cost</b>	<ul style="list-style-type: none"> <li>• CAPEX components</li> <li>• OPEX components</li> <li>• Other costs</li> </ul>
<b>System – Technology specific</b>	<ul style="list-style-type: none"> <li>• Frequency of maintenance</li> <li>• Type of maintenance</li> <li>• Applicability of service</li> <li>• % skilled labour</li> <li>• Energy requirement</li> <li>• Water requirement</li> </ul>
<b>System – Input water quality</b>	<ul style="list-style-type: none"> <li>• BOD</li> <li>• COD</li> <li>• TKN</li> <li>• TDS</li> <li>• Turbidity/TSS</li> <li>• pH</li> <li>• Pathogen concentration</li> </ul>

## What are other key features of note?

<b>Accessibility</b>	<ul style="list-style-type: none"> <li>• Households served</li> <li>• Extent of Service (Adequacy)</li> <li>• Households having toilets</li> <li>• Households connected to sewage network</li> <li>• Time required for operation of system</li> </ul>
<b>Environment</b>	<ul style="list-style-type: none"> <li>• Water Use</li> <li>• Energy Use</li> <li>• Organic Loading</li> <li>• BOD/COD</li> <li>• TSS</li> <li>• Safe Disposal</li> </ul>
<b>Social</b>	<ul style="list-style-type: none"> <li>• Willingness To Pay</li> <li>• Acceptability/Satisfaction</li> <li>• Affordability</li> <li>• % Skilled labour required</li> </ul>
<b>Costs/Revenue</b>	<ul style="list-style-type: none"> <li>• CAPEX (Tangible)</li> <li>• OPEX</li> <li>• Septage Cost Recovery</li> <li>• Potential of Cost Recovery</li> </ul>
<b>Health</b>	<ul style="list-style-type: none"> <li>• Pathogen concentration</li> </ul>



The tool will allow comparison of the performance indicators before and after the improvements (system wide)



**Sujaya Rathi**  
Principal Research Scientist

10th Cross, Papanna Layout, Mayura Street, Nagashettyhalli  
RMV II Stage, Bangalore-560094, Karnataka, INDIA  
E: sujaya@cstep.in  
www.cstep.in



## Scaling City Institutions for India: Sanitation (SCI-FI: Sanitation)

**SCI-FI:** Sanitation is an initiative at the Centre for Policy Research, New Delhi which aims to inform and support the formulation and implementation of the Government of India's urban sanitation programmes and investments and State government urban sanitation policies/ programs to be output based and proactively supportive of alternative technologies and service delivery models, leading to increased access to safe and sustainable sanitation in urban areas.

### This is structured into four components:

**BOTTOM-UP REVIEW:** To research at the Household, Community and City level to review the local capacity, political economy and reform appetite in two selected states and two cities (Udaipur in Rajasthan and Balasore in Odisha) – lessons from field to be taken into account when designing national/state programs. Research to cover, behaviour aspects of sanitation, perceptions, institutional accountability, project impacts etc.

**TOP DOWN ANALYSIS:** To analyse the lessons from the implementation of relevant National and State policies and public investment programs (eg. JNNURM, NBA, NRHM) and review their implications for scaling up urban sanitation efforts.

**UNDERSTANDING SECTOR SPECIFIC ISSUES (ECONOMIC AND TECHNICAL):** To investigate sector specific issues such as technology, market structure, costs, design implications, user needs and service provider concerns to better understand the challenges facing the adoption of the range of sustainable options in local contexts.

## Knowledge Management and Dissemination:

To generate and support a platform for consultative processes in at least one state/city and to disseminate research outputs to stakeholders aimed at sensitising the central, state and select local governments on challenges of scaling up a public investment focused on urban sanitation.

The first three components look at different aspects of urban sanitation, to develop a well-rounded picture of issues that concern policymaking in the sector. The fourth component is around the engagement process with local, state and national governments and knowledge management and dissemination of lessons / analysis from the research.

### The project focuses on informing innovation in city institutions and service delivery models to support the National Urban Sanitation Policy (NUSP) vision:

*"All Indian cities and towns become totally sanitized, healthy and liveable ... with a special focus on hygienic and affordable sanitation facilities for the urban poor and women".*



**Mr. Shubhagato Dasgupta**  
Senior Fellow

Centre for Policy Research  
Dharam Marg, Chanakyapuri  
New Delhi – 110021 (India)  
P: 26115273-76  
E: shubhagato@cprindia.org  
www.cprindia.org



# Climate Foundation, Cornell University, Sanergy, Tide Technocrats, and the Prasino Group

## Conversion of human waste into biochar using pyrolysis at community-scale facility in Kenya

Climate Foundation is developing a community-scale sanitation reactor designed to convert human waste into biochar without the use of external water or electricity. Biochar is a high quality form of charcoal with energy value as a smokeless fuel and agricultural value as a fertilizer substrate. The reactor is being developed to operate at an existing waste disposal facility run by project field test partner, Sanergy. Trials are targeted to start in Nairobi, Kenya in the second half of 2014.

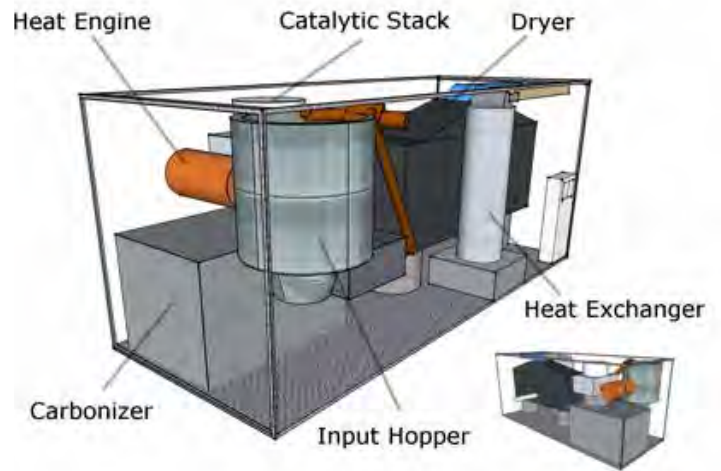

### A bit of detail

The prototype is intended to process several hundred kilograms of human fecal matter and cover material per day. The prototype includes a dryer, a carbonizer, and waste treatment. Field and laboratory analysis of Sanergy fresh fecal waste has been performed to determine the system performance and energy balance.

A belt dryer brings the waste from high to low moisture content. The dryer utilizes thermal energy from the carbonizer for drying. The dryer requires electricity for fans and motors. Electrical generation from waste heat is demonstrated as part of the prototype.

The dried waste enters the carbonizer. In a rich burn phase, the carbonizer converts the dried waste into pyrolysis by-products, biochar, and heat. As with a smoking bonfire, the tars and particulates of the pyrolysis by-products are carried in a thick smoke within the reactor. Biochar (or charcoal) is created during the rich burn and is extracted from the carbonizer. A subsequent combustion phase performs a lean burn on this smoke using a catalyst. The catalyst ensures clean emissions and high temperatures that are used for the generation of electricity and for heating in the dryer. The high temperature gas provides thermal energy for a heat engine; the engine's electrical output powers the reactor system and the engine waste heat is recovered by the dryer.

A carbon filter removes odors from the dryer exhaust gases. Waste water is processed prior to external use. A control system balances the operation of components within the system to optimize power generation and biochar output. The prototype demonstrates a wirelessly accessible control system for remote monitoring and diagnostics. Major system outputs are biochar, water, water vapor, ash, and carbon dioxide.

### Key Features

#### Pathogen Treatment Success

#### Complete pathogen elimination

Capital Cost \$60,000 – 100,000 USD

Daily Operating Cost \$0.03 /user/day

System Life Expectancy 10 years

Water/Fertilizer/ Energy creation/capture

Water for reuse: 50 l/ hour

Fertilizer: Biochar, approx. 10 g/user

Energy generated: 1-3 kWh thermal/day, for external use

Business Opportunity

Service charge from waste processing, Fertilizer Revenues, Energy Source

# Climate Foundation, Cornell University, Sanergy, Tide Technocrats, and the Prasino Group

## How does the system work?

Are chemical processes used?	No
Are mechanical processes used?	Yes
Are biological processes used?	No
Does the system require the use of water?	No
Does the system require an external source of electricity?	No
Does the system use any other "consumable" materials?	Steady state operation does not require other consumables
Does the system require any off-site waste processing?	No
Does the system require any waste to be dumped in adjacent soil?	No

## What are other key features of note?

What is the current status of the system?	System demonstrated in a laboratory environment.
What technical challenges remain?	1. Energy-positive operation 2. Robust operation in field conditions 3. Waste water conditioning and treatment
What is the estimated capital cost of the system?	\$60,000 – 100,000 USD
What is the system life expectancy?	10+ years
How many users can the system accommodate?	2,000 – 4,000 users/day
What is the estimated daily operations cost per user?	\$0.03/user/day
How much energy will be recovered?	1 – 3 kWh thermal/day
How much usable water will be recovered?	50 l/hour
How much fertilizer will be produced or recovered?	30 kg/day
What is the estimated business opportunity or revenue potential?	Service charges to users and sales of biochar into agricultural and energy markets



**Brian Von Herzen**  
Executive Director, Climate Foundation

Climate Foundation  
135 Pasa Robles Ave.  
Los Altos CA 94022P: 775-790-5000  
E: [brian@climatefoundation.org](mailto:brian@climatefoundation.org)  
[www.climatefoundation.org](http://www.climatefoundation.org)



## The Nano Membrane Toilet

Cranfield University is developing the Nano Membrane Toilet, designed for single-household use (equivalent to 10 people). The toilet is designed to accept urine and feces as a mixture. The toilet flush uses a unique rotating mechanism to transport the mixture into the toilet without demanding water whilst simultaneously blocking odor and the user's view of the waste.

Solids separation (feces) is principally accomplished through sedimentation. Loosely bound water (mostly from urine) is separated using low glass transition temperature hollow-fibre membranes. The unique nanostructured membrane wall facilitates water transport in the vapor state rather than as a liquid state which yields high rejection of pathogens and some odorous volatile compounds. A novel nano-coated bead enables water vapor recovery through encouraging the formation of water droplets at the nanobead surface. Once the droplets form a critical size, the water drains into a collection vessel for reuse at the household level in washing or irrigation applications.

Following release of unbound water, the residual solids (around 20-25% solids) are transported by mechanical screw which drops them into a coating chamber lined with a replaceable bag. Once inside the coating chamber, the solid matrix is periodically coated with a biodegradable nano-polymer. The nanopolymer coating serves to block odor and acts as a barrier to pathogen transport. The toilet will be powered using a modular hand crank or bicycle power generator supplied for household use that can also power other low voltage items (e.g. mobile phones).

The replaceable bag comprising the coated solids is periodically collected for transport to a locally sited small scale gasifier sized to accommodate around 40 toilets. Both toilet maintenance and solids collection will be undertaken with a trained operative responsible for the franchised area.



### Key Features

#### Pathogen Treatment Success

**Pathogen free water/  
Pathogens retained  
within coated solids.  
Final pathogen kill  
with gasification.**

Daily Operating Cost

\$0.05 – 0.10/user/day

Water/Fertilizer/ Energy  
creation/capture

Water for reuse:  
1.5L/user/day

Fertilizer:  
1g/user/day

Energy generated:  
90Wh/user/day

Business Opportunity

Franchise business to  
service the toilet for a  
regular fee.

## How does the system work?

<b>Are chemical processes used?</b>	Yes, biodegradable polymer for solids coating
<b>Are mechanical processes used?</b>	Yes, a mechanical screw for solids transport
<b>Are physical processes used?</b>	Yes, a low glass transition membrane for dewatering
<b>Does the system require the use of water?</b>	No.
<b>Does the system require an external source of electricity?</b>	No, electricity is generated by a hand crank or bicycle generator.
<b>Does the system use any other “consumable” materials?</b>	Yes, biodegradable polymer (membrane and bead will need servicing)
<b>Does the system require any off-site waste processing?</b>	Yes, dewatered sludge is processed in a gasifier
<b>Does the system require any waste to be dumped in adjacent soil?</b>	Ash waste from the gasifier will be produced and will need to be properly disposed

## What are other key features of note?

<b>What is the current status of the system?</b>	System components have been validated in a laboratory environment
<b>What is the system life expectancy?</b>	7-14 years
<b>How many users can the system accommodate?</b>	1-10 users
<b>What is the estimated daily operations cost per user?</b>	\$0.05 – 0.10 /user/day
<b>How much energy will be recovered?</b>	90Wh/user/day
<b>How much usable water will be recovered?</b>	Approx. 1.5L/user/day
<b>How much fertilizer will be produced or recovered?</b>	1g/user/day



The works-like prototype processing synthetic urine and feces.

**Cranfield**  
UNIVERSITY

**Alison Parker**  
Lecturer in International Water and Sanitation

Cranfield University  
Cranfield  
Bedfordshire  
MK43 0AL  
+44 1234 750111  
a.parker@cranfield.ac.uk  
www.nanomembranetoilet.org

# Defence Research Laboratory, DRDO, Indian Ministry of Defence

## DRDO Biotoilet

Defence Research Laboratory (DRL) has developed human fecal matter biodegradation technology that comprises of a specially designed anaerobic tank (biotank) and a natural secondary treatment bed (reed bed) for effluent water. A highly efficient microbial consortium digests human fecal matter into colorless, odorless gases and effluent water that is safe to reuse for flushing, gardening etc.

The technology has various advantages:

- Eco-friendly, appropriate & affordable
- Simple, easily adoptable design and construction
- Customized for individual family or community level
- Wide application under different climatic conditions
- Smaller size than conventional septic tank
- Maintenance free (in terms of sludge cleaning)
- Minimizes water consumption
- Reduction in organic waste & pathogen by 99%
- Generation of biogas, that can be harnessed
- Reduced load on sewage system

## Prototype Presentation

DRL will present a toilet prototype and the treatment system. Treatment tank will comprise of a Biotank where raw sewage (fecal matter) will be digested and the effluent water from the tank will again be treated using reed bed, a natural filtration bed. Water after the reed bed treatment can be collected for further use. Stored water can be pumped to overhead tank (solar power may be used) for using the water for flushing.

## Research Areas

Design of tanks and reed bed

Development of efficient microbial consortium

Effluent water decontamination

Water reuse to reduce water loss.



## Key Features

**Pathogen Treatment Success** Yes

Capital Cost \$700 (household)

Daily Operating Cost \$0.05/user/day (if electricity is used)

Water/Fertilizer/ Energy creation/capture  
Water for reuse: Yes  
Fertilizer: No  
Energy Creation: Yes

Energy generated  
Biogas may be harnessed

Business Opportunity  
Considerable percentage of Indian sanitation market (approx 4500 Crores INR)

# Defence Research Laboratory, DRDO, Indian Ministry of Defence

## How does the system work?

Are chemical processes used?	No
Are mechanical processes used?	No
Are biological processes used?	Yes
Does the system require the use of water?	Yes
Does the system require an external source of electricity?	No
Does the system use any other “consumable” materials?	No
Does the system require any off-site waste processing?	No
Does the system require any waste to be dumped or infiltrated in adjacent soil?	No

## What are other key features of note?

What odor control measures are included?	Generation of odor is less from the system, however, common P-trap is sufficient for odor control at toilet
What is the current status of the system?	Technology is being implemented throughout India; Technology has been transferred to various companies including Eram Scientific.
What is the estimated capital cost of the system?	Household level (max 6 users): 700USD with treatment system and single toilet (super structure). Price may increase according to the volume of the treatment tank and number and quality of super structure.
What is the system life expectancy?	> 30 yrs
What is the expected daily user cost?	0.05USD
How much energy will be recovered?	Biogas may be harnessed
How much usable water will be recovered?	80%
How much fertilizer will be produced or recovered?	Nil
What is the estimated business opportunity or revenue potential?	0.08 USD/ day/ user may be recovered from community based toilet and advertisement.



The flow diagram represents the complete cycle of our system. The fecal matter enters to Biotank through inlet pipe. After biodegradation and secondary treatment, water may be stored for reuse. Background photo: installed system at DRL gate where reuse of water for flushing is done.

“ECO-FRIENDLY, APPROPRIATE &  
AFFORDABLE SANITATION FOR ALL”



Defence Research Laboratory, DRDO

Dr Vijay Veer  
Director

Defence Research Laboratory, DRDO  
Ministry of Defence  
Post Bag 2, Tezpur 784001  
Assam, India  
P: +91 3712 258836  
E: director\_drl@yahoo.com



## Sanir: Upgrading human waste with plasma-driven gasification

As part of the Omni-Processor development program, Delft University of Technology is developing a processing facility and a related Community Sanitation Centre. The processing facility consists of a Microwave Plasma Gasification process to generate electricity out of dried feces which is fed into the gasifier.

This is an efficient method to get rid of large amounts of feces, while at the same time generating enough electricity and heat to make the system self-supporting; indeed, possible surplus of energy can be used to provide additional services to the community. Other resources that can be recovered out of the collected human waste, which is converted into a disinfected ash, are nutrients such as phosphate, which is a valuable fertilizer.

Water at the Sanitation Centre will be purified and recycled so that it can be reused for hand washing and anal cleansing.

Ultimately, this concept is a fully stand-alone entity that has no electric utility connection, no (heavy) reliance on piped-in water and no connection to any type of sewerage.

The business model that is developed around the recovered resources and other revenues allows us to limit capital and operational costs to less than \$0.05 per person per day.

## Delhi Fair Presentation

Our solution aims at processing the urine and feces of multiple toilets or toilet groups. The exhibit demonstrates all steps of the process:

- A. Toilet with diverting water/feces facilities
- B. Sanitation Centre with gender specific facilities
- C. Recycling of water at Sanitation Centre
- D. Transport of feces from Centre to mini-factory
- E. Drying of the urine and feces
- F. Plasma gasification of dried urine/feces
- G. Conversion of gas into electricity in a fuel-cell



## Key Features

### Pathogen Treatment Success

### Total pathogen elimination achieved

Capital Cost

Treatment facility:  
US\$ 325,000 – 425,000

Sanitation Centre:  
US\$ 15,000 – 20,000

Daily Operating Cost

<\$0.01-<\$0.02/user/day (treatment)  
<\$0.04-<\$0.06/user/day (sanitation)

Water/Fertilizer/ Energy creation/capture

Water for reuse:  
2,000L per day  
Fertilizer: 91 tons of ash/fertilizer per year  
Energy generated:  
0.06 kWh/user/day

Business Opportunity

Revenues from user fees, micro insurance fees, advertisements, store franchising, energy, fertilizer

## How does the system work?

<b>Are chemical processes used?</b>	Yes; several processes, including plasma gasification, and electrochemical fuel oxidation are included.
<b>Are mechanical processes used?</b>	Yes; water pumps, the LaDepa belt dryer, and heat exchangers are some of the mechanical processes involved.
<b>Are biological processes used?</b>	Yes; there is a biological layer in the sand filter used in the purification process.
<b>Does the system require the use of water?</b>	Yes, for flushing and hand washing; much of the water need will be met by internal recycling processes.
<b>Does the system require an external source of electricity?</b>	No; the system is designed to ultimately meet all of its own electrical needs.
<b>Does the system use any other “consumable” materials?</b>	Low quantities of: Sand (filtration grey water) Adsorbents for gas cleaning
<b>Does the system require any off-site waste processing?</b>	No.
<b>Does the system require any waste to be dumped in adjacent soil?</b>	No.

## What are other key features of note?

<b>What is the current status of the system?</b>	System demonstrated in a laboratory environment
<b>What is the estimated capital cost of the system?</b>	Sanitation Centre: US\$ 15,000 – 20,000 Treatment Facility US\$ 325,000-375,000
<b>What is the system life expectancy?</b>	7.5-10+ years
<b>How many users can the system accommodate?</b>	Sanitation Centre: 400 u/d Treatment: 50,000 u/d
<b>What is the estimated daily operations cost per user?</b>	Sanitation + Treatment \$0.05 - \$0.08 /user/day
<b>How much energy will be recovered?</b>	900kWh/day
<b>How much usable water will be recovered?</b>	2000L/day
<b>How much fertilizer will be produced or recovered?</b>	91 tons ash-fertilizer/year
<b>What is the estimated business opportunity or revenue potential?</b>	Sanitation Centre Revenues: user fees, micro-insurance fees, advertisements, store franchising Treatment Revenues: sale of energy, ash-fertilizer



Delft University of Technology – Model of the Community Sanitation Center.

## APNA SANIR: UPGRADING HUMAN WASTE WITH PLASMA DRIVEN GASIFICATION

**Dr. Ir. J.C. Diehl**  
Industrial Design Engineering

Delft University of Technology  
j.c.diehl@tudelft.nl  
+31 6 14015469

**Dr. P.V. Aravind**  
Process and Energy Department

Delft University of Technology  
p.v.aravind@tudelft.nl  
+31 6 11702061



## “Soch”alaya – The Thinking Toilets

In the summer of 2013, the faculty and students at the Department of Industrial Design at SPA Delhi embarked on an initial survey to discover how sanitation in our country fails at every level possible. Across the country our railway tracks become equivalent to bathrooms for many. In our cities well-intentioned Public Toilets for women become virtually non-existent, as they remain locked for concerns of “safety”. Huge water wastage occurs where there is seemingly plenty and in urban slums as many as six dozen families may share a single toilet, if there is any. Even in our own homes, the toilet becomes hostile to the elderly and disabled.

A tremendous opportunity exists for Design to improve quality of life, preserve the environment, reduce disease and uphold human dignity. And for the ‘world’s largest democracy’, which presently ranks 136 on the United Nations Human Development Index, this neglected area calls attention to India’s priorities concerning development.

## Project “Soch”alaya

With this mandate, the Design Studio at ID, SPA with its 19 students began Project “Soch”alaya or “The Thinking Toilets” and spent 10 weeks addressing diverse domains and reinventing the Toilet and designing Sanitation Systems by means of extensive research, analysis, design and testing by mockup development.

Thus came about Public Toilets for Coastal Areas that harness wind energy, use local materials and finally use human waste as a resource, Domestic Toilets for waterlogged areas that provide a solution at site using a system of recyclable plug-in units.

Responding to the needs of 1/3rd of the world’s population affected by motor disabilities that resides in India, an Inclusive Washroom that allows access to all and a Wheelchair that eases transfer to the toilet seat independently in public areas was designed.

A running water free, low cost toilet for slum squatters was evolved, as well as one that is a Transition-ary solution for migrant population that is caught in a lifestyle where habits of open defecation acquired in rural areas cannot be practiced anymore and tiny latrines are all that is available. In these scenarios, women, children and elderly become particular sufferers, so the study led to the design of a Portable urinating unit to be used indoors.

Also taken up were areas like “chawls” where a large number of people share the same overburdened toilet facility and there is lack of ownership, so washrooms

were evolved with self-regulating mechanisms for cleaning and maintenance. Efficiency was maximized by multiplying the space utilization and minimizing the toilet footprint in LIG housing scenarios too. For mass gatherings like the Kumbhmela where an estimated 1.8 million visited everyday an organised semi-open defecation system and Easy deployable, single -operation cleaning toilet modules for Melas and Weekly markets.

Hygiene and Safety became the primary concerns while designing Public Toilets for Women that were designed for “minimal contact” and ease of identification. Taking this further, Women’s Urinals that integrate with Bus Shelters were also designed.



## Key Projects / Areas

- Public Toilet for Coastal Areas
- Domestic Toilet for Waterlogged Areas
- Inclusive Toilet for the Home environment
- Wheelchair redesign to facilitate ease of use of the WC
- A transition-ary toilet for EWS squatters
- Emergency Toilet for Indoor Purposes in Slum Squatters
- Common Toilets for multiple EWS Families
- Minimising the toilet area footprint in LIG Housing
- Organised semi-open defecation system
- Easy and Quick install Toilet Modules for mass gathering
- Public Toilet for Women with a focus on Safety
- Minimal Contact Public Toilets for Women
- A system to make independent & learn the importance and process of washing hands
- Redesign of the WC for Pre-Schools
- Urinals for Bus Shelters for both genders.
- Integrated toilet system to minimise water and electricity consumption
- Resource optimising High efficiency bathroom

# Department of Industrial Design, SPA Delhi

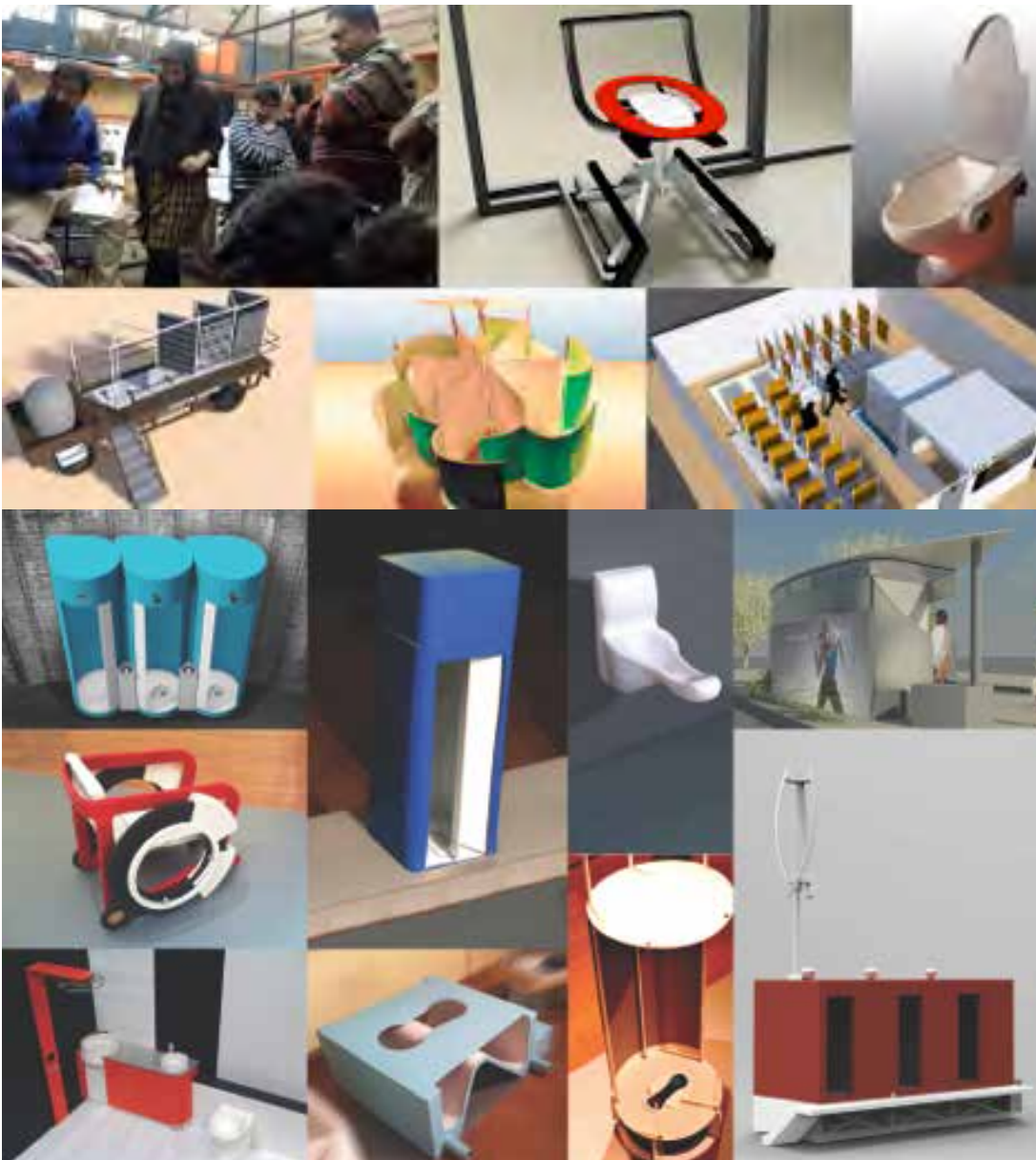

*"Soch" alaya: The Thinking Toilets*

For children in the age group of 2-6, in pre-school, where toilet training and the basics of hygiene are learnt, a hand-wash system and WC that makes independent and promotes the importance of hygiene were designed. Hi Tech and efficiency responsive Washroom emerged from the need to address people's habits and inefficient systems to discourage resource consumption while improve the washroom experience.

The attempt of this exercise was to knit together understanding of human behaviour, habits, our diverse social-cultural contexts, economic considerations and advancement in technology to arrive at design interventions that address areas in sanitation and hygiene which are peculiar and specific to our context.



**School of Planning  
and Architecture**  
New Delhi

**Parag Anand**

Associate Professor of Industrial Design  
Aditi Singh  
Assistant Professor of Industrial Design

6, Block B, Indraprastha Estate  
New Delhi, India 110 002  
P: +91-11-2370 2392  
E: aditi.post@gmail.com / paraganand@spa.ac.in  
www.spa.ac.in



## Anaerobic Digestion-Pasteurization System

Duke University will exhibit its waste treatment system in conjunction with Eram Scientific Solutions' eToilet. The Duke Phase I project is based on the vision that effective sanitation can be accomplished through the treatment of human waste in an anaerobic digester, followed by heat sterilization of the treated effluent in a novel heater/heat recovery system powered by the biogas produced by the anaerobic digester. The target application and focus of the research during Phase I was household or extended household as a replacement for pit latrines. For the toilet fair, the design will be adapted and integrated with Eram's eToilet. The treatment system is self-contained, requires no external energy input, destroys pathogens and provides a safe effluent with fertilizer value.

Treatment relies on anaerobic digestion which converts the wastes from the toilet to biogas (i.e., methane + CO<sub>2</sub>). No urine diversion, separation or other preprocessing of the waste is needed. Some of the biogas is then combusted in a special heater-heat exchanger system which pasteurizes the effluent from the digester, thereby providing a pathogen-free effluent, safe to be discharged. The liquid can be used for irrigation as it has fertilizer value. Desludging frequency of the digester has not yet been determined, but is low; our lab unit has not required desludging in over a year and a half.

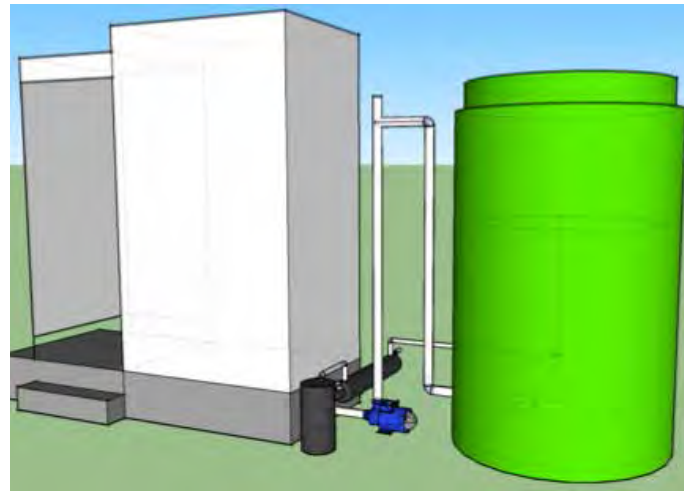

*Duke add-on: anaerobic digester, heater and heat exchanger and ancillary equipment (right) attached to the back of the eToilet (left).*

### Key Features

#### Pathogen Treatment Success

**>6 log reduction of pathogen achieved**

#### Capital Cost

Treatment system only - \$1000 USD (25 users)

Treatment and basic toilet superstructure - ~\$1500 (25 users)

#### Daily Operating Cost

Treatment only - \$0.02/user/day

Treatment & structure - \$0.03/user/day

#### Water/Fertilizer/Energy creation/capture

Water for reuse: TBD

Liquid fertilizer: Yes, with N content of ~4-7g /user/day

Energy generated: Excess biogas ~5-20 L/user/day

#### Business Opportunity

Potential sale of energy and fertilizer

## How does the system work?

<b>Are chemical processes used?</b>	No.
<b>Are mechanical processes used?</b>	Yes, the design uses a biogas powered heater coupled to a tube and shell heat exchanger to heat sterilize the treated waste leaving the digester.
<b>Are biological processes used?</b>	Yes, bacteria in the anaerobic digester convert the organic wastes (feces and urine) into biogas.
<b>Does the system require the use of water?</b>	No.
<b>Does the system require an external source of electricity?</b>	No.
<b>Does the system use any other "consumable" materials?</b>	No.
<b>Does the system require any off-site waste processing?</b>	No.
<b>Does the system require any waste to be dumped in adjacent soil?</b>	Yes, effluent liquid can be used as fertilizer or can be infiltrated.

## What are other key features of note?

<b>What is the current status of the system?</b>	Three systems are operational in Eldoret, Kenya
<b>What is the estimated capital cost of the system?</b>	~\$600 USD for 10-20 users. \$1000 USD for 25 users.
<b>What is the system life expectancy?</b>	20+ years
<b>How many users can the system accommodate?</b>	10-30, scalable.
<b>What is the estimated daily operations cost per user?</b>	25 users - \$0.02, or \$0.03 including superstructure. 10 users - \$0.04
<b>How much energy will be recovered?</b>	Excess biogas up to 20 L user/day.
<b>How much usable water will be recovered?</b>	TBD. A post-digester treatment is being developed for this purpose.
<b>How much fertilizer will be produced or recovered?</b>	7 g/person/day (N)
<b>What is the estimated business opportunity or revenue potential?</b>	TBD. Opportunities with fertilizer and excess biogas being explored.



One of the three complete system and superstructure deployed in Eldoret, Kenya (left) and contained treatment system below (right). Each system comprises of three toilets, one anaerobic digester, and one heat sterilization system. All systems are self-contained.



**Marc Deshusses**  
Professor of Civil & Environmental Engineering

121 Hudson Hall  
Box 90287  
Durham, NC 27708  
919-660-5480  
marc.deshusses@duke.edu  
www.sanitation.pratt.duke.edu

# Duke University and the University of Missouri

## Neighborhood-Scale Treatment of Sewage Sludge by Supercritical Water Oxidation

The Duke University / University of Missouri RTTC team is utilizing the potential of Supercritical Water Oxidation (SCWO) for the treatment of sewage sludge. The team is designing and building an Omni-Processor prototype unit that fits into a 20 ft. shipping container and will treat the waste produced daily by about 1200 users.

Supercritical water and oxygen are fully miscible, making it a flexible and unique medium for oxidation.

**At supercritical water conditions, all organics in the sewage are converted to clean water, energy and carbon dioxide within seconds.**

SCWO is a very fast process that relies on high pressure and temperature (400-700°C and 250atm). Waste (feces and urine) is compressed, heated and mixed with an oxidant (in this case air) and supercritical water (recycled internally in the process). The high pressure and temperature promote rapid conversion of the organics in the waste. Clean water, CO<sub>2</sub> and excess energy are released. All pathogens are destroyed.

Prototype construction is being completed at Duke University. Following initial testing in spring 2014, the unit will be transferred to a local wastewater treatment plant to process sewage in an operational environment. Later, the unit will be moved to a developing country for actual field demonstration.

## Key Features

### Pathogen Treatment Success

### Complete pathogen elimination

Capital Cost

\$300k – \$500k

Daily Operating Cost

\$0.08 – 0.15/user/day

Water/Fertilizer/ Energy creation/capture

Water for reuse: 95% of influent waste volume is recovered

Fertilizer: None

Energy generated: TBD

Business Opportunity

Business models are being developed



# Duke University and the University of Missouri

## How does the system work?

<b>Are chemical processes used?</b>	Yes, the primary process is thermochemical – oxidation at high temperature and pressure
<b>Are mechanical processes used?</b>	No
<b>Are biological processes used?</b>	No
<b>Does the system require the use of water?</b>	No
<b>Does the system require an external source of electricity?</b>	If successfully engineered, no external source of electricity should be needed since electricity is expected to be generated by the process. Early prototypes will require some external electricity.
<b>Does the system use any other “consumable” materials?</b>	No
<b>Does the system require any off-site waste processing?</b>	No
<b>Does the system require any waste to be dumped in adjacent soil?</b>	No

## What are other key features of note?

<b>What is the current status of the system?</b>	System components have been validated in a laboratory environment.
<b>What technical challenges remain?</b>	Complete prototype testing and design improvements, test at a POTW, and field testing
<b>What is the estimated capital cost of the system?</b>	~\$300k-500k USD
<b>What is the system life expectancy?</b>	20 years
<b>How many users can the system accommodate?</b>	~1200 users/day
<b>What is the estimated daily operations cost per user?</b>	\$0.08 – 0.15/user/day (estimate)
<b>How much energy will be recovered?</b>	TBD
<b>How much usable water will be recovered?</b>	95% of wet waste volume will be recovered as usable water
<b>How much fertilizer will be produced or recovered?</b>	None
<b>What is the estimated business opportunity or revenue potential?</b>	TBD

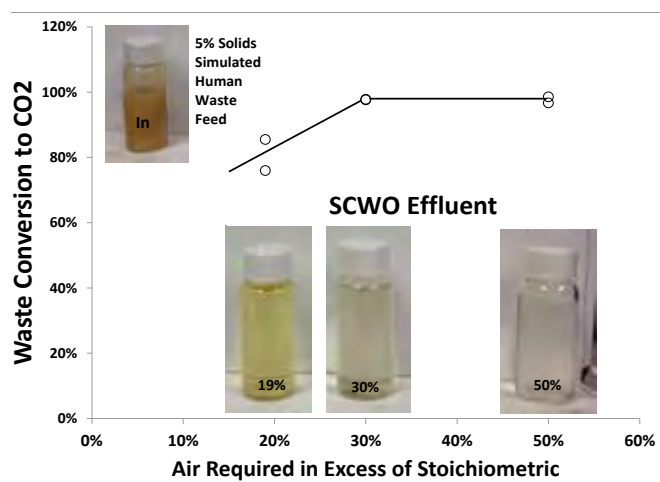

**Marc Deshusses**  
Professor of Civil & Environmental Engineering

121 Hudson Hall  
Box 90287  
Durham, NC 27708, USA  
P: 919-660-5480  
E: marc.deshusses@duke.edu  
URL: sanitation.pratt.duke.edu



# Eawag (Swiss Federal Institute of Aquatic Science and Technology), Design by E00S

## Blue Diversion

Eawag/E00S has developed an attractive grid-free dry diversion toilet, which provides water for flushing, hand washing and personal hygiene (for washers and for menstrual hygiene). Undiluted urine, feces, and flush-and-wash water are collected separately below the pan. The water is treated in a self-cleaning ultrafiltration unit and reused on-site. The toilet features a business model, linking the family scale toilet to a community scale Resource Recovery Plant (RRP) where resources from urine and feces are recovered. The business encompasses the entire sanitation value chain, and constitutes a profitable business opportunity which creates jobs for the local community.

## Delhi Fair Presentation

1. Prototype of the Blue Diversion Toilet. We present a prototype which has been field-tested in Nairobi, Kenya. Advanced, but robust electronics and smart design ensure a comfortable experience for the user despite the simple construction. Large parts of the prototype are industrialized and have been produced by rotational molding. The rest will be industrialized in phase 3. The prototype is equipped with measuring devices, which provide important information about the use of the toilet and the washing facilities during the field tests. This will also be useful for future large-scale pilot projects.
2. Graphical presentation of the urine treatment processes at the Resource Recovery Plant (RRP). Since the RRP is not of a transportable scale, a video of the urine treatment processes will be shown, explaining the function of the urine treatment reactors in operation at Eawag. Many feces treatment technologies suggested by other RTTC grantees fit well in the RRP.
3. Graphical presentation of on-site fertilizer production from urine. This feature will be part of a future Blue Diversion toilet with minimal transport requirements.



## Key Features

### Pathogen Treatment Success

### Complete pathogen removal

Daily Operating Cost:	\$0.037/user/day
Toilet & logistics:	\$0.024/user/day
RRP	\$0.013/user/day
Water/Fertilizer/Energy creation/capture	Recycled for on-site use 90-95 % of all excreted nutrients (at RRP)
Water for reuse:	
Fertilizer:	
Energy generated:	Solar for internal operations (1.5 -2 W/p continuous electrical power).

# Eawag (Swiss Federal Institute of Aquatic Science and Technology), Design by E00S

## How does the system work?

<b>Are chemical processes used?</b>	Yes, water recovery includes the use of electrolysis to remove the urine's color and prevent pathogen regrowth.
<b>Are mechanical processes used?</b>	No.
<b>Are biological processes used?</b>	Yes, water recovery is based on processing the water with a biologically activated membrane reactor.
<b>Does the system require the use of water?</b>	Yes, initially 60 Liters of water and afterwards less than 1 Liter/day to replace lost water.
<b>Does the system require an external source of electricity?</b>	A solar panel is part of the on-site system, providing all required electricity (Target: 60W peak; Present: 105 W peak).
<b>Does the system use any other "consumable" materials?</b>	No.
<b>Does the system require any off-site waste processing?</b>	Yes, urine and feces are processed at the Resource Recovery Plant (RRP)
<b>Does the system require any waste to be dumped in adjacent soil?</b>	No. Full resource recovery.

## What are other key features of note?

<b>What is the current status of the system?</b>	Blue Diversion Toilet: Tested in the field Urine treatment: Demonstrated in the field On-site urine treatment: Demonstrated in the lab
<b>What technical challenges remain?</b>	Urine treatment: field tests On-site urine treatment: de-sign and field testing
<b>What is the system life expectancy?</b>	1 Toilet: 7 – 10 years 2 RRP: 20 years
<b>How many users can the system accommodate?</b>	Toilet: 10 – 12 users RRP : 800 – 1000 users
<b>What is the estimated daily cost per user?</b>	Daily expenditure: \$0.05 covering operational and capital costs
<b>How much energy will be recovered?</b>	Solar energy will be generated for internal use only.
<b>How much usable water will be recovered?</b>	Approximately 75L/day will be returned to the system.
<b>How much fertilizer will be produced or recovered?</b>	90-95 % of excreted total nutrient content will be recovered at RRP (feces and urine).



Transport of the Blue Diversion Toilet during the first field tests in informal settlements in Kampala, Uganda in April 2013. Field-testing of the prototype presented in Delhi is on-going in the Mukuru slum in Nairobi, Kenya.



**“IT SAVES WATER, IT DOES NOT SMELL, IT IS CONVENIENT AS EVERYTHING IS PORTABLE.”**

*(Quote from an interview with a test user in an informal settlement in Kampala, Uganda)*

**Dr. Tove Larsen**

Ueberlandstrasse 133  
PO Box 611  
8600 Duebendorf  
Switzerland  
tove.larsen@eawag.ch  
www.bluediversiontoilet.com

**eawag**  
aquatic research 000

Design by E00S

## eToilet Imperial Model

eToilet (Electronic Public Toilet) - the “Next Generation”, revenue generating sanitation model with a unique ambience. The eToilet makes effective use of Information, Communication and other Engineering technologies for solving major issues of public sanitation, such as lack of cleanliness and lack of adequate manpower support to manage the conventional toilets. These unmanned eToilets with remote monitoring via GPRS enables online tracking of the unit’s health status, usage and income. This feature brings in more transparency and accountability. eToilet, designed with the state-of-the-art technology, comes with these exclusive features:

- Automatic Payment Collection
- Automatic Door Opening
- Alerts to Users
- Display Boards
- Automatic Closet Washing System
- Power Back-up Mechanism
- Water Tank
- GPRS Alerts
- Auto-washing mechanisms for closets and floors
- Pre-flush system
- Automatic after-use power flush
- Water conservation measures
- Solar panel option
- Theft protection features

## Prototype Presentation

Eram will present its Imperial Model integrated with the below project areas and eToilet prototypes in conjunction with Duke University’s anaerobic digestion system and CALTECH’s CLEW.

## Project Areas

1. Automatic Sterilization
2. Power Flushing
3. Water minimization using sensor enabled systems
4. Self-washing and cleaning mechanism
5. Atmospheric Water Generator



Stainless Steel

Mild Steel

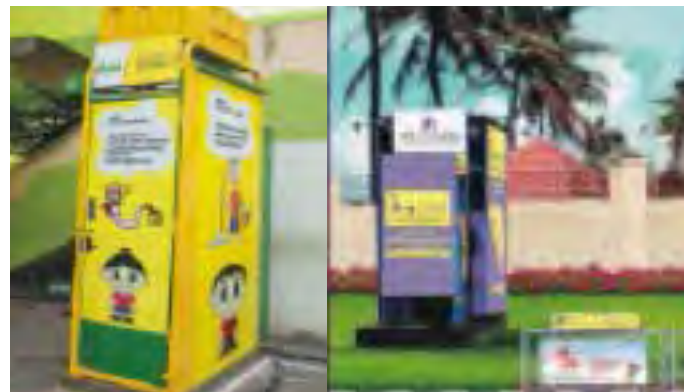

School Model

She Toilet

- 1. Automatic Sterilization-** Automatic sterilization of toilet seat covers with the help of UV and Steam treatment methods.
- 2. Power Flushing-** Pressure assisted vacuum sucking mechanism developed of toilet flushing to minimize the amount of water.
- 3. Water minimization using sensor enabled systems-** Sensor-enabled Controls to conserve water by allowing the amount of water utilized for each flush to be varied and to the minimum.
- 4. Self-washing and cleaning mechanism-** Automatic cleaning of toilet bowls and floor with the help of water injection systems.
- 5. Atmospheric Water Generator:** AWG is a new, state of the art water generating machine which takes moisture out of air and turns it into pure water.

Daily Operating Cost	\$0.05/user/day
----------------------	-----------------

Resource creation/ capture	Water for reuse: up to 250 L/day
-------------------------------	-------------------------------------

# Eram Scientific Solutions Pvt. Ltd.

## How does the system work?

<b>Are chemical processes used?</b>	No.
<b>Are mechanical processes used?</b>	Yes, the eToilet contains mechanical processes like seat sterilization system, Power flushing system etc. The exhibit also requires civil base construction before installation.
<b>Are biological processes used?</b>	No.
<b>Does the system require the use of water?</b>	Yes, water is used for flushing, seat cleansing, and floor washing. eToilet's water needs will be filled by the Atmospheric Water Generator.
<b>Does the system require the use of electricity?</b>	Yes, many of the functions in the eToilet require electricity. Solar panel is an option for an alternate energy source.
<b>Does the system use any other consumable materials?</b>	No.
<b>Does the system require any off-site waste processing?</b>	No.
<b>Does the system require any waste to be dumped in adjacent soil?</b>	No.

## What are other key features of note?

<b>What is the current status of the system?</b>	System demonstrated in an operational environment
<b>What is the system life expectancy?</b>	10-15 years
<b>How many users can the system accommodate?</b>	50-120 users/day
<b>What is the estimated daily operations cost per user?</b>	\$0.05/user/day
<b>How much energy will be recovered?</b>	No energy is generated by the eToilet
<b>How much usable water will be recovered?</b>	At 80% humidity, the AWG can generate up to 250 L/day, accommodating the needs of 50 users/day.
<b>How much fertilizer will be produced or recovered?</b>	No fertilizer is generated by the eToilet
<b>What is the estimated business opportunity or revenue potential?</b>	User fees and advertisement revenue.



*This innovative eToilet School Model is exclusively designed and developed to meet the specific sanitary needs of school students to promote good sanitary practices in schools.*

eToilet incorporates full cycle approach in sustainable sanitation by integrating convergence of electronics, mechanical, web-mobile technologies thereby controlling entry, cleaning, exit, and remote monitoring capabilities with multiple revenue options.



**Bincy Baby**  
Head-Convergence Business Group

Eram Scientific Solutions Pvt. Ltd.  
KEK Towers, 5th Floor,  
Vazhuthacaud, Trivandrum,  
Kerala, INDIA 695 010  
P: +91 9747756100  
E: bincy@eramscientific.com  
www.eramscientific.com



# FSOI Development Firms: AGI Engineering, Beaumont Design, DCI Automation, and Synapse Product Development

## The Fecal Sludge Omni-Ingester (FSOI)

The FSOI will increase the vault pumping capabilities of emptiers (access, effectiveness), reduce their operating expenses, and improve financial and environmental sustainability of their businesses. It will permit more households to rely on mechanical vault emptying, reduce reliance on unsanitary vault emptying practices, and reduce the amount of infectious human waste released into the environment.

The Pumping System of the FSOI will enable emptiers to pump waste from vaults 50 to 100 meters from the roadside, giving them access to over 92% of the vaults in peri-urban spaces. The pumping system will also be capable of emptying the majority of the contents of both wet and dry vaults.

The Mobile Pre-Processing (MPP) technology will enable emptiers to reduce the material transported to waste treatment plants. The Debris Extraction sub-system will extract trash from the waste stream, rinse the trash and disinfect it so that it may be properly disposed of. The Heavies Extraction sub-system will extract sand, grit, glass, and metal from the waste stream then rinse and disinfect the material to make it safe for proper disposal. Finally, a Sludge Thickening sub-system will reduce the water content of the sludge thereby reducing the volume of material that must be transported to a waste treatment plant. The MPP is currently under development and will not be presented at the Delhi Fair.

Improved pumping will widen the market for emptying services. Reducing the volume of material transported to WTP's means lower fuel expenses and more time spent emptying pits.



***The FSOI suite of technologies includes pumping, debris extraction, heavies extraction, sludge thickening, and disinfection sub-systems. The system can be configured to meet the needs of the vault emptying business.***

**Pathogen Treatment Success**

**Material discharged from the system meets or exceeds WHO requirements**

Capital Cost

\$10,000 to \$35,000

Operating Cost

<\$5.00/m<sup>3</sup> extracted

Energy or Resource Generation / Reuse

Capable of discharging water suitable for reuse

Business Opportunity

Revenue generated from service charge for emptying service. Improvements include:

- Increased market size
- Improved consumer experience
- Reduced operating expenses
- Higher profits

# FSOI Development Firms: AGI Engineering, Beaumont Design, DCI Automation, and Synapse Product Development

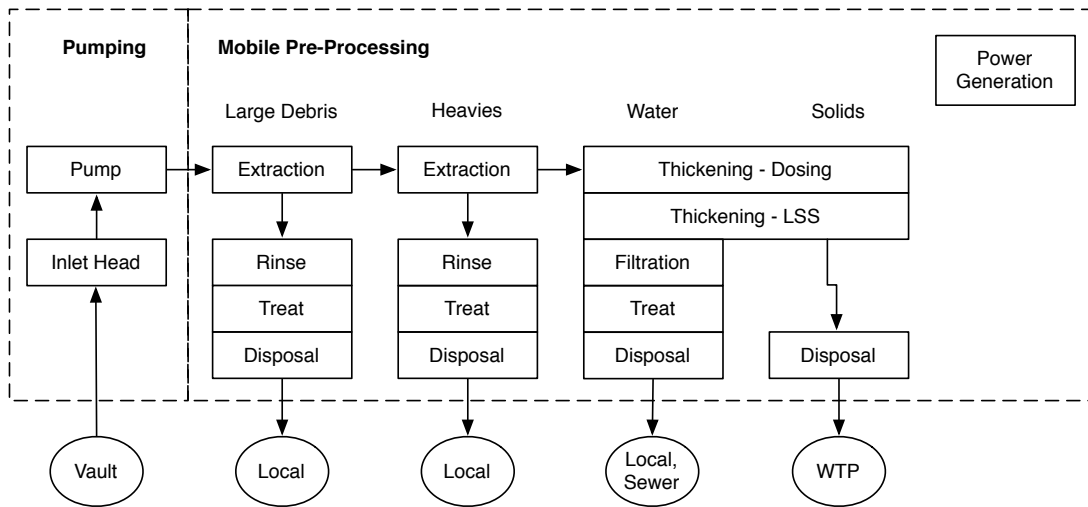

## Pumping

<b>What is the current status of the system?</b>	Field testing of the Pumping System is about to begin. Commercialization is expected to begin in the first quarter of 2015.
<b>What is the estimated capital cost of the system?</b>	\$4,000 - \$12,000 USD
<b>What is the system life expectancy?</b>	10-20 years
<b>What is the expected cost of ownership?</b>	Less than \$2 USD/m <sup>3</sup> Extracted
<b>Source of pumping power?</b>	Varies. Vacuum truck, diesel engine powered compressor, vacuum pump, generator, or hydraulic power unit.
<b>Pumping distance</b>	50 meter minimum.
<b>Pumpable material</b>	Septic tank contents (<5% TSS) to latrine pit contents (<40% TSS)
<b>Does the pumping system require the use of water or air?</b>	Water and or air may be used to improve pumping performance
<b>Does the system require an external source of electricity?</b>	Power will be provided by a diesel engine on the RSU
<b>Does the system use any other "consumable" materials besides fuel?</b>	The pumping system may include some disinfection capability and require a chemical disinfectant

## Mobile Pre-Processing

<b>What is the current status of the system?</b>	System prototype demonstration in a laboratory environment.
<b>What is the estimated capital cost of the system?</b>	\$12,000 - \$23,000 USD
<b>What technical challenges remain?</b>	Additional design and testing is required.
<b>What is the system life expectancy?</b>	10 - 20 years.
<b>What is the expected cost of ownership</b>	Less than \$4 USD/m <sup>3</sup> Extracted
<b>Source of power</b>	Diesel generator (may be shared by pumping system)
<b>Options</b>	Debris extraction & disinfection Heavies extraction & disinfection Sludge thickening & treatment of effluent
<b>Treatment Standard: Debris &amp; Heavies</b>	Safe for human contact
<b>Treatment Standard: Liquid effluent</b>	Meets or exceeds WHO standards for re-use
<b>Other consumables</b>	Polymer (de-watering) Chemical (treatment)

**Andrew Whitesell**  
Project Manager – Fecal Sludge Omni-Ingester

232 Pouli Road  
Kailua, Hawaii 96734  
P: 808-561-8652  
E: abw@beaumontdesign.com  
www.beaumontdesign.com  
www.fsmtech.org

## The Earth Auger: Urine Diverting Dry Toilet

Our goal is to commercialize a series of affordable urine diverting dry toilets (UDDT) that have functional and comfortable features designed to increase the acceptability of dry sanitation. The various models accommodate both high-density and rural communities, and can fit the financial constraints of low-income residences. These toilets differ in price and number of accessories (prototypes: Select, Basic, Squat), with the following basic features:

- Low cost (\$100-150)
- No water required for flushing
- No energy required
- Urine diverting system
- Little odors or fly problems
- Safe and comfortable to use
- Easily operated and maintained
- Cheaply and easily repaired (if necessary)
- Creation of compost (from excreta and dry material) and urine harvesting
- Pedal operated mixer-auger (to process excreta + sawdust)
- Pedal operated flushing (to avoid visual contact – Select model)
- Lever operated sawdust addition (Select model)

The Earth Augers (El Taladro de la Tierra en español) have foot actuated compost mixing and movement, and optional dry flush and sawdust addition operations. Excreta handling is not needed; the whole process is pedal-operated until harvest, when material is automatically stored in attached bag. Subsequent storage time in containers is dependent upon number of users, with detention time required for compost stability and pathogen kill prior to use as a soil amendment.

Field testing of the Earth Auger has begun with limited distribution in Ecuador, allowing for study of user interface, operational acceptability and end product characteristics.

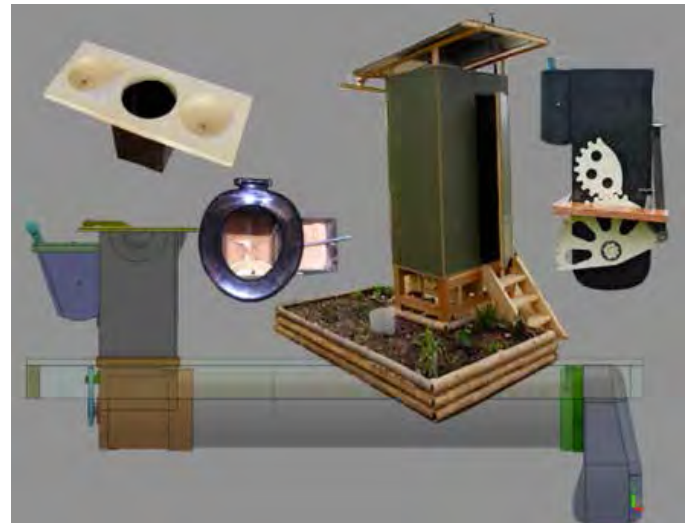

### Key Features

#### Pathogen Treatment Success

Passive pathogen treatment through composting and dessication

Capital Cost

\$100-150 USD

Daily Operating Cost

\$0.02-0.05/user/day

Water/Fertilizer/ Energy creation/capture

Water for reuse: None

Fertilizer: 0.25L/user/day urine

Energy generated: None

Business Opportunity

Direct sales model anticipated

# Fundación In Terris and Critical Practices LLC

## How does the system work?

<b>Are chemical processes used?</b>	No.
<b>Are mechanical processes used?</b>	Yes, the prototype design uses an auger and gears to mix fecal solids with cover material.
<b>Are biological processes used?</b>	Yes, typical decomposition via compost bacteria.
<b>Does the system require the use of water?</b>	No.
<b>Does the system require an external source of electricity?</b>	No.
<b>Does the system use any other “consumable” materials?</b>	Yes, sawdust, other organic material or ash is mixed with fecal solids
<b>Does the system require any off-site waste processing?</b>	Yes, some storage is required to achieve pathogen destruction.
<b>Does the system require any waste to be dumped in adjacent soil?</b>	No, however, the valuable end products will be used to amend the soil.

## What are other key features of note?

<b>What is the current status of the system?</b>	System prototype demonstrated in an operational environment
<b>What is the estimated capital cost of the system?</b>	\$100-150 USD
<b>What is the system life expectancy?</b>	5+ years.
<b>How many users can the system accommodate?</b>	5
<b>What is the estimated daily operations cost per user?</b>	\$0.02-0.05 /user/day
<b>How much energy will be recovered?</b>	None.
<b>How much usable water will be recovered?</b>	None.
<b>How much fertilizer will be produced or recovered?</b>	120g compost, 0.25L urine /user/day
<b>What is the estimated business opportunity or revenue potential?</b>	Direct sales is the anticipated business model



*The Earth Auger – El Taladro - is more than a toilet – it’s a station! This food was grown in soil amended with “Taladro-gro.”*

**“MORE THAN A TOILET –  
IT’S A RECYCLING STATION!”**



**Manufacturing and distribution:**  
Chuck Henry, P.E., PhD  
Design Engineer

60 Goat Peak Ranch Road  
Cle Elum, WA 98922  
206-755-1394  
chuck@criticalpracticesllc.com  
criticalpracticesllc.com/CP/

**Implementation:**  
Marcos Fioravanti  
Environmental Consultant

Via Perimetral km 17 Guayaquil,  
Ecuador  
+593994492690  
mtfioravanti@gmail.com  
www.balandra.edu.ec/interris/



## Zero Discharge Toilet System

The system is based on the wisdom of isolating the water bodies from human excreta and recognizes the fact that human excreta and urine are valuable resources for supporting agriculture. The toilets are identical to those in conventional water borne system as these are the most acceptable and known to be hygienically safe. The collection and processing of the waste, however, is entirely different from the conventional system. The solid and liquid matters are separated underneath the toilet seat itself by using a solid-liquid separator. The separator allows formation of a thin water film that adheres to the surface of the separator and flows outwardly while most of the solids gravitate. The solids gradually disintegrate to form slurry, which is then fed to the bio-composter. The liquid is clarified adopting flocculent settling using enzymes and polymers extracted from naturally available fungi and other microbes. This clarified liquid is recycled for flushing the toilets; thus avoiding the use of fresh water for flushing while no compromise is made for properly flushing the toilet pan. Enzymes and polymers extracted from naturally available fungi and other microbes along with green edible dye eliminate the foul smell and improve aesthetics of the recycled flush water. The entire scheme is implemented in a most compact fashion in the vicinity of the toilet avoiding long distance conveyance of water and wastes.

The faecal sludge is converted into quality organic manure using activated composting followed by vermicomposting. Nitrogen, phosphorous and potash (NPK) are precipitated and recovered intermittently from the flush water to get inorganic fertilizer. Overall, the inputs to the toilet system include (i) human excreta, (ii) water used for anal cleaning, (iii) enzymes and polymers extracted from naturally available fungi and other microbes, and (iv) edible alkaline dye solution while the outputs are vermicompost and inorganic fertilizer (NPK mixture).

### Merits of ZDTS

- The front end is similar to conventional water flush toilets
- Simple device to separate fecal matter from flush water (with urine and anal cleaning water)
- Recycling of flush water thus elimination of fresh water use for flushing
- Conversion of fecal matter to quality organic manure
- Nitrogen, Phosphorus and Potassium recovery from flush water
- Can be installed anywhere; no power / sewer requirement
- Easy installation



Various Versions of Zero Discharge Toilet System

### Key Features

**Pathogen Treatment Success**

**Very high/ Complete isolation of human excreta from water bodies (surface or sub-surface)**

Capital Cost

\$6,500 [set of 4 toilets; excludes processing Plant]

Daily Operating Cost

\$0.05/user/day [per use]

Water/Fertilizer/ Energy creation/capture

Water for reuse: 100% for flushing  
Fertilizer: Yes  
Energy generated: Nil

Business Opportunity

The expected source of revenue: direct sales and/or user fees

## How does the system work?

Are chemical processes used?	Yes
Are mechanical processes used?	Yes
Are biological processes used?	Yes
Does the system require the use of water?	Yes
Does the system require an external source of electricity?	Not necessary
Does the system use any other “consumable” materials?	Yes
Does the system require any off-site waste processing?	Not necessary
Does the system require any waste to be dumped or infiltrated in adjacent soil?	No

## What are other key features?

What odor control measures are included?	Deodorizing agents, Polymer and Enzyme, and a Consortia of Microbes available in nature
What is the current status of the system?	Actual system completed and qualified through test and demonstration
What is the estimated capital cost of the system?	\$6,500 [set of 4 toilets excludes processing plant]
What is the system life expectancy?	25-30 Years
What is the expected daily user cost?	\$0.05/user/day [per use]
How much energy will be recovered?	Directly none
How much usable water will be recovered?	70-80 %
How much fertilizer will be produced or recovered?	> 90 % of nutrients and > 40 % organic matter
What is the estimated business opportunity or revenue potential?	Negligible

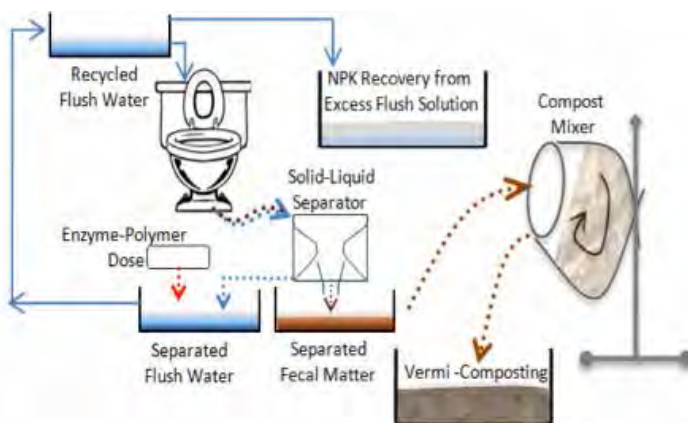

Schematic Flow Diagram of Zero Discharge toilet System

“INDIAN INSTITUTE OF TECHNOLOGY KANPUR”



Dr Vinod Tare  
Professor

Environmental Engineering and Management Programme  
Department of Civil Engineering  
Indian Institute of Technology Kanpur  
KANPUR – 208 016; INDIA  
P: +91-512-259-7792  
E: vinod@iitk.ac.in  
W: www.iitk.ac.in

# Institute for Financial Management and Research (IFMR) and Quicksand Design Studio

## Project Sammaan

An urban sanitation project that combines principles of design, research and technology to propose a new model for community sanitation with an aim to reduce open defecation and instill a sense of dignity in the community using these facilities.

In addition to physical infrastructure of toilets, the project seeks to improve the associated management systems in order to ensure long-term maintenance of the toilet facilities.

A total of 119 toilet facilities will be built and evaluated in Bhubaneswar and Cuttack in 2013-14. More than 24,000 persons are expected to directly benefit from this (200 per facility).

The hardware design, comprised of different community and public toilet layouts and features, will help improve the overall user experience of slum residents using these facilities. Two models of toilets will be tested – one which consists of just defecation stalls (Base Layer) while the other will consist of additional features such as bathing stalls, retail shops, clothes washing area etc. All toilets however will incorporate better ventilation, lighting, landscaping, universal access toilets and a new brand identity.

Additionally, in order to understand the impact of different management models on usage and maintenance, some community toilets will be contracted to private agencies while others will be given to the community to manage and run.



Beyond identifying a solution that will produce the most attractive, sustainable and hygienic alternatives to open defecation for slum residents, the program will test a variety of complementary household-level interventions, such as discount coupons for community toilet facilities and a range of pricing mechanisms (monthly passes vs. pay-per-use), etc.

The study also incorporates a program of demand generation activities in a subset of communities around community and public facilities. These activities will be used to sensitize communities to the problems associated with open defecation and facilitate a collective response sanctioning it.



## PROJECT SAMMAAN

### Kevin Shane

Program Manager & Communications Lead

A-163/1, 3rd Floor  
HK House  
Lado Sarai, Delhi 110030  
India  
P: +91 95602 09883  
E: kevin@quicksand.co.in  
www.quicksand.co.in  
www.projectsammaan.com





## WASHCost Calculator

### What does your latrine really cost?

An easy-to-use tool to evaluate the life-cycle costs of your sanitation and water services. Users fill in expenditure and service data about the case, with the option of using WASHCost benchmarks. It generates a comprehensive report with an evaluation of capital and recurrent costs, affordability to households, and service levels. Results are easily shared and reports are designed to facilitate discussions about financing services and collecting missing data.

Features:

- Life-cycle costs analysis
- Household sanitation service evaluation
- Affordability check for households
- Comparisons between areas
- Shareable reports

### Growing smarter

As more data becomes available and benchmarks are updated, the tool grows smarter and so do your results. As each user analyzes their costs, the database is updated. Benchmarks are set and verified by experts.

### Growing smarter

The life-cycle costs approach shifts thinking from isolated sanitation projects and installations to delivering long-term household sanitation services. It examines all costs from construction, behavior change and training to keeping facilities and services running. It captures capital expenditure, operational expenditure, capital maintenance expenditure, cost of capital, and support costs. It can report what services are achieving in terms of use, accessibility, reliability, and environmental protection.



**Nicolas Dickinson**  
WASHCost Calculator Project Director

Street Address  
Suite 555  
City, State 55555  
P: +31 70 304 4038  
E: dickinson@irc.nl  
www.washcost.org  
www.ircwash.org



# Janicki Industries

## Omni-Processor

Janicki Industries' Omni-Processor is a 300 kW combined heat and power plant that uses fecal sludge – ranging anywhere from 5%-50% solids – as the fuel source for electricity generation. The heat from combustion within a fluidized sand bed is utilized to generate high pressure steam that is expanded in a reciprocating piston steam engine connected to a generator, producing electricity. The exhaust from this engine (process heat) is used to dry the incoming fecal sludge.

## Technology

The key technology features of this plant come from the re-design of basic power plant components making them economical in mass production for small output plants (300kW and smaller). A steam turbine is typically used in power plants for electrical conversion; however, steam turbines are not economically feasible in the small size range. Therefore, Janicki Industries is designing a steam engine, utilizing automotive design mentality and technology, allowing for affordable electricity production.

A similar approach was used in the design of the sludge dryer and fluidized bed boiler. In order to expedite the testing and proof of plant concept, the boiler in Version 1 looks somewhat similar to a typical fluidized bed boiler, however, Janicki's approach in Version 2 is to utilize a radically different boiler design, which will lend itself to significant scalability in size range.

## Prototype Presentation

It is not feasible to ship the physical prototype to the fair; therefore, the exhibit will consist of video footage of the functioning test plant, posters, and small plant components on display. Representatives from Janicki will be available to answer questions and provide additional information as needed.



***A key feature of the Janicki Industries' Omni-Processor is its ability to handle and process solid waste.***

- ***Sludge Processing: the OP is designed to process 14 tons of dry solids every day at full capacity. With 30% total solids, that equates to 50 wet tons of sludge on a daily basis.***
- ***Energy generation: the OP is designed to generate 0.16 kWh per day per user. This electricity can be sold for an estimated average price of \$0.09/kWh on the open market.***

<b>Pathogen Treatment Success</b>	<b>Complete pathogen elimination</b>
Capital Cost	\$350,000 – \$750,000
Daily Operating Cost	\$0.015-0.03/user/day
Water/Fertilizer/ Energy creation/capture	Energy generated Water for reuse Fertilizer
Number of people served per day	30,000 – 50,000
Business Opportunity	User service charges, sludge processing and sale of electricity are anticipated

## How does the system work?

<b>Are chemical processes used?</b>	No.
<b>Are mechanical processes used?</b>	Yes. Most of the novel critical components of this plant, including the steam engine and sludge dryer, are highly mechanical in nature.
<b>Are biological processes used?</b>	No.
<b>Does the system require the use of water?</b>	For the initial production units yes, approximately 1200 L/day of municipal water will be utilized for the power cycle make up water. This is being done to simplify the first plant and accelerate the testing phase. Once the baseline technology is proven, JI will add an additional process loop which will utilize the sanitized water from the dried sludge for this purpose.
<b>Does the system require the use of electricity?</b>	For the initial production units yes. Initially, 30 kW grid power will be used for startup and parasitic loads. Once the technology is proven, JI can add a generator for startup and add an additional feedback loop which will support all parasitic loads.

## What are other key features of note?

<b>Does the system use other consumable materials?</b>	Sand and/or limestone will be used as the fluidized bed media.  Water treatment chemicals will be used to treat the makeup water to reduce scaling on the boiler tubes.  Garbage or other fuel source can be used to increase the sludge solids percentage (or total calorific value) as necessary.
<b>What is the estimated capital cost of the system?</b>	\$350,000 - \$750,000 USD
<b>What is the system life expectancy?</b>	15-25 years, with routine maintenance.
<b>How many users can the OP accommodate?</b>	The OP design was sized around processing 40m <sup>3</sup> of sludge per day, equating to approx. 46,000 users.
<b>What is the estimated daily per user operating cost?</b>	\$0.015-\$0.03/user/day
<b>What is the estimated business opportunity or revenue potential?</b>	\$0.07/user/day. The OP is designed to generate excess electricity for sale, in addition to revenue created by processing of sludge.



Steam engine testing, September 2013



**Sara VanTassel**  
Technology Development Manager

1476 Moore Street  
Sedro-Woolley, WA 98284  
P: 360-856-1522  
E: svantassel@janicki.com  
www.janicki.com



## The Loowatt Toilet

The Loowatt Toilet seals human waste in a biodegradable film for easy transfer to a locally sited anaerobic digester. The Loowatt System produces energy and fertilizer in several steps including mesophilic anaerobic digestion, thermophilic aerobic composting, and vermicomposting.

Loowatt's patented sealing technology eliminates odor and provides a clean and hygienic experience. This technology can fit into toilets of any shape, size, and specification, and is currently engineered for deployment in the following contexts: public toilets and privately owned toilets in BOP (Base of Pyramid) urban markets; disaster relief toilets; hospital toilets; and festival and events toilets.

Loowatt's end-to-end system hardware treats human waste into biogas and fertilizer using a range of processes including anaerobic digestion, thermophilic composting and vermicomposting. These systems are scalable in terms of physical dimensions, catchment areas, and capital and operating expenditures. Loowatt is currently at work with commercial partners to optimize our system hardware and to develop the local economies required to sustain end-to-end treatment in BOP markets.

The first Loowatt system has been successfully serving paying toilet customers in Antananarivo, Madagascar, since November 2012, and the next five Madagascar systems are scheduled for installation in March 2014.



A Loowatt system has been toilet and energy customers in Antananarivo, Madagascar since 2012. © 2013 Loowatt Ltd.

**Loowatt toilets safely contain waste, while their linked systems are designed to achieve a Log 4 (~99.99%) removal of pathogens**

### Key Features

<b>Pathogen Treatment Success</b>	<b>99.99% pathogen removal</b>
Capital Cost	\$50 - \$95 USD
Daily Operating Cost	\$0.03/user/day
Water/Fertilizer/ Energy creation/capture	Water for reuse: None Fertilizer: 0.5 kg/user/day Energy generated: 0.18 kWh/user/day
Business Opportunity	User fees and sale of fertilizer and energy

## How does the system work?

<b>Are chemical processes used?</b>	No.
<b>Are mechanical processes used?</b>	Yes; Mechanical processes in the toilet relate to a simple sealing apparatus and emptying in the local digester; in the digester they relate to heating, mixing and other internal functions.
<b>Are biological processes used?</b>	Yes, the current system uses anaerobic digestion (AD), though the Loowatt toilet can work with other treatment systems. The current system uses aerobic thermophilic and vermicomposting in the post-treatment of digestate (the liquid output from AD).
<b>Does the system require the use of water?</b>	No.
<b>Does the system require an external source of electricity?</b>	No.
<b>Does the system use any other “consumable” materials?</b>	Yes, the system uses Loowatt biodegradable refills.
<b>Does the system require any off-site waste processing?</b>	Depending on the system configuration, processing can be on-site or off-site.
<b>Does the system require any waste to be dumped in adjacent soil?</b>	No.

## What are other key features of note?

<b>What is the current status of the system?</b>	Actual system proven through successful product launch.
<b>What is the estimated capital cost of the system?</b>	\$95 USD (toilet) \$1000 USD (digester)
<b>What is the system life expectancy?</b>	5+ years
<b>How many users can the system accommodate?</b>	Up to 100 uses per toilet between service calls.
<b>What is the estimated daily operations cost per user?</b>	\$0.03 /user/day
<b>How much energy will be recovered?</b>	176 Wh/user/day
<b>How much usable water will be recovered?</b>	None.
<b>How much fertilizer will be produced or recovered?</b>	0.5 kg/user/day (locally sourced straw added to human waste for thermophilic composting)
<b>What is the estimated business opportunity or revenue potential?</b>	\$0.04 /user/day user fees \$0.02 /user/day fertilizer \$0.04 /user/day energy  (all revenue based on experience and research in Antananarivo, Madagascar deployment)



The Loowatt system provides for clean, renewable energy that can be used for a variety of purposes, including mobile phone charging. © 2013 Loowatt Ltd.

**“OUR TOILET USES BIODEGRADABLE LINING INSTEAD OF WATER, CREATING A CLEAN, ODOR-FREE SEAL.”**

# Loowatt

**Virginia Gardiner**  
CEO

contact@loowatt.com  
www.loowatt.com

## Reinventedtoilet@lboro

The guiding objective of the Loughborough Toilet is to safely eliminate known pathogens while recovering scarce resources from waste; the recovered resources can then be used to finance safer disposal in a user-friendly and socially acceptable manner at household levels. The toilet's configuration eliminates the hassle of separating urine and excreta, and may also take in other organic waste, such as sanitary napkins and food products.

The system is very simple – it is based on minimizing flush volumes and processing waste using hydrothermal carbonization with basic “pressure-cooking.” This has resulted in a positive energy balance in a compact size, with little-to-no odour. The toilet can work in off-grid situation and can be mobile if needed as well. The prototype design is based on 6-40 users (average 10 users per day). With further development, it is estimated that the system could work with as many as 100 (for shared toilet) with variations in operation parameters and size of the processor. In current form, the toilet is operational and has completed approximately 2500 hours of operations.

The system is composed of: a desirable toilet seat; an input tank; pump; high temperature pressure reactor; heater; expansion tank; and material collector. The system operates by heating up the input material, cooking it for some time and delivering the output material. The process is exothermic in nature and overall energy positive. The system is design with control systems to enable data collection during the experimentation phase, but also with a very simple user interface for house use. We have also designed in several layers of safety features.

In domestic sanitation, size matters. The Loughborough Toilet's compact size enables its ready use at household level, and we will continue to investigate other ways to reduce its size. Additionally, there is potential for the system to operate off-grid. For demonstration purposes, the system is run off batteries charged by solar collectors and back-up gas-powered generator.



## Key Features

### Pathogen Treatment Success

### Total Pathogen Removal

Daily Operating Cost

Total Pathogen Removal

Water/Fertilizer/ Energy creation/capture

Water for reuse:  
~0.4L/user/day

Fertilizer:  
~10-15 g/user/day

Energy generated:  
~3 kWh/user/day

Business Opportunity

Ownership, licensing, lease, or public partnerships among possibilities

## How does the system work?

<b>Are chemical processes used?</b>	Yes, the system uses hydrothermal carbonization.
<b>Are mechanical processes used?</b>	Yes, vacuum and compressed air, pumps, automatic valves.
<b>Are biological processes used?</b>	No.
<b>Does the system require the use of water?</b>	Yes, approximately 0.5L are used for each flush; additional water may be used for system cleaning purposes. Tap water, grey water, or recycled water may be used.
<b>Does the system require an external source of electricity?</b>	It is both AC and DC current ready and demonstrably off-grid
<b>Does the system require any other consumable inputs?</b>	No.
<b>Does the system require any off-site waste processing?</b>	No.
<b>Does the system require any waste to be dumped on-site?</b>	No.

## What are other key features of note?

<b>What is the current status of the system?</b>	System demonstrated in an operational environment.
<b>What is the system life expectancy?</b>	Expected life of different components varies from 5 years to 20 years +.
<b>How many users can the system accommodate?</b>	6 – 40 users, depending on configuration.
<b>What is the daily per user cost?</b>	\$0.05/user/day.
<b>How much energy will the system recover?</b>	~3 kWh/user/day may be generated.
<b>How much usable water will be recovered?</b>	0.4 L/user/day
<b>How much fertilizer will be produced or recovered?</b>	10-15 grams/user/day; phosphorous in solids, nitrogen in liquids.
<b>What is the estimated business opportunity or revenue potential?</b>	TBD-see above



**M. Sohail**  
Professor

School of Civil and Building Engineering(WEDC)  
Ashby Road  
Loughborough University  
Leicestershire, UK  
LE11 3TU  
P: 44 1509-222890  
E: m.sohail@lboro.ac.uk



## Low-cost Decentralized Sanitary System for Treatment, Water and Resources Recovery

National University of Singapore is working to develop a low-cost eco-sanitation system that: 1) transforms feces into a biological charcoal (biochar) through pyrolysis (decomposition at elevated temperatures without oxygen); 2) recovers urine and cleansing water into clean water for on-site personal hygiene usage by evaporation, condensation and sand/zeolite filtration; 3) produces fertilizers from concentrated urine; and 4) provides odor control by a ventilation fan powered 24/7 by microbial fuel cell. Disinfection processes using hypochlorite and solar LED system on recovered water and fertilizer shall provide additional level of safety from pathogens. The system is designed by considering cultural and sanitation practices in the field.

### Prototype Presentation

The prototype presented at the Delhi Fair consists of a three-way urine diversion sanitary system in which three streams are generated: 1) the urine stream; 2) the feces; and 3) the cleansing water. The feces falls on a conveyor belt and is first solar dried by Fresnel lens prior to being converted into biochar by pyrolysis. The conveyor belt system will be operated through users entering and exiting the revolving gates, avoiding human contact with feces. The conveyor system will flatten and reduce the moisture content of the feces. Solar drying of the feces by the Fresnel lens will allow the feces to be dried enough for pyrolysis/combustion. The heat requirement is met by combusting small amount of wood chips/charcoal and the produced biochar. The heat from pyrolysis/ combustion is concurrently used to evaporate the urine. High quality water will be produced by filtering the condensate water through soil, sand and zeolite, and disinfected by hypochlorite or solar LED system. Diluted fertilizer will be produced by the forward osmosis process and disinfected by the solar LED system. Microbial fuel cells will be powered by the fecal and cleansing water to operate a ventilation fan, achieving odor control by convection of the foul air to the atmosphere through a chimney. Solar powered pump and LED lighting are used. The final output is recovered clean water, biochar and fertilizer (i.e., concentrated urine), achieving eco-sanitation.

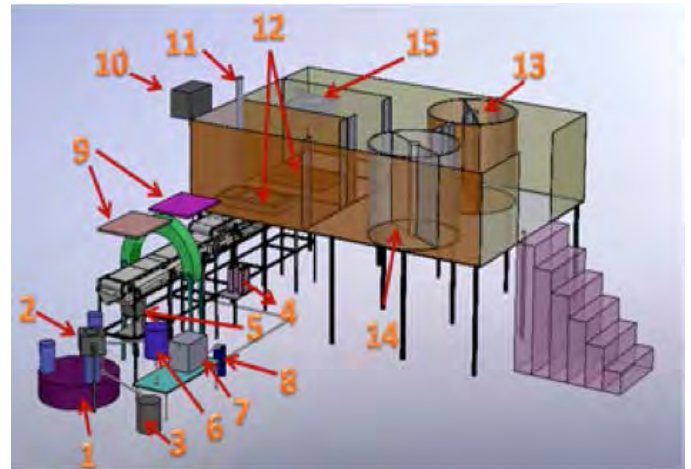

*Sustainable Low-cost Decentralized Eco-Sanitary System for Treatment, Water and Resources Recovery developed in Phase 2. Component: 1. Rotating Stove; 2. Urine Combustion Tank; 3. Urine Condensate Tank; 4. Microbial Fuel Cell; 5. Urine Storage Tank; 6. Urine Condensation Tank; 7. Soil, Sand & Zeolite Filtration Tank; 8. Disinfection Tank; 9. Solar Dryer (Fresnel Lenses); 10. Clean Water Tank; 11. Chimney; 12. Three-hole Squatting Pan; 13. Coin-operated Revolving Entrance Door; 14. Revolving Exit Door; 15. Wash Basin.*

#### Pathogen Treatment Success

#### Near complete pathogen removal

Daily Operating Cost

\$0.01 – 0.02/user/day

Water/Fertilizer/ Energy creation/capture

Water: 1L/user/day  
Fertilizer: 0.1L/user/day  
Electricity: TBD

## How does the system work?

<b>Are chemical processes used?</b>	Yes. Pyrolysis/combustion is used for processing.
<b>Are mechanical processes used?</b>	Yes. For moving feces on the conveyor system.
<b>Are biological processes used?</b>	Yes. Microbial fuel cells are used for energy recovery.
<b>Are physical processes used?</b>	Yes. For evaporation of urine and condensation of vapor; solar drying of feces using Fresnel lens; solar pumps for water transfer; Solar LED for lighting and disinfection; forward osmosis process for diluting fertilizer.
<b>Does the system require the use of water?</b>	No.
<b>Does the system require an external source of electricity?</b>	No.
<b>Does the system use any other "consumable" materials?</b>	Yes. Charcoal/wood chips are used to initiate pyrolysis/combustion, and sawdust is used for odor control.
<b>Does the system require any off-site waste processing?</b>	No.
<b>Does the system require any waste to be dumped in adjacent soil?</b>	No.

## What are other key features of note?

<b>What is the current status of the system?</b>	Subsystem components are being tested in a laboratory environment
<b>What technical challenges remain?</b>	Risk of not achieving sufficient feces drying (target moisture content < 20%) in an operational environment
<b>What is the system life expectancy?</b>	10-12 years.
<b>How many users can the system accommodate?</b>	Full-scale application will accommodate 40-50 users.
<b>What is the estimated daily operations cost per user?</b>	US\$0.01 – \$0.02
<b>How much energy will be recovered?</b>	All energy available in the feces and urine will be recovered and used by the system.
<b>How much usable water will be recovered?</b>	1L/user/day.
<b>How much fertilizer will be produced or recovered?</b>	0.1L/user/day.



**Ng How Yong**  
Associate Professor

Centre for Water Research  
Department of Civil & Environmental Engineering  
National University of Singapore  
1 Engineering Drive 2, E1A-07-03  
Singapore 117576  
P: +65-6516 4777  
E: howyongng@nus.edu.sg  
<http://www.eng.nus.edu.sg/cee/people/ceenghy/>

## Hygienic Pit Emptying Using a Modified Auger – “The Excrevator”

Many pit latrines and septic tanks are emptied by manual laborers, exposing the workers, residents, and the surrounding community to potentially harmful fecal material. Vacuum trucks are expensive and cannot access many pits, particularly in closely spaced slum neighborhoods. Current low-cost technologies work best on low viscosity (high water content) material. What is needed is a low cost, effective method that can safely and efficiently empty pits with a wide range of contents – from watery sludge to high levels of trash. Such a technology will reduce costs for pit emptying, reduce community exposure to fecal borne pathogens, restore dignity to pit emptiers, and encourage small-scale emptying businesses.

### Delhi Fair Presentation:

North Carolina State University is presenting an improved (Version 3) prototype of a low-cost auger-based technology that can reliably and hygienically empty a wide variety of pit latrines and septic tanks (pits) with waste that ranges from high water to high trash content—thus, one machine can be used in a wide range of pit situations.

We will show the prototype pumping out a simulated pit latrine with simulated fecal sludge material. Visitors can come up on the platform and operate the machine (‘The Excrevator’) to experience how it works. We will also show a video of the machine working in the field.



Field testing in Durban, South Africa showed the ability of the extraction auger in emptying pit latrines as a portable, hygienic technology. The testing also showed the high variability of pit latrine contents with respect to viscosity, water content, shear strength, and amount of trash.

### Key Features

Capital Cost	\$1,000 - \$3,000
Daily Operating Cost	\$5 - \$20
Lifespan of unit (years)	5 - 10
Number of people unit is designed to serve (per day)	25 - 80
Business Opportunity	Pit emptying fees; daily capacity for operator increased over traditional methods

## How does the system work?

The basic design consists of a continuous flight auger that rotates inside a pipe, transporting waste upward, before discharge through a 45-degree wye fitting into containers for off-site transport. In our final configuration, the auger is rotated by a hydraulic motor that provides high power and is easily reversible to discharge solids that enter the auger. The hydraulic motor is powered by a remotely located gasoline engine. The auger is on a wheeled frame for easy transport and maneuverability.

<b>Are chemical processes used?</b>	No.
<b>Are mechanical processes used?</b>	Yes, the screw auger is powered by a hydraulic motor.
<b>Does the system require the use of water?</b>	No.
<b>Does the system require an external source of electricity?</b>	No.
<b>Does the system use any other "consumable" materials?</b>	Gasoline is needed as fuel for the engine. Usage varies, but 1 L per pit is estimated.
<b>Does the system require any off-site waste processing?</b>	The machine is for pit emptying – collected wastes will have to be treated.

*Schematic of the 'Excrevator', the modified power screw auger for emptying pits. Reversible flights near the top push waste material to the outlet. The auger is mounted on a wheeled structure for easy transport and maneuverability, so one person can operate the machine, while another person directs the outlet and collects the waste material. The length of the screw and tube is adjustable, to allow emptying of pits with different depths.*

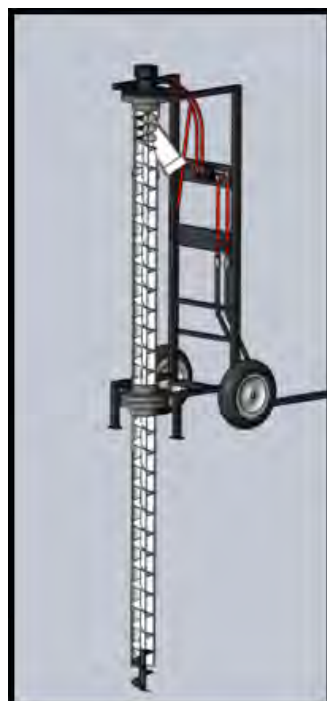

## What are other key features of note?

<b>What is the current status of the system?</b>	System demonstrated in an operational environment.
<b>What technical challenges remain?</b>	Additional field tests on a variety of wastes will be performed in Malawi (with Mzuzu Univ.) and South Africa (with UKZN).
<b>What are the estimated operating costs?</b>	\$5 - \$20 per day for petrol and maintenance, depending on how many pits are emptied
<b>Designed to serve how many people per day?</b>	25 – 80, depending on pits emptied per day and users per pit.
<b>What is the machine life expectancy?</b>	5 - 10 years
<b>How fast can a pit be emptied?</b>	A 1 m <sup>3</sup> pit can be emptied in 0.5 to 1.5 hours.
<b>What is the flow rate of material?</b>	50 -125 Lpm, depending on material
<b>Can the machine be used for pits with different depths?</b>	Yes. The length of the screw auger and tube can be adjusted.
<b>How many people are required to operate?</b>	One person to operate the machine, one person to handle waste collection

**"IF THE MACHINE IS PROVEN TO BE RELIABLE, I WILL USE IT. IT WILL MAKE EMPTYING PITS EASIER AND SAFER."**

*(Quote from a pit emptying business owner from Durban, South Africa)*

**NC STATE UNIVERSITY**

**Dr. Francis L. de los Reyes III**  
Professor

208 Mann Hall  
Stinson Drive  
Raleigh, NC 27695-7908  
1-919-515-7416  
fldelosr@ncsu.edu  
[www.ce.ncsu.edu/faculty/francis-de-los-reyes](http://www.ce.ncsu.edu/faculty/francis-de-los-reyes)



# Pollution Research Group, University of KwaZulu-Natal; eThekweni Water and Sanitation, eThekweni Municipality

## Data Acquisition and Field Support for Sanitation Projects

The eThekweni Municipality in Durban, South Africa is home to a wide variety of sanitation technologies and is therefore an ideal environment in which to conduct research into the optimization of sanitation services. The Pollution Research Group (PRG) at the University of KwaZulu-Natal, in partnership with the eThekweni Water and Sanitation Unit (EWS), have been awarded a RTTC 1 Phase 2 grant with the objective of characterizing the physical and chemical properties of excreta streams from dry on-site sanitation systems or from decentralized low-water consuming sanitation systems. This data will be passed to other RTTC grantees for use in their research.

EWS is responsible for the provision of water and sanitation services to more than 3.7 million people within the eThekweni municipal boundaries, which includes both urban and rural areas. There are in the region 35,000 ventilated improved pit latrines (VIPs), 85,000 urine diversion dehydration toilets (UDDTs) and 520 community ablution blocks (CABs). A research facility has also recently been established at Newlands Mashu (North of Durban) in order to investigate: the use of a decentralized wastewater treatment system and the reuse of treated effluent for agricultural purposes; the processing of urine to produce struvite; and the optimization of UDDT design. EWS endeavors to empty the VIP latrines on a 5-year cycle and has developed a pelletizing machine (LaDePa) to process this waste.

Since the early 2000s the PRG has been providing research assistance to EWS and has developed a biochemical processing laboratory in order to analyze fecal and urine waste streams, undertake laboratory scale experiments, and provide data to support the development of sanitation systems.

Under this Gates Foundation grant, further experimentation and data analysis is being undertaken and assistance will be provided to other grantees in establishing and evaluating their prototypes in Durban, and providing a support of their work by:

- obtaining experimental data of a range of excreta streams;
- undertaking generic process investigations on selected excreta streams;
- developing process models of material flows and transformations;

- facilitating field trials for BMGF grantees in Durban, and
- obtaining data from other countries (either field or from prototypes) during the last few months of the project.

Both fundamental characteristic data and operational data will be obtained to support the design of generic processing units which can be applied by other BMGF grantees in the design and evaluation of their particular processes. The output will be a set of simplified process models and the combining of these models to support prototype development.



View of the Newlands Mashu Research Facility

## Key Features

Access to facilities	Communities Sanitation systems
Assistance in field	Sampling On-site pilots
Assistance in labs	Lab-scale pilots Process experiments Lab analyses
Impact on agriculture	Reuse opportunities Growing tunnels Field trials
Networking	Expanding African network

# Pollution Research Group, University of KwaZulu-Natal; eThekweni Water and Sanitation, eThekweni Municipality

A list of the facilities and type of analyses that can be undertaken is provided below:

## PRG facilities

<b>Equipment</b>	Laboratory Pilot plants
<b>Assistance</b>	Analyses Sampling Tours
<b>Sanitation sludge</b>	Chemical, physical & mechanical properties Density & rheological properties Extrusion properties Drying curves and thermal properties
<b>Urine</b>	Vapor-liquid equilibrium Evaporation Filtration Membranes

## EWS Facilities

<b>Communities</b>	Rural Informal settlements Peri-urban Schools
<b>Sanitation systems</b>	Urine diversion toilets Ventilated Improved Pit latrines Pour flush toilets Community ablution blocks School toilets LaDePa pelletizer
<b>Sanitation streams</b>	Feces Urine Sludge
<b>Agricultural field trials</b>	Newlands Mashu
<b>Assistance</b>	Sampling Tours



Sanitation systems in eThekweni (clockwise from top left): LaDePa pelletizer; VIP emptying; UDDT and traditional pit latrine; emptying of UDDT vault; community ablution blocks; reuse for agriculture.

“GOOD SCIENCE MAKES GOOD POLICY”



**Chris Buckley**  
Professor (Head of PRG)

Pollution Research Group  
University of KwaZulu-Natal  
Durban, South Africa  
P: +27 31 260 3131  
E: RTTC@ukzn.ac.za  
<http://prg.ukzn.ac.za>



**Teddy Gounden**  
Manager, Community Education  
and Councillor Liaison

eThekweni Water and Sanitation  
Tel: +27 31 311 8667  
Mobile: + 27 82 804 7299  
Teddy.Gounden@Durban.Gov.  
[zawww.durban.gov.za](http://zawww.durban.gov.za)

# Population Services International (PSI), Water For People, and PATH

## Supporting Sustainable Sanitation Improvements in Bihar (3 Si)

We are providing access to desirable latrines to the various segments based on their paying capacity in rural households of Bihar province of India. The toilets are designed for improved usage particularly by women and improved quality and delivery efficiency by centralized production and distribution of the toilet components. The toilets are being delivered by establishing the supply chain mechanism for sustained delivery of the desirable toilets to the consumer. Households unable to purchase the toilet due to lack of money are also supported by establishing a finance mechanism through the existing network of microfinance institutions and the fund managers.

## Parry's Modular Latrine

By minimizing the skill level required for latrine construction, the Parry's Modular Latrine is a complete pour-flush latrine package that allows customers to assemble their product much like a kit of Lego. No longer reliant on the long-exhausted mason led approach to latrine construction, this innovation is comprised of interlocking, pre-cast concrete components, resulting in a quick, simple assembly process in which the final quality is guaranteed. The standardized manufacturing process make for an attractive investment for entrepreneurs, while households are able to overlook the product's lack of aesthetic appeal for its dominating attributes—a toilet brand that is clean, affordable, long lasting, and stress free to construct.

## Rammer

The Rammer is the next generation Gulper that goes deeper and is cleaner than the original, yet retains the important qualities of having low capital costs, low running costs, capable of local manufacture, simple to maintain, lightweight and not worth stealing. It a Pompidou Centre version of the Gulper in that connecting rods are on the outside the mechanism allowing the unimpeded passage of sludge out of the pit. The project establishes local manufacturers of Rammers and other emptying equipment who sell their devices to start-up pit emptying businesses.



**Sanjay Singh**  
Population Services International (PSI)  
sanjaysingh@psi.org.in

**Sherina Munyana**  
Water for People  
smunyana@waterforpeople.org

**Pat Lennon**  
PATH  
plennon@path.org





## Description

RTI International is working in partnership with Duke University, Colorado State University, Roca, and AppTech Solutions to develop an integrated on-site waste treatment and toilet system. RTI's prototype design will accomplish four primary functions:

1. separate solid and liquid waste;
2. dry and burn solid waste, using a combination of mechanical, solar, and thermal energy;
3. disinfect liquid waste; and
4. convert the resulting combustion energy into stored electricity.

A mechanical, augur-based process is used to separate liquids and begin the process of converting solid waste into combustible fuel. Solar energy, natural air drafts and heat from burning waste provide the drying process. As it dries, the waste is broken down into uniform-sized pellets, which will be burned using a novel combustion unit. This self-powered human waste treatment unit also captures a portion of the heat produced, using thermoelectric energy harvesting, and converts it into electricity for powering the system.

Liquid waste—including urine, liquid removed from the solid waste, and flush water—will be disinfected through electrochemical processes using carbon-based electrodes (developed in partnership with ADT Inc.). Liquid disinfection will be powered by thermoelectric energy from the solid waste treatment unit. The disinfected liquid will be suitable for use as flush water for the toilet, as a fertilizer supplement, or for other non-potable applications.

The system is being designed to reduce cost and maintenance by maximizing operational utility and energy efficiency and minimizing unnecessary components. Energy neutrality is the ultimate goal.

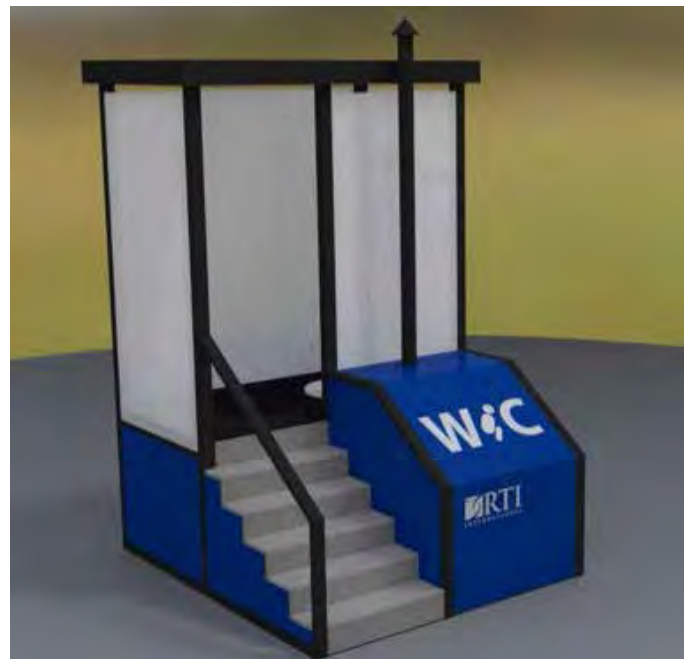

The RTI system is based on 4 core technology components: solid liquid separation and solid waste drying via convection (using heat from combustion), electrochemical disinfection of the liquid waste, combustion of the solid waste (down-draft gasification), and thermoelectric energy harvesting.

<b>Pathogen Treatment Success</b>	<b>Full pathogen elimination achieved</b>
Daily Operating Cost	\$0.01 – 0.06/user/day (max of 50 users per day)
Water/Fertilizer/ Energy creation/capture	Water for reuse Fertilizer Energy generated (100% neutrality)
Business Opportunity	Revenue from user fees anticipated

## How does the system work?

<b>Are chemical processes used?</b>	Yes. The prototype uses electrochemical disinfection to treat the liquid waste
<b>Are mechanical processes used?</b>	Yes. The solid waste is transported through a tube using an auger powered by a foot pedal
<b>Are biological processes used?</b>	No
<b>Does the system require the use of water?</b>	No. Water supply may be added for hand washing and anal cleansing
<b>Does the system require an external source of electricity?</b>	No
<b>Does the system use any other “consumable” materials?</b>	No
<b>Does the system require any off-site waste processing?</b>	No
<b>Does the system require any waste to be dumped or infiltrated in adjacent soil?</b>	No. Pathogen-free ash and liquid can be reused or safely disposed.

## What are other key features of note?

<b>What odor control measures are included?</b>	A water seal will be used to minimize odor.
<b>What is the current status of the system?</b>	System prototype demonstrated in a laboratory environment
<b>What is the system life expectancy?</b>	10+ years.
<b>What is the expected daily user cost?</b>	\$0.01 – 0.06/user/day for O&M assuming 50 users/day.
<b>How much energy will be recovered?</b>	The system is expected to be energy neutral.
<b>How much usable water will be recovered?</b>	1 L/user/day.
<b>How much fertilizer will be produced or recovered?</b>	None.
<b>What is the estimated business opportunity or revenue potential?</b>	O&M costs will be covered at very low cost/user; operators could charge a higher price and make a profit. Toilet operators could also make more profit operating the toilets in middle income housing or public spaces.

**THE RTI UNIT FULLY TREATS  
ALL HUMAN WASTE AND IS  
100% OFF GRID—REQUIRING NO  
EXTERNAL POWER OR WATER**



*This figure shows the core steps in RTI’s integrated waste treatment system—auger-based solid liquid separation, liquid waste treatment via electrochemical disinfection, recycled liquid used for flush/rinse, and solid waste combustion (source for thermoelectric energy generation). Not shown is the Roca-designed squat plate.*



**Brian Stoner**  
Senior Fellow, RTI International  
Principal Investigator

3040 E. Cornwallis Rd.  
Research Triangle Park, NC 27709  
P: 919-248-1119  
E: stoner@rti.org  
www.rti.org  
www.abettertoilet.org

# Sanergy

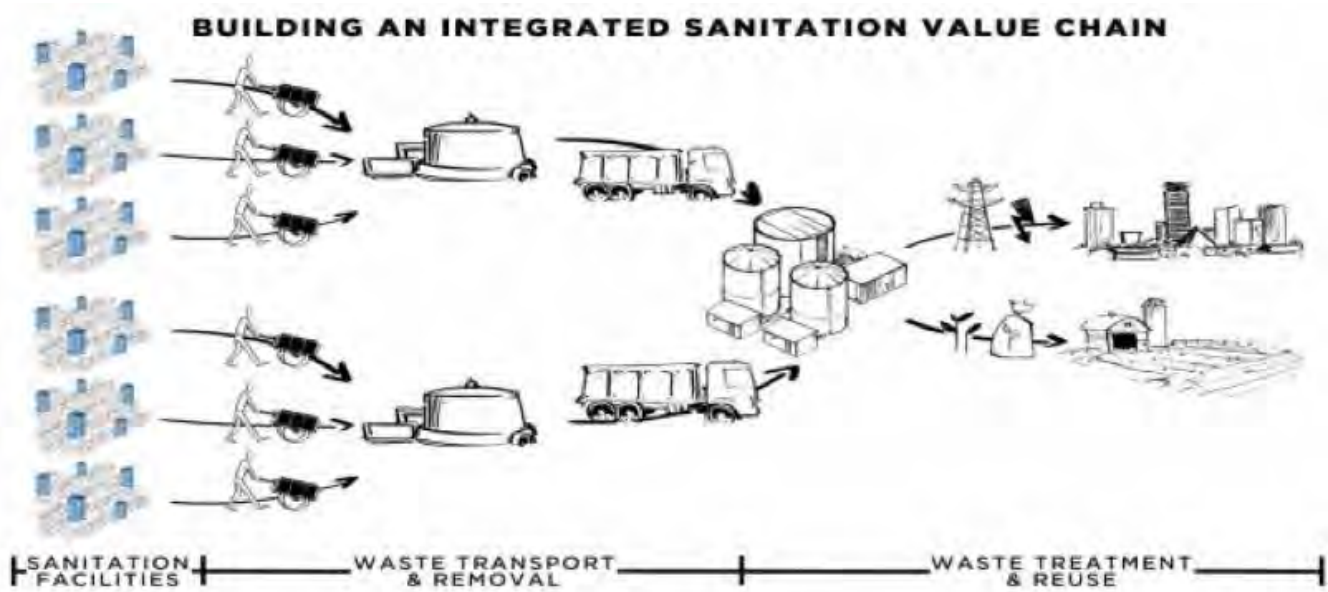

## Fresh Life Toilet

In African slums, Fresh Life makes hygienic sanitation accessible and affordable for everyone, forever. We franchise a dense sanitation network of clean toilets, collect the waste, and convert it into valuable by-products. As of January 2014, 12,000 residents in Nairobi's slums are using Fresh Life Toilets every day with a projected 200,000 in 5 years. Sanergy's franchising creates financial opportunity while solving a critical social and environmental challenge.

## Toilet Design

The Fresh Life Toilet is based on a continuous customer feedback loop and related user research suggests that a clean, comfortable and friendly sanitation experience dramatically increases uptake. The Fresh Life Toilet delivers an enjoyable experience by leveraging features such as an easily cleaned tile floor and an ergonomic splash reducing squat plate for women, men, and children. A durable concrete modular construction, coupled with powerful community-driven branding – in partnership with Wash United – makes Fresh Life preferred sanitation option for all slum residents.



## Key Features

Capital Cost of Facility	\$100-300
Lifespan of Unit	5-6 years
Users / day	80-120 users
Daily Operating Cost	\$0.04-\$0.08/user/day
Water/Fertilizer/Energy creation/capture	Water for reuse: None – waterless design Fertilizer: YES Energy generated: YES
Business Opportunity	User fees for Fresh Life Operators Byproduct Sales for Sanergy

## Collection and Processing

Sanergy collects the fecal sludge from its network of 310+ Fresh Life Toilets in Nairobi, Kenya. Sanergy aggregates the fecal sludge – 5+ tons per day – and converts into a variety of useful by-products. The predominant by-product is organic fertilizer. Sanergy works with a variety of RTTF grantees to develop new technologies:

Partner	Product	Technology	Stage
Climate Foundation	Biochar	Pyrolysis	Large Pilot
Agriprotein	Animal Feed	Black Soldier Flies	Lab Test
EAWAG	Struvite	Nitrogen Columns	Lab Test
EAWAG	Blue Diversion Toilet	Stream Separation	Field Trial
UNESCO-IHE	Biogas	Anaerobic Digestion	Field trial
UC – Berkeley	Ammonia Disinfection	pH Alteration	Field Trial

*We welcome the opportunity to collaborate with other Gates RTTC*



*A Child Uses the Fresh Life Toilet Nairobi, 2012*

**“WE MAKE HYGIENIC  
SANITATION ACCESSIBLE  
AND AFFORDABLE FOR  
ALL, FOREVER”**



**David Auerbach**  
Co-Founder  
Nairobi, Kenya

P: +254 739 585 070  
E: david@saner.gy  
W: <http://saner.gy>

**Fausto Marcigot**  
R&D Engineer Lead  
Nairobi, Kenya

P: +254 735 742 851  
fausto@saner.gy  
W: <http://saner.gy>



## GF-1 All Solar Unit

Santec is developing a self-contained, solar-powered restroom facility. The unit is equipped with one (1) mixed content toilet facility and one (1) urine-only urinal facility. It is designed to accept fecal material, urine, and waste paper, as well as transport these items from the user area to the processing area, via mechanical transfer. Once in the processing area, the waste content level will be monitored by sensors. In the processing chamber, the mixed content will go through an initial gravity filtration to separate the liquid and solid content. The solid content will be retained in a suspended basket post-filtration, while the liquid content will flow under a partition wall and be stored in a second chamber. When the unit processing chamber and the secondary unit liquid holding container has reached the 30-person process capacity, the unit will initiate a process cycle.

The water generated from the process will be available for closed loop reuse in the system toilet and sanitation use, in the toilet area sinks. The water may also be used outside the closed loop for other clean water needs.

The thermal treatment for solids dewatering will exceed temperatures accepted for neutralization of pathogens making the post processed solids safe to handle for auxiliary agricultural and bio-fuel uses.

The system will provide a monthly revenue model for operation including potential for cell or internet income via leasing of unit antenna and bandwidth to established or emerging business markets. This revenue line could be incorporated into other user fees of surrounding population.

Dependant on user frequency, there will be an opportunity to use excess power for auxiliary unit purpose during lower usage periods. This allows for revenue positive availability during variable usage periods.

The operation revenue line is planned at \$0.05/User/Day

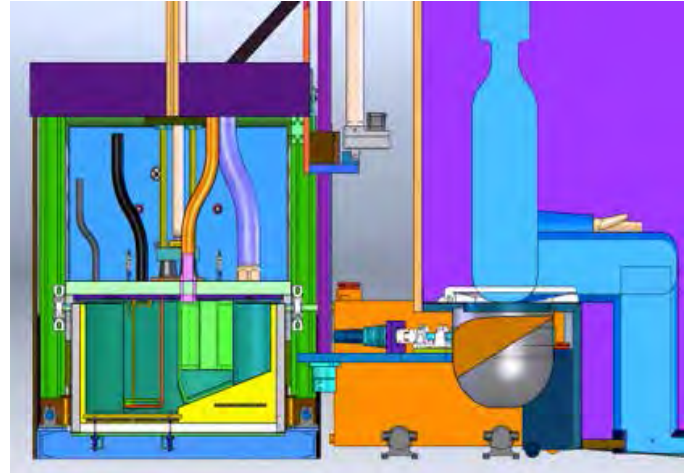

Santec Toilet with Processing Unit

## Key Features

### Pathogen Treatment Success

### Thermal elimination of pathogens is successful

Daily Operating Cost

\$0.035/user/day

Water/Fertilizer/ Energy creation/capture

Water for reuse: 1.5 L /user/day

Fertilizer: 90g/user/day

Potential Energy generated: 0.45 kWh/user/day

Business Opportunity

Potential markets include developing countries, developed nations, and Emergency Management Agencies

## How does the system work?

<b>Are chemical processes used?</b>	No.
<b>Are mechanical processes used?</b>	Yes, distillation is the primary technology used.
<b>Are biological processes used?</b>	No.
<b>Does the system require the use of water?</b>	Yes, as currently designed the unit requires 75L of water for initialization; afterward, the unit will use water recovered during processing in a closed loop.
<b>Does the system require an external source of electricity?</b>	No, all electrical needs (for mechanical controls, wireless communications, and waste processing) are provided for by the included solar array.
<b>Does the system use any other “consumable” materials?</b>	System will require minor routine maintenance of component parts.
<b>Does the system require any off-site waste processing?</b>	No, but option is available for subsequent process power generation via gasification or other.
<b>Does the system require any waste to be dumped in adjacent soil?</b>	Dewatered solids can either be safely used as fertilizer or used in a subsequent bio-energy generation process.

## What are other key features of note?

<b>What is the current status of the system?</b>	System demonstrated in a laboratory environment.
<b>What is the system life expectancy?</b>	Low: 10 Years High: 15 Years
<b>How many users can the system accommodate?</b>	Low 10-15 High: 45-60
<b>What is the estimated daily operations cost per user?</b>	Target \$0.035/user/day
<b>How much energy will be recovered?</b>	0.45 kWh/user/day potential
<b>How much usable water will be recovered?</b>	1.5L/user/day
<b>How much fertilizer will be produced or recovered?</b>	90g/user/day
<b>What are other anticipated sources of revenue?</b>	Service fees, Excess Power Back to Power Grid, Excess wireless capacity, Bio-Energy Power

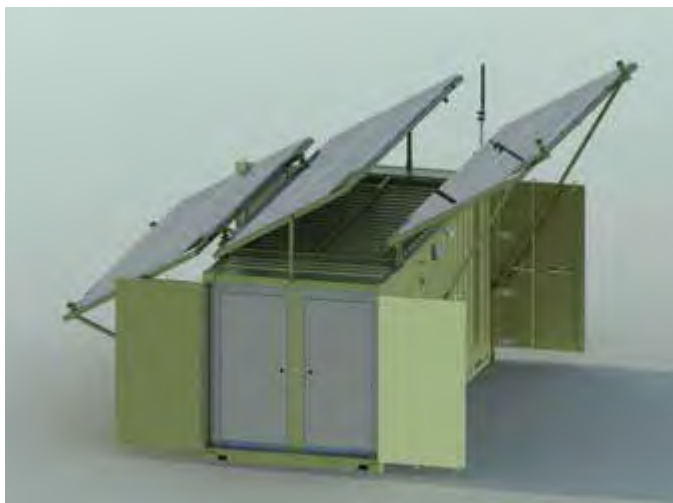

Santec Hut with All Electric Solar Toilet.

“SAVING WATER, SAVING LIVES.”



**Heather M. Deal**  
Chief Executive Officer

718 State Street  
Suite B  
Newburgh, Indiana, 47630  
P: 812.484.2162  
E: hdeal@santeccompany.com  
www.santeccompany.com

# SCOPE

## Society for Community Organization and Peoples Education (SCOPE)

Existing sanitation systems, pour flush pit toilets, septic tank toilets and underground drainage systems are not sustainable and they seriously pollute environment. They all are disposal oriented and not conservation or management oriented. They seriously contaminate the groundwater and surface water.

- These existing systems are water centered. Water is a very precious input which cannot be wasted. The UGD system needs enormous quantity of water for transporting human waste from the house to the treatment plants. In individual household septic tank toilets, septage management is a critical issue and in most developing countries like India there are not many septage treatment facility.
- ECOSAN UDDT (Ecological Sanitation Urine Diversion Dehydration Toilet) is nutrient oriented and the human waste is managed in an environmentally friendly manner. The nutrients in human waste is recovered and is used for increasing farm productivity and thereby ensure food security.
- ECOSAN UDDT uses only a very small quantity of water for body wash. Thus the model helps conservation of water
- It is built over the ground and will not contaminate surface or ground water, or the atmosphere.

### Description of the ECOSAN toilet:

The two-chamber ECOSAN UDDT is an onsite toilet system built above the ground. The eco pan is 3-in-1 model ideal for countries like India where people defecate in the squatting position and are used to anal washing with water. Urine from the urine bowl is collected in a mud pot buried outside the toilet. Wash water is filtered in a filter bed outside the toilet. Urine and wash water help the kitchen garden. (Urine can also be collected in a jerry can from the urine bowl and used in any other distant places.

### Usage:

After removing the lid on the drop hole the user defecates, applies ash over the faeces closes the lid and washes his body. (The ash act as a disinfectant and as dehydrating agent). Care is taken so that water is not entering the chamber.

The first chamber will be closed when it is full (about one year)

Faeces in the closed chamber will after one year will become an ideal soil conditioner.



### Advantages:

UDDT saves water, prevents water contamination.

Urine is a very good liquid fertilizer, and the compost is a good soil conditioner

It is the only income generating toilet model.

It will function in high water table flood prone, coastal areas as well as in rocky, hilly, water scarce areas.

### ECCT:

The ECOSAN Community Compost Toilet the first in the world has helped collection of urine in large quantities. 500 liters per week. Urine bank has been started.

Urine is used for research to study its efficiency as fertilizer on different crops (paddy, banana, vegetables). The result is very encouraging, helps saving use of chemical fertilizer which generally deplete soil health.

The nutrient in urine, struvite has been extracted by IIT, New Delhi

ECCT first toilet in the world users were paid money for using the toilet to popularize the value of urine and faeces. HUMAN WASTE IS NOT A WASTE BUT A WEALTH.

# SCOPE

## How does the system work?

Are chemical processes used?	No
Are mechanical processes used?	No
Are biological processes used?	Yes Ash as disinfectant and dehydration agent
Does the system require an external source of electricity?	No
Does the system use any other “consumable” materials?	Yes Ash
Does the system require any waste to be dumped in adjacent soil?	No

## What are other key features of note?

What odour control measures are included	application of ash/saw dust
What is the estimated cost of the system	INR 25,000
What is the expected daily user cost	INR 2
How much usable water will be recovered	12 liters out of 15 liters per day
How much fertilizer will be produced or recovered- 350 kg of compost	350 kg of compost and urine 2000 liters per annum
What is the estimated business opportunity or - revenue potential -	very high when scaled up  INR 500 (compost) INR 500 (urine) Per household

**Society for Community Organization  
and Peoples Education (SCOPE)**

**M.Subburaman, Director, SCOPE**

40, Ramalinga Nagar West Extension Part II, Trichy - 620 003.  
Office: 0431-2774144 Mobile : 9443167190, 9965567190  
scopeagency1986@rediffmail.com  
scopeagency1986@gmail.com  
www.scopetrichy.com



# Sesame Workshop

## 'S' is for Sanitation

With funding from the Bill & Melinda Gates Foundation, Sesame Workshop is developing a multi-media intervention to promote positive sanitation and hygiene behaviors in children ages 3 to 7 and their caregivers in Bangladesh, India, and Nigeria. The 30-month project, which began in November 2012, will provide critical sanitation and health messaging on latrine use, wearing footwear to the latrine, hand washing to break the fecal-oral route of disease transmission, and the safe treatment and storage of water. The project's multi-country approach blends mass media elements that are shared across countries, as well as community-based components that are unique to each country. At the same time, in-country research drives and informs the entire project.

## Project Components

1. A mass media component: A series of public service announcements that align shared issues on sanitation and hygiene across Bangladesh, India, and Nigeria.
2. A community-based intervention: The project will take advantage of strengths and infrastructure in each country to implement community-level interventions. In Bangladesh and India, this takes the form of community viewings of themed video content on sanitation and hygiene with accompanying print materials and mediation by a trained facilitator. In Nigeria, a school-based intervention with a series of books and a DVD that focus on sanitation and health topics form the core of the program.
3. A research-driven approach: The project is driven by an extensive research process that includes in-country advisories to inform the project's educational framework; a needs assessment; formative testing of materials created for the project; a pilot evaluation of impact; and a survey of the project's reach.

Using our unique approach and the power of the Muppets, Sesame Workshop aims to have a measurable impact on the health of young children and their families around the world.



**June H. Lee, Ph.D.**  
Assistant Vice President  
Research and Evaluation  
Sesame Workshop

1900 Broadway  
New York, NY 10002  
P: 212-875-6252  
E: [june.lee@sesame.org](mailto:june.lee@sesame.org)  
[www.sesameworkshop.org](http://www.sesameworkshop.org)





## Aerobic Biological Toilets

The primary function of the biological toilets is to completely eliminate open defecation. The biological toilet consists of a purpose built multi chambered bio digester tank in which the wastes are stored. The movement of the wastes is slowed down as the wastes flows from one chamber to another by a special process in the Bio digester tank so that the multi strain bio media present in the tank can digest the wastes and convert them fully into non toxic, non pathogenic neutral water. This resultant water then passes on to the Disinfection Chamber where it is completely disinfected before it passes out as irrigation nutrient.

The Biological Toilets eliminate septic tanks, sewage lines and need for any periodic sludge removal. Toilet system decomposes the waste completely and converts it into water by the bacterial digestion within 24 hours. The toilet system is simple to operate requires zero maintenance, is totally odorless and safe for users.

### Social impact achieved so far:

- More than 3000 MT of human waste treated of which otherwise would have clogged existing sewage systems..
- More than 60000 Liters of water conserved daily.
- More than 50000 people using toilets for the first time.
- Provided employment to more than 100 people.
- Eradicate infant Mortality
- Promote Women Empowerment.
- Elimination of open defecation and manual scavenging.



### Key Features

Capital Cost (USD)	\$650 - \$1950
Lifespan of unit (Years)	20-25 Years
Designed to serve how many people per day	30 people a day
Daily Operating Cost (USD)	\$0.003/user/day
Water/Fertilizer/Energy creation/captured	Water for reuse: Yes Fertilizer: Yes Energy generated: No

## How does the system work?

<b>Are chemical processes used?</b>	Disinfection Process is used to disinfect the effluent water before discharge
<b>Are mechanical processes used?</b>	A special mechanical process used for gradual holding and Bio treatment of the waste for complete digestion
<b>Are biological processes used?</b>	Aerobic bio digestion process using multi strain Aerobic Bacteria for the complete digestion of the waste is used
<b>Does the system require the use of water?</b>	For flushing after defecation
<b>Does the system require an external source of electricity?</b>	Optional for Lighting purpose and for pumping the water to the overhead tank
<b>Does the system use any other "consumable" materials?</b>	Bio Media, Bio Cleaner, Disinfectant
<b>Does the system require any off-site waste processing?</b>	No
<b>Does the system require any waste to be dumped or infiltrated in adjacent soil?</b>	No

## What are other key features of note?

<b>What odor control measures are included?</b>	Bio Deodorizer is used if required
<b>What is the estimated capital cost of the system?</b>	\$650 to \$1950 depending on the type of model
<b>What is the system life expectancy?</b>	20-25 Years
<b>What is the expected daily user cost?</b>	\$0.003/user/day
<b>How much energy will be recovered?</b>	No
<b>How much usable water will be recovered?</b>	All the usable water may be treated as irrigation nutrient or recycled after treatment as flush water.
<b>How much fertilizer will be produced or recovered?</b>	The total volume of the waste that enters the Bio digester tank per day is fully converted into water which can be used as a fertilizer
<b>What is the estimated business opportunity or revenue potential?</b>	300000 villages in India without toilets and tens of thousands of slums and schools without toilets.



**SUDIP SEN**  
SENIOR VICE PRESIDENT  
STONE INDIA LIMITED

16, Taratala Road  
Kolkata-700088  
+919831229700  
sensudip@stoneindia.co.in  
www.stoneindia.co.in



# Sulabh International Social Service Organisation (SISSO); Sulabh Sanitation & Social Reform Movement

## Project/Product- No.1:

### Two Pit Pour Flush Toilet

Sulabh's Two Pit Pour Flush Toilet is an eco-friendly technically appropriate socio-culturally acceptable and affordable technology option for the developing countries. It provides protection to community health by safe disposal of human excreta onsite. It consists of a pan with a steep slope of 25 to 28° and a specially designed trap with 20 mm water seal, requiring only 1 to 1.5 litres of water for flushing. There are two pits of varying size and capacity depending on the number of users. The capacity of each pit is normally designed for nearly 3 years of usage. Both pits are used alternately, when one pit is full, the incoming excreta are diverted into the second pit. In about two years' time, the sludge gets digested and is almost dry & pathogen free, thus safe for handling as manure. The digested sludge is odorless and is a good manure & soil conditioner. It can be dug out easily and can be used for agricultural & horticultural purposes.

Sulabh's Flush Composting Toilets does not cause water pollution. When constructed in homogenous soil, bacteria do not travel more than 3 metres horizontally and vertically the seepage is not more than 1 metre. The toilet should be built at a safe distance from the source of water keeping in mind the need of taking other necessary precautions. The cost of Sulabh's Flush Composting Toilets varies widely to suit people of every economic status, ranging from US\$ 20 –US\$1000 per household unit.

## Project/Product- No.2: Community Toilet Linked Bio-Gas Plant.

The design developed by Sulabh does not require manual handling of human excreta and there is recycling and resource recovery from the waste. The digester is built underground into which excreta from public toilets flows under gravity. Inside the digester, biogas is produced due to anaerobic fermentation by the help of methanogenic bacteria. The biogas thus produced is stored in inbuilt liquid displacement chamber. 1 cubic foot biogas is produced from the human excreta of 1 person /day.

Human excreta based biogas contains 65-66% methane, 32-34% Carbon-dioxide and rest Hydrogen sulphide and other gases in traces.

Methane is the only combustible constituent, the calorific value of which is 5000 KCAL/cum. 1000 cft (30 cum) biogas is equivalent to 600 cft of natural gas. Sulabh has developed a novel technology to run dual fuel Generator set on biogas alone that works without any diesel. Under the system, ignition of compressed biogas is done through battery operated spark system. It is a new method to make biogas based electricity generation sustainable. Human excreta based biogas system has multiple advantages, - improved sanitation, makes available energy, bio-fertilizer and can reduce greenhouse effect to an extent considering that methane can be used for cooking purpose.



Sulabh Community Toilet linked with Biogas Plant



Sulabh Two Pit Pour Flush Toilet

# Sulabh International Social Service Organisation (SISSO); Sulabh Sanitation & Social Reform Movement

## Project/Product- No.3:

### Sulabh Effluent Treatment System (SET)

Effluent from the biogas plant has high BOD and contains pathogenic bacteria along with nutrients, which could be gainfully used for agricultural / horticultural purposes or direct discharge into a water body. After a series of experiments, the Sulabh has developed a new and convenient technology by which the effluent from human excreta based biogas plants turns into colourless and odourless liquid manure with low BOD and minimal pathogens. The technology is based on filtration of effluent through activated charcoal followed by disinfection with ultra-violet rays. Prior to activated carbon filter the effluent undergoes sedimentation, aeration and sand filtration. The BOD of the effluent from the biogas plant comes down to less than 10 mg/l from over 200 mg/l. Thus the processed effluent can be used for agricultural, and/ or horticultural purposes or be discharged into any water body including rivers. It can also be used for floor cleaning of public toilets in draught prone areas. The decentralized system of biogas plant with SET technology could be an appropriate technology option for small and medium towns and also for high rise buildings / urban colonies which cannot afford the costly and high water consuming sewerage system.



Sulabh Effluent Treatment System (SET)



#### Dr. Bindeshwar Pathak

Founder, Sulabh Sanitation & Social Reform Movement  
Sulabh Gram, Mahavir Enclave, Palam-Dabri Marg, New Delhi – 110  
045, (India)  
Phone : (0091-11) 25031518, 25031519; Fax: (0091-11) 25055952,  
25034014  
E.mail: [sulabhinfo@gmail.com](mailto:sulabhinfo@gmail.com) / [sulabhinfo1@gmail.com](mailto:sulabhinfo1@gmail.com)  
Website: <http://www.sulabhinternational.org>,  
[www.sulabhtoiletmuseum.org](http://www.sulabhtoiletmuseum.org)

## Take Poo to the Loo campaign

'Take Poo to the Loo' is a digitally led, fun and interactive campaign that seek to persuade toilet users to raise their voice to influence public opinion in support of an end to open defecation in India.

The campaign gives youngsters the power to put poo in its right place—the toilet. It builds on the idea that the best way to help youngsters to face the issue is letting all poo break loose of them! On the ground and online, young people encounter the character of poo: Poo has lost its way in the city and must be shown the way to the loo.

### Objectives

- To drive nationwide change by raising public awareness of the issues surrounding open defecation; and to harness private attitudes to form public opinion in favor of the need to end the practice.
- To demonstrate that this opinion is an influential force on the opinion of others (becoming critical datum for social commentators, politicians and decision makers, NGOs, private sector, media, academia and individuals - including children), who also begin to publicly support calls to make India open defecation free.

### Strategies

- To use young people's catalytic power.
- To capitalise on the Government of India's drive to increase access to internet connectivity and social media platforms to a wider population.
- To complement the goals and targets of the National Sanitation and Hygiene Advocacy and Communication Strategy.

## Open Defecation

Open defecation is prevalent among all socio-economic groups in rural India although the bottom two wealth quintiles practice it most. Children are born into an environment that contributes to stunting; to repeated episodes of diarrhoea and worm infestations; and where girls face discrimination as they enter puberty.

In India more than 620 million people defecate in the open; this represents half the population. The other half have become blind to the practice—it is a socially accepted norm. A change is urgently needed. Everyone has to consider the practice of open defecation as totally unacceptable. It is our duty to raise our voice and support efforts to end this practice, and this is exactly what this campaign intends to do.



**Maria Fernandez Ruiz de Larrinaga**  
Communication Specialist

United Nations children's Fund  
India Country Office  
UNICEF House, 73 Lodi Estate  
New Delhi - 110 003 India  
P: +91 11 24606265  
E: mfernandez@unicef.org  
www.unicef.in  
www.poo2loo.com





## Description

Unilever are creating Oya; a community scale sanitation treatment system to serve over 2,250 people. Oya will take in human waste alongside other waste that causes harm to the community, such as clinical, industrial or household waste. These waste materials will be converted to electricity, soil improver and water; products that are useful to the community.

Oya's small footprint and quiet operation make it ideal for use in residential areas of urban cities. Because the technology at its core is pyrolysis, it will render the waste pathogen-free and produce energy in the form of either heat or electricity.

To create Oya, Unilever are modifying a commercially available pyrolysis unit and adding dewatering and water treatment units. Pyrolysis is a process which decomposes matter using heat in the absence of oxygen. This generates an energy-rich syngas, which is then cleanly combusted to produce heat. The solid product is an inert ash, which can safely be used as a construction material or a soil conditioner.

Human waste is too wet to be processed by pyrolysis and so a unit to remove this water is being designed. This will generate a large quantity of contaminated water so a water treatment system will also be designed to remove pathogens. The soluble nutrients in the contaminated water will be separated and concentrated, making a byproduct which can be used as a soil conditioner. The energy created from pyrolysis of the waste will be used to power these processes, and so there will be no net energy requirement for Oya.

Trials with the system will begin in 2014 at Avonmouth Sewage Treatment plant in the UK. A series of different combinations of human waste and other wastes (industrial, clinical, household) will be tested. An assessment of the waste that can be found in different cities globally is being completed. This will ensure that Oya can process the waste from any local environment.



## Key Features

### Pathogen Treatment Success

### Complete pathogen removal

Capital Cost

\$430,000 – \$550,000

Daily Operating Cost

\$0.05 - 0.07 user/day

Water/Fertilizer/ Energy creation/capture

Water for reuse: 6,000 m<sup>3</sup> process quality water produced per day.  
Fertilizer: 300 t liquid fertilizer produced from black water from dewatering process.  
450 t ash byproduct soil conditioner.  
Energy generated: 700,000 kWh per annum.

Business Opportunity

User fees and sale of process byproducts

## How does the system work?

<b>Are chemical processes used?</b>	Yes, pyrolysis is a chemical engineering process.
<b>Are mechanical processes used?</b>	Yes, the dewatering activity is anticipated to be mechanical in nature.
<b>Are biological processes used?</b>	No.
<b>Does the system require the use of water?</b>	No water needs to be added. Process quality water recovered from the sewage will be used for cooling purposes.
<b>Does the system require an external source of electricity?</b>	No external source of electricity required. Electricity will be generated by pyrolysis and used in the system.
<b>Does the system use any other "consumable" materials?</b>	Nothing of significance beyond normal maintenance and cleaning needs.
<b>Does the system require any off-site waste processing?</b>	No.
<b>Does the system require any waste to be dumped in adjacent soil?</b>	No dumping will be required; all outputs will have commercial value.

## What are other key features of note?

<b>What is the estimated capital cost of the system?</b>	\$430,000 – \$550,000
<b>What is the system life expectancy?</b>	10 – 15 years
<b>How many users can the system accommodate?</b>	2,250 – 4,000
<b>What is the estimated daily operations cost per user?</b>	\$0.05 – \$0.07 per user per day
<b>How much energy will be recovered?</b>	Heat energy will be converted to electricity. Dependant on input ratios, this could make 700,000 kWh per annum.
<b>How much usable water will be recovered?</b>	The unit will produce water suitable for industrial processes or irrigation. Volumes are estimated at 6,000 m <sup>3</sup> per annum.
<b>How much fertilizer will be produced or recovered?</b>	450 tonnes per annum of ash for use as a soil conditioner and 300 tonnes per annum of liquid fertilizer from waste water.



The pyrolysis unit and the pre-treatment units will be transportable on shipping containers. The pyrolysis unit can be delivered in two 40 ft shipping containers. Water treatment and dewatering units are currently in design.



**Technical contact:**  
**Lisa Hawkes**  
 Project Leader, Open Innovation,  
 Unilever

P: +44 (0) 151 641 3350  
 E: lisa.hawkes@unilever.com

Unilever Port Sunlight R&D  
 Quarry Road East, Bebington,  
 Wirral, UK, CH63 3JW

**Media contact:**  
**Adam Fisher**  
 Senior Corporate Media  
 Relations Manager, Unilever

P: +44 (0) 20 7822 5082  
 E: Adam.Fisher@Unilever.com

Unilever PLC  
 100 Victoria Embankment  
 London, EC4Y 0DY.

## NewSan Prototype Simulator

The NewSan Prototype is a computer-based simulator based on material flow analysis to simulate resource fluxes related to human excreta from household to final disposal/reuse.

NewSan Prototype allows city engineers and planners to assess resource/energy recovery potential of different options of sanitation systems. It simulates and visualizes the complete sanitation chain, ranging from user interface (toilet) through transport, treatment and final utilization and disposal options. Special emphasis is laid on non-networked sanitation systems, such as those which are prevalent in Africa, Asia, and India.

Due to the flexible nature of the simulator, technologies that are still in the stage of development such as those developed within the Gates Foundation's Grand Challenges Explorations Program – can be incorporated in the simulator. It is expected that this will enhance system understanding and support development of city sanitation plans.

NewSan Prototype software has been developed in collaboration with ifak which is a non-profit institute for applied research at Otto-von-Guericke University in Magdeburg/Germany that develops simulators for water and wastewater applications.

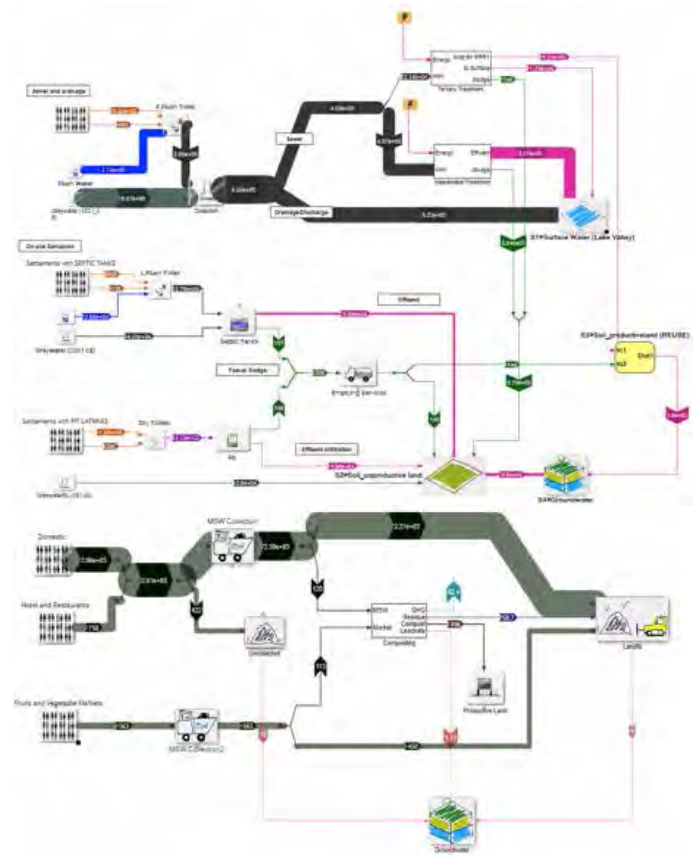

An example of Waste Flows Simulation of Bangalore (by Luca Di Mario, University of Cambridge)

## Key Features

Water, nutrient and energy fluxes from household to final disposal/reuse;

Capex/opex, revenue, energy consumption/generation simulations;

Sanitation systems represented by “blocks” and new blocks can be easily developed;

Blocks built-in include UDDT, low flush toilet, LaDePa, Vortex Bioreactor, Anaerobic Digester, and Biochar processes;

Simulator developed in C#, using Microsoft .NET Version 4

## Input data

<b>Area</b>	Population Population development Area (km <sup>2</sup> )
<b>Household</b>	Type of technology Water consumption (per person per day) Household size
<b>Collection system</b>	Type & capacity of system Energy consumption CAPEX & OPEX Distance to treatment
<b>Treatment</b>	Type & capacity treatment BOD & COD reduction Pathogen type & reduction Biogas production Energy consumption CAPEX & OPEX Waste/Sludge production Distance to final disposal
<b>Final disposal/reuse</b>	Transportation costs Type of system Volume/loading of reuse

## Outputs

<b>Waste flows</b>	Wastewater WW Sludge Faecal Sludge
<b>Nutrients/Pollutants</b>	Carbon BOD COD Nitrogen Phosphorous Potassium
<b>Pathogens</b>	Coliforms Helminths
<b>Resources/Economy</b>	Energy consumption/generation CAPEX/OPEX Revenue

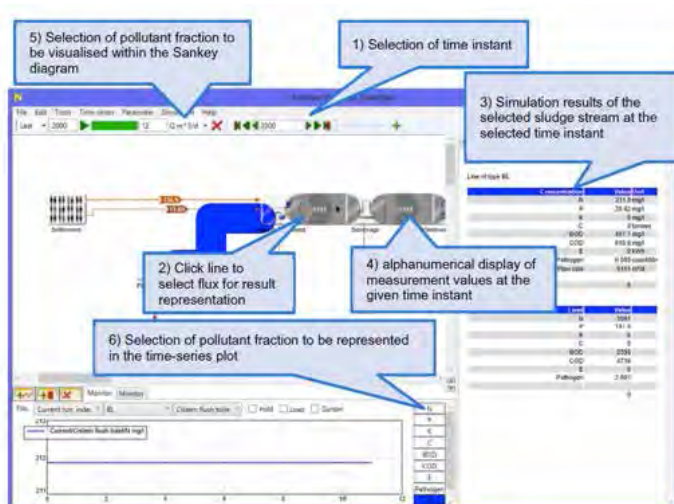

View of the various options for visualization of simulation results in NewSan Prototyp



**Dr Luiza Cintra Campos**  
Senior Lecturer

Department of Civil,  
Environmental and Geomatic  
Engineering  
University College London  
Chadwick Building  
Gower St, London WC1E 6BT, UK  
l.campos@ucl.ac.uk

**Dr Manfred Schütze**  
Senior Engineer

ifak - Institut fuer Automation und  
Kommunikation e.V. Magdeburg  
Wasser und Energie / Water and  
Energy / Agua y Energía  
Werner-Heisenberg-Str. 1  
39106 Magdeburg- Germany  
E: manfred.schuetze@ifak.eu



## Sol-Char System

The Sol-Char approach uses concentrated solar energy to transform both fecal material and urine into safe to handle, commercially viable end-products (e.g., solid fuel, heat, and fertilizer). The system uses parabolic dishes to concentrate sunlight. The concentrated energy is then delivered to a reaction chamber via fiber optic bundles. Fecal material is transformed into char, which can be used as a soil amendment or as solid fuel, while urine is thermally treated to produce nitrogen-rich fertilizer. The Sol-Char process renders the waste completely safe eliminating public health and environmental hazards and can be designed for any number of users by appropriately scaling the solar power input.

## Prototype

The Sol-Char prototype showcases our scientific approach that integrates solar technology innovations within a toilet architecture. Each cycle entails the deposition of fecal material from a urine-diverting squat plate directly into a collection vessel within the reaction compartment. The urine and used hand wash water are diverted to a pre-treatment storage tank. The reaction compartment comprises two vessels that are alternated between “collection” and “reaction” modes via a simple carousel system that can be automated or manually controlled. Once the collection vessel is filled, it is rotated into the reaction position. The vessel is illuminated by concentrated sunlight and heated to temperatures between 200°C to 600°C depending on the daily solar conditions. The urine/hand wash water mixture is thermally treated with a small solar heater to a temperature of 60°C to 70°C for up to 90 minutes. Prototype odor control is achieved with an exhaust fan and an in-line filtration process using the produced char as an adsorbent.

During the demonstration, details of the solar tracking process, the science of solar concentration and transmission, the mechanical operation of the toilet system, and characteristics of the final char product will be displayed.



## Key Features

### Pathogen Treatment Success

### Complete pathogen disinfection

Daily Operating Cost

\$0.03 – 0.23/user/day

Potential Products (user/day)

Char as Soil Amendment: 80 g char  
Char as Solid Fuel: 0.36 kWh  
Disinfected Urine: 1L



## How does the system work?

<b>Are chemical processes used?</b>	Yes, solar powered pyrolysis is used to convert feces into char and other byproducts
<b>Are mechanical processes used?</b>	Yes, various mechanical processes are used to move the waste between collection, treatment, and storage
<b>Are biological processes used?</b>	No
<b>Does the system require the use of water?</b>	Only for hand washing
<b>Does the system require an external source of electricity?</b>	Yes, electricity from a PV panel runs the automated mechanical components
<b>Does the system use any other “consumable” materials?</b>	No
<b>Does the system require any off-site waste processing?</b>	No
<b>Does the system require any waste to be dumped in adjacent soil?</b>	No

## What are other key features of note?

	Low (Disinfection only)	High (Disinfection + Char)
<b>What is the system life expectancy?</b>	~20 years	
<b>How many users can the system accommodate?</b>	Family unit: 4 users/day Household-shared unit: 32 users/day	
<b>What is the estimated daily operations cost per user?</b>	\$0.03	\$0.23
<b>How much energy will be recovered?</b>	Not applicable	0.36 kWh/user/day
<b>How much usable water will be recovered?</b>	Not applicable	
<b>How much fertilizer will be produced or recovered?</b>	Up to 80 g char/person/day (disinfection + char only) and 1 L of treated urine/user/day	
<b>What is the estimated business opportunity or revenue potential?</b>	Usage fees and end products revenue	

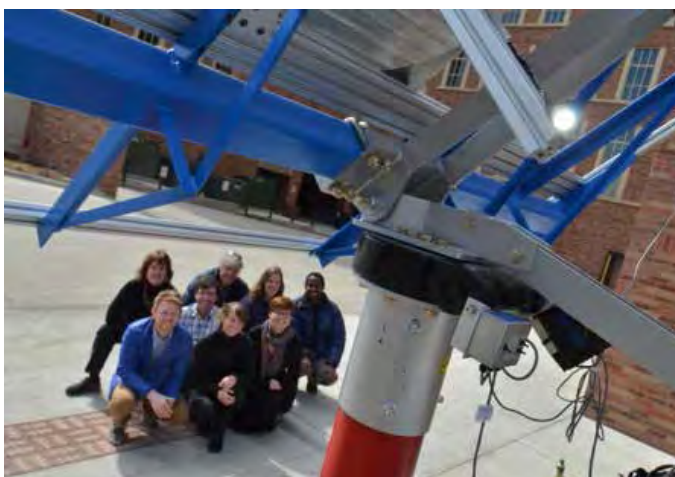

Team members with prototype showing a fiber bundle transmitting light from the sun

## “HARNESSING SOLAR ENERGY FOR SANITATION SOLUTIONS”



**Karl Linden**  
Principal Investigator

Dept. of Civil, Environmental, and Architectural Engineering  
University of Colorado  
1111 Engineering Center Drive, UCB 428  
Boulder, Colorado 80309 USA  
P: 303-492-4798  
E: karl.linden@colorado.edu  
<http://ceae.colorado.edu/klinden/>

## NoWater! NoWatts! NoWaste! Sanitation NoW!

The University of Toronto, with partners at the University of Western Ontario and University of Queensland, present Sanitation NoW! – an onsite sanitation system that collects, disinfects, and recovers valuable nutrients from waste streams. Sanitation NoW! aims to disrupt the sanitation value chain with a decentralized pathogen inactivation process.

### The Process: Collect. Disinfect. Recover.

Solid and liquid waste streams enter the system through a squat pan or any other toilet fixture, and

is then flushed by the user using wash water. Solid and liquid streams are separated using a passive diversion interface, gravity drain, and a sand filter.

The solid waste is mixed with sand and conveyed into a chamber where further mixing and drying occur. Solar power is used to electrically ignite the dried solid waste, which is then disinfected through smoldering, a flameless combustion process that works similarly to a coal barbecue. Organic content is completely destroyed, leaving only sterilized ash and sand. Heat generated by smoldering is used efficiently for solid waste drying and liquid waste processing.

The liquid waste stream drains into a settling tank where residual solid contaminants sink to the bottom, to be removed periodically and recycled through the system. The liquid then flows from the settling tank towards the kill tank, where it is heated from a counter-current heat exchanger (CCHE). The liquid residence time in the kill tank is sufficient for pasteurization. The CCHE recovers heat from the liquid as it flows out of the kill tank, which serves to heat the incoming liquid stream.

The resulting sanitized liquid is a nutrient rich fertilizer, while the output ash from the smoldering process may be used as a soil conditioner. Efficient heat re-use is incorporated throughout the process. Sanitation NoW! is exploring value capture opportunities in nutrient recovery, urban agriculture, maintenance and servicing businesses, as well as subscription sanitation services. Sanitation NoW! is revolutionizing existing sanitation paradigms through innovative onsite rapid disinfection, and nutrient recovery.

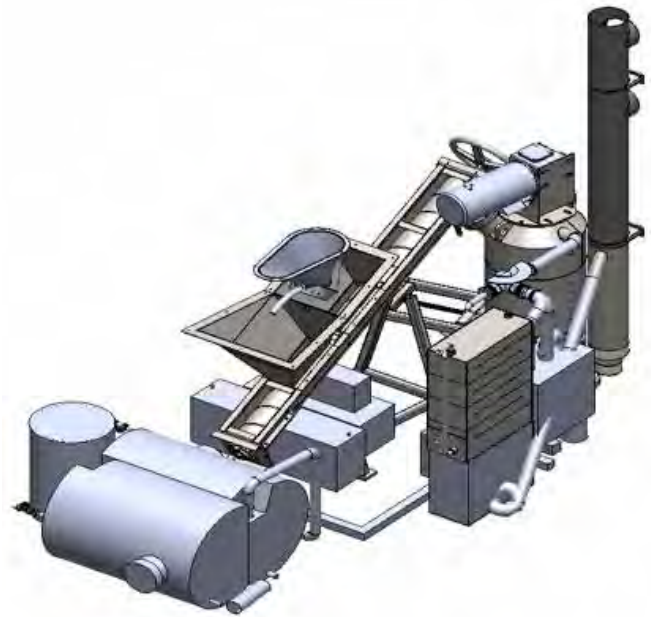

A 3D model of the Sanitation NoW! technology.

## Key Features

What is the life expectancy of a fully functional system?	15+ years
How many users can one system accommodate?	10 user family with the capacity to store and treat more for times of higher load
What is the estimated daily operation cost per user?	\$0.03 – 0.07
What is the estimated water recovered per user per day?	All water input to the system (~35 kg per day) can be safely used for crop irrigation or other land applications, such as fertilizer spreading
How much fertilizer will be produced or recovered?	N: 5.7 – 8.6 g/user/day P: 0.6 – 1.0 g/user/day K: 1.6 – 2.5 g/user/day
What is the estimated business opportunity or revenue potential?	Nutrient recovery, for use in urban agriculture or to be sold commercially, is one potential revenue source being explored.

## Sanitation NoW! PROCESS FLOW DIAGRAM

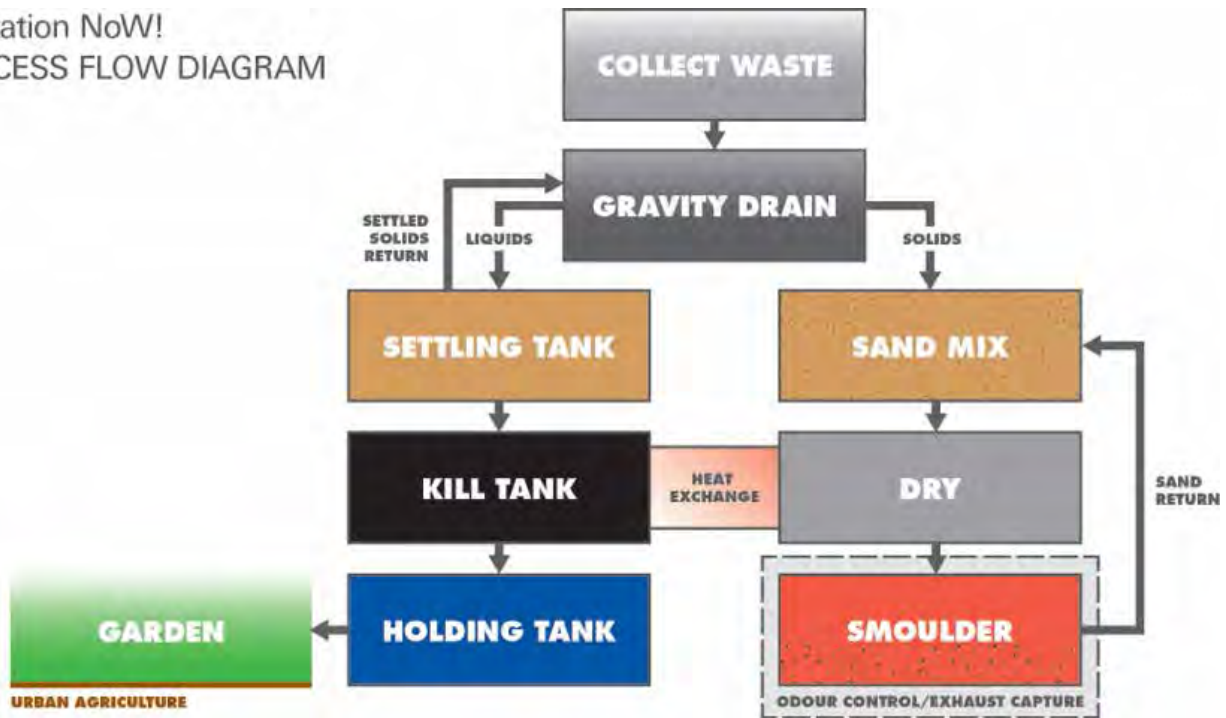

## How does the system work?

Are chemical processes used?	No chemicals are added to the system. However, a number of chemical and physical processes are used: smoldering, heat exchange and recovery, particle settling, filtration and pasteurization.
Are mechanical processes used?	Augering/conveyance, mixing, and pumping of gases and liquids.
Are biological processes used?	No biological processes are used.
Does the system require the use of water?	No, but it accepts wash water and this helps to 'flush' the system.
Does the system require an external source of electricity?	Electricity is needed for air and fluid pumps, mixer, and user lighting; 1.64 kWh/day required.
Does the system use any other "consumable" materials?	Yes. A small amount of sand is used as a filtering medium as well for the smoldering process. It is partially recycled in the system.
Does the system require any off-site waste processing?	No. The Sanitation NoW! system processes everything onsite!
Does the system require any waste to be dumped in adjacent soil?	No, the nutrient rich liquid stream will be used in either adjacent urban agriculture systems or as part of a larger scale nutrient recovery process while the solid stream ash is recovered for use as a soil conditioner.

**Yu-Ling Cheng**  
PhD, P.Eng, FCAE

Director, Centre for Global Engineering  
Distinguished Professor in Global Engineering  
Professor, Dept. of Chemical Engineering and Applied Chemistry  
200 College Street, Toronto Ontario M5S 3E5, Canada  
416-978-5500  
yuling.cheng@utoronto.ca



# University of the West of England (UWE), Bristol

## Description

Urinal facility with integrated MFC (microbial fuel cell) technology for mobile phone charging

The MFC is a bio-electrochemical transducer that generates electricity as a natural respiratory by-product of live metabolizing microorganisms. The MFC technology has been in existence for an entire century. It is only in the last decade, however, that sufficient attention from the scientific community has resulted in MFC systems designed for practical applications, such as wastewater treatment. The innovative idea of using urine as a fuel for electricity is truly unconventional, and Bristol's laboratory findings support its feasibility.

The key process, through this MFC technology, is that urine can be converted directly into useful electricity, which can then be used for simple electrical needs, such as charging a mobile (cellular) phone. This is an important breakthrough that exemplifies the utilization of waste (urine) into something useful.

## Prototype Presentation

The prototype from Bristol will consist of one male urinal unit with an integrated Microbial Fuel Cell stack of 66 units, a mobile phone adaptor and a mobile phone. Bristol intends to demonstrate the effectiveness of the MFC system in treating urine and generating a useful byproduct, by charging a commercially available mobile phone in real-time, from the electricity produced by the MFCs utilizing urine.

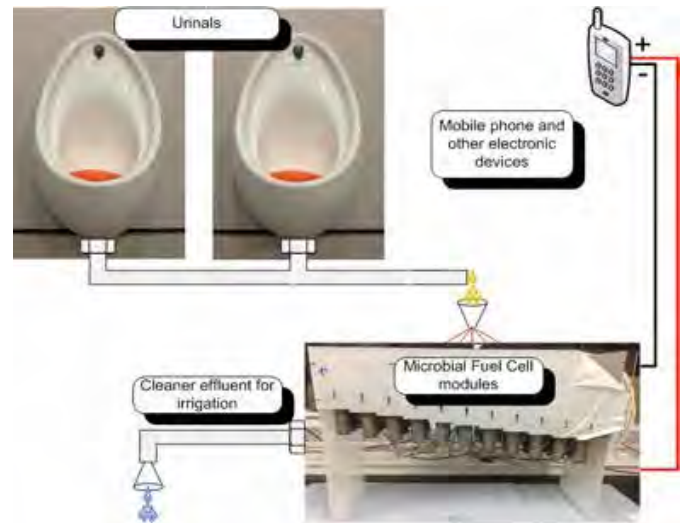

***Urine-tricity converts urine, using microbial fuel cell technology, directly into electricity, enabling charging of mobile phones or other simple electrical needs.***

## Key Features

<b>Pathogen Treatment Success</b>	<b>99.9% (preliminary data)</b>
Daily Operating Cost	\$0.03 – 0.05/user/day
Water/Fertilizer/ Energy creation/capture	Water for reuse: 1L/day Fertilizer: TBC Energy generated: USB 5V output
Business Opportunity	Revenue potential from service charge for urinal use and sale of electricity, as well as from a service contract for maintenance.



# University of the West of England (UWE), Bristol

## How does the system work?

<b>Are chemical processes used?</b>	No.
<b>Are mechanical processes used?</b>	No.
<b>Are biological processes used?</b>	Yes. The Bristol approach uses microbial metabolism of urine into electricity, which results in continuous growth of new daughter cells that can in lock up nutrients useful for fertilizers
<b>Does the system require the use of water?</b>	No.
<b>Does the system require an external source of electricity?</b>	No, in fact Urine-tricity is a generator of new electricity.
<b>Does the system use any other "consumable" materials?</b>	No, urine is the only input required.
<b>Does the system require any off-site waste processing?</b>	Yes. After the urine is processed through the MFC, the remaining waste material will require disposal.
<b>Does the system require any waste to be dumped in adjacent soil?</b>	No.

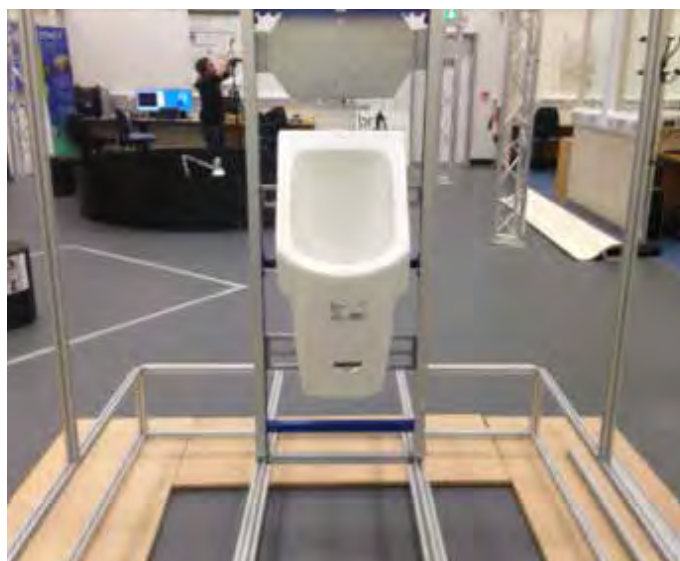

Exhibit showing the urinal (ROCA), prior to the installation of MFC stack and other fixtures and fittings.

## What are other key features of note?

<b>What is the current status of the system?</b>	System components have been validated in a laboratory environment.
<b>What is the estimated capital cost of the system?</b>	Between 5-10 years.
<b>How many users can the system accommodate?</b>	Between 10-20 people per day
<b>What is the estimated daily operations cost per user?</b>	Between \$0.03-\$0.05/user/day
<b>How much energy will be recovered?</b>	Approximately 500Wh
<b>How much usable water will be recovered?</b>	Approximately 1L/day
<b>How much fertilizer will be produced or recovered?</b>	Quantities are yet to be determined
<b>What is the estimated business opportunity or revenue potential?</b>	Selling charges for mobile devices; service and maintenance contracts for device upkeep

## "URINETRICITY – ELECTRICITY FROM URINE"



University of the West of England

**Ioannis Ieropoulos**  
Associate Professor, PhD

Bristol Robotics Laboratory, T-Building  
Frenchay Campus  
Bristol, BS16 1QY  
00441173286318  
ioannis.ieropoulos@brl.ac.uk  
www.brl.ac.uk



# WASH United and World Toilet Organization

## Leading innovation in sanitation advocacy.

WASH United and the World Toilet Organization (WTO) are two of the leading innovators in the field of sanitation advocacy. WASH United harnesses the power of fun, sports stars, interactive games and strictly positive communication to raise the profile of sanitation at scale. With World Toilet Day, WTO has created the most prominent advocacy platform for sanitation at the global level to help break the toilet taboo, make toilets sexy and get the world to talk sh\*t.

## Complementing innovation in sanitation hardware with cutting-edge sanitation advocacy.

Sub-Saharan Africa and India are scattered with tens of thousands of broken and abandoned toilets used as chicken stalls, bicycle sheds or even temples.

WASH United and WTO recognize that innovation in sanitation hardware must go hand-in-hand with innovation in sanitation advocacy. Because only a wanted toilet is a used toilet. And only a used toilet is a toilet that changes the world – one poop at a time.

Through its initiatives, like World Toilet Day and World Toilet Summit, WTO mobilizes a vast network of partners to advocate for effective sanitation policies ensuring health, dignity and well-being for everyone, everywhere. After 12 years of continued sanitation advocacy efforts, WTO achieved a key milestone for the global sanitation movement when the United Nations recognized World Toilet Day as a UN Day.

WASH United's work ranges from travelling WASH carnivals in India, to football-based advocacy and WASH in Schools programs in Africa and - most recently - a partnership with the International Cricket Council (ICC) to promote sanitation and hygiene in South Asia. Sharing innovative advocacy tools and materials with the sector is at the core of WASH United's work. Our hardware partners include Sanergy and Umande Trust.



**ONLY A WANTED TOILET IS A USED TOILET. AND ONLY A USED TOILET IS A TOILET THAT CHANGES THE WORLD – ONE POOP AT A TIME.**

**Thorsten Kiefer**  
CEO, WASH United

Blücherstraße 22  
10961 Berlin/Germany  
thorsten.kiefer@wash-united.org  
P: +49-30-55576806-2  
www.wash-united.org

**Jack Sim**  
Founder, World Toilet Organization

Northstar @ AMK  
7030 Ang Mo Kio Ave 5  
#08-103 Singapore 569880  
jacksim@worldtoilet.org  
T +65 6352 8921  
<http://worldtoilet.org/>



# World Bank Water and Sanitation Program, International Finance Corporation, and Kenyan Ministry of Health

The Selling Sanitation project aims to catalyze the consumer market for sanitation to help millions of Kenyans get access to the sanitation products and services they want and can afford. The project is focused on the market for household sanitation solutions, which presents not only a huge development challenge for Kenya but also a potentially sizeable market opportunity for firms able to provide attractive solutions that meet the needs of un-served consumers.

The project has two phases: (i) supporting the design and testing of a range of suitable sanitation and hand washing products and the market development strategies required to support their sale, and (ii) scoping additional regional opportunities to catalyze sanitation market-based approaches at scale in East Africa.

## Prototype Key Features

The range of slabs developed is suitable for both new builds and retrofits. Some key features include:

### Butterfly footrests

- Allows flexibility in foot position and use by children
- Few nooks and crannies to collect dirt

### Self-Draining

- Prevents pooling of urine
- Makes cleaning easier
- Helps keep slab dry
- Keeps slab cleaner

### Standardized Modified Keyhole

- Elongated hole accommodates both urination and defecation
- Minimizes risk of children falling in

### Dual Hand/Foot operated lid

- Option of hand or foot operation
- Easy to use by adults and children alike



**Lewnida Sara**  
Operations Analyst

Water & Sanitation Program  
World Bank  
Delta Center, Menengai Road, Upper Hill  
PO Box 30577-00100, Nairobi, Kenya  
Lsara@worldbank.org  
www.wsp.org



# 3S – A Division of Saraplast Pvt. Ltd.

## About us

Improved portable restrooms and urinals for Indian application along with a robust scalable and profitable business plan for urban requirements and un-served settlements.

## How does the system work?

JOHNNY'S BOX: The winning combination

- Robust restroom with gravity, water saving fresh water flushing mechanism and hand washing
- High quality blend of technology and quality
- The patented snorkel vent stack ensures minimal odor
- 100% eco friendly double walled unit

Along with this is the 3S signature service wherein we provide installation of unit, cleaning, evacuation, disposal and treatment of waste collected from the restroom as our complete solution.

The waste can be either disposed to a legal waste treatment plant or at our recycling and treatment facility where it can be recovered and sold back to construction sites for non potable usage or for agriculture





# 3S – A Division of Saraplast Pvt. Ltd.

## How does the system work?

Are chemical processes used?	No
Are mechanical processes used?	No
Are biological processes used?	Partially
Does the system require the use of water?	Yes
Does the system require an external source of electricity?	Yes
Does the system use any other “consumable” materials?	Marginally
Does the system require any off-site waste processing?	Yes
Does the system require any waste to be dumped or infiltrated in adjacent soil?	No

## What are other key features of note?

What odor control measures are included?	Bio Friendly Additives
What is the estimated capital cost of the system?	NA
What is the system life expectancy?	10 Years
What is the expected daily user cost?	NA
How much energy will be recovered?	NA
How much usable water will be recovered?	98%
How much fertilizer will be produced or recovered?	NA
What is the estimated business opportunity or revenue potential?	

## SANITATION SOLUTIONS SIMPLIFIED

**Rajeev Kher**  
 CEO and founder  
 203, Rujuta complex  
 Nachiket park,  
 Baner road  
 City-Pune  
 P: +91-9765557782  
 E: rajeev.kher@3sindia.com  
 www.3sindia.com



# Notes



# Notes





# Notes



# Notes

