



Sustainability in Environmental Protection for all citizens

Gatze Lettinga, Grietje Zeeman,
Katarzyna Kujawa, Adriaan Mels,
Jules van Lier

Perhaps the major challenge for the present generations is to attain the Millennium Development Goals (MDG).

Practically all tools (technology & scientific insight) to attain the MDG are available!!

but sociologically we are underdeveloped!

Millennium Water Goals 2000. The Hague 2000

- By 2015; reduce by one-half the proportion of people without access to hygienic sanitation facilities
- By 2015 to reduce by one-half the proportion of people without sustainable access to adequate quantities of affordable and safe water
(UN Millennium Goal, Johannesburg, 2002)
- By 2025 to provide water, sanitation, and hygiene for all

Likely we should apply 'old' wisdom,
well established skills and
concepts/technologies
of our ancestors

and reject

many of the mainly business directed
'innovative developments".

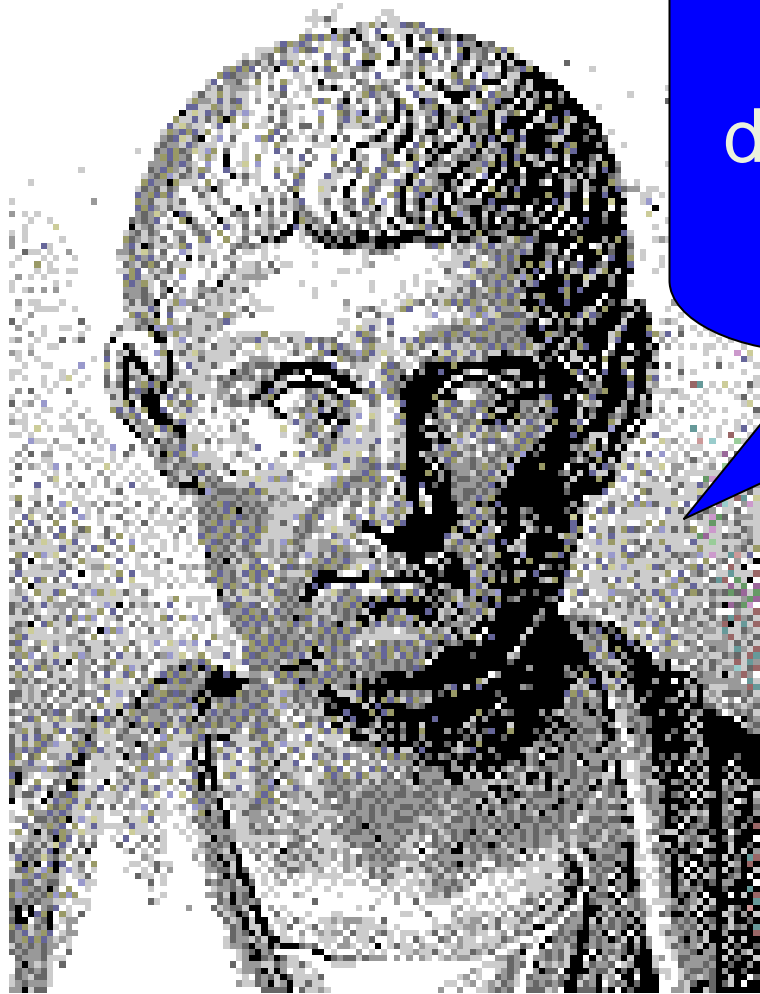

Please, handle
domestic residues with
care!!!

ARISTOTLE
Greece
400 B.C.

54 definitions for the notion Sustainable Development

(Rogers, Jalal, Boyd, "An Introduction to sustainable Development").

The vast majority is directed to self-interest (e.g. of companies, sectors), rather than on the common interest of mankind

Brundtland Commission

WCED, 1987

Along with the on-going steeply growing world population and the exhaustion of resources,

extreme poverty

comprises the main threat for attaining a sustainable society.

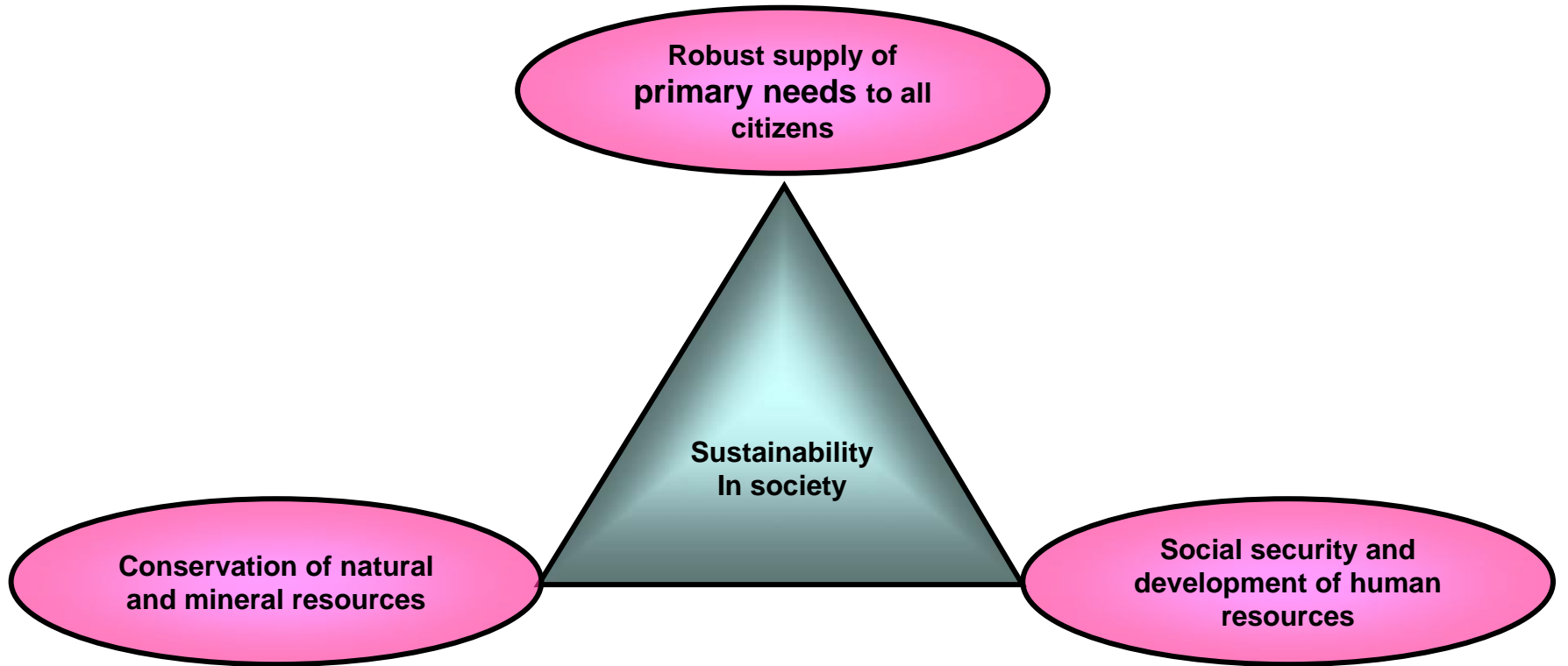

Is it too optimistic to believe
in the realisation of
a more sustainable society
in our 'free market' directed
economies?

The appropriate instruments to force development towards more sustainability are available for most of the vital sectors in society

They lie in the promotion of:

- a) Problem Prevention,**
- b) Self-sufficiency,**
- c) Application of the sustainable technologies/concepts.**

But in our free market directed societies the first priority is for 'economical growth' and everything that supports that!

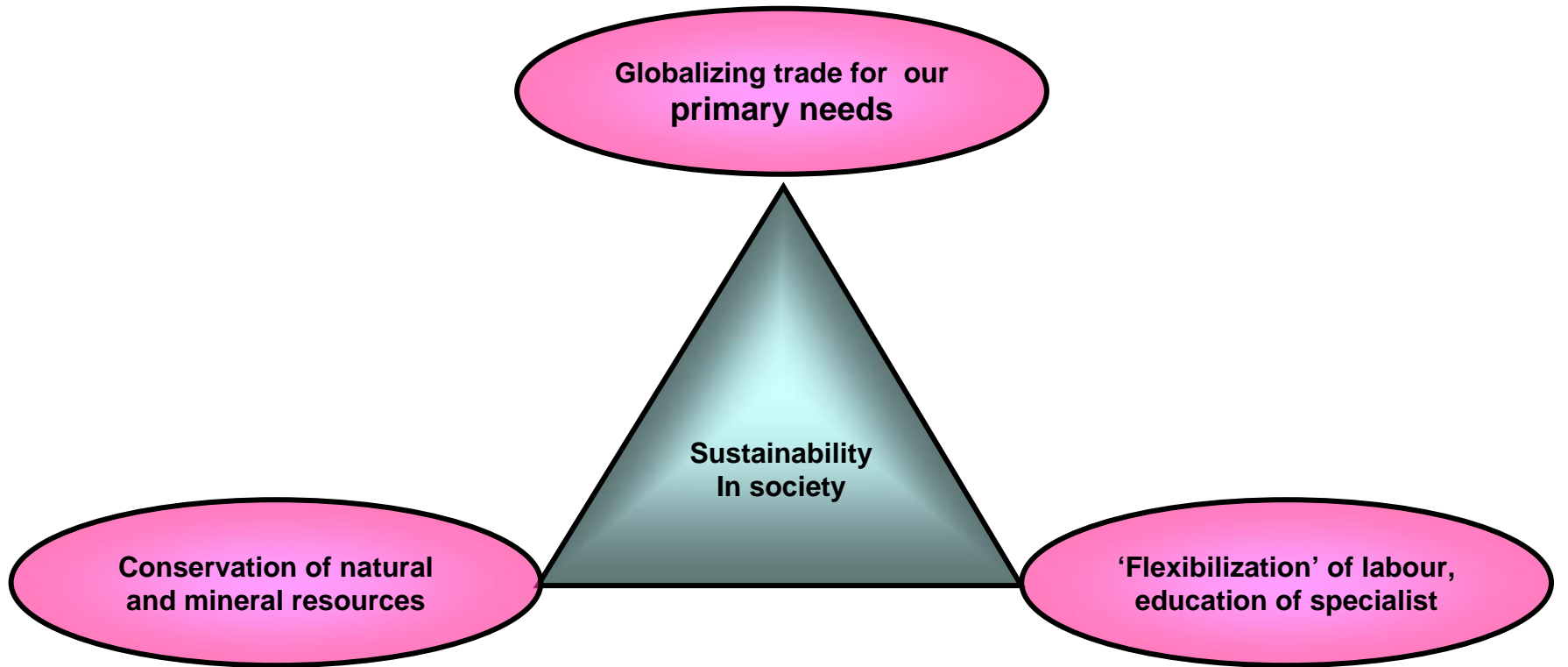

The Environmental Protection Issue

(I will focus on the Public Sanitation Sector)

The Environmental Protection Issue.

**General principle should be:
'avoid man made
pollution problems'**

**(It is immoral to discharge wastewaters
untreated in the environment!)**

**What means sustainability in
environmental protection?**

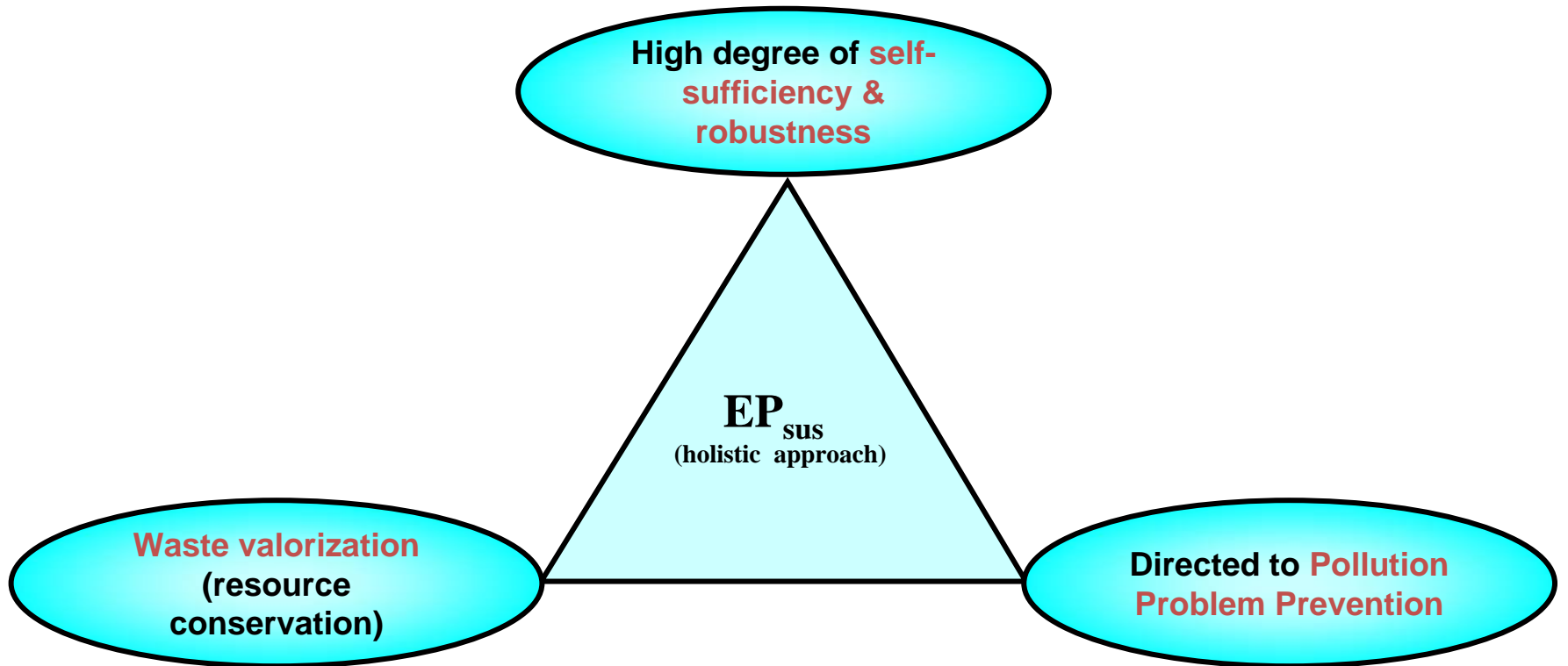

Prevention Man-Problems in EP_{sus}

Sanitation needs to be focused on principles as:

“Keep waste(waters) as concentrated as possible”

“Valorize wastes by recovering and reusing by-products (resources)”

“Keep consumption of resources at a minimum”

“Use simple technologies and concepts”.

Self-sufficiency in EP_{sus}

Communities, municipalities, states, countries,
even possibly communities of national state ,
industries, farmers, etc.

Application of the suitable sustainable technologies and concepts in EP_{sus}

**Most of the instruments lay ready on the
shelf**

i.e . those directed on *pollution problem prevention* and to
waste and wastewater valorization.

Wastewaters in PuSan-sector

Domestic wastewater:	Combined domestic wastewaters
Black water:	Combined urine and faeces from low/high flush-toilets
Yellow water:	Urine (non or slightly diluted)
Brown water:	Faeces with small contribution of urine and flush water
Kitchen wastewater:	Solid fraction of food leftovers and meal preparation
Grey water:	All combined wastewater other than toilet

Solid wastes in PuSan sector

- Food and kitchen residues, well biodegradable!
- Organic non-biodegradable wastes, e.g plastics, paper, etc.
- Garden wastes,
- Inorganic wastes.

Source separation increasingly is becoming an important issue in man

Qualitative characteristics of wastewaters produced at household level

Composition and flow urban wastewater

Volume
L/(PE.year)

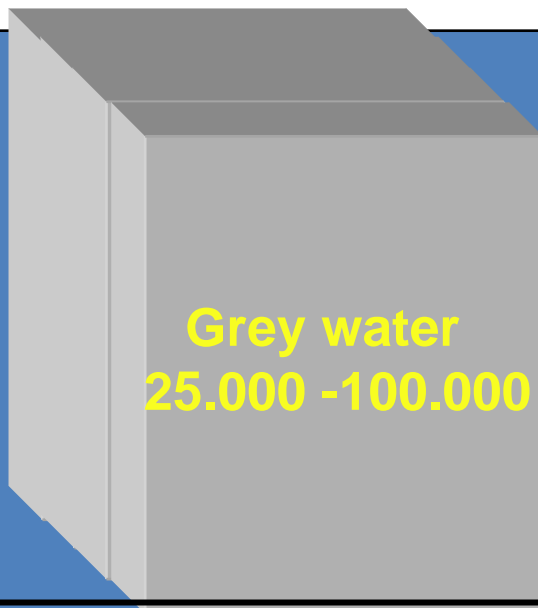

Urine
~ 500

Faeces
~ 50



Loads

kg/(PE.year)

	Grey water	Urine	Faeces
N	~ 4-5	~ 87 %	~ 10 %
P	~ 0,75	~ 50 %	~ 40 %
K	~ 1,8	~ 54 %	~ 12 %
COD	~ 30	~ 12 %	~ 47 %

Source: Otterpohl

Organic matter in domestic wastewater (gCOD/p/d)

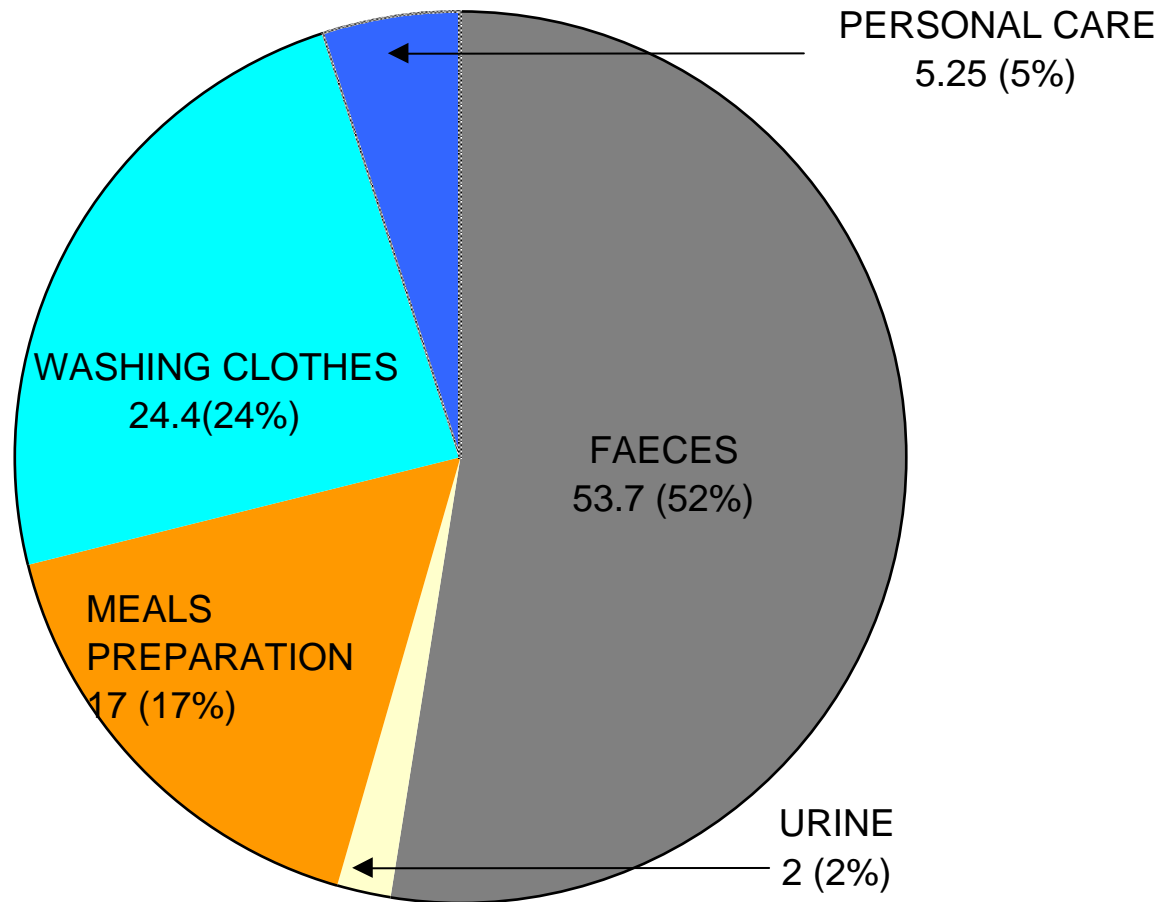

By far the most hazardous domestic wastewater is black water

Small in volume, but highly polluted and containing the pathogens and micro-pollutants!!

Waste(water) collection

**Towards water saving
&
source separation**

(big progress in industry)

Categories of waste(water) collection systems

- A.** Separate collection of **undiluted** faeces, urine (kitchen waste) and grey water.
- B.** Separate collection of **slightly diluted** faeces (from **vacuum toilets**), urine (kitchen waste) and grey water.
- C.** Combined collection of **slightly diluted** faeces + urine (from **vacuum toilets**), (kitchen waste), but grey water separately.
- D.** Combined collection of **diluted** faeces and urine (from **flush toilets**) and kitchen waste, but **grey water separately**.
- E.** Combined collection of **very diluted** faeces, urine from water **flush toilets**, kitchen waste + grey water.

Nothing New!

Source oriented sanitation (or decentralised sanitation and reuse). Already applied in 19th century:



Need for large demands of fertilisers in agriculture!!



Waste(water) Transport

**limit transport,
limit use of water as transport medium**

(big progress in industry)

Components of wastewater infrastructure: sewer and treatment plants



Table 4. Drawbacks of 'excessive' centralisation in the present PuSan-CENSA-practice.

- **Creation of serious environmental pollution and health problems,**
- **Very high investment and maintenance cost** of sewerage (up to 80% of the total investment costs),!
- Sewerage networks with their pumping stations, storage basins etc. are **very vulnerable** ,
- **High risks of uncontrolled discharges** of hazardous compounds,
- Construction is accompanied with a lot of **nuisance in neighbourhoods,**
- Risk for **mal-odour nuisance problems** to the environment,
- **Risks for discharge of untreated wastewater in recipient surface waters.**
- **Export of large amounts of water from the cities,**
- Discharge of large amounts of effluents at one location.

Wastewater treatment systems

Needed for:

a) protection of the environment from pollution,

b) valorization of the 'pollutants'.

**For waste-valorization we need
to apply:**

**The Natural Biological
Mineralization Sequence
(NBMS) treatment concept**

Natural Biological Mineralization Sequence (NBMS)

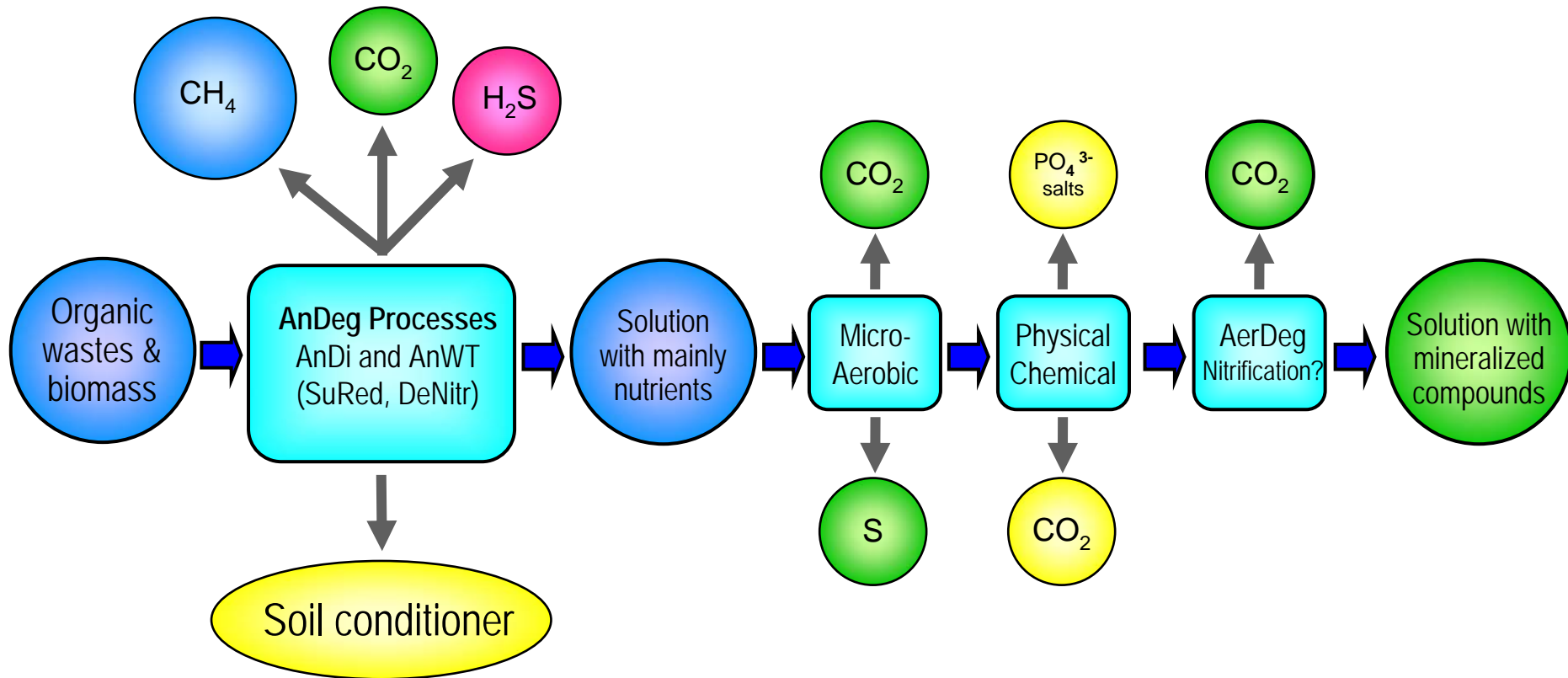

AnDegr-processes: the first NBMS-biological treatment step!!

- For stabilizing biodegradable organic matter,
- For generating useful energy carriers, i.e. CH_4 , possibly H_2 , or even direct generation of electricity.
- For making available of nutrients (fertilizers), and elementary biological sulphur
- For Producing valuable organic soil conditioners

AnWT and AnDi as primary biological treatment step

- For sewage, total domestic wastewater,
- For black water,
- For grey water treatment,
- For slurry & solid waste treatment.

The three main conditions to be met in high rate AnWT-systems

1. Retention of a high amount of viable sludge under high hydraulic and organic loading rates
2. Accomplishing a good contact between wastewater and viable sludge
3. Efficient separation of biogas from the mixed liquor.

Available High-rate AnWT-systems

- UASB-systems,
- AF-systems,
- EGSB-systems (FB-systems?),
- various hybrid systems,
- High-rate systems combined with digester
- Sequential batch systems

A proven feasible design version of a UASB – reactor for sewage pre-treatment

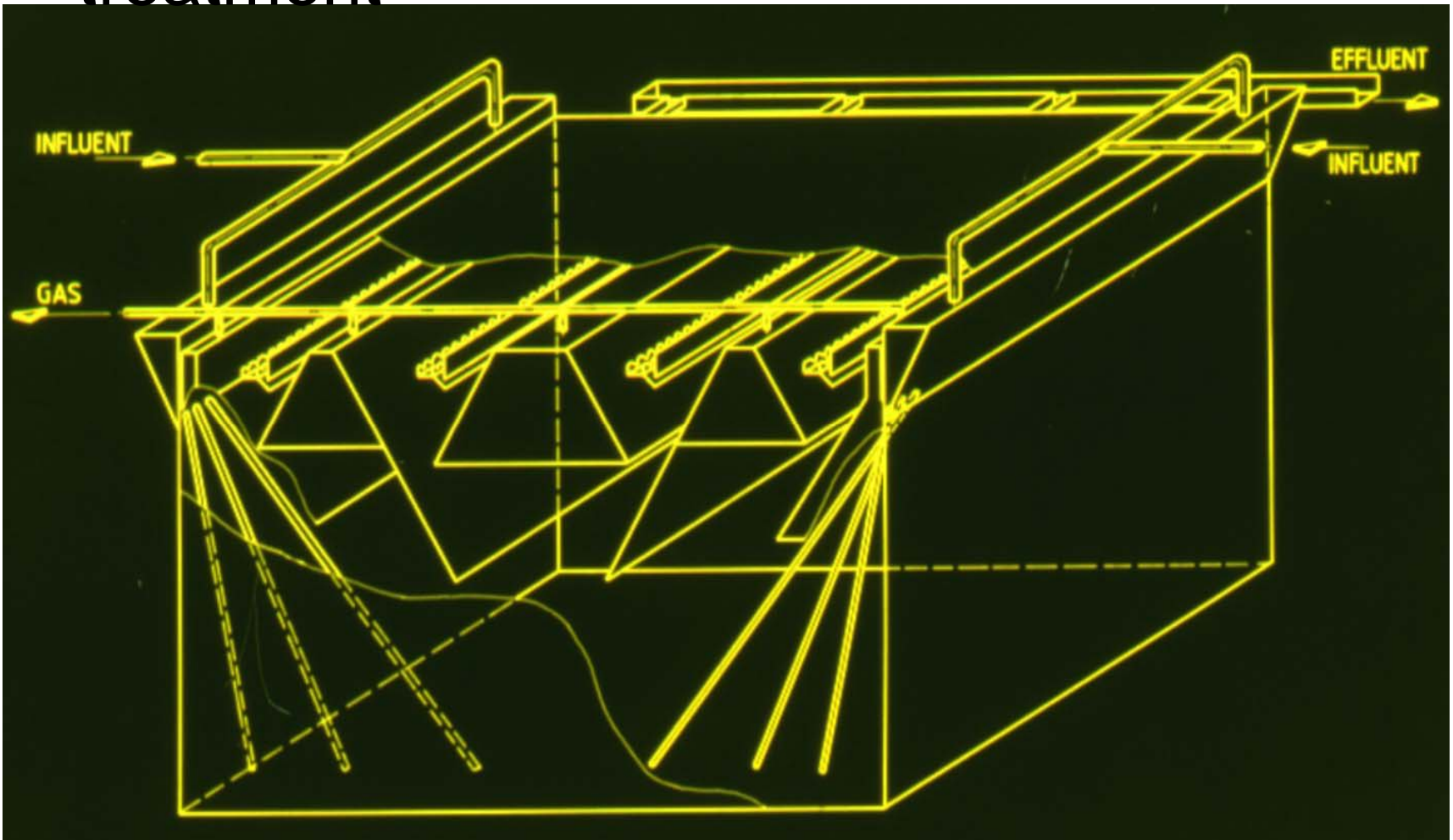

Great advantages of AnWT compared to AeWT:

- Resource producing (energy, fertilizers, soil conditioners) instead of demanding,
- No excess sludge disposal problems,
- Simple, cheap and robust technology,
- Can handle very high organic loading rates,
- No external power supply required,
-
- Viable anaerobic sludge can be preserved for years, i.e. suitable for campaign industries.

Any drawbacks of AnWT compared to AeWT?

- Slow start up? **No problem anymore!**
- Malodour nuisance? **No!**
- Susceptible? **No! (prevent overloading)**
- Little full scale experience? **Vanishing!**
- AnWT is just removing organic matter **OK!**
- Merely applicable at higher temperatures? **Not anymore!**

Fate of UASB by-products: biogas and stabilised sludge

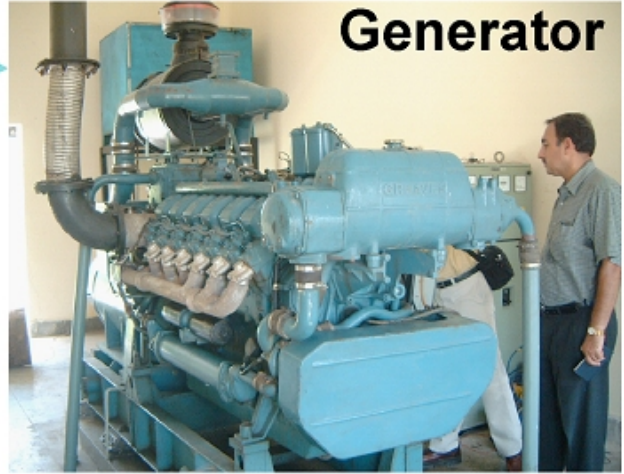
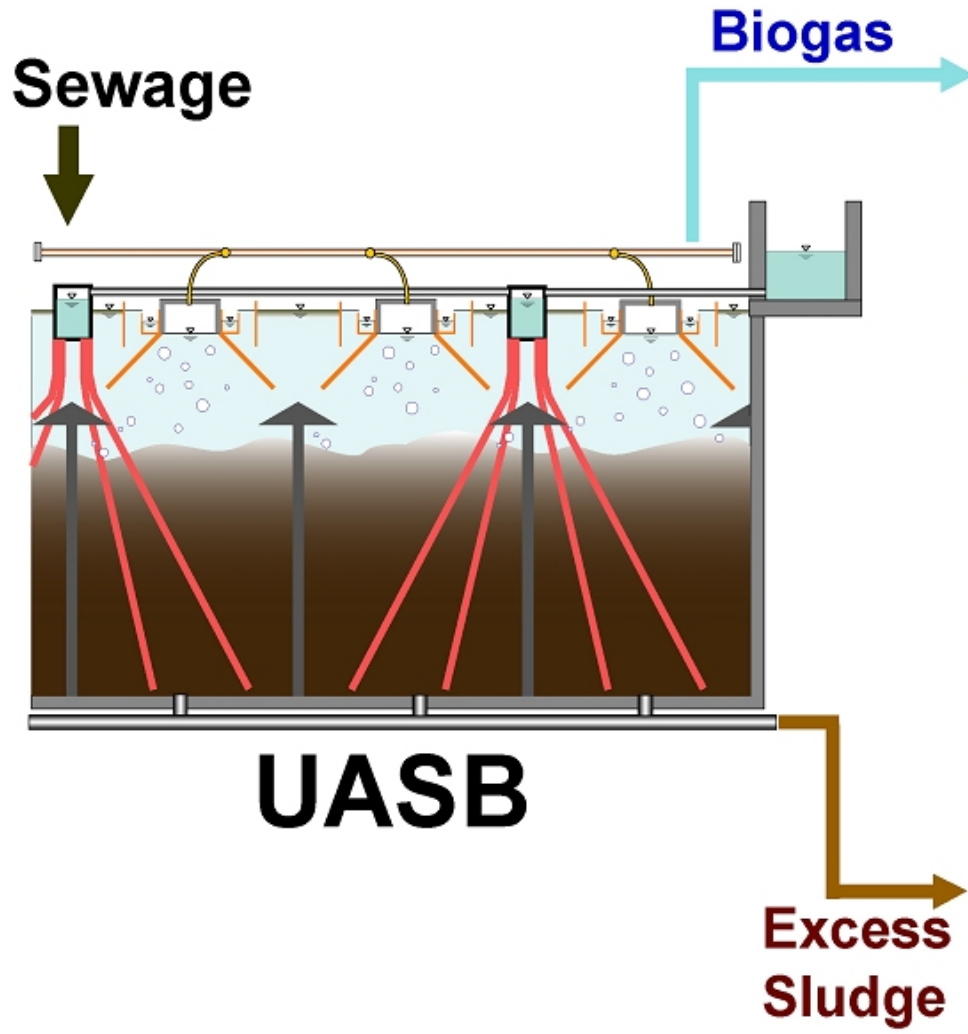

Drawbacks of high-rate AeWT as first biological

- . Energy demanding instead of energy producing .
- . Production of huge amounts of poorly stabilized voluminous excess sludge,
- . High land requirements for the total treatment system,
- . Expensive in investment, operation and maintenance, labor intensive,
- . Technically rather complex and relatively short life-time,
- . Complex in operation and maintenance (need for specialists),
- . Need of rather complex infrastructure e.g. for power supply, consequently vulnerable.
- . Formation of recalcitrant organic compounds (e.g. humic acids) from in essence well biodegradable compounds,
- . Poor degradation of compounds like azo-dyes, PAC's, nitro-aromatics.
- . Occasionally serious mal-odor nuisance problems.

Ae_{micro}WT –systems:

role as first NBMS-post-treatment step

1. Conversion of reduced S-compounds into elementary sulfur.
(use of the oxidative part of the **S_{biol}-cycle**)
2. Degradation of remaining, easily biodegradable organic pollutants,
3. Oxidation of reduced inorganic compounds (e.g. Fe^{II}),
4. Removal of colloidal matter (+ dispersed pathogenic organisms).

How to reach effluent re-use standards ?

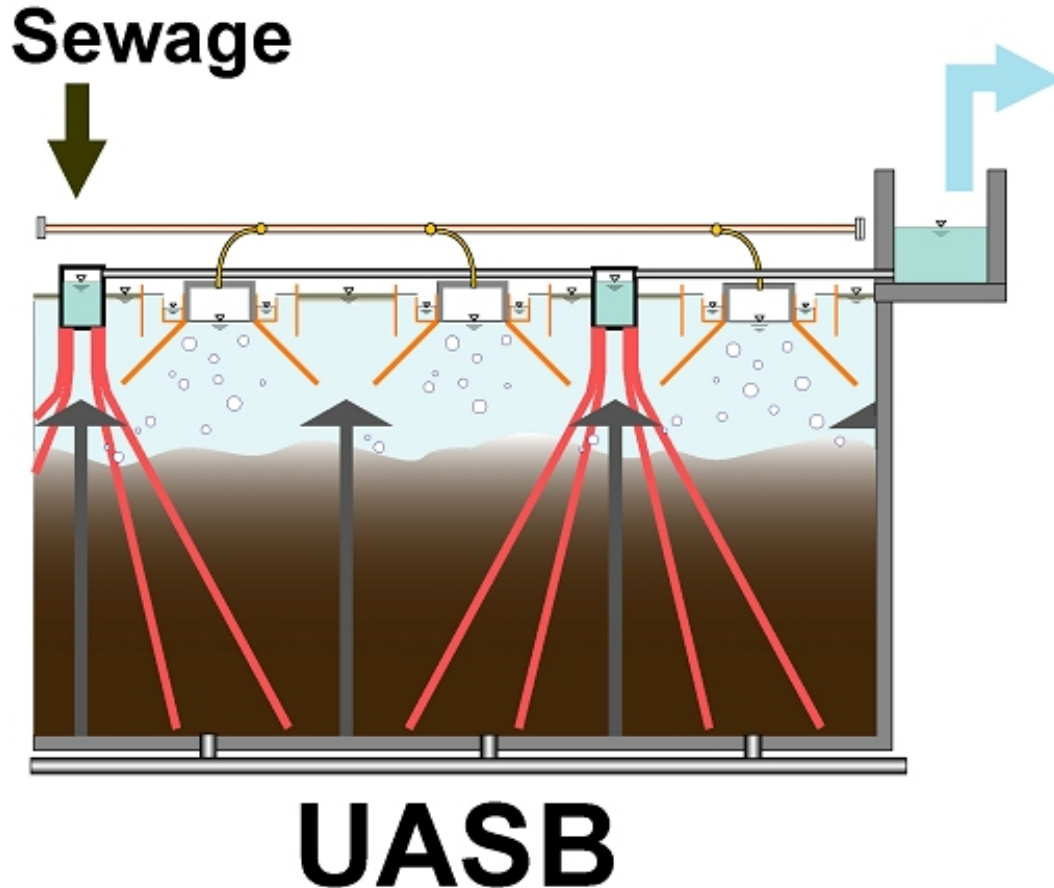

Post-treatment:

- Activated sludge ?
- Lagoons (aerated) ?
- Membrane systems ?
- Rotating Bio-Contactors ?
- Constructed wetlands ?
- Sand filtration ?
- Trickling filters ?
- Flocculation
- Flotation
- Physico-chemical ?
- Forced oxidation ?
- others ?????

**For Environmental Protection
the DESAR₃-concept (EcoSan) is
the most sustainable approach,
because it comprises:**

- Source separation, little if any dilution and merely on-site transport
- Application of NBMS-based waste & wastewater treatment
- Recovery and (on-site) reuse of resources.

The DESAR₃-concept.

(sustainable EP_{sus})

Big **progress in industrial sector**, self-interest big driving force. Many industries in frontline with almost complete DESAR₃

By tradition applied in **traditional agricultural practices**, although not for energy generation.

Represents the most recommendable EP_{sus}-tackle for the ***PuSan sector***, but ... where is the 'self-interest'? So far little progress!!

**Implementation of the DESAR₃-
concept in the PuSan- SECTOR only
can be realized over very prolonged
periods of time.**

We need a **smooth transition** of CENSA_{modern}
towards 'up to date' DESAR₃, implying the coming off
of parallel transitions in:

- waste(water) collection,
- waste(water) transport,
- waste(water) treatment
- reuse of recovered by-products.

Likely the first possible transition in existing CENSA-settings is:

Substituting conventional AeWT-systems by modern NBMS-systems, starting with high-rate ANWT-systems (especially at sewage temperatures > 18 °C)

At sewage temperatures $> 18\text{ }^{\circ}\text{C}$:

a simple “one-step UASB-system”
frequent already suffices!

- in **tropical regions** all the year round ,

- in **sub-tropical and moderates** climate
zones during summer time (e.g. in touristic
regions)



The 64 m³ demonstration UASB-plant in Cali Colombia (1983-1989)



1500 m³ UASB-reactors and an aerated pond for sewage (Piracicaba, Brazil)

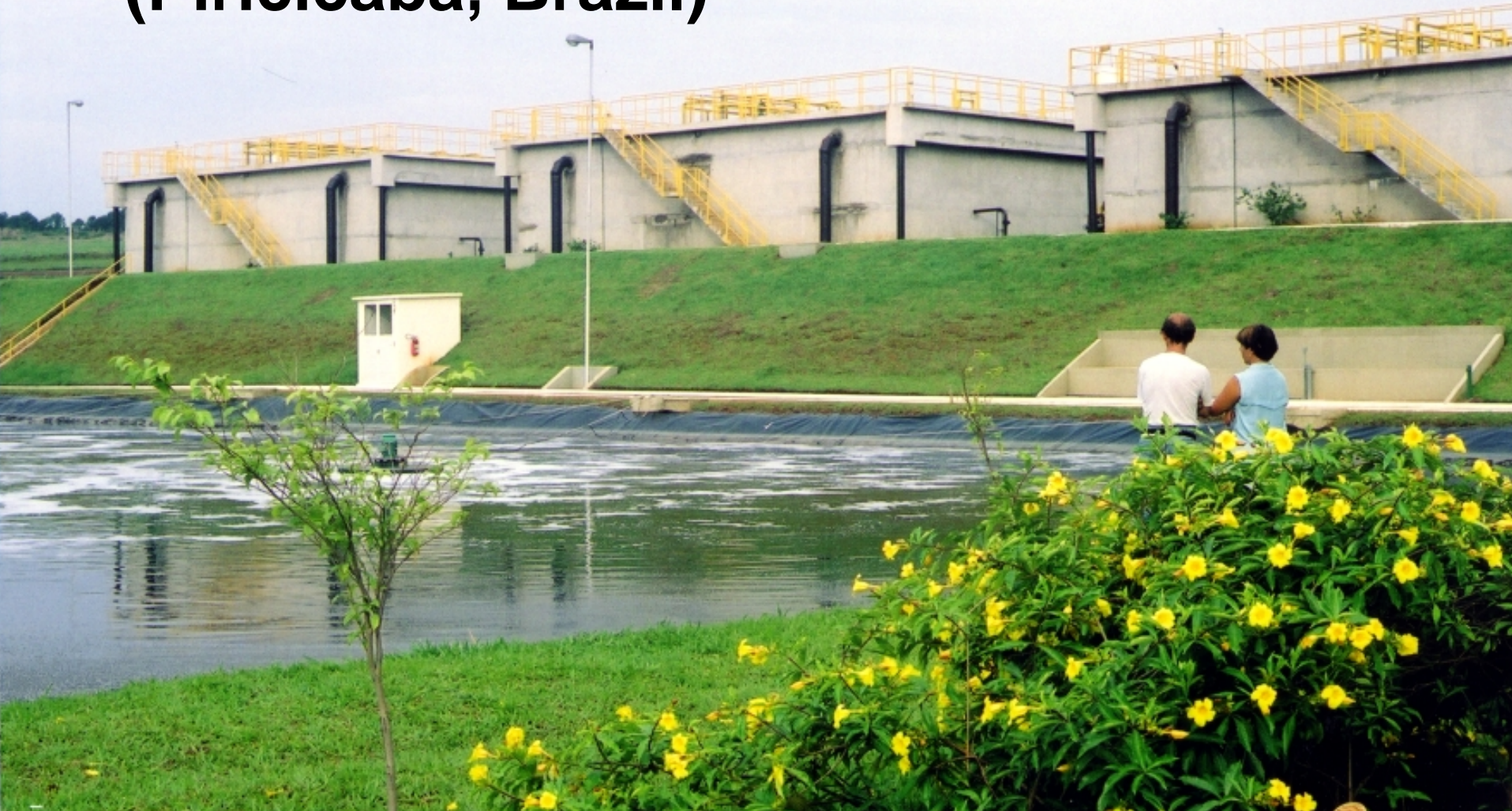

**6000 m³ UASB-installation in Accra
(Ghana)
for appr. 200,000 people.**





Modern updates of AnWT-systems For sewage Pre-treatment.

- **One step systems:** UASB-reactors,
- **More-step systems:** UASB/AF/EGSB reactors

The Micro-aerobic post-treatment step.

One and/or two step micro-aerophilic RBC-reactor highly efficient in removing:

- Mal-odorous compounds and reduced inorganic compounds (at HRT < 15 min),
- $COD_{biodeg,sol}$ at HRT: 30-150 min (depending of the quality of the effluent),
- Colloidal matter/pathogens at HRT in the range 30- 150 min. (depending on the effluent quality).

Big potentials for UASB + Ae_{micro} WT
post-treatment at temperatures $> 18^{\circ}\text{C}$

(UASB- A_{plus} – reactor system)

An impression of a UASB-A_{plus} – reactor, here equipped with a biorotor system

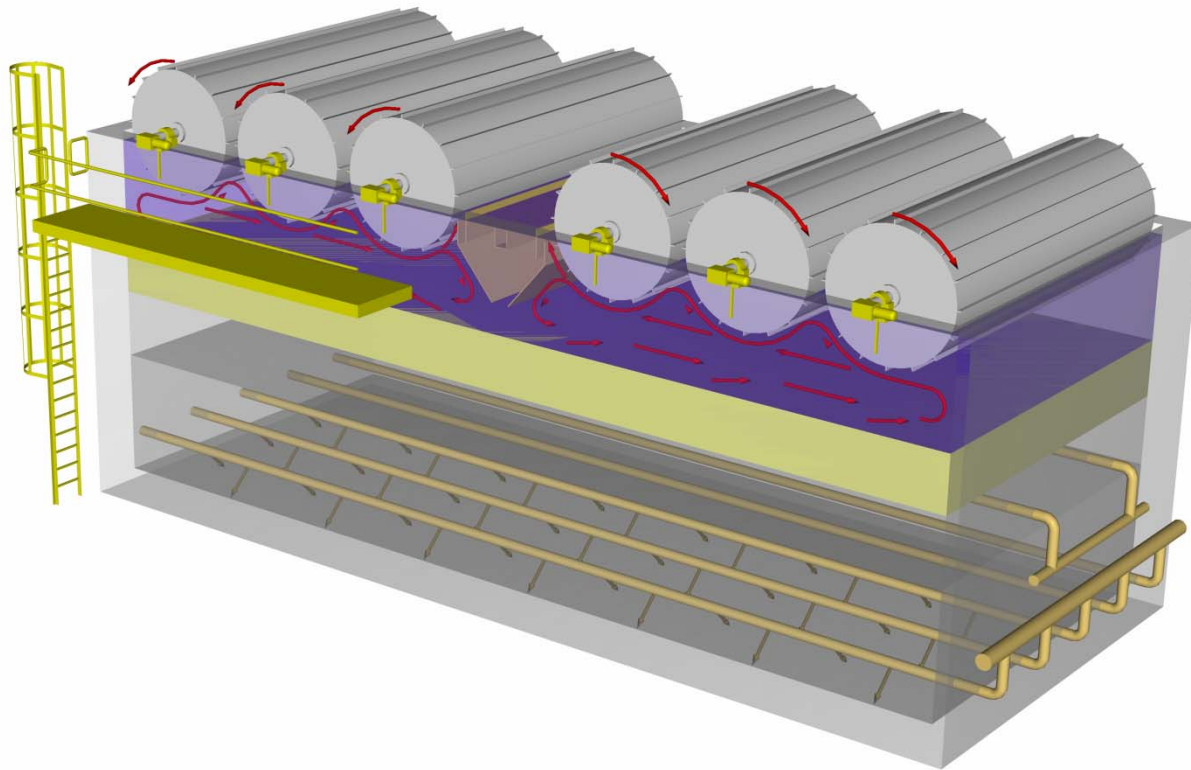

Integrated anaerobic treatment – post treatment, Bra

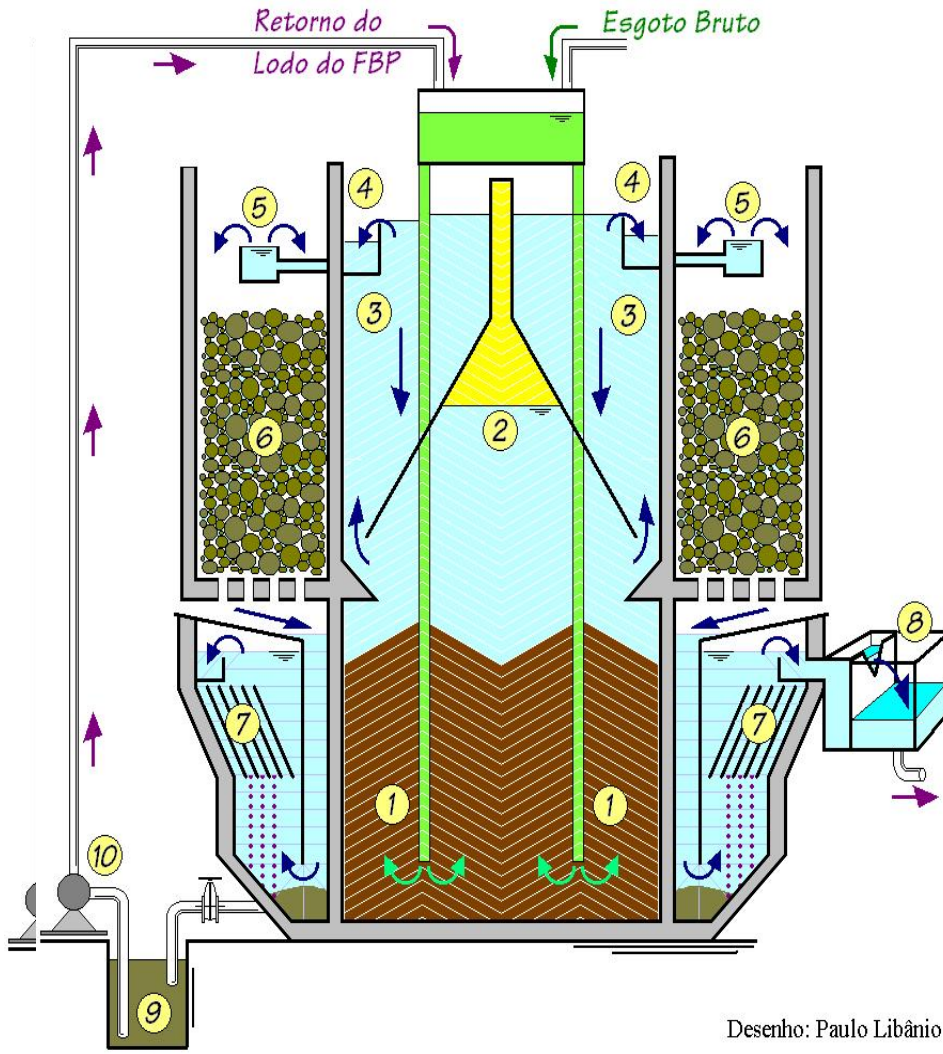

Also for winter time conditions in sub-tropical and moderate climate zones there exist big potentials for NBMS-systems, viz.

The **UASB/AD- A_{plus} reactor** system which can use the Ae_{micro} WT-unit :

- **in front of the UASB**
(as high rate A-step conform *Böhnke, 1978*),
and/or
- **the Ae_{micro} WT-unit as first post treatment step**

Two stage system is more appropriate for the anaerobic treatment of domestic sewage at low temperature than one stage (Mahmoud, et al 2004).

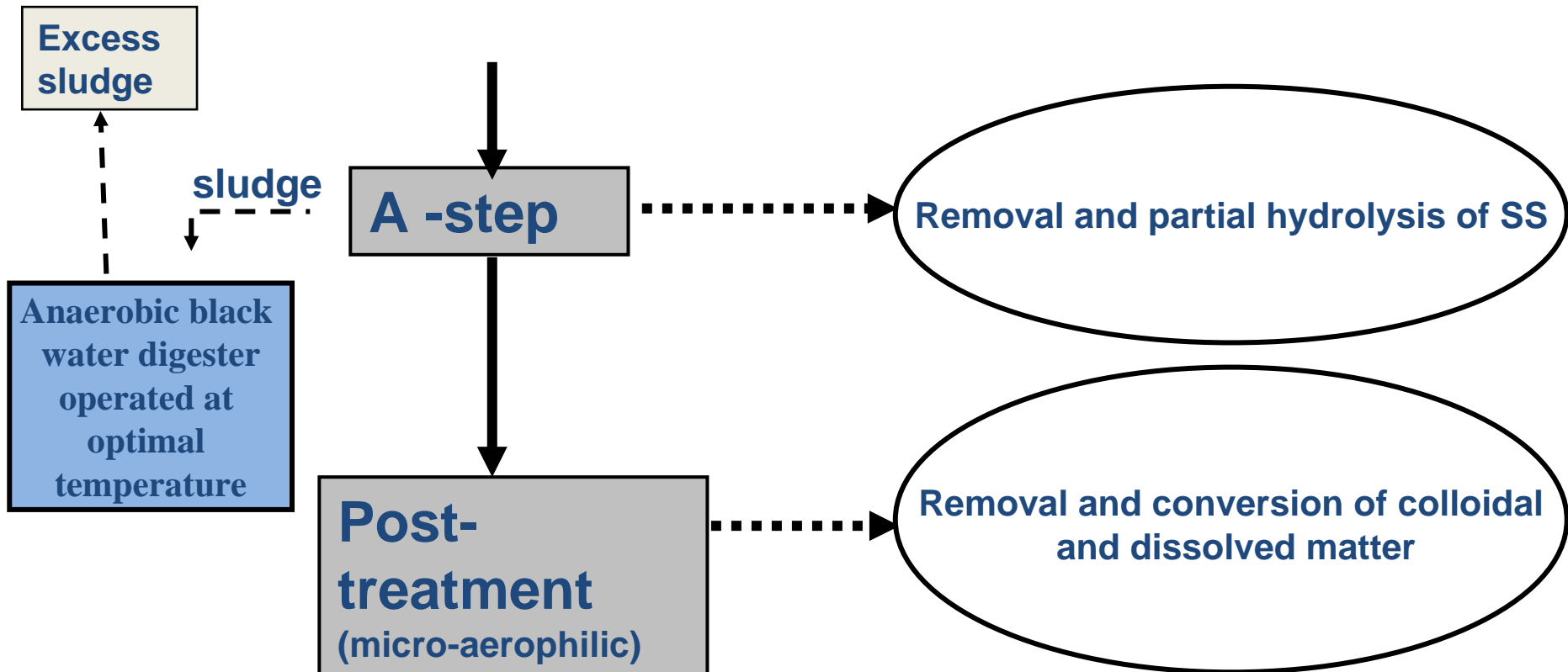

The benefits of substitution of conventional AeWT-systems in existing sewage treatment plants by NBMS-systems (*although it is not the optimal DESAR₃-approach*)

- Substantial lower space requirements,
- Substantial saving of energy,
- Simpler treatment process,
- Much less **excess sludge problems**,
- Saving in investment and operational costs,
- Applicable at almost any scale,
- Enables the gradual implementation of DESAR₃ in down-town area's,

Basic setup of conventional aerobic treatment

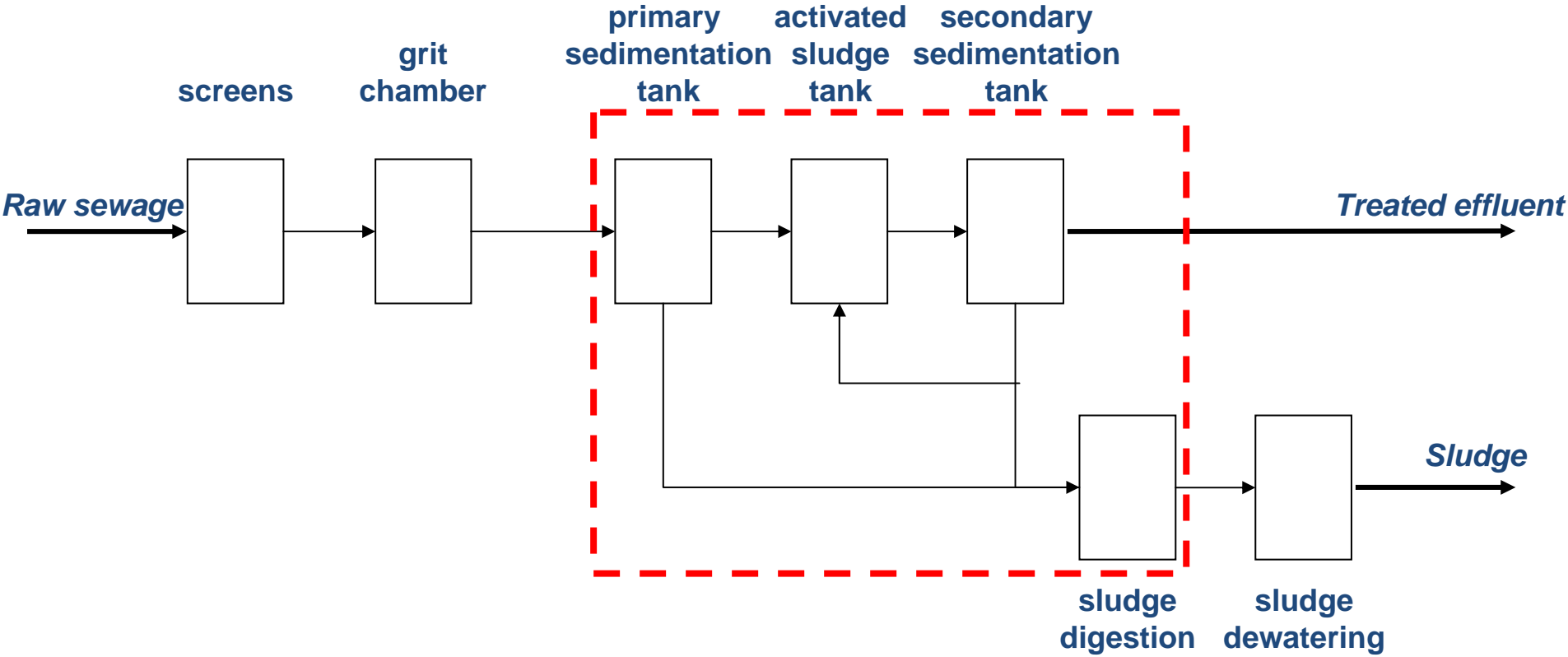

Basic setup for anaerobic treatment

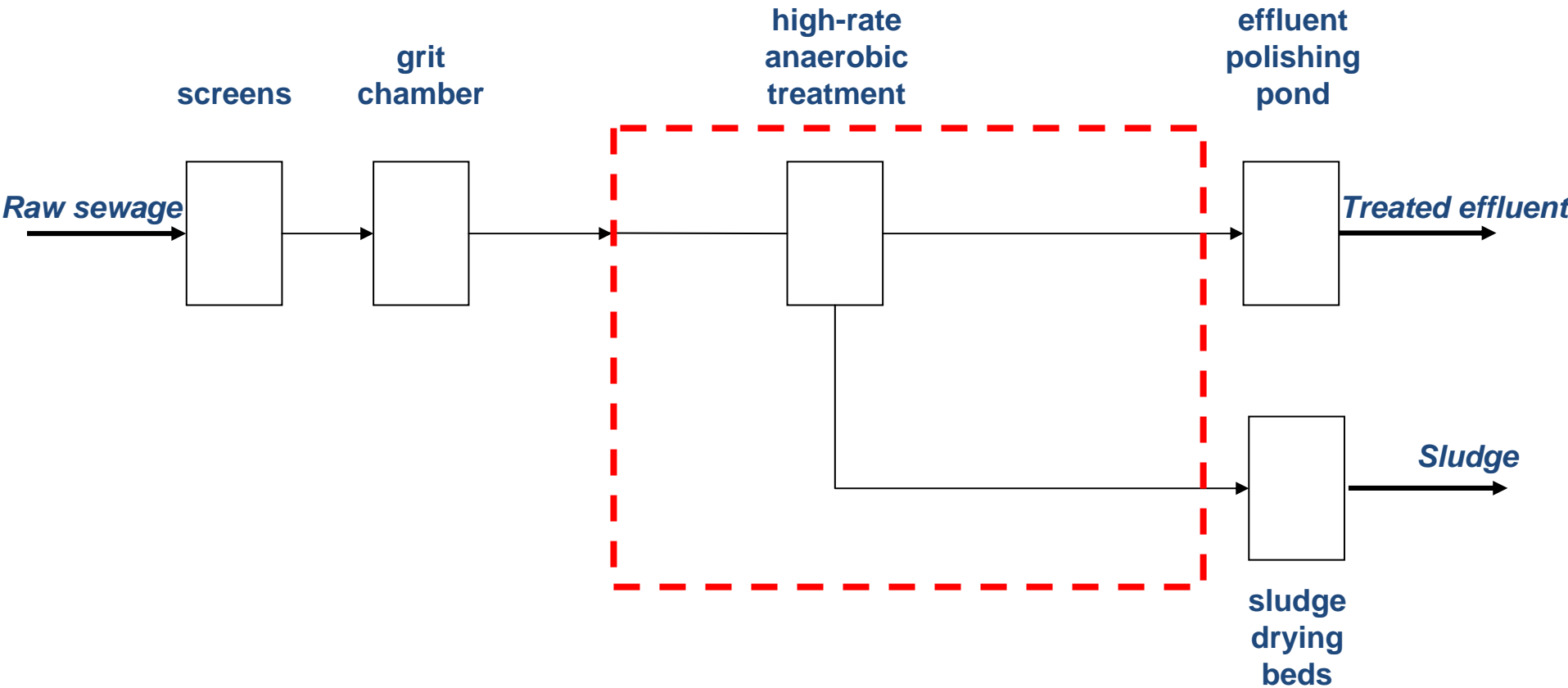



Aerobic WW-treatment plant Amsterdam, The Netherlands

1000 m³/d Demonstration Scale DHS Biotower in Karnal, India

Constructed by Indian Government, under Yamuna Action Plan (YAP)



DHS Biotower (1000 m³/d)



Wastewater distributor

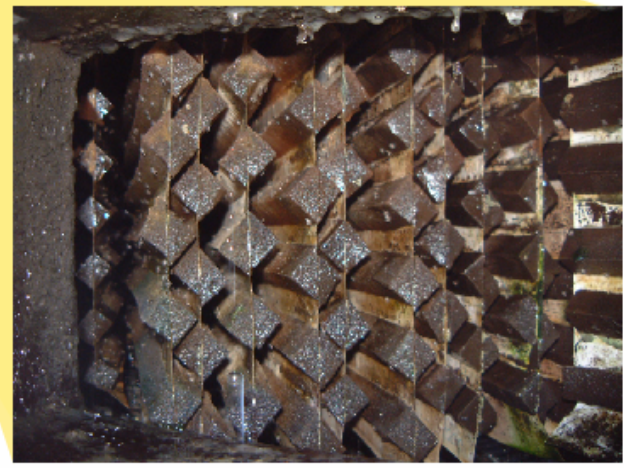

Sponge curtains inside the biotower

HRT: 1.5h
P.E. 7,000

In operation since Sept. 2002

Comparison of performance of DHS Biotower and FPU at 40 MLD Karnal-STP

Parameter	Raw wastewater (sewage influent)	UASB effluent	DHS Biotower effluent	FPU (Final Polishing Unit) effluent
pH	6.6 - 7.7	6.8 - 8.0	7.4 - 8.2	7.0 - 7.7
DO, mg/L	0	0	5.42 (0.84)	0
BOD-total, mg/L	142 (52)	46 (16)	6.2 (5)	38 (18)
CODcr-total, mg/L	459 (163)	181 (57)	37 (17)	139 (47)
CODcr-soluble, mg/L	153 (54)	78 (29)	24 (14)	62 (21)
Fecal coli. , MPN/100 ml	$7.8 \times 10^4 - 1.7 \times 10^7$	$4.9 \times 10^4 - 1.4 \times 10^7$	$3.3 \times 10^3 - 5.4 \times 10^5$	$2.0 \times 10^4 - 1.6 \times 10^7$
NH ₄ -N, mg/L	17 (6)	20 (7)	5 (6)	20 (10)
NO ₃ -N, mg/L	ND	ND	6 (2)	2 (1)
Suspended solids, mg/L	233 (75)	89 (25)	12 (7)	71 (19)
Turbidity, FAU	258 (73)	132 (27)	18 (7)	111 (25)
Ambient temp. ,°C	6 - 40			
DHS Biotower Flowrate, MLD	1.0			
Removal		UASB	UASB + DHS Biotower	UASB + FPU
BOD-total, %		65 (14)	96 (3)	71 (17)
CODcr-total, %		57 (15)	91 (5)	66 (15)
Suspended solids, %		59 (14)	95 (4)	68 (13)
NH ₄ -N, %		-	80 (19)	-
Fecal coli., log		0.0 (0.4), 37.2%	2.3 (0.6), 99.0%	1.0 (0.5), 81.7%

() Standard deviation, ND not detectable

Middle East research on anaerobic pre-treatment: Amman



Lagoons for treating domestic sewage of city of Aman, Jordan, about 50 km outside the city!



Compared to existing traditional CENSA-situations, NBMS-systems can be implemented much easier:

- In big private buildings (hospitals), settlements,**
- When expensive renovations are needed,**
- In new real estate situations.**

Ultimately we need to proceed in the PuSan-practice towards DESAR₃ in order to:

- Prevent health risk and environmental pollution (limit use of clean water),**
- Reduce investment, operational and maintenance costs,**
- Reduce vulnerability in EP, improve self-sufficiency (community participation)**
- Strengthen Resource Recovery and Reuse**

Composition of black water (Netherlands)

	Urine	Faeces	Total
N	85%	11.5%	96.5%
Organic Matter	2%	52%	54%
P	46%	35%	81%
K	62%	25%	97%

Volume of urine + faeces: 1.2 l/cap./day

The interest in moving to DESAR₃-application in the PuSan-practice is growing in Europe, especially in:

- New real estate situations (neighbourhoods, hospitals, schools, hotels, apartment buildings etc.),
- In existing situations when private decision making is sufficiently strong for take own measures!
- In existing CENSA-situations when costly renovations have to be made and public authorities take the 'risks' to move in a new concept (paradigm).....
- Situations where most EP-measures still need to be taken.

Anaerobic treatment can be applied quite well 'on the site' (in separate buildings, houses and neighbourhoods, consequently building on-site and community on-site up to > >1000 houses, depending on the location) for:

- **black water**
- **combined black + grey water**
- **solid organic wastes as well**
- **mixed domestic wastewater.**

UASB: options for decentralised sewage treatment



Campina Grande, Brasil



Odemira, Portugal

**Masterplan of Recife metropolitan area: decentralised approach
(Florencio *et al.*, 2001)**

On-site anaerobic pre-treatment systems

- **Septic tanks, Imhoff tank,**
- **Pit latrines,**
- **Improved septic and Imhoff tanks,**
- **Accumulation type digesters (mixed and non- mixed).**

Improved (upflow) septic tank system

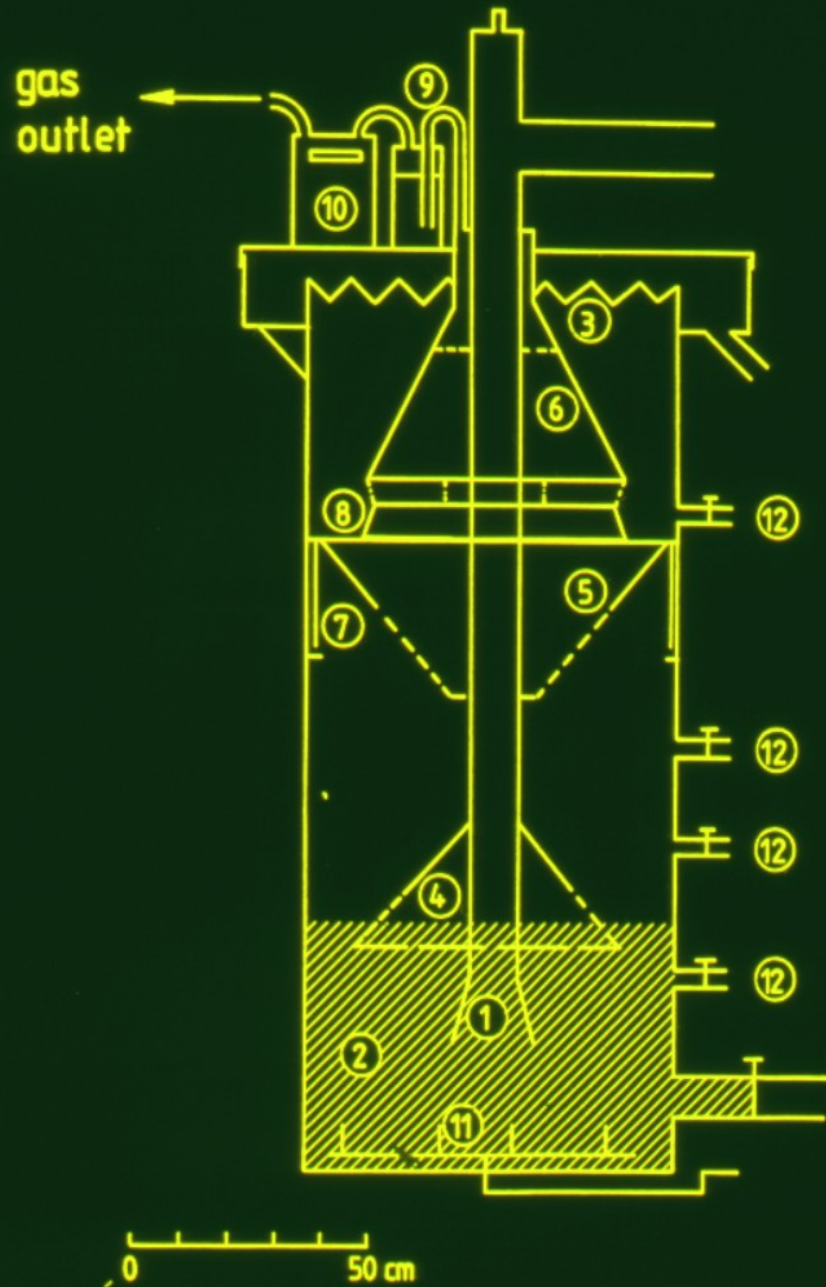

**Performance data obtained in a 0.86 m³ UASB-septic tank system
(at 25-30 °C) with:**

- **black water (COD: 5.5 g/l) and**
- **black + grey water (COD: 1.35 g/l)**

**black water
(HRT= 15 days)**

**black + grey water
(HRT = 1.4 days)**

COD	90 - 93	67 - 77
BOD	92 - 95	up to 82
TSS	93 - 97	74 - 81
CH₄-prod. (L/day/pe)	12 - 15 (65 % CH₄)	12 - 15 (80 % CH₄)

**An ideal solution in urban public sanitation
and energy supply:**

‘The Greenhouse Village’

(Noor van Andel, Jon Kristinsson, Adriaan Mels)

A multidisciplinary approach in PuSan and Energy supply:

**sanitary-, chemical- and civil engineers,
biotechnologists, (bio)chemists, microbiologists,
irrigation experts and agronomists,
economists and sociologists,
architects, household scientist,
health care specialists,
common citizens.**

What is Greenhouse Village?

Greenhouse for:

- **collection of heat (using innovative highly efficient heat exchanger)**
- **production of e.g. food crops and clean water**

Aquifer technology for :

- **storage of warm/cool water for heating /cooling houses and greenhouse**

Decentralized NBMS-based wastewater treatment for:

- **production energy (biogas/electricity),**
- **production CO₂, fertilizers and compost**

Technical scheme of Greenhouse

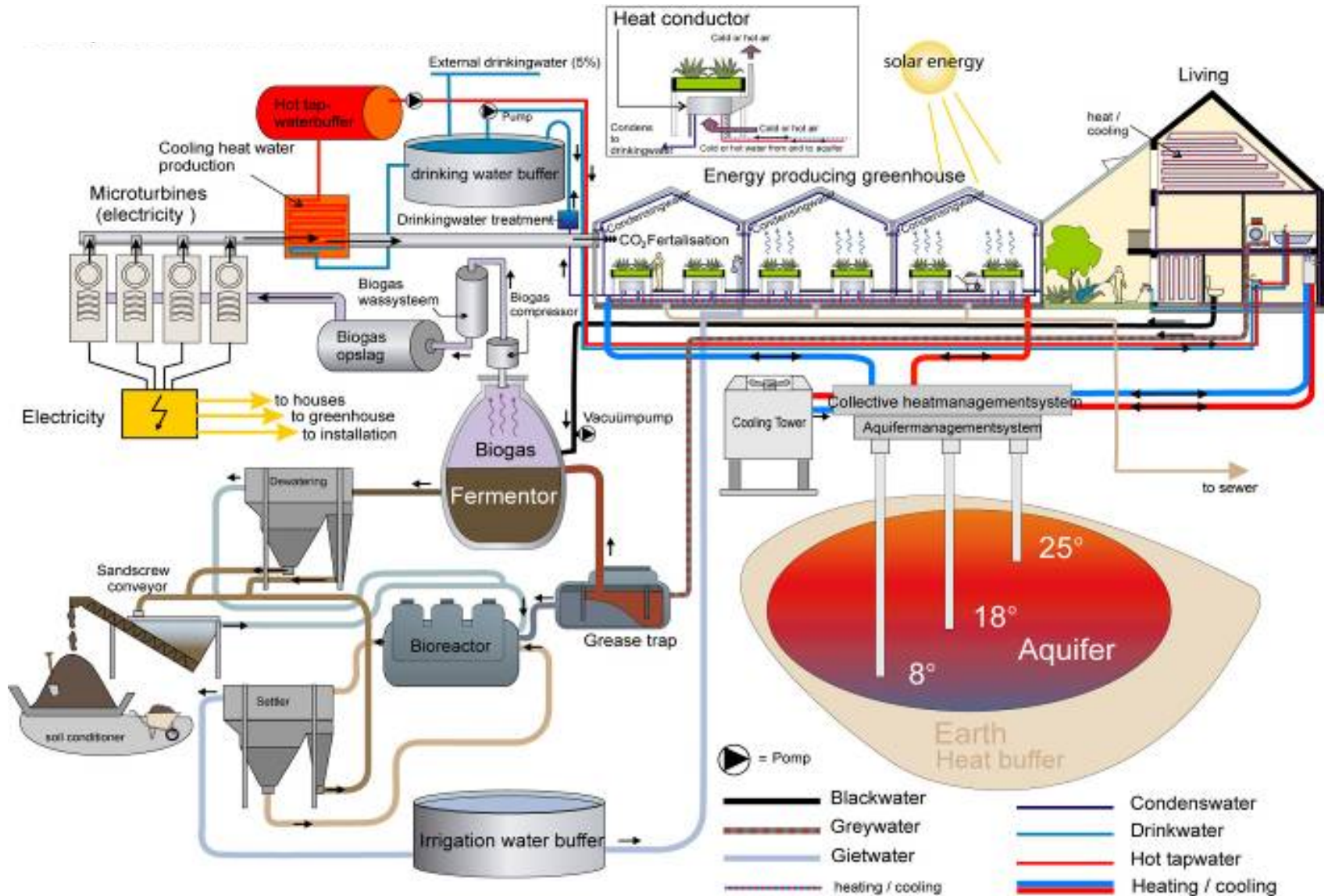

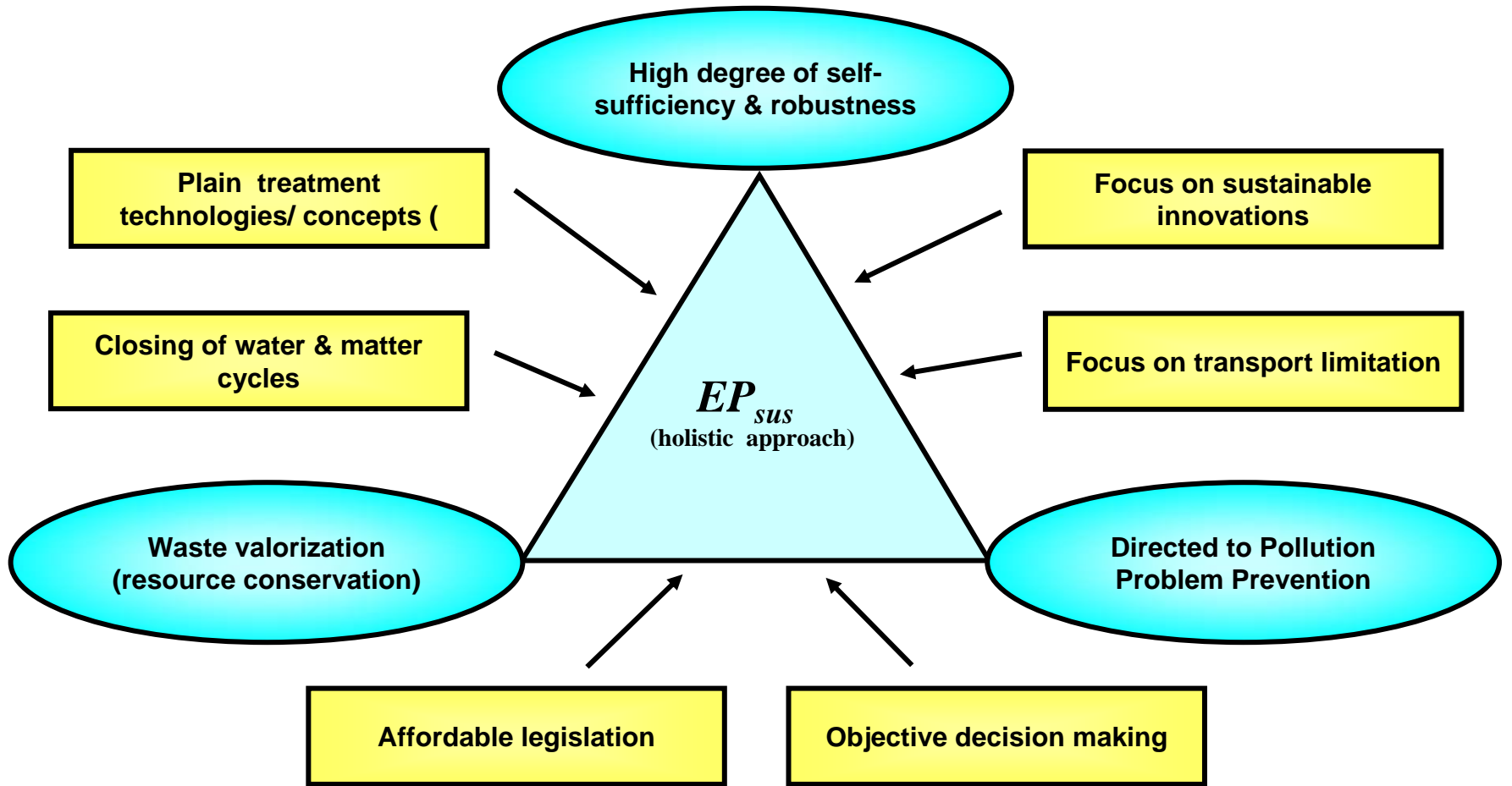

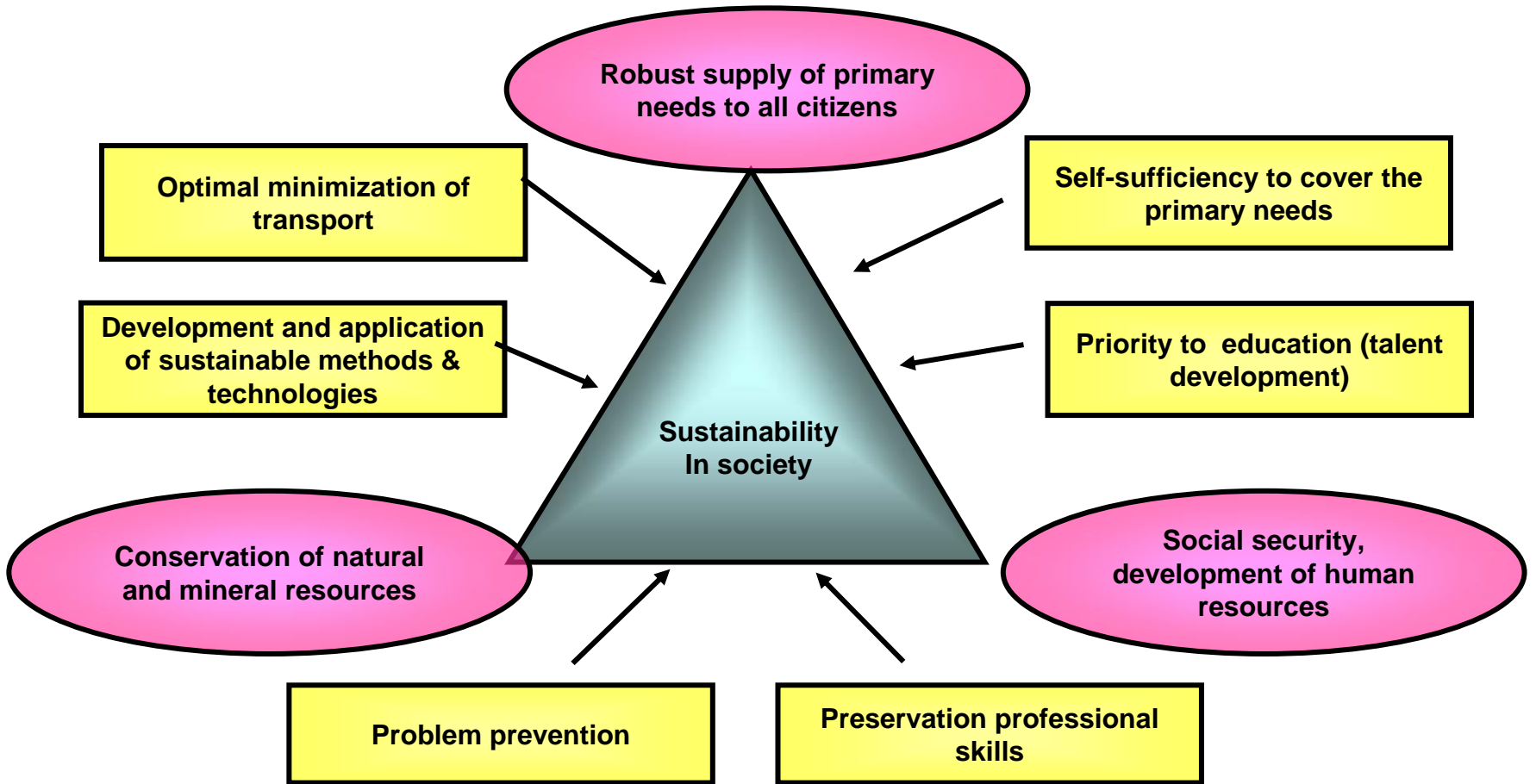

Conclusions

- For realizing Ep_{sus} we need conceptual innovations (paradigm change); most of the required tools are already available.
- In order to make progress towards $DESAR_3$ we need multidisciplinary cooperation and proper public decision making (with more real democracy).
- In view of their enormous principle advantages (e.g. economical) AnDeg-systems represent a excellent crowbar to realize more **SUSTAINABILITY** in society.