



# Rural Water Supply

67751 v1

## Volume I

# Design Manual

## **Disclaimer**

The findings, interpretations, and conclusions expressed in this work are those of the writer and do not necessarily reflect the views of the World Bank. The information in this work is not intended to serve as legal advice. The World Bank does not guarantee the accuracy of the data included in this work and accepts no responsibility for any consequences of the use of such data.

These manuals may be reproduced in full or in part for non-profit purposes without prior permission provided proper credit is given to the publisher, The World Bank Office Manila.

### **The World Bank Office Manila**

23<sup>rd</sup> Floor, The Taipan Place  
F. Ortigas Jr. Road, Ortigas Center  
1605 Pasig City, Metro Manila, Philippines

**Manila, Philippines**

**February 2012**

**Cover Design:** The images on the cover were derived from two photographs courtesy of the DILG. The inset photo with a girl is from "The Innocent" by Mr. Jason Cardente. The boy filling water bottles is from "Water for Drinking" by Mr. Dan Ong. Some elements in the originals may have been altered for purposes of the design.

# Rural Water Supply

---

Volume I

# Design Manual



WATER  
PARTNERSHIP  
PROGRAM







MALACAÑAN PALACE  
MANILA


## MESSAGE

I congratulate the institutions, agencies, and individuals of the water sector for your collaborative publication of the **Rural Water Supply Manual**.

This Manual is the latest of many multi-sectoral efforts to extend the availability of safe water to our countrymen. Water security is a critical issue that we must address, for it is essential to maintaining the well-being and dignity of human life. Thus, I am heartened by our steady progress in this regard – significantly decreasing the number of families without access to water from over 27 million in the 1990s to less than 16 million at present. These accomplishments are in no small part due to the cooperation among agencies and institutions and the support given by their leadership, who have established the necessary programs and administrative mechanisms to enable a dynamic exchange of skills and expertise.

To sustain the gains that we have achieved in securing the safety and accessibility of our water resources, our government is set on formulating and implementing a unifying framework that will harmonize the work of all engaged stakeholders in the water sector, in order to enhance support and ensure that the provision of safe water becomes a universal, self-sustaining aspect of our total development as a nation.

With your continued enthusiasm, I am confident that we can meet and perhaps even surpass our Millenium Development Goal for safe water. Equitable growth can only be accomplished by integrating social justice as the central component of our development agenda, applying a fair and equal treatment of every individual under the law and by our institutions. Let us work together to realize our shared aspiration of a sustainable Philippines.



BENIGNO S. AQUINO III

MANILA  
February 2012



# Foreword

## Purpose of this Manual

This **RURAL WATER SUPPLY DESIGN MANUAL** is the first of three related volumes prepared for the use of prospective and actual owners, operators, managements, technical staff, consultants, government planners and contractors of small Level III and Level II water supply systems in the Philippines.

Its purpose is to introduce the key concepts and considerations involved in the design of small waterworks facilities for Level II and III systems.<sup>1</sup> For the technical persons, hopefully it will facilitate their work by providing them with a ready resource reference for their everyday use. For the non-technical readers, such as the many who are involved in the management and operation of small water supply systems, hopefully it will be an aid in understanding the design process, giving them a basis for participating in decisions that would enable them to avail more usefully of the services of the technical consultants and contractors they must deal with.

Overall, the local and international partners who cooperated in making these Manuals possible hope that they will help the participants in the rural water supply sector to understand better the nature of the water supply business, its responsibilities to the stakeholders, and the role of the government agencies and regulatory bodies that seek to help them operate sustainably while protecting the consumers.

## On the Use of the Manual

This **RURAL WATER SUPPLY DESIGN MANUAL** and the companion volumes in the series can at best serve as a general reference and guide. As they refer to the information, recommendations, and guidelines contained in them, readers are urged to consider them always in relation to their own specific requirements, adapting and applying them within the context of their actual situation.

Even as they refer to this Manual for information, its users are advised to consult with qualified professionals – whether in the private sector, in the local governments, or in the regulatory and developmental agencies concerned with the water sector – who have had actual experience in the construction, management, operation, maintenance, and servicing of water supply systems and utilities – including those other professionals who can help them in the financial, legal and other aspects of their small water supply business.

---

<sup>1</sup> A few of the topics covered may also be relevant to Level I systems, which consist of a single well or pump serving a limited number of beneficiaries at source. However, it was felt unnecessary to focus on Level I systems requirements in this work as the design, engineering, operational and maintenance requirements of Level I systems – as well as the organizational and training support – are adequately provided by the relevant government agencies and supported by non-government agencies.

## Manual Organization

The three volumes in this series of RURAL WATER SUPPLY MANUALS are as follows:

**Volume I: DESIGN MANUAL.** – Its purpose is to introduce and give the reader the key design concepts in the design of waterworks facilities. For non-technical readers who are involved in the management and operation of small water supply systems, rather than in their actual design and construction, the text of Volume I will be useful in understanding and in making decisions that would enable them to avail more usefully of the services of the technical consultants and contractors they must deal with.

**Volume II: CONSTRUCTION SUPERVISION MANUAL.** – This volume presents the considerations, requirements, and procedures involved in supervising a waterworks project. How these are implemented should be clear to one who supervises, inspects, or manages such a project. For this reason, the details of implementation are covered in the chapters on Pipeline and Pumping Facilities Installation, Concrete and Reservoir Construction, Water Sources, Metal Works, and Painting.

**Volume III: OPERATION AND MAINTENANCE MANUAL.** – This volume focuses on the small water system as a public utility, and answers the question “What are the requirements to effectively manage and sustainably operate a small utility?” It covers the institutional and legal requirements of setting up a water supply business, the demands of ensuring water safety through proper treatment, the nature and requirements of operating and maintaining the water distribution system, and its administration, commercial, financial, and social aspects.

# Acknowledgements

Deep appreciation is extended to the following for the cooperation and support given during the pilot activities and preparation of the Manuals:

## Department of Interior and Local Government

*Hon. Jesse M. Robredo, Secretary*  
*Hon. Austere A. Panadero, Undersecretary*  
*Ms. Fe Crisilla M. Banluta, Project Manager*  
*Mr. John M Castaneda, Director, OPDS*  
*Ms. Rolyn Q. Zambales, Assistant Director, OPDS*  
*Senior Staff of the WSSU*

## National Water Resources Board

*Mr. Vicente S. Paragas, Executive Director*  
*Atty. Nathaniel C. Santos, Deputy Executive Director*  
*Mr. Jorge M. Estioko, Division Chief*  
*Senior staff of NWRB*

## Local Water Utilities Administration

*Mr. Salvador C. Ner, Acting Administrator*  
*Mr. Edgardo C. Demayo, Acting Manager, WD Development Department*  
*Mr. Ernesto de Vera, Manager, Project Planning Division*  
*Mr. Angelito C. Bernardo, Manager, Project Monitoring & Evaluation Division*

## Department of Public Works and Highways

*Hon. Rogelio L. Singson, Secretary*  
*Mr. Ernesto S. Gregorio, Jr., Project Director, PMO-RWS/CARP*  
*Mr. Virgilio G. Gacusana, Assistant Director, PMO-RWS/CARP*  
*Mr. Dindo S. Taberna, Technical Coordinator, PMO-RWS/CARP*


## Department of Health

*Hon. Enrique T. Ona, Secretary of Health*  
*Mr. Joselito M. Riego de Dios, Chief Health Program Officer*  
*Engr. Ma. Sonabel S. Anarna, Supervising Health Program Officer*

## National Anti-Poverty Commission

*Hon. Jose Eliseo M. Rocamora, Secretary*  
*Hon. Patrocinio Jude H. Esguerra, Undersecretary*  
*Ms. Cynthia A. Ambe, Senior Technical Officer III*





The project team also acknowledges **Engr. Ramon L. dela Torre, Engr. Yolanda Mingoa, Mr. Victoriano Y. Liu, Jr., Mr. Simplicio C. Belisario, Jr., Mr. Nasser Sinarimbo, and Ms. Mariles R. Navarro** for their collaboration and unfailing support.

For the professional advice and their comments and inputs in enhancing the Manuals, the team also extends its gratitude to the following: **Ms. Elizabeth L. Kleemeier**, Senior Water & Sanitation Specialist, TWIWA, World Bank (WB); **Ms. Ly Thi Dieu Vu**, Consultant, EASVS, WB; **Mr. Shyam KC**, Disaster Risk Management Specialist, EASIN, WB; **Mr. Alexander V. Danilenko**, Senior Water Supply and Sanitation Engineer, WSP, WB; and **Mr. Virendra Kumar Agarwal**, Consultant, WB.

The team would also like to express profound thanks to the WB Country Management Unit and fellow EASPS colleagues for their encouragement, invaluable support and commitment: **Mr. Motoo Konishi**, Country Director, **Mr. Bert Hofman**, former Country Director; **Mr. N. Vijay Jagannathan**, Sector Manager, Infrastructure Unit, Sustainable Development Department, East Asia and Pacific Region (EASIN); **Mr. Sudipto Sarkar**, Practice Leader for Water, EASIN; and **Mr. Mark C. Woodward**, Sustainable Development Leader, Philippines.

Finally, acknowledgements are extended to the **Water Partnership Program (WPP)**, which made funds available for the development and publication of these Manuals.

These Manuals were prepared under the guidance of **Mr. Christopher C. Ancheta**, Task Team Leader, World Bank. The Project Team was composed of the following: **Engr. Antonio R. de Vera**, Lead Consultant, **Mr. Gil S. Garcia**, **Mr. Jerome Vincent J. Liu**, **Mr. IoanNikhos Gil S. Garcia**, **Ms. Abegyl N. Albano**, **Ms. Demilour R. Ignacio**, and **Ms. Jeannette Ann R. Wiget**.

# Acronyms & Abbreviations

## Government and Other Organizations

<b>ASTM</b>	American Standard for Testing Materials	<b>DPWH</b>	Department of Public Works & Highways
<b>AWS</b>	American Welding Society	<b>LWUA</b>	Local Water Utilities Administration
<b>AWWA</b>	American Water Works Association	<b>NIOSH</b>	National Institute for Occupational Safety and Health (United States)
<b>BIR</b>	Bureau of Internal Revenue	<b>NSO</b>	National Statistics Office
<b>CDA</b>	Cooperative Development Authority	<b>NWRB</b>	National Water Resources Board (formerly NWRC)
<b>DAR (ARISP)</b>	Department of Agrarian Reform, Agrarian Reform Infrastructure Support Program	<b>NWRC</b>	National Water Resources Council
<b>DILG</b>	Department of Interior & Local Government	<b>SEC</b>	Securities & Exchange Commission
<b>DOH</b>	Department of Health	<b>WHO</b>	World Health Organization

## Technical & Operational Terms, Units of Measure

<b>AC</b>	alternating current	<b>D or diam</b>	diameter
<b>ADD</b>	average daily demand	<b>dm</b>	decimeter
<b>AL</b>	allowable leakage	<b>Elev</b>	elevation
<b>BOD</b>	Biological Oxygen Demand	<b>EV</b>	equivalent volume
<b>CAPEX</b>	capital expenditure	<b>F/A</b>	Force/Area
<b>CBO</b>	Community-Based Organization	<b>g</b>	grams
<b>cc</b>	cubic centimeter	<b>G.I. pipe</b>	Galvanized iron pipe
<b>CIP</b>	cast iron pipe	<b>GPM</b>	gallons per minute
<b>cm</b>	centimeter	<b>HGL</b>	hydraulic grade line
<b>COD</b>	chemical oxygen demand	<b>hm</b>	hectometer
<b>CPC</b>	Certificate of Public Conveyance	<b>HP</b>	horsepower
<b>CT</b>	Contact Time	<b>HTH</b>	High-Test Hypochlorite
<b>cumecs</b>	cubic meters per second	<b>IDHL</b>	Immediately Dangerous to Life and Health
<b>dam</b>	dekameter	<b>kg</b>	kilograms
<b>Dep</b>	depreciation expenses	<b>kgf</b>	kilogram force

<b>km</b>	kilometer	<b>Opex</b>	operational expenses
<b>kPa</b>	kilopascals	<b>Pa</b>	Pascal
<b>KPIs</b>	key performance indicators	<b>PE pipe</b>	polyethylene pipe
<b>LGUs</b>	Local Government Units	<b>PEER</b>	property and equipment entitled to return
<b>lm</b>	linear meter	<b>PNS</b>	Philippine National Standards
<b>lpcd</b>	liters per capita per day	<b>PNSDW</b>	Philippine National Standards for Drinking Water
<b>lps</b>	liters per second	<b>psi</b>	pounds per square inch
<b>m</b>	meter	<b>PVC pipe</b>	polyvinyl chloride pipe
<b>m<sup>2</sup></b>	square meter	<b>PWL</b>	pumping water level
<b>m<sup>3</sup></b>	cubic meter	<b>ROI</b>	return on investment
<b>m<sup>3</sup>/d</b>	cubic meters per day	<b>RR</b>	revenue requirements
<b>MaxNI</b>	maximum allowable net income	<b>RWSA</b>	Rural Water & Sanitation Association
<b>MDD</b>	maximum day demand	<b>SCBA</b>	self-contained breathing apparatus
<b>mg/l</b>	milligrams per liter	<b>SMAW</b>	shielded metal arc welding
<b>mm</b>	millimeter	<b>SSWP</b>	Small-Scale Water Provider
<b>mld</b>	million liters per day	<b>SWL</b>	static water level
<b>mm/hr</b>	millimeters per hour	<b>TDH</b>	total dynamic head
<b>MOA</b>	Memorandum of Agreement	<b>TDS</b>	total dissolved solids
<b>N/m<sup>2</sup></b>	Newtons per square meter	<b>VC</b>	volume container
<b>NGO</b>	Non-Government Organization	<b>VIM</b>	variation in mass
<b>NPSH</b>	net positive suction head	<b>Wc</b>	container
<b>NPSHa</b>	net positive suction head available	<b>Wcm</b>	container + material
<b>NPSHr</b>	net positive suction head requirement	<b>WHP</b>	water horsepower
<b>NRW</b>	non-revenue water	<b>WL</b>	water level
<b>NTU</b>	Nephelometric turbidity unit		
<b>O&amp;M</b>	operation and maintenance		
<b>OD</b>	outside diameter		

# Table of Contents

<b>Chapter 1 Introduction .....</b>	<b>1.1</b>
A. The Philippine Water Sector Experience.....	1.1
B. Considerations for a Sustainable System.....	1.3
C. The Water System Design Process.....	1.3
D. Design Outputs.....	1.4
<b>Chapter 2 The Nature and Importance of Water.....</b>	<b>2.1</b>
A. The Physical and Chemical Nature of Water .....	2.1
B. Uses and Importance of Water.....	2.2
C. The Hydrologic Cycle.....	2.2
D. Factors Altering the Water Cycle .....	2.4
<b>Chapter 3 Water Demand.....</b>	<b>3.1</b>
A. General.....	3.1
B. Service Level Definitions .....	3.1
C. Design Period .....	3.2
D. Design Population .....	3.3
E. Water Consumptions .....	3.6
F. Non-Revenue Water (NRW).....	3.7
G. Water Demand.....	3.7
<b>Chapter 4 Water Sources .....</b>	<b>4.1</b>
A. Water Resources.....	4.1
B. Basic Climatology of the Philippines .....	4.1
C. Classification of Water Sources.....	4.4
<b>Chapter 5 Water Quality.....</b>	<b>5.1</b>
A. Water Quality.....	5.1
B. Water Quality Tests.....	5.1
C. Components of Water Quality .....	5.3
<b>Chapter 6 Development of Water Sources.....</b>	<b>6.1</b>
A. Rainwater .....	6.1
B. Springs.....	6.2
C. Infiltration Wells .....	6.6
D. Surface Water Supplies.....	6.8

<b>Chapter 7 Wells .....</b>	<b>7.1</b>
A. General Plan of Action .....	7.1
B. Well Hydrology.....	7.1
C. Classification of Wells Based on Aquifer Tapped.....	7.3
D. Rehabilitation/Improvement of Existing Wells.....	7.3
E. Types of Wells Based on Design and Construction Methods .....	7.7
F. Tests of Well Suitability.....	7.14
G. Well Site Selection .....	7.15
H. Designing a Drilled Well .....	7.16
I. Well Drilling.....	7.20
<b>Chapter 8 Source Capacity Measurements.....</b>	<b>8.1</b>
A. Introduction .....	8.1
B. Measurements of Discharge .....	8.1
C. Measurement of Water Levels in Wells.....	8.5
<b>Chapter 9 Preventing Pollution of Sources .....</b>	<b>9.1</b>
A. Pollution and Infiltration.....	9.1
B. Protecting Wells.....	9.2
C. Formation Sealing of Springs .....	9.4
D. Underground Pollution .....	9.4
E. Pollution from Mining .....	9.4
<b>Chapter 10 Water Treatment .....</b>	<b>10.1</b>
A. General.....	10.1
B. The Design of Water Treatment for Level II Facilities.....	10.1
C. Raw Water Sources .....	10.1
D. Selection of Treatment Process .....	10.3
<b>Chapter 11 Applied Hydraulics .....</b>	<b>11.1</b>
A. Factors Determining Pipe Flow Rates .....	11.1
B. Water Pressure .....	11.2
C. Friction Loss .....	11.3
<b>Chapter 12 Transmission and Distribution Systems.....</b>	<b>12.1</b>
A. Introduction .....	12.1
B. Methods of Water Transmission and Distribution .....	12.1
C. Pipeline Hydraulics.....	12.2



D.	Transmission System.....	12.4
E.	Distribution System.....	12.6
F.	Pipe Network Analysis.....	12.9
G.	Pipeline Design Criteria.....	12.13
H.	Protecting the Water Quality in the Distribution System.....	12.13
I.	Pipeline Materials Selection.....	12.14
J.	Appurtenances for Transmission and Distribution Mains .....	12.16
K.	Public Faucets/Service Connections .....	12.17
<b>Chapter 13 Reservoirs.....</b>		<b>13.1</b>
A.	Introduction .....	13.1
B.	Types of Reservoirs .....	13.1
C.	Design of Reservoirs.....	13.5
D.	Reservoir Appurtenances.....	13.5
E.	Samples of Reservoir Design .....	13.6
<b>Chapter 14 Pumping Facilities.....</b>		<b>14.1</b>
A.	Introduction .....	14.1
B.	Considerations in Pump Selection .....	14.2
C.	Terminology and Definitions.....	14.3
D.	Types of Pumps .....	14.4
E.	Pump Performance Curves .....	14.10
F.	Pump Installation .....	14.11
G.	Prime Movers.....	14.11
H.	Pump Control .....	14.11
I.	Design of Pumps.....	14.12
<b>Annexes.....</b>		<b>A.1</b>
	Table of Annexes .....	A.1
<b>References.....</b>		<b>A.42</b>

## List of Tables

Table 1.1: Sample Specifications .....	1.6
Table 3.1: Sample Growth Rate Projections.....	3.4
Table 5.1: Water Quality Parameters to be Tested.....	5.2
Table 5.2: Minimum Frequency of Sampling for Drinking-Water Supply Systems for Microbiological Examination .....	5.2
Table 5.3: Standard Values for Physical and Chemical Qualities for Acceptability .....	5.6
Table 9.1: Pollution Sources .....	9.1
Table 10.1: Treatment Options .....	10.4
Table 11.1: Friction Head Loss in meters per 100 meters in Plastic Pipe.....	11.5
Table 11.2: Friction Head Loss in meters per 100 meters Galvanized Iron (GI) Pipes .....	11.6
Table 11.3: Head Loss Due to Valves and Fittings .....	11.7
Table 12.1: Recommended Pipe C-Values (New Pipes).....	12.3
Table 12.2: Characteristics of Different Pipe Materials .....	12.15

## List of Figures

Figure 2.1: Hydrologic or Water Cycle.....	2.3
Figure 4.1: Climate Types of the Philippines .....	4.3
Figure 6.1: Rainwater Harvesting .....	6.1
Figure 6.2: Spring Box with Permeable Side.....	6.5
Figure 6.3: Spring Box Design with Permeable Bottom .....	6.6
Figure 6.4: Details of an Infiltration Well .....	6.7
Figure 7.1: Well Hydrology .....	7.2
Figure 7.2: Manual Percussion Rig .....	7.9
Figure 7.3: Reverse Rotary Drilling .....	7.12
Figure 7.4: A Down-the-Hole (DTH) Rig.....	7.13
Figure 7.5: Sections of a Drilled Well.....	7.16
Figure 7.6: Screen Types.....	7.19
Figure 8.1: V-Notch Weir .....	8.3
Figure 8.2: Measuring Discharge from a Horizontal Pipe.....	8.4
Figure 8.3: Electrical Sounder/Electrical Depth Gauge .....	8.6

Figure 9.1: Private Pollution Sources .....	9.2
Figure 9.2: Sanitary Sealing of Drilled Wells.....	9.3
Figure 10.1: Cascading Aerators.....	10.5
Figure 10.2: Plan View – Slow Sand Filter .....	10.6
Figure 10.3: Slow Sand Filter Sections.....	10.7
Figure 11.1: Pipe Flow and HGL.....	11.1
Figure 12.1: Profile of a Transmission Pipeline from Source to Distribution System .....	12.6
Figure 12.2: Distribution System Basic Layouts.....	12.8
Figure 12.3: Typical Detail of a Single Public Faucet .....	12.18
Figure 12.4: Typical Detail of a Double Public Faucet .....	12.19
Figure 12.5: Details of Service Connections .....	12.20
Figure 13.1: Ground Level Concrete Reservoir.....	13.2
Figure 13.2: Diagram of a Floating Reservoir .....	13.3
Figure 13.3: Diagram of a Draw and Fill Reservoir .....	13.4
Figure 13.4: Prismatic Tank Volume.....	13.7
Figure 14.1: Head Terms Used in Pumping .....	14.3
Figure 14.2: Centrifugal Pump.....	14.5
Figure 14.3: Submersible Pump .....	14.7
Figure 14.4: Reciprocating Pump .....	14.8
Figure 14.5: Pump Performance Curve .....	14.10



# Chapter 1

## Introduction

This Chapter presents the major considerations in the design of successful small water supply systems such as are appropriate to serve the populations in rural areas and small towns in the Philippines.

### A. THE PHILIPPINE WATER SECTOR EXPERIENCE

Starting in the 1970s, the Philippine Government introduced certain developmental practices and concepts to strengthen the water sector and expand its coverage of the population. These led to the improved overall sustainability of water utilities, the establishment of more small water systems, the institutionalization of support for all water service levels, and the increase in commitments of development funds to maintain the positive impetus that had been created.

While these practices and concepts were applied initially to advance sector-wide objectives, the lessons learned are relevant today in the conceptualization, planning, strategy-setting, operation and expansion of the individual small utility. They can be summarized as follows:

#### 1. Demand-Based Design

In 'greenfield' areas or areas where no water supply system is in place, a demand-based approach that considers what consumers want and are willing to pay for was adopted in determining design and service levels. This approach departs from the traditional mode of estimating water demand based on purely engineering considerations, and is more attuned to preferences of consumers and to their ability and willingness to pay. The traditional mode often led to costly, over-designed systems that were unsustainable. For example, consumers in small towns have daily per capita consumption of 80 to 100 liters, compared to standard engineering design parameters of 120 to 150 lpcd. The demand-based approach lowers the cost of investment and translates into more affordable tariffs and sustainable operations.

#### 2. Phased Design

In designing systems, the concept of having a master plan for each utility (with a design horizon of 10-20 years) was adopted but implemented in phases. The initial phase was designed to address only the service demand projected for the initial years, but provided for eventual expansion. The implementation of subsequent phases was made contingent on increases of the revenue base and service demand, and on the creditworthiness of the utility. This realistic, conservative approach also helped to



prevent the overdesign of the system and introduced the concept of cost recovery tariffs.

### **3. Use of Updated Technology**

The new technologies introduced, like geo-resistivity surveys to determine the sites and design of wells, computerization, new drilling methodologies, and hydraulic networking models – were an important boon for the effective planning and operation of water utilities.

### **4. Operational Autonomy**

Water districts (WDs), water cooperatives and rural water & sanitation associations (RWSAs) were operated by boards chosen from the community. They retained all their water revenues, which were used for defraying operational costs, debt service and as reserves for the utility business. These organizations also had to source their own funds either from internally generated cash or loans. The financial autonomy and discipline that had to be adopted by these utilities helped greatly to improve their management and operation.

### **5. Tariff Design and Public Consultation**

The tariff mandated by government policies is designed as a full-recovery tariff which all utilities must adopt. The law also requires all utilities to present in a public hearing or in a general membership assembly all petitions for tariff adjustments.

### **6. Institutional Development Practices**

Water districts (WDs) had to adhere to standard commercial practices and organizational structure guidelines developed by LWUA. The Billing and Collection System and the preparation of formal Financial Statements are examples of these commercial practices. Training programs were also developed for all staff levels within the WD, from the Board down to the operators.

### **7. Monitoring System**

Key Performance Indicators and operating standards were introduced and all WDs, water cooperatives, and grantees of Certificates of Public Conveyance (CPC)<sup>1</sup> of the National Water Resources Board (NWRB)<sup>2</sup> were required to submit monitoring reports at least on an annual basis. The monitoring system pinpointed the poor performing utilities and helped the regulators institute immediate remedial measures.

---

<sup>1</sup> A formal authority to operate a water utility

<sup>2</sup> NWRB is the Philippines' national economic regulatory body for private water systems.

## B. CONSIDERATIONS FOR A SUSTAINABLE SYSTEM

From the experience of the water sector, the considerations that determine a sustainable system fall into four major areas:

- 1. Technical Considerations** – From the outset, the design and construction of the system should be done right, using the appropriate technology, equipment and materials. It is clear that if a newly built system experiences high NRW or unaccounted-for water at the start of its operational life, the correction of the likely systemic deficiencies would be very expensive, disruptive of operations and revenue streams, and almost futile.
- 2. Financial Considerations** – Financial considerations have to do with building and operating the system at the least possible cost but in a way that meets all standards and the customers' requirements. These considerations must strike a balance between the acceptance and affordability levels of customers, on the one hand, and the appropriate cost recovery tariff structure, on the other, as the latter constitutes the primary source of funds needed to support the operational, maintenance and repair, and future requirements of the utility.
- 3. Social Considerations** – This means engaging the population and gaining the broad community support that is needed to initiate and carry out the public utility project. The interests and concerns of the various stakeholders, including the local officials, businesses, community leaders, and the homeowners as groups and individuals have to be considered and their views given the proper respect. A small town water business needs to operate with a strong social base to support its role as a public utility.
- 4. Environmental Considerations** – This means that the system should be built and operated in relation to its environment. It must be sure that its sources of water have not been, and will not be compromised by surrounding developments. At the same time it has to preserve the viability of its water sources, and to ensure that extractions are well within the limits of safe yields. During the construction and operational period, care must be taken to ensure that it does not cause pollution of the environment or degradation of adjacent aquifers waterways and bodies of water.

## C. THE WATER SYSTEM DESIGN PROCESS


The design of small water supply systems has to consider key decision areas related both to the facilities and to the operation and maintenance issues that the utility needs to address. The details of these decision areas, which are summarized below, are discussed in several chapters and an annex in this volume (referred below by Chapter and Annex) and in Chapter 8 of Volume III.

1. **Service Level** – The decision on service level or levels that the utility would provide should be based on a consultation process among the stakeholders. Service levels are discussed in Chapter 3.
2. **Water Demand Projections** – It is necessary to determine the design horizon for which the facilities will be designed, and project the population to be served annually over this horizon, the unit consumptions, and expected non-revenue water. These projections are based on the historical data on population growth and levels, as well as on analyses of current and future developments in the area to be served, their effects on income levels, and other information relevant to the drivers of water consumption. This will lead to a determination of how much water demand the system needs to support. These are discussed in Chapter 3.
3. **Facilities Designs** – The considerations, guidelines, and parameters of the different design elements for the components of small water systems are presented in the Chapters from 6 to 14.
4. **Capital Investment and O&M Costs** – Estimated Investment Costs are presented in Appendix C. The planner/designer will have to estimate the O&M costs based on the details of the proposed system, its water source, and facilities.
5. **Tariff Design** – Tariff design is discussed in Chapter 8: Financial Aspects in the companion “OPERATION AND MANAGEMENT MANUAL” (Volume III in this series on Rural Water Supply).
6. **Design Iteration** – Before plans are finalized, there is need to confirm if the facility, as proposed, meets the social criteria of affordability and acceptance. If the expected tariffs are too high or the unit investment cost is more than ₱ 15,000/connection (Level III), the proposed project should probably be redesigned starting from the reduction in service level objectives, lowering the standard for unit water consumption, and other measures to match the financial capabilities of the proposed users..
7. **Plans and Design Specifications** – Once all the agreements, design parameters, and assumptions are established, the detailed plans have to be prepared by professional engineers to ensure a well-balanced system that will fulfill its objectives, and to provide a detailed guide for the construction of the facilities.

Annex A gives additional details of the design steps, including a flowchart of the design process.

## D. DESIGN OUTPUTS

The Detailed Engineering Design outputs are the following:

- 
- 1. Engineer's Report** – This report contains special design provisions as well as a summary of the design standards used. (Refer to Annex C for Design Standards). Design provisions include: demand requirements, justification of any treatment process adopted, soil conditions as a basis for foundation design, distribution system analysis, and source description and justification.
  - 2. General Layout** – This is usually the first page of the detailed plans showing the name of the barangay/town covered, the CBO or agency in charge of the WS facilities, the location of major facilities (sources, reservoirs) and coverage of the pipe network.
  - 3. Detailed Plans** – These are also called the blueprints or working drawings. The designs of these facilities are explained in the chapters in this Manual covering the particular component of the facilities. Plans will include the locations, elevations, schematics, dimensions and elevations of all facilities.
  - 4. Specifications** – Specifications always accompany a set of working drawings. Specifications refer to one or a combination of the following criteria: the type of material to be used, installation and disinfection procedures, or the quality of workmanship. In general, specifications of materials refer to either the material used or the performance required. Specifications can be found in the different chapters of this Design Manual.

Among the different agencies, it is only the LWUA that has a complete set of specifications for water systems. It is suggested that the LGUs or CBOs concerned secure a copy of these specifications for reference or use it to the maximum extent possible.

Table 1.1 on the following page shows some examples of specifications.

- 5. Bill of Quantities and Cost Estimates** – The bill of quantities prepared during the detailed engineering phase will be used as the bill of quantities in the bid documents, and the cost estimates will be used as a basis of the agency estimate for the bid.

**Table 1.1: Sample Specifications**

<b>Plastic pipe materials</b>	All materials including pipe, fittings, valves and fire hydrants shall conform to the latest standards issued by the PNS 14:2004 or PNS-ISO 4427:2002 and be acceptable to the approving authority. In the absence of such standards, materials meeting applicable Product Standards and acceptable to the approving authority may be selected.
<b>Pavement concrete subject to heavy loads</b>	Unless otherwise indicated on the plans, the minimum concrete compressive strength for slabs on fill subjected to pneumatic tired traffic will be 4,000 pounds per square inch @ 21 days. Portland cement shall meet specifications of PNS 14:2004
<b>Drain pipe for ground reservoir</b>	The overflow for a ground-level storage reservoir shall open downward and be screened with twenty-four mesh non-corrodible screen. The screen shall be installed within the overflow pipe at a location least susceptible to damage by vandalism. The overflow pipe shall be of sufficient diameter to permit waste of water in excess of the filling rate
<b>Steel bars</b>	Rolled bars used for concrete reinforcement shall conform with PNS 49: 2002 requirements.
<b>Submersible pump</b>	The pump to be used shall have an operating characteristic of xxx m TDH and yyy lps at a minimum efficiency of 60% as indicated in its operating curve.
<b>Disinfection procedure</b>	All wells, pipes, tanks, and equipment which can convey or store potable water shall be disinfected in accordance with current AWWA procedures. Plans or specifications shall outline the procedure and include the disinfectant dosage, contact time, and method of testing the results of the procedure.



## Chapter 2

# The Nature and Importance of Water

This Chapter discusses the nature of water, the hydrologic cycle and climate change effects as they relate to the operation of a small public water utility business designed to supply the potable water needs of Philippine communities.

### A. THE PHYSICAL AND CHEMICAL NATURE OF WATER

Water is one of the most abundant substances on Earth without which life, it is said, cannot exist. It covers more than 70 per cent (70%) of the earth's surface and exists as vapor in the earth's atmosphere. It is considered as the universal solvent because of its ability to dissolve almost all organic and inorganic solids and gases it comes in contact with. For this reason, pure water is never found in nature. Even rainwater, the purest natural water, contains chemicals dissolved from the air. Pure water is obtained only by special methods of distillation and by chemical action in laboratories.

Pure water is a tasteless, odorless and colorless liquid. Water in liquid form is most dense at 4° C, (39.2° F). The density of water at this temperature is used as a standard of comparison for expressing the density of other liquids and solids. At 4° C, one liter of water weighs 1 kilogram (a density of 1 gram/cc). In its gas form as a vapor, water is lighter than air, thus, it rises in the atmosphere.

Other important properties of water are the following:

- At 4°C pure water has a specific gravity of 1.
- The density of pure water is a constant at a particular temperature, and does not depend on the size of the sample (intensive property). Its density however, varies with temperature and impurities.
- Water is the only substance on Earth that exists in nature in all three physical states of matter: solid, liquid and gas.
- When water freezes it expands rapidly adding about 9 % by volume. Fresh water has a maximum density at around 4° C. Water is the only substance whose maximum density does not occur when solidified. As ice is lighter than liquid water, it floats.
- The specific heat of water in the metric system is 1 calorie – the amount of heat required to raise the temperature of one gram one degree Celsius. Water has a higher specific heat than almost any other substance. The high specific heat of water protects living things from rapid temperature change.

## **B. USES AND IMPORTANCE OF WATER**

Uses of fresh water can be categorized as consumptive and non-consumptive. Consumptive water use is water removed from available supplies without return to a water resource system (e.g., water used in manufacturing, agriculture, and food preparation that is not returned to a stream, river, or water treatment plant). Non-consumptive water use refers to a water use that can be treated and returned as surface water. A great deal of water use is non-consumptive, which means that the water is returned to the earth as surface runoff.

### **1. Domestic Uses**

Small water utilities are primarily concerned with water for potable use, which is basically for the home. Aside from drinking, other domestic uses include washing, bathing, cooking and cleaning. Other household needs might include tending and watering of home gardens and the upkeep of domestic animals. Basic household water requirements have been estimated to average around 40 liters per person per day. The standard used for drinking water supplied by Level II and Level III utilities is potability, or water that can be consumed directly by drinking without risk of immediate or long-term harmful effects.

### **2. Other Uses**

Other use categories for water supplied by water utilities include Municipal, Irrigation, Power Generation, Fisheries, Livestock Raising, Industrial and Recreational uses.

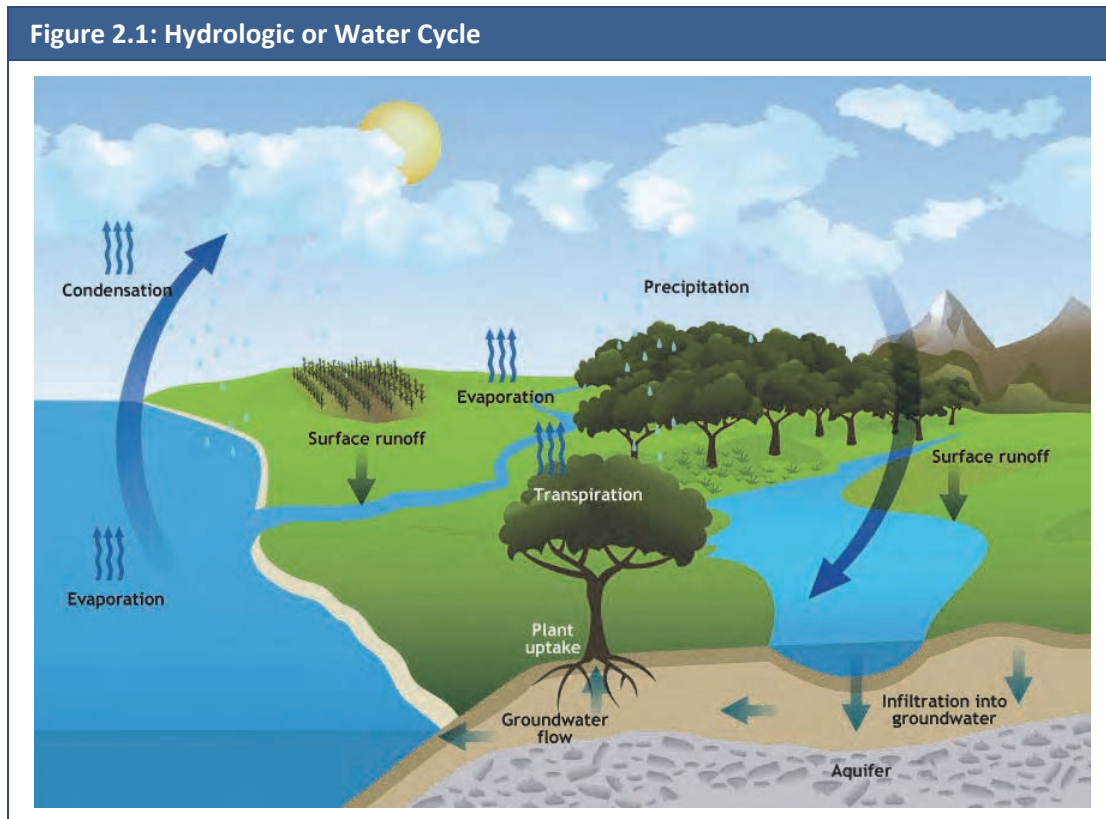
## **C. THE HYDROLOGIC CYCLE**

The hydrologic or water cycle (Figure 2.1) is a conceptual model published on the internet that describes the storage and movement of water on, above and below the surface of the Earth. Since the water cycle is truly a "cycle," there is no beginning or end. Water occurs in one of its three forms (solid, liquid and vapor) as it moves through this cycle. The water cycle consists primarily of precipitation, vapor transport, evaporation, evapo-transpiration, infiltration, groundwater flow, and runoff.

### **1. Water in the Atmosphere**

The sun, which drives the water cycle, heats water in oceans and seas. Water evaporates as water vapor into the air. Ice and snow may melt into liquid or sublimate directly into water vapor. Evapo-transpiration is water transpired from plants and evaporated from the soil. The water vapor rises in the atmosphere where cooler temperatures cause it to condense into clouds. As the air currents pick up and move the water vapor, cloud particles collide, grow, and fall out of the sky as precipitation. Where the precipitation falls as snow or hail, it can accumulate as ice caps and glaciers, which

can store frozen water for thousands of years. Snow packs can thaw and melt, and the melted water flows over land as snowmelt.



*Landscape for Life website ([http://landscapeforlife.org/give\\_back/3b.php](http://landscapeforlife.org/give_back/3b.php))*

## 2. The Bodies of Water

Most water falls back as rain into the oceans or onto land, where it flows over the ground as surface runoff. A portion of runoff enters rivers in valleys, where the stream flow moves the water towards the oceans. Some of the runoff and groundwater is sequestered and stored as freshwater in lakes. But not all the runoff flows into rivers or lakes; much of it soaks into the ground as infiltration.

## 3. Water in the Earth

Some of the water infiltrates deep into the ground and replenishes aquifers, which store freshwater underground for long periods of time. Some infiltration stays close to the land surface and can seep back into surface-water bodies as groundwater discharge. Some groundwater finds pathways that eventually lead to openings in the land surface, where it comes out as springs. Over time, the water returns to the ocean, where the water cycle started.

## 4. The Phenomena in the Water Cycle

The various phenomena that characterize the water cycle are as follows:

- **Evaporation** – Evaporation is the process by which liquid water is converted into a gaseous state. It takes place when the humidity of the atmosphere is less than the evaporating surface (at 100% relative humidity there is no more evaporation).
- **Condensation** – Condensation is the change in state of water from vapor to liquid when it cools. This process releases latent heat energy to the environment.
- **Precipitation** – Precipitation is any aqueous deposit (in liquid or solid form) that develops in a saturated atmosphere (relative humidity equals 100%) and falls to the ground. Most precipitation occurs as rain, but it also includes snow, hail, fog drip, and sleet.
- **Infiltration** – Infiltration is the absorption and downward movement of water into the soil layer. Once infiltrated, the water becomes soil moisture or groundwater.
- **Runoff** – This is the topographic flow of water from the area on which it precipitates towards stream channels located at lower elevations. Runoff occurs when the capacity of an area's soil to absorb infiltration has been exceeded. It also refers to the water leaving a drainage area.
- **Evapo-transpiration** – This covers the release of water vapor from plants into the air.
- **Melting** – Melting is the physical process of a solid becoming a liquid. For water, this process requires approximately 80 calories of heat energy for each gram converted.
- **Groundwater Flow** – This refers to the underground topographic flow of groundwater because of gravity.
- **Advection** – This is the movement of water in any form through the atmosphere. Without advection, water evaporated over the oceans could not precipitate over land.

### D. FACTORS ALTERING THE WATER CYCLE

Many factors have an impact on the normal workings of the water cycle. Some of these are either man-made, such as extent of agricultural and industry activities, deforestation and forestation, the construction of dams, the amount of water abstracted from surface and groundwater, and the effects of urbanization in terms of consumption and obstruction of the topographic flow of groundwater.

The other factors are those that influence climate change, which is basically manifested as a perceptible distortion of climate patterns. A large degree of uncertainty governs the understanding on how precipitation and temperature change leads to changes in runoff and river flows, flooding and drought patterns. The earth's climate has always changed, but it is the fast rate of change that is causing concern. As an example, there has been an increase of 0.61° C in the measured temperature in the Philippines from the 1950s to 2005.

About 86% of the global evaporation occurs from the oceans, which reduces their temperature by evaporative cooling. Without the cooling effect of evaporation, the earth would experience a much higher surface temperature. The rising temperatures will increase evaporation and result in increased rainfall. This situation may cause more frequent droughts and floods in different regions due to their variations in rainfall.

The Philippines suffered a severe drought in 1999 and two milder dry spells in 2004 and 2007. Droughts in the Philippines have destroyed millions of pesos worth of crops, reduced the country's water supply, and threaten widespread blackouts as power companies contend with low water levels in hydroelectric dams.

## **1. Responsibilities of Utilities in Relation to Climate Change**

For their part, utilities must do whatever is necessary to promote water conservation measures and reduce non-revenue water. The Philippines is highly vulnerable to the impacts of typhoons, flooding, high winds, storm surges and landslides. It is therefore incumbent on the water system designer to consider, on one hand, the location and features of the utility's facilities, so as to protect them from negative effects of the climate and environmental changes that are being felt; and, on the other hand, ensure that the operation of the utility will not harm the ecology and that its design and plans incorporate measures to avoid adding to risk factors that contribute to climate changes.

## **2. Climate Change Effects to Consider**

Climate changes have significant effects on the available sources of water, as well as on the competing demands on its use. Small water utilities have to be alert to these effects as they pose threats on their long-term viability and sustainability.

### **a. Climate Change Effects:**

1. Rising Sea Levels;
2. Increased saline intrusion into groundwater aquifers;
3. Water treatment challenges: increased bromide; need for desalination;
4. Increased risk of direct storm and flood damage to water utility facilities.

#### **b. Effects of Warmer Climate:**

1. Changes in discharge characteristics of major rivers due to upstream changes;
2. Changes in recharge characteristics of major groundwater aquifers due to upstream changes;
3. Increased water temperature leading to increased evaporation and eutrophication in surface sources;
4. Water treatment and distribution challenges;
5. Increased competing demands for domestic and irrigation;
6. Increased urban demand with more heat waves and dry spells;
7. Increased drawdown of local groundwater resources to meet the increasing water demands.

#### **c. Effects of More Intense Rainfall Events:**

1. Increased turbidity and sedimentation;
2. Loss of reservoir storage;
3. Water filtration or filtration/avoidance treatment challenges;
4. Increased risk of direct flood damage to water utility facilities.

### **3. Suggested Strategies to Mitigate Risks from Climate Change**


Within the capabilities of small water utilities are some strategies that they can implement either as part of their day-to-day operations, or as special measures in response to external developments.

#### **a. Water Conservation Measures:**

1. Meter all production and connections.
2. Reduce NRW.
3. Use tariff design to manage demand.
4. Disseminate water conservation tips to consumers.

#### **b. Design of Facilities**

1. If possible have at least 2 sources of supply at different locations.
2. Build superstructures above high flood line level.
3. Adopt energy-efficiency programs and, where possible, select facilities which require less power consumption.

- 
4. Monitor wells near coastlines to prevent salinization. If climate change causes sea levels to rise dramatically, even aquifers that have been sustainability utilized can suffer salinization.
  5. Utilize renewable energy sources.

**c. Reforestation of Watersheds:**

1. Join or initiate community programs for watershed reforestation. Enlist assistance from NGOs and the LGU units.
2. Enlist the support of the community in protecting the watersheds.

**d. Mitigation of Disaster Effects**

1. Form Disaster Response Committee.
2. Network with multi-sectoral organizations.





## Chapter 3

# Water Demand

This Chapter describes the method of determining the water volumes needed by a new small water utility project to supply the population it intends to cover.

### A. GENERAL

The first step in designing a Level II or small Level III water system is to determine how much water is needed by the population to be covered. The water to be supplied should be sufficient to cover both the existing and future consumers. It must include provisions for domestic and other types of service connections. In addition to the projected consumptions, an allowance for non-revenue water (NRW) that may be caused by leakages and other losses should be included.

Water demands are influenced by the following factors:

1. Service levels to be implemented;
2. Size of the community;
3. Standard of living of the populace;
4. Quantity and quality of water available in the area;
5. Water tariffs that need to be shouldered by the consumers;
6. Climatological conditions;
7. Habits and manners of water usage by the people.

Once the consumption demands are defined, the next step is to determine the service level as part of the demand analysis.

### B. SERVICE LEVEL DEFINITIONS

Water service levels are classified in the Philippines under three types<sup>3</sup>, depending on the method by which the water is made available to the consumers:

- **Level I (Point Source)** – This level provides a protected well or a developed spring with an outlet, but *without a distribution system*. The users go to the source to fetch the water. This is generally adaptable for rural areas where affordability is low and the houses in the intended service area are not crowded. A Level I facility normally serves an average of 15 households within a radius of 250 meters.

---

<sup>3</sup> NEDA Resolution No.5, Series 1998

- **Level II (Communal Faucet System or Stand Posts)** – This type of system is composed of a source, a reservoir, a piped distribution network, and communal faucets. Usually, one faucet serves four to six households within a radius of 25 meters. It is generally suited for rural and urban fringe areas where houses are clustered in sufficient density to justify a simple piped system. The consumers still go to the supply point (communal faucet) to fetch the water.
- **Level III (Waterworks System or Individual House Connections)** – This system includes a source, a reservoir, a piped distribution network, and individual household taps. It is generally suited for densely populated urban areas where the population can afford individual connections.

## C. DESIGN PERIOD

In commercial utility models, the design period normally spans long periods involving decades within which the initial capital outlay and succeeding outlays for expansion and rehabilitation can be rationally recovered. For small water utilities, including those owned by the local governments, such large outlays are not available and cannot be matched by the rural population's capacity to pay. For these reasons, the design period or horizon in this Manual is set at 5 or 10 years. In fact, these are the design periods frequently decided by agreements among the funder, the implementing agency, and the community or the LGU. In setting the design period, the designer should take into account the terms of the financing package and the potential consumers' capability and willingness to pay the amounts needed to support repayment.

The advantages and disadvantages for the 5- and 10-year options are:

### 1. Five-year design period

- **Advantages** – Low initial capital cost. If the project is to be financed through a loan, the loan amortizations are lower due to the lower investment cost.
- **Disadvantages** – Need for new capital outlays after five (5) years to upgrade system capacity. Most waterworks facilities, like reservoirs and pipelines are more viable to plan for a one stage 10-year period than to plan in two stages of 5-year period each.

### 2. Ten-year design period

- **Advantages** – The water system facilities are capable of meeting the demand over a longer period. No major investment cost is expected during the 10-year design period.
- **Disadvantages** – The higher initial capital cost will require initial tariffs to be set higher.

## D. DESIGN POPULATION

The design population is the targeted number of people that the project will serve. Examples in this section on population and water demand projections are based on the assumption that the design period is 10 years and the design year (or base year) is 2020.

There are 2 ways of projecting the design population.

1. Estimate the population that can be served by the sources. In this case, the supply becomes the limiting factor in the service level, unless a good abundant and proximate source is available in the locality.
2. Project the community or barangay population, and determine the potential service area<sup>4</sup> and the served population.

For purposes of illustration, the latter method is used throughout this Chapter. (The challenge is to discover and develop sources for populations in need of potable water supply. It is relatively simple to correlate the projected population to be served with the limitations of supply that may be determined using the first method.)

The historical population growth rates of the municipality/city/barangays are needed as the basis for population projections. The population is enumerated every 5 years (beginning on 1960, except in 2005 where it was moved to 2007 due to budgetary constraints). The latest national census was conducted for year 2010 but no official results have as yet been released by the NSO. These data can be obtained from the local governments themselves or from the National Statistics Office (NSO).<sup>5</sup>

Steps 1-3 below are used to determine the design population.

### 1. Projecting Annual Municipal and Barangay Growth Rates

The basic equations to be used to determine the average annual growth rate within the last censual period (in this case from 2000 to 2007):

$$P_{2007} = P_{2000}(1 + GR)^n$$

or

$$GR = \left( \frac{P_{2007}}{P_{2000}} \right)^{\frac{1}{n}} - 1$$

Where:

$P_{2007}$  = population in 2007

$P_{2000}$  = population in 2000

$GR$  = annual growth rate (multiply by 100 to get percent growth rate)

$n$  = number of years between the two census, in this case  $n = 7$

---

<sup>4</sup> Areas with pipes

<sup>5</sup> As of Oct 2010, the available census data are for years 2000 and 2007.

Using the above equations, the latest average annual growth rate GR for the municipality and its barangays (potential service area) can be determined. If a new census report is released by NSO, say for the year 2010, the above formula should be adjusted accordingly.

The latest historical GR of each covered barangay could then be projected every five years (2010, 2015, 2020). If no projections of population or growth rates are available for the municipality, the following assumptions can be used:

1. The maximum annual GR by year 2010 will be 2.5% (unless there is a planned development in the barangay that will boost immigration). It is assumed that the Government's population program and the public awareness of the issue will eventually temper high population growth. This is applicable to historical annual GRs that are more than 2.5%. Interpolation of the GR<sub>2007</sub> and GR<sub>2010</sub> will be done to get the GRs for the in-between years.
2. The minimum annual GR by year 2010 will be 1.0%. An annual GR of less than 1.0% for any barangay to be served is deemed unreasonably low considering that with the provision of accessible water supply, the barangay very likely will attract migrants. This is particularly applicable to historical annual GRs that are less than 1.0%. The GR<sub>2007</sub> and GR<sub>2010</sub> could then be interpolated to get the GRs for the in-between years.
3. For the reasons stated, the GRs within 1.0% to 2.5% will decrease by a modest 0.5% per year.

Table 3.1 shows a sample GR projection using the above method.

Table 3.1: Sample Growth Rate Projections						
Barangay	Population		Growth Rate (%)	Projected Annual Growth Rate (%)		
	2000	2007	2000 – 2007	2000 – 2010	2010 – 2015	2015 – 2020
Bgy 1	1,000	1,300	3.82	3.51	3.01	2.50
Bgy 2	2,000	2,300	2.02	1.99	1.94	1.89
Bgy 3	1,800	1,900	0.78	0.83	0.91	1.00

The projected growth rates are preliminary and should be examined if reasonable and realistic. These should be compared with projections, if any, from the Provincial and Municipal Planning and Development Offices. Adjustments on the computed GRs should be made as considered necessary.

## 2. Projecting Municipal and Barangay Populations

Having projected the annual growth rates, the year-by-year population projections for the municipality and barangays could then be computed by applying the basic equation

$$P_n = P_0(1 + GR)^n$$

Where:

$P_n$  = the projected population after nth year from initial year

$P_0$  = the population in the initial year of the period concerned

$GR$  = the average growth rate between the 2 periods

$n$  = number of years between  $P_0$  and  $P_n$

To project, for example, the population for the years 2010, 2015 and 2020, the equation is substituted as follows:

$$Pop_{2010} = actual\ Pop_{2007}(1 + projected\ GR_{2007-2010})^3$$

$$Pop_{2015} = Pop_{2010}(1 + projected\ GR_{2010-2015})^5$$

$$Pop_{2020} = Pop_{2015}(1 + projected\ GR_{2015-2020})^5$$

The population for the years in-between are projected by using the same basic equation and applying the respective growth rates for the periods.

### 3. Projecting the Population Served

After determining the projected population for each of the barangays, the next step is to determine the actual population to be served. Some of the residents may not ask for the service, and some will be too far from the distribution system. Determining the actual potential users involves but is not limited to the following activities:

1. Preparation of base maps;
2. Ocular inspection to gain familiarity with the physical and socio-economic conditions of the potential service area. Note that population densities must be estimated;
3. Delineation of the proposed service area (where the pipes are to be laid);
4. Determination and assessment of the level of acceptance by the residents of the planned water system. A market survey is recommended, in which one of the questions to be asked is if the respondent is willing to avail of the service, and how much is the respondent willing to pay per month for a Level II or a Level III service;
5. Assessment of the availability and abundance/scarcity of alternative water sources, such as private shallow wells, dug wells, surface waters, etc.

The percentage of those willing to avail of the planned water service could be adopted in the plan for the initial year of operation. The annual increase from the initial year up to the end of the design period will have to be assumed by the planner. For this he/she will have to consider the general economic capacity of the families and other pertinent information. For every year, the served population is estimated by applying the percentage of willingness to the projected population, per barangay, for the year.

## E. WATER CONSUMPTIONS

Water consumptions served by small water utilities are commonly classified into Domestic Use, Commercial Use, Institutional Use, or Industrial Use. In rural areas, water consumption is generally limited to domestic uses, i.e., drinking, cooking, cleaning, washing and bathing. Domestic consumption is further classified as either Level II consumption (public faucets) or Level III consumption (house connections).

### 1. Unit Consumptions

Unit consumption for domestic water demand is expressed in per capita consumption per day. The commonly used unit is liters per capita per day (lpcd). If no definitive data are available, the unit consumption assumptions recommended for Level II and Level III domestic usages in rural areas are as follows:

- Level II Public Faucets: 50 - 60 lpcd  
*(Each public faucet should serve 4 - 6 households)*
- Level III House Connections: 80 - 100 lpcd

If there are public schools and health centers in the area, they will be supplied from the start of systems operation and be classified as institutional connections.

Commercial establishments can also be assumed to be served, after consultation with the stakeholders, within the 5-year period. The unit consumptions of institutional and commercial connections are, in terms of daily consumption per connection, usually expressed in cubic meters per day ( $m^3/d$ ). Unless specific information is available on the consumptions of these types of connections, the following unit consumptions for commercial and institutional connections can be used.

- Institutional Connections:  $1.0 m^3/d$
- Commercial Connections:  $0.8 m^3/d$

This unit consumption can be assumed to be constant during the design period under consideration, *unless available information indicates otherwise*.

### 2. Total Consumption

The total consumption is the sum of the domestic, institutional and commercial consumptions expressed in  $m^3/d$ .

#### a. Domestic Consumption:

The year-by-year total domestic consumption is projected by applying the projected unit consumption to the projected population to be served for each year. The served population is estimated by employing the market survey results and the planner's judgment of the potential of the area.

Based on experience, most water systems originally constructed as Level II have upgraded either to Level III or to a combined Level II and Level III system.

In anticipation of the trend towards upgrading to Level III in the future, the Level II system planner should assume that within 5 years, 90% of the households served would opt for individual house connections.

This estimate, however, should be tempered by the planner's direct first-hand information about the area and its population.

**b. Institutional and Commercial Consumption:**

After having considered the possible timing and number of institutional and commercial connections, the projected yearly consumptions for each category are estimated by applying the corresponding projected unit consumptions as presented in the preceding section.

**F. NON-REVENUE WATER (NRW)**

Non-revenue water is the amount of water that is produced but not billed as a result of leaks, pilferages, free water, utility usages, etc. An allowance should be made for this category; otherwise, the designed source capacity would not be sufficient to supply the required consumption of paying customers.

In actual operation, the NRW should be a cause of concern and should be subject to measures to keep it as low as possible. For planning purposes, however, a conservative approach should be adopted. The water demand projection should assume that the NRW of the new system will be fifteen percent (15%) of the estimated consumptions. The plan's figure can be increased up to a total of 20% at the end of 10 years. . These assumed NRW figures require good maintenance of utilities, pro-active leakage prevention, and no illegal connections for 100% recovery of supplied water.

**G. WATER DEMAND**

The water demand is a summation of all the consumptions given in the preceding sections and will determine the capacity needed from the source/s. The average daily water demand, also known as the average day demand, is calculated (in m<sup>3</sup>/day or lps) from the estimated water consumptions and the allowance for the NRW (expressed as a percentage).

A system with consumption of 2 lps with a 15% NRW will have an average day demand equal to

$$\frac{2 \text{ lps}}{(1 - \text{NRW})} = 2.4 \text{ lps}$$

## 1. Demand Variations and Demand Factors

Water demand varies within the day and also within the year. This demand variation is dependent on the consumption pattern of the locality and is measured by four demand conditions which are:

- **Minimum day demand:** The minimum amount of water required in a single day over a year.
- **Average day demand:** The average of the daily water requirement spread in a year.
- **Maximum day demand:** The maximum amount of water required in a single day over a year.
- **Peak hour demand:** The highest hourly demand in a day.

Each of the above demand conditions is designated a demand factor to define its value based on the average day demand. For a Level II/III system, the following demand factors are recommended:

Demand Parameter	Demand Factor
Minimum day demand	0.3 of average day demand
Average day demand (ADD)	1.0
Maximum day demand	1.3 of average day demand
Peak hour demand	2.5 of ADD (>1,000 connections) 3.0 of ADD (<1,000 connections)

The average day demand is first estimated, and the estimates for the other demands follow by directly applying the respective demand factors to the projected average day demand.

## 2. Uses of the Demand Variations

- **Minimum day demand:** The pipe network system is analyzed under a minimum demand condition to check on possible occurrence of excessive static pressures that the system might not be able to withstand. No point in the transmission and distribution system should be subjected to pressure more than 70 m.
- **Average day demand:** Annual estimates and projections on production, revenues, non-revenue water, power costs, and other O&M costs are based on the average day demand.
- **Maximum day demand:** The total capacity of all existing and future water sources should be capable of supplying at least the projected maximum day



demand at any year during the design period. The design of treatment plants, pump capacity and pipelines considers the maximum day demand supply rate as an option in the optimization analysis.

- **Peak hour demand:** The pipeline network should be designed to operate with no point in the system having pressure below 3 meters during peak hour conditions. If there is no reservoir, the power ratings of pumping stations should be sufficient for the operation of the facilities during peak hour demands.

### **SAMPLE COMPUTATIONS**

**Given data:**

$$P_0 = 2000$$

$$P_{10} = 3000$$

$$\text{Persons per HH} = 5$$

**Determine:** Required source capacity for a well operating 18 hr/day

**Analysis:**

The number of standpipes would be, at present,

$$2000 \text{ persons} / 5 \text{ persons per HH} / 6 \text{ HH} = 67 \text{ standpipes}$$

Each standpipe should be able to supply  $50 \text{ lpcd} \times 6 \text{ HH} \times 5 = 1500 \text{ lpd}$ .

Domestic consumption for the 67 standpipes:  $67 \times 1500 \text{ lpd} = 100,500 \text{ lpd}$

Assuming 15% NRW, source capacity should be

$$\left( \frac{100,500 \text{ lpd}}{0.85} \right) \times \left( \frac{1 \text{ day}}{18 \text{ hrs}} \right) \times \left( \frac{1 \text{ hr}}{3600 \text{ sec}} \right) = 1.82 \text{ lps} \dots \text{ say } 2 \text{ lps}$$

**However, a source capacity of 2 lps now will not be sufficient for future demand of  $P_{10}$**

Even if the source capacity required now is only for a Level II system, the proper approach is to determine the source capacity requirement for a Level III system.

For a system that started as a Level II system, we can assume that 90% of the HHs will have Level III connections at Year 10.

No. of Level III connections in  $P_{10} = 3000 / 5 \times 90\% = 540 \text{ connections}$

For this community size, additional 2 commercial and one institutional connection can be assumed.

Since only 90% will have Level III connections, the remaining population (300 persons or 60 HH) will still rely on standpipes. At 6 HH per standpipe, 10 standpipes will still be needed by Year 10.

*(See continuation of Sample Computations next page)*

(Continuation of Sample Computations)

**Total connections 10 years from now:**

**Standpipes:**  $10 \text{ standpipes} \times 6 \text{ HH} \times 5 \frac{\text{persons}}{\text{HH}} \times 50 \text{ lpcd} = 15 \text{ m}^3 \text{d}$

**House connections:**  $540 \text{ conn} \times 5 \frac{\text{persons}}{\text{HH}} \times 90 \text{ lpcd} = 43 \text{ m}^3 \text{d}$

	Standpipes	Domestic	Commercial	Institutional	TOTAL
Connections	10	540	2	1	543
Average Day Consumption (m <sup>3</sup> /d)	15	243	1.6	1.0	<b>261</b>

Assuming a NRW of 15% the ADD will be:

$$261/0.85 = 307 \text{ m}^3/\text{d}$$

Since the source capacity must be able to satisfy the maximum day demand (1.3 of ADD), the source capacity must be equal to:

$$307 \times 1.3 = 400 \text{ m}^3/\text{d}$$

If the source will operate for only 18 hr/day, then capacity should be capable of producing:

$$\left(\frac{400 \text{ m}^3}{\text{d}}\right) \times \left(\frac{1 \text{ Dd}}{18 \text{ hr}}\right) \times \left(\frac{1 \text{ hr}}{3600 \text{ sec}}\right) \times \left(\frac{1000 \text{ l}}{\text{m}^3}\right) = 6.17 \text{ lps}$$

## Chapter 4

# Water Sources

After the demand has been estimated, the next step is to look for a source that passes both the quantity and quality requirements. This Chapter presents an overview of the possible water supply sources that can be utilized for rural and other small water supply systems.

### A. WATER RESOURCES

In the selection of a source or sources of water supply, adequacy and reliability of the available supply could be considered the overriding criteria. Without these, the water supply system cannot be considered viable. These, together with the other factors that should be considered (and which are interdependent), are as follows:

- Adequacy and Reliability
- Quality
- Cost
- Legality
- Politics.

Adequacy of supply requires that the source be large enough to meet the water demand. Frequently, total dependence on a single source is undesirable, and in some cases, diversification is essential for reliability.

From the standpoint of reliability, the most desirable supplies are, in descending order:

1. An inexhaustible supply, whether from surface or groundwater, which flows by gravity through the distribution system;
2. A gravity source supplemented by storage reservoirs;
3. An inexhaustible source that requires pumping;
4. A source or sources that require both storage and pumping.

The capacity or flow rates and water quality of each type of source should be evaluated through actual flow measurements, water quality sampling and testing – or, if available, recent data that can be relied upon to be accurate. In addition, information on potential sources of contamination and pollution should be determined.

### B. BASIC CLIMATOLOGY OF THE PHILIPPINES

The Philippines has annual rainfall varying throughout the country from 965 mm (38 in) to 4,064 mm (160 in). The monsoon rains are pulled in by hurricanes or typhoons. The

actual distribution of rainfall varies widely with time and location due to the archipelagic nature of the country's geography and regional climatic conditions.

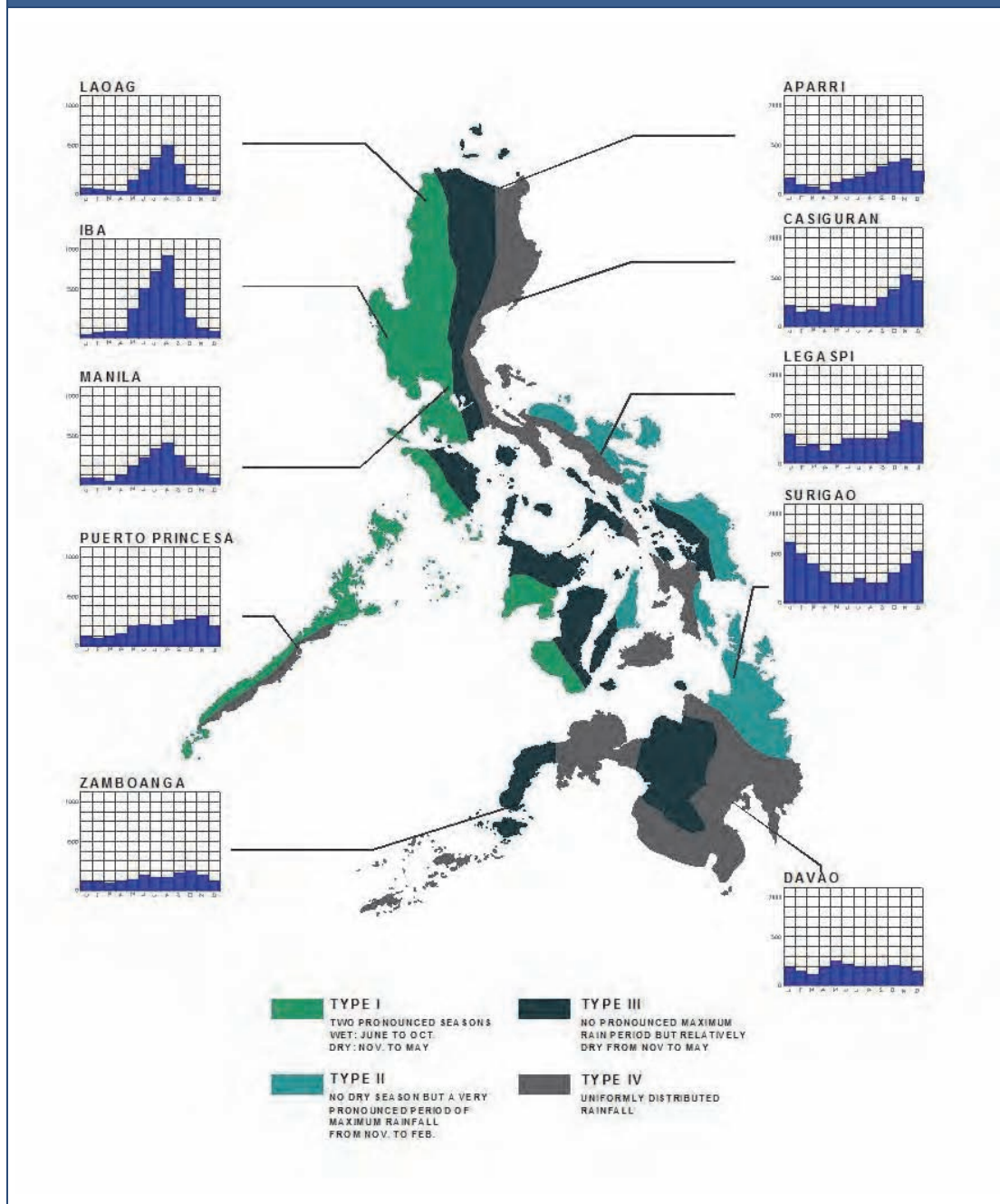
The tropical climate of the Philippines is marked by comparatively high temperature, high humidity and plenty of rainfall. The mean annual temperature is 27.7° C. January is the coolest month with a mean temperature of 22° C, while the warmest month is May with a mean temperature of 34° C.

Based on temperature and rainfall, the climate of Philippines can be categorized generally into two predominant seasons: the rainy season, from June to November; and the dry season, from December to May. Different sectors of the country, however, are characterized by important variants of these general classifications. For purposes of understanding the available water sources for a distribution system, these are better characterized, based on the prevalent distribution of rainfall, in classifications or types of climate shown in Figure 4.1, and summarized as follows:

- **Type I:** Two pronounced seasons: dry from November to April and wet during the rest of the year. The western parts of Luzon, Mindoro, Negros and Palawan experience this climate. These areas are shielded by mountain ranges but are open to rains brought in by southwest monsoons (Habagat) and tropical cyclones.
- **Type II:** Characterized by the absence of a dry season but with a very pronounced maximum rain period from November to January. Regions with this climate are located along or very near the eastern coast. They include Catanduanes, Sorsogon, the eastern part of Albay, the eastern and northern parts of Camarines Norte and Sur, the eastern part of Samar, and large portions of Eastern Mindanao.
- **Type III:** Seasons are not very pronounced but are relatively dry from November to April and wet during the rest of the year. Areas under this type include the western part of Cagayan, Isabela, parts of Northern Mindanao and most of Eastern Palawan. These areas are partly sheltered from the trade winds but are open to Habagat and are frequented by tropical cyclones.
- **Type IV:** Characterized by a more or less even distribution of rainfall throughout the year. Areas with this climate include the Batanes group, Northeastern Luzon, Southwest Camarines Norte, Western Camarines Sur, Albay, Northern Cebu, Bohol and most of Central, Eastern and Southern Mindanao.

The climate types and the rainfall data can be used in assessing the average volume of rain for a given area to determine the feasibility of rain harvesting or capacity of certain surface sources to supply projected demands.

Figure 4.1: Climate Types of the Philippines



Generally, the east and west coasts of the country receive the heavier rainfall. The northeast monsoon or “Amihan” brings frequent rains to the east coast of the islands, while the southwest monsoon or “Habagat” brings rainy season in Manila and the western coast, as well as the to the northern parts of the archipelago.

The central parts of the country, particularly Cebu, Bohol and a part of Cotabato receive the smallest amount of rainfall. As indicated in Figure 4.1, the annual rainfall ranges from less than 1,000 mm in Southern Mindanao to more than 4,000 mm in the eastern

portion of the country. In places where rainfall is uniformly distributed throughout the year and where groundwater and surface water are not available, rainwater might have to be used as a source of water supply through the use of simple rain harvesting methods.

### **C. CLASSIFICATION OF WATER SOURCES**

Water sources are generally classified according to their relative location on the surface of the earth. These are characterized as follows:

#### **1. Rainwater**

Rainwater, or atmospheric water, is a product of water vapor that has risen due to evaporation and accumulated in the atmosphere, which condenses and falls on the Earth's surface. As the water vapor that has accumulated in cloud formations condenses, it forms drops of rain that fall to the Earth.

#### **2. Surface Water**

Surface water is exposed to the atmosphere and subject to surface runoff. It comes from rains, surface runoff and groundwater, and includes rivers, lakes, streams, ponds, impounding reservoirs, seas, and oceans.

The quantity of surface runoff depends on a large number of factors; the most important of which are the amount and intensity of rainfall, the climate and vegetation, and the geological, geographical, and topographical features of the catchment area.

The quality of surface water is determined by the amount of pollutants and contaminants picked up by the water in the course of its travel. While flowing over the ground, surface water collects silt, decaying organic matter, bacteria and other microorganisms from the soil. Thus, all surface water sources should be presumed to be unsafe for human consumption without some form of treatment.

For rural water supply systems, surface water that is determined to need treatment is normally not a viable source because of the high cost of treatment and the general lack of expertise for the maintenance and operation of the appropriate treatment facilities. Where no other source is available, some form of subsidy may need to be arranged to set up and operate the treatment facilities. For these reasons, surface water is usually a last priority in selecting sources for rural water supply systems.

#### **3. Groundwater**

Groundwater is that portion of rainwater which has percolated beneath the ground surface to form underground deposits called aquifers. The upper surface of groundwater is the water table. Groundwater is often clear, free from organic matter and bacteria due to the filtering effect of soil on water percolating through it. However, groundwater almost always contains minerals dissolved from the soil. Groundwater is

often better in quality than surface waters, less expensive to develop for use, and usually provides more adequate supply in many areas in the country.

For rural water supply systems, groundwater is generally preferred as a water source. The types and extraction methods are as follows:

- **Spring** – is a point where groundwater flows out of the ground, and is thus where the aquifer surface meets the ground surface. A spring may be ephemeral (intermittent) or perennial (continuous). Springs can be developed by enlarging the water outlet and constructing an intake structure for water catchment and storage. The methodology is discussed in detail in Chapter 6.
- **Well** – is a hole constructed by any method such as digging, driving, boring, or drilling for the purpose of withdrawing water from underground aquifers. Wells can vary greatly in depth, water volume and water quality. Well water typically contains more minerals in solution than surface water and may require treatment to soften the water by removing minerals such as arsenic, iron and manganese.

Well water may be drawn by pumping from a source below the surface of the earth. Alternatively, it could be drawn up using containers, such as buckets that are raised mechanically or by hand. Wells are discussed in detail in Chapter 7.

- **Infiltration Galleries/Wells** – Infiltration galleries are horizontal wells, constructed by digging a trench into the water-bearing sand and installing perforated pipes in it. Water collected in these pipes converges into a “well” from which it is pumped out. Infiltration galleries are discussed more in Chapter 7.





# Chapter 5

## Water Quality

This Chapter describes the parameters and limits which define potable water.

### A. WATER QUALITY

“Water quality” is a measure of how good the water is, in terms of supporting beneficial uses or meeting its environmental values. Potable water is water suitable for drinking and cooking purposes. Potability considers both the safety of water in terms of health, and its acceptability to the consumer – usually in terms of taste, odor, color, and other sensible qualities.

### B. WATER QUALITY TESTS

Before deciding on the source/s of surface or groundwater, it is important to conduct water quality tests through representative samples. These tests ideally should be performed on site and through samples taken to the laboratory for definitive analysis.

#### 1. Water Quality Parameters

Samples from the potential surface and groundwater sources should be collected and analyzed for several quality parameters. During sampling, some parameters may be observed and tested on site with the use of portable equipment; while others have to be analyzed formally by an accredited testing laboratory.

Weather conditions, time of sampling, flow rate (when possible) and the physical appearance (color) of the water at the sampling point should be included in the assessment report. A prescribed volume and number of samples for laboratory analyses will have to be collected, stored in appropriate containers, protected to preserve the original quality, and transported to the testing laboratory in the soonest time possible.

All naturally occurring chemicals that are of health significance and found in the drinking-water supply as a result of the geological characteristics in the locality should be in the priority list tabulated in Table 5.1. The list of priority physical and chemical parameters to be monitored may be changed based on the results of previous water examinations. Parameters that are less likely to occur in water may be less frequently tested.

These tests are important in the selection of a potential source of supply. They also become necessary when major developments or environmental changes occur in the vicinity that might affect the quality of water of an existing source, or if important changes are found in the quality of the water originating from a previously tested source.

**Table 5.1: Water Quality Parameters to be Tested**

<b>High Priority (critical) Parameters:</b>		
1. Microbiological : (Total Coliform, Fecal Coliform )	6. Benzene	11. Manganese
2. Arsenic	7. Color	12. Chloride
3. Cadmium	8. Turbidity	13. Sulfate
4. Lead	9. Iron	14. Total Dissolved Solids (TDS)
5. Nitrate	10. pH	
<b>Other Parameters:</b>		
1. Temperature	4. Total Hardness	7. Dissolved Silica
2. Biological Oxygen Demand	5. Chromium	8. Total Mercury
3. Ammonia as NH <sub>3</sub> -N	6. Sulfide	9. Pesticides

## 2. Frequency of Sampling

The NWRB and the Department of Health (DOH) prescribe certain protocols for the testing of water at the supply source and through the distribution system. These are different for the microbiological concerns and the physical and chemical characteristics of the product.

### a. Microbiological Tests:

The minimum number of samples, which are to be collected periodically by existing water utilities and delivered to the DOH or its authorized laboratory for examination, is based on the mode and source of the water supply (Table 5.2). Samples are to be taken from the distribution network.

**Table 5.2: Minimum Frequency of Sampling for Drinking-Water Supply Systems for Microbiological Examination**

Source/Supply Mode	Population Served (no. of persons)	Minimum Frequency of Sampling
Level I	90 -150	Once in three (3) months
Level II	600	Once in two (2) months
Level III	Less than 5,000	1 sample monthly
	5,000 - 100,000	1 sample per 5,000 population per month
	More than 100,000	20 samples and additional one (1) sample per 10,000 population per month
Emergency Supplies for Drinking Water		Before Delivery to users

*Philippine National Standards for Drinking Water*

## b. Physical/Chemical Tests:

The minimum frequency of physical and chemical sampling for drinking water supply is once a year regardless of service levels. Samples are to be taken from the source itself.

## C. COMPONENTS OF WATER QUALITY

In accordance with the Philippines National Standards for Drinking Water, three aspects of water quality need to be considered. These are the Chemical, Physical and Microbiological aspects.

### 1. Chemical Aspects

Chemical contamination of water sources may be due to natural sources or to certain industries and agricultural practices. When toxic chemicals are present in drinking water, there is the risk that they may cause either acute or chronic health effects. Chronic health effects are more common than acute effects because the levels of chemicals in drinking water are seldom high enough to cause acute health effects.

1. **Hardness** – hardness is due primarily to calcium and magnesium carbonates and bicarbonates (which can be removed by boiling) and calcium and magnesium sulfate and chloride (which can be removed by chemical precipitation using lime and sodium carbonate). Hardness in water is objectionable for the following reasons:
  - Calcium and magnesium sulfate have a laxative effect.
  - Hard water makes lathering more difficult, and so it increases soap consumption.
  - In boilers, pots and kettles, hardness causes scaling, resulting in the reduction of the thermal efficiency and restriction of flow.
2. **Alkalinity and Acidity** – the presence of acid substances is indicated by pH below 7.0 and alkaline substances by pH greater than 7.0. Acidic water is corrosive to metallic pipes.
3. **Carbon Dioxide** – the presence of appreciable quantities of carbon dioxide makes water corrosive due to carbonic acid formation and the presence of free CO<sub>2</sub>.
4. **Dissolved Oxygen** – aside from a flat taste, water devoid of oxygen may indicate an appreciable level of oxygen-consuming organic substances.
5. **Chemical Oxygen Demand (COD)** – COD is a measure of the amount of organic content of water. As bacteria utilize oxygen in the oxidation of organic matter, the COD increases and the dissolved oxygen in the water decreases.
6. **Organic Nitrogen** – organic nitrogen is a constituent of all waste protein products from sewage, kitchen wastes and all dead organic matter. Freshly produced waste normally contains pathogenic bacteria. All water high in organic nitrogen should therefore be suspected for possible contaminants.

7. **Iron and Manganese** – groundwater usually contains more of these two minerals than surface water. Iron and manganese are nuisances that must be removed if in excess of 0.3 mg/l and 0.1 mg/l respectively. They stain clothing and plumbing fixtures, and the growth of iron bacteria causes strainers and screens to clog and metallic conduits to rust. The appearance of a reddish brown or black precipitate in a water sample after shaking indicates, respectively, the presence of iron or manganese.
8. **Toxic Substances** – a number of chemical substances, if present in appreciable concentration in drinking water, may constitute a danger to health. These toxic substances include arsenic, barium, cadmium, hexavalent chromium, cyanide, lead, selenium and silver.
9. **Phenolic Compounds** – these cause undesirable taste in water whenever present.

## 2. Physical Aspects

The turbidity, color, taste, and odor of water should be monitored. Turbidity should always be low, especially where disinfection is practiced. High turbidity can inhibit the effects of disinfection against microorganisms and enable bacterial growth.

Drinking water coloration may be due to the presence of colored organic matter. Organic substances can also cause water odor, though odors may result from many factors, including biological activity and industrial pollution.

Taste problems relating to water could be indicators of changes in the water source or in the treatment process. Inorganic compounds such as magnesium, calcium, sodium, copper, iron, and zinc are generally detected by the taste of water.

1. **Turbidity** – is a measure of the degree of cloudiness or muddiness of water. It is caused by suspended matter in water like silt, clay, organic matter or microorganisms. Even when caused by factors that do not pose a health risk, turbidity is objectionable because of its adverse aesthetic and psychological effects on the consumers.
2. **Color** – is due to the presence of colored substances in solution, such as vegetable matter and iron salt. It does not necessarily have detrimental effects on health. Color intensity could be measured through visual comparison of the sample to distilled water.
3. **Odor** – odor should be absent or very faint for water to be acceptable for drinking. Pure water is odorless; hence, the presence of undesirable odor in water is indicative of the existence of contaminants.
4. **Taste** – pure water is tasteless, hence, the presence of undesirable taste in water indicates the presence of contaminants. Algae, decomposing organic matter, dissolved gases, and phenolic substance may cause tastes.

### 3. Microbiological Aspects

Drinking water should be free of pathogenic microorganisms. It should not contain bacteria that indicate fecal pollution, of which coliform bacteria are the primary indicator as it is found in the feces of warm-blooded organisms.

Parasitic protozoa and helminths are also indicators of water quality. Species of protozoa can be introduced into the water supply through human or animal fecal contamination. Most common among the pathogenic protozoans are Entamoeba and Giardia. Where possible, only water sources that are not likely to be contaminated by fecal matter should be used.

Pathogens in water can be removed by filtration or disinfection. Chlorine, which is readily available and inexpensive, is the usual disinfectant. However, it is not fully effective against all organisms.

The two basic methods used for the enumeration of coliform organisms in water are the multiple-tube fermentation method and the membrane filtration method. Estimates of the numbers of coliform organisms are given in terms of Most Probable Numbers (MPN) per 100 ml, when using the multiple-tube fermentation method, and colonies per 100 ml when determined by the membrane filtration method. These tests must be conducted by DOH-accredited laboratories only<sup>6</sup>.

### 4. Philippine Standards for Water Quality

The Philippines National Standards for Drinking Water 2007 (PNSDW-2007) provide the minimum standards for quality of potable water. Per PNSDW, drinking water must be clear, colorless and free from objectionable taste and odor. Table 5.3 on the following pages presents the PNSDW standards for physical and chemical quality. All other standard values are contained in the PNSDW Administrative Order No. 2007-0012 or any other standards more recently issued by the Department of Health.

---

<sup>6</sup> List of these is available at the DOH website

**Table 5.3: Standard Values for Physical and Chemical Qualities for Acceptability**

Constituent	Maximum level(mg/l) or Characteristic	Remarks	Method of analysis
Taste	No objectionable taste	The cause of taste must be determined.	Sensory Evaluation
Odor	No objectionable odor	The cause of odor must be determined.	Sensory Evaluation
Color – True: Apparent:	5 NTU 10 NTU	Decomposition of organic materials such as leaves or woods usually yield coloring substances to water	Visual Comparison; Colorimetry Method
pH	6.5-8.5 (5-7 for product water that has undergone reverse osmosis or distillation)	The acceptable range may be broader in the absence of a distribution system.	Electrometric method
Turbidity	5 NTU	Turbidity increases with the quantity of suspended matters in water	Turbidimetry
Aluminum	0.2 mg/l	Aluminum sulfate is used in water treatment as a coagulant.	FAAS, EAAS. ICP, Colorimetry Method
Chloride	250 mg/l	Chloride in drinking water originates from natural sources, sewage and industrial effluents, urban runoff, and seawater intrusion	Argentometric Method, 1C
Hardness	300 as CaCO <sub>3</sub>	Hardness is due to the presence of naturally occurring divalent cations, resulting from contact of acidic groundwater with limestone and dolomites.	FAAS, EAAS. ICP, Colorimetry Method
Hydrogen Sulfide	0.05 mg/l	Hydrogen sulfide is a common nuisance contaminant. Although not hazardous to health, the offensive odor and corrosiveness of water containing hydrogen sulfide make treatment necessary.	Methylene Blue Method, Iodometric Method
Iron	1.0 mg/l	Iron is found in natural fresh waters. It may be present in drinking water as a result of the use of iron coagulants or the corrosion of steel and cast iron pipes during water distribution.	Phenanthroline, AAS, ICP, Colorimetric Method

Constituent	Maximum level(mg/l) or Characteristic	Remarks	Method of analysis
Manganese	0.4 mg/l	Manganese occurs naturally in many surface and groundwater sources, particularly in anaerobic or low oxidation conditions.	Persulfate Method, AAS, ICP, ICP/MS
Sodium	200 mg/l	Sodium is usually associated with chloride; thus, it may have the same sources in drinking water as chloride.	AAS (Flame absorption mode), ICP/MS, Flame
Sulfate	250 mg/l	High levels of sulfate occur naturally in groundwater	Turbidimetric Method, Ion Chromatography, Gravimetric Method
Total Dissolved Solids (TDS)	500 (but < 10 for water product that has undergone reverse osmosis or distillation process)	TDS in drinking water originate from natural sources, sewage, urban runoff and industrial wastewater	Gravimetric, dried at 180° C
Zinc	5.0	Zinc may occur naturally in groundwater. Concentration in tap water can be much higher as a result of dissolution of zinc from pipes.	FAAS, ICP, ICP/MS

*Philippine National Standards for Drinking Water*





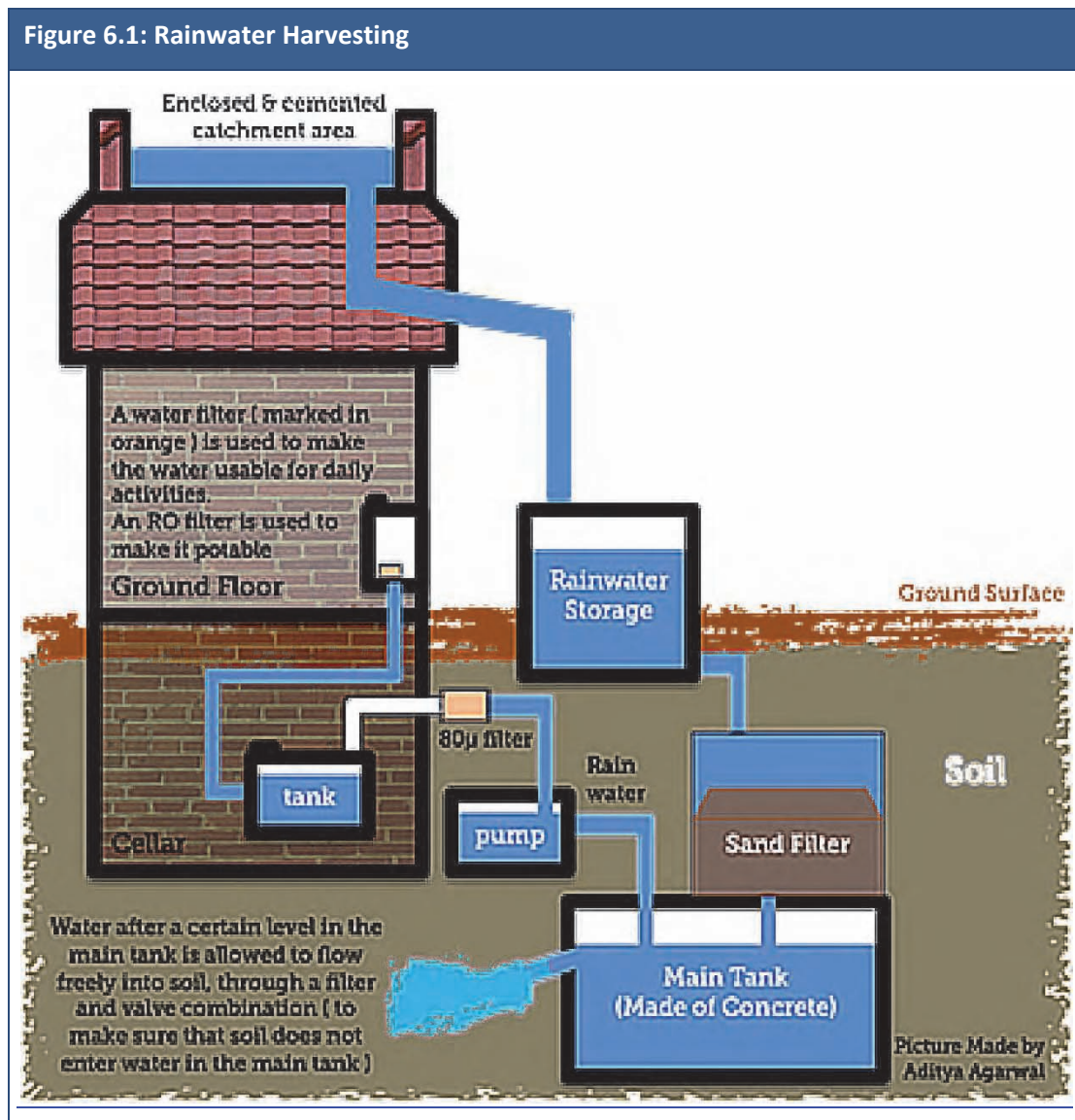
## Chapter 6

# Development of Water Sources

This Chapter deals with ways of utilizing rainwater, springs and infiltration galleries as water supply sources.

### A. RAINWATER

Rainwater would be an immediate resource to augment the existing water supply systems by "catching water wherever it falls". Rainwater can be utilized as an important source of water supply in areas where rain is well distributed throughout the year and where surface and groundwater are scarce.



Rainwater harvesting can be defined as the process of collecting and storing rainwater in a scientific and controlled manner for future use. Figure 6.1 shows the collection system for a single home, which can be expanded to include a number of interconnected catchments. Needless to say, this requires strong community participation. The rainwater can be collected from roofs of buildings, houses, and other catchments from which it can be channeled to a cistern or storage tank. A cistern is a watertight tank where the rainwater is stored. Unless the catchment area is unusually large (several hectares), cisterns are applicable only for Level I service. Any fibro-cement roof should be excluded as the material has been identified as a carcinogen initiator.

Rainwater harvesting benefits include the following:

- Environment-friendly, easy approach for water requirements;
- Increases ground water level and improves its quality;
- Mitigates the effects of drought;
- Reduces the runoff, which otherwise would flood storm water drains;
- Reduces flooding of roads and low-lying areas;
- Reduces soil erosion;
- Cost-effective and easy to maintain;
- Reduces water and electricity bills;
- Because rainwater is soft, little soap is needed when used for laundry purposes.

Note, however, that rain will wash air pollutants, dust, dirt, bird and animal droppings, leaves, paint, and other material from a catchment area to its storage area, hence special provisions should be made to bypass the first 5 to 10 minutes of rainwater and to filter the collected water. It is recommended that the cistern be treated after every rain with a chlorine compound of at least 5 mg/l chlorine.

The average annual rainfall and the collecting area determine the amount of water which can be collected. One millimeter of rain falling on one square meter of roof will yield 0.80 to 0.90 liters of water depending on the type of roof. For example, if the annual rainfall is 2,360 mm and the available collecting surface has the dimension of 5 x 10 meters, the amount of water which can be collected in a year is equal to:

$$2,360 \text{ mm} \times 0.80 \frac{\text{l/m}^2}{\text{mm}} \times 5 \text{ m} \times 10 \text{ m} = 94,400 \frac{\text{liters}}{\text{year}}$$

*or an average of 259 liters/day*

## B. SPRINGS

Springs are outcrops of groundwater that often appear as small water holes or wet spots at the foot of hills or along river banks. To obtain satisfactory water, it is necessary to find the source, properly develop it, eliminate surface water intrusion, and prevent

animals from gaining access to the spring. There should be no immediate upstream settlements, as these would pose the risk of biological contamination.

In all cases, a spring should be protected from surface-water pollution by the construction of a deep diverting ditch or equivalent above and around it. The spring and the collecting basin should have a watertight top, preferably concrete, and water obtained by gravity flow. Covers for inspection manholes, when provided, should be tightly fitted and kept locked.

If the water flows to the spring head through limestone or similar types of fissured rock channels, it is unlikely to have undergone natural filtration and purification to any appreciable extent. Hence, it likely carries pollutants from nearby or distant places. Under these circumstances, it is advisable to have periodic bacteriological examinations and to chlorinate the water.

***Ideally, spring flows should be measured monthly for a year to determine the spring's design yield.***

## 1. Steps in Developing Springs

A spring must be properly developed for several reasons: to obtain the full benefits of its flow, keep it from intrusion of animals and pollution, and protect it from damage and possible diversion. Among the first steps to develop a spring are the following:

1. Enlarge the eye of the spring to increase the quantity of water yield. This is accomplished by digging out the area around the hole down to the impervious layer to remove silt, mineral matter and rock fragments. During excavation, avoid disturbing the underground rock formation to prevent the deflection of the spring to another direction or rock formation.
2. Against the eye of the spring, pile stones that will serve as the foundation of the spring box.
3. Construct a spring box around the enlarged eye of the spring. This is to protect the spring water from contamination.
4. If there are several small springs located in the same area, construct a silt trap to serve as the reservoir collecting water from the springs.

## 2. Basic Design Features of a Spring Box

Although there are many different designs for spring boxes, they all share common features. Primarily, a spring box is a watertight collecting box constructed of concrete, clay, or brick with one permeable side. The idea behind the spring box is to isolate spring water from surface contaminants such as rainwater or surface runoff. All spring boxes should be designed with a heavy, removable cover in order to prevent contamination from rainwater while providing access for disinfection and maintenance.

Spring box design should include an overflow pipe that is screened for mosquito and small animal control. It is also important to provide some measure of erosion prevention at the overflow pipe. Approximately 8 meters upslope from the spring box, a diversion ditch should be constructed capable of diverting surface runoff away from the spring box. An animal fence should be constructed with a radius of at least 8 meters around the spring box. This protects the water source from livestock and wildlife contamination, as well as from soil compaction that could lead to reduced yields. Deep-rooted trees and plants should be avoided as their root systems could damage protective structures and reduce spring flow.

There are two basic spring box designs that could be modified to meet local conditions and requirements. The first design is a spring box with a single permeable side for hillside collection (Figure 6.2), and the second design has a pervious bottom for collecting water flowing from a single opening on level ground (Figure 6.3).

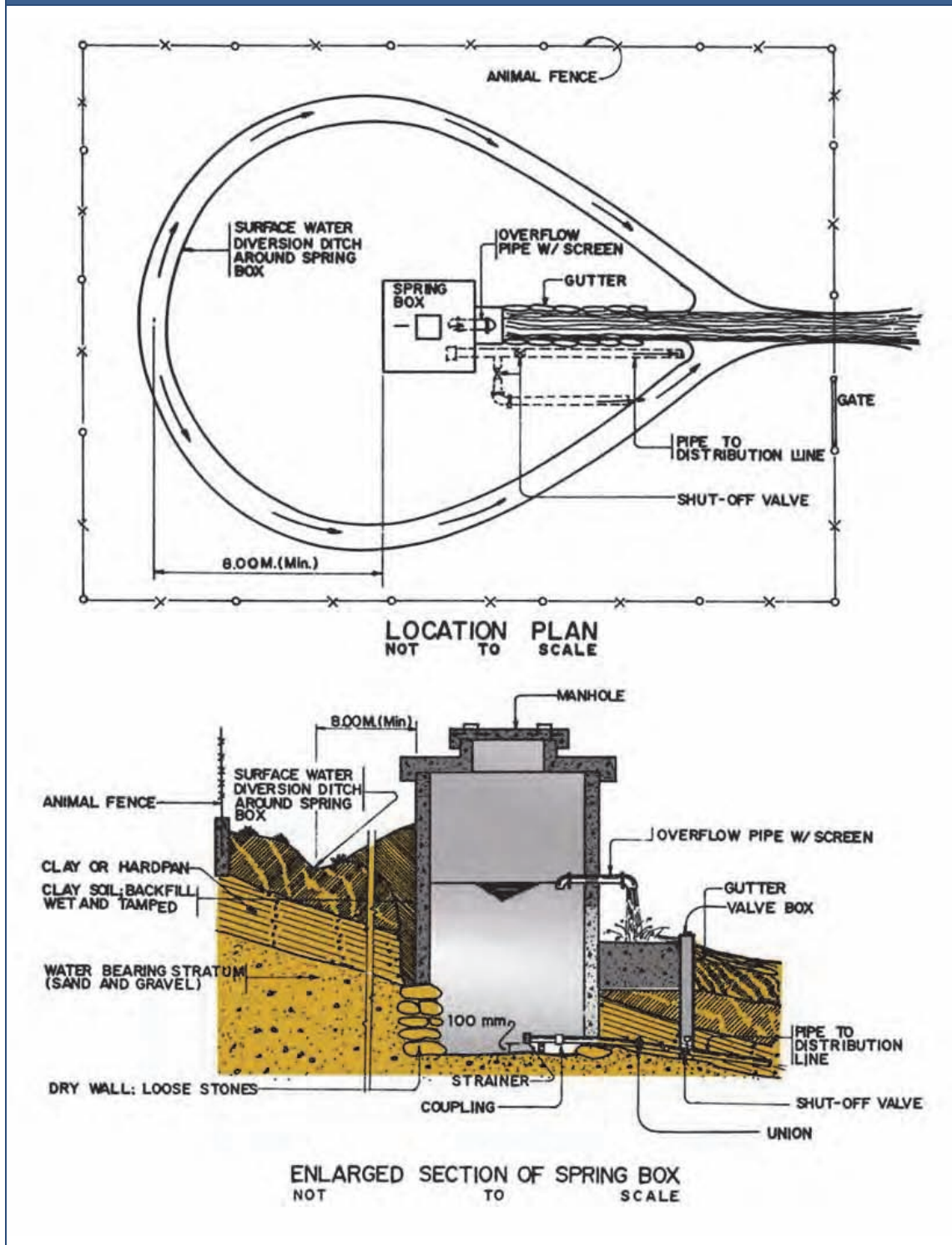
In Figure 6.2, the outlet pipe should be at least 100 mm above the bottom of the box. To prevent stones, rubbish and frogs from blocking the pipes, the end of the outlet pipe inside the box should be covered with a screen. Moreover, a drain pipe is necessary for removing silt at the bottom of the spring box. Figure 6.3 shows a spring box with a permeable bottom for springs emanating from ground level.

Because each spring site is unique and every community has individual water supply needs, there is not a particular spring box design that will fit all circumstances. It is up to the designer and the community to decide what will work best depending on local conditions. For instance, if the spring is located at a higher elevation than the distribution area and the distance is not too great, it may be preferable to design a spring box that is large enough to also act as a storage structure with sufficient capacity to supply the entire community. This would eliminate the need to construct additional water storage tanks. If the source has high sediment loads, it is also possible to design a spring box with a built-in sedimentation tank.

One thing to remember in designing a spring box is that the overflow pipe should not be higher than the natural elevation of the spring. If subjected to back pressure from the stored spring water in the box, it is possible for a spring to divert its flow elsewhere.

If a single spring eye cannot be located, a seep collection system is an alternative. In a seep collection system, perforated collection pipes are laid in a "Y" shape perpendicular to the seep flow in order to collect and concentrate water, which is then diverted to a spring box. Designing and constructing a seep collection system is much more difficult and typically more costly than other methods. In addition, collection pipes often clog with soil and rocks, making water collection less efficient and requiring more frequent and intensive maintenance.

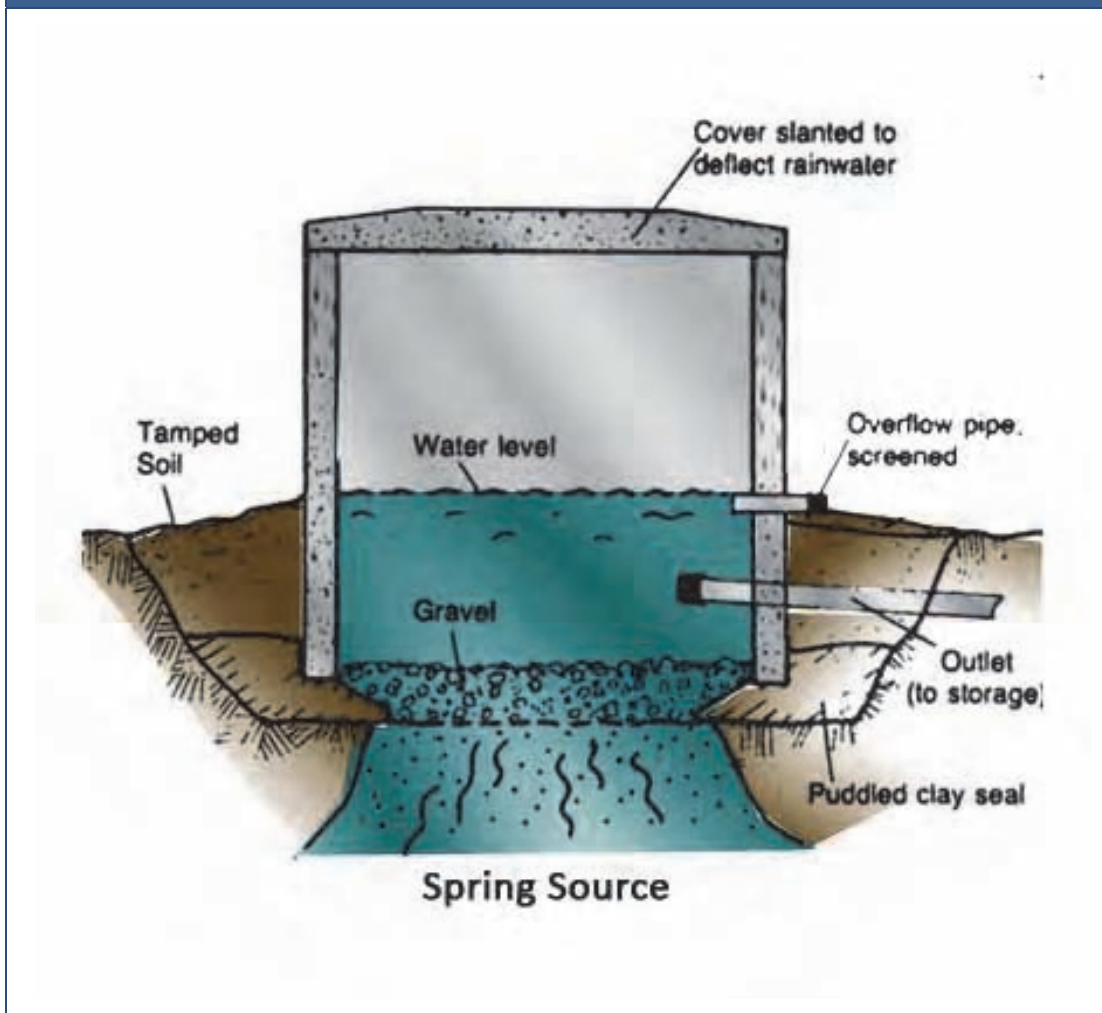
Figure 6.2: Spring Box with Permeable Side



NWRC RWS Volume I, Design Manual



Figure 6.3: Spring Box Design with Permeable Bottom

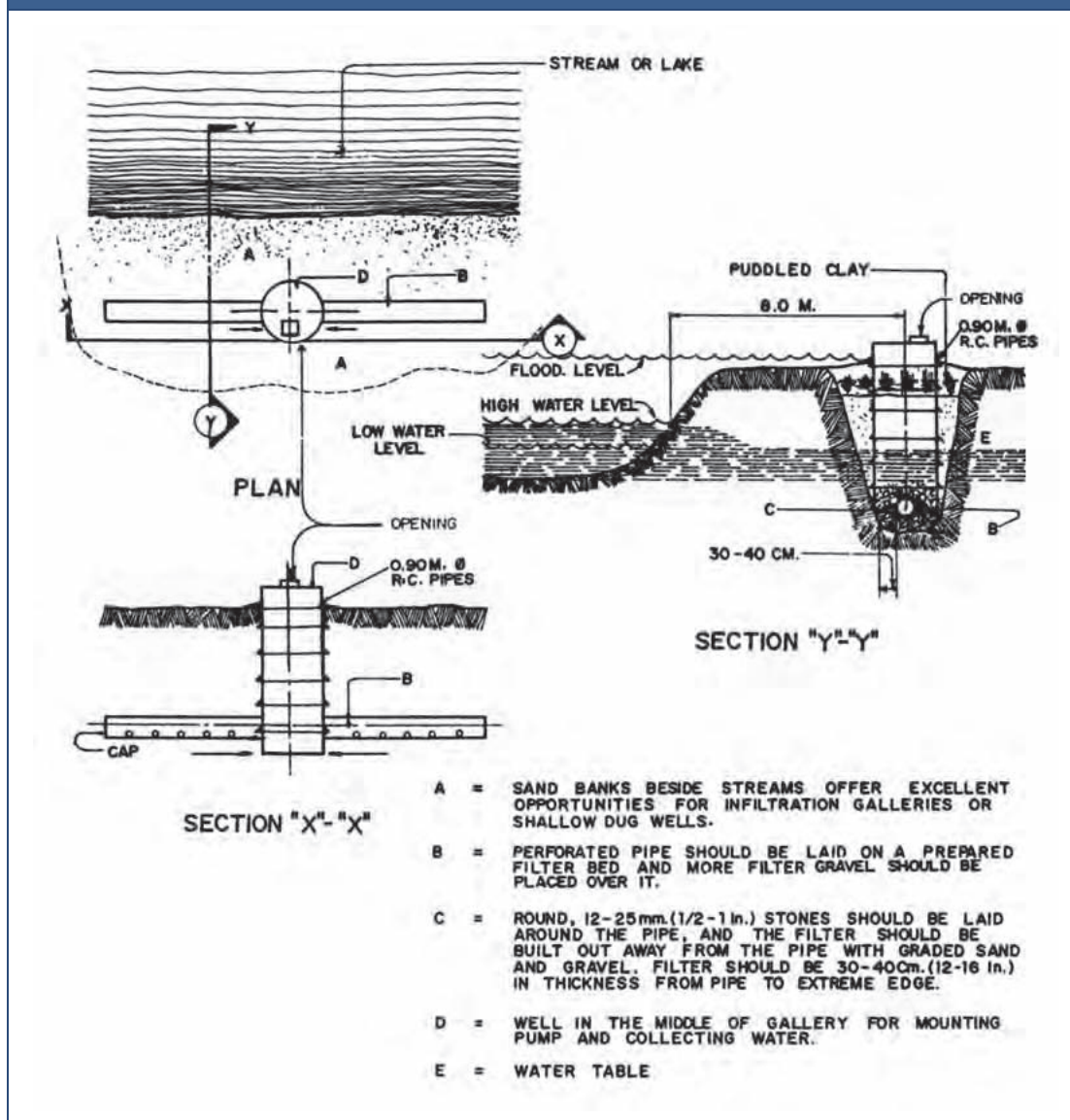


### C. INFILTRATION WELLS

An infiltration well involves a simple means of obtaining naturally filtered water. It consists of a system of porous, perforated, or open-joint pipe or other conduit that drains to a receiving well as shown in Figure 6.4. The pipe is surrounded by gravel and is located in a porous formation such as sand and gravel below the water table. The collecting system should be located 6 m or more from a lake or stream or under the bed of a stream or lake. It is sometimes found desirable, where possible, to carefully place a cofferdam, cutoff wall, or puddle clay dam between the collecting conduit and the lake or stream to form an impervious wall.

It is not advisable to construct an infiltration well unless the water table is relatively stable and the water intercepted is free of pollution. The depth of the collecting pipes should be about 3 m below the normal ground level, and below the lowest known water table, to assure a greater and more constant yield.


Figure 6.4: Details of an Infiltration Well



NWRC RWS Volume I, Design Manual

Depending on the nature of the source, however, an infiltration well may also be located at a shallow depth, above highly mineralized groundwater, such as saline water, to collect the fresher or less mineralized water.

An infiltration system consisting of horizontally perforated or porous radial collectors draining to a collecting well can also be designed and constructed where hydrogeological conditions are suitable, usually under a stream bed or lake, or where a thin water-bearing stratum exists. The infiltration area should be controlled and protected from pollution by sewage and other wastewater and animals. Water derived from infiltration galleries should, at the minimum, be disinfected.



Careful tests to measure yield should be made to determine the length of collecting pipes before constructing an infiltration well. Since the best wells collect water well below ground level, it is usually necessary to dewater the working trench. This usually requires cribbing and dewatering pumps and therefore is more expensive than a simple bored or driven well. This system, however, offers better possibilities of obtaining larger quantities of water if a suitable formation, such as coarse sand, can be found on the bank of a river, lake or small stream.

#### **D. SURFACE WATER SUPPLIES**

Surface water supplies include water from streams, rivers, lakes, ponds, seas and oceans. Surface water usually contains organic and inorganic minerals and needs expensive water treatment. Unless surface water is the only option, surface water should be avoided for rural water supplies.



# Chapter 7

## Wells

This Chapter will help the readers utilize wells as sources of supply either by their direct efforts in cases where the works involved are simple, or by selecting and overseeing the work of professional drillers hired in the case of more complex projects. Information on professional drillers can be obtained from the National Water Regulatory Board (NWRB), which regulates well drillers and requires them to be registered with it.

### A. GENERAL PLAN OF ACTION

The first step in considering the use of wells as the sources of water supply is to calculate the total capacity of the existing wells, and compare this capacity to the demand for water based on the population to be served.

The supply-demand analysis shows whether the existing wells can still be utilized or if new wells are needed.

#### 1. Utilize Existing Wells

If wells already exist, they should be checked for capacity and water quality. Wells that have the desired capacity and water quality should be given priority in selection. If capacity of a well is not sufficient, it should be checked to see if it can be developed to improve the yield. (Please refer to Section D). If water quality is the problem, a decision has to be made whether to go for a new well or to provide some treatment facilities.

#### 2. New Well Sources

For new wells, the following steps are called for:

1. Determine the best possible well sites (Refer to Section G).
2. Prepare preliminary well design (Refer to Section G).
3. Select the method of construction (Refer to Section E and G).
4. Construct the well.
5. Test for safe yield (refer to Section F) and water quality (Chapter 5).

### B. WELL HYDROLOGY

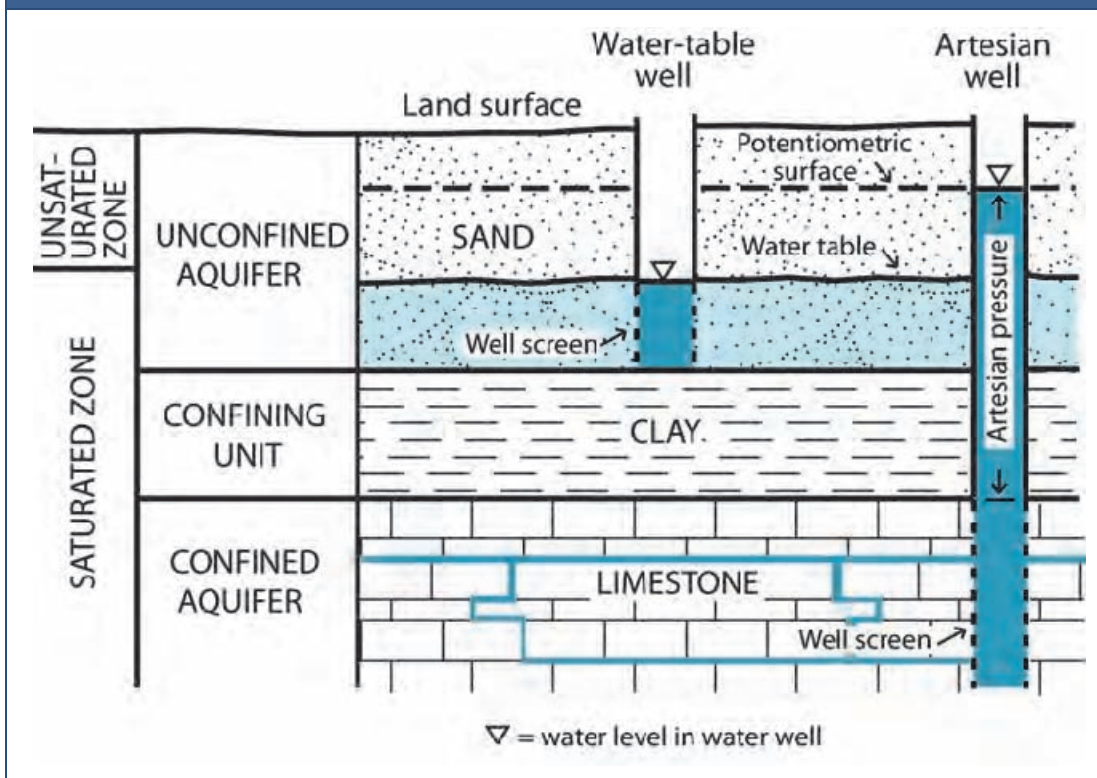
A well is a hole which has been dug, bored, driven or drilled beneath the ground for the purpose of extracting ground water.

Beneath the ground, most rocks and soil contain voids, pores or fissures. Subsurface water, which fills these voids and pores, occurs in two zones. One zone is called the

unsaturated zone, which is immediately beneath the ground surface and contains both water and air in the voids and pores. The other zone is called the saturated zone, where the voids are all filled with water. Water in the saturated zone is referred to as groundwater.

The water table (Refer to Figure 7.1) is the boundary between the unsaturated zone and the saturated zone. The water table is not stationary. It moves up during rainy season when percolation is high and moves down during dry season when groundwater discharge is higher. In general, the shape of the water table tends to follow the topography of the land.

Figure 7.1: Well Hydrology



The saturated zone is also called the aquifer. There are two main types of aquifers. One is the unconfined aquifer or water table aquifer whose upper limit is the water table. Unconfined aquifers are often shallow and the hydraulic pressure at its surface water level or water table is equal to atmospheric pressure.

Where an aquifer is sandwiched between an upper impermeable layer and a lower impermeable layer, the aquifer is said to be a confined aquifer or an artesian aquifer. One difference between a confined and unconfined aquifer is that the hydraulic pressure in a confined aquifer is greater than the atmospheric pressure. This hydraulic pressure, sometimes called artesian pressure, will cause the groundwater in a well to rise above the confining layer or even above the ground surface.

## **C. CLASSIFICATION OF WELLS BASED ON AQUIFER TAPPED**

As mentioned, an aquifer contains a considerable amount of groundwater underground beneath layers of permeable soil material like sand or gravel. Aside from their water storage capacity, aquifers allow the underground flow of groundwater. Aquifers are recharged with rainwater that seeps down to the soil and through the permeable layers.

### **1. Shallow Wells**

Generally, a well is considered shallow if it is less than 20 meters deep. Shallow wells tap the upper water-bearing layer underground. This permeable layer, however, usually has limited safe yield due to its great dependence on seasonal rainfalls. Therefore, the supply capacity of shallow wells could be unreliable and sometimes intermittent. Also, the water extracted from the upper strata is usually more affected by contamination since the aquifer being tapped is near the ground surface where possible sources of contamination abound. Protection against contamination is therefore one of the main considerations in constructing a shallow well.

### **2. Deep Wells**

Deep wells, which are over 20 meters deep, tap the deeper unconfined aquifer. This aquifer is not confined by an overlying impermeable layer and is characterized by the presence of a water table. A deep well is less susceptible to surface contamination because of the deeper aquifer. Also, its yield tends to be more reliable since it is less affected by seasonal precipitation.

### **3. Artesian Wells**

Artesian wells are much like the deep wells except that the water extracted is from a confined aquifer. The confining impermeable layers are above and below the aquifer. Groundwater recharge enters the aquifer through permeable layers at high elevations causing the confined groundwater at the lower elevations to be under pressure. In some cases, the hydraulic pressure of the aquifer is sufficient for a well to flow freely at the well head.

## **D. REHABILITATION/IMPROVEMENT OF EXISTING WELLS**

Existing wells may have capacities that could contribute substantially to the total required production for the planned water system. Existing sources should be investigated to assess whether they could be viably utilized. Existing wells whose output has diminished might possibly be rehabilitated/improved depending on several factors, among them the ground formation where the well is drilled, the construction or drilling method used, and the reasons its flow has been reduced.

Rehabilitating an existing well is usually cheaper than drilling a new well given the same output. A professional contractor can do tests to determine if rehabilitation is possible and practical.

## **1. Typical Causes of Reduced Well Flow**

Aside from declines in the water table – as experienced in several parts of the country – reduced well productivity could stem from other reasons. The most common is the plugging of holes along the well screen or incrustations forming on the well screens. The amount of water going through the well system will drop significantly if several holes or portions of the screens are clogged. Calcium carbonate, iron bacteria, silt, clay, and “slime,” a combination of sediment and deposits, are all common well cloggers.

### **a. Mechanical Blockage**

There are two types of mechanical blockage that commonly restrict the movement of groundwater into a well. The first type involves the movement of fine grained soil materials from the natural formation to the borehole face or the face of the screen. The second type is caused by corrosion by-products of the metal portions of the well which act to cover the openings of a well screen.

The movement of fine particles is typically caused by improper well design or by over-pumping a well. An improper well design may include the selection of a gravel pack that is too large to effectively filter fine formation materials, or selection of an inappropriate screen slot size. Also, a well screen could be placed opposite layers of sand that are significantly smaller or more graded in particle size than the other aquifer materials.

Over-pumping a well will cause a turbulent flow in the formation near the well screen and promote the movement of fine grained materials. These same materials may not migrate at pumping rates that maintain laminar flow throughout the formation. The migration of fine materials reduces the effective porosity and restricts water flow, increases head loss in the immediate vicinity of the well, and often results in sand pumping.

The corrosion of well casings or screens can cause holes to develop in a casing and cause the screen slot size to increase, allowing sand and/or gravel pack to enter the well. Corrosion by-products can also cover portions of the screen and cause higher entrance velocities through the remaining open area, thus increasing head loss across the screen.

### **b. Chemical Encrustation**

Chemical encrustation is the deposition of minerals on the well screen or gravel pack which act to restrict the movement of water into a well. Chemical encrustation is caused by the precipitation of minerals dissolved in the groundwater due to changes in flow and/or pressure conditions at the well. Well encrustation typically consists of iron and manganese oxides or of calcium and magnesium carbonates or sulfates.

Chemical encrustation can be reduced by designing the well with a minimum of head loss through the screen, by correct placement of well seals, by proportioning the flow vertically in the well, and by maintaining proper pumping rates.

### **c. Bacteriological Plugging**

Microorganisms, such as bacteria, can cause clogging problems in wells, pipelines, and treatment facilities. This includes the types of iron-related bacteria which utilize dissolved iron as an energy source and others which cause iron precipitation in a secondary manner. These bacteria are not believed to cause health concerns but are a nuisance in the production and transmission of groundwater. These bacteria have been characterized by their unusual capacity for accumulating ferric (iron) hydrate around their cells. A relatively small number of bacteria are able to clog a well because they can accumulate many times more ferric hydrate than the actual bacterial cell material.

There are two methods by which these bacteria can infest a well. The bacteria may either be native to the aquifer or they may be introduced directly by man. Bacteria are known to exist in the ground as active organisms or inactive spores. It is also possible to introduce new or additional bacteria into an aquifer during drilling or when a pump or other equipment is serviced or operated.

## **2. Typical Methods of Well Rehabilitation**

Contractors will often use a combination of several methods to rehabilitate a well. Typical methods include:

- Using chemicals to dissolve the incrusting materials so that they can be pumped from the well;
- Cleaning the well with a brush attached to a drilling rig;
- High pressure jetting and well surging, in which water is injected into the well at high pressures.

### **a. Chemical Treatment:**

The selected chemicals are placed in the well and agitated frequently for 24 to 72 hours. The well is then pumped with water before a water test is given to see if the well system is ready to be put back in service.

1. For iron bacteria and slime, a liquid bacteria acid is effective.
2. For clogs with carbonate scale, sulfamic acids are used with inhibitors and modifiers.
3. If the bacteria problem is persistent, some of the more aggressive chemicals are muriatic acid and hydroxyacetic acid.
4. Disinfectants are chemicals which are used to kill bacteria present in the immediate vicinity of a well. Chlorine compounds are the most widely

used disinfectants because they are inexpensive, readily available, and proven effective against many types of bacteria.

5. Bacteriological plugging is typically treated by a combination of methods to destroy bacteria and to remove iron encrustation. This treatment often consists of alternating chlorine and acid solutions, combined with physical treatment methods.

**b. Physical Methods:**

1. A well drilling rig is used. A brush is attached to the drill and used in the well to mechanically remove incrustations.
2. High-pressure jetting features a tool with an adjustable, multi-head, water-powered jet that lowers into the well and injects water at a high pressure, dislodging debris from the well. The water removes debris from the clogged perforations in the casing and can crack the formations underground to create new sources of water.
3. Well surging is the repeated injecting and flushing out of water in a well system. With repeated flushing, the debris is washed away.

### **3. Steps in Well Rehabilitation**

Once a problem has been identified, the potential sources of the problem should be evaluated. The operation history of the well should be reviewed along with the results of any previous treatment efforts. The existing data may need to be supplemented by conducting performance tests to determine the current condition of the well and pump. If it is necessary to remove the well pump, a down-hole video survey should also be performed. A proper treatment procedure should then be developed to address the specific well problems.

Implementation of rehabilitation procedures for an individual well generally includes a combination or all of the following steps:

1. Pull and inspect the pump;
2. Perform a video survey;
3. Perform mechanical cleaning of the well screen;
4. Apply the proper quantity and type of chemical treatments;
5. Allow sufficient chemical reaction time;
6. Remove spent chemicals from the well;
7. Reinstall the well pump; and
8. Conduct a performance pumping test.

All chemicals used during a well cleaning process must be carefully removed from a well and properly disposed. Water should be pumped from the well until the water quality is essentially the same as prior to treatment.

#### **4. Other Methods**

Another method of increasing the well yield is to deepen an existing well. This method should be discussed with an experienced driller.

The structural parts of the well should also be looked into. Sand pumping may have any of several possible causes. Corroded casings or screens could be the cause. The well can still be rehabilitated by inserting smaller diameter casings and screens. Needless to say, this is possible only with large diameter wells (wells over 150 mm diameter) and, while the sand pumping may be solved, the well yield will be reduced.

### **E. TYPES OF WELLS BASED ON DESIGN AND CONSTRUCTION METHODS**

Wells can be designed and constructed in a number of ways depending on the geologic condition, budget for the construction, and desired capacity of the well. The following are the types of wells based on the construction method employed.

#### **1. Dug Wells**

Dug wells are holes or pits dug manually into the ground to tap the water table. The dug well may be up to 15 meters deep, with diameter usually ranging from 1 meter to 1.5 meters. The well is lined usually with concrete masonry, bricks, stones, or reinforced concrete to prevent the wall from caving in. At depths of the aquifer layer, the wall is embedded with slots; or pre-fabricated concrete caisson rings are installed for the passage of groundwater into the dug well.

Dug wells are normally circular in shape. This type of well is sometimes capable of drawing sufficient supplies of water from shallow sources but is easily polluted by surface water.

#### **2. Driven Wells**

Driven wells are like dug wells, in the sense that they tap the shallow portion of the unconfined aquifers. They are easy and relatively inexpensive to construct in locations with unconsolidated formations that are relatively free of cobbles or boulders. The wells are constructed by driving to the ground an assembly of G.I. pipe and a pointed metal tube called a “well point”. The pointed end of the well point, which is the penetrating end, has screens or holes to allow the passage of water. The upper end of the G.I. pipe is hit at the top with a heavy weight, usually suspended from a block attached to a tripod. As the driving progresses, the well point sinks further into the ground and lengths of G.I. pipes are added at the top. Wooden blocks or steel caps should be placed at the top to protect it from being damaged by the impact of the driving weight.



Although driven wells are deeper than dug wells, they are still relatively shallow and are prone to contamination. Also, driven wells have relatively small yield, which might not be sufficient for Level II/III rural water supply systems.

### 3. Bored Wells

Bored wells are constructed with hand or power augers, usually into soft cohesive or non-caving formations that contain enough clay to support the boreholes. The depth of bored wells could be up to 15 meters. Before the boring reaches the water table, the auger is raised out of the hole from time to time to remove bored soils from the auger bit. But once the boring operation reaches the water table, the auger is lifted out and the sand and soil have to be removed from the borehole by a bailer or sand pump. As the boring goes deeper, sections of rod are added to the auger stem. Also, a temporary steel casing of similar diameter as the borehole may be necessary to prevent the borehole from collapsing. After the boring has reached the final depth, preferably 2 meters below the dry season water table, a perforated PVC pipe is installed inside the temporary casing. The temporary casing is then gradually pulled out while gravel is poured in-between the PVC pipe and the temporary casing. When the casing has been retracted to 3 meters below the ground surface, cement grout will be used on top of the gravel packing up to the ground level, to protect the well from surface contamination.

Bored wells are very prone to surface contamination. The well construction method is not applicable on hard consolidated materials and is not advisable on predominantly boulder formations.

### 4. Drilled Wells

Wells drilled by professional drillers<sup>7</sup> with the appropriate experience and equipment can extract groundwater from a much deeper level than the other types of wells. Various well drilling methods have developed because geologic conditions range from hard rock such as granite and dolomite to completely unconsolidated sediments such as alluvial sand and gravel. Particular drilling methods have become dominant in certain areas because they are most effective in penetrating the local aquifers, thus offer cost advantages.

Well construction usually comprises four or five distinct operations: drilling, installing the casing and screen, placing the filter pack, grouting to provide sanitary protection, and developing the well to insure sand-free operation at maximum yield.

There are 2 common types of drilling methods, namely: cable tool and rotary drilling methods.

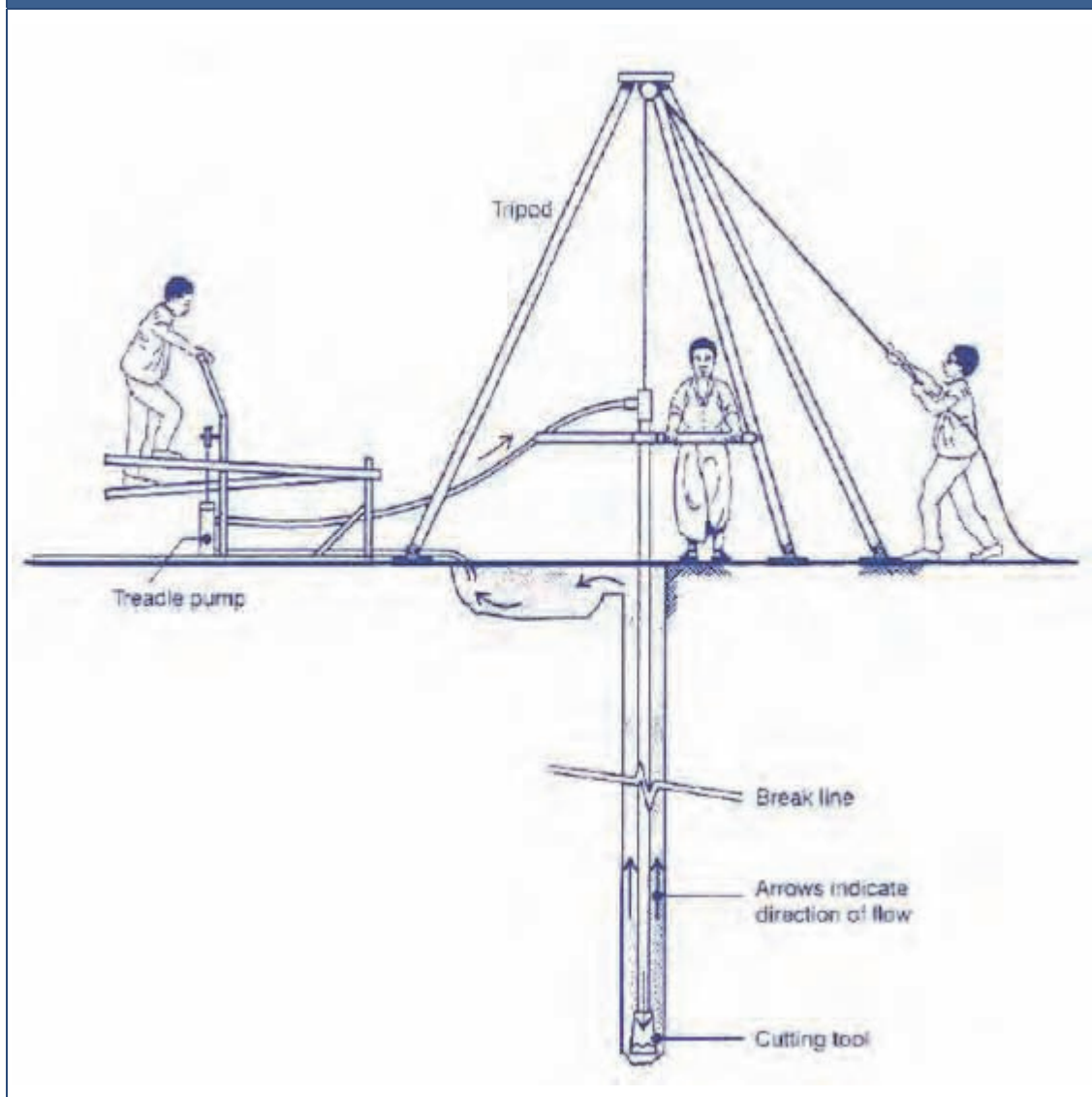
---

<sup>7</sup> The NWRB requires professional well drillers to register with it. It is not advisable to hire drillers who may not be qualified or lack the necessary experience to undertake the drilling and well development work for the utility.



### a. Percussion or Cable Tool Method

Figure 7.2: Manual Percussion Rig



*NWRC RWS Volume I, Design Manual*

This method is used to construct wells by repeatedly lifting and dropping a heavy string of drilling tools into the borehole as illustrated in Figure 7.2. The drill bit breaks or crushes consolidated rock into small fragments, whereas the bit primarily loosens the material when drilling in unconsolidated formations. In both instances, the reciprocating action of the tools mixes the crushed or loosened particles with water to form a slurry or sludge at the bottom of the borehole. Slurry accumulation increases as drilling proceeds and eventually it reduces the impact of the tools. When the penetration rate becomes unacceptable, slurry is removed at intervals from the borehole by a bailer or sand pump.

### **Advantages:**

- Rigs are relatively inexpensive, simple in design and require little sophisticated maintenance;
- Machines have low energy requirement;
- Borehole is stabilized during the whole drilling operation;
- Recovery of reliable samples is possible from every depth unless a heaving condition occurs;
- Wells can be drilled in areas where little make-up water exists and can be constructed with little chance of contamination;
- Wells can be drilled in formations where lost circulation is a problem;
- Wells can be bailed at any time to determine the approximate yield at certain depths.

### **Disadvantages:**

- Penetration rates are relatively slow;
- Casing costs are usually higher because heavier wall or larger diameter casing may be required and difficulty to pull-back long strings of casing in some geologic conditions;
- Not recommended for solid hard rock formations.

Most boreholes completed in consolidated formations by percussion method are drilled “open hole,” that is, no casing is used during part or all of the drilling operation. Drilling in unconsolidated formations requires a pipe or casing that follows the drill bit closely as the well is deepened to prevent caving in and to keep the borehole open. Wells drilled by the percussion method are very versatile and are able to develop water from either shallow or deep sources in either unconsolidated (sands and gravels) or consolidated formations.

#### **a. Rotary Drilling Methods**

The *DIRECT ROTARY DRILLING* method was developed to increase drilling speeds and reach greater depths in most formations. The drill bit is attached to the lower end of a string of drill pipes, which transmit the rotating action from the rig to the bit. The borehole is drilled, cutting and breaking the rock formation, the cuttings are removed by the continuous circulation of a drilling fluid which is pumped down through the drill pipe and out through ports or jets in the bit. This fluid flows upward in the annular space between the borehole and drill pipe, carrying the cuttings in suspension to the surface, where they can be geologically analyzed.

### **Advantages:**

- Penetration rates are relatively high in all types of materials;
- Minimal casing is required during the drilling operation;
- Rig mobilization and demobilization are rapid;
- Well screens can be set easily as part of the casing installation.

### **Disadvantages:**

- Drilling rigs are costly and require a high level of maintenance;
- Mobility of the rig may be limited depending on the slope and condition (wetness) of the land surface;
- Collection of accurate samples requires special procedures
- Drilling fluid management requires additional knowledge and experience.

The *REVERSE-CIRCULATION ROTARY DRILLING* method, illustrated in Figure 7.3, differs from the direct rotary in that the drilling fluid circulates in the opposite direction. The suction end of the centrifugal pump, rather than the discharge end, is connected through the swivel to the Kelly and drill pipe. The drilling fluid and its load of cuttings move upward inside the drill pipe and are discharged by the pump into the settling pit. The reverse circulation method is the least expensive method for drilling large-diameter holes (24 inches or more) holes in unconsolidated formations.

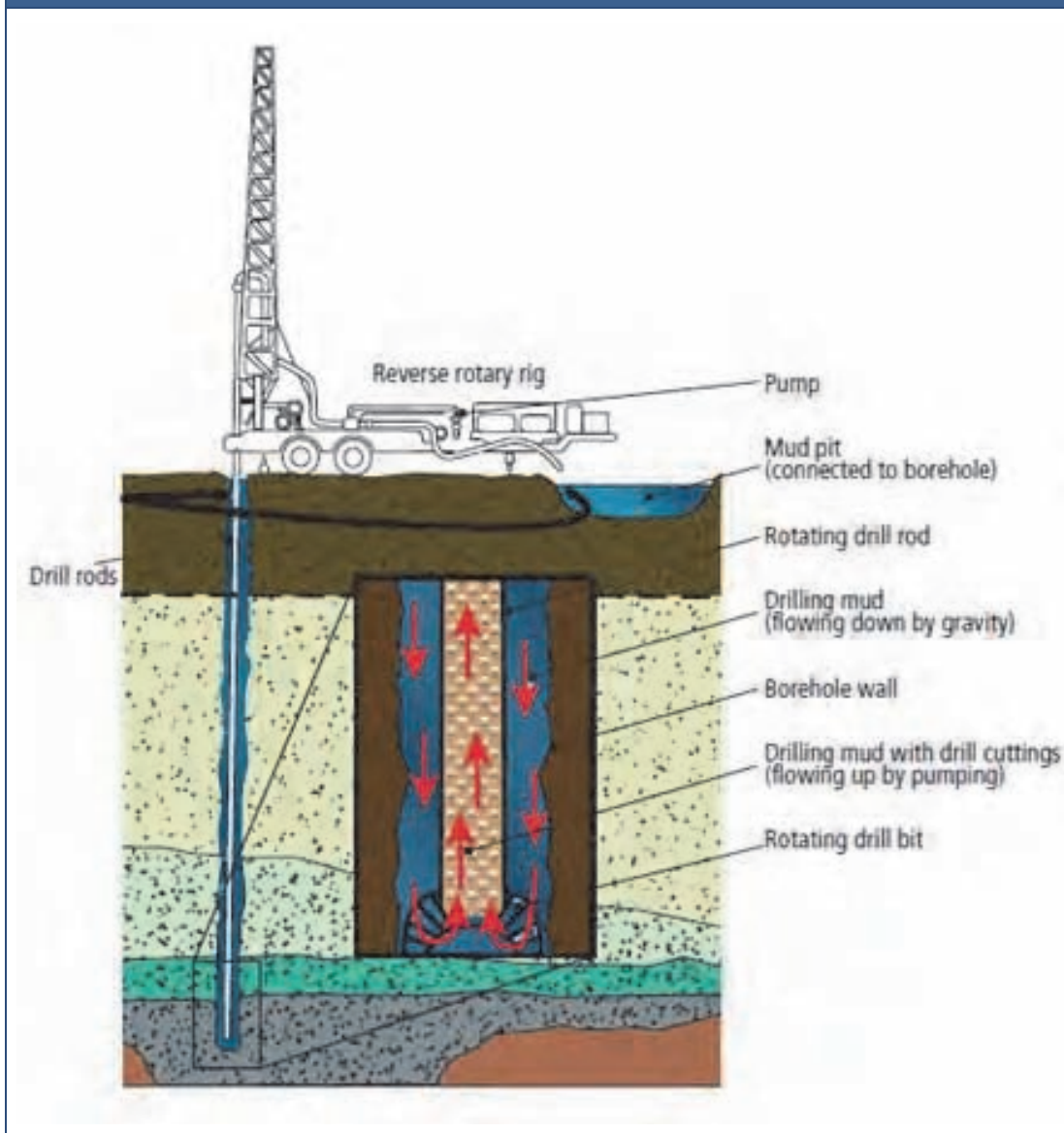
### **Advantages:**

- Porosity and permeability of the formation near the borehole are relatively undisturbed;
- Large diameter holes can be drilled quickly and economically;
- No casing is required during the drilling operation;
- Well screens can be set easily as part of casing installation.

### **Disadvantages:**

- Large water supply is generally needed;
- Reverse-rotary rigs and components are more expensive;
- Large mud pits are required;
- Some drill sites are not accessible because of the rig size.

Figure 7.3: Reverse Rotary Drilling



In the *AIR ROTARY METHOD*, air, with a small volume of water and surfactant (foam), serves as the fluid and excavation is accomplished exactly as is done in the conventional direct rotary method. Air drilling is used principally in semi-consolidated and consolidated formations. This method is not recommended for drilling in unconsolidated materials because the quality of the samples is usually poor and inaccurate.

Another type of drilling method that uses air as its fluid is the *DOWN-THE-HOLE (DTH) DRILLING METHOD*, in which the percussion mechanism – commonly called the hammer assembly – is located directly behind the hammer bit. (See Figure 7.4) The down-the-hole drill is basically a pneumatic jack hammer that is operated at the end of the drill pipe that rapidly strikes the rock while the drill pipe is slowly rotated. The percussion

effect is similar to the blow delivered by a cable tool bit, except for its higher impact and number of blows per minute. The bit's rotation helps ensure even penetration and therefore, straighter holes even in extremely resistant rock formation. Drill cuttings are removed continuously by the air used to drive the hammer, insuring that the air hammer bit always strikes a clean surface.

**Figure 7.4: A Down-the-Hole (DTH) Rig**



*Photo courtesy of Allianz Infrastructure Development Corp.*

The “down-the-hole hammer” combines the features of percussion drilling with those of rotary drilling, using compressed air to drive a rotating pneumatic hammer at the end of the string of tools. This type of rig is normally mounted on a truck and energy is supplied by a powerful compressor driven by a diesel engine of up to 200 hp. Compressed air is used to drive various motors to raise and lower the drilling string as well as to operate the hammer.

**Advantages:**

- Cutting removals is extremely rapid;
- Aquifer is not plugged with drilling fluids;
- No maintenance cost for mud pumps;
- Bit life is extended;

- Penetration rate is high, especially with down-the-hole hammer in highly resistant rocks such as dolomite and basalt;
- An estimate of the yield can be made during drilling from a particular formation;
- Wells can be drilled where lost circulation is a problem.

**Disadvantages:**

- High cost;
- Application restricted to semi-consolidated and well-consolidated formations.

***If a well is the primary source of water for a Level II system, the use of a drilled well is highly recommended as it can easily be upgraded for Level III requirements.***

## **F. TESTS OF WELL SUITABILITY**

The following basic tests are needed to assess whether a well is suitable as a source for a Level II or Level III water supply system.

### **1. Pumping (“Safe Yield”) Test**

The well’s safe yield can be roughly determined by operating a test pump with capacity at least equal to the system peak demand and operating it for 24 to 48 hours. After 24 hours pumping, the drawdown should be measured at several time intervals to determine if it has stabilized. The pumping rate at a stabilized pumping water level is the so called maximum pumping level and the safe yield is about 60 - 80% of the figure. In water where incrustation is anticipated, the safety factor should be set low. In areas where water quality is good, with a sand and gravel aquifer and low seasonal water table fluctuation, a higher safety factor can be considered.

To measure the water level in the well (both static and during pumping), it is best to install a water level sounding tube together with the pump. A flow meter or orifice weir is the best apparatus for measuring flows.

### **2. Water Quality Test**

This is done to determine if the physical and chemical characteristics of the groundwater meet the parameters set by the PNSDW. These are tabulated in Table 5.3 in Chapter 5, Section C-4.



***If the results of the tests indicate a sufficient yield and water quality that complies with PNSDW standards, then the well source(s) should be given high consideration for integration in the planned water system.***

## **G. WELL SITE SELECTION**

Important factors to be considered in selecting a drilled well site are:

1. Proximity to the planned service area;
2. Local hydro geological conditions;
3. Right-of-way and site ownership issues;
4. Accessibility of the site by drilling rigs and other equipment;
5. Distance/security from potential sources of surface contamination;
6. Proximity to existing electric power lines;
7. Terrain and ground slope of the site.

A survey of existing wells in the proposed area should be done to determine:

1. Typical yields and water quality;
2. Depths and which aquifer to tap;
3. Prior drilling success rates.

A drilling contractor cannot always determine in advance the depth at which an adequate water supply will be found. Neighboring wells offer some guidance but not a definite assurance.

### **1. Hydro-Geological Conditions**

The water resources study of the hydro-geological conditions of the project area will indicate the viable sites for well exploration in terms of supply capacity and water quality. Hydro-geological studies are conducted by knowledgeable professionals or drillers, who assess available information on existing wells. These examine well data such as water quality, well yield, seasonal fluctuations, water table depth, and well drilling logs showing geologic layers. A geo-resistivity survey of the areas being considered for possible well sites will indicate the depth and thickness of aquifers.

### **2. Environmental Considerations**

Shallow ground water wells should be at certain distance from any pollutant source such as toilets, pig or livestock farms, fertilizer-intensive farms, and the like. They should also be away from big trees whose root systems may affect the stability of the well.

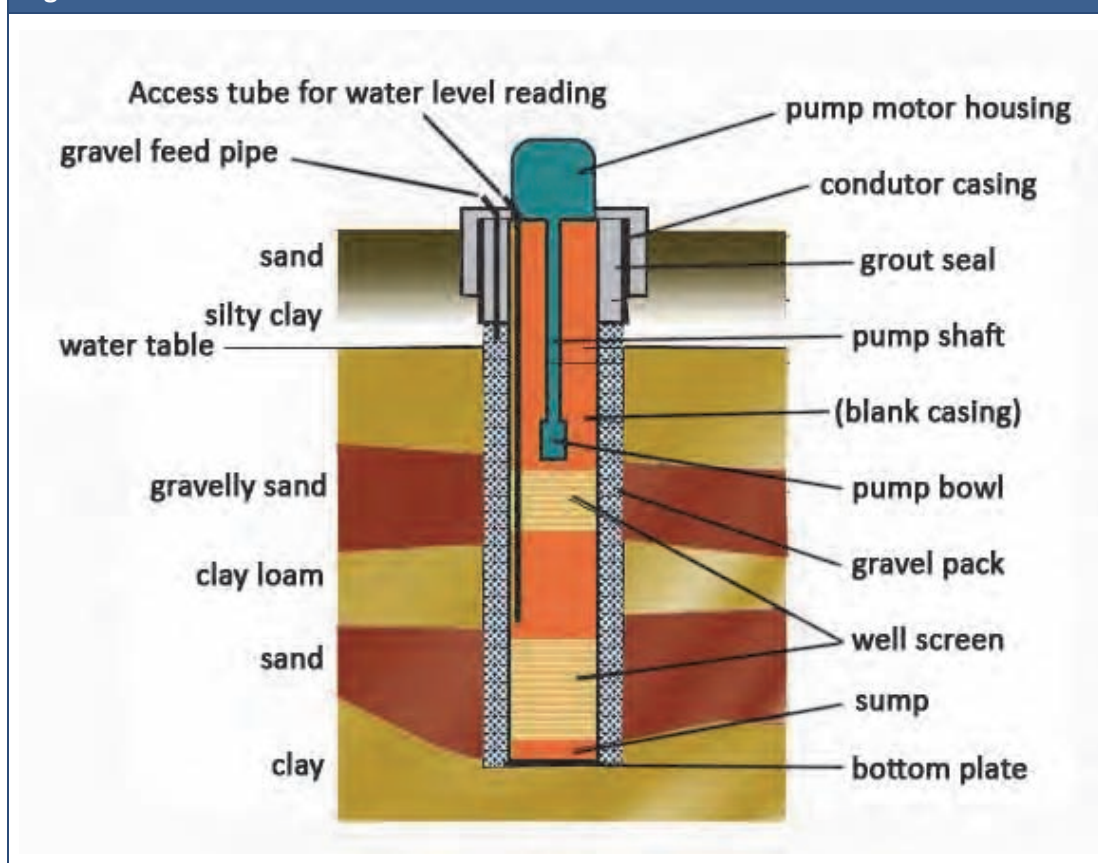
## H. DESIGNING A DRILLED WELL

### 1. Well Design

In practice, well design is done in two stages, the preliminary design and the final well design. Designing consists primarily of deciding the well depth, casing diameter, screen type and slot size and its position in the well.

Once the well site is determined, a preliminary well design is prepared by an experienced professional or driller based on hydro-geologic information gathered before the drilling. The elements of a drilled well's structure are illustrated in Figure 7.5. This preliminary design is the basis of the well drilling contract and the cost estimates.

Figure 7.5: Sections of a Drilled Well



During the drilling period, the preliminary well design will be adjusted based on actual observations and findings on the specific site. This adjusted design will then become the final well design. During this stage, the design assumptions used are verified and become actual design parameters, such as water table level, drawdown, depth and thickness of the geologic layers, types of material of each geologic layer encountered, and other relevant information.



The main objective of the design is to construct a well that

1. Is structurally stable;
2. Is able to extract groundwater at the desired volume and quality;
3. Has the proper and correctly placed screens or slots to tap the productive aquifers as well as to allow effortless flow of ground water into the well;
4. Has enough space to house pumps;
5. Has appropriate gravel packing that minimizes entry of sediments and sand particles.

## **2. Estimated Well Yield**

The combined production of the existing sources (if any) and of the additional well(s) should be at least equivalent to the projected maximum day demand of the water system by the design year. The hydro-geological study mentioned in the preceding section would indicate the estimated yield of a well. Prior to construction, this estimated well yield is considered preliminary and is used as basis for the preliminary well design.

After well construction and development, the actual well yield will be determined through a pumping test.

## **3. Well Depth**

The depth of the well depends on the water-bearing formation and the budgeted cost. The well must be designed to penetrate the aquifer as deep as possible within the budgeted cost.

During the test hole drilling, the drilling contractor will complete a formation log. Soil and rock samples are taken at various depths and the type of geologic material is recorded. This allows the driller to identify aquifers with the best potential for water supply. Some drillers also run an electric or gamma-ray log in the test hole to further define the geology.

Generally a well is completed to the bottom of the aquifer. This allows more of the aquifer to be utilized and ensures the highest possible production from the well.

## **4. Casing Diameter**

The well casing could be either a straight casing or telescopic casing. The diameter of a straight casing is the same from top to bottom of the well. Telescopic casing is a combination of a larger diameter casing/screen portion and a smaller diameter lower casing/screen portion.

The casing serves as a housing for the pumping equipment and as a conduit for the flow of groundwater from the screen opening to the suction of the pump. The housing portion of the casing should be located such that the pump will always be submerged in

water. It should be set a few meters below the lowest drawdown level, considering seasonal fluctuations. The casing should be large enough to accommodate the pumping unit for the desired supply rate. Ideally, the well casing is two nominal sizes larger than the bowl size of the pump that will be installed. For deep wells, the well casing must be large enough to accommodate the pump bowl, column or drop pipe with proper clearance for installation and efficient operations. The minimum casing size must be equal to 50 mm larger than the pump bowls but should not be less than 100 mm. For a telescopic well, the pump should be set at the upper larger casing.

## 5. Well Screen

The well screen is the intake portion of the well. The yield of a well depends greatly on the design and location of the screen. Wells can be screened continuously along the bore or at specific depth intervals. This depends on the depths and thickness of aquifer layers encountered.

The screen openings keep sand and gravel from entering the well, while allowing water to flow into it. Screens are installed in the productive formations of the borehole. The first screen section from the wellhead (top) should be installed below the estimated deepest pumping water level.

Basically, the well screen should as much as possible (a) prevent movement of sand into the well, (b) provide optimum opening for groundwater inflow, (c) be corrosion-resistant, and (d) be structurally strong to withstand collapse. Well screens are typically installed in wells where the aquifer is composed of loose or unstable material. The screen prevents rock fragments from entering the well, helps support the wall of the well and allows water to enter slowly. Turbulent flow can more easily transport unwanted rock particles and agitated water may release minerals and clog up the well.

Stainless steel screens are the most widely used because they are strong and relatively able to withstand corrosive water.

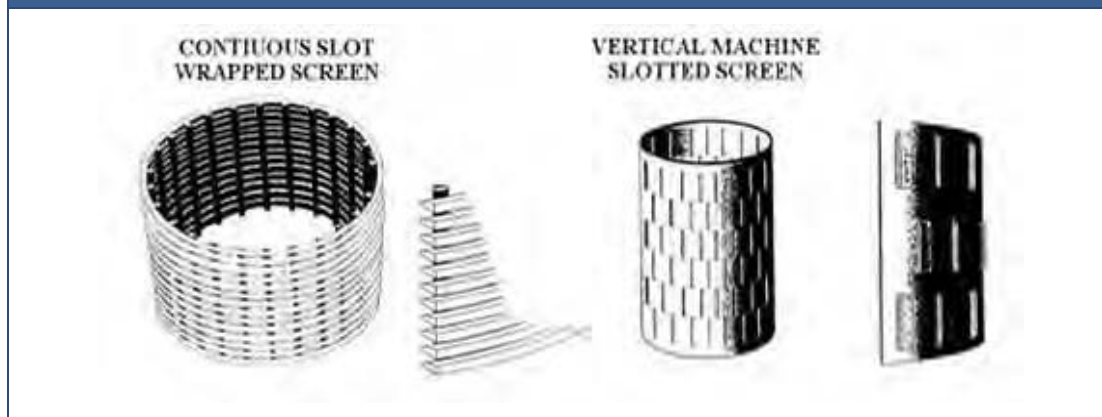
### a. Types of Well Screens:

Screens are made in many different slot or opening sizes and are usually installed by fixing them to the end of the casing. (Figure 7.6)

The slot sizes and shapes are designed to match the characteristics of the aquifer. The slotted or perforated casing or liner is made by creating openings using a cutting tool or drill. Pre-slotted plastic pipes are also available.

Slot openings and perforations are spaced further apart than screen openings. This reduces the amount of open area to allow water into the well. The openings tend to vary in size and may have rough edges depending on how they were made. This impedes the flow of water into the well and may not hold back the formation sediments.

Figure 7.6: Screen Types



While a screen is the more expensive alternative, it is necessary if the aquifer is composed of loose material such as fine sand, gravel or soft sandstone. A slotted or perforated casing can be used when the aquifer formation is more consolidated, such as hard sandstone or fractured shale.

After a choice is made between a screen and a slotted or perforated casing, other decisions will be made regarding:

- Size of slot openings
- Total area of screen or perforation that is exposed to the aquifer
- Placement of the screen or perforations within the aquifer.

#### **b. Size of Slot Openings:**

The slot openings must be small enough to keep out sediment but permit easy entry of water into the well. The slot size chosen will depend on the particle size of the earth materials in the producing aquifer. A slot size that allows 60 percent of the aquifer material to pass through during the well development phase of drilling should be chosen. The remaining 40 percent, comprising the coarsest materials, will form a natural filter pack around the perforations or screens.

The total area of the slot openings is dependent on the length and diameter of the screen. While the length of the screen is variable, the diameter of the screen is determined by the diameter of the well casing. The yield from a well increases with an increase in screen diameter but not proportionately so. Doubling the screen diameter raises the well capacity only 20 percent.

The amount of open area of the screen or slotted or perforated casing/liner must be calculated to ensure the water from the aquifer does not enter the well too quickly. A larger amount of open area allows the water to enter the well at a slower rate, causing a lower drop in pressure in the water as it moves into the well. If the water flows too quickly, there will be problems with incrustation.

### **c. Screen Placement:**

The screen or perforations on the casing/liner must be placed adjacent to the aquifer. If improperly placed, the well may produce fine sediment which will plug plumbing fixtures and cause excessive wear on the pump. If the driller uses geophysical logging equipment to accurately identify the boundaries of the aquifer, the exact placement will be easier.

The pumping water level in the well should never go below the top of the slot openings or perforations. Otherwise, the aquifer would be exposed to oxygen, which would enhance bacterial growth and reduce well yield.

## **6. Gravel Pack**

The annular space between the well screen, well casing, and borehole wall is filled with gravel or coarse sand (called the gravel pack or filter pack). The gravel pack prevents sand and fine sand particles from moving from the aquifer formation into the well. The gravel pack does not exclude fine silt and clay particles; where those occur in a formation it is best to use blank casing sections. The uppermost section of the annulus is normally sealed with a bentonite clay and cement grout to ensure that no water or contamination can enter the annulus from the surface.

## **7. Cement Grout**

A cement grout should be used to fill the upper 3 m of the annular space between the casing and the bore hole to provide a seal against possible surface contamination. At the surface of the well, a surface casing is commonly installed to facilitate the installation of the well seal. The surface casing and well seal protect the well against contamination of the gravel pack and keep shallow materials from caving into the well. Surface casing and well seals are particularly important in hard rock wells to protect the otherwise open, uncased borehole serving as a well.

# **I. WELL DRILLING**

The method of construction of a borehole will depend upon the depth and diameter required, the nature of the geological formation to be penetrated, and the amount of backup support available.

## **1. Use of Experienced Deepwell Drillers**

Well drilling must be contracted to an experienced and competent well drilling company duly accredited by the NWRB. The driller's role goes beyond the physical drilling of an appropriate size borehole; it includes, importantly, the performance of the following standard practices and tests:

1. Record all changes in geologic formations and their corresponding depth, with view to determining the site's viability and the design requirements of the well;
2. Log the geophysical borehole;
3. Develop the well;
4. Conduct plumbness test and check alignment;
5. Conduct pumping test.

## 2. Drilling

During drilling, drillers must keep a detailed log of the drill cuttings obtained from the advancing borehole. In addition, after the drilling has been completed but before the well is installed, it is often desirable to obtain more detailed data on the subsurface geology by taking geophysical measurements in the borehole.


Specialized equipment is used to measure the electrical resistance and the self-potential or spontaneous potential of the geological material along the open borehole wall. Sand has a higher resistance than clay, while high salinity reduces the electrical resistance of the geological formation. Careful professional interpretation of the resistance and spontaneous potential log, together with the drill cuttings' description, provides important information about water salinity and the location and thickness of the aquifer layers. The information obtained is extremely useful when finalizing the well design, which includes a determination of the depth of the well screens, the size of the screen openings, and the size of the gravel pack material.

## 3. Well Development

Well development is the process of removing fine sediment and drilling fluid from the area immediately surrounding the perforations. This increases the well's ability to produce water and maximizes production from the aquifer. After the well screen, well casing, and gravel pack have been installed, the well is developed to clean the borehole and casing of drilling fluid and to properly settle the gravel pack around the well screen. A typical method for well development is to surge or jet water or air in and out of the well screen openings. This procedure may take several days or perhaps longer, depending on the size and depth of the well.

Jetting, surging, backwashing and over pumping are methods used to develop a well. Water or air is surged back and forth through the perforations. Any fine materials that are in the formation become dislodged and are pumped or bailed from the well. This procedure is continued until no fine particles remain and the water is clear.

If the aquifer formation does not naturally have any relatively coarse particles to form a filter, it may be necessary to install an artificial filter pack. The pack is placed around the screen or perforations so the well can be developed. For example, this procedure is



necessary when the aquifer is composed of fine sand and the individual grains are uniform in size.

#### **4. Well Completion**

Once the well has been drilled and the equipment is in place, there are several procedures the drilling contractor must complete before the well is ready to use. The drilling contractor is responsible for:

- Well development
- Disinfecting the well
- Conducting a yield test.

#### **5. Wellhead Protection**

The construction of the final well seal is intended to provide protection from leakage and to keep runoff from entering the wellhead. It is also important to install backflow prevention devices, especially if the well water is mixed with chemicals such as fertilizer and pesticides near the well. A backflow is intended to keep contaminated water from flowing back from the distribution system into the well when the pump is shut off.

# Chapter 8

## Source Capacity Measurements

This Chapter presents the various methods for measuring the capacities of water sources and the well depths needed to support their use.

### A. INTRODUCTION

The production capacity of a source is important in planning a water supply system. An estimate of the water that can be reliably produced by a water source like a well or spring gives the planner basis to decide for or against its development. For the source/s to be considered adequate, they must at least satisfy the maximum day demand of the area to be served.

The following terminologies and definition of terms are used:

- **Static Water Level** – The vertical distance from the center line of the discharge to the water surface in the well when there is no pumping.
- **Pumping Water Level** – The vertical distance from the center line of the discharge to the water surface in the well while pumping. During a pumping test, the pumping water level is the depth of water surface when the amount of water withdrawn from the well and the amount of replenishment of water to the well are equal.
- **Drawdown** – The difference between the static water level and the pumping water level.
- **Yield of Well** – The volume of water per unit time that could be safely pumped from the well, as determined by a pumping test.
- **Yield of Spring** – The volume of water per unit time discharged by the spring.

### B. Measurements of Discharge

#### 1. Volumetric Method

Flows can be determined by measuring volume. The equipment necessary are a wrist watch or timer and a bucket or drum of known volume. The method consists of determining the time required to fill the bucket. For more accurate results, the measurement is repeated several times, and the average time of these trials is taken. Note that using a bigger container will improve the accuracy of the measurement. In Example 8.1, an empty oil drum is used as the container.

### Example 8.1: Determine the yield of the well using the volumetric method

#### Data:

- Volume of oil drum used : 200 liters  
Number of drums used : 1  
Time to fill the drum : 30 seconds

#### Required: Well yield

1. Calculate the total volume of water collected,  $V$

$$V = \text{Volume of container used} = 200 \text{ liters}$$

2. Calculate the yield of well,  $Q$

$$Q = \frac{\text{Volume of water collected}}{\text{time in seconds}} = \frac{200 \text{ l}}{30 \text{ s}} = 6.67 \text{ lps}$$

## 2. V-Notch Weir Method

A weir is an overflow structure built across an open channel for the purpose of measuring the rate of flow of water. Weirs may be rectangular, trapezoidal or triangular in shape. The Triangular or V-Notch Weir is a flow measuring device particularly suited for small flows. The V-Notch Weir often used in flow measurements is the 90° V-Notch shown in Figure 8.1.

A 90° V-Notch Weir can be cut from a thin sheet of metal or plywood and is placed in the middle of the channel and water is allowed to flow over it. The water level in the channel is then measured using a gauging rod as shown in Figure 8.1. The zero point in the rod should be level with the bottom of the notch. For a known height of water above the zero point in the rod, the flow in LPS can be obtained by using Figure 8.1 Table A or using the formula:

$$Q = 4.4 H^{2.48}$$

Where:

$Q$  = Discharge rate in liters per second

$H$  = Height of water level on the weir in decimeters

An application of the preceding formula to determine spring yield is demonstrated in Example 8.2 found on Page 8.4.



Figure 8.1: V-Notch Weir

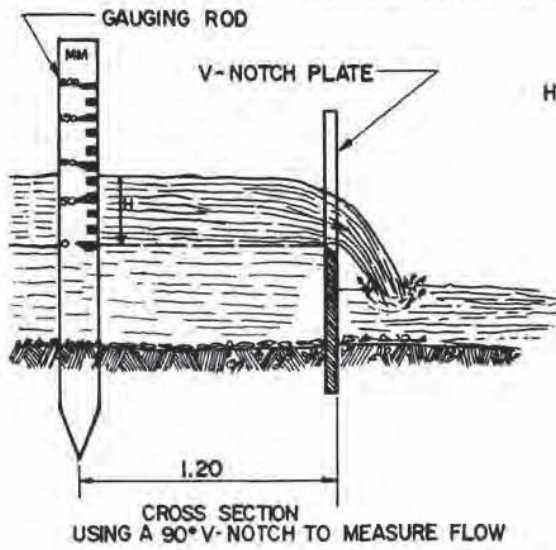
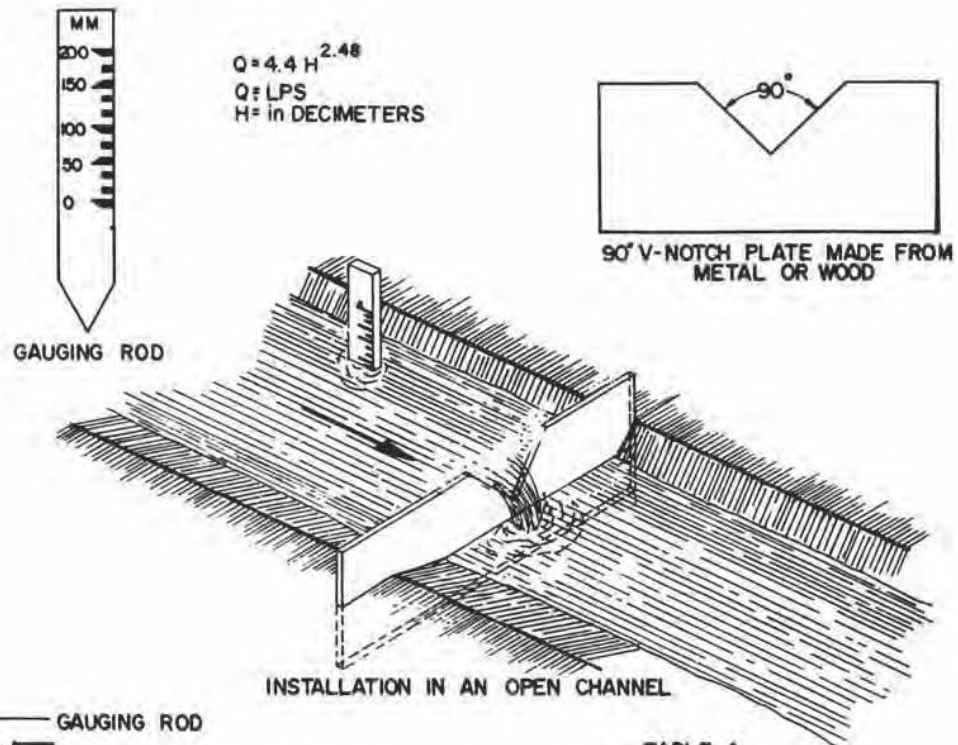


TABLE A  
FLOW OVER A 90° V-NOTCH  
HEIGHT OF WATER H(mm) FLOW (LITERS/SEC.)

50	0.8
60	1.2
70	1.8
80	2.5
90	3.4
100	4.4
110	5.6
120	7.0
130	8.4
140	10.1
150	12.0
160	14.1
170	16.4
180	18.9
190	21.6
200	24.5

NWRC RWS Volume I, Design Manual

### Example 8.2: Determination of Spring Yield

#### Data:

Water from the spring is discharged into an open channel and is metered using the V-Notch Weir Method

Height of water on the weir measured with a gauging rod = 100 mm

**Required:** Water yield of spring

1. **Calculate the yield of spring using Figure 8.1, Table A**

Locate under the column "Height of Water" the value  $H = 100$  mm and draw a horizontal line to intersect in the column "Flow". The reading in column "Flow" is:

$$Q = 4.4 \text{ LPS}$$

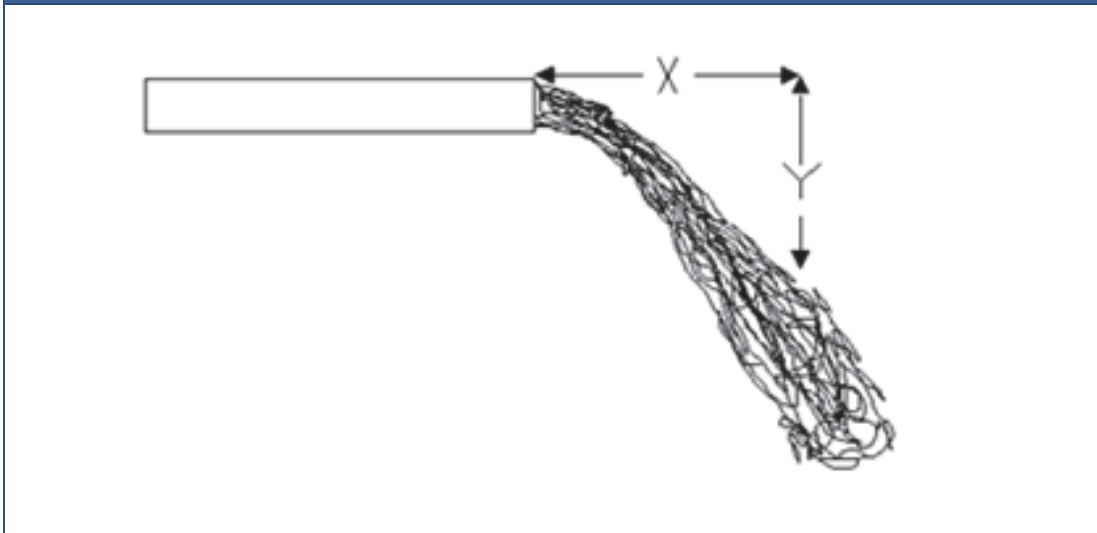
2. **Calculate the yield of spring using the formula,  $Q = 4.4 \times H^{2.48}$**

$$H = 100 \text{ mm} = 1 \text{ decimeter (dm)}$$

$$Q = 4.4 \times 1^{2.48} = 4.4 \text{ LPS}$$

### 3. Flow from a Horizontal Blow-off Pipe

Figure 8.2: Measuring Discharge from a Horizontal Pipe



The following describes the procedure for measuring flow from a horizontal pipe as shown in Figure 8.2. Two conditions must be met for this procedure to work:

- The pipe must be flowing full
- The pipe must be horizontal.

**Procedure:**

1. Measure the pipe distance to the ground (drop, or **y** in meters). The pipe must be parallel to the ground.
2. With water flowing from the pipe, measure the horizontal distance from pipe nozzle to a point where the water falls to the ground (carry distance or **x** in meters).
3. Apply the formula:

$$Q = \frac{0.001739 d^2 x}{y^{1/2}}$$

Where:

*d* = pipe diameter in mm  
*x* = carry distance in meters  
*y* = drop in meters  
*Q* = lps

**Example 8.3**

Find the flow in a 62.7 mm (2½ inch) pipe flowing full where the drop is 0.50 m (**y** axis) and the carry is 0.824 meters (**x** axis)

**Solution:**  $Q = \frac{0.001739 \times (62.7)^2 \times 0.824}{(0.50)^{1/2}} = 7.9 \text{ lps}$

**C. MEASUREMENT OF WATER LEVELS IN WELLS**

The measurements of static and pumping water levels can be done electrically or manually. The measurements provide data that reflect the condition of a well. The particular methods commonly used are the electric sounder, the wetted tape, and the splashing methods.

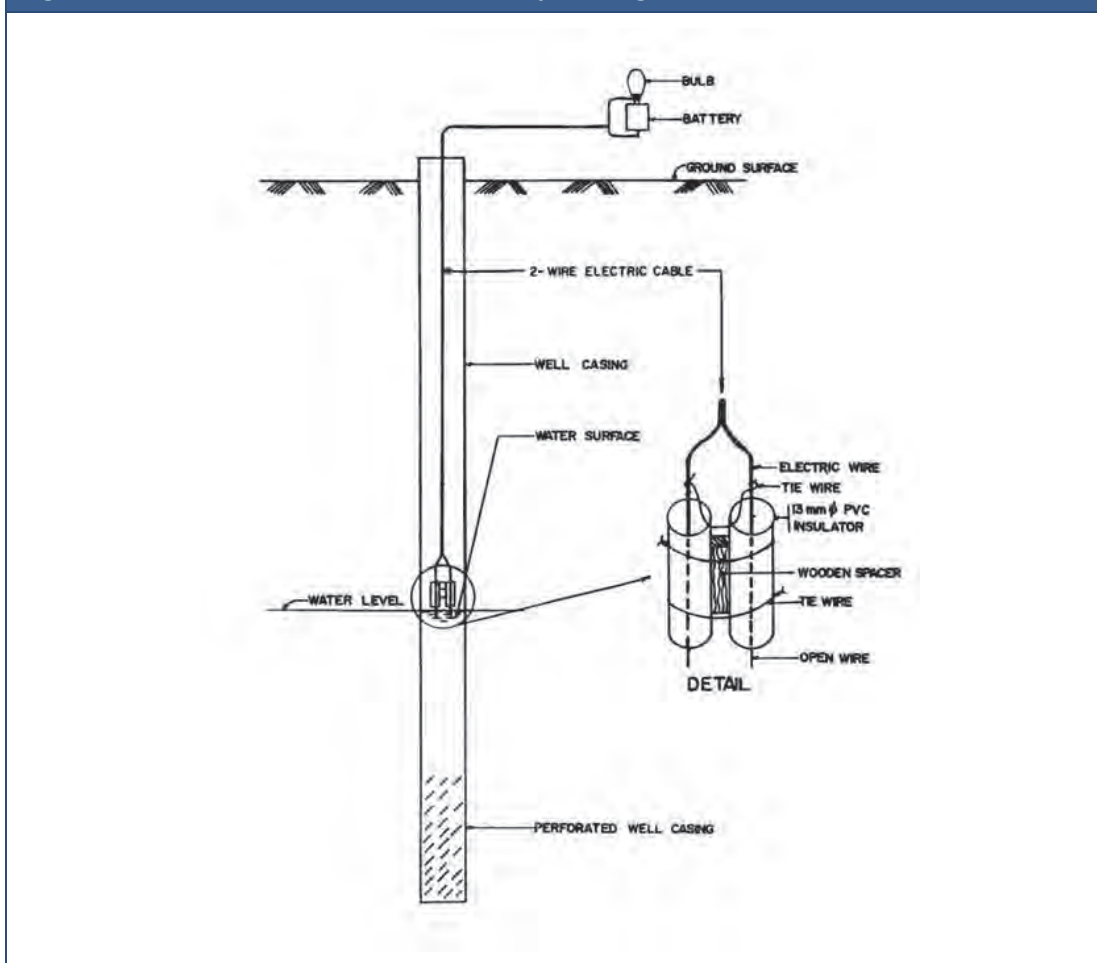
The data obtained could be interpreted as follows:

Case No	Static Water Level	Drawdown	Interpretation
1	Dropping	Unchanged	The water table is falling. The aquifer is being depleted faster than it can recharge.
2	Unchanged	Increased	The screen or strainer may be clogged and water is not freely going into the well.
3	Unchanged	Decreased	There is a loss in pump efficiency

## 1. Electric Sounder or Electrical Depth Gauge

An electrode suspended by a pair of insulated wires is lowered into the well (Figure 8.3). When the electrode touches the water surface, the circuit is closed and current flows. An attached ammeter may be used to indicate the current's flow. Equally effective is to use a light bulb and flashlight batteries instead of an ammeter as shown in Figure 8.3. The bulb lights up as the electrode touches the water surface. To improve the accuracy of readings, the electrode and cable should be left hanging in the well for a series of readings. This eliminates any error from kinks or bends in the wires which may change the length slightly when the device is pulled up and let down.

Figure 8.3: Electrical Sounder/Electrical Depth Gauge



NWRC RWS Volume I, Design Manual

## 2. Wetted Tape Method

The wetted tape method can be an accurate method of measuring depth of water and can be readily used for depths up to 25 m. First, a lead weight is attached to a steel measuring tape. The lower 60 to 90 cm of the tape is wiped dry and coated with

carpenter's chalk or keel before making measurement. The tape is then lowered into the well until a part of the chalked section is below the water surface while the foot mark is held exactly at the top of the casing or at some other measuring point that may have been selected. The tape is then pulled up. The wetted line on tape can be read to a fraction of an inch on the chalk section. The actual depth of the water level is then determined by finding the difference of the reading in the chalk section and the foot mark.

The disadvantage of this method is that the approximate depth of water must be known so that a portion of the chalked section will be submerged each time to produce a wetted line. Where the depth of water is more than 25 meters, the tape is difficult to handle.

### 3. Splashing Method

In the splashing method of measuring water levels in wells, a cord or rope with a weight can be lowered into the well until the weight is heard splashing on the water surface. The string is held or marked at the ground surface and then withdrawn. The length of the lowered cord when splashing is heard is the depth of water level in well.

#### Example 8.4: Determining Static Water Level, Pumping Water Level and Drawdown of Well

##### Data:

Measuring Device:	Electric Depth Gauge
Indicator:	Bulb lights when electrodes at the end of a lowered cord touch water
Before Pumping:	Bulb lit when cord measured 12 m
While pumping, water table stable:	Bulb lit when cord measured 14 m

##### Required:

1. **SWL (Static Water Level)** = the depth of water table from the ground surface before pumping:

*Measured at 12 m*

2. **PWL (Pumping Water Level)** = the depth of water table from the ground surface during pumping operation when water table is stable:

*Measured at 14 m*

3. **D (Drawdown)** = the difference between the static water level and the pumping water level.

Calculate the drawdown:

$$D = PWL - SWL$$
$$D = 14 - 12 = 2 \text{ m}$$



# Chapter 9

## Preventing Pollution of Sources

This Chapter discusses the commonly encountered risks of pollution of water sources and the measures that can be taken to protect our water sources from such risks.

### A. POLLUTION AND INFILTRATION

There are several possible ways by which pollution and contamination of our water sources can happen. These are from:

- Industrial/Commercial Pollution
- Municipal and Rural Pollution
- Private Pollution Sources.

#### 1. Industrial/Commercial Pollution

Contamination of both groundwater and surface water sources by industrial and commercial firms is often the result of ignorance, carelessness or demand for business profit. Many rivers in the country are beginning to be “biologically dead” and are already unsuitable for use in potable water schemes.

Groundwater sources were once considered safe from contamination due to overlying layers of earth. But now many wells which are not properly protected have been found to be contaminated by surface water pollutants.

#### 2. Municipal and Rural Pollution

Typical pollution sources and the contaminants involved are listed in Table 9.1.

Pollution Source	Possible Contaminants
Solid waste landfill	Heavy metals, chloride, sodium, wide variety of organic & inorganic compounds
Liquid waste storage ponds	Heavy metals, solvents and brines
Septic tanks/leach fields	Organic solvents, nitrates, sulfates and microbiological contaminants
Agricultural activities	Nitrates, herbicides and pesticides
Infiltration of urban runoff	Inorganic compounds, heavy metals and petroleum products

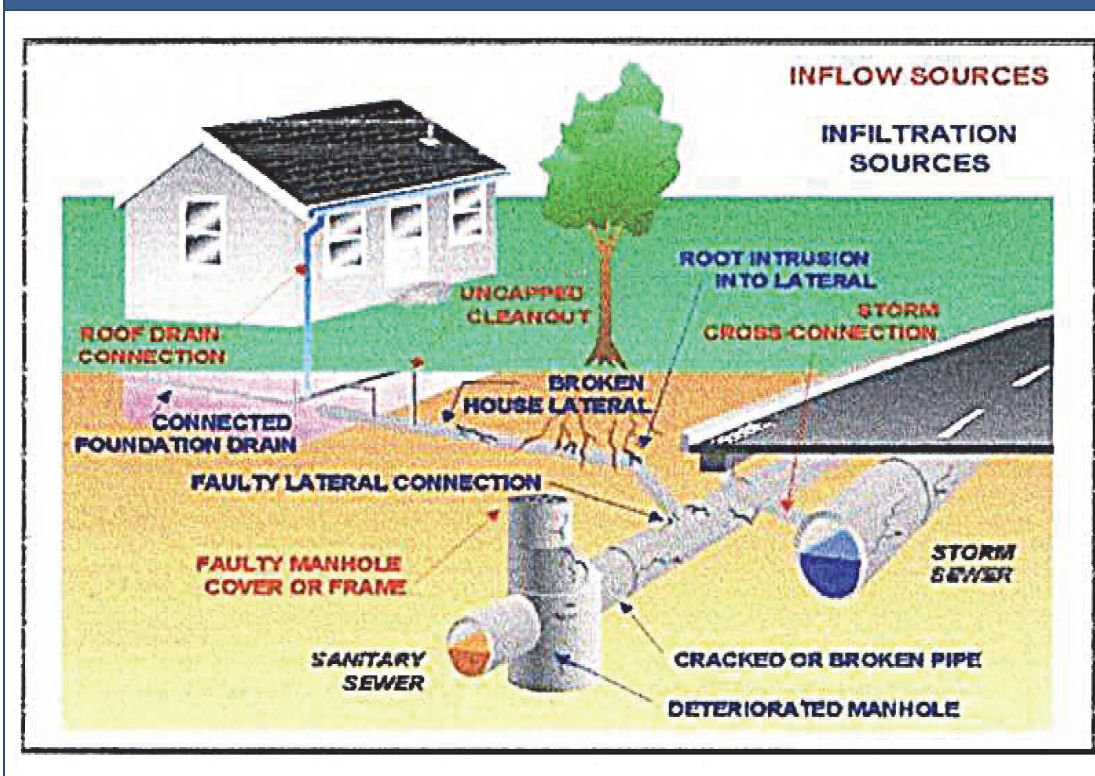


### 3. Private Pollution Sources

Private pollution sources are depicted in Figure 9.1. They include the following:

- Open well casing allowing animal or human waste to pollute the casing/shallow well directly;
- Lack of sealing around the casing (annular space) allowing unfiltered surface water to drain directly into the filter setting;
- Oil or chemical spillage seeping down (1 liter of oil can make 20 m<sup>3</sup> of water undrinkable);
- Over-fertilization of fields.

Figure 9.1: Private Pollution Sources



## B. PROTECTING WELLS

### 1. Formation Sealing of Drilled Wells

The borehole diameter of a drilled well is often larger than the casing diameter, which leaves an open space around the casing. This is known as the annular space and it provides an open pathway for contamination from the surface or from poor quality aquifers intersected by the bore hole before this reaches the desired aquifer.

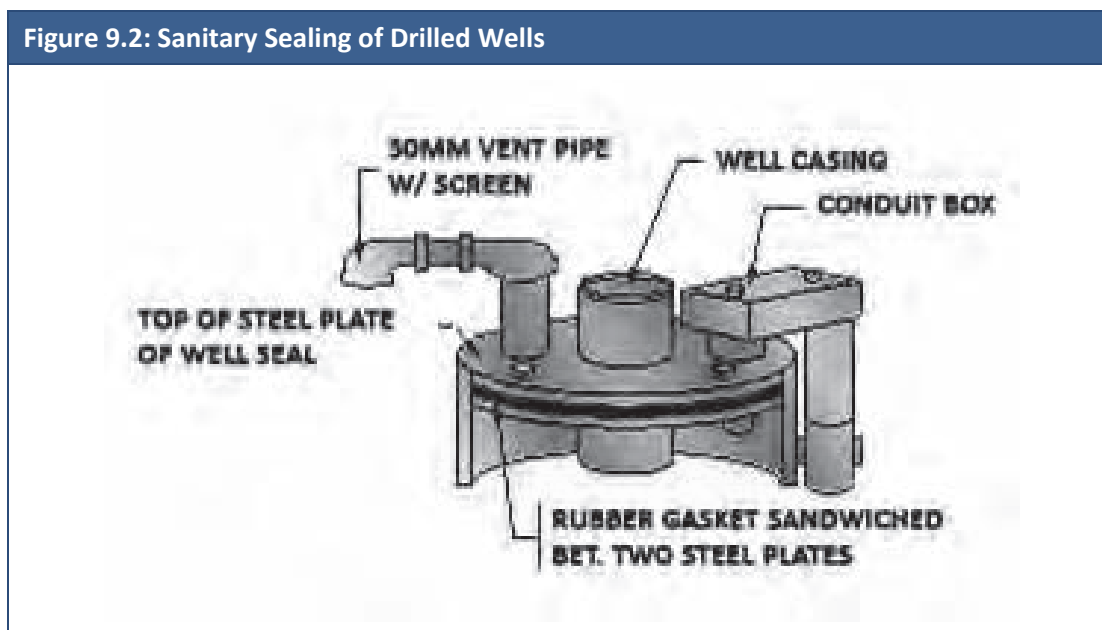


The annular space must be filled up with grout to protect the aquifer. The grout consists of cement and water plus bentonite<sup>8</sup> to reduce shrinkage. A reinforced concrete well slab at the well top is also important to protect the well.

## 2. Sanitary Sealing of Drilled Wells

The top of the casing must extend approximately 0.3 m above the surface of the ground/floor and be watertight with a tight sanitary well seal where the pump connection enters the well. The seal must close all openings for riser mains, cables and monitoring equipment.

Any vent pipe should be screened to prevent entry of insects, snakes and the like. The ground level around the well top must be sloping away in all directions from the well to prevent entry of surface runoff. (Figure 9.2)



## 3. Formation Sealing of Dug Wells

The dug diameter of the well is only a little larger than the concrete culvert and the lower annular space is usually filled up by cave-ins. The annular space around the culvert should first be filled by grout up to the water level or at least up to at 2 meters from the surface. The balance of the annular space can be filled up with clay up to the concrete slab.

<sup>8</sup> Used in rotary drilling to aid in formation of mud cakes

## C. Formation Sealing of Springs

Spring water suitable for drinking is normally located on a hill or mountainside. The spring water is collected by placing perforated drains in the aquifer. After installing these pipes, the aquifer should be enclosed in clay so that polluting surface water will not infiltrate. In constructing the spring box, all surfaces in connection with clay should be sealed with cement grout.

## D. UNDERGROUND POLLUTION

If the water source is safely protected against surface contamination but is still supplying polluted water, there are 2 possible major causes of pollution:

1. The groundwater is infiltrated by contaminated ground water.
2. The water source is contaminated by a septic tank or leachate water from a dumpsite.

***It is almost impossible or just too expensive to try to correct underground pollution. It would probably be more practical to develop a new water source elsewhere.***


## E. POLLUTION FROM MINING

There is growing awareness of the environmental legacy of mining activities that have been undertaken with little concern for the environment. The impact on the country's water resources have been costly, and shall be paid not only by the present generation but also future generations to come.

Mining by its nature consumes, diverts, damages the condition of the earth, and can seriously pollute water sources, as the following summaries of its extensive impacts on water quality describe:

### 1. Acid Mine Drainage (AMD)

Acid Rock Drainage (ARD) is a natural process whereby sulfuric acid is produced when sulfides in rocks are exposed to air and water. Acid Mine Drainage (AMD) is essentially the same process, greatly magnified. When large quantities of rock containing sulfide minerals are excavated from an open pit or opened up in an underground mine, it reacts with water and oxygen to create sulfuric acid. When the water reaches a certain level of acidity, a naturally occurring type of bacteria called *Thiobacillus ferrooxidans* may kick in, accelerating the oxidation and acidification processes, leaching even more trace metals from the wastes. The acid will leach from the rock as long as its source rock is exposed to air and water and until the sulfides are leached out – a process that can last hundreds, even thousands of years. Acid is carried from the mine site by rainwater or surface



drainage and deposited into nearby streams, rivers, lakes and groundwater. AMD severely degrades water quality, and can kill aquatic life and make water virtually unusable.

## **2. Heavy Metal Contamination & Leaching**

Heavy metal pollution is caused when such metals as arsenic, cobalt, copper, cadmium, lead, silver and zinc contained in excavated rock or exposed in an underground mine come in contact with water. Metals are leached out and carried downstream as water washes over the rock surface. Although metals can become mobile in neutral pH conditions, leaching is particularly accelerated in the low pH conditions such as are created by Acid Mine Drainage.

## **3. Processing Chemicals Pollution**

This kind of pollution occurs when chemical agents (such as cyanide or sulfuric acid used by mining companies to separate the target mineral from the ore) spill, leak, or leach from the mine site into nearby water bodies. These chemicals can be highly toxic to humans and wildlife.

## **4. Erosion and Sedimentation**

Mineral development disturbs soil and rock in the course of constructing and maintaining roads open pits, and waste impoundments. In the absence of adequate prevention and control strategies, erosion of the exposed earth may carry substantial amounts of sediment into streams, rivers and lakes. Excessive sediment can clog riverbeds and smother watershed vegetation, wildlife habitat and aquatic organisms.



# Chapter 10

## Water Treatment

This Chapter provides the basic parameters and methods for the design of simple water treatment facilities.

### A. GENERAL

Water treatment, also known as water purification, is the process of removing undesirable chemicals, materials, and biological contaminants from raw water. The purpose of water treatment is to ensure that the quality of the water to be supplied to the consumers is within acceptable standards.

Depending on the treatment method, the concentration of the undesirable particulates or contaminants may be reduced or even eliminated. These contaminants include suspended particles, dissolved elements and minerals, bacteria, and algae that degrade the raw water quality.

### B. THE DESIGN OF WATER TREATMENT FOR LEVEL II FACILITIES

***Water treatment ideally should be avoided.***

***It is best to select sources with good water quality at the outset to reduce facility and operation costs.***

In case treatment cannot be avoided, the financial capacity of the users, including the technical ability of the persons who will operate and maintain the facilities, have to be taken into account. It must be considered that the structures needed to treat water are costly, and thus could result in water costs that the users cannot afford. It is for this reason too that for Level II facilities, it is vital to draw the participation and cooperation of the residents in the operation and maintenance of water treatment facilities; but this may be difficult to do successfully if the facilities entail complex mechanisms.

### C. RAW WATER SOURCES

The general description of the raw water characteristics of these sources which may require treatment are briefly summarized in the following sections.

#### 1. Groundwater Sources

Groundwater originally comes from rain and water runoffs that pick up a lot of impurities while on the ground. These impurities may include inorganic and organic soil

particles, debris, micro-organisms, and chemicals. The contaminated rain and water run-off percolates underground. As it flows deeper underground, water quality improves. Suspended particles are removed by filtration, organic substances are degraded by oxidation, and micro-organisms die due to lack of nutrients. However, dissolved minerals are not removed and may even increase depending on the physical/chemical properties of the subsurface strata it passes through.

The most common type of water quality problems of groundwater sources, especially wells, is the excessive amount of iron and manganese in the raw water.

When a groundwater source is properly designed and constructed and its supply is properly withdrawn, its raw water would be free from turbidity and pathogenic organisms. When said source taps a clean and good water quality aquifer, without objectionable substances, there will be no need for a water treatment process, except for disinfection prior to water distribution.

***Disinfection:***

***Disinfection is treated in detail in “Chapter 3: DISINFECTION” found in the companion OPERATION AND MAINTENANCE MANUAL (Vol. III of this Rural Water Supply series.)***

***Where required either by itself or in conjunction with the water treatment procedures covered in this Chapter, please refer to said Chapter 3 of Volume III.***

Groundwater sources that tap aquifers with high organic matter content will have raw water containing a high amount of carbon dioxide. Such a condition will deplete the water’s oxygen content. Water without or with very low oxygen will dissolve iron, manganese and heavy metals from the underground. These dissolved substances and minerals could be removed by aeration.

## **2. Surface Water Sources**

Surface water sources come from both groundwater outflows and from rain water run-offs. The groundwater outflows have dissolved solids and minerals, while rain water run-offs bring turbidity, organic matter, pathogenic organisms, and other pollutants. Over time, the dissolved minerals remain unchanged while other impurities are reduced. Usually, organic substances are reduced through chemical processes, pathogenic organisms diminish due to lack of food, and suspended solids settle down. But waste influents and other contributing groundwater and surface water tributaries bring additional contaminants to the receiving body of the surface water source. Algal growth is also a common water quality problem of surface sources.

The ideal treatment method for a surface water source depends on the impurities that are expected to contaminate the water. In upland uninhabited areas, where clear water abounds in rivers and lakes, there might be no need for a water treatment. However, there is the possibility that bacteria and pathogens are present. Thus, it is necessary to provide chlorination facilities to take care for such contamination. Many upland sources have low pH which may require adjustments. On the other hand, low land surface water sources have usually significant bacterial load, algae, suspended solids, and dissolved constituents, which might require complex and expensive treatment processes.

### **3. Pollution Sources**

Sources of pollution to the water obtained from ground water surface water sources are discussed in Chapter 9.

## **D. SELECTION OF TREATMENT PROCESS**

The designer of a water treatment facility for a rural water supply project should strive to achieve the following design features:

1. Keep the facility simple to operate and maintain; avoid as much as possible complex operation and maintenance methods as these will only cause problems in the future.
2. Minimize utilization of electro-mechanical equipment, and ideally adopt or develop processes that do not require the use of mechanically or electrically operated equipment.
3. Employ as much as possible natural methods of treatment. If the use of chemicals cannot be avoided, adopt methods that minimize their use.

The type or method of treating raw water depends mainly on the degree of concentration of unwanted qualities in water. Table 10.1 on the next page presents the different treatment methods or processes and the corresponding impurities that are effectively removed or reduced.

### **1. Preliminary Treatment**

Pre-treatment is generally used when the raw water contains large amounts of floating debris (e.g. sticks and leaves) as well as gravel, sand and soil sediments. The preliminary treatment process may include one or a combination of the following sub-processes: (a) screening/sieving, (b) pre-sedimentation, and/or (c) pre-chlorination.

### **2. Aeration**

This process is aimed at prolonging the contact time of the raw water and air in order to improve the chemical and physical qualities. There are many types of aerators, some of them are:

- **Gravity:** Allowing water to flow in thin sheets over a series of steps or weirs. Gravity systems are also known as cascades. (Refer to Figure 10.1)
- **Spray:** Spraying water in a well-ventilated tank.
- **Diffuser:** Use of baffles in a tank to lengthen the travel of water.
- **Mechanical:** Introducing air bubbles in the water with a mechanical device.

**Table 10.1: Treatment Options**

Treatment Process	Groundwater	Surface Water
Pre-chlorination		Algae Pathogenic organisms Bacteria
Aeration	Iron and Manganese Hydrogen Sulfide	Taste and odor
Sedimentation		Organic matter Bacteria Suspended solids
Slow Sand Filtration		Turbidity Color Taste and odor Bacteria Iron and manganese Organic matter
Post Chlorination	Pathogenic organisms	Pathogenic organisms Bacteria

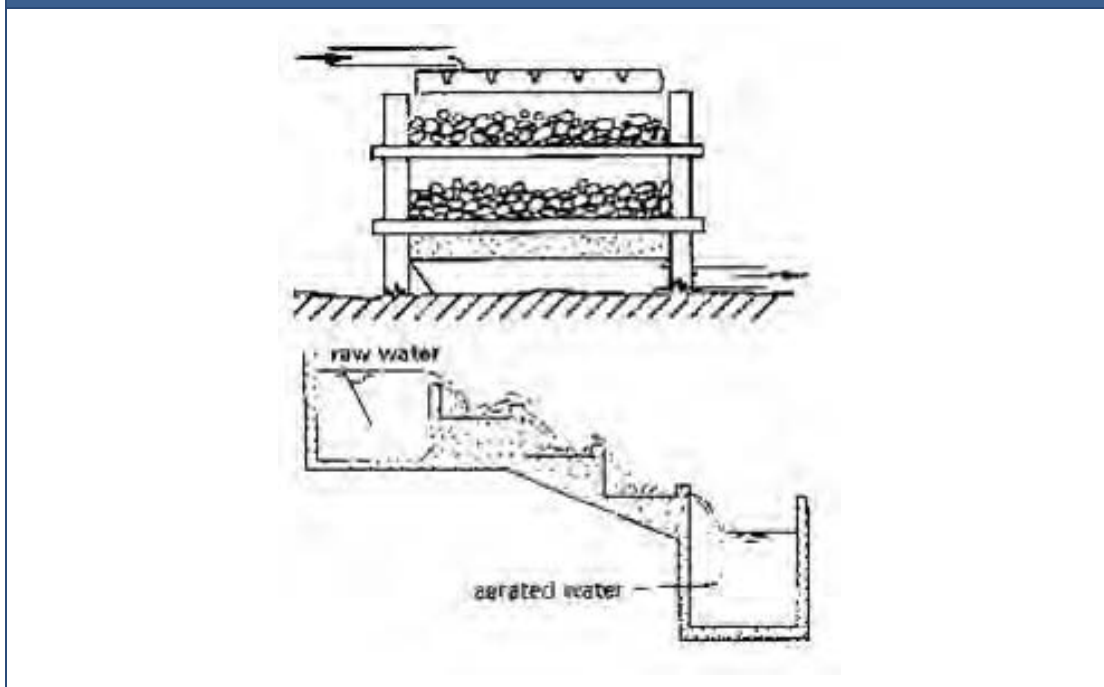
Aeration methods are utilized where the following physical and chemical properties are found to be unacceptable or over the permissible limits:

1. Taste and odor caused by dissolved gases like hydrogen sulfide;
2. Iron and manganese which are removed by oxidation. Dissolved iron and manganese, upon contact with free oxygen from air will form an insoluble precipitate which could be removed by subsequent filtration;
3. Obnoxious gases like H<sub>2</sub>S and CO<sub>2</sub>. Excessive carbon dioxide makes the water corrosive and dissolves iron in the piping system.

Typical air-water ratios for removal of volatile organic chemicals range from about 6:1 to 100:1.



Figure 10.1: Cascading Aerators



*GTZ – Simple methods for Treatment of Drinking Water*

### 3. Sedimentation

Water can contain suspended solid matter consisting of particles of many different sizes. Sedimentation, or clarification, is the process by which suspended materials settle by gravity. Suspended materials may be particles such as clay or silt originally present in the source water.

While some of the suspended materials will be large and heavy enough to settle rapidly to the bottom of a container, very small particles will settle only very slowly or not at all. These small solid particles cause the liquid to appear turbid.

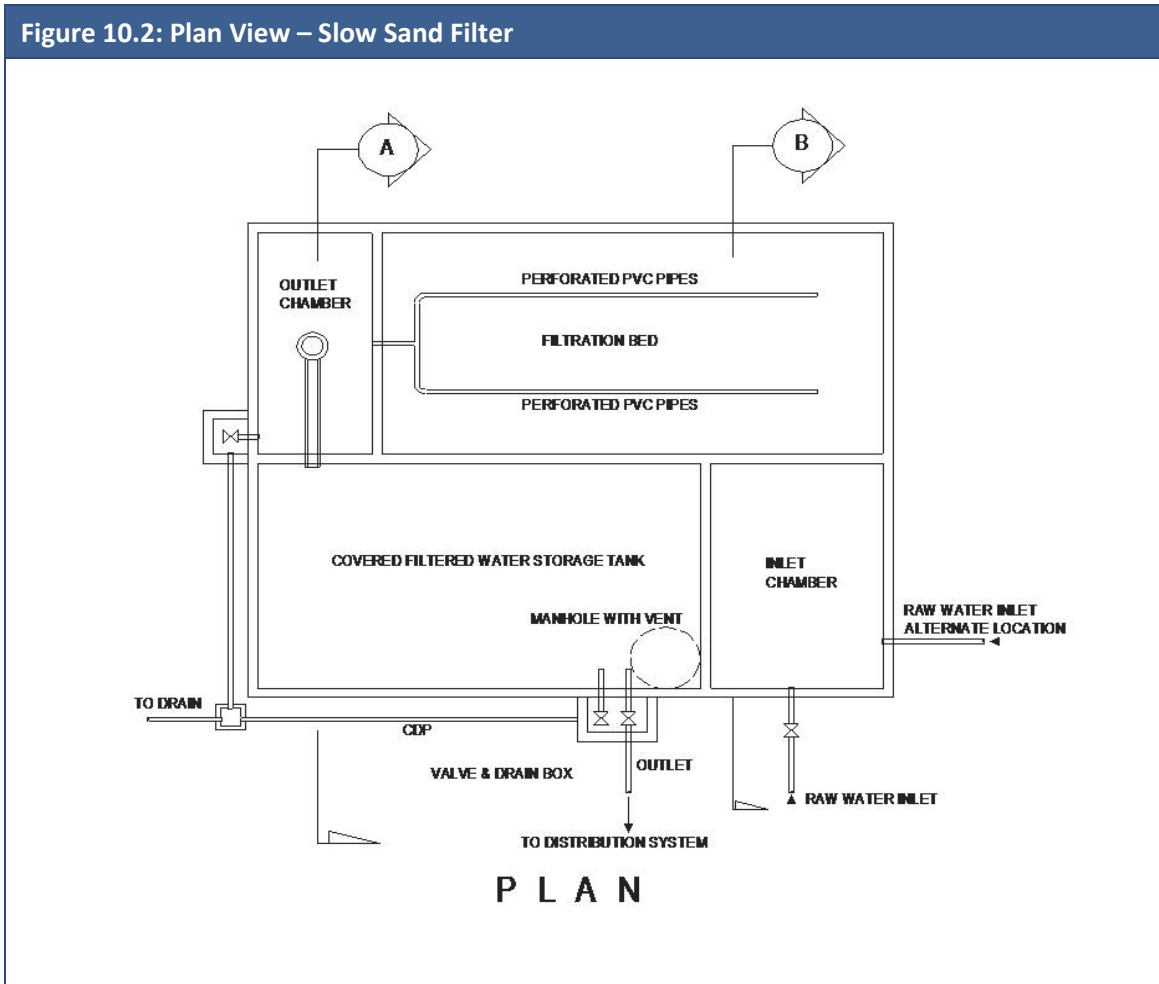
Sedimentation is accomplished by decreasing the velocity of the water being treated to a point below which the particles will no longer remain in suspension. When the velocity no longer supports the transport of the particles, gravity will remove them from the flow.

In designing sedimentation tanks, the required detention time determines the dimensions of the tank. A rectangular tank is the simplest design to use. Detention time is calculated as  $\text{Volume}/\text{Flow rate (Q)}$ . The detention times based on the average daily flows are usually from about 45 minutes to 3 hours depending on turbidity.

The ideal inlet reduces the entrance velocity and distributes the water as uniformly as possible across the depth and width of the tank. Outlets are usually weirs which are sufficiently long to reduce the flow velocity, and so avoid the re-suspension of the solids in the water.

## 4. Slow Sand Filtration

Slow sand filtration is a cheap and simple method of purifying water. It uses local skills and materials. Figure 10.2 and Figure 10.3 show schematic diagrams of a slow sand filter and filtered water reservoir.



*NWRC RWS Volume I, Design Manual*

A slow sand filter is basically a large tank containing the sand bed. Water is introduced at the top. It trickles down through the sand bed to the underdrains and goes to the storage tank. The impurities in the water are retained at the upper layers of the sand bed. In the process, a slimy layer (called sludge) consisting of bacteria and microscopic plants grow. The sludge removes the organic matter and most of the pathogenic microorganisms in water which might be smaller than the pores of the sand.

Slow sand filters can achieve the following:

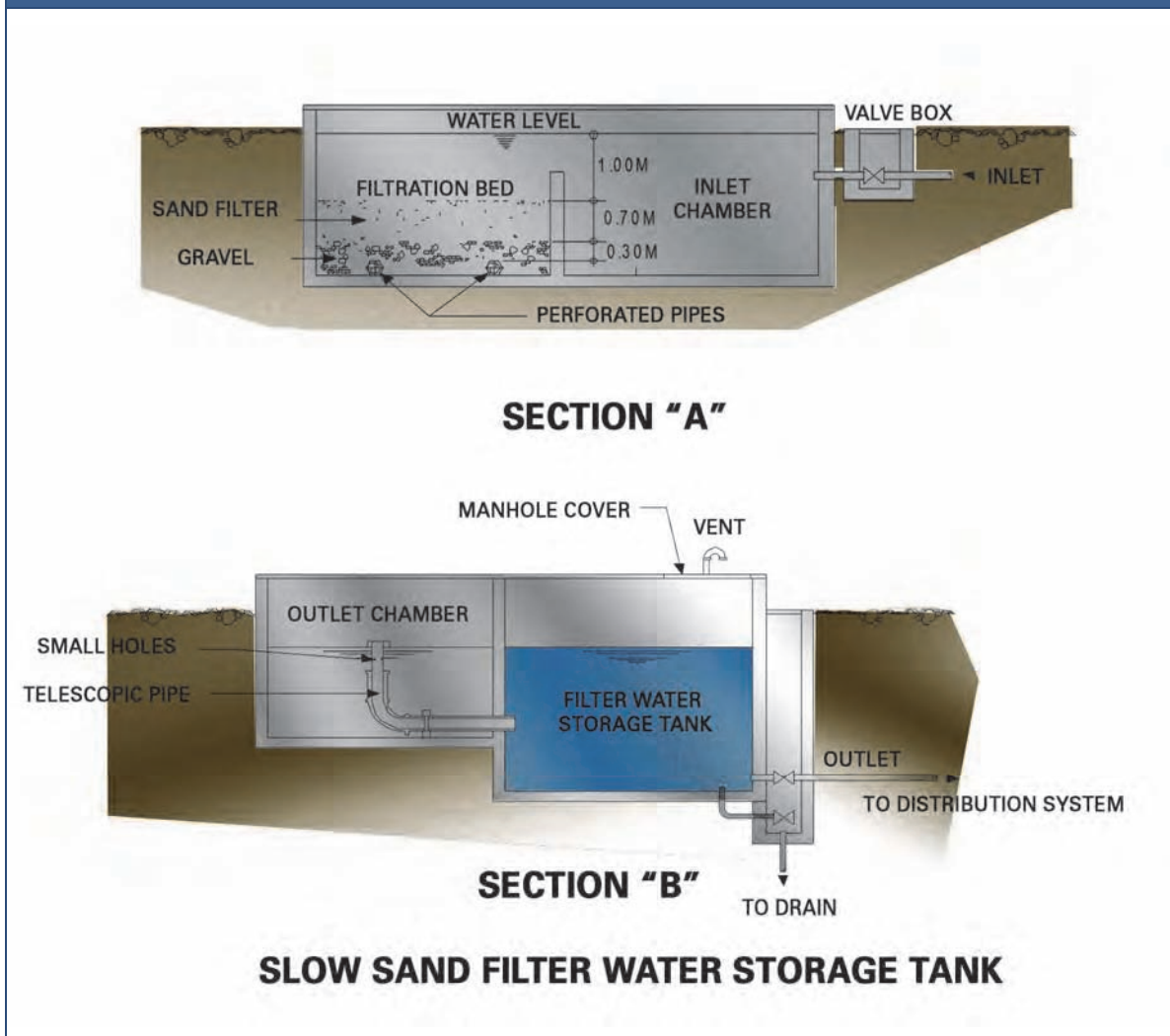
- Reduce bacterial count of raw water by 85% to 99%
- Reduce turbidity of the raw water by about 90% or more
- Reduce the concentration of color in raw water.

However, if the turbidity of raw water is greater than 50 mg/l (maximum limit), a pre-sedimentation facility is necessary prior to filtration to prevent short filter runs.

Sand of from 0.1 to 0.3 mm with uniformity coefficients of 2 – 3 is commonly employed. Thickness can range from 0.5 – 1.0 m. The depth is gradually reduced since the bed is cleaned by periodic removal of layers. The sand is supported by a layer of gravel usually up to 0.3 m in depth graded from fine (5 mm) at the top to coarse (50 mm) at the bottom.

Underdrains are normally made of perforated pipes placed within the lower portion of the support gravel to collect the filtrate.

Figure 10.3: Slow Sand Filter Sections



NWRC RWS Volume I, Design Manual



# Chapter 11

## Applied Hydraulics

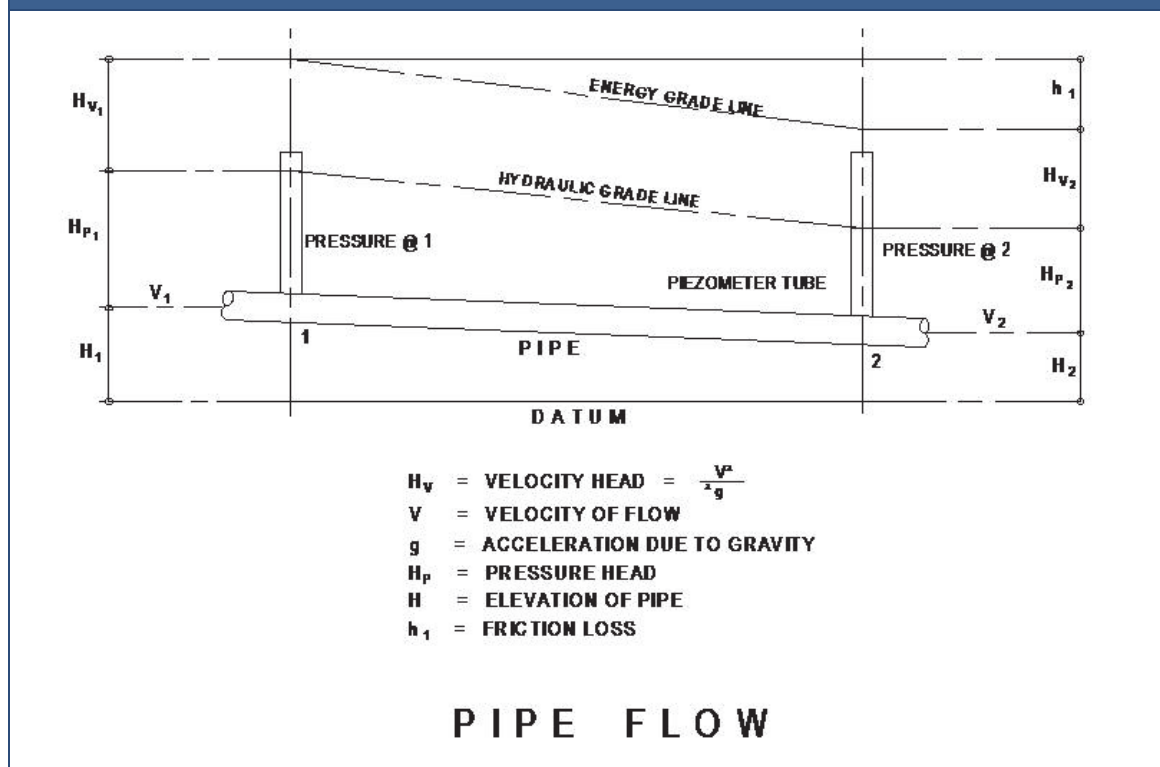
This Chapter deals with characteristics of water as it passes through the pipelines of distribution systems, and the basic calculations of pressure and friction losses in pipes and appurtenances.

### A. FACTORS DETERMINING PIPE FLOW RATES

Hydraulics is concerned with the properties and behavior of fluids when at rest and in motion. The factors that affect the flow of water in pipes are as follow:

- Cross sectional area;
- Roughness of the pipe's inner surface;
- Condition and type of flow;
- Obstructions; and
- Energy head

**Figure 11.1: Pipe Flow and HGL**



*NWRC RWS Volume I, Design Manual*

The following terms and concepts are important in the understanding of the behavior of water as it flows through the pipes to the consumers. This behavior, its causes, and the dynamic forces it creates, have to be understood in order for the pipelines to be properly designed, in a way that will withstand their effects and be in good service over the facilities' design life.

1. **Hydraulic Grade Line (HGL)** - The Hydraulic Grade Line (HGL) is an imaginary line that connects the points on which the water would rise in a piezometer tube if inserted in any place along the pipe (Figure 11.1). It is the measure of the pressure head available plus elevation of the pipe at various points.
2. **Energy Grade Line** – is the summation of elevation head (H) of the pipe, pressure head (Hp) and velocity head (Hv) with reference to a fixed datum. Also to be considered is the head loss (HL) or friction/energy lost in conveying the water from one point to another.
3. **Equivalent Length** – is the length of fittings, appurtenances, etc. reduced to a specific length of straight pipe with same diameter. This is used in the computation of head loss that occurs at valves, fittings, etc.

## B. WATER PRESSURE

### 1. Basic Principles

Pressure **P** is defined as the force exerted per unit area:

$$P = \frac{\text{Force}}{\text{Area}}$$

Where:

$$P = \text{pressure in } \frac{\text{kgf}}{\text{cm}^2}$$
$$F = \text{force, kgf}$$
$$A = \text{area, cm}^2$$

**NB.** Read "kgf" as "kilogram force"

The force represents the weight of a column of water above a certain point. The weight then is equal to the volume of the column of water multiplied by the specific weight of water. Specific weight of water equals 1 kgf/liter or 1,000 kgf/m<sup>3</sup>.

### 2. Static Water Pressure

Static water pressure is the pressure in the system when water is not flowing. It is an indication of the potential pressure available to the system. This pressure is produced by:

- Placing the water at an elevation above the location of water use (for example, in an elevated reservoir;

- Imparting energy to the water through a pump; and
- Air pressure in hydro-pneumatic tanks

### 3. Dynamic Water Pressure

The dynamic water pressure is the pressure at any particular point with a given quantity of water flowing past that point. Dynamic pressure differs from static pressure in that it varies throughout the system due to the friction losses during the transport of water. In this Manual, the dynamic and static pressure terms are expressed simply as pressure or head.

### C. FRICTION LOSS

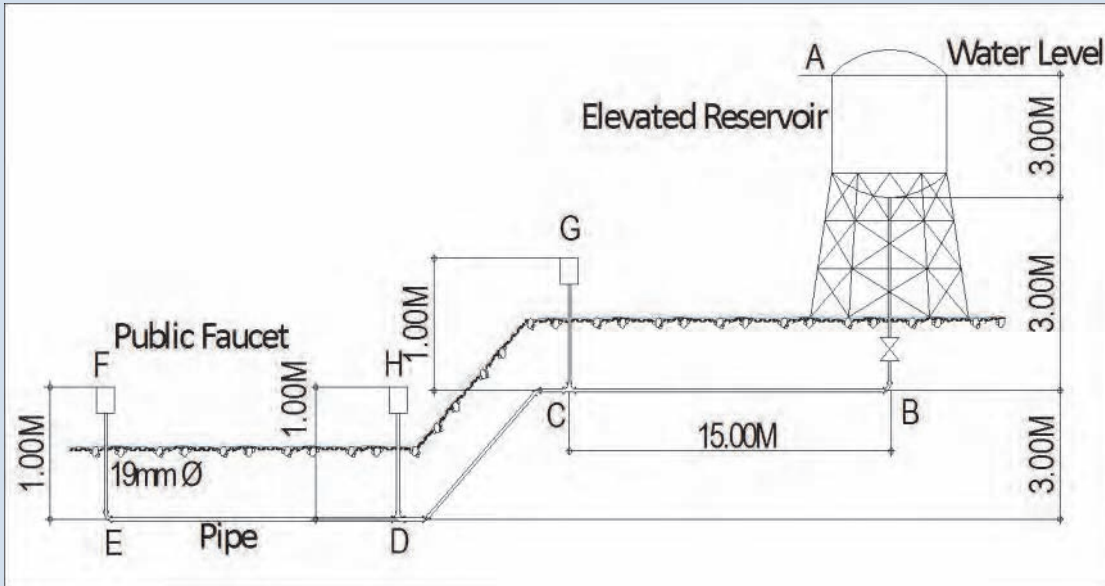
Friction loss is the loss of pressure caused by water flowing through the pipe in a system. Flow in pipes is usually turbulent and the roughness of the inside walls of pipes have a direct effect on the amount of friction loss. Turbulence increases and consequently friction loss increases with the degree of roughness.

Friction loss is thus determined by the type, size and length of the pipe and the amount of water flowing through it.

Friction loss in plastic pipes and galvanized (G.I.) pipes can be estimated using Table 11.1 and Table 11.2, respectively. The information necessary to determine the pressure loss are the pipe size and the discharge rate,  $Q$ . Also, Table 11.1 and Table 11.2 can be used to determine pipe sizes if the discharge rate and friction loss are given.

Furthermore, when water flows past valves, fittings and public faucets, there is a loss in energy due to friction. This loss of energy can be calculated by the use of Table 11.3. The pipe fittings, valves and public faucets are first reduced to an equivalent length of straight pipe using Table 11.3 and then the corresponding friction loss is determined using Table 11.1 or Table 11.2.

**Example 11.1: Determine the pressure at places of different elevations in the system shown below**



**Answer:**

- At Point A, the static Pressure = 0
- At Point B, the static Pressure = 6 m
- At Point C, the static Pressure = 6 m
- At Point D, the static Pressure = 9 m
- At Point E, the static Pressure = 9 m
- At Point F, the static Pressure = 8 m (9 – 1)
- At Point G, the static Pressure = 5 m (6 – 1)
- At Point H, the static Pressure = 8 m

*NWRC RWS Volume I, Design Manual*



**Table 11.1: Friction Head Loss in meters per 100 meters in Plastic Pipe**

Q Lps	Pipe Sizes (mm)									
	13	19	25	31	38	50	63	75	100	150
.01	0.1									
.02	0.4									
.03	0.8	0.11								
.04	1.4	0.19								
.05	2.1	0.20								
.06	3.0	0.41	0.10							
.07	4.0	0.50	0.13							
.08	5.0	0.65	0.17							
.09	6.3	0.82	0.22							
.10	7.0	1.06	0.26							
.11	9.1	1.18	0.31	0.11						
.12	10.7	1.50	0.36	0.13						
.14		2.00	0.48	0.17						
.15		2.10	0.55	0.18						
.16		2.50	0.62	0.22						
.18		3.10	0.77	0.27	0.101					
.20		3.80	0.94	0.32	0.131					
.25		5.80	1.42	0.48	0.20					
.30			2.00	0.67	0.23					
.40			3.40	1.15	0.47	0.12				
.50			5.10	1.74	0.71	0.18				
.60			7.20	2.40	1.00	0.25				
.70				3.20	1.33	0.33	0.11			
.80				4.10	1.70	0.42	0.14			
1.00				6.30	2.60	0.64	0.21	0.069		
1.20				8.80	3.60	0.89	0.30	0.124		
1.40					4.40	1.20	0.40	0.165		
1.50					4.90	1.35	0.44	0.187		
1.60					5.50	1.52	0.51	0.211		
1.80					7.35	1.80	0.64	0.262		
2.00					8.40	2.30	0.77	0.32	0.079	
2.50						3.50	1.20	0.48	0.119	
3.00						4.95	1.65	0.68	0.166	
3.50						6.95	2.19	0.90	0.221	
4.00						9.20	3.00	1.15	0.184	
4.50						11.85	3.60	1.43	0.353	
5.00							4.50	1.74	0.429	0.06
6.00							6.20	2.44	0.60	0.09
7.00							8.60	3.20	0.80	0.11
8.00								4.15	1.20	0.14
10.00								6.50	1.55	0.21

NWRC RWS Volume I, Design Manual

**Table 11.2: Friction Head Loss in meters per 100 meters Galvanized Iron (GI) Pipes**

Q Lps	Pipe Sizes (mm)									
	13	19	25	31	38	50	63	75	100	150
.06	6.00	0.82	0.20							
.07	8.00	1.00	0.26							
.08	10.00	1.30	0.34							
.09	12.60	1.64	0.44	0.15						
.10	15.20	2.12	0.52	0.18						
.11	18.20	2.36	0.62	0.22						
.12	21.40	3.00	0.72	0.26						
.14		4.00	0.96	0.34	0.13					
.15		4.20	1.10	0.36	0.15					
.16		5.00	1.24	0.44	0.16					
.18		6.20	1.54	0.54	0.202					
.20		7.60	1.88	0.64	0.262	0.70				
.25		11.60	2.84	0.96	0.400	0.10				
.30			4.00	1.34	0.46	0.14				
.40			6.80	2.30	0.94	0.24				
.50			10.20	3.48	1.42	0.36	0.12			
.60			14.40	4.80	2.00	0.50	0.17	0.70		
.70				6.40	2.66	0.66	0.22	0.91		
.80				8.20	3.40	0.84	0.28	0.117		
1.00				12.60	5.20	1.28	0.42	0.177		
1.20				17.60	7.20	1.78	0.60	0.248		
1.40					8.80	2.40	0.80	0.330		
1.50					9.80	2.70	0.88	0.374		
1.60					11.00	3.04	1.02	0.422	0.104	
1.80					14.70	3.76	1.28	0.524	0.129	
2.00					16.80	4.60	1.54	0.640	0.157	
2.50						7.00	2.40	0.96	0.238	
3.00						9.90	3.30	1.36	0.332	
3.50						13.90	4.38	1.80	0.442	
4.00						18.40	6.00	2.30	0.368	
4.50						23.70	7.20	2.86	0.706	
5.00							9.00	3.48	0.858	0.12
6.00							12.40	4.88	1.200	0.17
7.00							17.20	6.40	1.60	0.22
8.00								8.30	2.40	0.20
10.00								13.00	3.10	0.42

NWRC RWS Volume I, Design Manual

**Table 11.3: Head Loss Due to Valves and Fittings**

Resistance of Valves and Fittings										
Nominal $\phi$ in mm	90° Elbow	45° Elbow	Tee	Gate Valve Fully Open	Globe Valve Fully Open	Angle Valve Fully Open	Faucet Fully Open	Foot Valve Fully Open	Strainer	Check Valve Fully Open
<b>Equivalent Length Straight Pipe (meters)</b>										
13	0.55	0.24	1.04	0.11	4.88	2.56	4.88	1.22	3.05	1.16
19	0.69	0.30	1.37	0.14	6.40	3.66	6.40	1.52	3.66	1.58
25	0.84	0.41	1.77	0.18	8.23	4.57		1.83	4.27	1.98
32	1.14	0.52	2.29	0.24	11.28	5.49		2.13	4.88	2.74
38	1.36	0.61	2.74	0.29	13.71	6.71		2.44	5.49	3.35
50	1.62	0.76	3.66	0.38	16.76	8.54		2.74	6.10	4.27
63	1.98	0.91	4.27	0.43	19.81	10.06		3.05	6.71	5.18
75	2.50	1.16	4.88	0.53	25.90	12.80		3.66	7.62	5.79
100	3.35	1.52	6.71	0.70	33.54	12.80		4.57	9.15	7.62
150	5.03	2.04	9.76	1.01	48.78	24.39		6.42	12.21	11.59

\* When the length of pipe is greater than 1,000 times its diameter, the loss of head due to valves and fittings may be disregarded.

NWRC RWS Volume I, Design Manual

### Example 11.2

A pipe 200 m in length and 19 mm in diameter carries water at the rate of 0.20 liters per second. How much head or pressure would be lost due to friction if PVC pipe is used? If GI pipe is used?

**Required:** Friction Loss

1. If PVC Pipe is used
2. If GI Pipe is used

**Solution:**

1. **If the pipe material is PVC:**

Determine the friction loss per 100 m

Referring to Table 11.1 locate  $Q = 0.2$  lps and move horizontally until the column for 19 mm diameter is reached. Read the figure.

From the table, the friction loss is  $hf = 3.8$  m/100 m of pipe length.

Calculate the friction loss, HL of 200 m length of PVC pipe

$$HL = hf \times L = \frac{3.8 \text{ m}}{100 \text{ m}} \times 200 \text{ m} = 7.6 \text{ m}$$

2. **If the Pipe Material is GI:**

The friction loss, HL for GI pipes is determined using Table 11.2, with  $Q = 0.20$  lps and  $D = 19$  mm.

$hf = 7.6$  m/100 m (from Table 11.2)

$$HL = \frac{7.6 \text{ m}}{100 \text{ m}} \times 200 \text{ m} = 15.2 \text{ m}$$

### Example 11.3

A 240 m length of pipe will be used to convey water from a spring located at top of the hill to the barrio reservoir. The elevation of the spring is 3.0 m higher than the maximum water surface elevation of the reservoir and therefore, the water can be transported through gravity flow. If the desired flow is 4 lps, what size of pipe should be used if PVC pipe is used?

**Given:** Length of pipe = 240 m  
Pressure Head Available  $H_p = 3$  m  
 $Q = 4$  lps

**Required:** PVC Pipe Size

**Solution:** The pipe material is PVC.

The minimum pipe size can be obtained when the available head or pressure will equal to friction losses when water is flowing at the desired  $Q = 4$  lps. Total friction loss is 3 m which over a 240 m pipeline would have an  $h_f = 1.25$  m per 100 m.

Referring to Table 11.1, locate  $Q = 4$  lps and move horizontally until  $h_f/100$  m = 1.25 is found in or any value found in Table 11.1 which is nearest to 1.25. Find the column of pipe size having this friction loss. From Table 11.1, the nearest value to 1.25 m is 1.15 which is found in the column of pipe size with the size of 75 mm. Therefore, a 75 mm PVC pipe can transport water from the spring to the reservoir.

Using the same procedure, if a GI pipe will be used, the required diameter will be 100 mm.

### Example 11.4

A gravity storage tank shown is located on a hill. The minimum water surface elevation of 9 m is above the faucet and requires 100 meters of pipe, two 90° elbows, a gate valve, and a 13 mm faucet. The desired flow at the faucet is 0.12 liters per second. What size pipe should be used if a minimum residual pressure of 3 m is to be attained at the faucet?

**Given:**  $H = 9$  m of storage tank  
 $L = 100$  m

*(Continued on next page)*

(Example 11.4 continued from previous page)

No. of 90° elbows = 2

No. of gate valves = 1

No. of faucets = 1, Diameter = 13 mm

Q = 1.12 lps

**Required:** PVC Pipe Diameter

**Solution:**

1. Calculate maximum allowable pipe friction losses disregarding head loss in fittings and valves.

$$H = \text{Elevation head} - \text{minimum residual pressure} = 9 - 3 = 6\text{ m}$$

$$\text{Since pipe } L = 100\text{ m, then } 6\text{ m} = hf/100\text{ m}$$

2. Using Table 11.1, calculate the pipe diameter when Q = 0.12 lps and hf/100 m = 6 m

D = 13 mm is a possible answer but the friction loss is already 10.7 m/100 m pipe length which is already more than the allowable 6 m. Try the next size higher (19 mm) wherein hf of 19 mm = 1.50 m/100 m pipe length.

3. Using 19 mm diameter pipe, check if total friction loss will be higher than 6 m.

First, calculate the equivalent length (EQL) of pipes fittings, valves, etc. using Table 11.3 with D = 19 mm

Material	Diameter	No. of Pieces	EQL/Fitting	EQL
Elbow, 90°	19 mm	3	0.69	2.07
Gate Valve	19 mm	1	0.14	0.14
Faucet	13 mm	1	4.88	4.88
<b>Total Equivalent Length</b>				<b>7.09 m</b>

Calculate the total length. The total length is the sum of the straight pipe and the equivalent length of valves, fittings, etc.

$$\text{Total Length} = 100 + 7.07 = 107.09\text{ m}$$

$$hf \text{ of } 19\text{ mm with } L \text{ of } 107.09\text{ m} = \frac{1.50\text{ m}}{100\text{ m}} \times 107.09\text{ m} = 1.6\text{ m}$$

19 mm diameter pipe was found to be satisfactory because the total head loss (1.6 m) incurred is smaller than the available head (6 m)

# Chapter 12

## Transmission and Distribution Systems

This Chapter shows the method for designing pipelines and the parameters to be considered when selecting pipe materials.

### A. INTRODUCTION

Transmission and distribution systems vary in size and complexity but they all have the same basic purpose, which is to deliver water from the source(s) to the customer.

In general, most of existing rural water distribution systems were originally designed and constructed as Level II public faucet systems. The lower capital cost and lower tariff requirements were primary considerations, particularly at the inception of projects. Eventually, however, most of the consumers realized the value of household connections, and preferences shifted to Level III service levels. As a result, many Level II facilities upgraded their services, although in many cases, they maintained their public faucets even as they provided Level III connections. The combined Level II/Level III options allowed customers who could not afford a home connection to continue to rely on the public faucet.

With this experience, it is recommended that in establishing Level II distribution and transmission systems, these should already be designed to allow future expansion and eventual upgrading to a higher level of service.

The design of the rural water system also needs to take into account the nature of operation. Most rural water utilities are remotely located and are operated and maintained by part time staff. Therefore, it is important that the systems be relatively simple to operate and maintain.

### B. METHODS OF WATER TRANSMISSION AND DISTRIBUTION

Water can be transported from the source to the treatment plant, if any, and the distribution system, and eventually reach consumers through one of the following methods:

- **Through gravity flow:** This is the ideal set-up when the location of the water source is at a considerably higher elevation than the area to be served. The operation cost of a gravity system is very low, as it does not require energy cost.
- **Through pumping with storage:** Water is either (a) pumped to a distribution pipe network, then to consumers, with excess water going to a storage tank, or (b) pumped to a storage tank first, then water is distributed by gravity from the tank to the consumers. The maintenance and operation cost of this system is higher than a gravity system.

- **Through direct pumping to the distribution system:** In this system, water is pumped directly from the source to the distribution system to the consumers. Where capital cost for a reservoir is not affordable at the initial stage of the water system, direct pumping to the distribution is usually resorted to. Variable speed or variable frequency drive pumps are most ideal for direct pumping operations, but the capital costs for such equipment are higher than for conventional water pumps.

## C. PIPELINE HYDRAULICS

### 1. Pressure

Pressure is a force applied perpendicular to a body that is in contact with a fluid, in this case, with water. In the English system, pressure is generally expressed in lb/in<sup>2</sup> abbreviated as psi. In the SI system, pressure has units of N/m<sup>2</sup>, also called Pascal. Because of the level or amount of pressure in a water supply system, pressure is commonly expressed in kilopascals (kPa) or simply in meters (m).

Pressure increases linearly with the depth of water. For water at rest, the variation of pressure over depth is linear. The pressure exerted by a column of water is called **pressure head**, and can be calculated using the formula below:

$$h = \frac{P}{\gamma}$$

**Where:**

*h = depth of water above a datum*  
*P = pressure*  
*γ = specific weight of water*

From the above formula and using the specific weight of water at 62.4 lb/ft<sup>3</sup> the following conversion factor can be used:

*1 psi = 2.31 ft pressure head (English system), or*  
*1 kPa = 0.102 m pressure head (SI)*

### 2. Head Losses

Shear stress is developed between the water and the pipe wall when water is flowing. The shear stress is the result of friction, and is dependent on the flow rate, the roughness of the pipe, and the length and diameter of the pipe. The commonly used formulas for computation of head loss due to friction (also called friction loss) are the:

- Darcy-Weisbach formula
- Hazen-Williams formula
- Mannings formula
- Combined Darcy-Weisbach and Colebrook-White equation.



This Manual recommends the use of Hazen Williams among the formulas. The formula, which is the most widely used, relates the velocity of the flow, hydraulic mean radius and hydraulic gradient. In terms of head loss due to friction, the formula is:

$$h_L = \frac{10.7 L \times Q^{1.852}}{C^{1.852} \times D^{4.87}}$$

**Where:**

- $h_L$  = headloss due to friction (m)
- $L$  = distance between sections or length of pipeline (m)
- $C$  = Hazen – Williams C – value
- $D$  = internal diameter (m)
- $Q$  = pipeline flow rate (m<sup>3</sup>/s)

The C-value is a carrying capacity factor that is sometimes referred to as the roughness coefficient, which varies depending on the pipe material being considered. Higher C-values represent smoother pipes and lower C-values are for rougher pipes. Higher C-values indicate higher carrying capacities. C-values increase with pipe size but decrease with pipe age. Although C-values are affected by changes in flow rates, the effect is negligible. Thus, network designers usually assume uniform C-value for different flow rates. Table 12.1 presents the recommended C-values for various pipe materials.

Table 12.1: Recommended Pipe C –Values (New Pipes)		
Pipe Material	Diameter	Recommended C-Values
Plastic	300 mm	150
	< 300 mm	140
Iron	300 mm	140
	< 300 mm	130

Another contributing component of total head loss is the head loss from turbulence due to pipe fittings and appurtenances. This category of loss is sometimes called minor losses. The total minor losses in a distribution network is usually insignificant compared with the total head loss of the system, thus, the designer may ignore this component in network analysis computation.

### 3. Hydraulic Grade Line (HGL)

Water in a pressurized pipe possesses three forms of energy which are:

- Kinetic energy – energy due to the water’s movement;
- Potential energy – energy due to elevation;
- Pressure energy – energy due to internal pressure.

The total energy per unit weight of water is called head. The kinetic energy is called the velocity head, the potential energy is called elevation head, and the internal pressure energy is called pressure head. The SI unit for head is meter (m). An imaginary line corresponding to the sum of the elevation heads and pressure heads versus distance is the hydraulic grade line (HGL) of the pipeline. The HGL corresponds to the height that water will rise vertically in a tube attached to the pipe that is open to the atmosphere. The determination of the HGL is essential in the design of transmission lines.

## D. TRANSMISSION SYSTEM

The transmission system's function is to transport water from source to the reservoir, if any, and to the distribution point. Water conduits for the transmission system may be canals, aqueducts or tunnels, free-flow pipelines, or pressure pipelines. The transmission of water will either be under gravity or pumping.

Pressure pipeline is generally the type of water conduit used in the Philippines for water supply transmission systems. **Thus, this Manual confines its discussion to pressurized piping systems.**

### 1. Analyzing the HGL

Transmission systems using pressure pipelines are less governed by the route's topography than other types of water conduits. Thus, when possible without a significant increase in the length of the pipeline, routing alongside roads or public ways is preferred to provide easier inspection and ready access for maintenance and repair. It is necessary, however, to coordinate with either the LGU or DPWH to secure the required clearances.

The designer should examine closely the plotted HGLs. All possible flow rates have different HGLs. The HGL is inversely affected by the flow rate. The HGL for the maximum possible flow rate for the main should always lie above the pipeline through the entire length of the transmission system.

The Hazen Williams Formula for head loss is recommended for analyzing the HGLs for each possible flow rate.

### 2. Computing for Transmission Pipe Size

Normally, the sizing of the transmission main is dependent on the total storage capacity and the way the supply is transmitted to the distribution system. The main should have at least the carrying capacity to supply water at a rate equivalent to the maximum day demand of the system for a given design year.

However, when the feasibility of the storage facility is considered (that is, considering the costs of the land and the structure at different storage capacities), different system schemes have to be analyzed with corresponding designed carrying capacities for the transmission main. For direct pumping to the distribution system with no reservoir, the

transmission main is designed for a maximum carrying capacity equivalent to the peak-hour demand. For systems with a storage reservoir with an intermediate storage capacity (20 – 25% of average day demand), the transmission main to the reservoir is designed at a carrying capacity rate 1.3 times the average day demand.

Once the supply rate is determined and the plan and profile of the transmission pipeline route are plotted, the pipe diameter(s) and HGL could be determined using the Hazen's William head loss formula.

As a rule of thumb, for transmission by pumping, it is advisable to assume a preliminary head loss (hL) of about 5.0 m/km of pipeline. (As much as possible, head loss should be limited to 10.0 m/km of pipeline for transmission by pumping.) For a gravity system with a considerably elevated source (e.g. highland springs), the transmission line could afford to have higher head losses as long as the remaining pressure head at the downstream end is sufficient for the distribution system's needs. For a gravity system with source that is not much higher than the distribution system, the head losses are lowered to attain sufficient pressure head in the distribution system.

In cases where the HGL goes below the profile of the transmission main, the HGL could be adjusted upward (decrease head loss) by increasing the pipe size, in its entirety or in part. Refer to Figure 12.1 for a profile of a transmission pipe from the source to the distribution system.

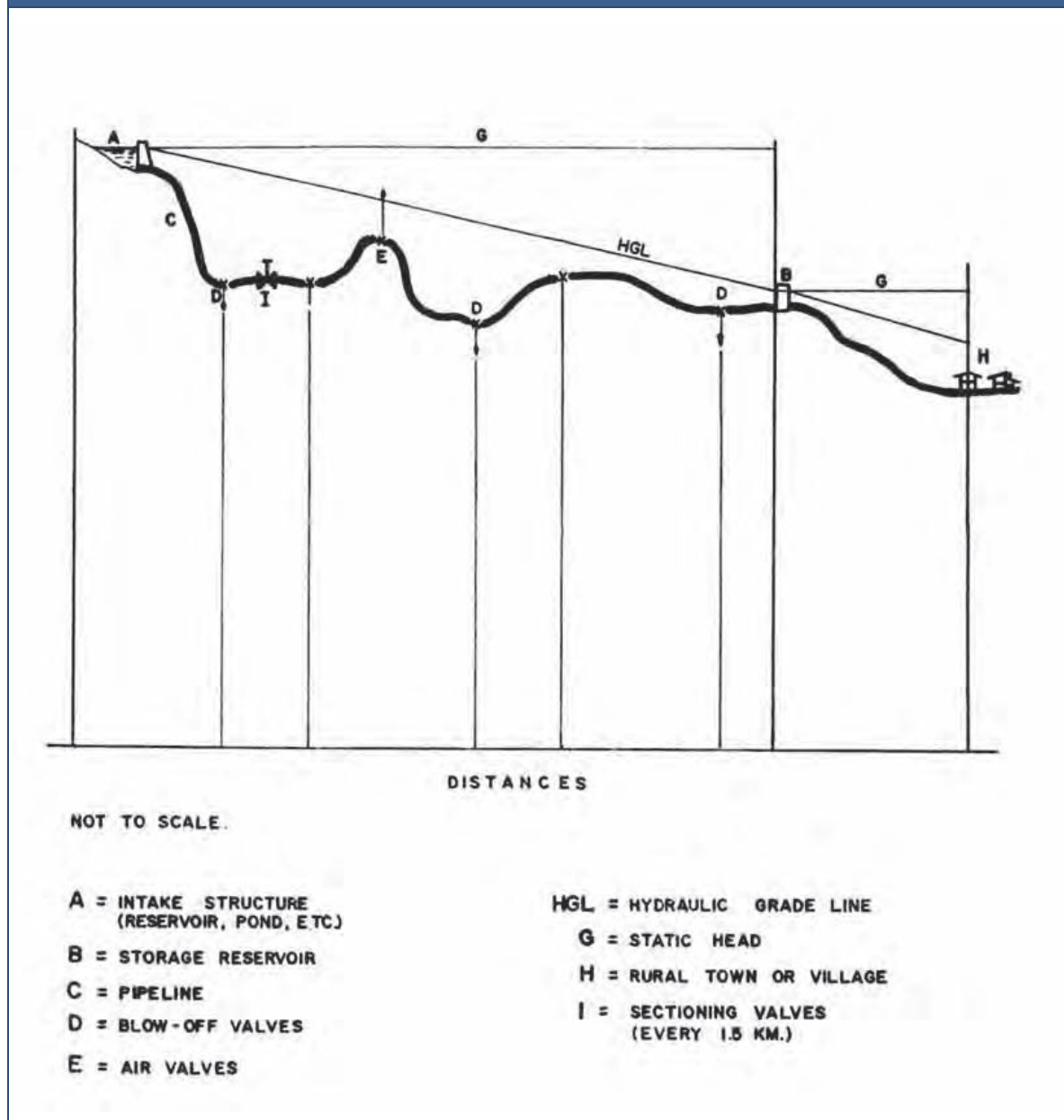
### **3. Maximum Pressure**

The pipe material must be selected to withstand the highest possible pressure that can occur in the pipeline. For a gravity system, the worst-case scenario is for pressure to be at its maximum during shut-off conditions (shut-off at downstream end) when the static pressure is too high. Normally, however, operators shut off transmission lines at the source facility during major repairs and emergency situations, practically draining the line of water and minimizing whatever static pressure remains in the line. For the transmission line design, a maximum computed HGL based on a minimum supply rate equivalent to 0.3 times the average day demand should be examined. At any point in the transmission line, this maximum HGL should not be over the allowable maximum pressure of the line (70 m head).

To limit the maximum pressure, break pressure tanks or chambers could be installed along the main. The break pressure tank or chamber will limit the static pressure by providing an open water surface at certain points of the transmission line.

One way of designing the transmission line is by the use of hydraulic computer software, which is discussed in the succeeding sections.

Figure 12.1: Profile of a Transmission Pipeline from Source to Distribution System



## E. DISTRIBUTION SYSTEM

As earlier discussed, distribution systems of small water supply providers in the Philippines are generally either Level II or Level III, depending on the method of delivery to the consumers. Quite often, too, these systems combine the individual house connections of the Level III system with the provision of public faucets needed to serve the lower income consumers.

For purposes of designing the pipelines, the distribution systems are considered also in terms of the topology or layout that is used. There are two types:

## 1. Branched System

Also referred to as a Dead-end System, the size of the main line in this distribution system decreases as its distance from the source increases, in consideration that the further pipes have to carry less water. The design of a branched system is generally straightforward, where the direction of water flow in all pipes and the flow rate can be readily determined. Figure 12.2 [A] illustrates a branched or dead-end system.

One of the advantages of a branched system is generally lower costs.

The disadvantages are:

- A main break will cause all downstream consumers to be out of service.
- It results in poor chlorine residuals and aging of water in low demand areas.
- During high demands, the velocities are faster, hence head losses are higher.

## 2. Looped System:

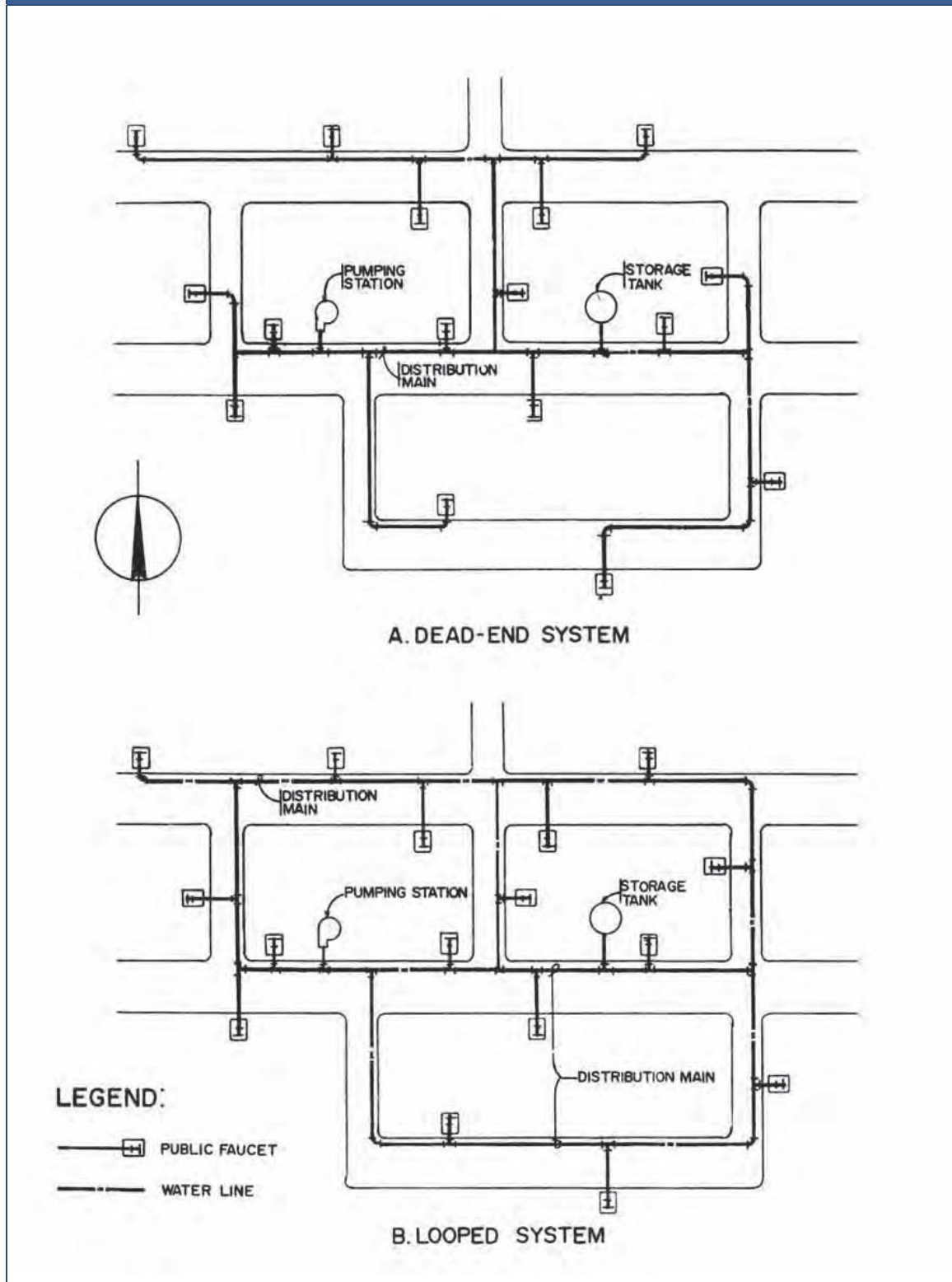
A distribution network is looped when there are only few or no pipe dead-ends, such that water can move through the system freely. The advantages of a looped system are:

- The lower water velocities in the main reduce head losses, resulting in greater capacity.
- Main breaks can be isolated, minimizing service interruptions to consumers.
- Usually better chlorine residual content is achieved.

The disadvantage is generally more costs because of the need for more pipes to create the loops.

***A major transmission design consideration is to ensure that if any section of the distribution main fails or needs repair, that section can be isolated without disrupting service to all or a great number of users in the network.*** Figure 12.2 [B] illustrates the looped system.

Figure 12.2: Distribution System Basic Layouts



NWRC RWS Volume I, Design Manual

## F. PIPE NETWORK ANALYSIS

Pipe network analysis involves the detailed and careful scrutiny of the fluid flow through a hydraulic network containing several interconnected branches and loops. In the design of a distribution system, a pipe network analysis must be done to determine the flow rates and pressure drops in the individual sections of the network, thus giving basis for selecting pipe diameters.

The basic principles governing network hydraulics are:

- **Conservation of mass** – the fluid mass entering any pipe system will be equal to the mass leaving the system. In network analysis, outflows are lumped in nodes. A related principle is that at each junction (node), the algebraic sum of the quantities of water entering and leaving the node is zero.
- **Conservation of energy** – In any closed path or circuit in a hydraulic network, the algebraic sum of the energy (head losses) in the individual pipes is zero. Another way of stating it is that the difference in energy (head loss) between two nodes in a system must be the same regardless of the path that is taken (Bernoulli principle).

One important tool that a network designer may use is the equivalent pipe method. It is the substitution of a complex system of pipes by a single pipe that will give an equivalent head loss at a given flow.

### 1. Network Analysis by Conventional Method (Hardy Cross)

The most common conventional method (not using computers) that is used in designing hydraulic networks is the Hardy Cross algorithm method. It involves iterative trial and error.

One approach of Hardy Cross is the method of balancing the heads on the nodes by adjusting assumed flows in the pipe elements. Clockwise flows and corresponding head losses are assigned negative signs, and vice versa for positive signs. In the initial trial, initial values of flows in all pipe elements are assumed subject to the second principle above. The corresponding head losses in one closed circuit are calculated using the Hazen Williams formula. The head losses are then added considering their signs. This same head loss calculation and addition are done to each of the other closed loops. The assumed flow values are adjusted and the above procedure is done repeatedly until the summation of the head losses in the closed circuit becomes zero.

Nowadays, manual computation for hydraulic network analysis is only acceptable when applied to systems with only a single pipeline or branched network with no loop. For networks with loops, it is highly recommended to use the more accurate, fast and convenient network modeling computer software, which is discussed in the following section.

## 2. Network Analysis by Computer Software

There are a number of pipe network analysis software (also called network simulation software, or hydraulic network modeling software) which mathematically solve hydraulic equations for all interconnections, branches and loops of the pipe network. With the advent of such powerful software, the conventional methods of water distribution design have been mostly discarded. The computer software requires the designer to create a water supply system model by inputting in the computer program information that includes pipe lengths, junction or node elevations, connectivity of the pipes and nodes, demand in each node, information on pumps, elevations of reservoirs, elevations and yield of sources.

### a. EPANET Software

Among the current software available in the internet and from proprietary sources, the EPANET is highly recommended. **EPANET is public domain software developed by the US Environmental Protection Agency that can be downloaded free on the internet.**<sup>9</sup> The software tracks the flow of water in each pipe, the pressure at each node, and the height of water in each tank.

The important features of EPANET for distribution network design its ability to:

- Handle systems of any size;
- Compute friction head loss using the Hazen-Williams, the Darcy Weisback, or the Chezy-Manning head loss formula;
- Include minor head losses for bends, fittings, etc.;
- Model constant or variable speed pumps;
- Allow storage tanks to have any shape.

The design process using EPANET usually involves the (a) layout of the system configuration including locations of sources and storage facilities, (b) determination of the distribution of demands to the nodes, input of network data, running hydraulic simulation, viewing results in any of the variety of formats, modifying the model by editing the network data, and modifying the model until the design criteria are met or results are acceptable.

A sample systems design using EPANET is presented in Annex B.

### b. Steps in Distribution System Design Using Computer Software

#### 1. Base Mapping:

Detailed maps of the municipality and the barangays concerned should be gathered as basis for pipeline alignment, distance and elevations. The Municipal Planning and

---

<sup>9</sup> To download EPANET, go to <http://www.epanet.com>. The software comes with a tutorial and comprehensive User's Manual.



Development Office, the Engineering Office of the Municipality and the Office of the Mayor are the most likely sources of these maps. Topographical maps of scale 1:50,000 are also available from the National Mapping and Resources Information Authority (NAMRIA).

Another source is the **Google Earth** (<http://earth.google.com>) internet site which makes it possible to view and print aerial images of the area being designed. Aside from the aerial images of houses, streets, rivers and other objects, Google Earth also gives spot elevations.

The information in the maps should be correlated to produce a base map, on which the proposed system layout will be drawn. The designer should conduct an ocular inspection of the whole project area to verify, validate and update the information on the source maps. The resulting base map must include positions and information on roads, streets, rivers, creeks, elevations, topographic contours, locations of built-up areas; it should provide relevant information like big potential consumers, e.g., piggeries and poultry farms. Ideally, the base map should be scaled.

## 2. Water Demand Projection:

The average day demand for the design year will be the basis of the hydraulic network analysis. The demand condition will be varied by adjusting the demand factor; that is 1 for the average day demand condition, 1.3 for the maximum day demand and 2.5 – 3 for the peak-hour demand.

## 3. Tentative Layout:

Using the base map, the designer should next develop a tentative layout of the pipe network, which should also show the positions of the source facilities and reservoir(s).

Pipelines are to be laid on road right of way, and the network should cover the target consumers. Nodes are placed at locations for pipe junctions, street or road junctions and intersections, locations for public faucets, demand centers, and not more than 100 meters from the nearest node. In systems where it is expected that pressure will be generally low or fluctuating, nodes are placed at the highest points of the service area.

## 4. Distribution of Demands:

It is important to plot the barangay or community boundaries and the service area delineation on the base map. Once the tentative layout (with nodes) is plotted on the base map, the service area should be subdivided into node areas. This will give the designer a working idea of the respective number of houses within the area covered by each node.

The projected average day demand for the design year is distributed to all the nodes within its delineated service area. The distribution of demands should take into consideration the relative number of houses for the different node areas.

#### 5. Encoding of Input Data:

Most of the hydraulic analysis software have common input data requirements. These data are grouped into pipe data and node data. Pipe data are the assigned pipe number, pipe diameter (mm), C-value, the pipe nodes, and length (m). Node data are node number, elevation (m), and water demand (lps).

Usually, the values of the design criteria are required by computer software. The design parameters are presented in Section G, PIPELINE DESIGN CRITERIA, below.

#### 6. Hydraulic Network Simulation:

This step is done by the computer software. If all the data required have been inputted by the designer, the software could proceed with its hydraulic run. The software computes the head losses (m) in each pipe, the rate of head loss (m/km) in each pipe, the flow velocities (m/s), and the pressure in each node (m).

The model is run for: (a) its peak-hour demand condition, to check for the possible value of the minimum systems pressure; and (b) its minimum demand condition, to check for the value of the possible maximum pressure in the network.

#### 7. Examination of Hydraulic Run Results:

Usually all possible hydraulic parameters can be shown from the computer run results. Of these parameters, the designer must examine two important results very closely: (a) the low system pressure points that are below the 7 m pressure and the affected nodes, and (b) the pipes that have high head loss per km in excess of the 10 m/1,000 m pipeline criteria.

The designer must also examine the balancing flows of the reservoir and analyze if the reservoir discharge or inflow are reasonable for its storage size.

#### 8. Adjusting Assumed Parameters of the Elements:

Based on the results of the computer simulation, the designer will improve the network model by adjusting the pipe and node data for specific elements, particularly for those that did not meet the design criteria. For example, for pipes that have high resulting head losses, the designer will have to increase the pipe size to the next larger diameter. If there is a system pressure that is below 7 m, the designer could replace some of the pipes leading to the affected node with a larger diameter. The height of the reservoir could be adjusted if needed to achieve a good system pressure.

The adjusted model is run again in the software. After the run, the results are examined and the model readjusted. The above cycle is done until an acceptable hydraulic model is achieved.

#### 9. Finalizing the Network Configuration:

The model is subjected to repeated simulation and data adjustments until an acceptable network configuration is reached.

## G. PIPELINE DESIGN CRITERIA

The distribution pipelines must be designed to handle the peak hour demand of the system:

1. Minimum pressure at the remotest end of the system = 3 m
2. Maximum velocity of flow in pipes
  - a. Transmission Line = 3.0 m/s
  - b. Distribution Line = 1.5 m/s
3. Minimum velocity of flow in pipes = 0.40 m/s
4. Demand Factor: varies from 0.3 (minimum demand) to 3.0 (peak-demand)
5. Allowable head loss: minimum = 0.50 m/1,000 m, maximum = 10 m/1,000 m
6. Allowable pressure: minimum = 3 m, maximum = 70 m

Please refer to Annex C for a listing of Design Criteria and Standards.

## H. PROTECTING THE WATER QUALITY IN THE DISTRIBUTION SYSTEM

Contamination of water supplies should be avoided at all times. In most small water supply systems, however, economic reasons prevent 24-hour daily water service. This creates a risk of polluted water infiltrating into the pipelines through leaks in pipe joints and service taps. To counter the health risk, 0.3 mg/L residual chlorine should be maintained throughout the distribution system.

Other measures to preserve the quality of water are the following:

1. Install water mains using adequate separation from potential sources of contamination such as sewers, storm water pipes, septic tanks, etc.
2. Avoid cross-connections and prevent backflow.
3. Provide at least the minimum allowable pressure and adequate flow at all delivery points in the distribution system.
4. Avoid situations that may give rise to negative pressures.
5. Control the pressure up to the maximum allowable while avoiding pipe breakage.
6. Minimize low-flow dead-ends to avoid stagnant water. Effective circulation of water in the pipelines should be maintained to prevent the deposition of sediments and minimize the growth of bacteria.
7. Install non-return valves on source facilities to prevent backflow that might cause contamination.
8. Promptly repair leaks in pipes to keep dirty water from coming in when pressure in the pipe is reduced.

- Cover reservoirs to prevent contamination. Ensure that all hatches and structures of the reservoir are secured and vermin-proof.

## I. PIPELINE MATERIALS SELECTION

### 1. Factors in Selecting Pipeline Materials

- **Flow Characteristics:** The friction head loss is dependent on the flow characteristics of pipes. Friction loss is a power loss and thus may affect the operating costs of the system if a pump is used.
- **Pipe Strength:** Select the pipe with a working pressure and bursting pressure rating adequate to meet the operating conditions of the system. Standard water pipes are satisfactory usually only in low pressure water supply systems.
- **Durability:** Select the type of pipe with good life expectancy given the operating conditions and the soil conditions of the system. It should have an expected life of 30 years or more.
- **Type of Soil:** Select the type of pipe that is suited to the type of soil in the area under consideration. For instance, acidic soil can easily corrode G.I. pipes and very rocky soil can damage plastic pipes unless they are properly bedded in sand or other type of material.
- **Availability:** Select locally manufactured and/or fabricated pipes whenever available.
- **Cost of Pipes:** Aside from the initial cost of pipes, the cost of installation should be considered. This is affected by the type of joint (such as screwed, solvent weld, slip joint, etc.), weight of pipe (for ease of handling), depth of bury required, and width of trench and depth of cover required.

### 2. Pipe Materials

- Galvanized Iron (GI) Pipes:** GI pipes are available in sizes of 13, 19, 25, 31, 38, 50, 63 and 75 mm and in lengths of 6 m. They are joined by means of threaded couplings.

#### **Advantages:**

- Strong against internal and external pressure.
- Can be laid below or above ground.
- People in rural areas know how to install this kind of pipes.

#### **Disadvantages:**

- GI Pipes can easily be corroded, thus the service life is short.
- These have rougher internal surface compared to plastic pipes, hence, have higher friction head losses.

**b. Plastic Pipes:** Polyvinyl Chloride (PVC) and Polyethylene (PE) are commercial plastic pipes. They are available in different pressure ratings and sizes of 13, 19, 25, 31, 38, 50, 63, 75, 100 up to 200 mm. PVC is supplied in lengths of 3 m and 6 m while PE is available in rolls and, for diameters greater than 100 mm, in straight lengths. Suppliers have to be consulted with respect to the pressure ratings to be used. PE pipes are joined by butt welding. PVC pipes can be joined either through solvent cement welding or through the use of special sockets with rubber rings.

**Advantages:**

- Smooth internal surface.
- Resistant to corrosion.
- Extremely light and easy to handle.
- Do not tuberculate

**Disadvantages:**

- Lose strength at high temperatures (500° C+).
- Not suitable for laying above the ground.
- Can deform during storage.
- Require good and carefully prepared bedding materials.

Table 12.2: Characteristics of Different Pipe Materials			
Parameters	GI	PVC	PE
Crushing strength versus superimposed loads in trench	Excellent	Fair	Poor
Burst strength versus internal pressure	Excellent	Good	Good
Durability	Fair	Excellent	Excellent
Resistance to corrosion	Poor	Excellent	Excellent
Flow capacity	Fair	Excellent	Excellent
Resistance to external mechanical injury	Excellent	Fair	Fair
Ease of installation	Easy	Must be handled gently. Must be buried	
Pipe Cost	High	Low	Low
Cost per fitting	Low	High	High
Number of fittings	High	High	High

*NWRC RWS Volume I, Design Manual*

## J. APPURTENANCES FOR TRANSMISSION AND DISTRIBUTION MAINS

### 1. Valves

One of the most important types of appurtenances is the valve. A valve is a device that can be opened and closed to different extents (called throttling) to vary its resistance to flow, thereby controlling the movement of water through a pipeline. Valves can be classified into five general categories as follows:

1. **Isolation Valves** – Perhaps the most common valve in the water distribution system is the isolation valve, which can be manually closed to block the flow of water. As the term “isolation” implies, the primary purpose of these valves is to provide means of turning off a portion of the system. Well-designed water distribution systems have isolation valves throughout the network. Isolation valves include gate valves (the most popular type), butterfly valves, globe valves, and plug valves.
2. **Directional Valves** – Directional valves, also called check valves, are used to ensure that water can flow only in one direction through a pipeline, Any water flowing backwards through the valve causes it to close, and it remains closed until the flow once again begins to go through the valve in the forward direction.
3. **Altitude Valves** – Many water utilities employ devices called altitude valves at the point where a pipeline enters a tank. When tank level rises to a specified upper limit, the valve closes to prevent any further flow from entering, thus eliminating overflow. When the flow trend reverses, the valve reopens and allows the tank to drain or to supply the usage demands of the system.
4. **Air Release Valves and Vacuum Breaking Valves** – Most systems include special air release valves to release trapped air during system operation, and air/vacuum valves that discharge air upon system start-up and admit air into the system in response to negative gauge pressures. These valves are often found in system high points, where trapped air settles, and at changes in grade, where pressures are most likely to drop below ambient or atmospheric conditions.
5. **Pressure Reducing Valves** – Pressure reducing valves (PRVs) throttle automatically to prevent the downstream hydraulic grade from exceeding a set value, and are used in situations where high downstream pressures could cause damage. It can be used to separate pressure zones.

## 2. Fittings

Fittings are installed in the pipelines for the following purposes:

**a. To connect the same type and size of pipe:**

- **Union:** Unions are provided in the pipeline for ease of repair. Unions are usually installed at 60-meter intervals on straight pipelines.
- **Coupling:** Used in jointing 2 pipes of the same diameter. It is cheaper than unions.

**b. To connect two pipes of different sizes:**

- **Reducers** are used when there is a reduction of pipe size and include bushings and elbows for galvanized iron pipes. Also available are reducing elbows, tees and crosses.

**c. To change the direction of flow:**

- **Elbow:** To change flow direction.
- **Tee:** To divide the flow into two.
- **Cross:** To divide the flow into three.

**d. To stop the flow:**

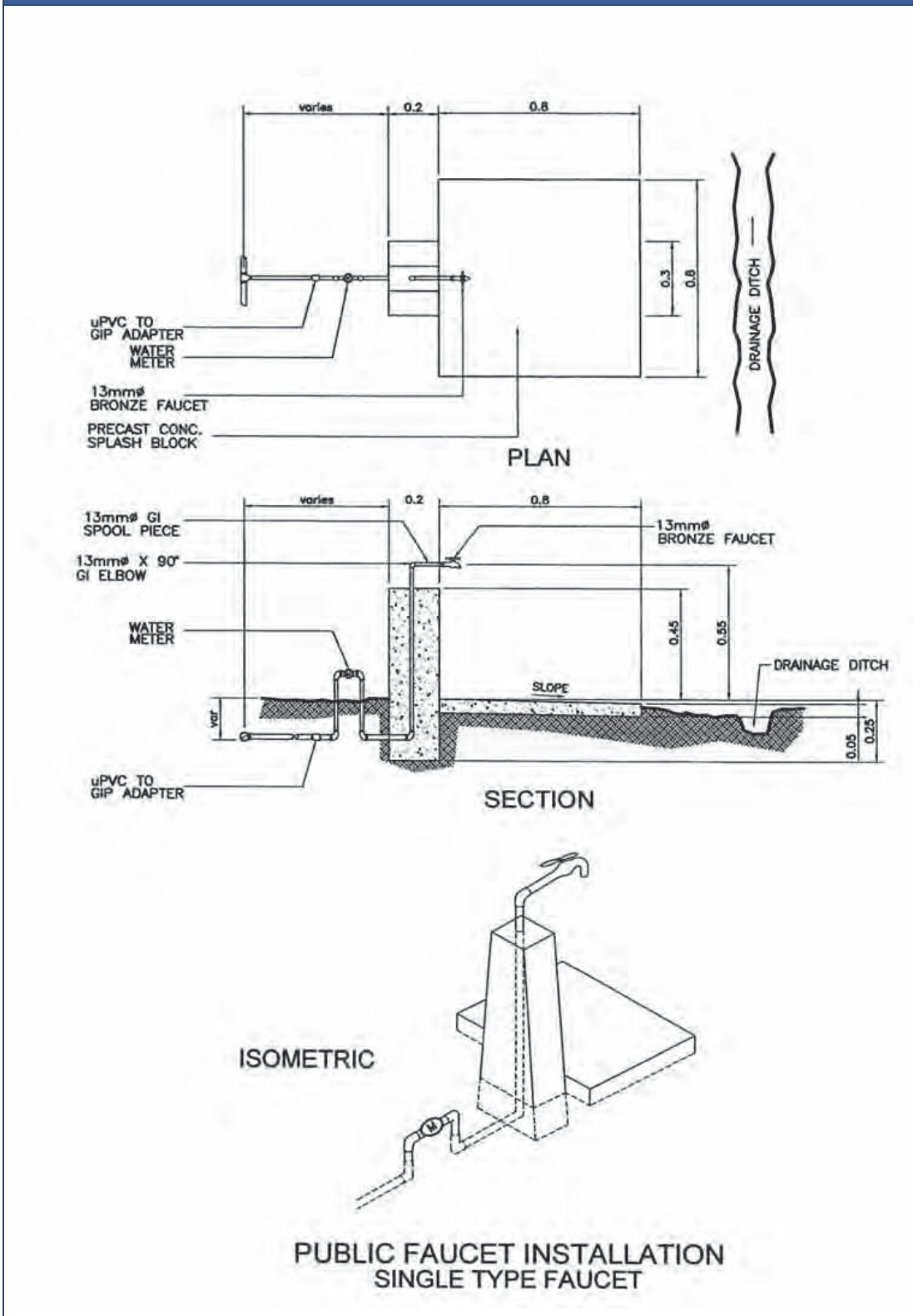
- These are the **caps, plugs and blind flanges**.

## K. PUBLIC FAUCETS/SERVICE CONNECTIONS

The design of taps should consider solutions for drainage in order to minimize the potential impacts on increased flooding, hygienic problems and mosquito breeding associated with stagnant/waste water

Figure 12.3, Figure 12.4 and Figure 12.5 give illustrated details of public faucets and service connections.

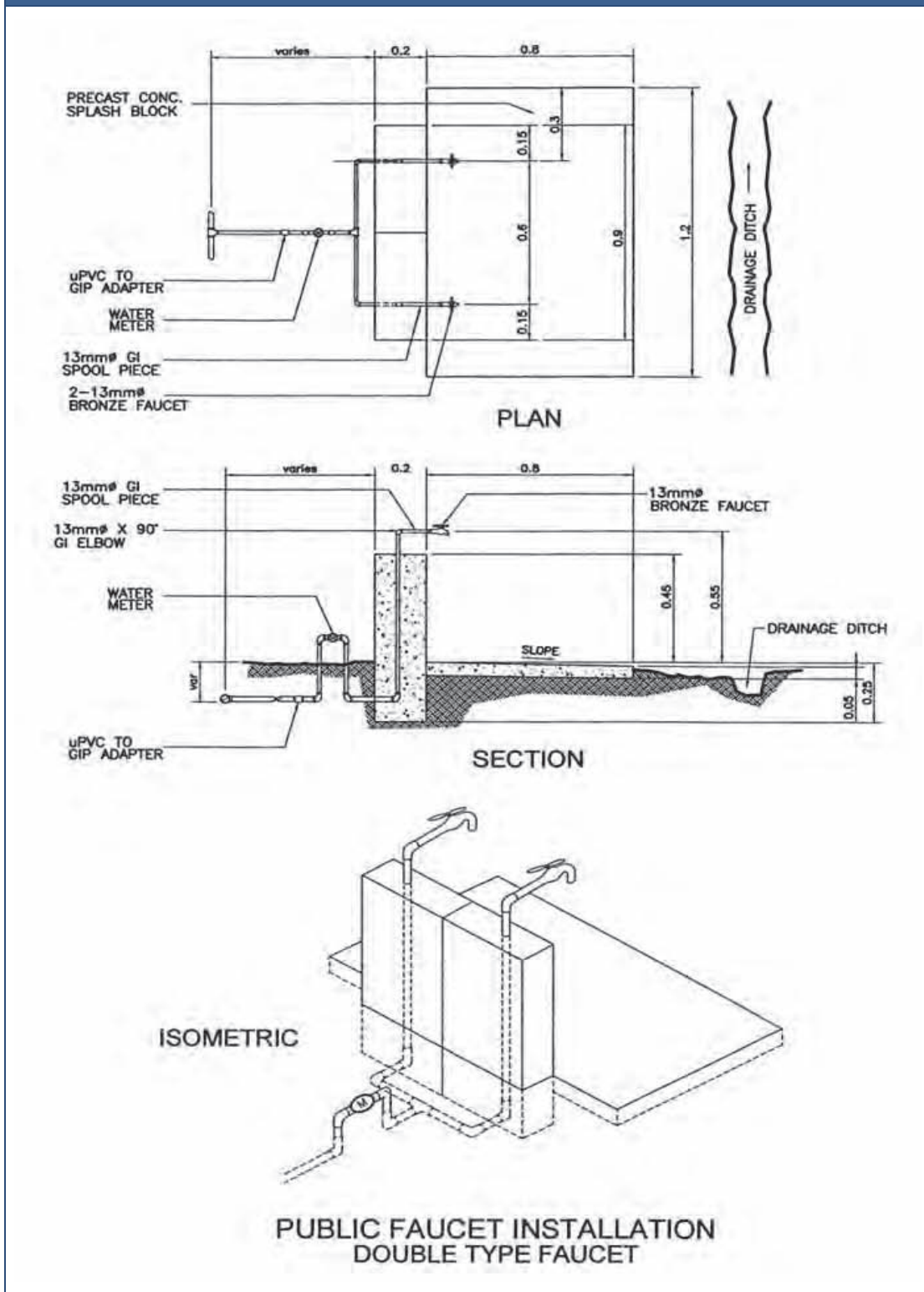
Figure 12.3: Typical Detail of a Single Public Faucet



DAR/ARISP – Implementing Manual-Potable Water Supply Development Component

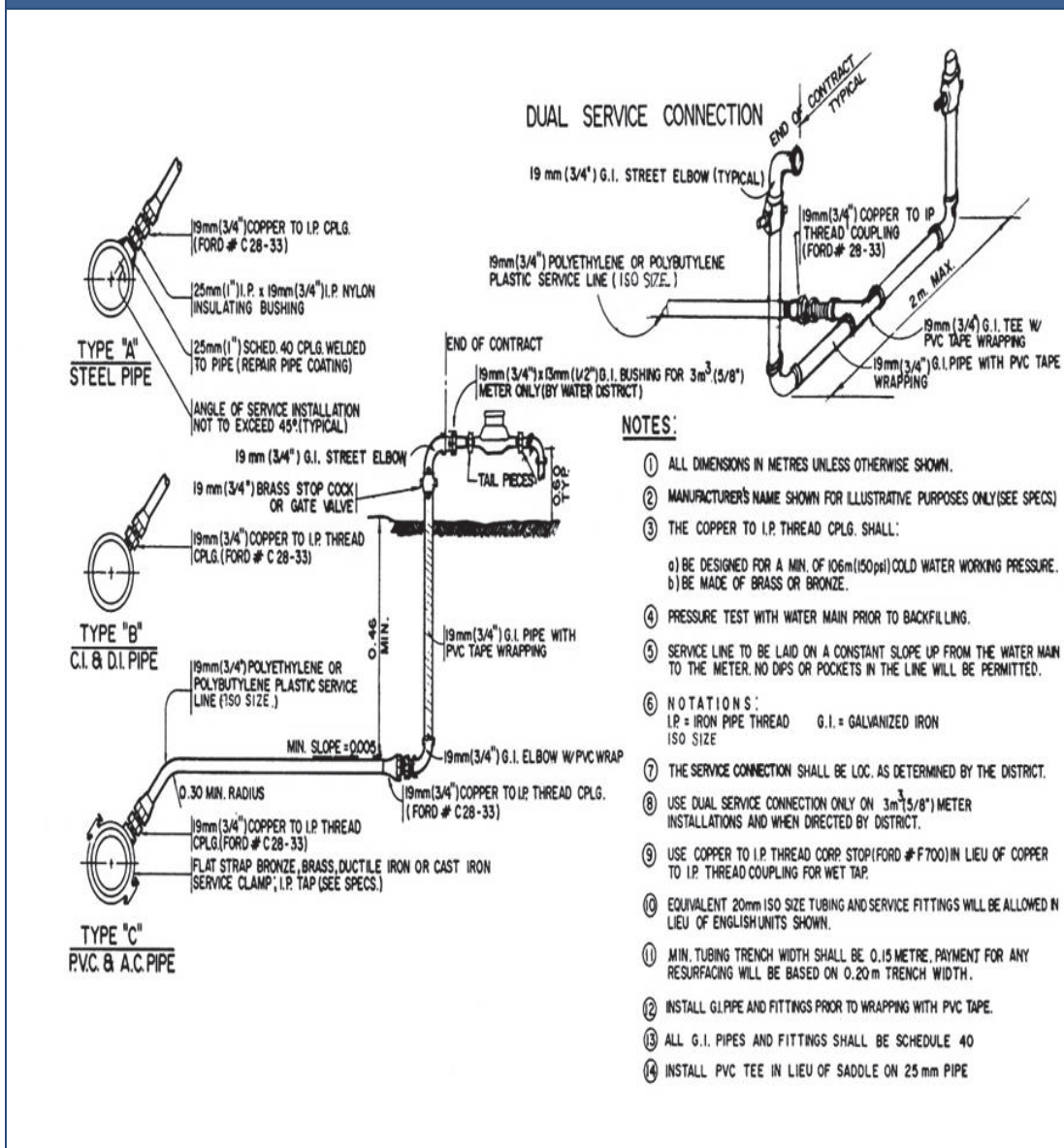


Figure 12.4: Typical Detail of a Double Public Faucet



DAR/ARISP – Implementing Manual-Potable Water Supply Development Component

Figure 12.5: Details of Service Connections



LWUA Inspector's Construction Manual

# Chapter 13

## Reservoirs

This Chapter discusses the factors that must be taken into account in the design of reservoirs and illustrates the basic design of a distribution reservoir.

### A. INTRODUCTION

#### 1. Importance of Distribution Reservoirs

In small town distribution systems, whether water is obtained by gravity or by pumping, distribution reservoirs are usually necessary for the following reasons:

- To balance the supply and demand in the system. In small distribution systems, variations in demand may be three or more times the average hourly consumption.
- To maintain adequate and fairly uniform pressure throughout the distribution system.
- To avoid the total interruption of water service when repairing pipes between the source of supply and the reservoir.
- To allow pumps to be operated uniformly throughout the day. Such pumps may be much smaller than would otherwise be required.

#### 2. Terminologies:

- **Minimum Water Level** – the lowest water level in the tank sufficient to give the minimum residual pressure at the remotest end of the system.
- **Maximum Water Level** – is the highest water level in the tank.
- **Working Pressure** – the minimum pressure at which the system will operate.
- **Safe Working Pressure** – the working pressure multiplied by a factor of safety.

### B. TYPES OF RESERVOIRS

Reservoirs may be classified according to their function, their relative position with respect to the earth's surface, manner of operation, and the type of material of construction.

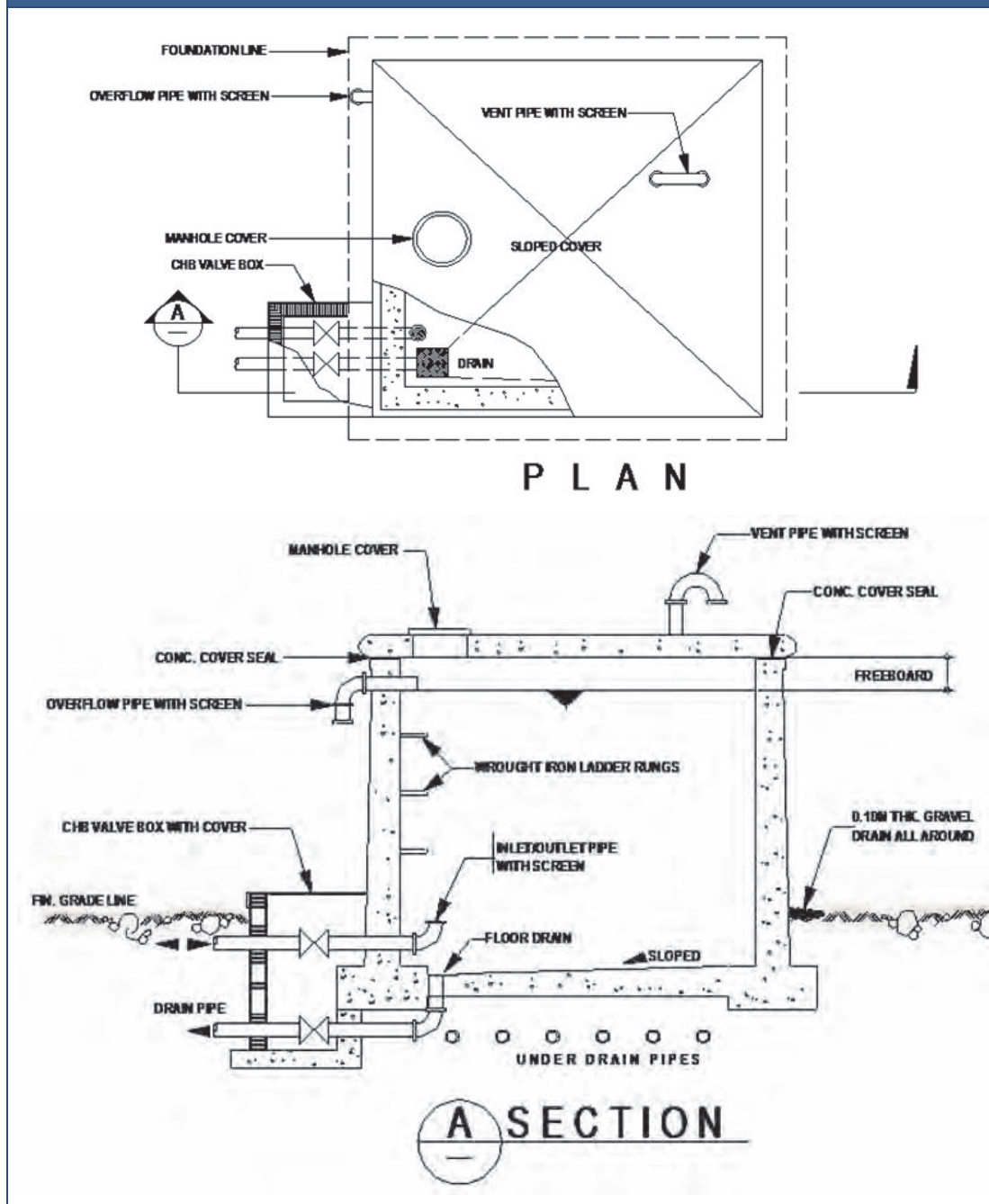
#### 1. Elevated Reservoirs

Reservoirs are constructed in elevated or hilly areas. In case of flat areas, a supporting frame or tower is installed to support the storage tank. This is known as an elevated reservoir. Standpipes are reservoirs with height greater than their diameter.

## 2. Ground Level Reservoirs

Ground level reservoirs may be made of reinforced concrete pipe, fiber glass, concrete hollow blocks, steel or ferro-cement. These may be single ground level tanks (Figure 13.1) or multiple type tanks.

Figure 13.1: Ground Level Concrete Reservoir

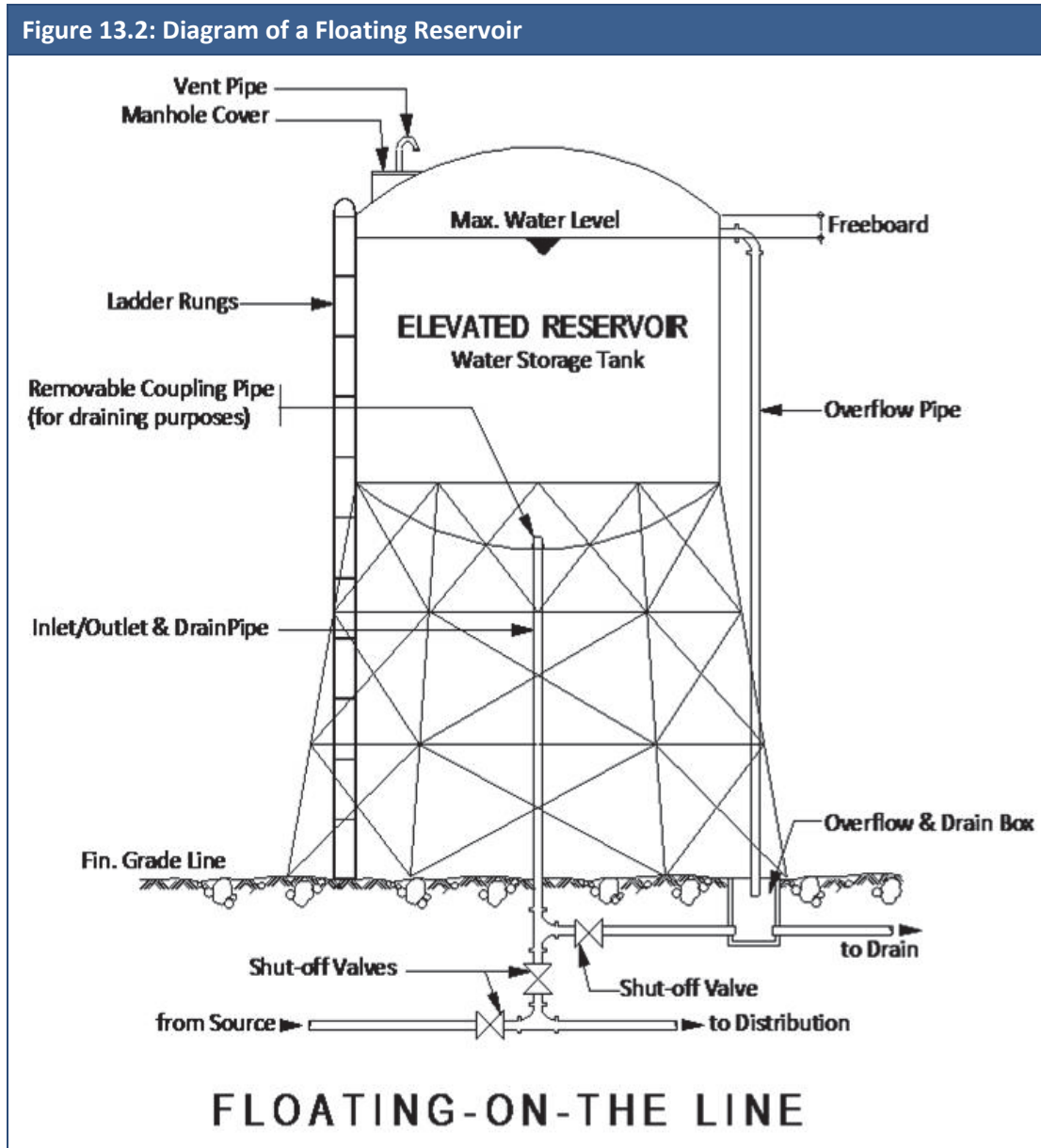


NWRC RWS Volume I, Design Manual

### 3. Operation of Reservoirs

Reservoirs may be operated on the following basis:

1. **Floating-on-the-Line Reservoir:** Water is pumped both into the reservoir and to the consumers; water goes up the tank when the water demand is low or if there is a residual water supply. During peak demand, water goes to the customers directly from the source and from the tank. This system requires fairly continuous pumping at low pumping capacity. (See Figure 13.2)

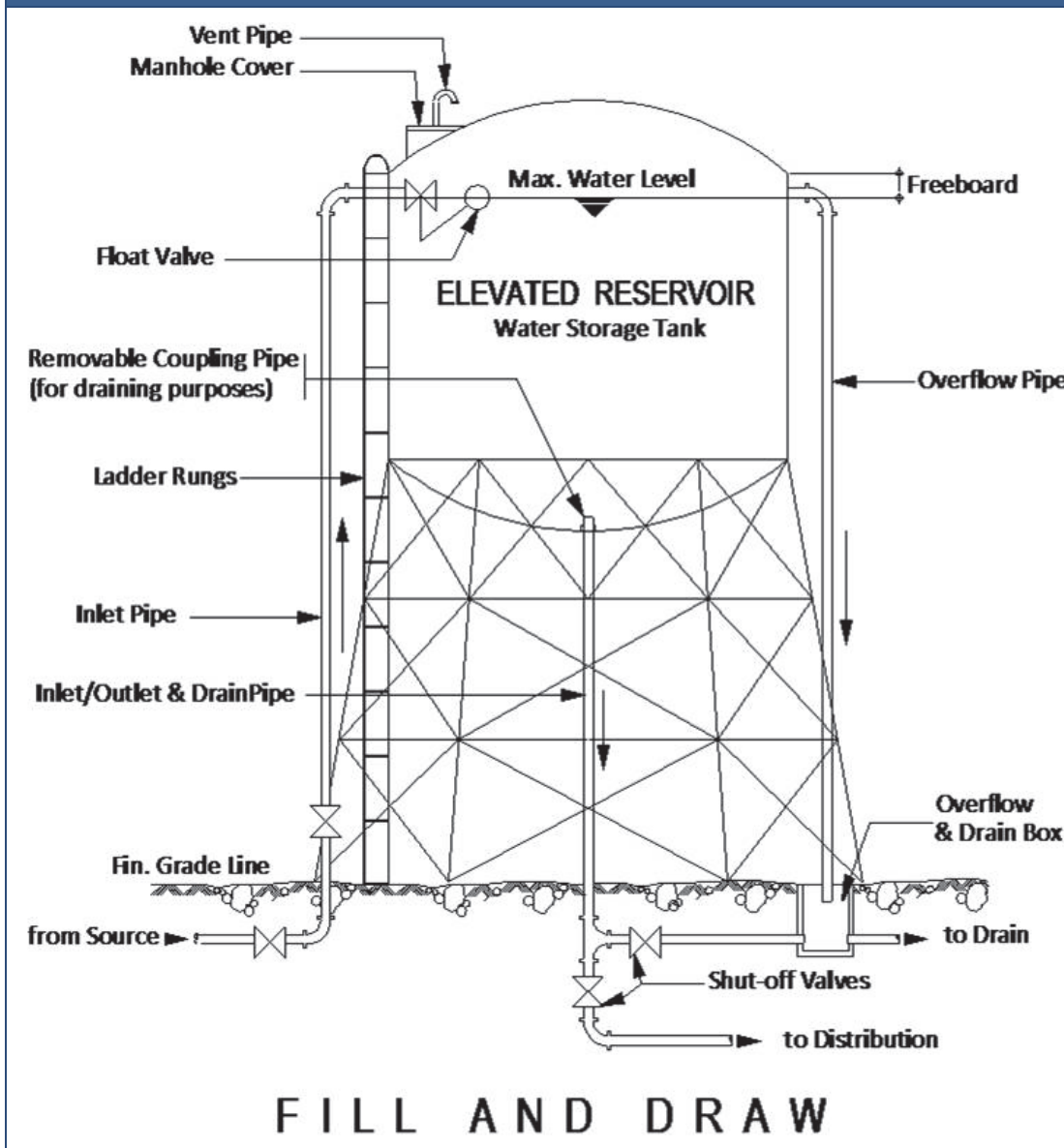


NWRC RWS Volume I, Design Manual



2. **Fill-And-Draw Reservoir:** Water flows or is pumped directly into the reservoir and from the reservoir, water supply is distributed to the consumers through gravity flow. The tank is usually installed near the water source to minimize head losses due to friction losses. In the fill-and-draw system, however, water is conveyed to the storage tank at high pumping capacity at shorter time duration, and always against the maximum head. (Refer to Figure 13.3)

Figure 13.3: Diagram of a Draw and Fill Reservoir



NWRC RWS Volume I, Design Manual

## C. DESIGN OF RESERVOIRS

### 1. Capacity:

As a rule of thumb, the storage tank volume should be at least equal to one-fourth (25%) of average day demand of the community. The formula is:

$$Cr = (1/4)(ADD)$$

Where:

*Cr* = reservoir capacity in liters

*ADD* = average day demand in liters per day

### 2. Site of the Storage Tank

In the selection of the site for storage tanks, first priority should be given to natural elevated places. If the elevated storage tank is to be constructed in a flat area, it may be built central to the distribution system or opposite the source. This is to avoid long and consequently large- diameter service mains.

### 3. Structural Design

The structural design of reservoirs must meet the standards set by the National Structural Code of the Philippines. The reservoirs must be strong enough to withstand all loads, such as hydrostatic pressure, earth pressure, wind loads, seismic loads and other dead or live loads. The reservoir should be covered to avoid pollution and growth of algae.

## D. RESERVOIR APPURTENANCES

### 1. Inlet Line

The size of the inlet line is determined by the supply and demand requirements. The inlet line on all reservoirs must have a shut-off valve located adjacent to the reservoir.

### 2. Outlet or Discharge Line

Like the inlet line, the size of the outlet line is determined by the supply and demand requirements. The upstream-end of the outlet pipe is usually installed at least 5 cm, above the floor of the reservoir to create a dead volume of water. This dead volume of water at the bottom of the reservoir acts as settling zone, where particles are allowed to settle and kept from entering the water distribution line. These dead volumes of water are drained via a drainage pipe. The outlet line must also have a shut-off valve located adjacent to the reservoir.

In floating-on-the-line reservoirs, there is only one inlet and outlet line.

### **3. Drain Line**

This is provided for draining and cleaning the reservoir. Draining could be done through the inlet–outlet line by shutting off the valve controlling the flow in the main line and opening the drain valve. To facilitate cleaning, the floor of the reservoir is sloped towards the drain.

### **4. Ventilation facilities**

These are provided in reservoirs to allow the air to escape fast enough to prevent pressure from building up inside the reservoir during filling, and to prevent a vacuum from forming when water is being drawn out. The ventilation facilities should be designed to keep rain and surface water from entering, and they should be screened to keep out insects. Overflow and drainage pipes should be designed with a valve chamber to prevent rodents from entering the reservoir.

### **5. Overflow Line**

Reservoirs should be provided with an overflow line large enough to allow the maximum anticipated overflow (pump or spring capacity) and should be properly screened and covered like an air vent.

### **6. Manholes and Covers**

These are installed in reservoirs to serve as entrance during repair, cleaning and maintenance. To prevent the entry of surface water which may contain pollutants, manholes should be installed slightly raised above the roof level and must be equipped with an overlaying cover. The cover is also necessary to prevent the sun's rays from promoting algae growth.

### **7. Water Level Indicators**

These are used to indicate the water level inside the reservoir. Depth gauges using a float and wires are usually used.

### **8. Control Valves:**

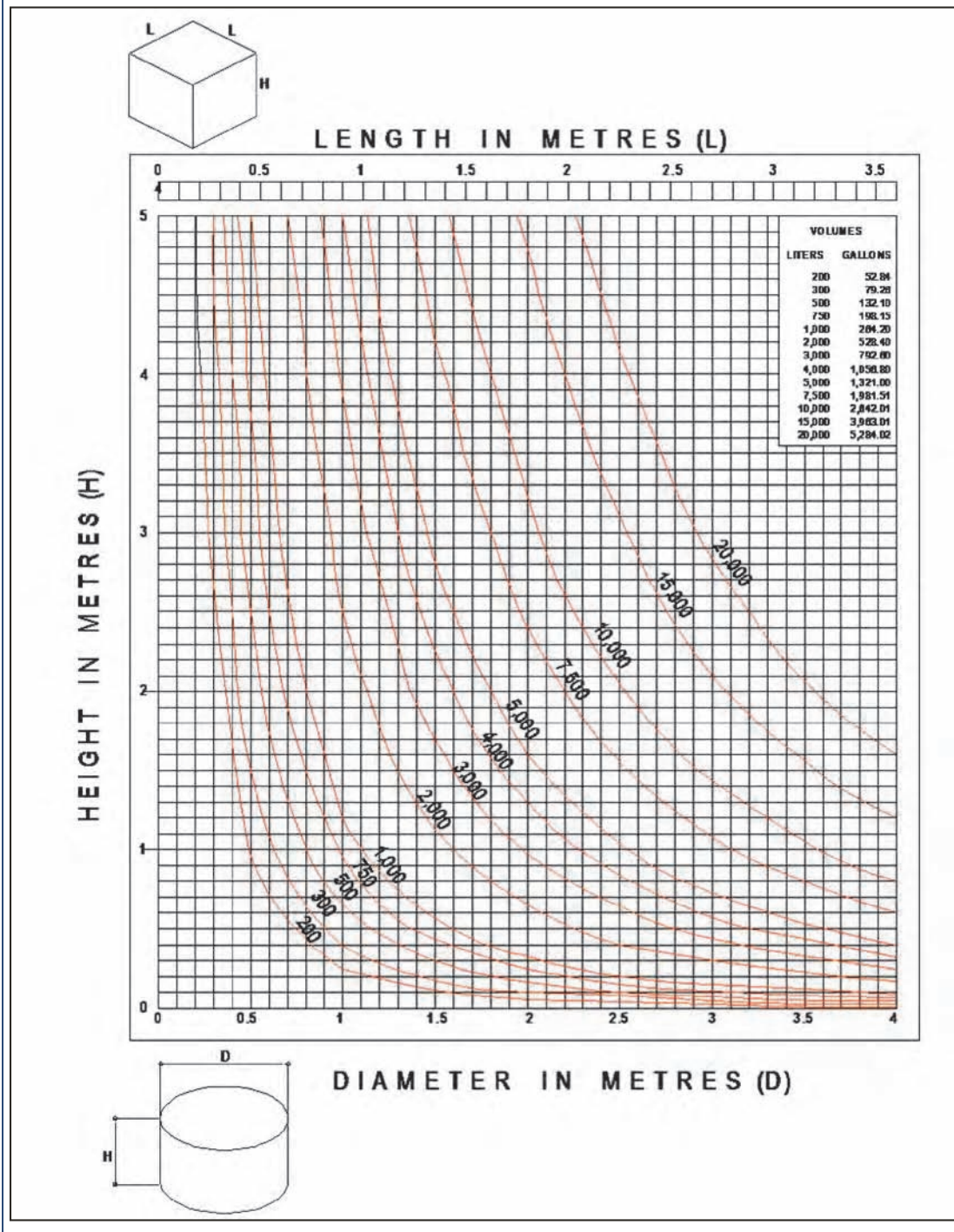
The use of reservoir control valves will depend on the type of controls and means of operation to be employed for the system. The flow into the reservoir may be stopped manually or automatically by a float valve, pressure switch or equivalent device.

## **E. SAMPLES OF RESERVOIR DESIGN**

Figure 13.4 provides a quick method of determining prismatic tank dimensions.



Figure 13.4: Prismatic Tank Volume



NWRC RWS Volume I, Design Manual

### Example 13.1: Design Example of Tanks

#### Given Data:

Minimum Pressure at the remotest public faucet (PF) = 3 m

Average Day Demand (ADD) = 43,440 lpd

Friction head loss from tank to remotest PF = 3 m

#### Required:

Using an elevated tank, calculate the capacity and height of the required minimum water level.

#### Analysis:

Using Elevated Tank,

Calculate the Reservoir Capacity

$$\text{Capacity} = \frac{1}{4} \times 43,440 = 10,860 \text{ liters, say } 11,000 \text{ liters}$$

If Shape of Reservoir = Cylindrical

Assumed Height = 3 m

From Figure 13.4, Diameter = 2 m\*

- \* The diameter was determined using Figure 13.4. Locate the height = 3 m in the figure and move horizontally to intersect  $V = 11,000$  and then move down on the abscissa to find the diameter,  $D = 2.09$  m. Use  $D = 2.0$  m

Calculate the Height of Minimum Water Level, H

$H$  = Minimum Pressure at the remotest PF + Friction Head Loss in pipeline from tank to remotest PF,  $H = 3 + 3 = 6$  m

### Example 13.2: Design a Reservoir (PART I: DATA)

#### Data:

Design Population : 600

Average Day Demand:  $600 \times 80 \text{ lpcd (level II/III)} = 48,000 \text{ LPD}$

PF1, found at the remotest of the system

Friction Head Loss in Pipeline:  $F1 = 4 \text{ m}$

Elevation of PF:  $E1 = 2 \text{ m}$

PF2, found 40 m from the storage tank

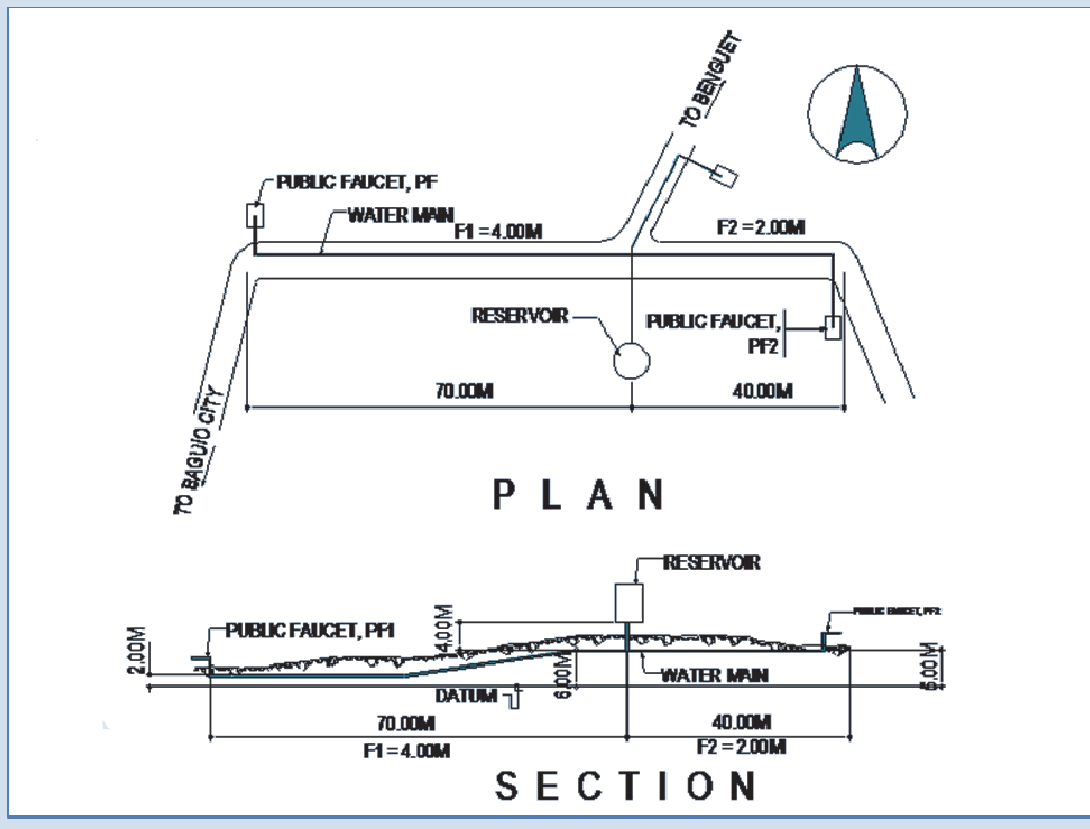
Friction Head Loss in Pipeline:  $F2 = 2 \text{ m}$

Elevation of PF:  $E2 = 5 \text{ m}$

Elevation of the location of Storage Tank:  $E3 = 6 \text{ m}$

#### Required:

Using an elevated tank, calculate tank capacity and height of the minimum water level.



### Example 13.3: Design a Reservoir (PART II: ANALYSIS)

#### Analysis Using an Elevated Tank

Minimum pressure in system = 3 m

1. Design Capacity of Tank  $V = 1/4$  of Average Day Demand

2. Calculate the Tank Capacity

$$\text{Capacity} = \frac{1}{4} \times 48,000 = 12,000 \text{ liters}$$

Assume height = 2.5 m and square top and bottom

$$L = W = 2.2 \text{ m using the formula } V = H \times L \times W$$

3. Calculate the Height of Minimum Water Level, H

**Case A:** Use the remotest PF1 as the basis in the computation of H1.

Find the sum of the Minimum Pressure, Friction headloss and Elevation:

Minimum Pressure	3 m
Friction Headloss, F1	4 m
Elevation of PF1, E1	2 m
<b>P1, pressure to be supplied by tank</b>	<b>9 m</b>

**Case B:** Use the remotest PF2 located 40 m from the Storage Tank as the basis in the computation of H2.

Find the sum of the Minimum Pressure, Friction headloss and elevation:

Minimum Pressure	3 m
Friction Headloss, F2	2 m
Elevation of PF2, E2	5 m
<b>P2, pressure to be supplied by tank</b>	<b>10 m</b>

$$\mathbf{P2 (10 m) > P1 (9 m)}$$

**Conclusion:** Select P2 = 10 m, in the computation of Height, H of Tank.

**Rationale:** Using H1 as the basis will result in no water or the minimum pressure in the system of 3 m will not be attained in PF2 as the pressure requirement in PF1, is less than in PF2.

Calculate the Height of the Minimum Water Level of Storage Tank

The height of the minimum water level of storage tank is equal to the difference of P2 and the ground elevation of the location of tank, E3.

$$\begin{aligned} H &= P2 - E2 = 10 - 6 \\ &= \mathbf{4 m} \end{aligned}$$

# Chapter 14

## Pumping Facilities

This Chapter describes the mechanics of pumps, the types available, how to select and design pumps for a water system, and key considerations in their installation and operation.

### A. INTRODUCTION

Pumps are devices used to transferring water (or other liquids) from point A to point B with pressure to overcome the resistance along its path. It is important to understand the different types of pumps, their applications, design differences and the procedures used to operate and maintain them.

#### 1. Hydraulic Theory

All pumps use basic forces of nature to move a liquid. As the moving pump part begins to move, air is pushed out of the way. The movement of air creates a partial vacuum (low pressure) which can be filled up by more air, or in the case of water pumps, water. This is similar to sucking on a straw. A partial vacuum is created in your mouth when you suck on the straw. The liquid is pushed up the straw because of the pressure differences between your mouth and the atmosphere.

#### 2. Atmospheric Pressure

At sea level, nature exerts a pressure of 1 bar (14.7 psi) all around us. If one end of a tube is placed in water and a perfect vacuum is applied to the other end, that 1 bar could hold a column of water 10.3 m (33.9 feet) high. This is only obtainable at sea level and with a perfect vacuum.

However, centrifugal pumps can lift water no more than 7.9 m (26 feet) at sea level. This drops off approximately 0.6 m (2 feet) for each 305 m (1000 feet) of altitude above sea level.

#### 3. Pressure Differences

In nature, movement is from more dense to less dense. A liquid under high pressure will move to an area of less pressure if a path is provided.

#### 4. Centrifugal Force

A centrifugal pump works in the same way as sucking on a straw. Rotation of the impeller forces the water around it out of the pump's discharge port. The partial vacuum created, allows the natural air pressure to force water up the suction hose (straw), and into the suction (inlet) side of the pump to replace the displaced water.

When the water hits the rotating impeller, energy of the impeller is transferred to the water, forcing the water out (centrifugal force). The water is displaced outward, and more water can now enter the suction side of the pump to replace the displaced water.

## **B. CONSIDERATIONS IN PUMP SELECTION**

### **1. Total Dynamic Head**

In order to accurately predict the performance of a pump in a specific application, the total head losses must be considered. These losses include, but are not limited to:

- Total static head;
- Losses due to pipe size, length, and material;
- Losses due to pipe appurtenances.

Accurately predicting the discharge and pressure for a given pump in a specific application requires tedious calculations as well as patient trial and error.

### **2. Friction Losses in Conduits**

When water moves through a closed conduit, the flow creates heat due to the friction of the two surfaces (water against conduit). A steel pipe will produce more friction than will any plastic pipe. Friction increases with the increased length of pipe or hose, and also with a decreased diameter of pipe or hose. Increased friction slows down the water, effectively decreasing the discharge capacity and actual discharge of a given pipe.

### **3. Suction Head**

Atmospheric pressure at sea level limits the suction head of centrifugal pumps to 10.3 m (33.9 feet). However, this head would only be obtained if a perfect vacuum could be created in the pump. In reality, the suction head of centrifugal pumps is limited to about 7.9 m (26 feet). Pump performance (capacity or pressure) is highest when the pump is operated close to the water's surface.

Increasing the suction head will decrease the discharge head and consequently the discharge capacity of the pump. Very importantly, suction head should be kept to the smallest value possible to reduce the likelihood of cavitation<sup>10</sup>. Cavitation can also occur if the suction pipe is restricted. A suction hose with a smaller diameter than the suction port should not be used as cavitation can quickly damage a pump.

### **4. Discharge Head**

As the pump discharge head increases in height, the pump capacity decreases and the available pressure at the end of the discharge pipe also decreases. At maximum head,

---

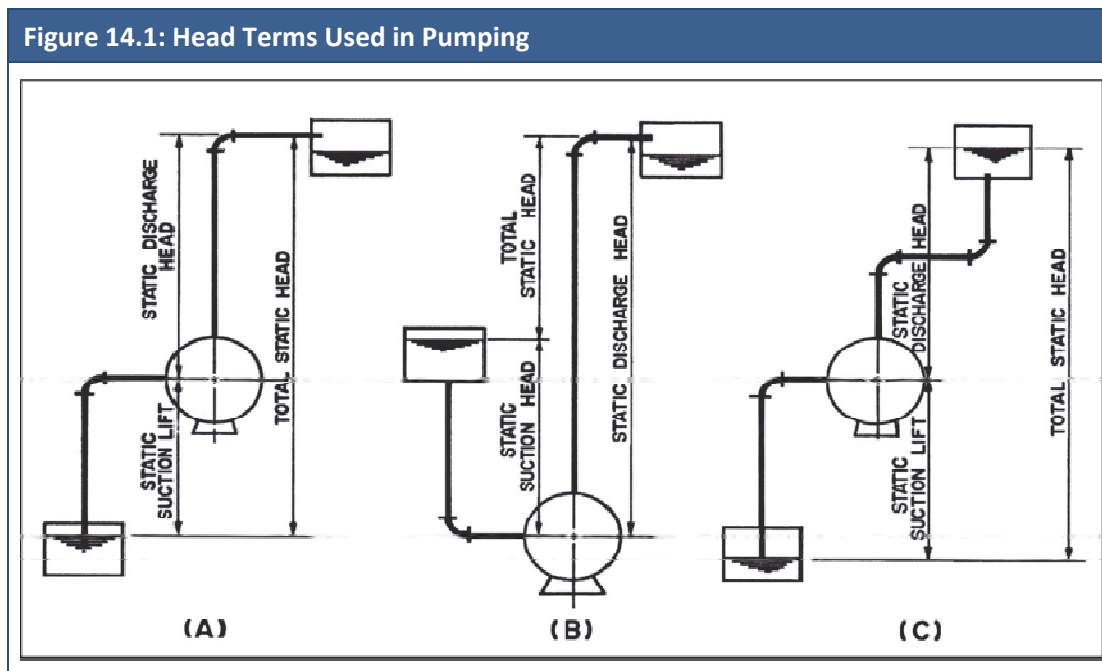
<sup>10</sup> Cavitation means that cavities or bubbles form in the liquid being pumped which leads to loss of pump efficiency.

the capacity of a pump drops to zero and no pressure is available at the end of the discharge line. The pump performance curves show the relationship between discharge capacity and total head.

## 5. Pipe Restrictions

When water hits any restriction (valve or a reducer), only a partial amount of the flowing water is be allowed to pass through. Restrictions increase the friction and decrease the discharge capacity at the end of the pipe.

## C. TERMINOLOGY AND DEFINITIONS



*NWRC RWS Volume I, Design Manual*

1. **Total Dynamic Head (TDH)** – the TDH is the sum of static head, pipe friction and velocity head at the point of discharge.
2. **Static Head** – The difference in elevation between suction level and discharge level. Refer to Figure 14.1.
3. **Pipe Friction** – Head loss due to friction of the water as it moves along the pipes, fittings, elbows, valves and suction entrance.
4. **Velocity Head** – Changes in kinetic energy of water from source to discharge point. Velocity head is calculated as the square of the velocity divided by twice the acceleration of gravity.

$$H_v = v^2/2g$$

Where:

$$\begin{aligned}H_v &= \text{velocity head, meters} \\v &= \text{velocity of water, meters/second} \\g &= 9.8 \text{ meters/sec}^2\end{aligned}$$

5. **Water Horsepower (Output Horsepower)** – is the energy transferred by a pump to the water.

$$WHP = Q \times TDH / 75$$

Where:

$$\begin{aligned}Q &= \text{Pump Discharge, LPS} \\TDH &= \text{Total Dynamic Head, m}\end{aligned}$$

6. **Brake Horsepower (BHP or Input Horsepower)** – is the energy transferred to the prime mover of a pump. The BHP will always be larger than the WHP due to losses caused by friction, impeller slippages, etc. BHP is expressed as:

$$BHP = \frac{Q \times TDH}{75 \times e} = \frac{WHP}{e}$$

Where:

$$\begin{aligned}Q &= \text{Pump Discharge, LPS} \\TDH &= \text{Total Dynamic Head, m} \\e &= \text{Pump Efficiency}\end{aligned}$$

## D. TYPES OF PUMPS

There are three general types of water pumps in the water industry. While different in design and application, they each basically serve the same purpose, which is to move water from point A to point B. These are the centrifugal, positive displacement and special pumps. The third type (special pumps) will not be taken up in this Manual as their use in rural and other small water supply systems is not common.

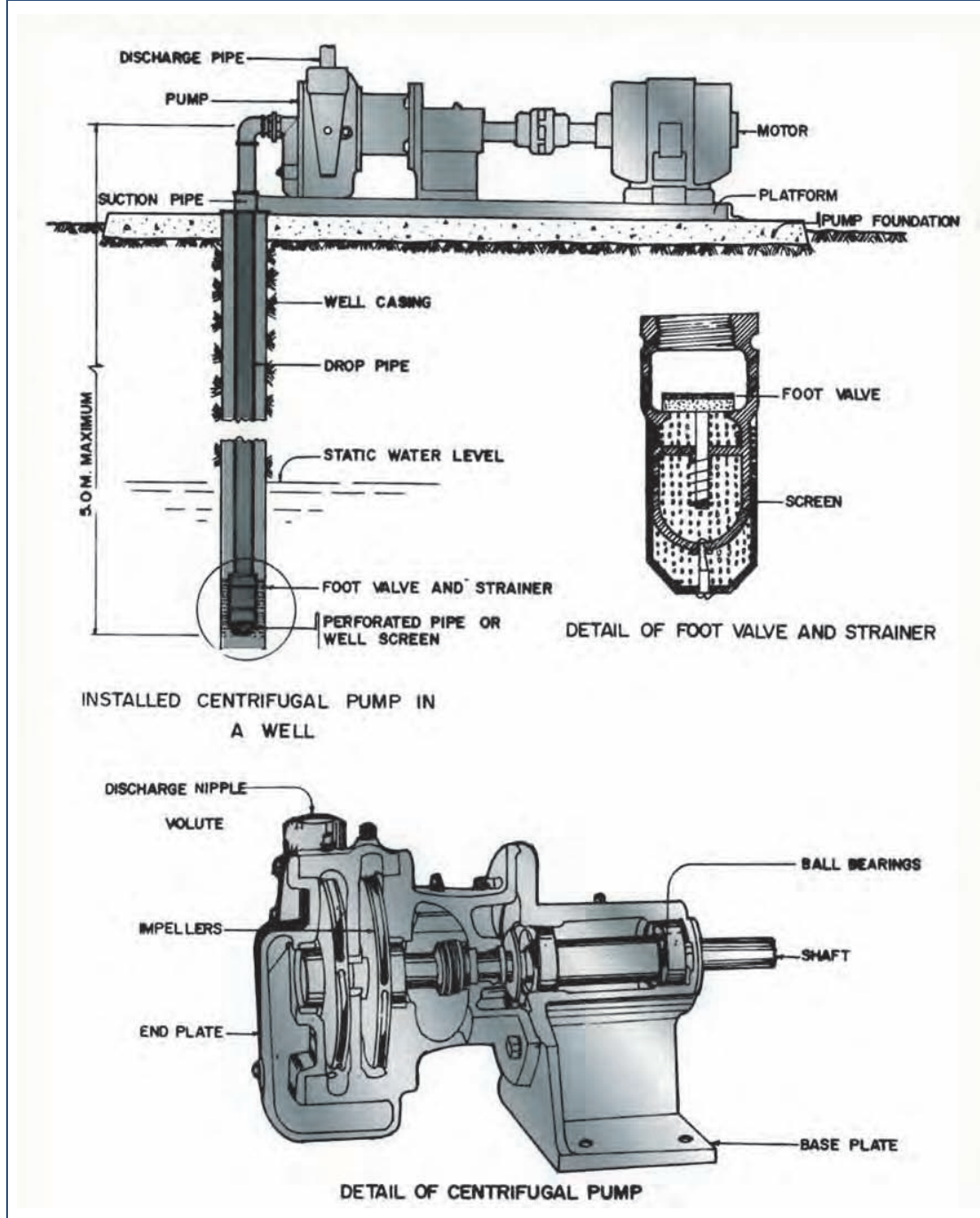
### 1. Centrifugal Pump Designs

#### a. Centrifugal Pumps

Centrifugal pumps (Figure 14.2) raise liquids by centrifugal forces created by a wheel called an impeller, rotating within a pump case. Water enters at the center of the impeller and as the impeller rotates, water in the pump is forced out by centrifugal force. This causes a vacuum condition at the center of the impeller which provides the necessary force to move or lift the water. Water is continuously drawn toward the vacuum and at the same time is being discharged by the centrifugal force of the impeller, thereby producing a smooth and continuous flow of water.



Figure 14.2: Centrifugal Pump



NWRC RWS Volume I, Design Manual

### **b. Turbine Pumps**

The turbine pump motor is usually placed above the water level, but submersible types are available depending on the design requirement.

Generally, turbine pumps have a constant head, and water flows uniformly at high pressure. The stages can be connected in series to increase the head capacity of the turbine pump. Two common types of turbine pump are submersible turbine pumps and deep well turbine pumps, which are also known as vertical turbine pumps. These pumps consist of open or semi-open impellers. The impellers must be periodically adjusted for the pump to maintain proper function.

Vertical turbine pumps are mainly used in those wells where the water surface fluctuates regularly. These pumps can run on both internal combustion power and electric power. Installation and repair of these pumps are more difficult and expensive than other centrifugal pumps. Despite this drawback, a vertical turbine pump provides high flow rate and high efficiency.

### **c. Submersible Pump**

The submersible pump, an illustration of which is shown in Figure 14.3, is a pump which has a hermetically sealed motor close-coupled to the pump body. The whole assembly is submerged in the fluid to be pumped. The advantage of this type of pump is that it can provide a significant lifting force as it does not rely on external air pressure to lift the fluid.

The pump is installed just above the motor, and both of these components are suspended in water. Submersible pumps use enclosed impellers and are easy to install and maintain. These pumps run only on electric power and can be used for pumping water from very deep and crooked wells. Moreover, they are unlikely to be struck by lightning and require constant flow of water across the motor.

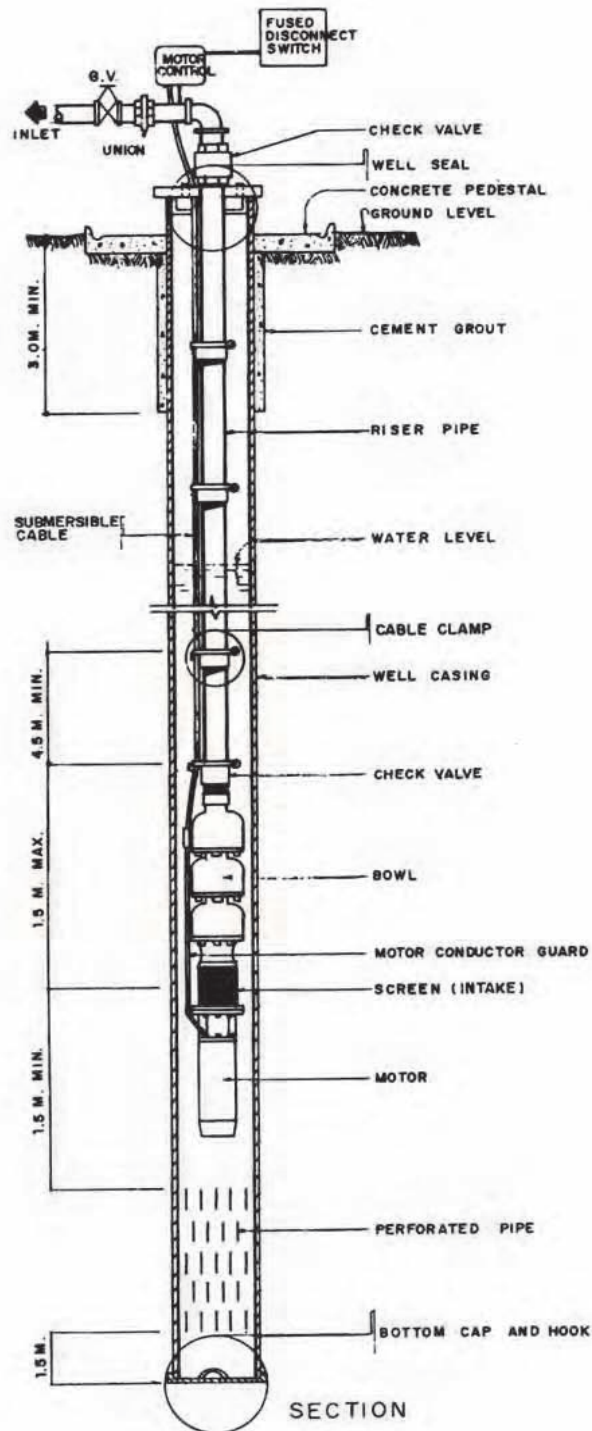
## **2. Positive Displacement Pumps**

Positive displacement pumps are either reciprocating or rotary types. A positive displacement pump causes a fluid to move by trapping a fixed amount of it then forcing (displacing) that trapped volume into the discharge pipe.

A positive displacement pump must not be operated against a closed valve on the discharge side of the pump because it has no shut-off head like centrifugal pumps. Operated against a closed discharge valve, a positive displacement pump will continue to produce flow and build up pressure until the line bursts or the pump is severely damaged or both. A relief or safety valve on the discharge side of the positive displacement pump is therefore necessary. The relief valve can be internal or external. The pump manufacturer normally has the option to supply internal relief or safety valves. An external relief valve installed in the discharge line with a return line back to the suction line or supply tank is recommended.

Positive displacement pumps can be further classified according to the mechanism used to move the fluid.

Figure 14.3: Submersible Pump



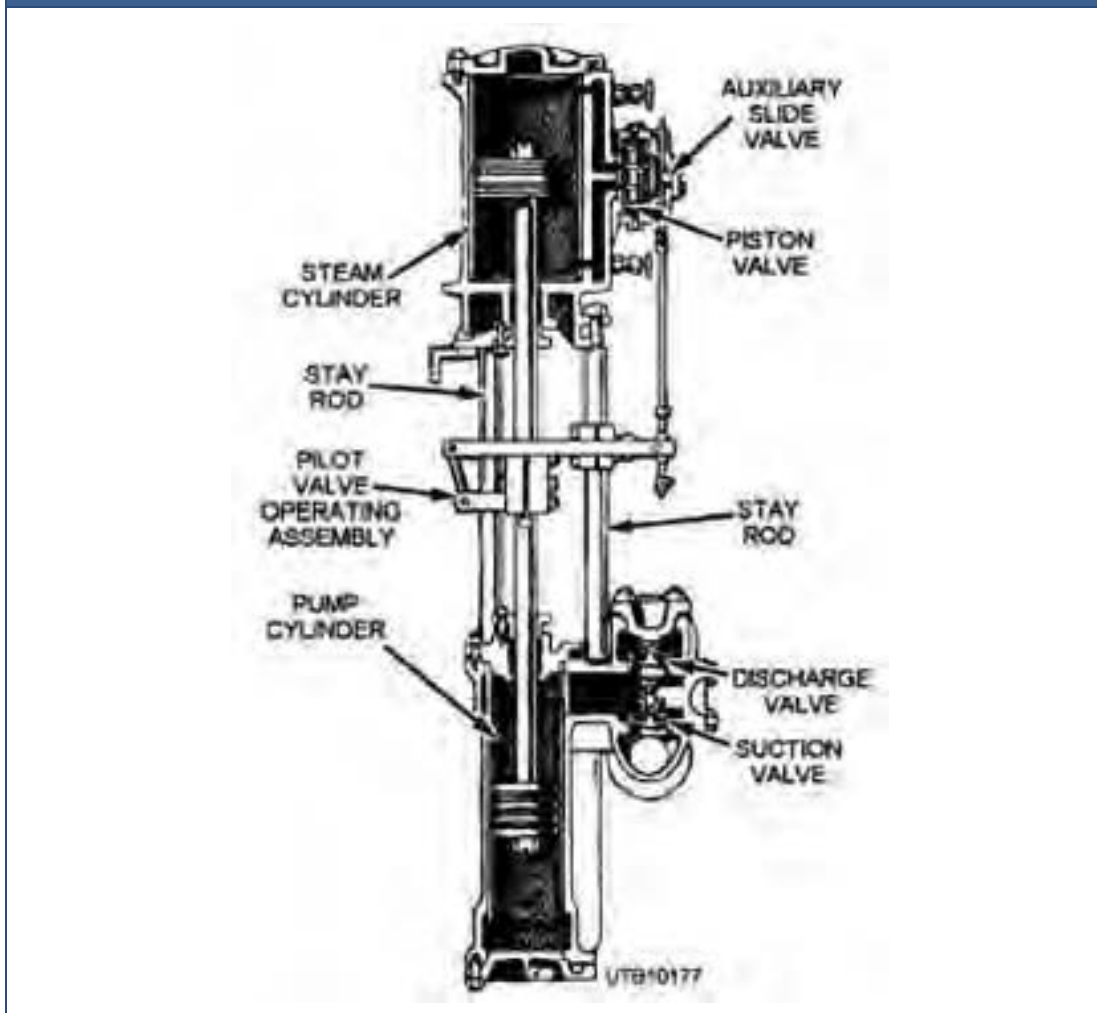
NWRC RWS Volume I, Design Manual

### a. Reciprocating Pumps

Reciprocating pumps (Figure 14.4) include piston pumps which operate by creating a vacuum in a cylinder. The water is drawn into the cylinder by the downward movement of the piston which operates a vacuum. The water is then forced out of the discharge outlet by the return stroke of the piston. When the piston acts on both ends of the cylinder, it is a double action pump or a duplex pump. Triplex and quadruplex designs are also possible and produce a smoother flow than the single action model.

The *plunger pump* is a reciprocating pump with a plunger that enters and is withdrawn from the cylinder through the packing glands. When a plunger is raised, a vacuum is created below it allowing water to flow through a check valve to fill the void. When the plunger is lowered, the check valve closes and water is trapped in the pump and forced up the plunger. The water is lifted further on the next upward stroke of the plunger.

Figure 14.4: Reciprocating Pump



NWRC RWS Volume I, Design Manual

## b. Rotary Pumps

Positive displacement rotary pumps fluid using the principles of rotation. The vacuum created by the rotation of the pump captures and draws in the liquid. Rotary pumps are very efficient because they naturally remove air from the lines, eliminating the need to manually bleed the air from the lines.

Gear pumps are the simplest type of rotary pumps, consisting of two gears laid out side-by-side with their teeth enmeshed. The gears turn away from each other, creating a current that traps fluid between the teeth on the gears and the outer casing, eventually releasing the fluid on the discharge side of the pump as the teeth mesh and go around again.

Screw pumps are a more complicated type of rotary pumps, featuring two screws with opposing thread — that is, one screw turns clockwise, and the other counterclockwise. The screws are each mounted on shafts that run parallel to each other; the shafts also have gears on them that mesh with each other in order to turn the shafts together and keep everything in place. The turning of the screws, and consequently the shafts to which they are mounted, draws the fluid through the pump. As with other forms of rotary pumps, the clearance between moving parts and the pump's casing is minimal.

The weakness of positive displacement rotary pumps is due to their intrinsic design, which requires the clearance between the rotating pump and the outer edge to be very close. Thus the pumps can only rotate at a slow, steady speed. If they are operated at high speeds, the fluids will cause erosion that eventually will enlarge these clearances, allowing the liquid to slip through, and thus detract from the efficiency of the pump.

### ***Pumping System Setup***

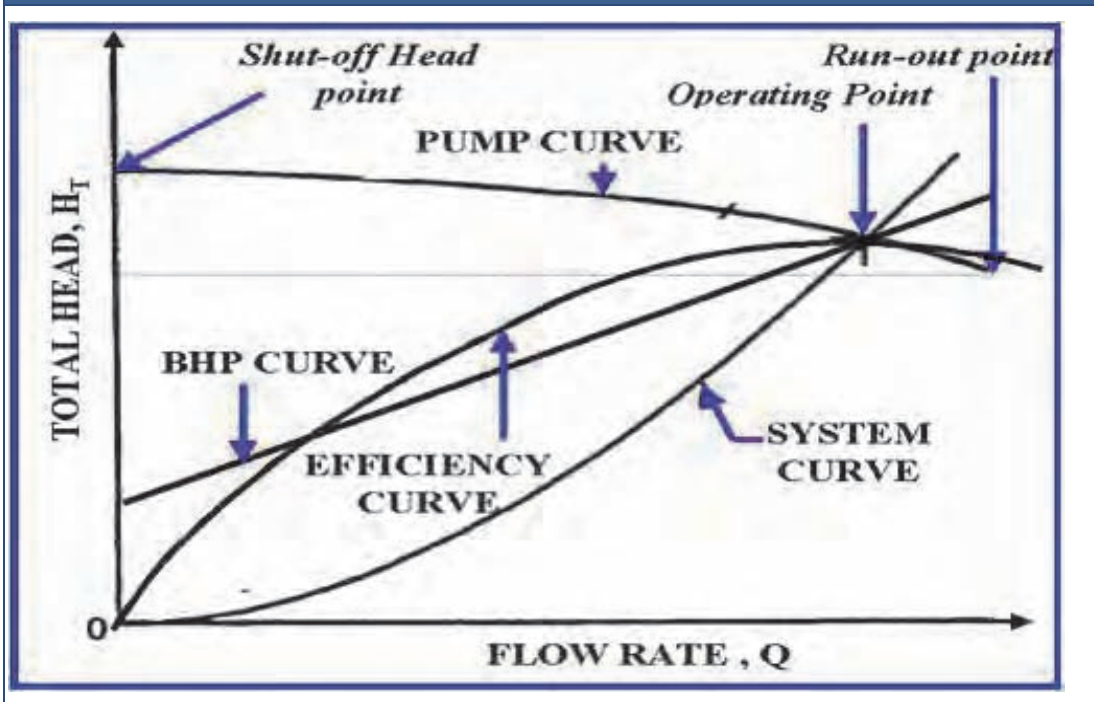
***When setting up the pumping system, carefully calculate the driver HP required based on the data on the flow, pressure and efficiency of the pump. Check the pump RPM and drive RPM and select the proper size pulleys to achieve the desired flow. Review the maximum horsepower per belt to assure that the pump receives adequate power to deliver the desired flow. The correct belt length and center distance must be established to achieve the proper HP.***

***If in doubt, consult your pump and/or drive supplier for their recommendations.***

## E. PUMP PERFORMANCE CURVES

The characteristic curves of a pump describe the factors that affect its performance. They are usually expressed graphically with the rate of discharge  $Q$  as abscissa and the other factors plotted as ordinates such as the head and the net positive suction head (NPSH). Typical pump performance curves are shown in Figure 14.5. The diagram shows that as the pump discharge increases, the power required to drive the pump increases. However the pump efficiency behaves both proportionately and inversely with the capacity of the pump much like a parabolic curve. The pump efficiency increases as the capacity is increased up to a certain point. The efficiency then decreases from that point even as the capacity continues to increase.

Figure 14.5: Pump Performance Curve



The performance curves reflect standard testing. Pump manufacturers typically calculate performance curves using a pressure gauge and a flow meter connected to the discharge port. For any anticipated total head, the discharge capacity can be determined. Pump performance curves are available for each pump model.

The Best Efficiency Point is the point at which effects of head (pressure) and flow converge to produce the greatest amount of output for the least amount of energy.



## **F. PUMP INSTALLATION**

### **1. Pumps Connected in Series**

When one pump is connected behind the other, the installation is called a series connection. A series connection will yield discharge equivalent to one pump, but the head is approximately equal to the sum of the individual heads of the pumps in the system.

### **2. Pumps connected in Parallel**

When pumps are connected beside one another, the pump connection is called a parallel system. Both of the pumps will be giving the same pressure as both will be working against the same external head. But the total Q will be the sum of their separate discharges.

### **3. Pump Foundation**

The foundation itself and the contact area of the foundation and ground have to be strong and large enough. Guidelines:

1. Make the weight of the foundation 3 to 5 times the total weight of the machinery in case of motor driven types.
2. When the pump is directly coupled to the prime mover or connected to it by a gear train, construct a single common foundation for the pump and prime mover. This will prevent misalignment due to differential settlement.

## **G. PRIME MOVERS**

Electric, gasoline or diesel engines are commonly used as power sources for pumps. The electric motor is however the most favored prime mover because of its reliability, relatively lower power cost, and environmental considerations like cleanliness, relatively lower noise, and lower pollutant emissions.

Electric motors, however, should be protected by heat sensors installed in the windings during manufacture. These sensors will shut the motor off in case of low voltage or change in phase before damage can be done.

## **H. PUMP CONTROL**

Pump controls can be manual or automatic. For small systems, manual controls can work very well. The operators can start the pump in the morning. With some operational experience, they will be able to estimate the time required to satisfy the morning peak demand and to fill the tank. When the tank is full, the pump is shut off. The pump is again started when the water level in the tank decreases to the minimum water level. On the other hand, with automatic control, the pump's start and shutoff is

actuated either by float or by pressure without requiring an operator to assume or estimate pumping cycle schedules.

## I. DESIGN OF PUMPS

In order to obtain a pumping system that will meet your requirements in an efficient manner, you must match the pump to the piping system and required flow rate.

***Manufacturers should supply a pump curve specifying the pump's performance and recommended operating range. Do not operate outside of the recommended range as this may damage the pump.***

A cost analysis of pumping should consider both the initial cost (capital investment), and operating cost. The type and size of pumping equipment, pipeline size, and system design affect not only the initial cost but also the operating cost. For example, using large pipes may cost more but could allow the use of the less expensive, smaller horsepower pumps which entail lower energy costs; whereas a piping system with a smaller diameter pipe would require pumps with higher horsepower and energy requirements.

To get the most efficient pump, an analysis should be made of all pumping requirements. Key points to consider are:

1. Net positive suction head (NPSH)
2. Priming
3. Useful life
4. Maintenance requirements
5. Quantity pumped
6. Pumping head
7. Power source
8. Economics.

The following data are needed in order to design the pump required:

1. Pump Discharge capacity
2. Total Dynamic Head
3. Pump Efficiency.

### 1. Pump Discharge Capacity

1. If the pump is used directly to supply water without a reservoir, the capacity must be equal to the peak hour demand.
2. If the water distribution system has a reservoir, the pump capacity must be equal to the maximum day demand.



## 2. Pump Selection

1. If the pumping water level (PWL) is less than 6 meters, use a centrifugal pump (maximum suction lift = 6 m).
2. If the pumping water level is from 6-20 m, use jet pumps or a submersible.
3. If the PWL is greater than 20 m, use a submersible or a vertical line shaft turbine pump.

## 3. When to use a Positive Displacement (PD) Pump

To make a good choice between the centrifugal or a positive displacement pump, it is important to understand that these two types of pumps behave very differently.

1. **Flow rate versus Pressure:** The flow of a centrifugal pump varies depending on pressure or head, whereas that of a PD pump is more or less constant regardless of pressure.
2. **Pump Mechanical Efficiency:** The pumps behave very differently with changes in pressure, which have little effect on a PD pump but a dramatic one on the centrifugal pump.
3. **Net Positive Suction Head:** Net positive suction head is used to describe the absolute pressure of a fluid at the inlet to a pump minus the vapor pressure of the liquid. The resultant value is known as the Net Positive Suction Head available (NPSHa).

Pump manufacturers also use the same term to describe the energy losses that occur within many pumps as the fluid volume is allowed to expand within the pump body.

This energy loss is expressed as a head of fluid and is described as NPSHr (Net Positive Suction Head requirement). A pump performance curve will usually include a NPSH requirement graph expressed in meters.

The NPSHa must be greater than the NPSHr to prevent cavitation problems.

4. **Peak Performance Range:** A centrifugal pump performs best in the center of the curve. Moving away from the center creates additional considerations. Far enough to the left or right, pump life is reduced due to either shaft deflection or increased cavitation. On the other hand, a PD pump can be operated on any point of the curve. In fact the volumetric efficiency ratio actually improves at the high speed part of the curve. This is due to the fact that the volumetric efficiency is affected by slip, which is essentially constant. At low speed the percentage of slip is higher than at high speed.

### Example 14.1

<b>DATA:</b>	Per Capita Demand	60 lpcd
	Design Population	1,200
	Average Day Demand	$60 \times 1200 = 72,000$ lpd
	Maximum Day Demand	$1.3 \times 72,000 = 93,600$ lpd
	Water Source:	Well
	• Static Water Level	4 m
	• Pumping Water level	10 m
	Reservoir Height (max. water level MWL):	8 m
	Friction loss in suction and discharge Pipe:	2 m

**REQUIRED:** Pump Capacity (12 hrs operation)  
TDH  
Water horsepower  
Brake horsepower  
Pump type

#### ANALYSIS:

1. Calculate pump capacity:

$$\mathbf{Pump\ Capacity} = 93,600\ lpd \times \frac{1\ day}{12\ hrs \times 60\ min \times 60\ sec} = \mathbf{2.17\ lps}$$

2. Calculate pump TDH:

$$\mathbf{TDH} = \mathbf{PWL} + \mathbf{H_f} + \mathbf{MWL} = 10\ m + 2\ m + 8\ m = \mathbf{20\ m}$$

3. Calculate WHP:

$$\mathbf{WHP} = Q \times \frac{\mathbf{TDH}}{75} = 2.17 \times \frac{20}{75} = \mathbf{0.58\ hp}$$

4. Calculate BHP:

Assume pump efficiency = 40%

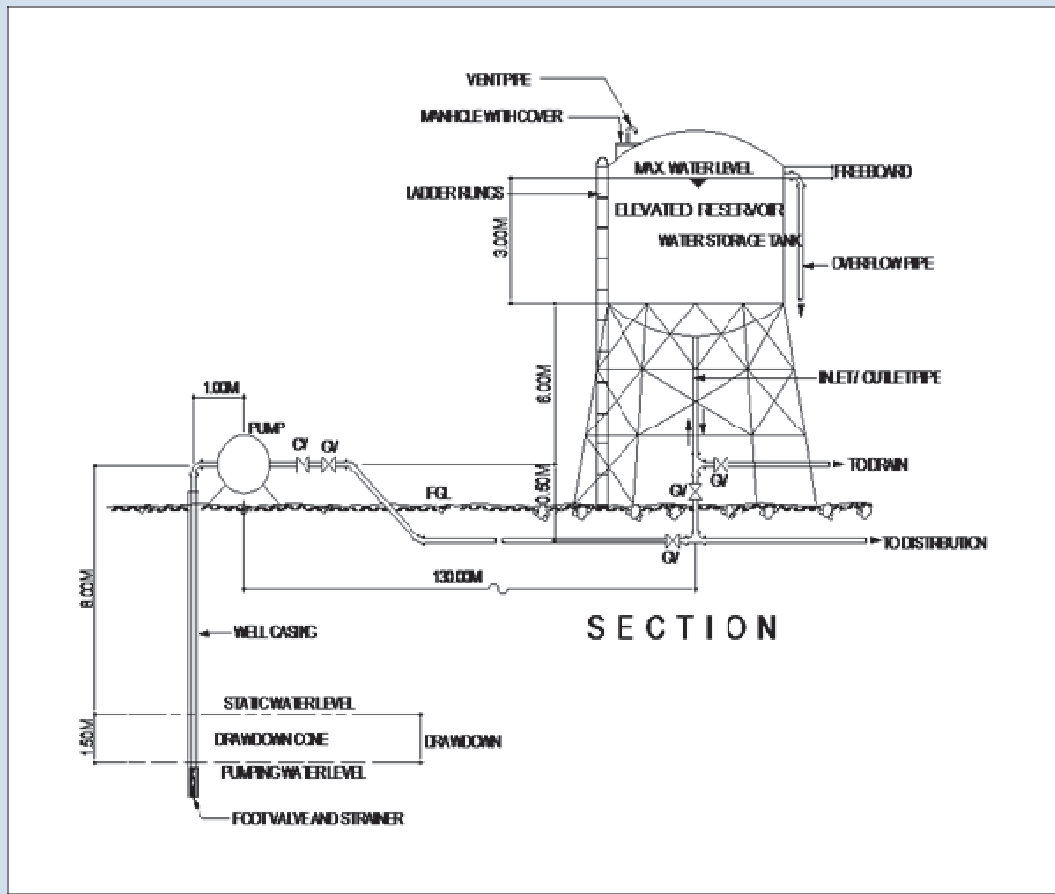
$$\mathbf{BHP} = \frac{\mathbf{WHP}}{e} = \frac{0.58}{0.40} = 1.44\ \text{say}\ \mathbf{1.5\ hp}$$

5. Determine pump type:

Since the pumping level is only 10 m, a jet pump, submersible or a vertical turbine pump can be used with the following characteristics and dependent on well diameter.

$$\begin{aligned}\mathbf{Q} &= \mathbf{2.17\ lps} \\ \mathbf{TDH} &= \mathbf{20\ m} \\ \mathbf{BHP} &= \mathbf{1.5\ hp}\end{aligned}$$

**Example 14.2: Determining Pump TDH and Pipe Size (PART I: RESERVOIR DESIGN)**



**BASE DATA**

Reservoir Maximum Water Level	9 m
Pump Requirement	2 lps
Pipe Length (L)	147 m
Appurtenances:	
Foot valve	1
Strainer	1
90° elbow	1
45° elbow	2
Tee	2
Globe valves	3

**REQUIRED**

- Pump TDH
- Plastic pipe size

*(Continued on next page)*

(Continued from previous page)

**Example 14.2: Determining Pump TDH and Pipe Size (PART II: ANALYSIS – 38 mm PIPE)**

**1. Determine pipe size**

To determine pipe sizes, assumptions have to be made. Assume a pipe size of 38 mm.

**2. Determine friction losses**

Using Table 11.3, determine the equivalent pipe size for the valves, fittings, etc. with 38mm diameter:

Appurtenances	Dia. (mm)	No.	Equivalent length per fitting (m)	EQL (m)
Strainer	38	1	5.49	5.49
Foot valve	38	1	2.44	2.44
90° Elbow	38	1	1.36	1.36
45° Elbow	38	2	0.61	1.22
Tee	38	2	2.74	5.48
Check valve	38	1	3.35	3.35
Globe valve	38	3	13.71	41.13
<b>Total</b>				<b>60.47</b>

**3. Determine total Head loss using 38 mm pipes**

Get head loss per 100 m using Table 11.1  
With  $Q = 2$  lps and 38 mm dia.

$$H_f = 8.40 \text{ m}/100 \text{ m}$$

$$\text{Total pipe line length} = 1.5 + 8.0 + 130 + 0.5 + 6 = 147 \text{ m} + 60.47 \text{ m} = \mathbf{207.47 \text{ m}}$$

$$\text{Therefore } \mathbf{HL} = 8.40 \times (207.47/100) = \mathbf{17.40 \text{ m}}$$

**4. Determine Pump TDH**

$$\text{TDH} = \text{Reservoir water level} + \text{headlosses} + \text{pumping water level}$$

$$\mathbf{TDH} = 9 + 17.40 + 6 = \mathbf{32.40 \text{ m}}$$

**5. Calculate WHP**

$$\mathbf{WHP} = QH/75 = 2 \times 32.4/75 = \mathbf{0.864 \text{ hp}}$$

**6. Calculate BHP**

Assume submersible pump with  $e = 50\%$

$$\mathbf{BHP} = \frac{WHP}{e} = \frac{0.864}{0.5} = 1.728, \text{ say } \mathbf{1.75 \text{ hp using 38 mm pipelines}}$$

(Continued on next page)

(Continued from previous page)

**Example 14.2: Determining Pump TDH and Pipe Size (PART III: ANALYSIS – 50 mm PIPE)**

1. **Determine pipe size**

Assume a pipe size of 50 mm.

2. **Determine friction losses**

Using Table 11.3, determine the EQL of the fittings

Appurtenances	Dia. (mm)	No.	Equivalent length per fitting (m)	EQL (m)
Strainer	50	1	6.10	6.10
Foot valve	50	1	2.74	2.74
90° Elbow	50	1	1.62	1.62
45° Elbow	50	2	0.76	1.52
Tee	50	2	3.66	7.32
Check valve	50	1	4.27	4.27
Globe valve	50	3	16.76	50.27
<b>Total</b>				<b>73.85</b>

3. **Determine total Head loss using 50 mm pipes**

Get head loss per 100 m using Table 11.1

$$H_f = 2.30 \text{ m}/100 \text{ m}$$

$$\text{Total pipe line length} = 147 \text{ m} + 73.85 \text{ m} = \mathbf{220.85 \text{ m}}$$

$$\text{Therefore } \mathbf{HL} = 2.30 \times (220.85/100) = \mathbf{5.08 \text{ m}}$$

4. **Determine Pump TDH**

$$TDH = \text{Reservoir water level} + \text{headlosses} + \text{pumping water level}$$

$$\mathbf{TDH} = 9 + 5.08 + 6 = \mathbf{20.08 \text{ m}}$$

5. **Calculate WHP**

$$\mathbf{WHP} = QH/75 = 2 \times 20.08/75 = \mathbf{0.535 \text{ hp}}$$

6. **Calculate BHP**

Assume submersible pump with  $e = 50\%$

$$\mathbf{BHP} = \frac{WHP}{e} = \frac{0.535}{0.5} = 1.07, \text{ say } \mathbf{1.25 \text{ hp using 50 mm pipelines}}$$

(Continued on next page)

(Continued from previous page)

**Example 14.2: Determining Pump TDH and Pipe Size (PART IV: DECISION)**

***The designer can now choose which of the 2 designs is cheaper:***

***Using a 38 mm pipeline with a 1 ¾ HP pump,***


***OR***

***Using a 50mm pipeline using a 1 ¼ HP pump***

# Annexes

## TABLE OF ANNEXES

<b>Annex A Requirements for Detailed Engineering Design.....</b>	<b>A.3</b>
A-I General.....	A.3
A-II Confirmation of Proposed Source Facilities.....	A.3
A-III Topographic Survey.....	A.3
A-IV System Configuration and Sizing.....	A.5
A-V Final System Design .....	A.5
A-VI Schematic Network Diagram .....	A.5
A-VII Preparation of Detailed Design Drawings.....	A.6
A-VIII Cost Estimates.....	A.6
A-IX Detailed Engineering Design Submissions .....	A.7
<b>Annex B Using EPANET .....</b>	<b>A.8</b>
B-I Introduction to Epanet.....	A.8
B-II Tutorial for Epanet Analysis .....	A.12
<b>Annex C Design Criteria and Standards .....</b>	<b>A.35</b>
<b>Annex D In-Place Cost of Waterworks Materials and Equipment.....</b>	<b>A.36</b>
A. Pipelines .....	A.36
B. Gate Valves .....	A.37
C. Butterfly Valves.....	A.37
D. Fire Hydrant Assemblies .....	A.37
E. Blow-Off Assemblies .....	A.37
F. Air Vacuum/Air Release Valves.....	A.37
G. Service Connections .....	A.38
H. Additional Tubing.....	A.38
I. Pavement Demolition .....	A.38
J. Surface Restoration.....	A.39
K. Over-Excavation for Pipelines .....	A.39
L. Miscellaneous .....	A.39
M. Pump Houses & Reservoirs .....	A.39
N. Electro-Mechanical Equipment.....	A.40



1. Pumping Stations.....	A.40
2. Diesel Generating Sets.....	A.40
3. Distribution Transformers & Accessories.....	A.40
4. Chlorination Equipment .....	A.41
5. Flow Meters.....	A.41
6. Check Valves with Counterweight.....	A.41
<b>References.....</b>	<b>A.42</b>



## Annex A

# Requirements for Detailed Engineering Design

### A-I GENERAL

The detailed engineering design of the proposed potable water supply project can only be started after screening and the preparation of the feasibility study. Only after the feasibility study confirms the project to be technically, socially and economically viable can the project be included in the list of candidates for detailed engineering design.

The workflow in the preparation of detailed engineering design (DED) is shown in the flowchart on the following page.

### A-II CONFIRMATION OF PROPOSED SOURCE FACILITIES

Prior to the conduct of DED, the proposed water source location, yield, drawdown and water quality shall be revalidated through additional data gathering and field confirmation. The conduct of geo-resistivity shall be performed for ground water in the target area to identify the location of the proposed well site if this was not performed during the preparation of the feasibility study. For spring source, monitoring of spring discharges shall continue on a regular basis starting from the planning stage to the detailed design stage.

### A-III TOPOGRAPHIC SURVEY

The topographic survey is intended for the final configuration of the facility in the preparation of detailed design analysis and drawings. The requirements and scope of works for topographic survey includes but not limited to the following:

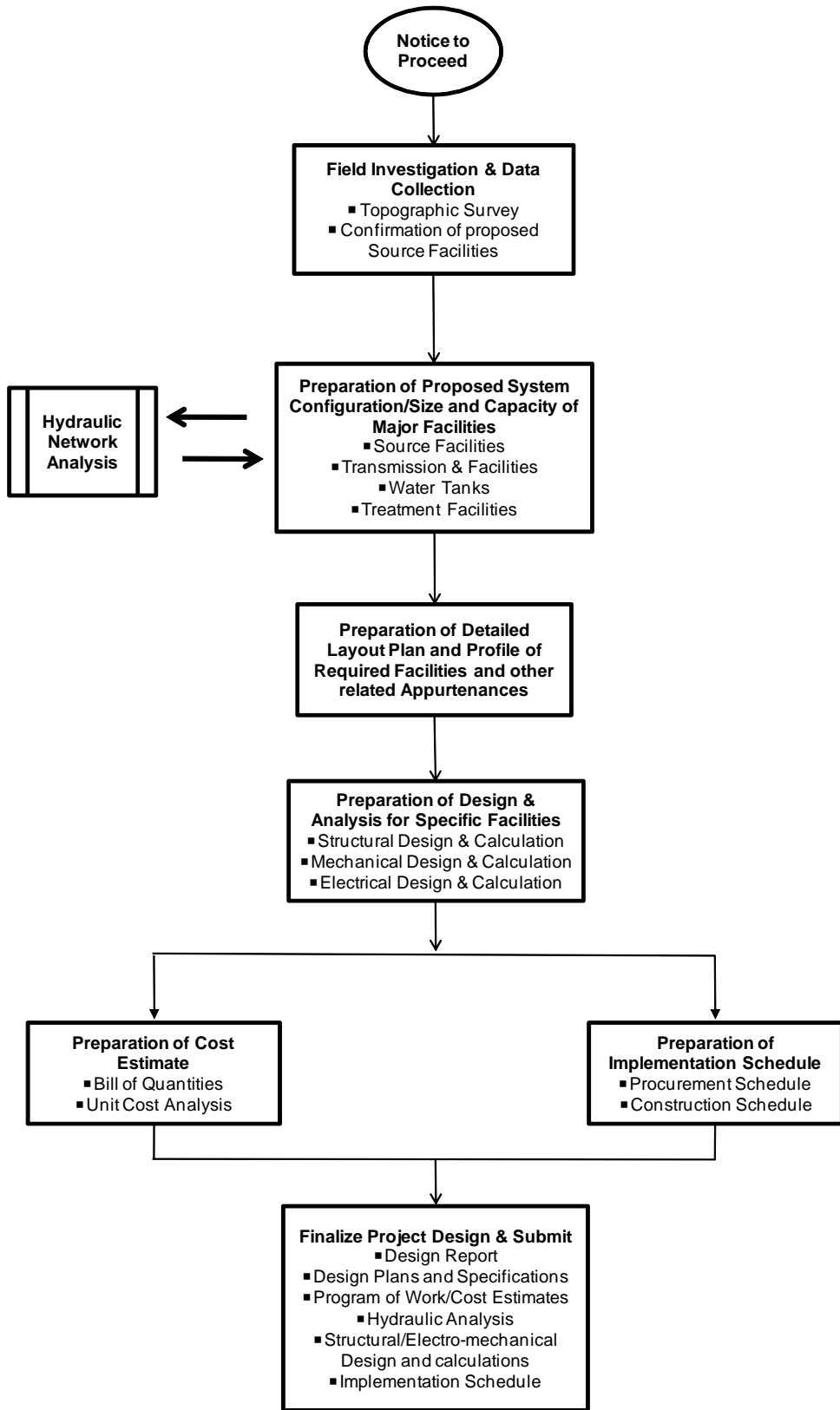
#### 1. Scope of Works

- Traverse
- Leveling
- Distance measurements
- Plan preparation with appropriate scale (1:000 ~ 1:2000).

#### 2. Requirements for Topographic Map

- Road network and type including waterways within the proposed pipe alignment;
- Locations of houses, public buildings, electric posts, kilometer posts and other utility facilities;

**WORK FLOW FOR DETAILED ENGINEERING DESIGN**



- Location and elevation of proposed water source(s);
- Cross sections of roads and waterways which will be traversed by the pipeline;
- Spot elevations of the proposed locations of communal faucets;
- Electric power lines indicating information such as type of phase and voltage.

#### **A-IV SYSTEM CONFIGURATION AND SIZING**

The system configuration refers to the general layout of the proposed system which contains the major components of the potable water supply project. After the completion of the topographic survey, the finalization of the proposed water supply project configuration could commence. From this configuration, then the initial sizing of the required components entails the conformance to the appropriate criteria of the following:

- Hydraulic Design Criteria
- Structural Design Criteria
- Electro-mechanical Design Criteria.

#### **A-V FINAL SYSTEM DESIGN**

The final system configuration of the proposed water supply project normally contains the location of following proposed major facilities:

- Water source
- Reservoir or tank
- Transmission and Distribution pipelines
- Communal faucets and or service connections

The final system design should be the least cost option among other possible alternatives in the area and should be recommended as the final system configuration.

#### **A-VI SCHEMATIC NETWORK DIAGRAM**

The schematic network diagram is composed of links and nodes. The links represent the pipes to be installed; nodes represent public faucets (demands), road intersections, tanks or reservoirs and water source. The recommended methods on how to prepare the schematic network diagram are as the following:

- All pipes in the system should be shown with corresponding distinct number and length based on the output of the topographic survey.
- Each node should be given distinct number and elevation based on the topographic survey.

- Public faucets or water demands should be assigned to nodes indicating the number of households served.
- Tank or reservoir should be placed in a node that represents the location in the service area.

With the schematic network diagram, hydraulic analysis is done using EPANET to check residual pressure at each node based on the result of headloss computations.

## **A-VII PREPARATION OF DETAILED DESIGN DRAWINGS**

The detailed design drawings or construction drawings should contain the details and standard drawings for waterworks consisting of civil, mechanical and electrical works. The preparation of detailed design drawings shall be based on the final selected alternative or final configuration of the proposed water supply system. Detailed design drawings should include at least the following:

- Cover Page
- Topographic Map
- Table of Contents with Vicinity Map and Location Map
- Legends and Symbols
- Key Plan of Delineated Area
- Plan of Water Supply Facilities
- Profile of Transmission and Distribution Pipelines
- Pipe Trench Details and Public Faucet or Service Connections Details
- Pipe Bridge, culvert and river crossing details when applicable
- Civil and electro-mechanical facility drawings when applicable such as intake facility, tank or reservoir, pump house and deepwell construction drawings.

Part of detailed drawings when applicable will require the calculations and design analysis for mechanical, electrical and structural facilities to complete the system.

## **A-VIII COST ESTIMATES**

The preparation of cost estimate requires first the completion of the detailed design drawings and applicable specifications of all the facilities of the water system. The cost estimates should include the costs of materials, labor, equipment and other specialty services to complete the water supply facility. The derivation of unit costs should consider the availability and source of construction materials and labor in the area. Other costs of water supply items could be based on the latest “In-Place-Cost” prepared by LWUA or on recently completed nearby potable water supply projects.

## **A-IX DETAILED ENGINEERING DESIGN SUBMISSIONS**

The detailed engineering design when completed should be submitted containing the following basic documents:

- Design Report
- Hydraulic Analysis
- Program of Work (Cost Estimate)
- Design Drawings
- Construction Schedule.

## Annex B

# Using EPANET

### B-I INTRODUCTION TO EPANET

EPANET is a computer program that performs extended period simulation of hydraulic and water quality behavior within pressurized pipe networks. A network consists of pipes, nodes (pipe junctions), pumps, valves and storage tanks or reservoirs. EPANET tracks the flow of water in each pipe, the pressure at each node, the height of water in each tank throughout the network during simulation period comprised of multiple time steps.

#### Hydraulic Modeling Capabilities

Full feature and accurate hydraulic modeling is a prerequisite for doing effective water quality modeling. EPANET contains a state-of-the-art hydraulic analysis engine that includes the following capabilities:

- Places no limit on the size of the network that can be analyzed;
- Computes friction headless using Hazen-Williams, Darcy-Weisbach, or Chezy-Manning formulas;
- Includes minor head losses for bends and fittings;
- Models constant or variable speed pumps;
- Computes pumping energy and cost;
- Models various types of valves including shutoff, check, pressure regulating, and flow control valves;
- Allows storage tanks to have any shape (i.e., diameter can vary with height);
- Considers multiple demand categories at nodes, each with its own pattern of time variation;
- Models pressure-dependent flow issuing from emitters (sprinkle heads) can base system operation on both simple tank level or timer

controls and on complex rule-based controls.

#### Physical Components

**Junctions** – are points in the network where links join together and where water enters or leaves the network.

The basic (and most important) input data required for junction are:

1. Elevation above some reference (usually main sea level);
2. Water Demand.

The output results computed for junctions at all time periods of a simulation are:

1. Hydraulic heads;
2. Pressure - always in positive sign and at least 7 m (equivalent to 2-storey house) at peak hour.

**Reservoirs** – are nodes that represent an infinite external source to the network. They are use to model such things as lakes, rivers, groundwater aquifers and tie-ins to the system.

The primary input properties are:

1. Hydraulic head (equal to water surface elevations if the reservoir is not under pressure);

2. Because reservoir is a boundary point of a network, its head and water quality cannot be affected by what happens within the network. This will be dependent on the water resource study.

**Tanks** - are nodes with storage capacity, where the volume of stored water can vary with time during simulation.

The basic (and most important) input data required for junction are:

1. Bottom Elevation (where water level is zero);
2. Diameter (or shape if non-cylindrical);
3. Initial, minimum, and maximum water levels;
4. And initial quality.

The Principal outputs computed over time are:

1. Hydraulic heads (water surface elevation);
2. Water quality.

**Pipes** – are links that convey water from one point in the network to another. EPANET assumes that all pipes are full at all times.

The principal hydraulic input parameters are:

1. Start and end of nodes;
2. Diameter;
3. Length;
4. Roughness coefficient (to determine headloss);
5. Status (open, closed, or contain check valve).

The computed output for pipes includes:

1. Flow rate
2. Velocity
3. Headloss

**Pumps** – are the links that impart energy to a fluid thereby raising its hydraulic head. The principal input parameters are:

1. Start and end of nodes;
2. Pump curve (the combination of heads and flows that the pump can produce).

The computed output includes flow and head gain.

EPANET will not allow a pump to operate outside the range of its pump curve. As with pipes, a pump can be turned on and off at present times or when certain condition exist in the network (to be discuss in Data-Control Menu). A pump operation can also be described by assigning it a pattern of relative speed setting.

**Valves** – are links that limit the pressure or flow at a specific point in the network.

The principal input parameters are:

1. Start and end of nodes
2. Diameter
3. Setting
4. Status

The computed output includes:

1. Flow rate
2. Headloss

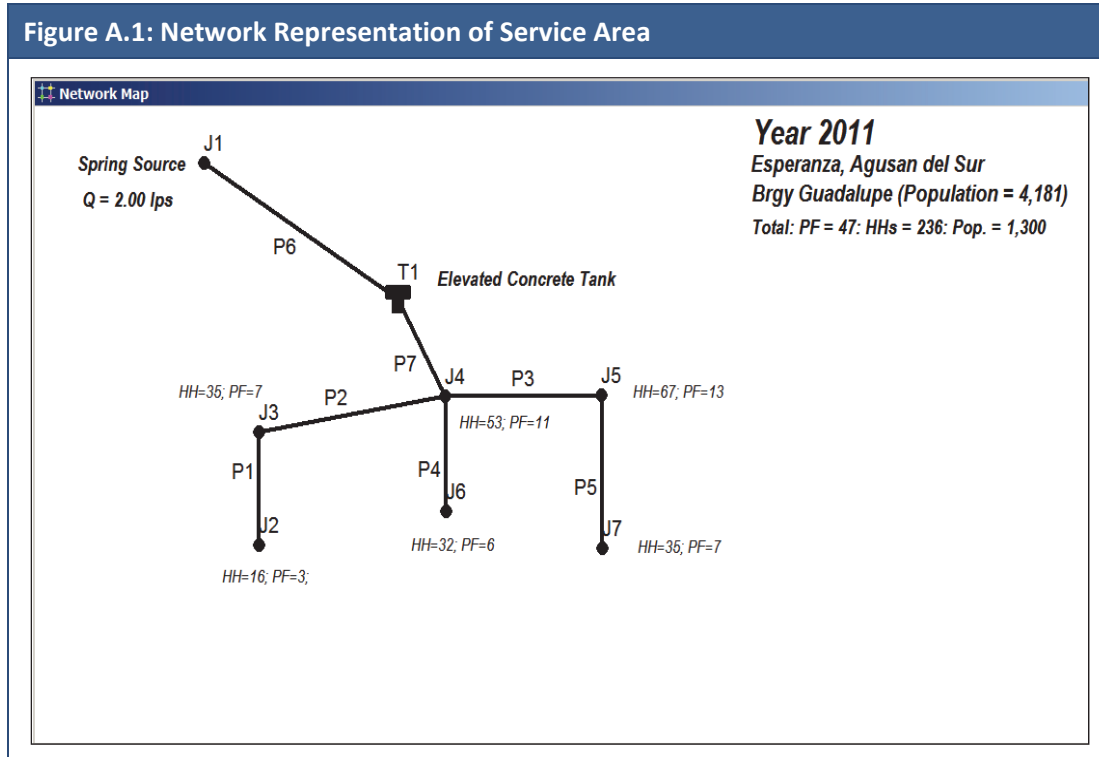
Different types of valves included in EPANET:

1. Pressure Reducing Valve (PRV)
2. Pressure Sustaining Valves (PSV),
3. Pressure Breaker Valve (PBV)
4. Flow Control Valve (FCV)
5. Throttle Control Valve (TCV)
6. General Purpose Valve (GPV)

## Step-by-Step Sample Problem Application

EPANET Project file contains all of the information used to model a network. This paper shows an example using EPANET in analyzing and simulating for extended period a rural barangay (village) using an appropriate water demand and demand variation for the population and other characteristics of the service area.

Given the pipe and junction data for the network as shown in Figure A.1, determine the flow rate in each line and pressure at each junction node using EPANET.



The system is a conventional system using a water storage tank, distribution pipelines and a nearby spring as source of drinking water. A 23 cu m elevated concrete tank is located within the village with bottom elevation of 18 m and height of 3.6 m. The nearby spring water source at elevation 40 m supplies water with a constant flow of 2.50 liters per second during the day. All the distribution pipes have a roughness coefficient  $C = 120$ . Hazen-Williams formula is used during the calculations. Minor losses are neglected. The water demands are tabulated below:



**Table 1: Water Demand**

Location	No. HH	HH Size	Served Pop.	Public Faucet	Total Day Demand	NRW	ADD	MDD	PHD
Junc J1	Spring Source								
Junc J2	14	5.5	77	3	4,620	30%	0.076	0.099	0.190
Junc J3	35	5.5	193	7	11,580	30%	0.191	0.248	0.478
Junc J4	53	5.5	292	11	17,520	30%	0.290	0.377	0.725
Junc J5	67	5.5	369	13	22,140	30%	0.366	0.476	0.915
Junc J6	32	5.5	176	6	10,560	30%	0.175	0.228	0.438
Junc J7	35	5.5	193	7	11,580	30%	0.191	0.248	0.478
Tank1									
<b>Total</b>	<b>236</b>	<b>5.5</b>	<b>1300</b>	<b>47</b>	<b>78,000</b>	<b>30%</b>	<b>1.289</b>	<b>1.676</b>	<b>3.224</b>

Notes: 1.0 Per Capita Water Consumption, 60 lpcd  
 2.0 Average HH per PF = 5  
 3.0 Average Day Demand (ADD); l/sec.

4.0 Maximum Day Demand, ADD x 1.30, l/sec.  
 5.0 Peak Hour Demand, ADD x 2.50, l/sec.

It is not accurate to assume a constant demand in the village. The base demands (ADD) shown in Table 1 correspond to the average day demands. For a rural area with less than 1000 service connections, the Peak-Hour-Demand multiplier is 2.5 x Average-Day-Demand.

During the hydraulic simulation, nodal and link outputs should be compared and modified until results are acceptable, and satisfy some basic design parameters listed below:

- Water Velocity range : 0.4 m/s to 3 m/s
- Pipe Friction headloss: 0.5 m/km to 10 m/km
- Pressure: 70 m to 7 m (100 psi to 10 psi)

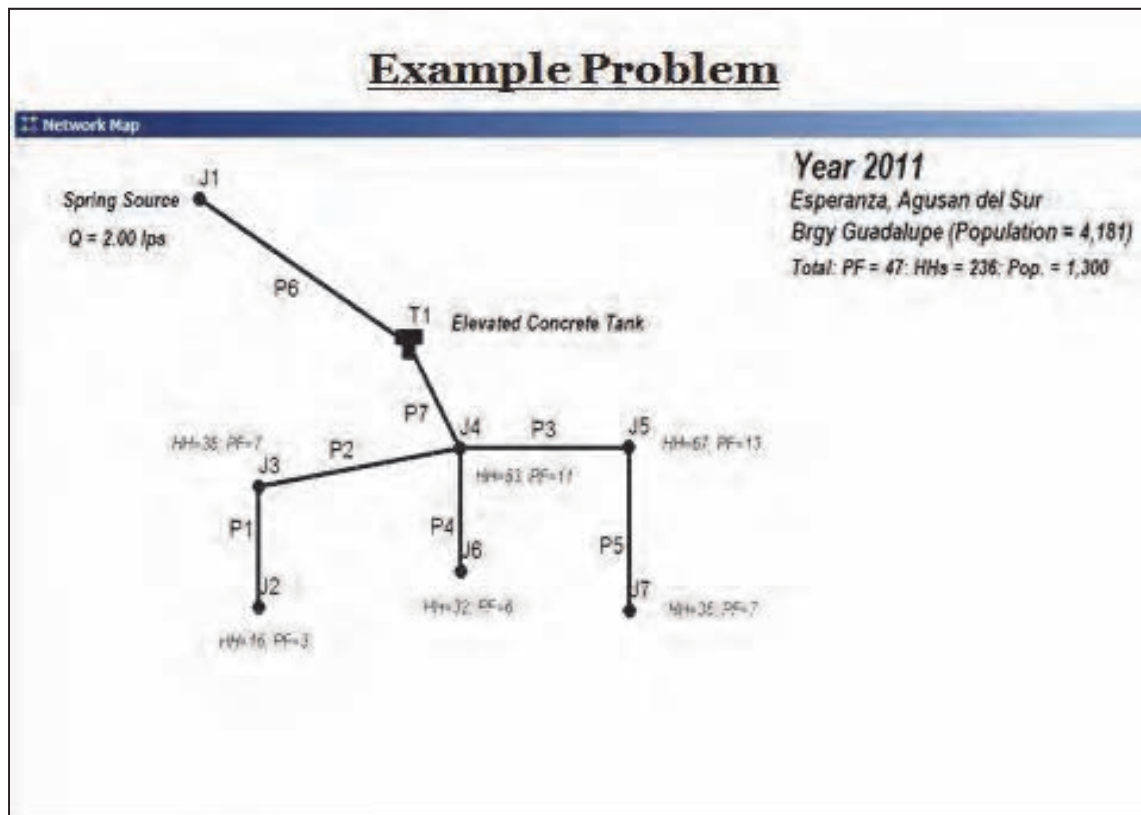
## B-II TUTORIAL FOR EPANET ANALYSIS

### Steps for EPANET Analysis

One typically carries out the following steps when using EPANET to model a water distribution system:

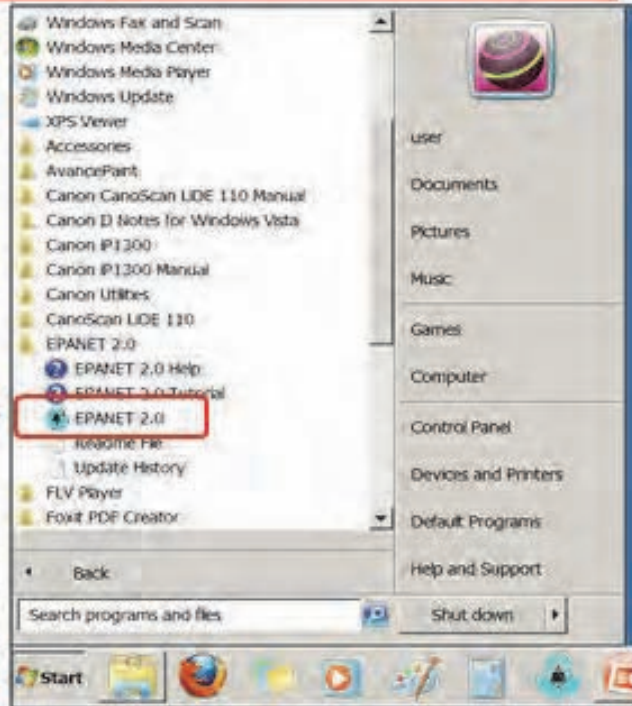
1. Open EPANET 2.0 Program
2. Set-Up a New Projects
3. Create the Project Scenario
4. Analyze the Network
5. View Results of Analysis

Using the example previously given, following is a step-by-step application of EPANET:



## 1. Open EPANET 2.0 Program

- To Run EPANET program, simply select this item off of the Start Menu
- Select EPANET 2.0 from the submenu
- Click to Run:



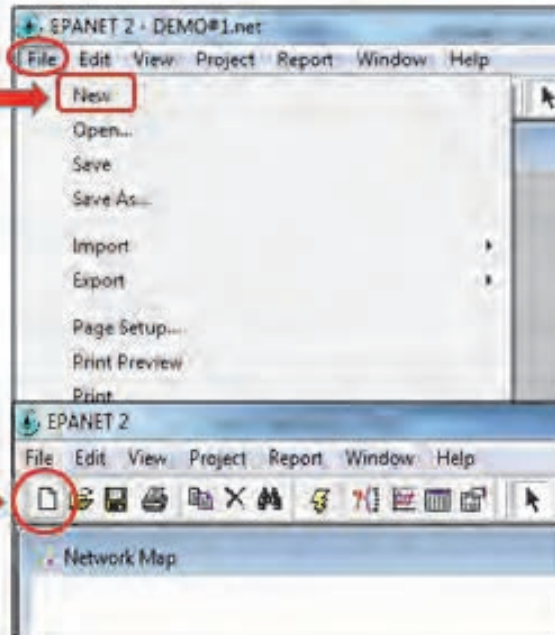
## 2. Set Up a New Project

- a. Create a New Project
- b. Set Project Preferences
- c. Set Project Defaults
- d. Set Map Options

## a. Create a New Project: File >> New

- From Main Toolbars select: File >> New
- A new, unnamed project is created with all options set to default values

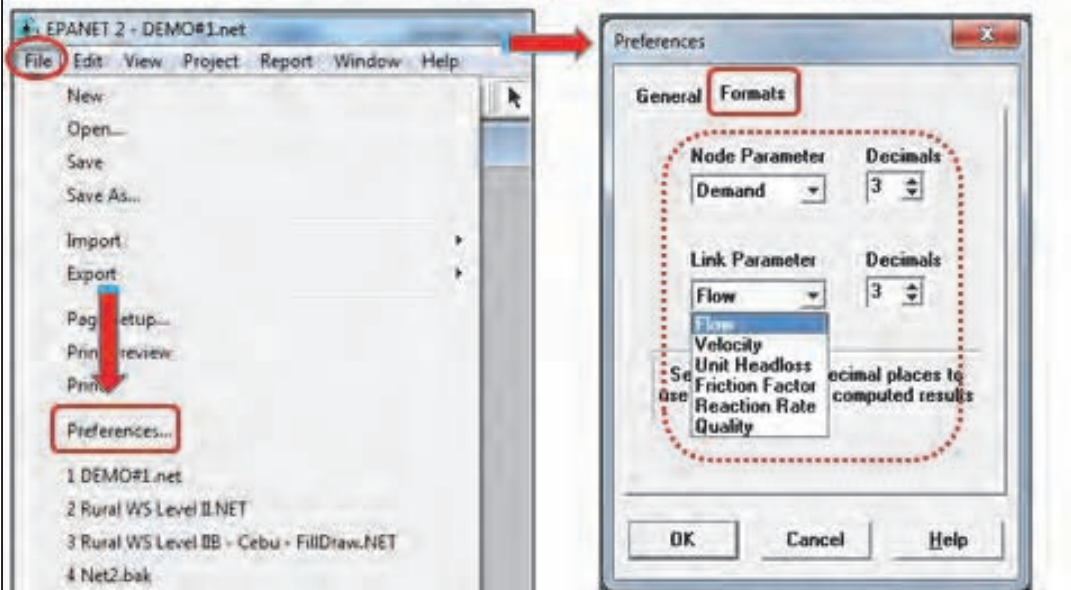
- Or, click New Project from Standard Toolbars
- Prompted to save the existing project before the new project is created



## b. Set Project Preferences: File >> Preferences

- From Main Toolbars select: File >> Preferences

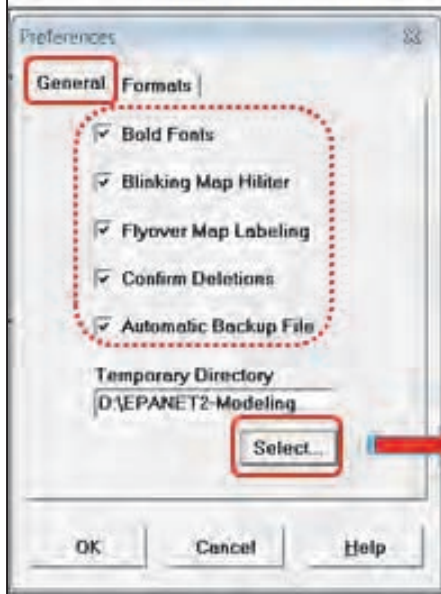
### ▪ Formats Preferences



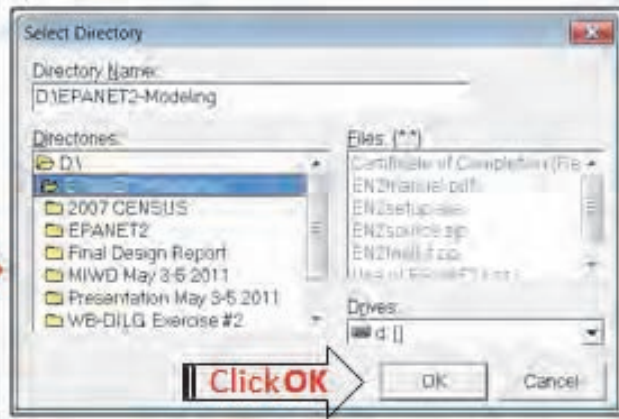


## b. Set Project Preferences: File >> Preferences

### General Preferences

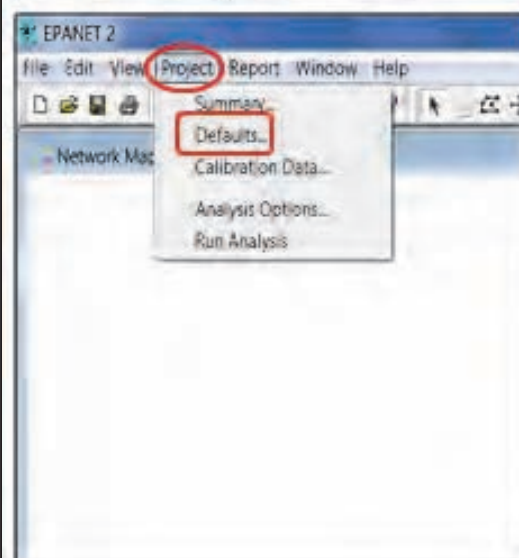


- Lastly, Press Select below Temporary Directory
- Browse for the c:\temp directory and press OK to accept the default directory

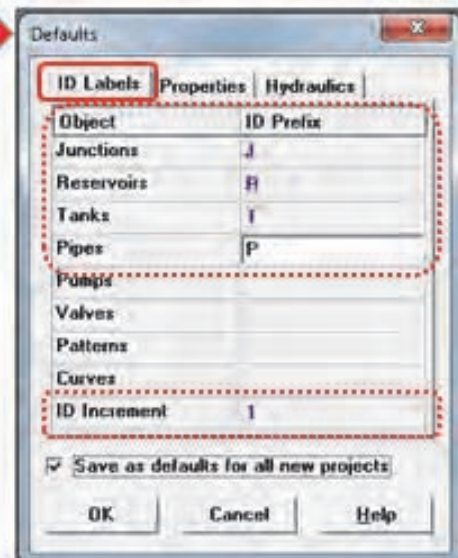


## c. Set Project Defaults: Project >> Defaults

- From General Toolbar select: Project >> Defaults



### ID Labels Defaults

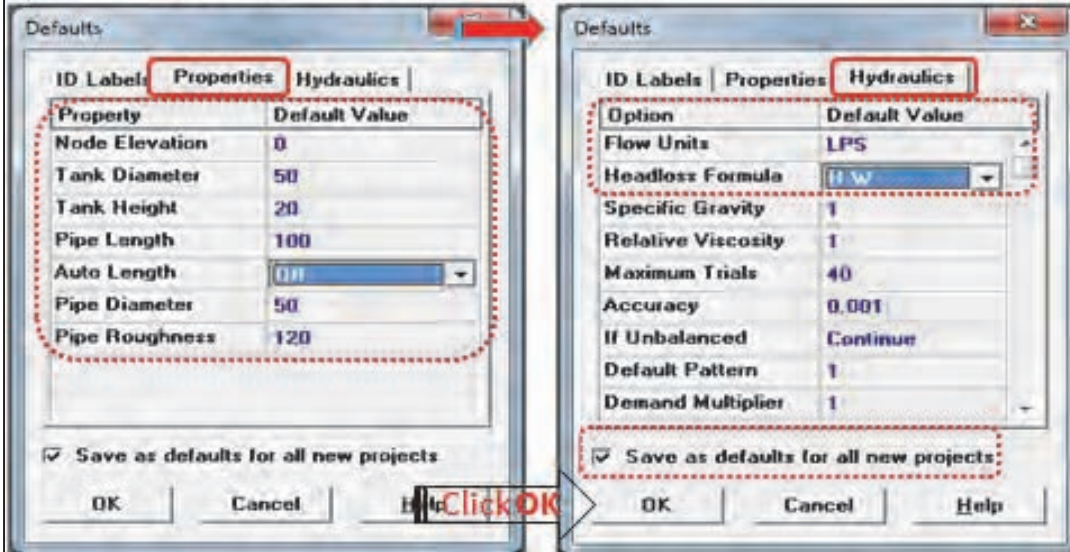


### c. Set Project Defaults: Project >> Defaults

- Properties Defaults
  - Make sure Auto Length is off
  - For Pipe Diameter = 50
  - For Pipe Roughness = 120

#### ▪ Hydraulics Defaults

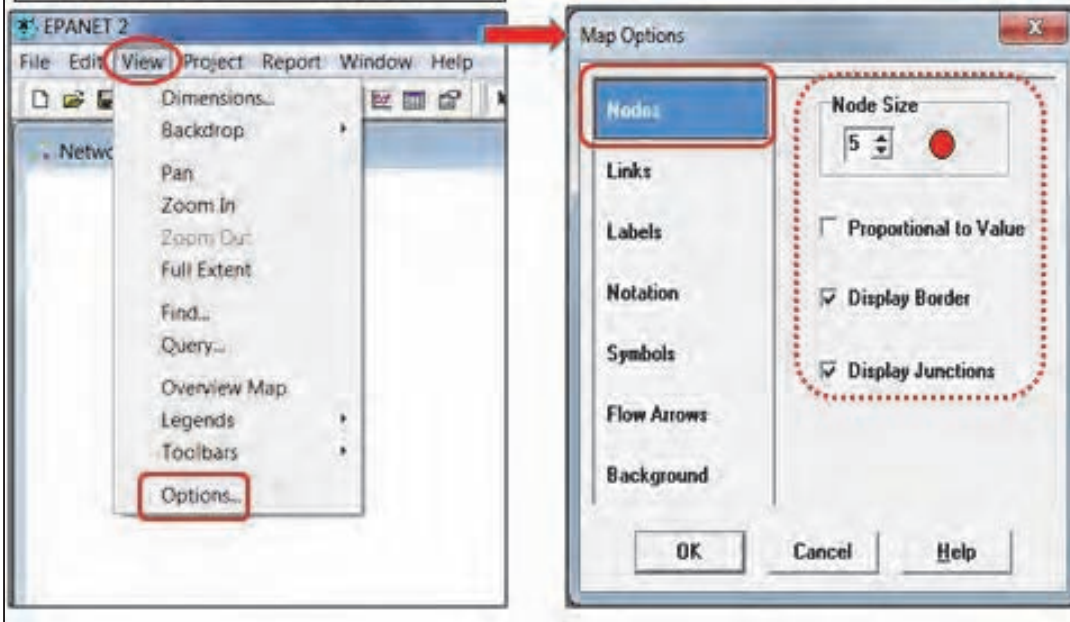
- Select appropriate flow units >> LPS
- Select headloss formula >> H-W



### c. Set Map Options: View >> Options

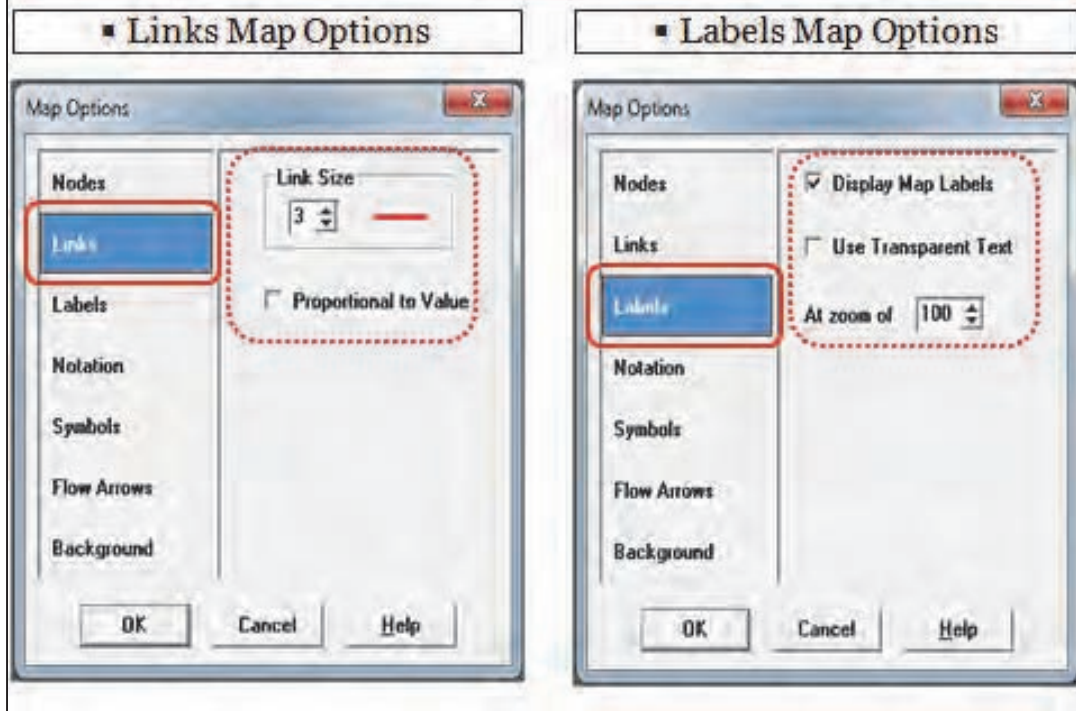
- From Main Toolbar select: View >> Options

#### ▪ Nodes Map Options

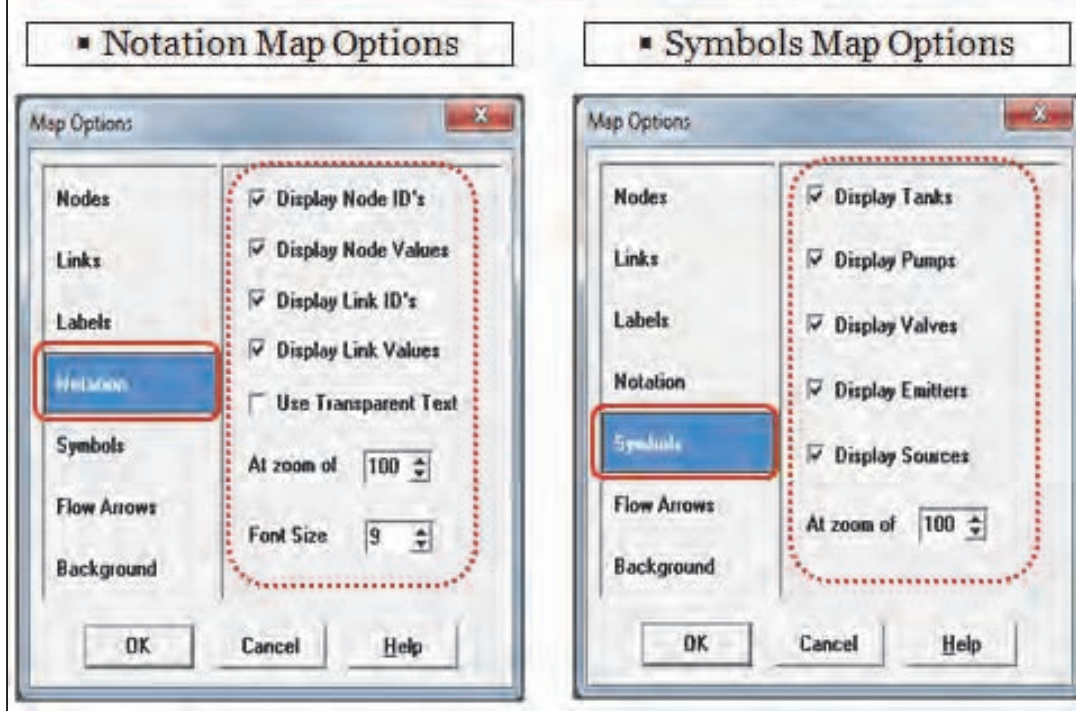




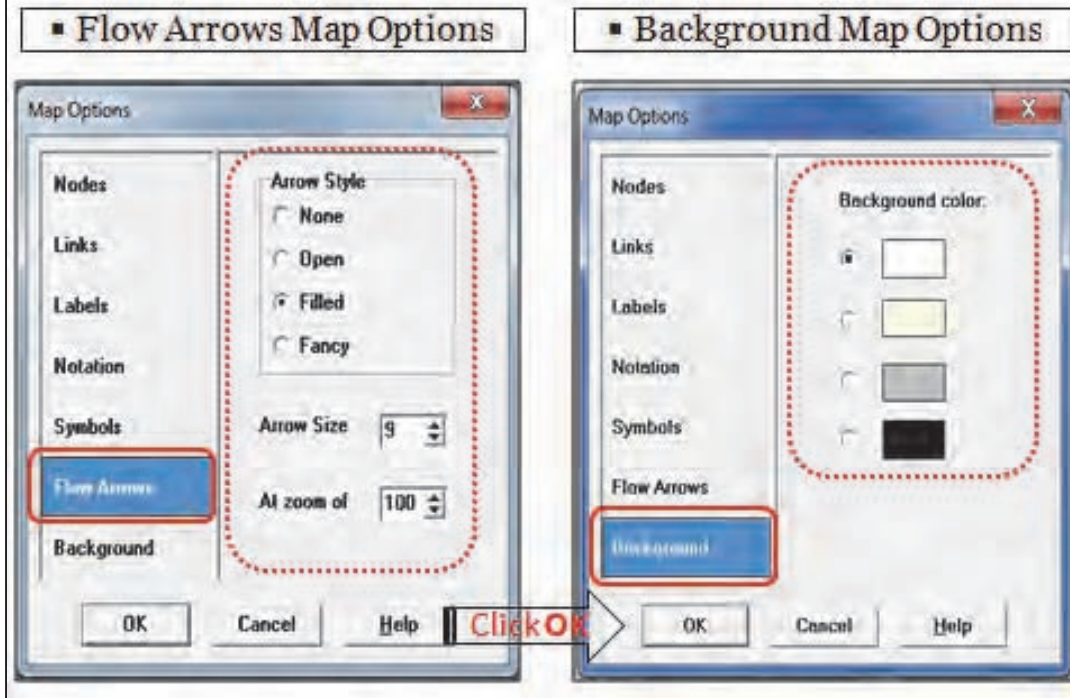
### c. Set Map Options: View >> Options



### c. Set Map Options: View >> Options



### c. Set Map Options: View >> Options




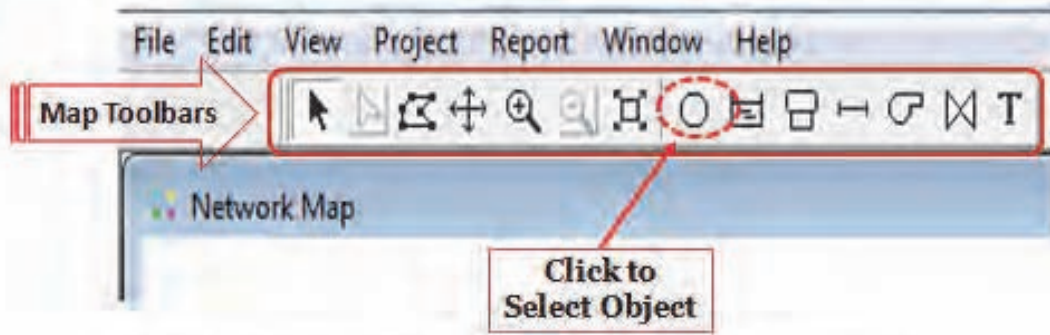
## 3. Create the Project Scenario

- a. Draw the Network
  - Nodes (including reservoirs, tanks)
  - Pipes connecting nodes
  - Pumps
  - Control Valves
- b. Specify Network Properties
  - Nodes {demands, elevations}
  - Pipe properties {L, D, C}
  - Pump Curves {H vs. Q}
- c. Run a Simulation
  - Single period (snapshot) Analysis
- d. Saving and Opening a Project
  - Save As a Project
  - Open a Project



## a. Draw the Network


- We are now ready to begin drawing our network by making use of Buttons contained on the Map Toolbar shown below.
  - Use Object Selection Button 

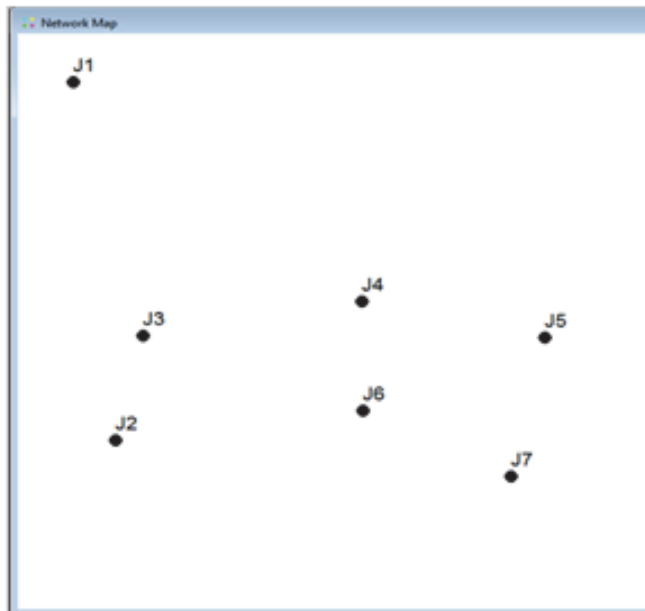


- If the Map Toolbars are not visible then select:  
**View >> Toolbars >> Map**

## a. Draw the Network


### ▪ Adding Junctions

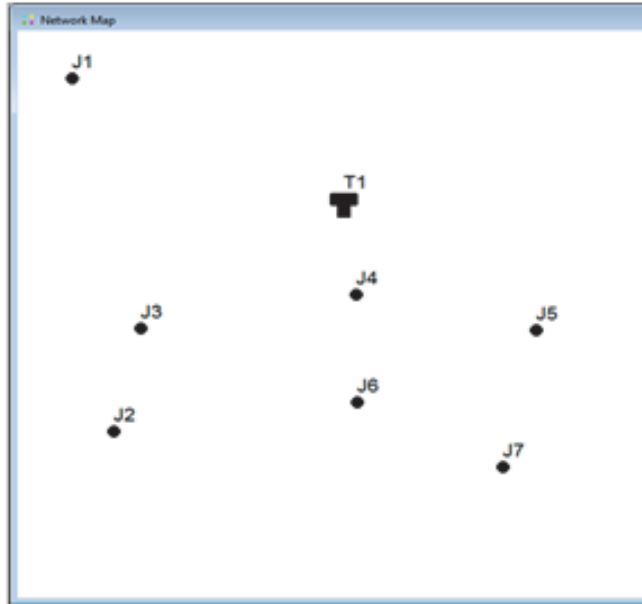
- First, we will add the junction nodes.
- Click the Junction button  and then click on the map at the locations of nodes 1 through 7,
- ALWAYS start a project by putting at least two (2) junctions on the map. You can add all junctions at this time, or add additional junctions later.



## a. Draw the Network


### ▪ Adding Tank

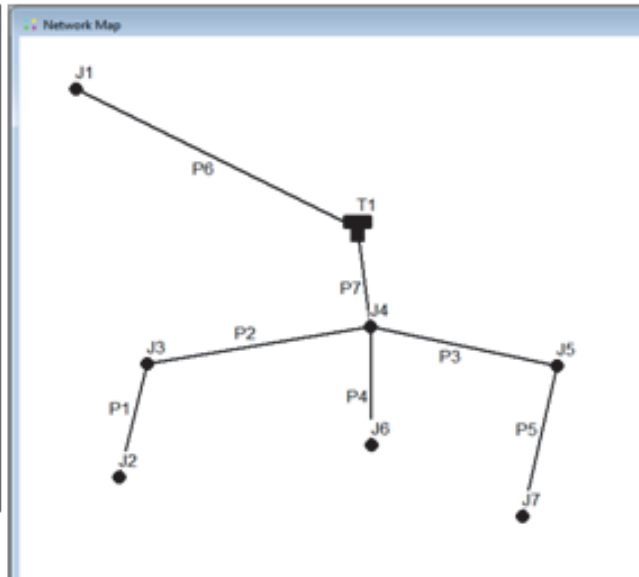
- Finally, add the tank by clicking the **Tank button**  and clicking the map where the tank is located,
- At this point the Network Map should look something like the drawing in attached figure.



## a. Draw the Network:

### ▪ Adding Links

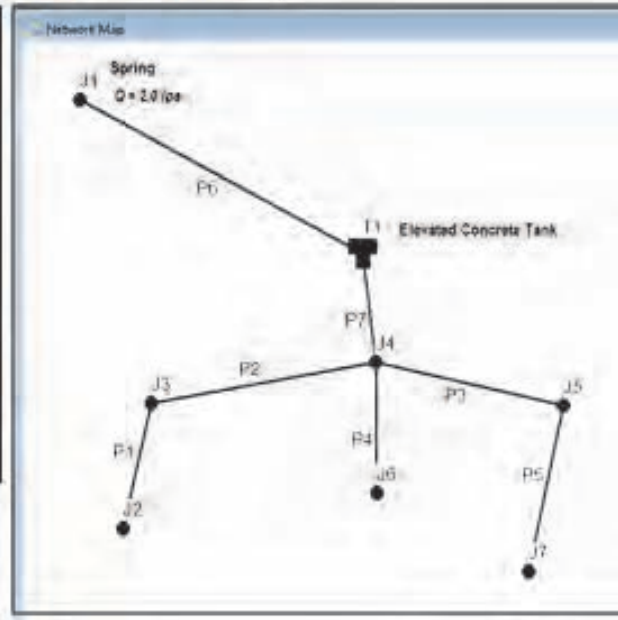
- Next we will add the pipes. Let's begin with **Pipe 1** connecting **J2** to **J3**
- First click the **Pipe button**  on the Map Toolbar
- Then click the mouse on **J2** on the map and then on **J3**
- Repeat this procedure for **Pipes P2** through **P7**



## a. Draw the Network

### ▪ Adding Labels

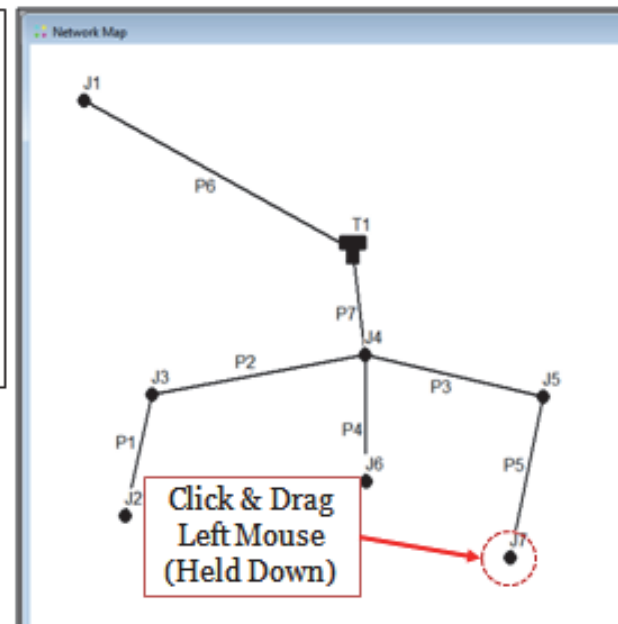
- Next we will label the spring and tank
- Select the **Text** button **T** on the Map Toolbar and click somewhere close to the spring (**Node J1**)
- An edit box will appear. Type in the word **"Spring"** and then hit the **Enter** key.
- Click next to the Tank and enter its label.




## a. Draw the Network

### ▪ Moving an Object

- If the Nodes are out of position you can move them around by clicking the node to select it
- Drag it with the **left mouse button held down** to its new position
- Labels can be repositioned in similar procedure



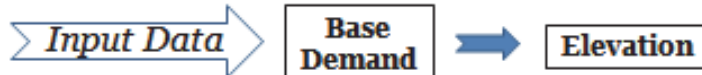
## **b. Specify Network Properties**

- Editing an Object is Adding Information to:
  - Links
  - Nodes
- To select an object on the map using the Select Object button:
  - Click the Select Object button  (Arrow) on the Map Toolbar
  - Double-Click the mouse over the desired object on the map
- To select an object using the Browser:
  - Select the type of object from the Object listbox of the Database Browser
  - Select the desired object from the Item listbox

## **b. Specify Network Properties**

### ▪ Editing Junction Properties:

- The nodes in our example network are assumed to have the following properties:



Network Table - Nodes

Node ID	HHs	Pop1	PF	NRW (%)	Water Demand (lps)		Elevation
					ADD	MDD	m
Junc J1	Spring Source				-2.50		40
Junc J2	14	77	3	30%	0.076	0.099	10
Junc J3	35	193	7	30%	0.191	0.248	11
Junc J4	53	292	11	30%	0.290	0.377	13
Junc J5	67	369	13	30%	0.366	0.476	14
Junc J6	32	176	6	30%	0.175	0.228	12
Junc J7	35	193	7	30%	0.191	0.248	13
Tank1							
<b>Total</b>	<b>236</b>	<b>1300</b>	<b>47</b>		<b>1.289</b>	<b>1.676</b>	

## b. Specify Network Properties

The screenshot shows a software interface for network management. On the left, a network diagram with several nodes and connecting lines is displayed. A red circle highlights a specific node, with a callout box labeled "Double-click to Edit". In the center, a "Junction Property Editor" dialog box is open, showing a table of properties for a selected junction. A red dashed box highlights a row in this table, with a callout box labeled "Double-click to Edit". An arrow labeled "Input Data" points from the network diagram towards the editor. On the right, a "Data Browser" panel is visible, showing a list of data points. A red circle highlights a specific entry, with a callout box labeled "Click to Edit".

## b. Specify Network Properties

### ▪ Editing Tank Property:

- The Tank in our example network is assumed to have the following properties:

*Input Data* →

Tank Node Data :	T1
Tank Bottom Elev. :	18.00
Initial Level :	3.50
Minimum Level :	0.10
Maximum Level :	3.60
Diameter :	4.20



## b. Specify Network Properties

The screenshot shows a software interface for network management. On the left, a network diagram has a node circled in red with a callout box that says "Double-click to Edit". An arrow labeled "Input Data" points from this node to the "Tank Property Editor" window in the center. The "Tank Property Editor" window shows a table of properties for "Tank T1", with a red dashed box around the "Elevation", "Initial Level", "Minimum Level", and "Maximum Level" fields. A callout box "Double-click to Edit" points to the "Elevation" field. On the right, a "Data Browser" window shows a list of tanks, with a red dashed box around a tank entry and a callout box "Click to Edit" pointing to it.

## b. Specify Network Properties

### ▪ Editing Pipe Properties:

- The Pipes in our example network are assumed to have the following properties:

Input Data
Length
Diameter
Roughness

**Network Table - Links**

Link ID	Node Number		Length m	Diameter mm	"C"
	From	To			
Pipe P1	J2	J3	200	50	120
Pipe P2	J3	J4	300	75	120
Pipe P3	J4	J5	250	75	120
Pipe P4	J4	J6	200	75	120
Pipe P5	J5	J7	250	50	120
Pipe P6	J1	T1	3000	100	120
Pipe P7	T1	J4	30	100	120

## b. Specify Network Properties

The screenshot shows a software interface for specifying network properties. It includes a network diagram on the left, a 'Pipe Property Editor' window in the center, and a 'Data Browser' on the right. Red boxes and arrows highlight specific actions: 'Double-click to Edit' on a pipe in the diagram, 'Input Data' arrow pointing to the editor, 'Double-click to Edit' on a pipe in the Data Browser, and 'Click to Edit' on a pipe in the Data Browser.

## b. Specify Network Properties

### ▪ Editing Pipe Properties:

- The Pipes in our example network are assumed to have the following properties:


Input Data
Length
Diameter
Roughness

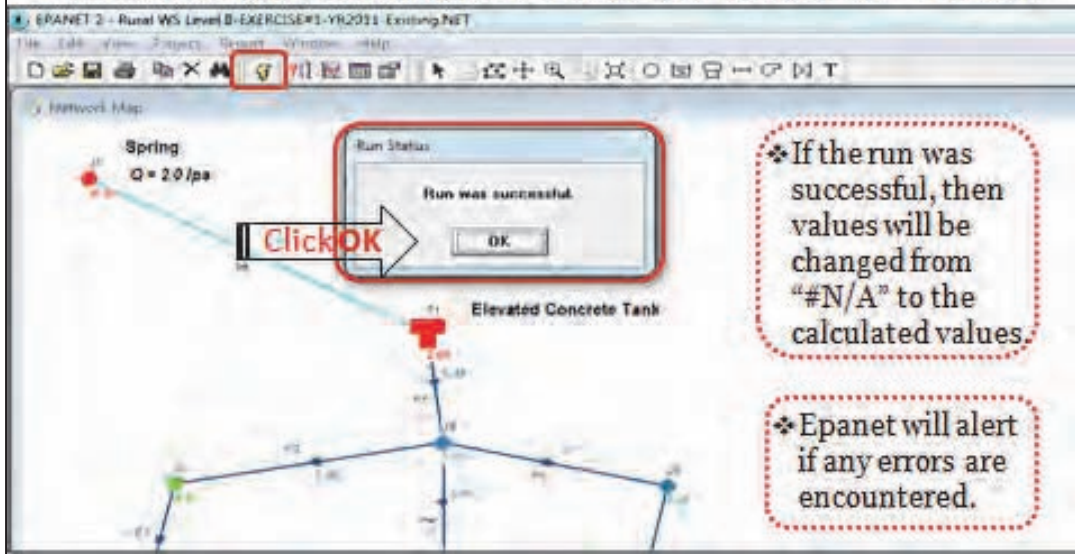
**Network Table - Links**

Link ID	Node Number		Length	Diameter	"C"
	From	To			
Pipe P1	J2	J3	200	50	120
Pipe P2	J3	J4	300	75	120
Pipe P3	J4	J5	250	75	120
Pipe P4	J4	J6	200	75	120
Pipe P5	J5	J7	250	50	120
Pipe P6	J1	T1	3000	100	120
Pipe P7	T1	J4	30	100	120

### c. Run a Simulation

- Run a Single period (steady-state) Analysis

- You now have enough information to run a Single Period (or steady-state) hydraulic analysis
- To run the analysis select Project >> Run Analysis (or click the  button)



❖ If the run was successful, then values will be changed from “#N/A” to the calculated values

❖ Epanet will alert if any errors are encountered.

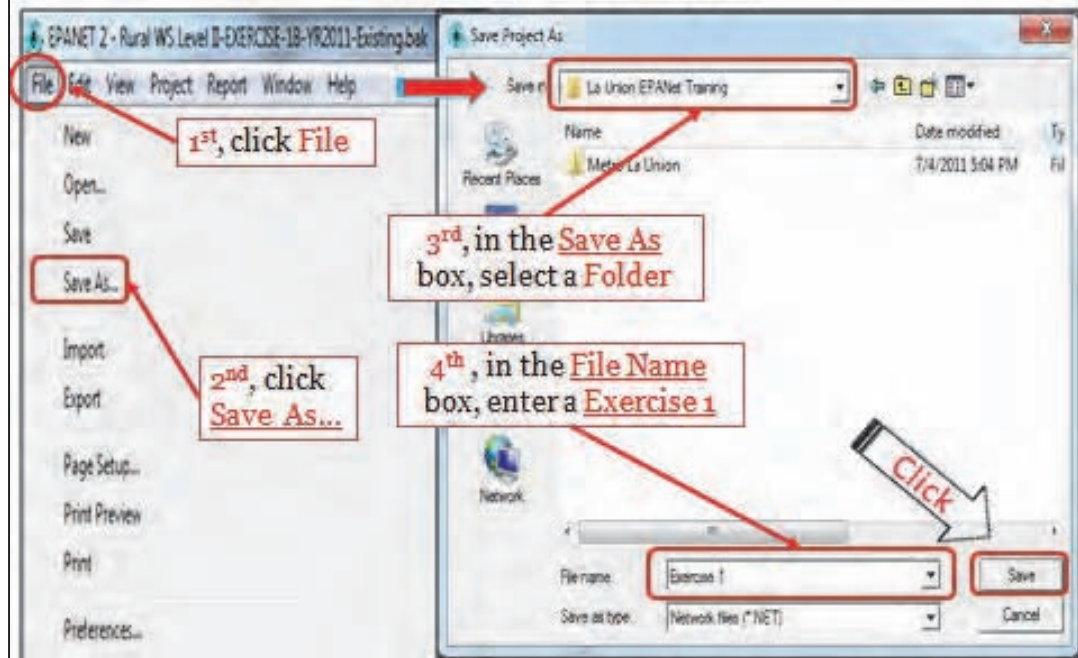
### d. Saving & Opening Project

- Having completed the initial design of our network it is a good idea to save our work to a file at this point
  1. From the File menu select the Save As option
  2. In the Save As dialog that appears, select a folder and file name under which to save this project. We suggest naming the file Exercise 1. (An extension of “.net” will be added to the file name if one is not supplied)
  3. Click Save to save the project to file
- The project data is saved to the file in a special binary format. If you wanted to save the network data to file as readable text, use the File >> Export >> Network command instead
- To open our project at some later time, we would select the Open command from the File menu.




## d. Saving & Opening Project

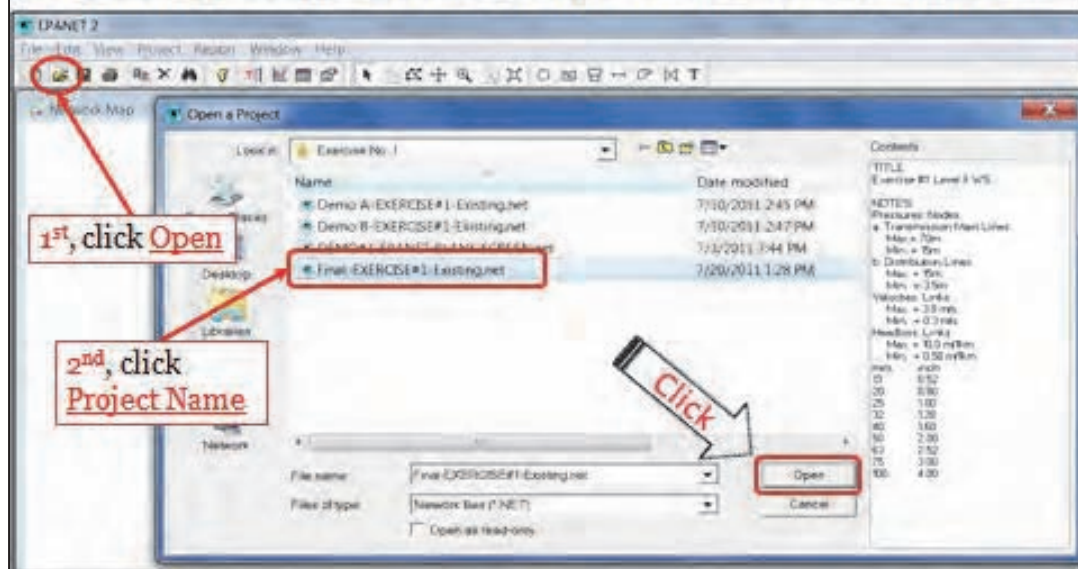
### ▪ Saving As a Project



## d. Saving & Opening Project

### ▪ Opening a Project

- To open our project at some later time, select the Open command from the File menu (File >> Open), or click the Open button  from the map toolbar.



## 4. Analyze a Network

### a. Set Analysis Options

- Create Time Series Analysis
- Create New Demand Patterns
- Assign Demand Patterns

### b. Run Analysis

- Run Extended Period Analysis
- View Extended Period Analysis

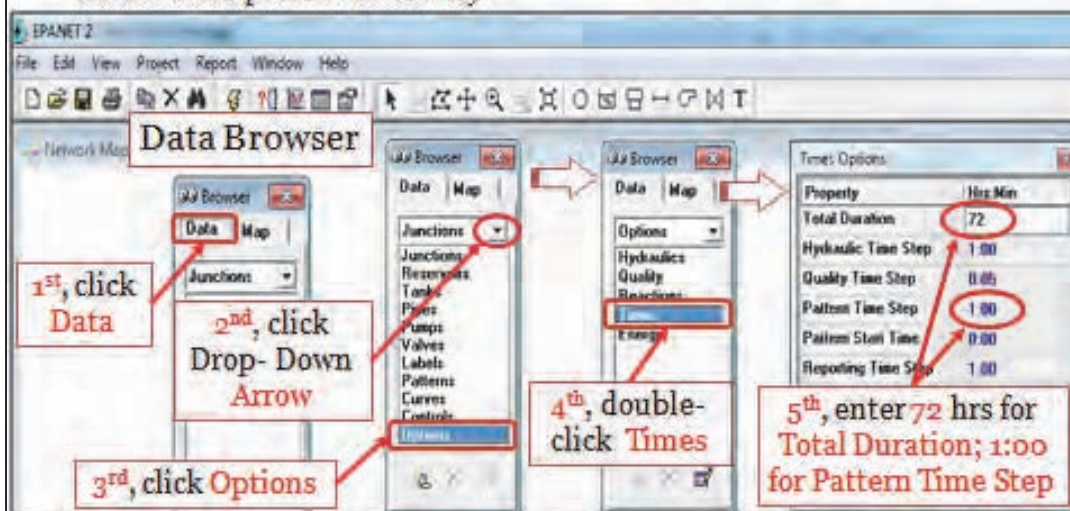
### c. View Results

- View Graphs
- View Tables

### a. Set Analysis Options

#### ▪ Creating a Time Series Analysis

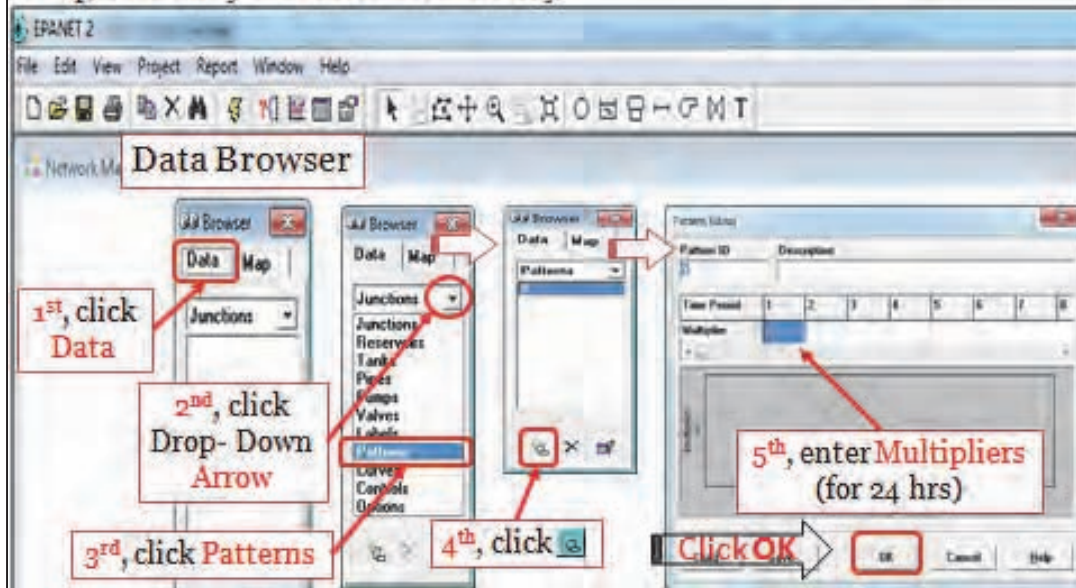
- To make our network more realistic for analyzing an extended period of operation, we will create a Time Series Pattern
- Once the time series is created, it is possible to observe the simulation for different periods of the day



## a. Set Analysis Options

### ▪ Creating New Demand Patterns

- Create Demand Patterns that will make demands at the nodes vary in a periodic way over the course of a day



## a. Set Analysis Options

### ▪ Creating New Demand Patterns

EPANET Pattern No. 1 Data: For Junctions 2 to 7

Small Barangay-Demand Pattern: 2.50 x ADD

Average = 1.00

Time Period	1:00	2:00	3:00	4:00	5:00	6:00	7:00	8:00	9:00	10:00	11:00	12:00
Multiplier	0.20	0.20	0.30	0.50	1.00	2.00	2.50	2.00	1.30	1.00	0.70	1.00
Time Period	13:00	14:00	15:00	16:00	17:00	18:00	19:00	20:00	21:00	22:00	23:00	24:00
Multiplier	0.70	0.50	0.60	1.30	1.90	2.20	1.80	1.00	0.60	0.30	0.20	0.20

EPANET Pattern No. 2 Data: For Spring Water Source

Well Source Supply Pattern: Hrs-24; MDD

Average = 1.00

Time Period	1:00	2:00	3:00	4:00	5:00	6:00	7:00	8:00	9:00	10:00	11:00	12:00
Multiplier	1.00	1.00	1.00	1.00	1.00	1.00	1.00	1.00	1.00	1.00	1.00	1.00
Time Period	13:00	14:00	15:00	16:00	17:00	18:00	19:00	20:00	21:00	22:00	23:00	24:00
Multiplier	1.00	1.00	1.00	1.00	1.00	1.00	1.00	1.00	1.00	1.00	1.00	1.00



## a. Set Analysis Options

### ▪ Creating New Demand Patterns

Typical Water Demand Variation (ADD Ratio)

Typical Water Source Supply Pattern (Spring)

ClickOK

ClickOK

## a. Set Analysis Options

### ▪ Assigning Demand Patterns

- Assign Pattern 1 to the Demand Pattern property of junctions J2 to J7 in our network:

Junction J2 to J7 Property Editor

Data Browser

Double-click to Edit

Double-click to Edit

Click to Edit

Input "1"

Property	Value
Junction ID	J2
X-Coordinate	1617.63
Y-Coordinate	8395.99
Description	100-10
Tag	
Elevation	10
Base Demand	0.115
Demand Pattern	1
Emitter Coeff	
Initial Quality	
Source Quality	
Actual Demand	00/0
Total Head	00/0
Pressure	00/0
Quality	00/0

## a. Set Analysis Options

- Assigning Demand Patterns
- Assign Pattern 2 to the Demand Pattern property of junction J1 in our network:

The screenshot shows the EPANET 2 interface. On the left, a network map displays a junction labeled 'J1'. A red circle highlights 'J1' with an arrow pointing to a text box that says 'Double-click to Edit'. In the center, the 'Junction J1 Property Editor' window is open, showing a table of properties. The 'Demand Pattern' property is highlighted with a red box, and a blue arrow points to it with the text 'Input "2"'. On the right, the 'Data Browser' window shows a list of junctions (J2, J3, J4, J5, J6, J7, J8). Junction 'J1' is selected and highlighted in blue. A red circle highlights the 'J1' entry with an arrow pointing to a text box that says 'Click to Edit'. Another red circle highlights the '2' in the 'Demand Pattern' field with an arrow pointing to a text box that says 'Double-click to Edit'.



## b. Run Analysis: Project >> Run Analysis

- Run an Extended Period Analysis (EPS)
- To run the analysis select Project >> Run Analysis (or click the Run button )

The left screenshot shows the EPANET 2 software interface with the 'Project' menu open. The 'Run Analysis' option is highlighted with a red box. A red arrow points from the 'Run Analysis' option to a text box that says '2<sup>nd</sup>, click Run Analysis'. A red arrow points from the 'Project' menu to a text box that says '1<sup>st</sup>, click Project'. The right screenshot shows the same software interface with the 'Run' button on the toolbar highlighted with a red box. A red arrow points from the 'Run' button to a text box that says 'Click [Run] to Run'.

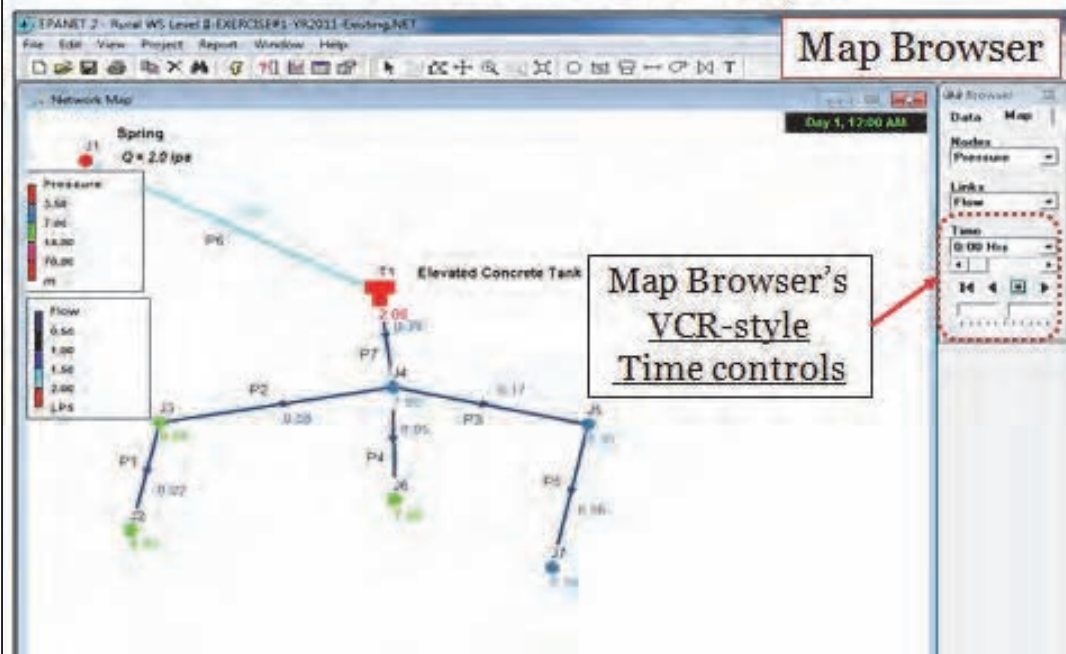
## b. Run Analysis

### ▪ View Results of Extended Period Analysis:

- The scrollbar in the Map Browser's Time controls is used to display the network map at different points in time.
  - select Pressure as the node parameter
  - select Flow as the link parameter
- The VCR-style buttons in the Map Browser can animate the map through time.
  - click the Forward button  to start the animation
  - click the Stop button  to stop it.

## b. Run Analysis

### ▪ View Extended Period Analysis

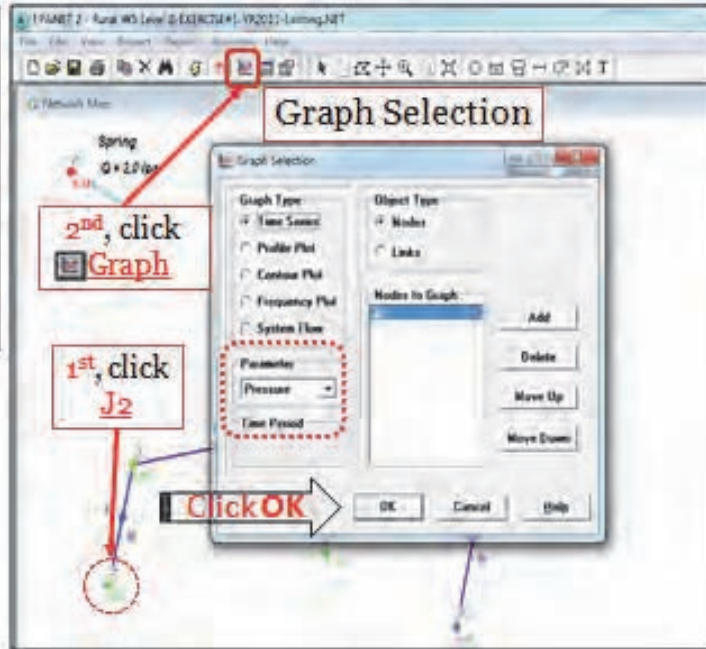




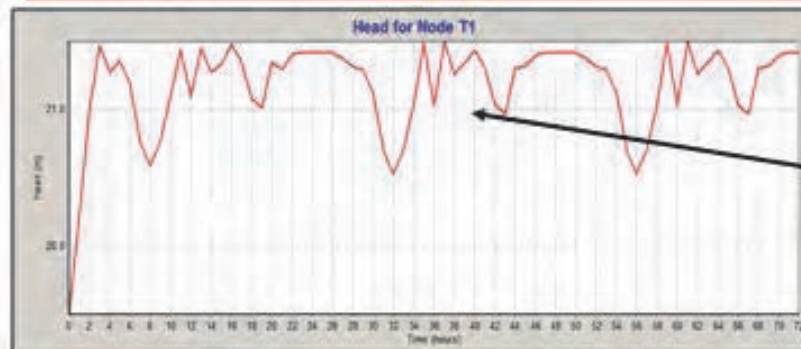
## c. View Results

### View Results - Graphs

- Analysis results can be viewed using several different types of graphs
- Graphs can be printed, copied to the Windows clipboard, or saved as a data file or Windows metafile

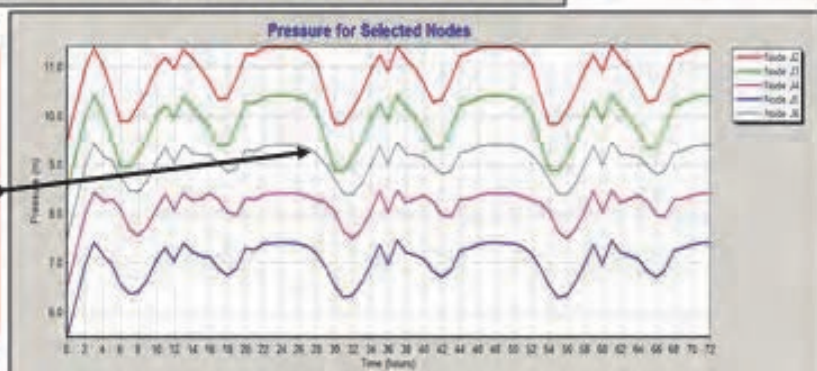


## c. View Results: Graphs



•Note the periodic behavior of the water elevation (head) in the tank **T<sub>1</sub>** over-time (72 hrs)

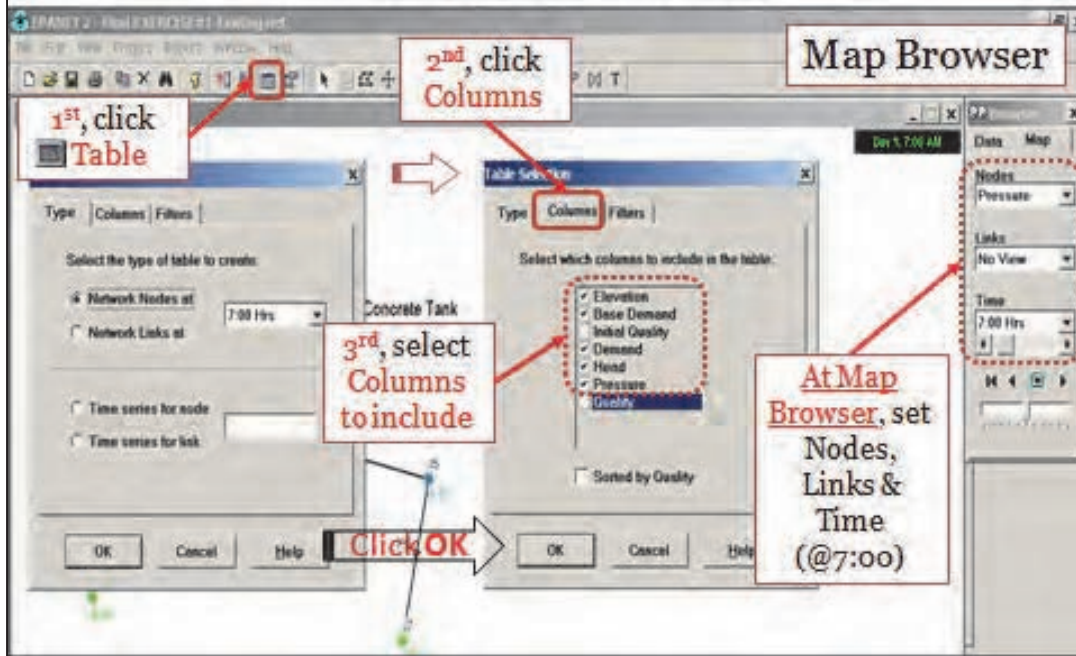
•Note the periodic behavior of the water pressures in Junctions **J<sub>2</sub>**, **J<sub>3</sub>**, **J<sub>4</sub>**, **J<sub>5</sub>** & **J<sub>6</sub>** over time 72 hrs





## c. View Results

### View Results - Tables



## c. View Results: Tables

- EPANET allows you to view selected project data and analysis results in a tabular format
- Tables can be printed, copied to the Windows clipboard, or saved as a data file or Windows metafile
- Network Link sign on flow (+/-) is relative to the way the pipe (link) was initially drawn on the network map

Node ID	Elevation m	Base Demand	Demand LPS	Head m	Pressure m
Junc J2	10	0.071	0.14	19.90	9.90
Junc J3	11	0.179	0.36	19.95	8.95
Junc J4	13	0.270	0.54	20.71	7.71
Junc J5	14	0.342	0.68	20.37	6.37
Junc J1	40	-2.00	-2.00	34.42	-5.58
Junc J7	13	0.179	0.36	20.03	7.03
Junc J6	12	0.163	0.33	20.48	8.48
Tank T1	18	#N/A	-0.41	20.76	2.76

## Annex C

# Design Criteria and Standards

### Demand Projections:

1. Design period: 5 – 10 years
2. Minimum Demand: 0.3 ADD
3. Average Day Demand (ADD):
  - Design Population x per capita consumption/1 - NRW
4. Maximum Day Demand (MDD): 1.3 ADD
5. Peak Hour Demand (PHD):
  - 3 x ADD for < 1,000 served population
  - 2.5 x ADD for > 1,000 served population
6. Non Revenue Water: 15% for a new system
7. Households per public faucet: 4 – 6 HHs

### Per capita Water Consumption:

- Level II: 50 - 60 lpcd
- Level III:
  - Domestic: 80 – 100 lpcd
  - Institutional: 1.0 m<sup>3</sup>/day or actual
  - Commercial: 0.80 m<sup>3</sup>/day or actual

### Design of Pump

- Pump TDH = Depth of Pumping water level + maximum reservoir high water level + friction losses
- Pump Capacity: = Max Day Demand / operating hours

### Design of Reservoirs

- Reservoir Capacity: 25% of ADD

### Design of Distribution System

1. Minimum line pressure = 3 meters
2. Maximum line pressure = 70 meters
3. Maximum velocity of flow in pipes:
  - a. Transmission Line = 3.0 m/s.
  - b. Distribution Pipes = 1.5 m/s

## Annex D

# In-Place Cost of Waterworks Materials and Equipment

(Prices in Philippine Pesos, Manila as of March 2011)

ITEM/DESCRIPTION	SIZE	UNIT	BY CONTRACT IN-PLACE UNIT COST	BY ADMINISTRATION IN-PLACE UNIT COST	
<b>A.Pipelines</b>					
Cost includes fittings, jointing materials, excavation up to 1.20m, pipe bedding, backfill, laying and jointing, warning/detection tapes, concrete thrust blocks, pressure and leakage testing, and disinfection.					
<b>Class 100 Pipe</b>					
200	Pvc	mm	LM	1,315.00	1,118.00
150	Pvc	mm	LM	974.00	828.00
100	Pvc	mm	LM	580.00	493.00
75	Pvc	mm	LM	391.00	332.00
50	Pvc	mm	LM	277.00	235.00
<b>Class 150 without Parallel Pipe</b>					
700	Stl	mm	LM	13,465.00	11,445.00
600	Stl	mm	LM	10,748.00	9,136.00
500	Stl	mm	LM	8,236.00	7,001.00
450	Stl	mm	LM	7,060.00	6,001.00
400	Stl	mm	LM	5,947.00	5,055.00
350	Stl	mm	LM	4,889.00	4,156.00
300	Stl	mm	LM	3,906.00	3,320.00
250	Pvc	mm	LM	2,995.00	2,546.00
200	Pvc	mm	LM	3,090.00	2,627.00
150	Pvc	mm	LM	1,420.00	1,207.00
100	Pvc	mm	LM	1,122.00	954.00
75	Pvc	mm	LM	517.00	439.00
50	Pvc	mm	LM	281.00	239.00
<b>Class 150 with 50 mm Parallel Pipe</b>					
700	Stl	mm	LM	13,747.00	11,685.00
600	Stl	mm	LM	11,033.00	9,378.00
500	Stl	mm	LM	8,552.00	7,269.00
450	Stl	mm	LM	7,342.00	6,241.00
400	Stl	mm	LM	6,229.00	5,295.00
350	Stl	mm	LM	5,174.00	4,398.00
300	Stl	mm	LM	4,187.00	3,559.00
250	Stl	mm	LM	3,276.00	2,785.00

<b>B. Gate Valves</b>					
Cost includes ring flange, gasket, pvc pipe, valve box with cover and concrete cover base.					
300	mm	pc.	39,288.00	27,502.00	
250	mm	pc.	34,614.00	24,230.00	
200	mm	pc.	29,640.00	20,748.00	
150	mm	pc.	25,908.00	18,136.00	
100	mm	pc.	16,278.00	11,395.00	
75	mm	pc.	15,348.00	10,744.00	
50	mm	pc.	11,634.00	8,144.00	
<b>C. Butterfly Valves</b>					
Cost includes ring flange, gasket, pvc pipe, valve box with cover and concrete cover base.					
600	mm	pc.	546,390.00	382,473.00	
500	mm	pc.	326,520.00	228,564.00	
450	mm	pc.	279,612.00	195,728.00	
400	mm	pc.	185,322.00	129,725.00	
350	mm	pc.	141,192.00	98,834.00	
300	mm	pc.	111,780.00	78,246.00	
250	mm	pc.	83,838.00	58,687.00	
<b>D. Fire Hydrant Assemblies</b>					
Cost includes valves, concrete thrust blocks, fittings, concrete base and barricades per standard drawings.					
150	mm	set	47,472.00	33,230.00	
100	mm	set	40,584.00	28,409.00	
75	mm	set	37,206.00	26,044.00	
<b>E. Blow-Off Assemblies</b>					
Cost includes valves, concrete thrust blocks, fittings, concrete base and barricades.					
100	mm	set	32,844.00	22,991.00	
75	mm	set	26,922.00	18,845.00	
50	mm	set	20,352.00	14,246.00	
<b>F. Air Vacuum/ Air Release Valves</b>					
50	mm	pc.	44,772.00	31,340.00	
25	mm	pc.	14,874.00	10,412.00	

<b>G. Service Connections</b>					
Cost includes tapping and installation including service saddle clamps, gate valve, brass coupling, GI elbows and risers two-meter service pipe and necessary earthworks					
<b>Service Pipe 32 mm (1")</b>					
200	mm	set	2,280.00	1,596.00	
150	mm	set	1,716.00	1,201.00	
100	mm	set	1,674.00	1,172.00	
75	mm	set	1,620.00	1,134.00	
<b>Service Pipe 25 mm (3/4")</b>					
200	mm	set	1,950.00	1,365.00	
150	mm	set	1,410.00	987.00	
100	mm	set	1,350.00	945.00	
75	mm	set	1,290.00	903.00	
50	mm	set	1,254.00	878.00	
<b>Service Pipe 20 mm (1/2")</b>					
200	mm	set	1,824.00	1,277.00	
150	mm	set	1,284.00	899.00	
100	mm	set	1,248.00	874.00	
75	mm	set	1,188.00	832.00	
50	mm	set	1,152.00	806.00	
<b>H. Additional Tubing</b>					
Cost includes service pipe and earthwork.					
32 (1")	mm	LM	126.00	88.00	
25 (3/4")	mm	LM	90.00	63.00	
20 (1/2")	mm	LM	85.00	60.00	
<b>I. Pavement Demolition</b>					
Cost includes labor, tools and equipment for pavement demolition and hauling of discarded materials to appropriate dump sites.					
Asphalt Pavement		sq.m.	240.00	168.00	
Concrete Pavement					
= or < 75 mm		sq.m.	258.00	181.00	
75 mm to 150 mm		sq.m.	366.00	256.00	
above 150 mm		sq.m.	654.00	458.00	
Concrete curb & gutter		l.m.	210.00	147.00	

<b>J. Surface Restoration</b>				
Cost includes materials, labor, tools and equipment for pavement construction, surface restoration with base course				
Asphalt Pavement	cu.m.	13,560.00	9,492.00	
Concrete Pavement	cu.m.	6,414.00	4,490.00	
Concrete curb & gutter	l.m.	918.00	643.00	
Concrete Sidewalk/Driveway	cu.m.	6,486.00	4,540.00	
Temporary Resurfacing	cu.m.	1,236.00	865.00	
Sodding (no base course)	sq.m.	138.00	97.00	
<b>K. Over-Excavation for Pipelines</b>				
Cost includes labor, tools and equipment.				
Over 1.2 to 2.0 m	cu.m.	360.00	252.00	
Over 2.0 to 2.5 m	cu.m.	420.00	294.00	
Over 2.5 to 3.0 m	cu.m.	492.00	344.00	
<b>L. Miscellaneous</b>				
Cost includes materials, labor, tools and equipment.				
Sand Bedding/Backfill	cu.m	690.00	483.00	
Crushed Rock Bedding	cu.m	1,074.00	752.00	
Reinforced Concrete Encasement	cu.m	6,828.00	4,780.00	
Concrete Anchor Blocks	cu.m	4,332.00	3,032.00	
Limestone/Coral Excavation	cu.m	918.00	643.00	
Rock/Boulder Excavation	sq.m	840.00	588.00	
<b>M. Pumphouse &amp; Reservoirs</b>				
Cost includes earthworks, concrete works, piping, valves with boxes, metal works, painting and coating, testing and disinfection and minor site development.				
Pumphouse	sq.m	10,200.00	8,670.00	
Elevated Steel Tank	cu.m.	24,000.00	20,400.00	
Concrete Ground Reservoir	cu.m.	10,620.00	9,030.00	
Elevated Concrete Reservoir	cu.m.	21,000.00	17,900.00	

<b>N. Electro-Mechanical Equipment</b>					
Cost includes delivery, installation, concrete foundation, commissioning and testing. For pumps and motors, however, cost includes specified equipment/items only.					
<b>1. Pumping Satations</b>					
<i>A. Electro-Mechanical Equipment</i>					
<i>Submersible Motor/Vertical Motor</i>					
	Lps	HP	KVA		
	3	3	2.2	164,928.00	115,450.00
	5	5	3.7	254,310.00	178,017.00
	8	7.5	5.6	290,520.00	203,364.00
	10	10	7.5	333,870.00	233,709.00
	12	15	11.2	373,794.00	261,656.00
	15	20	14.9	397,842.00	278,489.00
	20	25	18.7	534,414.00	374,090.00
	20	30	22.4	635,562.00	444,893.00
	25	40	29.8	823,356.00	576,349.00
	30	50	37.3	963,180.00	674,226.00
	35	60	44.8	1,280,706.00	896,494.00
	40	75	56	1,558,800.00	1,091,160.00
	50	100	74.6	1,729,692.00	1,210,784.00
Note: For EME, ad costs for valves, production meter, chlorinator, power lines, demand meter, distribution transformer, service pedestals.					
<b>2. Diesel Generating Set</b>					
			KVA		
			25	762,048.00	533,434.00
			30	871,182.00	609,827.00
			40	954,624.00	668,237.00
			50	1,019,910.00	713,937.00
			60	1,102,074.00	771,452.00
			70	1,144,500.00	801,150.00
			80	1,233,252.00	863,276.00
			100	1,448,040.00	1,013,628.00
<b>3. Distribution Transformer &amp; Accessories</b>					
			KVA		
			10	44,508.00	31,156.00
			15	48,990.00	34,293.00
			20	56,580.00	39,606.00
			25	61,410.00	42,987.00
			30	66,930.00	46,851.00
			50	106,428.00	74,500.00



<b>4. Chlorinating Equipment</b>					
A. Gas Chlorinator & Accessories					
i. Vacuum Feed-Type				182,000.00	155,000.00
ii. Pressure Feed-Type				218,880.00	186,050.00
B. Hypochlorinator & Accessories					
				63,000.00	54,000.00
<b>5. Flowmeter (Production Meter)</b>					
Cost includes all fittings and appurtenances per standard drawings					
250	mm	pc.	231,000.00	161,700.00	
200	mm	pc.	153,600.00	107,520.00	
150	mm	pc.	108,000.00	75,600.00	
100	mm	pc.	68,400.00	47,880.00	
75	mm	pc.	50,400.00	35,280.00	
<b>6. Check Valves with Counterweight</b>					
Cost includes all fittings and appurtenances per standard drawings					
250	mm	pc.	71,928.00	50,350.00	
200	mm	pc.	59,010.00	41,307.00	
150	mm	pc.	40,626.00	28,438.00	
100	mm	pc.	17,250.00	12,075.00	
75	mm	pc.	12,324.00	8,627.00	

## References

1. Ainsworth, R. (Ed.). (2004). *Safe Piped Water: Managing Microbial Water Quality in Piped Distribution Systems*. World Health Organization (WHO); IWA Publishing.
2. American Ground Water Trust. (n.d.). Retrieved from American Ground Water Trust Web Site: <http://www.agwt.org>
3. American Water Works Association. (1986). *Principles and Practices of Water Supply Operations (Vol. 3): Introduction to Water Distribution*. AWWA.
4. Bentley Institute. (2008). *Bentley WaterCAD/GEMS V8i; Water Distribution Design and Modeling*. Bentley Systems, Inc.
5. Cooke, R. (n.d.). *Chlorination Equipment*. (Mountain Empire Community College, Virginia) Retrieved from Water/Wastewater Distance Learning Website: <http://water.me.vccs.edu/concepts/chlorequipment.html>
6. Department of Agrarian Reform. (2009). *Implementing Manual-Potable Water Supply Development Component*. Agrarian Reform Infrastructure Support Project (ARISP), DAR.
7. Department of Health. (2007, March 9). *Philippine National Standards for Drinking Water (Administrative Order No. 2007-0012)*. DOH.
8. Department of the Interior and Local Government, NJS Consultants, CEST, Inc., & TEST Consultants, Inc. (2007). *Upgrading Guidelines: Rural Water Supply and Sanitation Project Phase V*. DILG.
9. Faust, R. W. (2007). *The Hydraulic Principles of Water Supply Systems*. PDH Center.
10. Hardie Iplex Pipeline Systems. (1993). *uPVC Pipelines Design Textbook*. Hardie Iplex Pipeline Systems.
11. Hart, W. (2003). *Protective Structures For Springs: Spring Box Design, Construction and Maintenance*. School of Forest Resources & Environmental Science, Michigan Technological University.
12. Harter, T. (n.d.). (University of California, Davis) Retrieved from UC Groundwater Cooperative Extension Program Web Site: <http://groundwater.ucdavis.edu>
13. Hofkes, E.H., Huisman, L., & International Reference Centre for Community Water Supply and Sanitation. (1983). *Small Community Water Supplies: Technology of Small Water Supply Systems in Developing Countries*. International Reference Centre for Community Water Supply and Sanitation.
14. Landscapes For Life. (n.d.). Retrieved from Landscape for Life: <http://landscapeforlife.org/>

15. Local Water Utilities Administration. (1975). *Inspector's Construction Manual*. LWUA.
16. Local Water Utilities Administration, & Motor Columbus Consulting Engineers, Inc. (1981). *Methodology Manual*. LWUA.
17. McGhee, T. J. (1991). *Water Supply and Sewerage*. McGraw Hill.
18. National Water Resources Council. (1979, March). *Rural Water Supply: Design Manual, Volume 1*. NWRC.
19. Pucell, P. (2003). *Design of Water Resources Systems*. Thomas Telford Ltd.
20. PWWA Conference Proceedings. (2009). *Philwater 2009 Proceedings*. Philippine Water Works Association.
21. Rossman, L. A. (2000). *EPANET 2 Users Manual*. United States Environmental Protection Agency.
22. Rubin, J. (n.d.). *Water Cycle Experiments*. Retrieved from Science Fair Projects and Experiments:  
<http://www.julianrubin.com/encyclopedia/earthsciences/watercycle.html>
23. Stiftsbogtrykkerie, A., Grundfos International, Jensen, H. L., & Grundfos International Education Centre. (1988). *Domestic Water Supply*. Grundfos International Education Centre.
24. Swamee, P., & Sharma, A. (2008). *Design of Water Supply Pipe Networks*. John Wiley & Sons, Inc.







**THE WORLD BANK OFFICE MANILA**

23rd Floor, The Taipan Place  
F. Ortigas Jr. Road, Ortigas Center  
1605 Pasig City, Metro Manila, Philippines