

Author: Pier Giorgio Nembrini

**WATER,
SANITATION,
HYGIENE
AND HABITAT
IN
PRISONS**



ICRC

International Committee of the Red Cross
19 Avenue de la Paix, 1202 Geneva, Switzerland
T +41 22 734 6001 F +41 22 733 2057
E-mail: icrc.gva@icrc.org www.icrc.org

© ICRC, August 2005



Author:

Pier Giorgio Nembrini

Project leader:

Riccardo Conti

Drawings:

François Rueff

Pier Giorgio Nembrini

Contributions from:

Annette Corbaz

Pascal Daudin

Acknowledgements:

Rowena Binz

Frank Bouvet

Pierre Corthésy

Yves Etienne

Carmen García

Pascal Jansen

Patrick Kilchenmann

Robert Mardini

Alain Mourey

Alain Oppliger

Alfred Petters[†]

Philippe Rey

Hernán Reyes

Stefan Spang

Jean Vergain

Cynthia Wallace

Aloys Widmer

Renée Zellweger-Monin

and all the engineers
and technicians who
have worked in prisons.

Contents

Foreword	9
Introduction	10
Dilapidated and unsuitable premises	10
Funding inadequate to meet needs	10
The need for a global approach	11
Subjects covered in this handbook	11
1. Habitat: space and quarters	13
1. 1 Architecture of a prison	14
1. 2 Plans and dimensions of a prison	15
1. 3 Living quarters and capacity	16
Capacity and calculation of occupancy rate	17
Measurement of area to determine occupancy rate	17
Weighting of occupancy rate	18
Total space available for accommodation	19
Floor space per detainee or true occupancy rate	19
1. 4 Bedding	21
Bunk beds	22
1. 5 Ventilation and lighting	23
Ventilation	23
Lighting	25
1. 6 Synoptic table	25
2. Water: water supply and hygiene measures	27
2. 1 Introduction	28
2. 2 Water supply and distribution	28
Storage and distribution systems	28
Assessment of water supply	29

	Amount of water that enters the prison	30
	Distribution of water consumption in the prison	34
	Minimum amounts of water available for detainees: recommendations	34
	Assessment of amounts of water available to detainees	35
	A technical matter: taps	35
	Storing water in cells and dormitories	36
	Improving detainees' access to water: general measures	37
	Rainwater harvesting	37
	Water supply from a well	39
	Deepening a well	40
	Emergency water distributions	42
	Emergency installations	42
2. 3	Personal hygiene	44
	Amount of water and equipment needed	44
	Sources of energy for heating water	45
	Measures for maintaining personal hygiene	47
2. 4	Disinfection of water	47
	Disinfectants	48
	Approximate cost of disinfection and advantages of HTH	49
	Inspection and disinfection of water storage tanks	51
	Disinfection of wells	52
	Disinfection of drinking water	53
	Measuring free residual chlorine	55
2. 5	Synoptic table	56
3.	Sanitation and hygiene	57
3. 1	Waste water and refuse disposal	58
	Quantity of waste generated	59
	Amounts of water necessary for waste-disposal systems	59
3. 2	Latrines	59
	Types of latrines	59
	Flush latrines	61
	Pour-flush latrines	62
	Dry pit latrines	62

	Ventilated improved pit latrines	64
	Intermittent flush latrines	64
	Dimension and slope of drainpipes	66
	Inspection hatches	66
	Latrine maintenance	67
	Urinals	68
	Soil buckets or sanitary pails	69
	Material for anal cleansing	69
3. 3	Septic tanks	70
	Calculating the capacity of a septic tank	71
	Principles to be observed in calculating the dimensions of a septic tank	72
	Practical tips	73
	Regular inspection	74
	Desludging a septic tank	77
	Manual desludging	77
	Disposal of effluent from septic tanks	79
	Infiltration capacity of the soil	79
	Soak pits	82
	Infiltration (or drainage) trenches	83
	Variants	85
	Stabilization ponds (lagooning)	86
	Facultative ponds	86
	Maturation ponds	87
3. 4	Refuse disposal	88
	Sorting and treatment of refuse	88
	Organization of refuse disposal	90
3. 5	Synoptic table	92
4.	Kitchens: design, energy and hygiene	93
4. 1	Introduction	94
4. 2	Kitchen layout and fittings	94
	Location	94
	Roofed area	94
	Essential infrastructure	96
	Drainage and disposal of waste water	97

	Lighting, ventilation and smoke extraction	98
	Number of stoves and capacity of cooking pots	98
	Utensils	99
	Food storage	100
4. 3	Different types of energy	101
	Wood and wood seasoning	101
	Other sources of energy	103
4. 4	Energy-saving techniques: improved stoves	104
4. 5	General kitchen hygiene	107
	Indispensable hygiene measures	107
	Cleaning and disinfection of kitchen and cooking utensils	108
4. 6	Synoptic table	108
5.	Vectors of disease and vector control	109
5. 1	The main vectors and control measures	110
	Definition of a vector	110
	Knowing the vector's life cycle and habitat	111
	Principles common to vector-control programmes	111
	The main vectors in the prison environment and control measures	112
5. 2	Combating the main vectors with insecticides	119
	Types of insecticide which may be used in prisons	119
	Formulations	120
	Residual effect	121
	Resistance to insecticides	121
	Insecticides used in the prison environment	122
5. 3	Implementation of a vector-control programme	122
	Spraying of walls, bedding and surfaces	122
	Calculating the quantity of insecticide needed	123
	Organization of spraying operations	125
	Spraying equipment	127
	Mosquito nets	129

Annex 1

Check list for evaluating environmental engineering problems and their effects on health 131

Need to take a global view of the problems 131

The check list and evaluation criteria 131

Prison questionnaire 132

Analysis of the results of the questionnaire 136

Evaluating a group of prisons 137

Annex 2

Example of price specifications for construction of a 50-m³ water reservoir 139

Annex 3

Estimates for materials and labour 142

Annex 4

Biogas sanitation system 143

Special features of biogas systems as compared with septic tanks 143

Technology adopted 143

Performance 145

Notes 146

Bibliography 147

Foreword

Ever since 1915 the International Committee of the Red Cross (ICRC), acting on the basis of international humanitarian law, has been devising and conducting activities for the protection of prisoners, detainees and internees held in connection with international and non-international armed conflicts and other situations of violence. By means of repeated visits to places of detention, ICRC delegates monitor the conditions of detention of persons deprived of their freedom.

For the ICRC, the term “conditions of detention” encompasses the degree of respect for the detainees’ physical and mental integrity shown by the whole range of personnel in charge of their lives in detention; material conditions of detention (food, accommodation, hygiene); access to health care; and possibilities for maintaining family and social relationships, for engaging in a minimum of physical exercise and leisure activities, for working and for receiving vocational training.

The ICRC’s monitoring of the conditions of detention and the treatment of persons deprived of their freedom is carried out with the agreement of and in cooperation with the authorities concerned. The ICRC keeps the authorities regularly informed, on a confidential basis, of its findings. When the detainees’ physical and mental integrity and/or dignity is under threat, it asks the authorities to take remedial action so as to ensure that the conditions of detention are consistent with the spirit of the relevant international legislation.

The main features of the action taken by the ICRC are as follows:

- Assessment of conditions of detention by means of tried and tested methods which guarantee maximum objectivity in the analysis of problems and their causes.
- Drawing up of practical recommendations that take account of economic conditions and local customs in the country concerned.
- A long-term approach and regular dialogue with all the relevant authorities, at all levels of the hierarchy.
- Individual monitoring of particularly vulnerable detainees.
- Where there are serious and urgent needs, provision of material and technical assistance for the benefit of the detainees, with the participation of the relevant authorities.

In places of enforced confinement such as prisons and other places of detention, access to basic necessities and a salubrious environment are of the utmost importance for ensuring that the inmates remain in good health.

In developing countries, and especially in crisis situations, health conditions in places of detention are often unsatisfactory and sometimes deplorable. ICRC engineers work in many very different contexts to remedy such situations. They have thus acquired, over the past two decades, specific expertise in the area of environmental engineering in places of detention.

This handbook offers a summary of the practical experience gained. It is not intended to provide answers to all problems relating to material conditions of detention, for such problems have to be approached also from the angle of the organization of prison administrations and of the management of prisons and other places of detention, matters which are outside its purview.

The ICRC hopes that this handbook will contribute to the improvement of conditions of detention for persons deprived of their freedom and enhance compliance with international legislation in that domain.

Introduction

Measures depriving persons of their freedom must in no way, whatever the circumstances, be made more severe by treatment or material conditions of detention which undermine the dignity and the rights of the individual.

Observance of this fundamental principle requires appropriate material structures, financial resources and staff trained in accordance with strict professional ethics. In practice, however, prison administrations are usually the poor relations in State administrative systems. This is particularly the case in developing countries, which have to cope with a chronic shortage of both financial and human resources, and which lack the professional skills necessary for the proper running of a prison administration.

These constraints, together with the poor view taken generally of delinquents and criminals – or people supposed to be such – mean that the task of prison administrations is an especially difficult and thankless one.

Needless to say, in this type of environment conditions of detention are rarely consistent with international standards. They are often very precarious, and sometimes appalling; and as a result morbidity and mortality rates among prison inmates are higher than in the population from which they come.

Dilapidated and unsuitable premises

In developing countries, prison buildings are usually dilapidated and many of them are materially unsuited for the confinement of large numbers of individuals on a permanent basis.

The capacity of places of detention tends to decline over time because the buildings are not properly maintained, while at the same time the number of inmates tends to grow, especially in urban centres. Economic and sometimes political crises trigger an increase in arrests, and the legal system is incapable of dealing with all the cases brought before it within a reasonable period of time.

A combination of these factors often results in overpopulation in the prisons.

The capacity of prisons as defined when they were built is seldom respected. The supernumerary detainees are sometimes literally crammed into the existing cells or dormitories, or even into rooms intended for other purposes, such as workshops and storerooms. In extreme cases, makeshift shelters are set up in corridors and exercise yards.

When the number of detainees exceeds a prison's capacity, or when a prison has been enlarged, the need to adapt essential services accordingly is rarely taken into account. As a result, the water-supply system and the capacity of the kitchens and sanitary facilities are no longer sufficient to meet the needs of the entire prison population. When essential services (water, meals, hygiene) break down, the detainees risk serious health problems.

And when health conditions are really appalling, the prison staff and even people living near the prison may suffer the consequences.

Funding inadequate to meet needs

The financial resources of prison administrations have always been limited. Chronic economic crises, and sometimes devaluation of the currency, further aggravate the situation, while at the same time the number of detainees who have to be catered for tends to increase. In many cases the budget allocated by the State is insufficient to cover the detainees' needs in terms of food and medical care.

In such circumstances building maintenance is often limited to security aspects, while the infrastructure slowly crumbles. Roofs leak, cells and dormitories are abandoned “for security reasons”: all factors which have an adverse effect on general living conditions.

The need for a global approach

Despite the constraints described above, it is possible, even with limited funds, to maintain or renovate decaying infrastructure and even to make significant improvements. The first step is to carry out a careful inventory of the existing situation, to identify and analyse the main problems, and to define the measures that need to be taken and the most urgent work to be done.

Although the different subjects covered in this handbook are dealt with in separate chapters, they are closely interdependent. For example, it would be futile to plan a water-supply system without planning for the disposal of waste water, or to opt for a sewage-disposal system without ensuring that it is compatible with the sewerage system of the area in which the prison is located.

Similarly, overpopulation in a prison gives rise to problems in terms of access to water, hygiene and public health which go beyond the question of the space available to accommodate the detainees.

Overpopulation also has an adverse effect on the detainees' daily lives, and often on the way in which they are managed and treated by prison staff.

It is therefore essential that problems be analysed from an overall perspective. This will avoid situations in which measures taken to deal with a single problem might give rise to difficulties in other areas of the detainees' daily lives.

Subjects covered in this handbook

The handbook deals with the following matters:

Habitat

The prison and its premises
The detainees' living quarters
Management of the prison population in terms of accommodation

Water

Water supply and distribution
Cleanliness and disinfection

Sanitation

Evacuation of waste water
Hygiene in prisons

Kitchens

Design and fittings
Sources of energy

Vectors of disease

Identification of the vectors that spread disease, and vector-control measures



The action it proposes takes the following factors into account:

- the level of expertise required;
- identification of measures that can be taken and supervised autonomously by the prison authorities;
- the optimum cost-effectiveness ratio;
- the resources – usually limited – available to the detaining authorities for following up the action taken.

Lastly, it describes concrete and exceptional measures for dealing with acute problems generated by crisis situations.

A large number of illustrations and figures are included to make the text easier to understand.

This handbook is the fruit of the experience of the author and of the ICRC's engineers in managing the environmental engineering problems (water supply, sewage and waste disposal, food preparation, vector control, general hygiene and health) which they have encountered and often resolved in a large number of prisons.

It is not intended for engineers and for professionals in other areas who are called upon to work in prisons. These may at most find some useful tips in the various chapters, most of them based on concepts and practices in use in the developed world and adapted to tropical and economically weak countries. The handbook is intended for all those who work in prisons without being specialists in the domain. It should improve the ability of prison authorities and others in positions of responsibility to identify and analyse the nature and origin of problems in the area of environmental engineering and to grasp their complexity, and thus help those authorities to draw up precise and realistic proposals for submission to the relevant government departments, and perhaps to potential donors.

The content of this handbook reflects the opinions of the author and not necessarily those of the International Committee of the Red Cross.

1. Habitat: space and quarters

1. 1	Architecture of a prison	14
1. 2	Plans and dimensions of a prison	15
1. 3	Living quarters and capacity	16
	Capacity and calculation of occupancy rate	17
	Measurement of area to determine occupancy rate	17
	Weighting of occupancy rate	18
	Total space available for accommodation	19
	Floor space per detainee or true occupancy rate	19
1. 4	Bedding	21
	Bunk beds	22
1. 5	Ventilation and lighting	23
	Ventilation	23
	Lighting	25
1. 6	Synoptic table	25

1. 1 Architecture of a prison

Prisons may be very different in terms of their architecture, but they all comprise a range of similar basic structures designed to meet the material needs of the detainees:

- buildings containing cells and dormitories for housing the inmates;
- kitchens and refectories;
- sanitary installations for maintaining personal hygiene: toilets and showers, and in some cases laundry facilities;
- areas for spending time outdoors and taking physical exercise.

Access to and use of these places which are the scene of life in detention are subject to more or less strict regulations, for both detainees and anyone coming in from outside. The perimeter formed by the limits of the entire complex of structures which are under surveillance and **within which** the movements of individuals are controlled is designated in this handbook by the term “**internal security perimeter**”.

A prison will usually comprise other integral structures:

- a dispensary;
- visiting rooms or other places where detainees can meet their families;
- the offices of the prison administration;
- the guards' quarters;
- storerooms;
- workshops;
- a classroom;
- a library;
- a sports ground.

For reasons of security – in particular that of the prison staff – these premises are usually situated **outside the internal security perimeter**, and are separated from the inner prison by at least a metal door or gate.

Places of worship and workshops for the detainees may be either inside or outside the internal security perimeter.

To prevent escape and to ensure security in the prison, there may be one or several walls or fences around the prison building or buildings.

The prison compound may extend beyond the perimeter walls. This adjacent area, whether enclosed or otherwise, is designated in this handbook by the term “**external security perimeter**”.

These different concepts are illustrated in **Figure 1**.

Figure 1
External and internal
perimeters of a prison

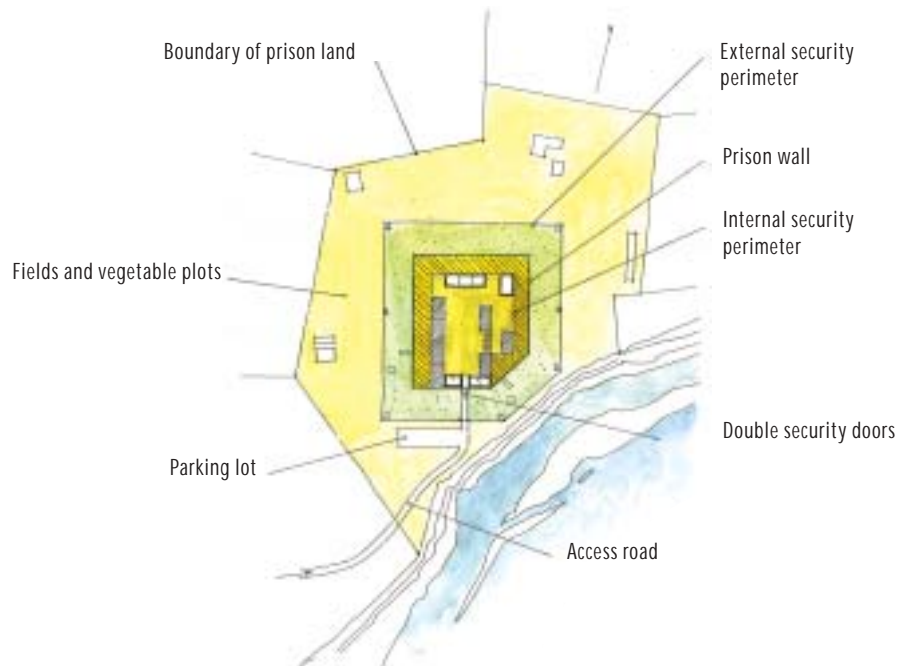

1. 2 Plans and dimensions of a prison

Figure 2 shows the plan of a typical (fictitious) small prison¹ comprising the facilities and areas described above. The architecture of this prison is simple, and the plans of its component parts will serve to illustrate the various subjects covered.

Figure 2
Plan of a prison

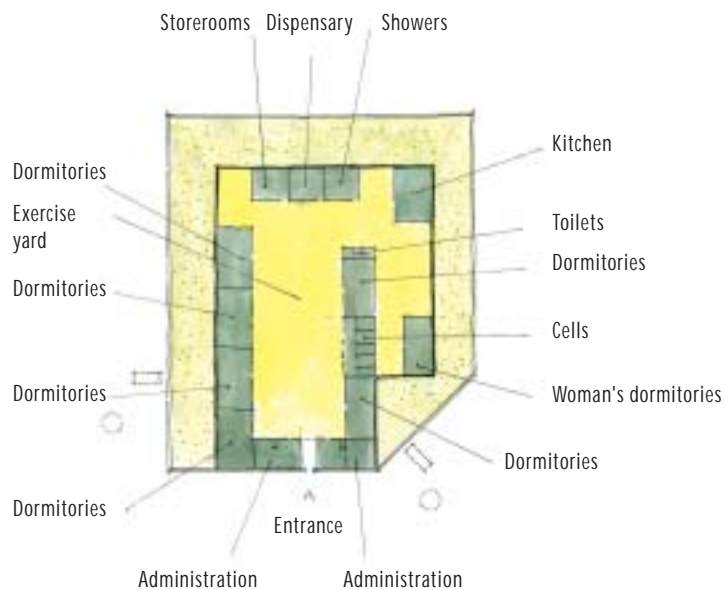
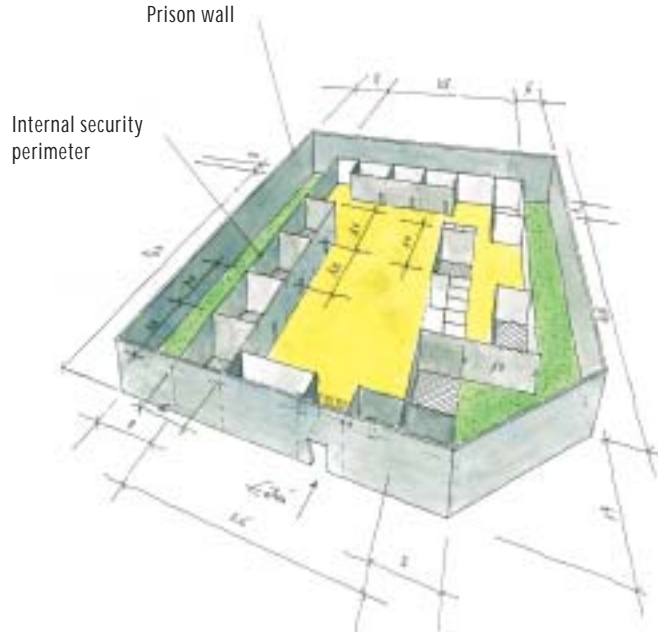

Figure 3 shows the same fictitious prison. This three-dimensional view is used in most of the illustrations in this handbook.

Figure 3
Prison seen
in perspective



1.3 Living quarters and capacity

The detainees' **living quarters** are cells, intended to accommodate one or several persons, and dormitories. The detainees are locked in at night and for more or less long periods of the day.

*The United Nations Standard Minimum Rules for the Treatment of Prisoners*² stipulate in Rule 10, under the heading "Accommodation": "All accommodation provided for the use of prisoners and in particular all sleeping accommodation shall meet all requirements of health, due regard being paid to climatic conditions and particularly to cubic content of air, minimum floor space, lighting, heating and ventilation".

The Standard Minimum Rules, being designed to apply in widely varying situations, are deliberately worded as general principles which must be translated into more detailed rules in national or regional legislation or prison regulations.³

An example of this can be found in the work of NACRO⁴ (National Association for the Care and Resettlement of Offenders), a British organization which has laid down quite specific standards for the dimensions of places of detention and for hygiene, water supplies and sewage disposal.

The NACRO rules were drawn up on the basis of the following considerations:

- the possibility of carrying out objective and quantifiable measurements;
- the existence of statutory rules, recommendations or articles relating to accommodation in prisons and other public facilities.

These, too, are only minimum rules which may be further developed.

For the construction of new prisons, the minimum floor space recommended is 5.4 m² per detainee, whether he* is alone in the cell or shares it with another person.

The minimum distance between the cell walls must be 2.15 m and the ceiling must be at least 2.45 m high.

Finally, the rules specify that every detainee should be allowed to spend at least 10 hours out of 24 outside his cell or dormitory, not counting the time needed to use the sanitary facilities (when these are not in the cell) or the period set aside for physical exercise.

The advantage of this method is that it takes into consideration both the space available to the detainee in his cell and the length of time he spends there. If detainees are allowed to go out into the exercise yard for several hours or to engage in activities in other parts of the establishment, they will find it easier to bear the periods spent in the confined space of their cells.

When the same cell or dormitory is occupied by several people, other matters have to be taken into consideration. For example, there will be increased needs in terms of:

- ventilation;
- lighting (intensity);
- the inmates' hygiene (personal hygiene and clothing).

Capacity and calculation of occupancy rate

To gain an overall idea of whether the detainees' quarters in a prison are adequate, two parameters are considered: **capacity and occupancy rate**.

The **capacity** of a prison is the total number of detainees that it can accommodate while respecting minimum requirements, specified beforehand, in terms of floor space per inmate or group of inmates.

The ability of the prison's various services to meet the needs of all the detainees under their responsibility must also be taken into account.

When the prison is built, individual or collective floor space is determined according to standards set by the prison administration or those applied to other forms of public housing. Such standards vary from one country to another.⁵

When prison buildings are old, prison administrations are not always able to give figures for the floor space allocated to each inmate or group of inmates. However, the official capacity of prisons at the time of construction is usually known.

The **occupancy rate**, also known as the population density in the prison, is determined by calculating the ratio of the number of detainees present at date "t" to the number of places specified by the prison's official capacity.

$$\text{Occupancy rate} = \frac{\text{Number of detainees present at date "t"}}{\text{Number of detainees specified by the official capacity}} \times 100$$

When the ratio obtained exceeds 100 (100 detainees per 100 places), the situation is one of overpopulation or "overoccupancy". Conversely, if the figure is lower than 100, the prison is "underoccupied".⁶

Measurement of area to determine occupancy rate

Prison administrations usually have block plans of their prisons. When this is not the case, such plans must be drawn up to allow rapid visualization of the location and dimensions of different structures and areas.

Figure 4 shows, in diagrammatic form, how the areas available to persons detained within the internal security perimeter are calculated, and Box No. 1 shows how to determine the occupancy rate.⁷

Figure 4
Calculation of
occupancy rate

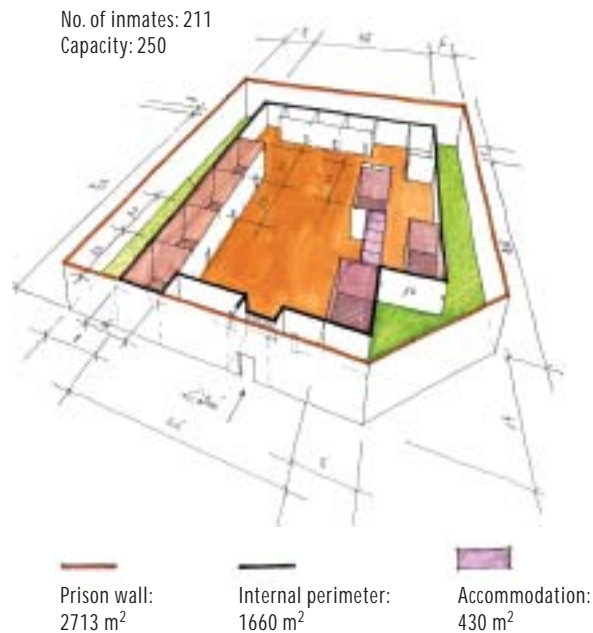

Box No. 1

Calculation of occupancy rate

Figures for the fictitious prison shown in Figure 4

Number of detainees: 211

Official capacity of prison: 150

$$\text{Occupancy rate: } \frac{211}{150} \times 100 = 140\%$$

Rate of overpopulation: 40%

Total floor area of living quarters: 400 m²

Average floor space per detainee: 1.9 m²

Space accessible to the detainees within the internal perimeter: 1.660 m²

Total space available per person within the internal perimeter: 7.86 m²

Average space per detainee

(space within the internal perimeter minus space occupied by administrative services): 7 m²

Weighting of occupancy rate

The occupancy rate is a general **indicator** of compliance with the accommodation capacity of a prison. As such, it gives no precise information as to the conditions in which the detainees are housed, or as to the gravity of the problems that might affect them if the official capacity is not respected or is overestimated.

When the prison capacity is greatly exceeded (overpopulation), the detainees' living conditions are usually problematical. But while an occupancy rate of 150% (50%

overpopulation) may place the health of the inmates of one such facility at **grave risk**, that same rate will not have seriously adverse consequences for those of another.

Occupancy rates and overpopulation must therefore be analysed together with other parameters, such as:

- the space actually available per detainee in every place used for detention;
- ventilation;
- lighting;
- access to sanitary facilities;
- the number of hours the detainees spend locked in their cells or dormitories;
- the number of hours they spend in the open air;
- whether they have the opportunity to take physical exercise and to work, etc.

Total space available for accommodation

As may be seen from Figure 4, only part of the space within the security perimeter is used to house the detainees.

In this example:

- 400 m² of floor space are used for housing,
- 255 m² are occupied by other services,
- about 1,000 m² are taken up by the exercise yard.

Figure 5 shows how space is distributed among the various prison services.

Figure 5
Location of
different services

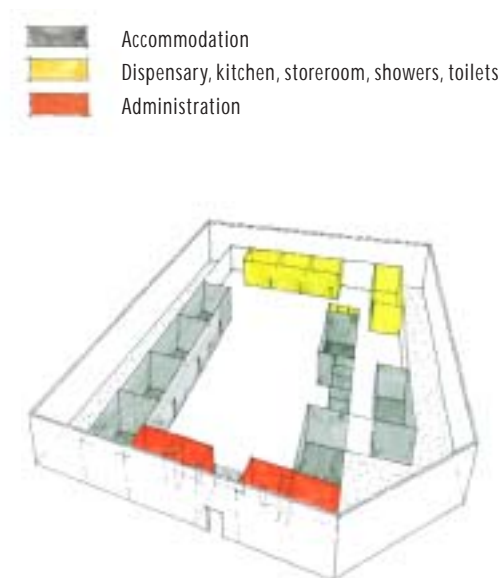

Floor space per detainee or true occupancy rate

In the assessment of most situations, account is taken only of the **ratio of the number of detainees to the floor area that is actually available to them when they are locked in their quarters⁸**, that is, the **true occupancy rate**. The figure obtained by this means must be weighted as explained above.

If the figure remains high for the ratio of the **number of detainees to the area of their quarters and the exercise yard**, serious problems will arise in the detainees' daily lives

in terms of access to water and sanitary facilities, opportunities for physical exercise, etc., together with **technical problems** in terms of waste-water disposal, ventilation, etc.; and all these will have adverse effects on the conditions of detention.

In practice, there are often significant **disparities in the amount of space** available to different detainees in the same establishment. Therefore the space actually allocated per person must be calculated by dividing the area of each dormitory and cell by the **corresponding number of occupants**.

Where cells or dormitories are fitted with bunk beds, the following must be taken into account:

- the **area of the floor**;
- the **space available for resting** (area occupied by beds);
- the **space available to the detainees for moving around**.

The figures obtained in this way are then compared with the accommodation standards laid down by the administration or by the international organizations which are concerned with conditions of detention.

Unfortunately, these standards cannot always be applied immediately in all contexts. In such cases the following principles should be respected as a minimum.

The detainees must be able to:

- **lie down to sleep**;
- **move around freely within their cells or dormitories**;
- **have space for their personal effects**.

Figure 6 shows the **floor space available to each detainee**, calculated by measuring the area of each cell and dormitory and dividing this by the number of detainees housed in it.

Figure 6
Floor space available per detainee in each cell and dormitory (m²/person)

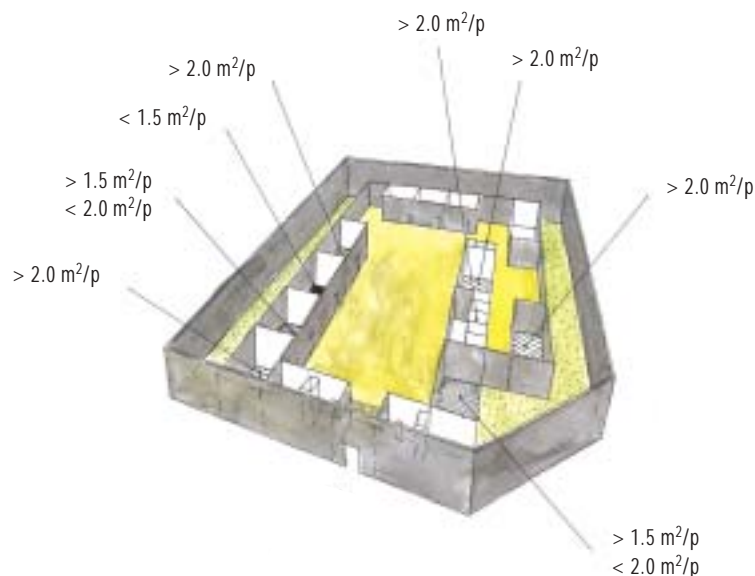

The figures obtained, expressed in m²/person per cell or dormitory, may be transcribed in a table, or in visual form using different colours for each category of occupancy rate:

- less than 1.5 m²/person;
- between 1.5 and 2 m²/person;
- more than 2 m²/person.

The figures for floor space per inmate given as examples in **Figure 6** are intentionally very low. The ICRC's experience shows that such a situation of acute overpopulation is, sadly, far from unusual in the contexts in which it works.

Even in **exceptional crisis situations**, the floor space in cells and dormitories must never be less than 2 m² per person.

This figure of 2 m² per person must in no way be considered as a norm, but as a pragmatic indication which reflects the experience gained by the ICRC in very grave crises. **It must be increased as rapidly as possible**, for such a situation spells extremely difficult living conditions for the detainees concerned.

In cases where the floor space per person in the detainees' living quarters is very limited, it is essential that the following conditions be fulfilled to avoid a major health crisis.

Detainees held in conditions such as these must have:

- well-ventilated quarters;
- 10-15 litres of water each per day;
- access at all times to drinking water stored in appropriate containers;
- a balanced diet comprising food which is adequate in terms of quality and quantity, and which is prepared in accordance with proper standards of hygiene;
- a sufficient number of toilets in working order;
- access to exercise yards or any other place in the open air during the day;
- access to medical care.

It is also essential that emergency evacuation procedures be adapted accordingly.

1. 4 Bedding

The detainees must be able to sleep on beds and must have bedding (sheets, blankets) suitable for the climate.

The recommended minimum size for beds is 1.6 m², that is, 2 m long and 0.8 m wide.

Figure 7 illustrates the minimum area essential to allow each detainee to sleep.

Figure 7
Minimum size
of bed

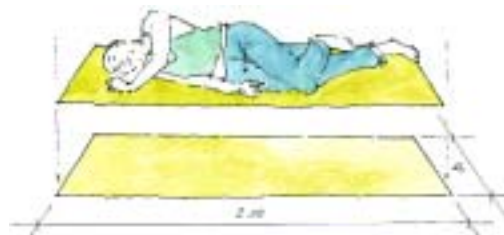

Bunk beds

Setting up bunk beds in cells increases the number of sleeping places and frees floor space which the detainees can use for leisure activities and physical exercise.

Where bunk beds are used, it is essential that minimum standards in terms of **floor space** and ventilation be respected so as to provide decent conditions of detention.

Guidelines for the construction of bunk beds are given in the table at the end of this chapter, including:

- distance between rows of beds;
- height of lower bunk;
- distance between lower and upper bunks;
- space needed to get up to the upper bunks;
- total height of bunk beds.

Bunk beds are usually in two tiers, or three if the ceiling is high enough and security standards permit. They may be set up in different ways, depending on the size of the cells or dormitories in question and the location of the doors, windows, and any interior sanitary facilities.

Figure 8 gives an example of bunk beds which conform to minimum standards in terms of the size of sleeping space, floor space and ventilation, and which allow lateral access.

Figure 8
Bunk beds
conforming to
minimum standards
for sleeping space



Figures 9 and 10 show a different arrangement, which provides a larger number of sleeping places than that shown in **Figure 8**. However, it does not allow every detainee to have his own bed, and this increases the risk of problems resulting from lack of privacy.

This type of arrangement, therefore, should be resorted to only where there is a high rate of overpopulation which cannot be remedied in the short term by judicial or political measures.

Figure 9
Bunk beds
with no partitions

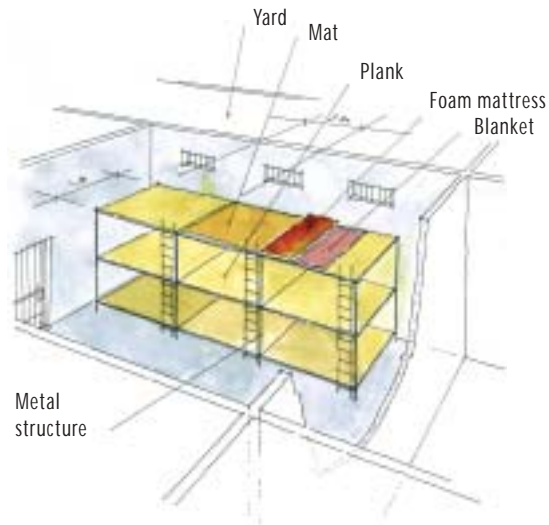
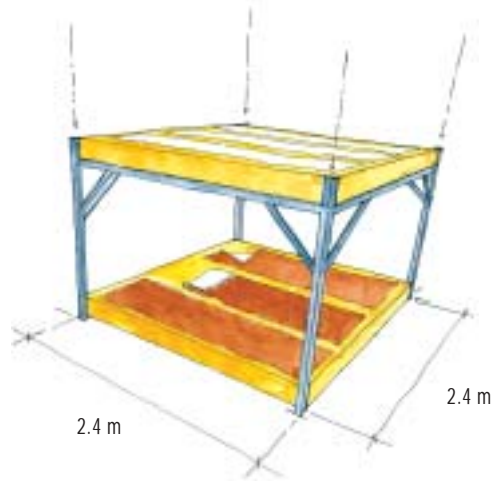

Figure 10
Wooden "mattresses"
and metal supports



1.5 Ventilation and lighting

Ventilation

The function of ventilation is to evacuate the carbon dioxide produced by breathing and the humidity resulting from perspiration. Good air circulation in living quarters allows the detainees to breathe normally and gets rid of body odour.

To determine whether a cell or dormitory is properly ventilated, the following guidelines based on empirical criteria may be used.

If ventilation is poor, the heat and humidity given off by sweating bodies accumulates and makes the atmosphere close. In the most extreme cases, condensation may be observed on cold surfaces such as walls and roofs. In such situations the detainees live permanently in excessively humid conditions, which can favour the occurrence of skin and respiratory diseases.

For proper ventilation, a supply of fresh air is necessary. This supply may be expressed in terms of cubic metres per minute per person, or in terms of m^3 per minute per m^2 of floor area.⁹ Recommended values vary between 0.1 and 1.4 $\text{m}^3/\text{minute}/\text{person}$ or between 0.1 and 0.2 $\text{m}^3/\text{minute}/\text{m}^2$.

A practical way of calculating ventilation in places of detention is to determine the ratio of the size of windows or other openings to the area of the floor.

To renew the air in a satisfactory manner, the following requirements must be fulfilled:

- **the size of the openings must be no less than one tenth of the floor area;**
- **and available air space must be no less than 3.5 m³ per person.**

Compliance with the first of these requirements is especially important if the detainees are not able to spend long periods in the open air every day, for it also ensures that the cells or dormitories enjoy a minimum amount of daylight.

For example, a cell measuring 20 m² should have openings totalling 2 m².

If this principle is applied to the example shown in **Figure 8**, there should be three openings, each measuring about 0.5 m², to provide the dormitory with proper ventilation. **Figure 11** gives an idea of the type of opening in question.

If the first of the two criteria is applied, the openings will be considerably larger, totalling 2 m².

Figure 11
Dimensions of an opening providing minimum ventilation for 10 people

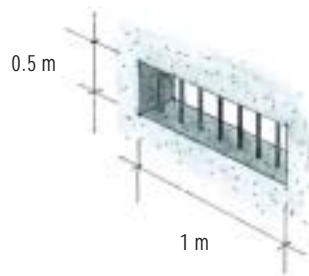

Where the climate permits, ventilation and daylight can be increased by replacing solid cell and dormitory doors with barred doors. The choice of such doors should, however, take into account the detainees' need for privacy in their daily lives.

In very hot countries ventilation can be improved by electric ceiling **fans**. These do not cost much to install and use little electricity. When detainees are kept in overheated rooms on a permanent basis, such fans are essential. **Figure 12** shows a dormitory fitted with this type of fan.

Figure 12
Dormitory with ceiling fans



Lighting

Natural light is essential for every human being.

Rule 11 of the Standard Minimum Rules for the Treatment of Prisoners stipulates:

“In all places where prisoners are required to live or work,

(a) The windows shall be large enough to enable the prisoners to read or work by natural light, and shall be so constructed that they can allow the entrance of fresh air whether or not there is artificial ventilation;

(b) Artificial light shall be provided sufficient for the prisoners to read or work without injury to eyesight”.

Furthermore, lavatories must be lit at all times so that the detainees can use them and keep them clean and thus prevent contamination and the propagation of pathogens. In the example shown in Figure 8, a glazed window or an opening of 0.4 m x 1 m provides minimum lighting.

In certain cases it may be possible to apply the requirements sometimes applied to houses, which state that the size of the windows must be one tenth of the floor area. If this were applied to the example just mentioned, the openings would total 2 m².

Where there is artificial lighting, the power of the light bulbs must be 5 Watts per person, or 2.5 Watts per m².

1. 6 Synoptic table

Prison capacity and accommodation conditions

Capacity

Defined by the authorities (requirements)

Total area available

Area within the security perimeter: 20-30 m²/person

Minimum space for accommodation

Space allocated for accommodation: 3.4-5.4 m²/person

Space for accommodation in serious crisis situations

Space (in cells or dormitories), defined as floor space/person: 2 m²/person is acceptable on a temporary basis if all other conditions are fulfilled (access to water, access to exercise yards, toilets in working order, access to medical care, food, etc.); may also be expressed as area additional to space required for sleeping (minimum 1.6 m²).

Bedding and bunk beds

Minimum size of beds (2 m x 0.8 m): 1.6 m²/person

Minimum space between ground and bottom bunk: 0.2 m

Minimum space between tiers: 1.2 m





Maximum number of tiers: 3

Minimum space between upper level and ceiling: 3 m

Minimum distance between beds: 1.5 m

Ventilation and lighting

Minimum air space per person: 3.5 m³

Ventilation per bed level and per person: 0.025 m²

Air renewal rate (cubic content of quarters/hour): 1

Intensity of artificial light: 0.5 Watts/person

Intensity of artificial light in quarters > 100 m²: 2.5 Watts/m²

Natural light (size of openings/person/level): 0.015 m²

2.	Water: water supply and hygiene measures	
2. 1	Introduction	28
2. 2	Water supply and distribution	28
	Storage and distribution systems	28
	Assessment of water supply	29
	Amount of water that enters the prison	30
	Distribution of water consumption in the prison	34
	Minimum amounts of water available for detainees: recommendations	34
	Assessment of amounts of water available to detainees	35
	A technical matter: taps	35
	Storing water in cells and dormitories	36
	Improving detainees' access to water: general measures	37
	Rainwater harvesting	37
	Water supply from a well	39
	Deepening a well	40
	Emergency water distributions	42
	Emergency installations	42
2. 3	Personal hygiene	44
	Amount of water and equipment needed	44
	Sources of energy for heating water	45
	Measures for maintaining personal hygiene	47
2. 4	Disinfection of water	47
	Disinfectants	48
	Approximate cost of disinfection and advantages of HTH	49
	Inspection and disinfection of water storage tanks	51
	Disinfection of wells	52
	Disinfection of drinking water	53
	Measuring free residual chlorine	55
2. 5	Synoptic table	56

2. 1 Introduction

Supplying sufficient amounts of water is one of the basic services which must be provided without interruption in any place where persons deprived of their freedom are being held. Water is essential for drinking, for preparing meals, for maintaining personal hygiene, and also for sewage disposal (in water-based evacuation systems).

It is therefore a priority task for anyone in charge of a prison to ensure that the water supply is adequate – in terms of both quantity and quality – and regular.

The water-supply infrastructure in places of detention is always under severe strain. Consequently, it must be adapted to cater for the number of detainees present and be regularly maintained.

In practice it is frequently observed that the supply system initially installed is no longer adequate because of the constant rise in the number of inmates. Overuse results in general and rapid deterioration. Very often, there is little or no water supply to showers and toilets, cells and dormitories because the taps and pipes are damaged or water pressure is insufficient. As well as depriving the detainees of the water they need for their own use, this prevents proper sewage and waste disposal and thus creates conditions conducive to the spread of disease.

Prisons also depend on reliable water supplies to the areas in which they are located. If a prison is in an urban centre which is itself short of water or developing rapidly, the inmates' need for water may be in competition with the needs of the local inhabitants.

The investment required to upgrade the capacity of existing distribution networks or to build new water treatment plants is constantly increasing. National water boards sometimes have to wait years before being able to launch new projects because of lack of funding.

2. 2 Water supply and distribution

Storage and distribution systems

Figure 13 gives a diagrammatic view of how water is distributed in a prison from a pressurized or a gravity-fed system. Where there is an elevated water storage tank, there must be sufficient pressure to fill it. The water is then distributed by gravity to the various parts of the prison. A storage tank whose base is about 5 metres high provides sufficient pressure to supply buildings at ground level.

Figure 13
Water supply,
storage tanks
and distribution
in a prison

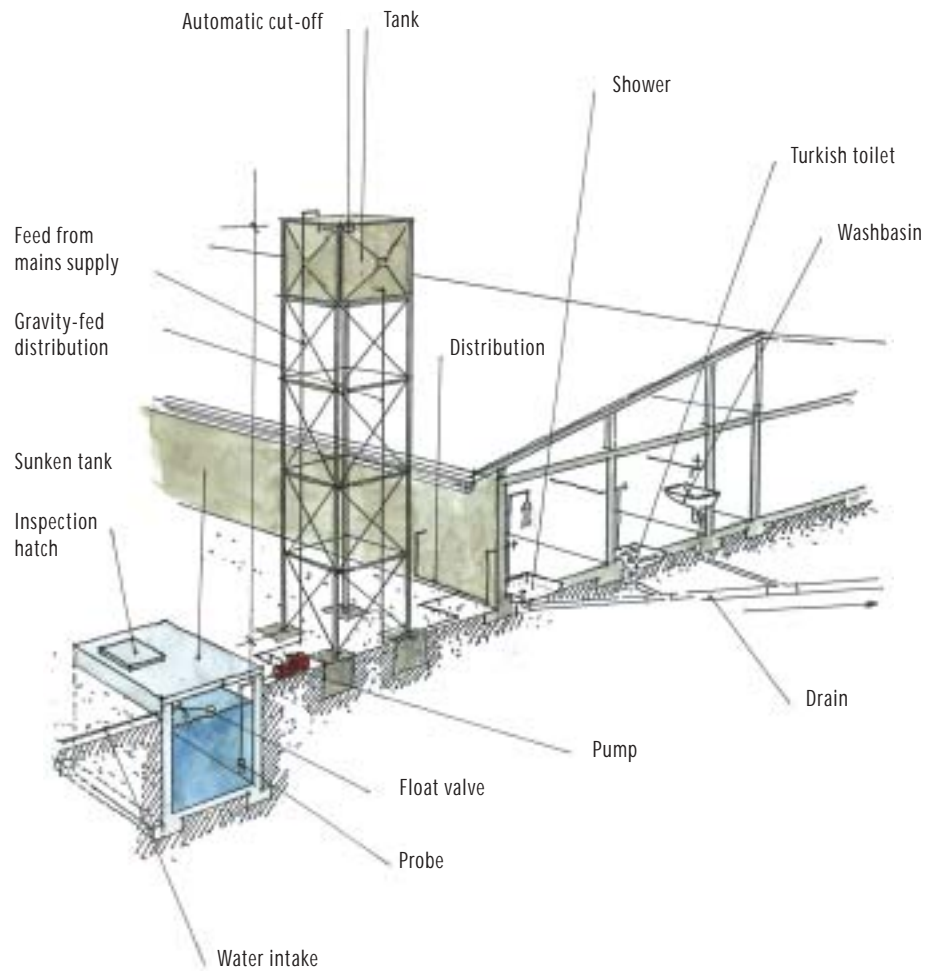

Where the water pressure is insufficient, pumps have to be used both to fill the storage tank and to feed the internal distribution network.

Some prisons have underground reservoirs, which are usually filled overnight when there is less demand for water and sufficient pressure.

If the water-supply system is a complex one, it is better to call in a specialist.

Assessment of water supply

A prison will usually be connected to a water-distribution network. The amount of water it uses is measured by means of a water meter, and the water consumption is billed to the prison administration on the basis of the meter readings. In some countries water is billed not by actual consumption but by fixed rate, whatever the number of cubic metres supplied.

The water supply must be sufficient to meet the following needs:

- drinking water;
- preparation of meals;
- maintenance of personal hygiene;
- operation of the sewage- and waste-disposal systems;
- cleaning of premises, etc.

In determining whether these needs are being met and to identify any problems, the following parameters are taken into account:

- the quantity of water that enters the prison;
- the quantity of water that is available to the detainees;
- the quantity of water that is actually used by the detainees.

Amount of water that enters the prison

The amount of water that is actually received by the prison is determined by regular readings of the water meter.

The water meter is sometimes outside the prison's security perimeter. In tropical countries, care must be taken in reading the meter because the inspection hatches may harbour snakes or other potentially dangerous creatures.

Figure 14 shows a typical installation and the gauges and dials that record the number of cubic metres supplied.

Figure 14
Inspection hatches,
water meter
and meter readings

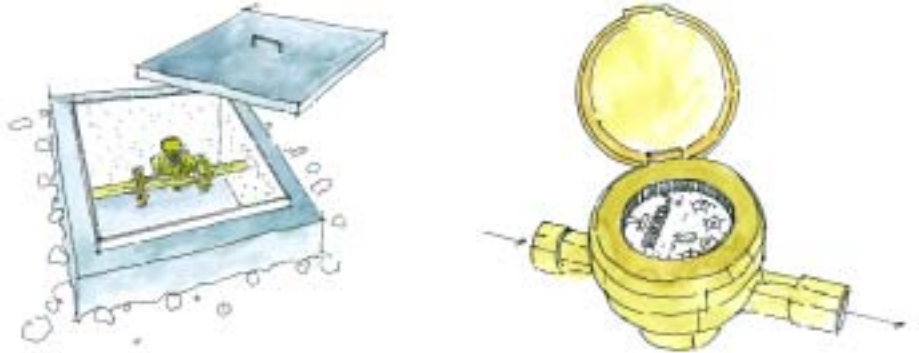

The volume of water supplied to a prison may undergo more or less wide variations according to the time of day and, naturally, the season. For various reasons, water may also be cut off for short or longer periods.

Variations in the water supply must be noted so as to assess their effect on the actual availability of water on a permanent basis within the internal security perimeter. The rate of flow, in terms of m³/hour, should therefore be measured at regular intervals.

Box No. 2 describes the procedure for measuring the amount of water entering the prison.

Box No. 2

Procedure for assessing the amount of water entering the prison by taking meter readings

1. Take a reading of the water meter at a fixed time or several times during the day.
2. Check (time) the rate of flow (number of m³/minute), and take several readings so as to calculate the average rate.
3. Calculate the number of m³ entering the prison during a set period (for example 10 hours or 12 hours).





If time permits:

4. Take readings on several successive days of the week, and then at least once a month, to determine whether water consumption varies in line with increased demand in summer or in the dry season.
5. Should there be any problems, take a reading every day at the same time.
6. Calculate the average daily amounts and the number of litres used per person per day on the basis of the number of inmates present each day or the average number present during the week.
7. Express the findings in a graph.

Table I gives an example of the result of readings taken over a week.

Table I Water meter readings taken over a week and calculation of amounts of water available to the prison

DAY	TIME OF READING	HOURS BETWEEN READINGS	METER READING	AMOUNT IN M ³	NO. OF DETAINEES	DAY NO.
10.11.96	18.00	–	15227.15	–	975	
11.11.96	10.00	16	15245.02	17.87	968	
11.11.96	18.00	8	15255.02	10.00	972	1
12.11.96	10.00	16	15277.22	22.20	975	
12.11.96	18.00	8	15290.52	13.30	978	2
13.11.96	10.00	16	15309.72	19.20	984	
13.11.96	18.00	8	15330.72	21.00	988	3
14.11.96	10.00	16	15346.72	16.00	985	
14.11.96	18.00	8	15368.74	22.02	988	4
15.11.96	10.00	16	15379.94	11.20	982	
15.11.96	18.00	8	15398.94	19.00	980	5

Total for the five days: 171.79

Average number of detainees: 980

Amount of water available per day: $171.79/5 = 34.358 \text{ m}^3$

Amount of water available per detainee: $34,358/980 = 35.05 \text{ litres/person/day}$

Figure 15
Meter reading with corresponding figures

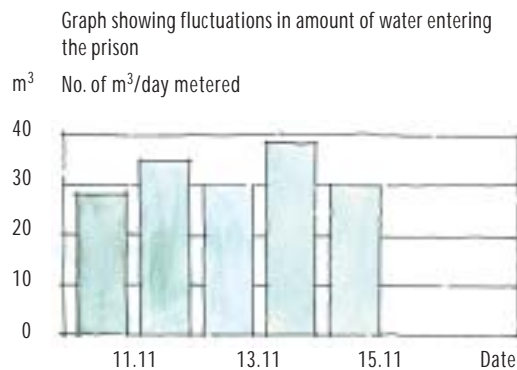

The data obtained during the five days of readings (see Figure 15) indicate that:

- in general, the rate of flow is appreciably higher in the evening than in the morning;
- an average of 34.358 m^3 (or 34,358 litres) of water enter the prison per day;
- the water entering the prison corresponds to average of 35 litres per detainee per day.

The amount of water actually available to the detainees can be determined after estimation of the loss of water occurring within the prison.

Where there is no water meter, assessment of the water supply is more complicated. In this case the easiest thing to do is to install a meter on the main supply line.

In a prison where there is a water reservoir, there are two possibilities. Either:

- calculate the volume of the reservoir;
- note how long it takes to fill up;
- divide the first of these figures by the second to estimate the number of litres of water that flow into the reservoir per hour;

or:

- measure the rate of flow by using a graduated bucket and noting the time it takes to fill up.

If the reservoir fills only at night, its capacity will determine the amount of water available daily.

Important services, such as the kitchen and the dispensary, sometimes have separate storage tanks which can be filled on a priority basis from the main reservoir. In that case the water consumption of the services concerned can be measured quite accurately and evaluated in comparison with their needs.

Figures 16 and 17 show two types of decentralized storage tanks, which are often installed close to the services supplied.

Figure 16
Decentralized
storage tank

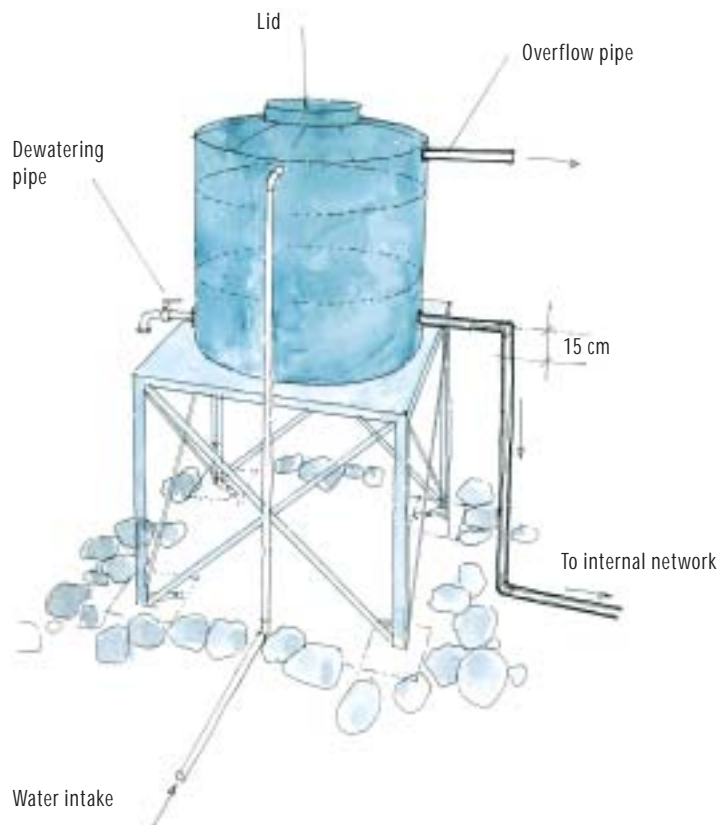

Figure 17
Decentralized
storage tank

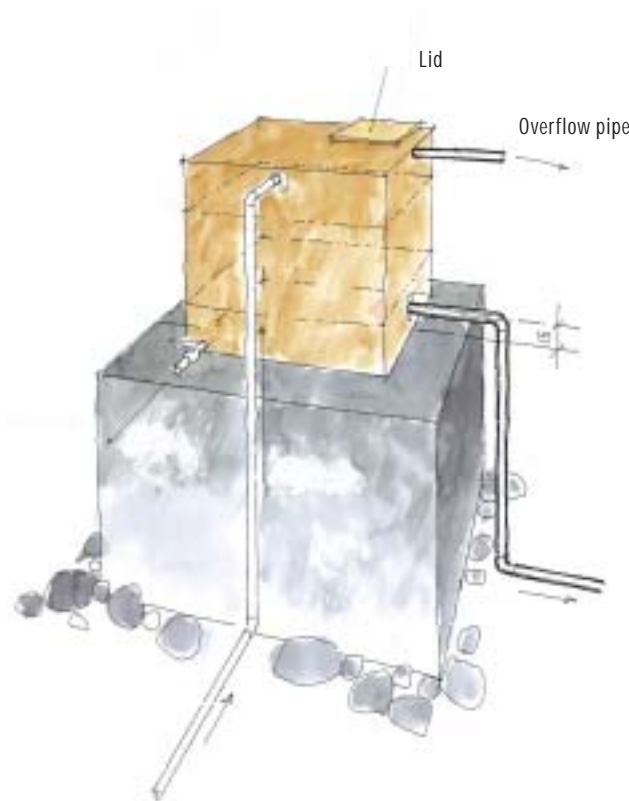
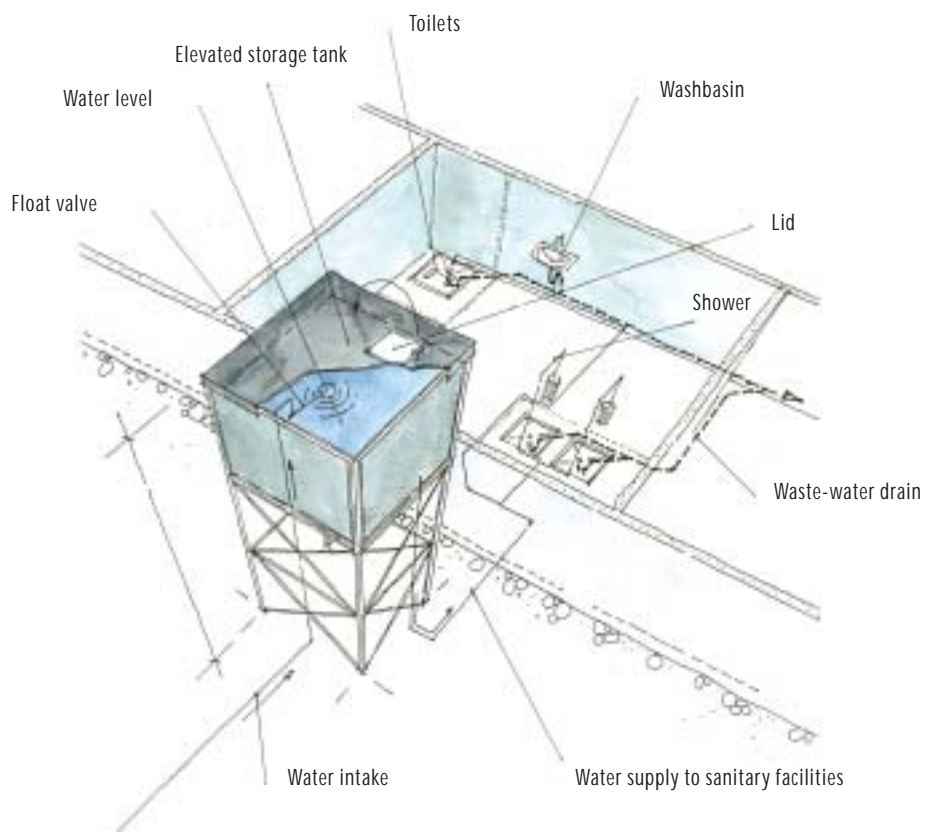

Figure 18 shows an elevated storage tank with a simple system of distribution to the different parts of the prison. The detainees must also have access to water in the exercise yard, where there are often taps or, more rarely, distribution ramps.

Figure 18
Elevated storage tank
and water distribution
to users



Distribution of water consumption in the prison

The water that enters the prison does not serve only to meet the detainees' immediate needs. It has to cover other needs, such as:

- supplying the kitchens, the dispensary or dispensary, the showers and other sanitary facilities;
- waste-water disposal;
- in some cases, supplying the living quarters of the prison staff;
- watering vegetable plots, etc.

It is important to estimate the amount of water used for each of the purposes mentioned above. Such an assessment must take into account water loss due to faults in the distribution network (leaking pipes and taps), which may be considerable.

This makes it possible to check whether the needs of each sector are being met and whether priorities are being respected. If necessary, the amounts of water delivered to each sector can be modified in accordance with priority needs.

If large amounts of water are being wasted because of faults in the network, measures must be taken to remedy the situation.

For example, a thin trickle of water from a leaking tap amounts to about 10 litres per hour, that is, 240 litres per day. If 10 taps are leaking, the minimum amount of water necessary for 240 people is being wasted.

Figure 19 gives an example of the proportion of water used for different purposes in a place of detention.

Figure 19
How water is
used in a prison

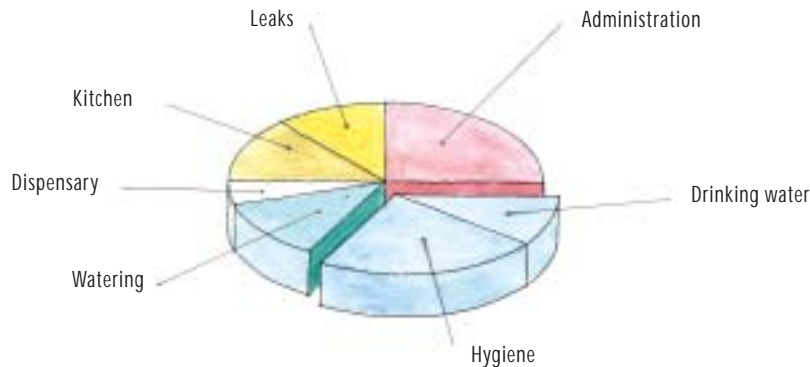

In this example, 6.66 m³ of water are available for a population of 1,000 detainees, that is, 6.66 litres per person per day. When the amount of water used by the prison kitchen and the dispensary is added, this comes to about 10 litres per person per day.

That amount corresponds to the minimum recommendations for places of detention, which are given in the synoptic table at the end of this chapter.

Minimum amounts of water available for detainees: recommendations

These recommendations are based on those issued by WHO (World Health Organization) and those used for refugee camps.¹⁰ Here too, the amounts given are the minimum required for drinking, hygiene and food preparation.

The amount of **10 to 15 litres per person per day** is the minimum required to maintain good health, as long as there is a reliable supply of food and other services and facilities (kitchen, waste-water disposal system, etc.) are functioning properly.

The strict physiological needs of a human individual may be covered by **3 to 5 litres** of drinking water per day. This minimum requirement increases in accordance with the climate and the amount of physical exercise taken. Thus detainees doing agricultural work will have greater needs in terms of both drinking water and water for maintaining personal hygiene.

Assessment of amounts of water available to detainees

Detainees must have access to water at all times. The most important figure to be established is the amount of water actually used by the detainees. This makes it possible to check whether their basic needs in terms of water are being met.

As already mentioned, water consumption is sometimes difficult to determine if there is no water meter and no storage tank.

The procedure to be followed in such cases is to measure, at different times of day, the average rate of flow from the various distribution points (usually taps) used by the detainees inside and outside their living quarters. The figure obtained is then divided by the number of detainees drawing water.

The same method can be used to estimate the amount of water used for showers, toilets, etc. Only very approximate figures are obtained in this way, for there may be variations in the rates of flow from the various distribution points.

Where there are no taps inside the cells and dormitories, the number of buckets and other water storage containers accessible to the inmates in each cell and dormitory should be counted and their capacity measured, and a note should be made of the frequency with which they are filled.

The water available to the inmates calculated in this way is then compared with the recommended amounts.

There must be a sufficient rate of flow and there must be no water cuts. Taps should supply no less than **10 litres per minute**, which allows 50 detainees to draw the minimum recommended amount in one hour.

The detainees' access to water becomes very uncertain when:

- the water distribution points are outside the cells and dormitories;
- the water supply is intermittent, or the rate of flow low;
- there is no storage tank.

A technical matter: taps

This is one of the weak points in water-supply systems. In prisons, taps are subject to considerable wear and tear because they are in constant use, and are often vandalized. Unfortunately, for economic reasons, the taps installed are generally the most common models and not the most reliable (see **Figure 20**).

Several factors should be taken into account in making a proper choice:

- spare parts (e.g. washers) must be available locally;
- the taps must be sturdy, as they wear out rapidly;
- the cost of the taps must be low, as they have to be replaced frequently;
- the taps must be easy to use.

Account must also be taken of the fact that it is hardly reasonable to expect detainees to handle the fittings in their place of detention with care.

Figure 20
Types of taps

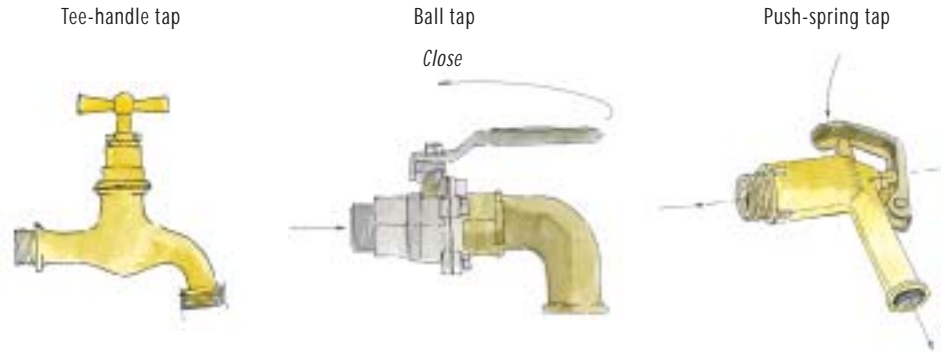

The traditional tee-handle tap is the model most frequently found in prisons for reasons of local availability. The problem with this type of tap is that it tends to leak.

The ball tap is easier to use and less likely to leak, but it does have a drawback: the lever tends to break if it is not made of stainless steel.

Other types of tap may be suggested, such as the push-spring self-closing tap. This model, however, does not work very well and breaks easily if water pressure is low or solid particles are present in the water.

Storing water in cells and dormitories

When there is no water supply inside the cells and dormitories, it is essential that the detainees have collective or individual containers for storing water in sufficient amounts to meet their physiological needs while they are locked in. Individual storage containers must be covered to avoid contamination. The use of jerry cans or buckets with lids is recommended.

The minimum amount of water that must be available inside the cells and dormitories is in the order of **2 litres per person per day** if the detainees are locked in for periods of up to 16 hours, and **3 to 5 litres per person per day** if they are locked in for more than 16 hours or if the climate is hot.

The most appropriate arrangement is to install water storage tanks inside the cells and dormitories. The capacity of these tanks is calculated as indicated below. They are filled every day by means of buckets which are kept clean and used only for this purpose.

Figure 21 shows a common type of storage tank and some individual storage containers.

Figure 21

Water storage tank
in detainees' quarters
and individual containers



The quality of the water is more likely to remain acceptable in a collective storage tank. In general, individual containers rapidly become dirty and contaminated with bacteria (faecal coliform bacteria), usually because of poor hygiene due to negligence or lack of cleaning products.

Should an epidemic occur, collective storage tanks can be disinfected more easily. This will prevent the rapid spread of disease (cholera, viral conditions, etc.) via contaminated water.

Improving detainees' access to water: general measures

The following measures may be considered to ensure that the detainees have access to water at all times:

- increase the diameter of the pipes bringing water into the prison;
- install a water reservoir allowing distribution to be regulated;
- increase the number of taps so as to reduce waiting time;
- install taps inside the cells and dormitories.

These solutions are technical in nature and have to be studied in detail by water-board engineers. Indeed, a whole range of factors have to be taken into account, such as the availability of water in the area where the prison is located, the waste-water disposal system and any plans for extending the distribution network, and these are matters that can be analysed only by professionals.

Rainwater harvesting

In countries with medium or high rainfall, rainwater harvesting can supply significant amounts of water. A study of rainfall patterns in the area where the prison is located should indicate whether it is worth installing a rainwater harvesting system and, if so, what results might be expected. Obviously, such a system will not remedy water shortages during the dry season.

Rainfall is measured in **millimetres per year**. It is expressed as the depth of water measured per unit of surface on the ground. It is estimated that about 0.8 to 0.9 litres may be harvested per square metre and per millimetre of annual rainfall. One millimetre of rainfall over an area of one square metre is equivalent to one litre.

Thus in a region where the average rainfall is 1,000 mm/year, about 900 litres of water per m² can be harvested. This means that a dormitory roof measuring 100 m² can provide about 90,000 litres of water per year.

The type of roof and the state it is in will determine the most appropriate harvesting method. The quality of the water harvested will depend on the type of roofing material and the system installed to discard the initial flush of water which rinses the roof and washes off dust and debris.

Figure 22 shows a typical rainwater-harvesting system.

Figure 22
Rainwater-
harvesting system



The brackets that fix the gutters under the corrugated iron sheeting (or other material) forming the roof must allow the water to flow towards the catchment system without stagnation and without loss.

Figure 23 shows the mounting of a gutter.

Figure 23
Gutter mounting
system

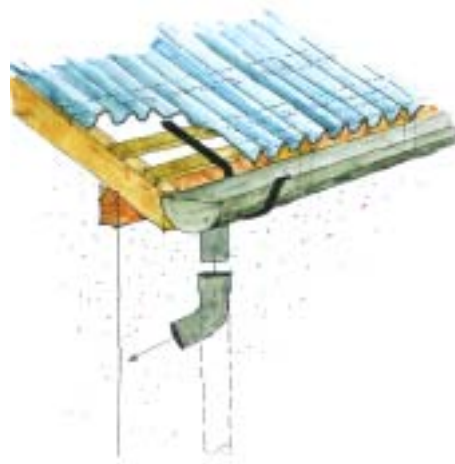

Figure 24
System for separating
the first flush
of water which
rinses the roof

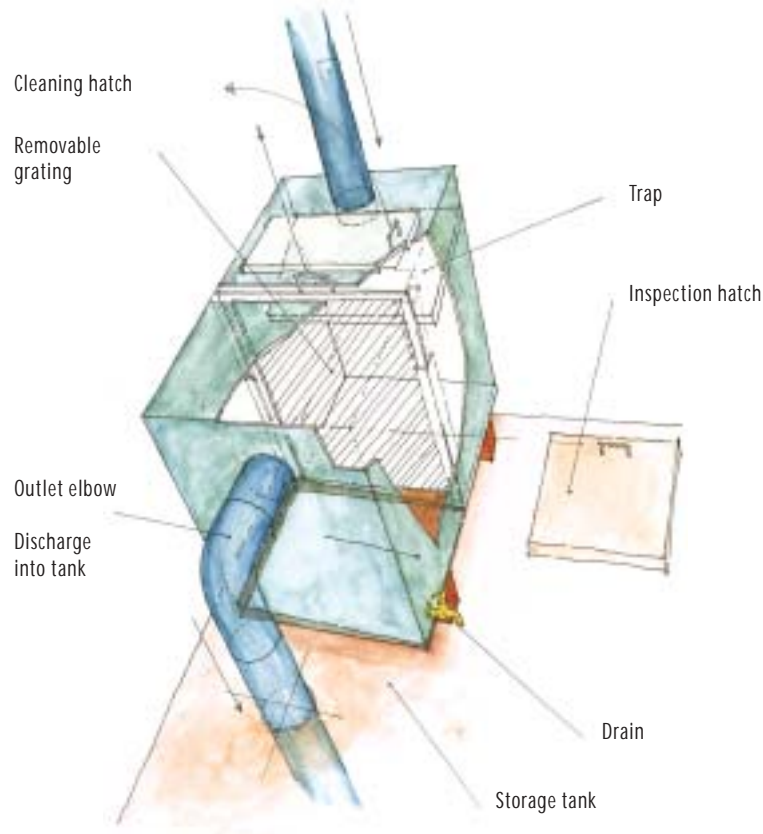

Figure 24 shows a type of filter which retains sediment and prevents it from entering the storage tank.

The tank must be large, for tropical rainfall can amount to 20 to 50 mm in a few hours. This means that between 4,000 and 5,000 litres of water can be harvested in two hours. In such conditions the tank should have a capacity of at least 4 m³.

A harvesting system with manual disposal of the first flush of water can be quite simple (see **Figure 25**).

Figure 25
Simple storage system
with manual disposal
of the first flush of water



Water supply from a well

In many places of detention, water is drawn from wells sunk inside the security perimeter. These are often just holes dug in the ground down to the water table.

Wells must be protected to prevent contamination of the water by direct infiltration or seepage of surface runoff or stagnant water collecting around the well.

Wells may be protected by:

- **lining the shaft** with concrete rings;
- **building a base or apron and a low wall or curb** (Box No. 3 explains the procedure to be followed, the materials necessary for building the base or apron, and indispensable maintenance measures);
- installing a **hand or power pump**, or a **bucket and rope** attached to a pulley. The manufacturer's instructions must be followed for installation of a hand pump.

Figure 26 shows a protected well fitted with a hand pump.

Figure 26
Well fitted with
a hand pump

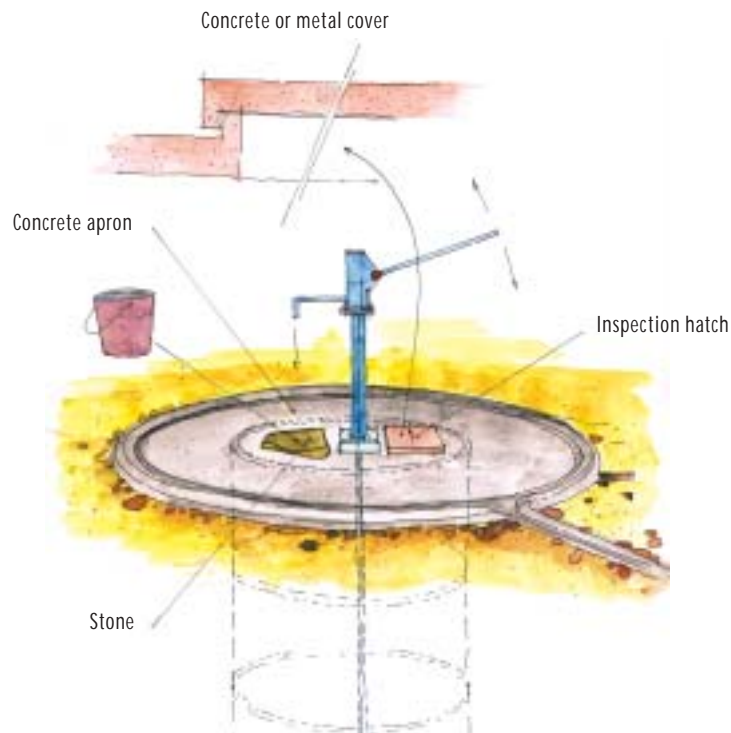

When the water is drawn by means of a bucket and rope, steps must be taken to prevent contamination:

- the water must **always** be drawn using the **same bucket** attached to a rope;
- the bucket and rope must be kept **clean**;
- the people who draw the water must systematically wash their hands before doing so.

Finally, the well must be fitted with a cover or an inspection hatch giving access to the interior of the well in case of any problem. Such access is essential for disinfection operations, the repair of leakages in the shaft, and installation or adjustment of the pump.

Deepening a well

Rather than describing all the possible techniques for sinking a well, we shall simply explain the most common procedures.

In dry periods the level of the water table may fall, and if the well is shallow it will yield only small amounts of water. In such circumstances the well will have to be deepened. This is a tricky operation which requires special expertise and materials.

To ensure a reliable supply of water all year round, wells have to be sunk about 2 metres below the lowest level of the water table during the dry season.

As shown in Figure 27, the well is deepened by adding porous or perforated concrete rings. During this operation the water can be removed in buckets, or by means of a pump if necessary. Gravel is added between the lining and the walls of the well, and a layer of gravel 5 to 10 cm deep is laid at the bottom to prevent the resuspension of settled particles in the water.

Figure 27
Deepening
a well

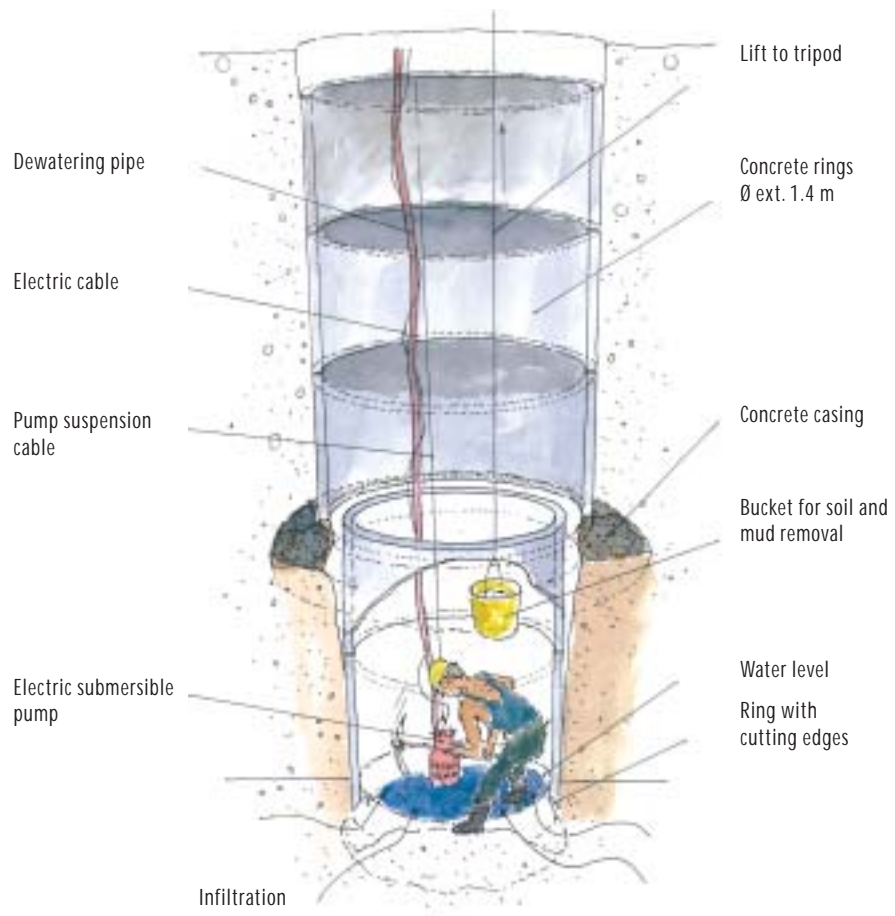

Box No. 3

Protecting a well

1. Dig a trench about 0.30 metres deep around the well head, to a radius of about 2 metres from the middle of the well. This apron may also be square.
2. Line the trench with stones, prepare the reinforcement bars and cast a concrete apron (proportions cement/sand/gravel 1 : 2 : 3) surrounded by a drainage channel and a curb about 0.1 metre high.
3. The materials required are as follows:
 - ▶ 4 50-kg bags of cement;
 - ▶ 4 wheelbarrows of sand;
 - ▶ 8 wheelbarrows of gravel;
 - ▶ 20 metres of steel reinforcement bars 8 mm in diameter and laid in squares 100 mm wide, bricks for construction of the curb, 1 wheelbarrow, 2 shovels, 1 pickaxe, planks, hammer, nails, 1 bucket.





Once the apron is cast, cover it with cement bags and keep them damp for 5 days, until the concrete is cured and has reached maximum strength.

4. The apron or base should slope (1%) towards the drainage channel and then towards the gutter. The water should flow into a soak pit or an irrigated vegetable plot, and must not be allowed to stagnate around the well.
5. Prepare the well cover by fixing on it the bolts for mounting the pump and leaving a space for the inspection hatch. Sometimes the body of the pump is fixed onto the cover, but it is generally preferable to allow for separate access so that the well can be inspected without having to dismantle the pump. Care must be taken to ensure that water cannot seep under the cover and enter the well.

Maintenance

1. When a bucket is used for drawing water, attention must be paid to the following points:
 - ▶ keep the bucket clean;
 - ▶ attach the bucket to the pulley and never place it on the ground;
 - ▶ keep the cement apron and the drainage channel clean;
 - ▶ always use the same bucket;
 - ▶ keep the rope wound round the pulley or tied to a post;
 - ▶ designate someone to supervise the drawing of water.
2. Replace the bucket and rope when necessary.
3. Check the state of the well.
4. Regularly (once or twice a month) measure the water level and the amounts drawn per day, and impose rationing if there is any problem.

Emergency water distributions

When there is a water shortage or the water is cut off, it may be necessary to use tanker trucks to supply the prison. This method is costly and can deliver only a limited amount. In such circumstances it is essential that the prison administration provide 10 litres of water per person per day; it should also take immediate water-saving measures such as restrictions on watering and showers.

In extremely serious situations, and for periods **not exceeding a few days**, water may be limited to **5 litres per person per day**, the minimum amount required to meet the detainees' physiological needs, that is, water for drinking and for preparing food. If the situation lasts any longer, there will be a risk of disease resulting from lack of water.

Emergency installations

Transporting water by tanker truck to fill existing reservoirs is feasible only if sufficiently powerful pumps are available. In that case, temporary storage tanks such as those used in emergency situations should be set up. **Figure 28** shows an installation of this type.

Figure 28
Temporary
storage tank

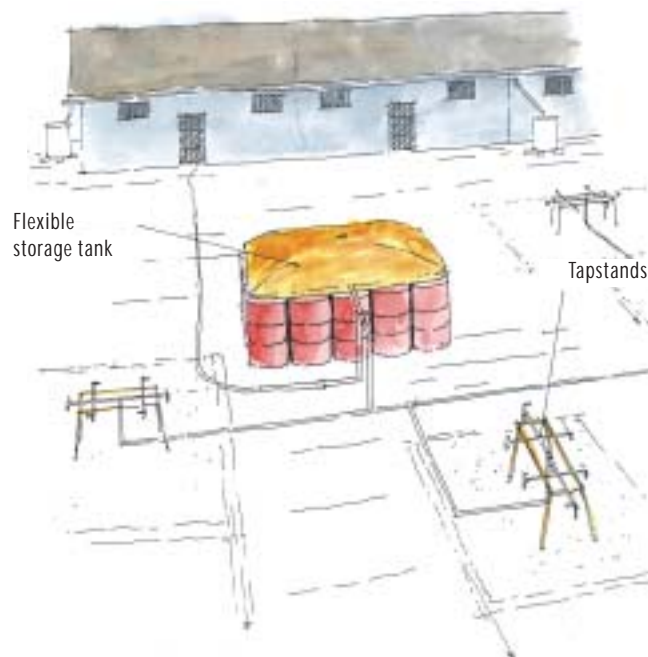

The tanks are placed on an elevated structure which allows the water to flow by gravity to one or more tapstands. Collapsible tanks have the advantage of being easy to transport and can be installed rapidly, but it may be preferable to use rigid, locally made tanks, which are more robust and less costly (see **Figure 29**). The tank should be installed in a place which is easily accessible to the detainees and where, if possible, it can be filled by gravity.

Figure 29
Locally made
storage tank



By way of example, in a place of detention where there are 1,000 inmates, 2 tanks each having a capacity of 2 m³ may be installed, providing some 4 litres of water per person per day.

The tanks can be filled by means of a medium-capacity (about 5 m³) tanker truck. Two such trucks will supply more or less the 10 litres required per person per day.

If the truck is not fitted with a pump, a mobile pump will have to be used to transfer the water from the truck to the storage tanks. Flexible hoses of sufficient length will also be required.

2.3 Personal hygiene

Amount of water and equipment necessary

The *Standard Minimum Rules* stipulate: “Adequate bathing and shower installations shall be provided so that every prisoner may be enabled and required to have a bath or shower, at a temperature suitable to the climate, as frequently as necessary for general hygiene according to season and geographical region, but at least once a week in a temperate climate”.¹¹

When the supply of water to a place of detention is limited or unreliable, consumption must be carefully managed to ensure that all the inmates have enough water to meet their physiological needs and to maintain a minimum level of personal hygiene.

In particularly serious situations it may become necessary to impose strict rules in order to conserve the water available. For example, showers may be limited to a few minutes, or the rate of flow may be reduced to a minimum of 2.5 litres/minute. Properly managed, 5 litres of water suffice to wash oneself.

The most basic solution is to let the detainees wash themselves using buckets of water, making sure that they are allowed at least 5 litres each.

These are minimum amounts, which must be increased as soon as the water supply improves.

The type of installation shown in Figure 30 makes it possible to control water consumption, to avoid the recurrent problem of leaking taps, and to ensure that the detainees can maintain a minimum of personal hygiene.

Figure 30
Water tank
and showers

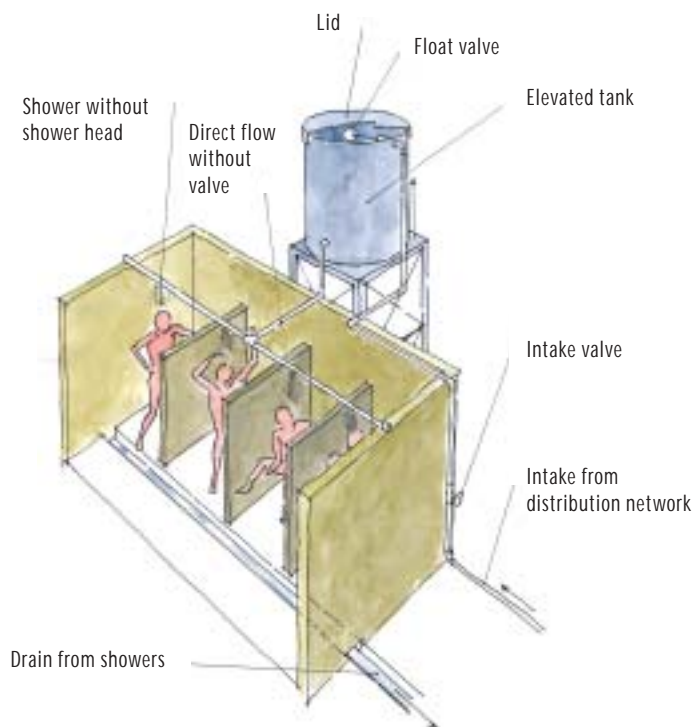

This is an extremely simple system which is suitable for use in hot climates. It requires very little water pressure. The water flows by gravity from an elevated tank which is

positioned above the shower cubicles and is filled at least once a day. If the tank is painted black, it will provide warm water for the showers.

The water simply flows through holes pierced in the pipes fed by the elevated tank (see Figure 31).

Figure 31
Detailed view
of shower system

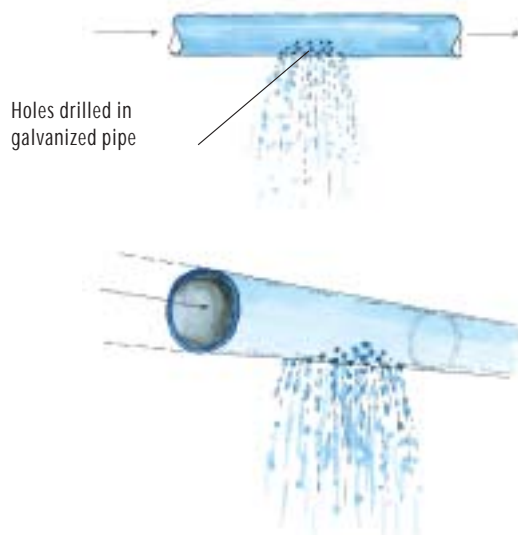

Figure 32
Tap with
"Talflo" valve

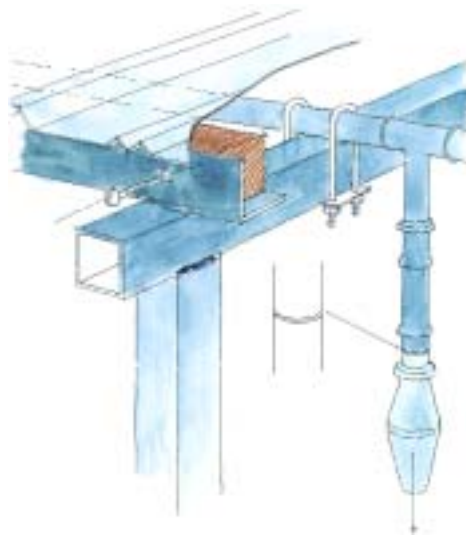

Figure 32 gives a detailed view of a tap fitted with a "Talflo" valve which cuts off the flow of water when released, thus reducing water wastage.

Sources of energy for heating water

Solar energy: Where there are problems with energy supply, solar collectors may have to be installed. Such systems are rather costly to buy, but once installed they use energy which is free of charge and provide hot water for washing in sunny weather.

These systems require little maintenance, but in the long term are functional only if there are local agents or repairmen who can be called in when necessary.

Figure 33 gives a diagrammatic view of one such system, based on what is known as passive solar energy. It comprises a feed tank, a hot-water storage tank, solar collector-absorber plates, and the necessary piping for transporting the water to the showers.

Figure 33
Installation of passive
solar collectors for
hot water production

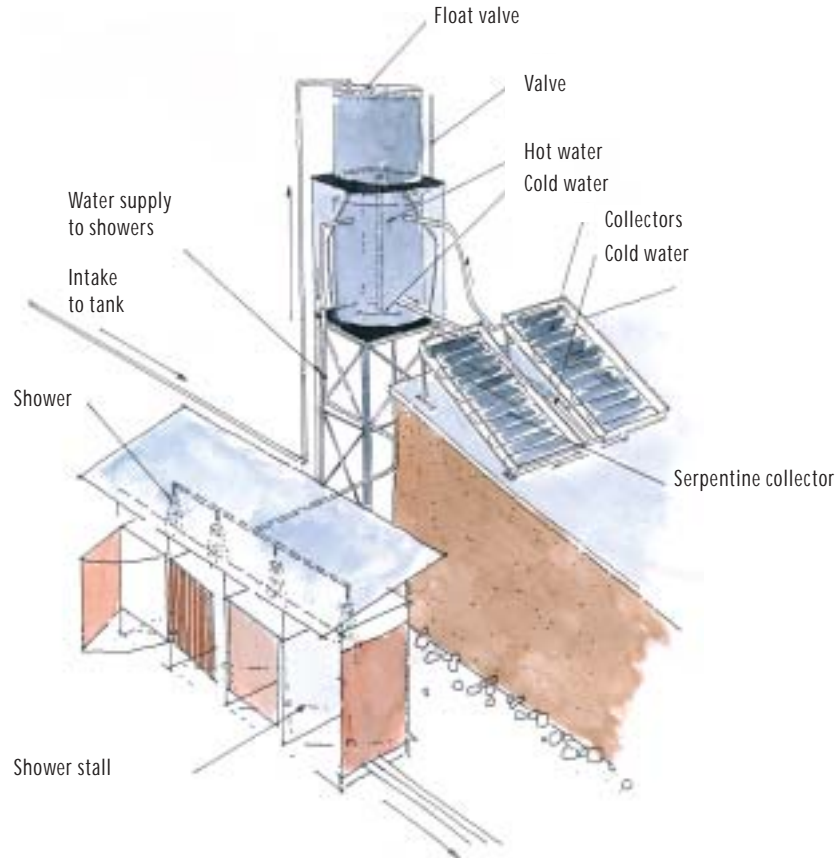

Kerosene and **paraffin** can be obtained almost everywhere. A simple model of a kerosene-heated shower is shown in **Figure 34**.

This system, which is safe and easy to use, can be installed without difficulty. With a litre of kerosene or paraffin it will produce some 8 litres of warm water (40°C) per minute for about 2 hours.

The waste water is disposed of in the same way as with any other system.

Figure 34
Shower with water
heated by kerosene

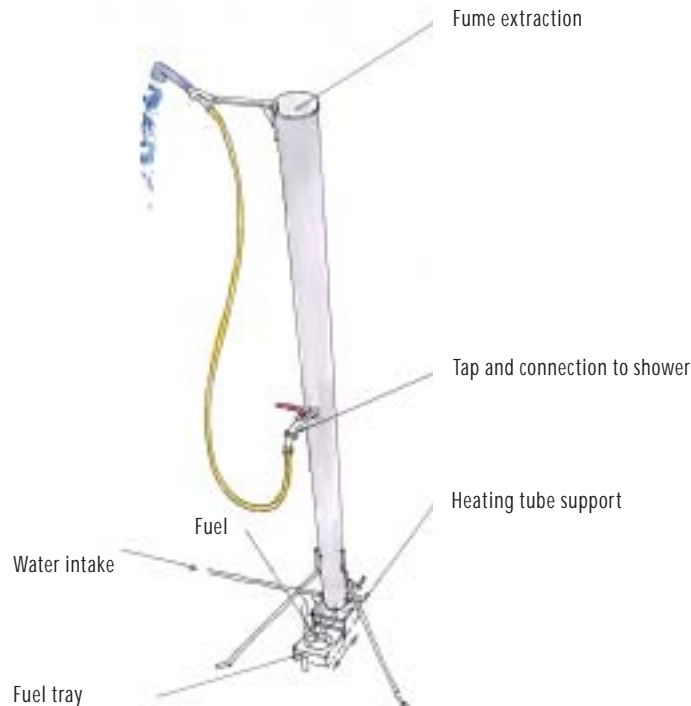

In cold climates, water for the showers may be heated by means of gas or electric water heaters.

Measures for maintaining personal hygiene

Each detainee must receive a minimum of **100 to 150 grams of soap per month**. Regular washing with soap prevents the occurrence of many diseases, especially skin conditions and diarrhoeal diseases transmitted by the faecal-oral route. The cost of the soap will be more than offset by the savings made in keeping the detainees in good health.

The detainees must be persuaded to wash their hands as a matter of course:

- after using the toilet;
- before eating;
- every time they have performed tasks such as sweeping up refuse, cleaning drains or unblocking pipes;
- every time there is reason to believe that they have been in contact with any pathogenic agent.

2. 4 Disinfection of water

To be safe for drinking, water must be free of pathogens. To ensure that this is the case, it has to be disinfected. Water supplied by the mains network, springs and wells is usually safe to drink. In the following situations, however, **water and storage tanks have to be disinfected**:

- in the event of an **outbreak of disease inside the prison** which may be attributed to a water-borne organism or related to a shortage of water, such as cholera or bacillary

dysentery (shigellosis); these organisms contaminate water containers, the areas used for food preparation and the toilets, and can thus spread rapidly among the detainees;

- in the event of an **epidemic outside the prison** which might spread to the inside;
- during the **regular cleaning of storage tanks**.

Disinfectants

The most common disinfectants are chlorine-based. **Box No. 4** outlines their main characteristics.

Box No. 4

Characteristics of chlorine-based disinfectants: advantages and drawbacks

➤ Advantages

May be obtained in various forms: powder, granules, tablets or liquid.

Can be obtained easily and at relatively low cost.

Dissolve easily and can be prepared in high concentrations.

Chlorine acts effectively against a wide range of pathogens.

➤ Drawbacks

Chlorine-based products are powerful oxidants and must be handled with care: do not inhale the vapour.

They are ineffective when there are solid particles in the water (high turbidity).

The water may have an unpleasant taste if slightly too much chlorine is added, and this may deter the detainees from drinking it. In that case it must be explained to them that there is no danger involved.

Against certain forms of pathogens – amoebic cysts, the eggs of intestinal parasites, viruses – chlorine is effective only in quite high concentrations and with a longer contact time.

Chlorine-based products have to be stored in a cool place and are subject to transport restrictions (especially air transport).

Box No. 5 gives a list of the most common disinfectants. They are usually available in various forms: powder, granules, tablets or liquid.

These products are **dangerous** in high concentrations. They must therefore be handled with care and must not come into contact with eyes and skin. Care must also be taken not to inhale the vapour they give off.

It is important to know their **content in terms of available chlorine**, for this value is the basis on which solutions are prepared for disinfection purposes.

Box No. 5

Chlorine-based disinfectants► *In solid form***Calcium hypochlorite (HTH)**

This is a white powder or granules containing between 65 and 70% available chlorine, and is relatively stable. It loses 1-2% chlorine per year if stored in good conditions. It must be protected from light, heat and humidity and kept in plastic (never metal) containers. It may be compressed into tablet form with the addition of stabilizing agents which prevent the product from absorbing humidity and make it easier to dissolve. The tablets are designed to deliver a given concentration of chlorine in a given volume of water, for example 1 mg/l when added to 10 litres of water.

Chlorinated lime

This is a white powder composed of calcium hydroxide, calcium chloride and calcium hypochlorite. It contains between 25 and 30% available chlorine, and must be stored in the same conditions. It is less stable than HTH and contains less chlorine.

Sodium dichloroisocyanurate (rapid-release chlorine)

This is a white powder often compressed into tablet form. It is a chlorine-releasing compound and contains between 65 and 70% available chlorine. It dissolves quickly, is more stable than HTH, and may be used as an emergency measure for a three-month period in the concentrations normally used for disinfection of water. The presence of the cyanide group is not a problem because it is in a very stable bonded form and is not toxic.

Sodium trichloroisocyanurate (slow-release or swimming-pool chlorine)

This belongs to the same class of products but dissolves more slowly. It is used for chlorinating swimming pools and may be used for continuous chlorination of water storage tanks. In the latter case a tablet is placed in a floating dispenser which releases the chlorine slowly, thus maintaining the concentration necessary for disinfection.

► *In liquid form***Sodium hypochlorite (liquid bleach)**

Liquid bleaches are available in different concentrations. Solutions may deliver around 15% available chlorine; they are less stable than the solid products described above. Household bleaches (sodium hypochlorite in solution) contain between 3 and 5% available chlorine. When used as whitening agents for washing fabrics, for example, their available chlorine content is around 3%.

Bleach solutions used as antiseptics contain about 1% available chlorine.

Approximate cost of disinfection and advantages of HTH

Only a few indications can be given here, because the cost of disinfection depends on the concentration of free residual chlorine desired. A kilogram of chlorine in the form of calcium hypochlorite (HTH) 70% granules costs around US\$ 2.50.¹²

A kilogram of HTH can disinfect some 1,000 m³ (a million litres) at a concentration of about 0.5 - 0.7 mg/litre, which is sufficient to disinfect water. This amount corresponds to the water consumption of 1,000 detainees over a 100-day period at a rate of 10 litres per person per day.

The cost of these products is reasonable, and they should be used without hesitation in the event of an epidemic. For economic reasons it is preferable to prepare disinfectant

solutions using HTH rather than buying large amounts of bleach, as the cost of bleach is high in relation to the amount of chlorine it contains.

The preparation of 1-2% solutions using chlorine in the form of HTH involves several procedures which can be carried out by anyone. Procedures for preparing the solutions are explained in **Box No. 6** and illustrated in **Figure 35**.

Box No. 6

Preparation of a 2%, 0.2% and 0.05% active chlorine solution using the most easily available products

	2 % active chlorine solution	0.2 % active chlorine solution	0.05 % active chlorine solution
	<ul style="list-style-type: none"> ▶ for disinfecting excrement, dead bodies (cholera) ▶ for preparing solutions in lower concentrations 	<ul style="list-style-type: none"> ▶ for disinfecting wells, water storage, tanks, floors, contaminated objects, beds; for spraying in toilets 	<ul style="list-style-type: none"> ▶ for disinfecting skin, hands, clothing, cooking utensils
Calcium hypochlorite, 70 % active chlorine powder or granules (HTH)	30 grams/litre or 2 tablespoons in a litre of water	30 grams/10 litres or 2 tablespoons in 10 litres of water	7 grams/10 litres or 1 tablespoon in 10 litres of water
or Sodium dichloroisocyanurate, 70 % active chlorine	ditto	ditto	ditto
Chlorinated lime, 30 % active chlorine, powder	66 grams/litre or 4 tablespoons in a litre of water	66 grams/10 litres or 4 tablespoons in 10 litres of water	16 grams/10 litres or 1 tablespoon in 10 litres of water
	▶ <i>allow the sediment to settle and use the supernatant</i>		
Liquid bleach, 5 % active chlorine	400 ml (0.4 l) in a one-litre receptacle and fill with water	400 ml (0.4 l) in a 10-litre receptacle and fill with water*	100 ml (0.1 l) in a 10-litre receptacle and fill with water*
	* <i>the dilution error is insignificant</i>		
Remember that the concentration of chlorine solutions declines over time (1% per day).			

Inspection and disinfection of water storage tanks

The water distributed by the mains network or any other system (wells, springs) always contains particles in suspension which will settle at the bottom of the reservoir. This turbidity may even be visible after a heavy storm. The water in the reservoir will be further polluted by dust, birds' droppings and insects which infiltrate through cracks in the lid.

Storage tanks and reservoirs therefore have to be **cleaned and disinfected** regularly, **once or twice a year**, usually by means of chlorine-based disinfectants.

They also have to be disinfected when they are first brought into use, following repairs, and when there is any reason for fearing contamination.

The proper procedure is explained in **Box No. 7**, which describes how to perform initial disinfection of tanker trucks used to distribute water, and how to disinfect the prison's internal distribution network.

The **tanker trucks** used to supply a prison with water in an emergency situation often serve urban and periurban areas as well, and may be used for purposes other than the distribution of clean water. They may therefore be contaminated and must be disinfected before being used for carrying drinking water.

Figure 35
Preparation of
2 litres of 1%
chlorinated solution



To prepare the solution:

- Pour a litre of water into a plastic bucket.
- To measure a litre, a plastic bottle or any other bottle with a known volume may be used.
- Add a tablespoonful of HTH (70% calcium hypochlorite).
- Take care not to touch the powder with the hands and avoid any contact with skin and eyes. Should such contact occur, rinse thoroughly with water.
- Stir the solution until the HTH dissolves. There will always be a slight residue.
- Add another litre of water. Stir carefully.

Box No. 7**Disinfection procedures****Disinfection of a storage tank**

1. Scrub the inside of the tank with a 0.2% chlorine solution. Rinse with clean water and empty the tank through the dewatering pipe.
2. Fill the tank with water by opening the intake pipes.
3. While the tank is filling, add one litre of the 0.2% chlorine solution per cubic metre of water. Leave this solution to act for 24 hours (the chlorine concentration should be in the order of 2 mg/l).
4. Check that the chlorine concentration is lower than 1 mg/l by means of a comparator (see below). If no comparator is available, empty out half the water in the tank and fill it again.

The water can then be distributed via the internal network.

Disinfection of the distribution network

To disinfect the network, proceed as indicated above up to point 3, then open the valves feeding the internal distribution network and ensure that the water remains in the pipes overnight. Then drain the pipes, allowing the chlorinated water (2 mg/l maximum) to flow out, and let the system fill with water from the normal supply.

Disinfection of a tanker truck

Spray the inside walls of the tank with a 0.2% chlorine solution and leave it to act overnight. Then empty and rinse with clean water. If the drinking water is chlorinated, the tanker can be filled directly and the water distributed without adding chlorine. If not, chlorine should be added to obtain a concentration of 1 to 1.5 mg/l.

Disinfection of wells

Protected wells (see **Figure 36**) have to be disinfected in the following situations:

- when they are first brought into use;
- in the event of accidental contamination, for example by latrine effluent or flooding;
- if work, such as deepening operations, has been carried out on the well.

The disinfection procedure is described in **Box No. 8**.

Box No. 8**Disinfecting a well**

1. Fill two to four 10-litre buckets with a 0.2 chlorine solution.
2. Scrub the inside walls of the well shaft with a long-handled brush dipped in the solution.
3. Once this has been done, pour the solution in so that it flows along the walls and pour two buckets of the same solution directly into the well water.
4. If the well is fitted with a pump, the pump must be disinfected by pumping out the chlorinated water for 15 minutes. This chlorinated water is then discarded.
5. Wait 24 hours before pumping or drawing water from the well for normal use.





6. If the water gives off an excessively strong smell of chlorine after 24 hours, pump or draw it out until the smell has disappeared.

In the event of a **cholera outbreak**, **preventive chlorination of the water** is necessary. Chlorine should be poured into the well until a concentration of 1 mg of free residual chlorine per litre of water is obtained. The chlorine should be left to act for half an hour before the water is used for drinking.

Figure 36
Disinfection
of a well

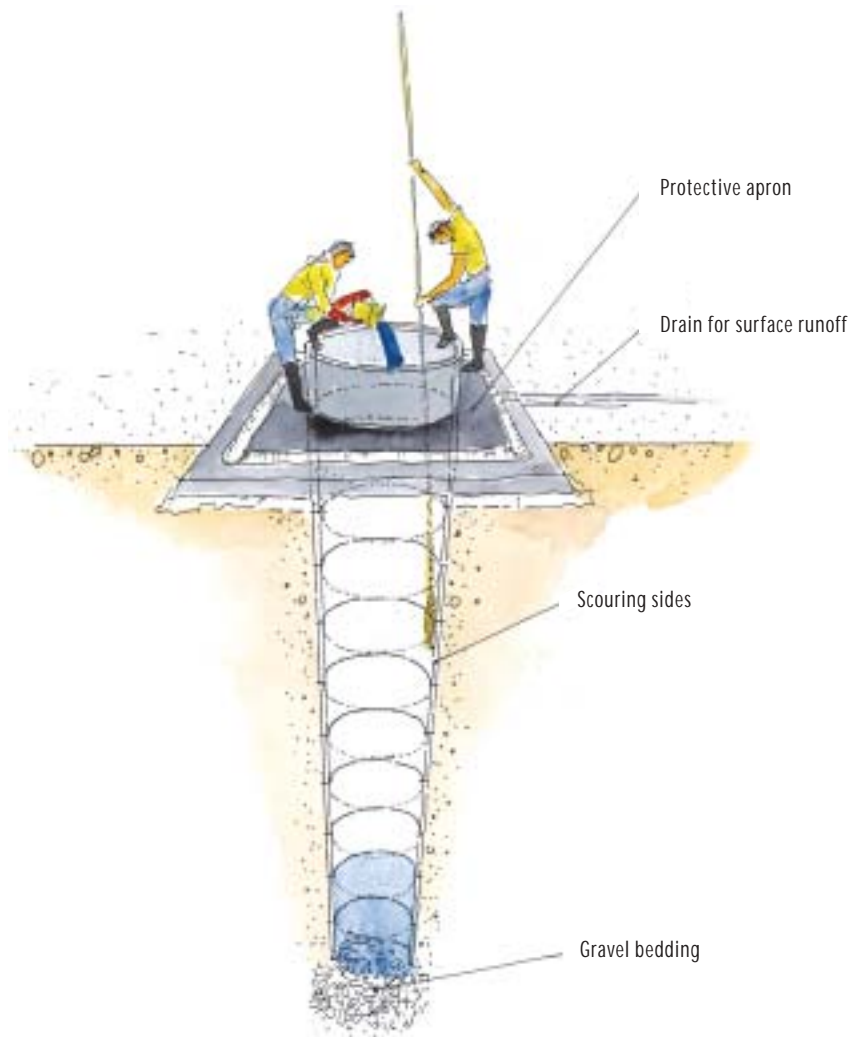

Disinfection of drinking water

In general, it is the water board that disinfects the water supplied by the urban mains network. However, additional treatment with chlorine may be necessary if there is reason to believe that this initial disinfection is insufficient to ensure the absence of any contamination. It is also necessary when the source of the water is dubious.

To disinfect the water, a sufficient quantity of chlorine must be added to eliminate microorganisms such as those that cause cholera and typhoid fever. Care must be taken, however, not to add too much chlorine so that the water remains drinkable.

The concentration of **free residual chlorine must be between 0.2 and 0.5 mg/litre** (0.2 – 0.5 ppm) when the water is distributed. Above that dosage the water tastes of chlorine and this might discourage consumption (see **Box. No. 9**).

The concentration of chlorine must be increased in the following situations:

- in the event of an outbreak of cholera or diarrhoeal disease;
- if the source of the water is dubious.

In both these situations, the concentration of free residual chlorine should be as follows:

- 1 mg/l at distribution points and in wells;
- 1.5 mg/l when a tanker truck is being filled, with a contact time (time during which the chlorine acts on the microorganisms) of no less than 30 minutes.

These dosages ensure complete elimination of pathogenic microorganisms, taking into account the absorption of chlorine by the sides of the tanks or wells and by the chlorine-consuming substances that may be in the water.

This is, however, a simplification, for the water to be treated does not always have the same characteristics. Some preliminary tests will therefore be necessary to determine the amount of chlorine that must be added to obtain the dosages mentioned above. The easiest way to check the effectiveness of chlorination is to test the free residual chlorine concentration by means of a comparator.

These procedures are relatively simple, but it is better to call in a technician from the water board, who will carry out the necessary tests and draw up a simple table of dilutions.

Box No. 9

Disinfection of drinking water

Preparation of a solution containing 0.5 mg/l from concentrated 0.2% or 0.05% solutions

► *To obtain 1,000 litres*

From a 0.2% solution

the solution obtained contains:

1 litre added to 1,000 litres (1 m ³)	2 mg/l
0.5 litre added to 1,000 litres	1 mg/l
0.25 litre added to 1,000 litres	0.5 mg/l

From a 0.05% solution

the solution obtained contains:

1 litre added to 1,000 litres (1 m ³)	0.5 mg/l
2 litres added to 1,000 litres	1 mg/l

► *To obtain 100 litres*

To prepare smaller quantities, first the concentrated solution is diluted tenfold by the addition of 1 litre of the 0.5% solution to 10 litres of water (N.B.: the amount must be made up to 10 litres and not 11 litres). Then 1 litre of this solution is added to 100 litres of water to obtain a 0.5 mg/l chlorine solution. If 2 litres are used, 100 litres of a 1 mg/l solution are obtained.

A 2% solution is used to chlorinate the water in a storage tank. In this case 0.5 litre of the 2% solution is added to 10 m³ (10,000 litres) of water to obtain a chlorine concentration of 1 mg/l. Alternatively, 5 litres of a 0.2% solution may be added.

It is important to test the free residual chlorine value from time to time. Chlorine demand may vary over time, and the amounts to be added in order to obtain the desired concentration have to be adjusted accordingly.

Measuring free residual chlorine

The amount of free residual chlorine in the water may be measured by means of a simple instrument (see Figure 37). This chlorine comparator is used by water-board technicians to ensure that the water distributed by the mains network contains a concentration of free residual chlorine sufficient to prevent the occurrence of water-borne diseases.

Figure 37
Comparator for
measuring
residual chlorine



The purpose of this procedure is to check that the free residual chlorine content in the water is between 0.2 and 0.5 mg/l at the stage where the water is used. The result of this reading will indicate whether the chlorine dosage needs to be adjusted to obtain these values.

The testing procedure is described in Figure 38.

Figure 38
Test for
residual chlorine

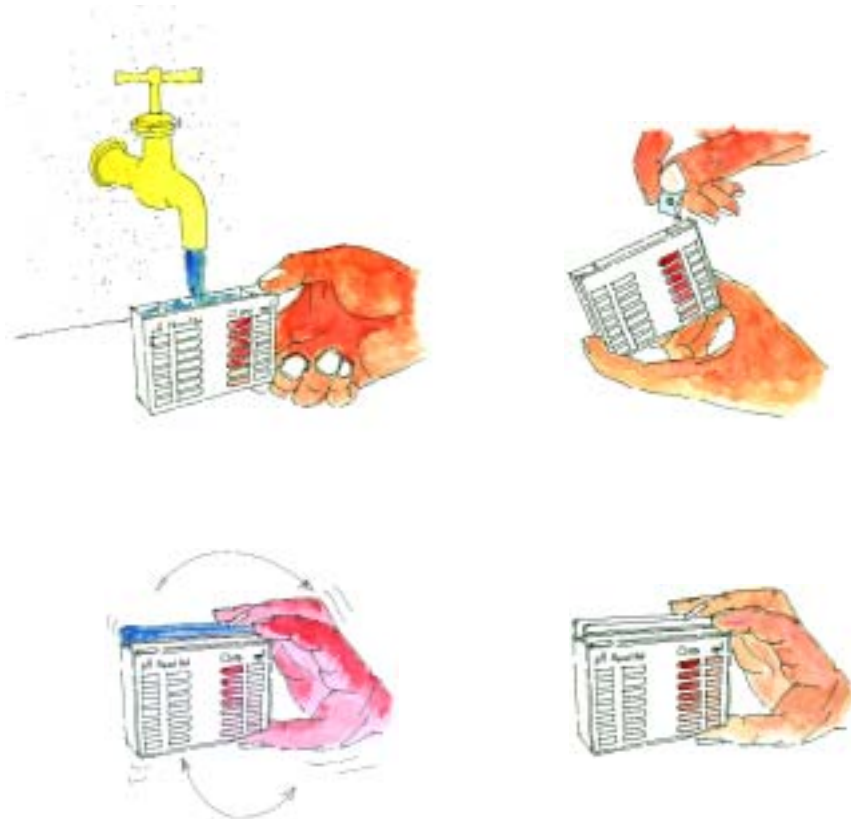

Procedure:

- fill the three compartments with water;
- add a DPD1 tablet (free residual chlorine test);
- shake to dissolve and mix;
- compare the colours and estimate the residual chlorine value.

2. 5 Synoptic table

Water supply

Recommendations for minimum amounts of water and minimum services relating to water

Minimum amounts of water

Minimum amount for survival (hot or cold environment)	3 – 5	litres/person/day
Minimum amount per person (to cover all needs)	10 – 15	litres/day
Infirmery/dispensary		
• outpatients	5	litres/user/day
• inpatients	40 – 60	litres/patient/day
• cholera treatment centre	60	litres/patient/day
Amount needed to wash hands after using toilets	1	litre/user/day

Water storage

Minimum storage capacity If water is distributed from the mains supply on alternate days in different neighbourhoods, the number of days between distributions must be taken into account	1 day's consumption
Storage capacity for kitchen	1 day's consumption
Storage capacity for dispensary	1 day's consumption
Storage capacity for the night inside cells or dormitories	2 litres/person or 1 10/20-litre jerry can (bucket) per cell or dormitory
Number of taps	1 – 2 taps per 100 inmates
Minimum rate of flow	3 – 5 litres/minute
Showers	1 per 50 persons 1 shower/week (minimum)
Taps in latrines	1 for each toilet block

3.	Sanitation and hygiene	
3. 1	Waste water and refuse disposal	58
	Quantity of waste generated	59
	Amounts of water necessary for waste-disposal systems	59
3. 2	Latrines	59
	Types of latrines	59
	Flush latrines	61
	Pour-flush latrines	62
	Dry pit latrines	62
	Ventilated improved pit latrines	64
	Intermittent flush latrines	64
	Dimension and slope of drainpipes	66
	Inspection hatches	66
	Latrine maintenance	67
	Urinals	68
	Soil buckets or sanitary pails	69
	Material for anal cleansing	69
3. 3	Septic tanks	70
	Calculating the capacity of a septic tank	71
	Principles to be observed in calculating the dimensions of a septic tank	72
	Practical tips	73
	Regular inspection	74
	Desludging a septic tank	77
	Manual desludging	77
	Disposal of effluent from septic tanks	79
	Infiltration capacity of the soil	79
	Soak pits	82
	Infiltration (or drainage) trenches	83
	Variants	85
	Stabilization ponds (lagooning)	86
	Facultative ponds	86
	Maturation ponds	87
3. 4	Refuse disposal	88
	Sorting and treatment of refuse	88
	Organization of refuse disposal	90
3. 5	Synoptic table	92

3. 1 Waste water and refuse disposal

Waste water and refuse disposal is often the most intractable sanitation problem in places of detention. A large proportion of the diseases observed among the inmates of such establishments is transmitted by the faecal-oral route. To keep the detainees in good health, special attention must be paid to waste-disposal systems.

Figure 39 illustrates how tiny particles of faecal matter can be ingested by the detainees, and how the accumulation of refuse attracts flies, rats and cockroaches, which are potential vectors of disease.

Figure 39
Main routes of
faecal-oral transmission
of disease



Faeces are the most frequent source of pathogens transmitted by the faecal-oral route. Urine contains only a few pathogens, which are transmitted to man via contaminated

water or by means of breeding cycles involving aquatic intermediate hosts. An example of the latter is urinary schistosomiasis (bilharzia), which is transmitted to human individuals when they bathe in infected ponds or rivers.

Preventive measures must be taken to ensure that human waste, waste water and refuse are removed to places where they will be treated and thus rendered harmless.

Quantity of waste generated

Every human being generates waste. One individual produces an average of 1 to 2 litres of waste per day.¹³ This figure represents the volume of urine and faeces, and does not include the material used for anal cleansing or the amount of water used for washing.

Waste water evacuation and storage systems must be commensurate with the amount of waste produced.

Fresh solid matter decreases in volume by decomposition. Decomposition occurs by evaporation, by digestion and the production of gas, by liquefaction and by the dissolving of soluble substances. It is then compacted by the accumulation of new layers of matter. The cumulated amount of excreta produced by an individual is estimated to be **40 to 90 litres per year (0.04 m³ to 0.09 m³/person/year)**.

This figure does not take into account the material used for anal cleansing or the number of people using the latrines. In places of detention, where the latrines may be used by large numbers of people, a figure expressed in cubic metres, that is, **3 m³ for 10 inmates over one year**,¹⁴ is used to calculate the volume of excreta produced by the detainees. Calculation of this figure makes it possible to determine needs in terms of storage.

Amounts of water necessary for waste-disposal systems

Lack of water is a frequent cause of the dysfunction of waste water and sewage disposal systems. In situations where water is in short supply, ensuring proper excreta disposal and keeping the toilets in working order often seems an impossible task.

Too much water, on the other hand, also causes serious problems, especially for disposal systems based on percolation in the soil. When the nature of the soil does not allow absorption of large quantities of water, the water level will rise in the soak pit or septic tank, which will sooner or later overflow. It will no longer be possible to flush the toilets and sewage will spread over the ground.

Careful thought should therefore be given to the choice of disposal systems.

3. 2 Latrines

Types of latrines

Figure 40 shows the various types of latrines generally used in prisons. There are two categories:

- dry pit latrines (simple or improved by ventilation of the pit);
- latrines using water to flush away excrement.

Figure 40
Types of latrines

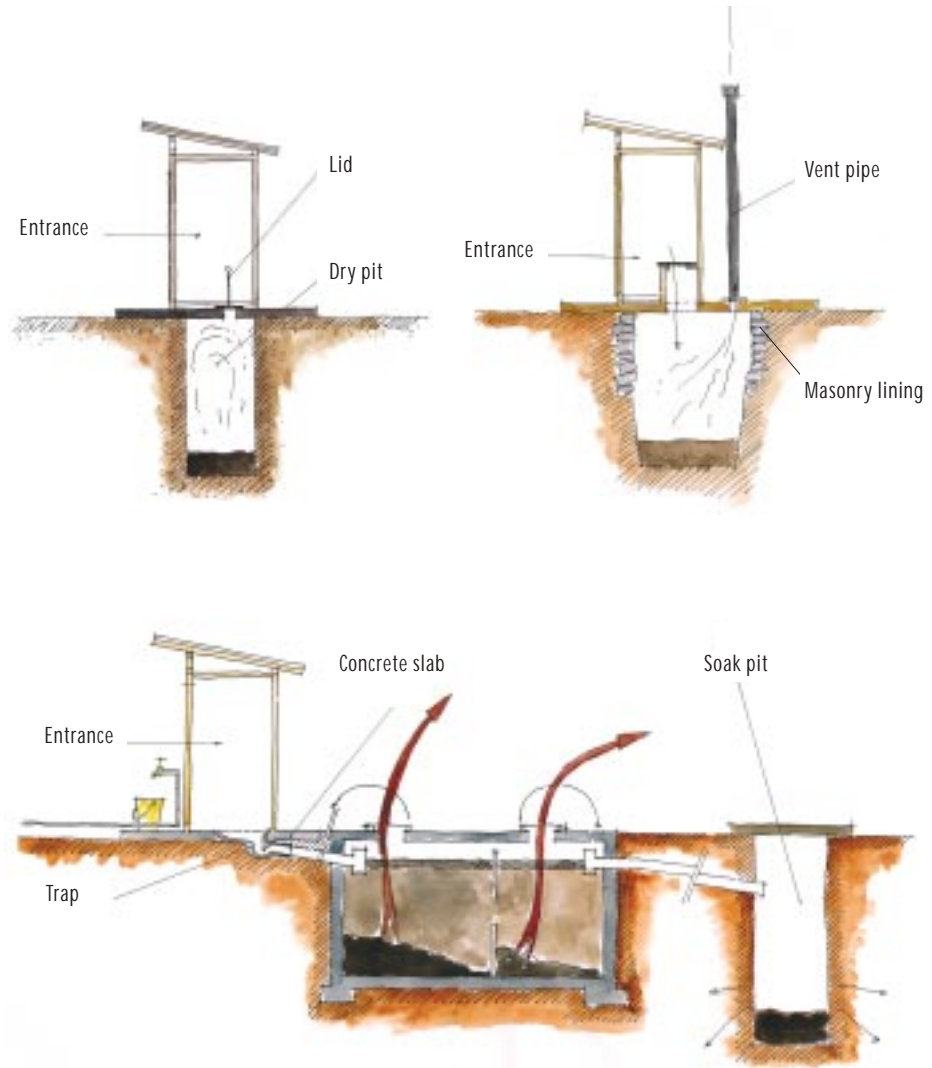

The selection of a type of latrine depends on several factors:

- soil conditions;
- the availability of water and the possibility of removing it to a central sewer or allowing it to percolate into the ground without causing any contamination;
- the type of latrine used in the country concerned and local hygiene practices (cultural considerations are primordial);
- the space available.

In prisons with a capacity of over 100 inmates, the types of latrines generally in use are those where the excrement is flushed away with water, which requires an adequate water supply.

Water-based systems make it possible to remove the excrement to a place outside the prison, thus avoiding any transmission of infectious agents inside the prison compound. In such cases it is important to ensure that no health hazard is created for the neighbouring population by exposing it to infectious agents.

Where there is no possibility of connection to a central sewer, waste water is usually collected in a septic tank. It then percolates in a soak pit or infiltration trenches.

Dry pit latrines are more often used in small prisons which are located far from urban centres and have enough space to allow the digging of new pits to replace those that are full.

Flush latrines

Latrines flushed with water are used in most prisons. They are fitted with a water seal which prevents odours and insects (especially cockroaches) from coming up from the septic tank into the latrines.

Figure 41 shows a type of flush latrine.

Figure 41
Model of flush
latrine

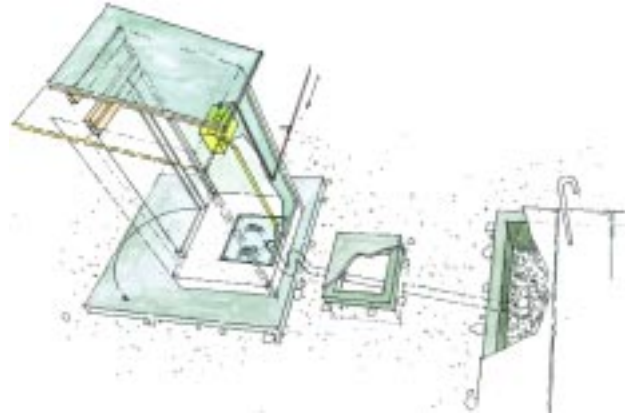

The squatting pan is made of glazed earthenware, plastic or cement. Cement pans have the advantage of being less costly and more robust, but as the surface is not as smooth it is more difficult to clean. It is, however, possible to add to the cement materials which make it smoother and easier to clean. It is estimated that about 2 litres of water are necessary to flush the pan.

In some countries, water is also used for anal cleansing. Buckets and other receptacles can be filled from a tap near the toilets or from a storage tank fed by the water-supply network.

Figure 42 shows a system of this type.

Figure 42
Latrines with
manual flushing
system

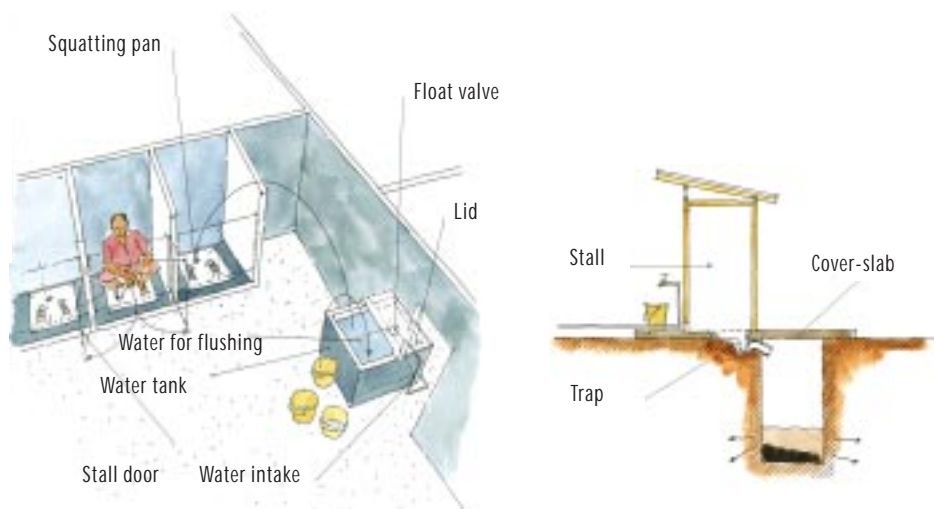

Pour-flush latrines

Pour-flush latrines are a variant of the flush latrines described above. They are installed directly above a septic tank, which must be watertight and is connected to a leaching pit into which the effluent is discharged. The septic tank has to be watertight so that the water seal – comprising a pipe which goes down some 100 to 250 mm below the water level – functions properly and prevents the emanation of foul odours. This type of system is particularly appropriate in situations where there is only a limited water supply.

Figure 43 illustrates this type of latrine.

Figure 43
Pour-flush
latrine

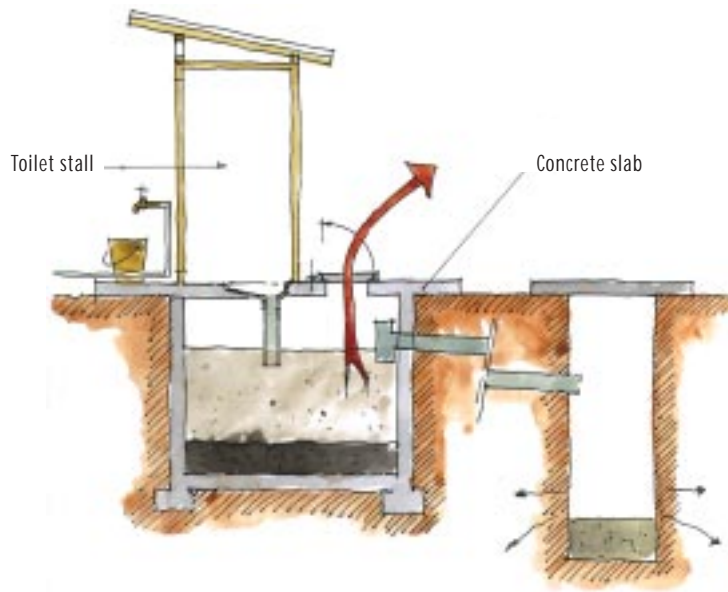

Dry pit latrines

Dry pit latrines are the most simple means of disposing of human waste. They are generally used in refugee camps and small prisons, and when existing latrines are under repair or being desludged.

A dry pit latrine is a hole dug in the ground and covered with planks or a concrete slab.

Depending on the type of soil, it may be necessary to strengthen the sides of the pit to prevent them from caving in. A hole is made in the slab or planks for defecation; it may be fitted with a seat. The hole usually has a cover designed to keep insects (flies, cockroaches) out and to prevent the emanation of foul smells.

A stall is built over the latrine for shelter and to provide privacy for the user. It must be made of light materials so that it is easy to move. Various materials can be used: wood, bamboo, matting, bricks, planks, plastic sheeting, or sometimes galvanized iron.

Figure 44 gives an example of this type of latrine.

Figure 44
Dry pit latrine



The pit will fill at a rate of **40 litres/person/year**.

For a group of 25 people, a pit of at least 1 m³ is necessary to dispose of the waste produced over one year.¹⁵

As it is practically impossible to empty this type of pit, there must be enough space available within the internal security perimeter (accessible to the detainees during the time they spend in the open air) to dig new latrines.

When a pit latrine is full (50 cm below ground level), a new pit is dug and covered with the same slab and protective structure as the old one. The unfilled 50 cm of the old pit are covered with earth. The site of this pit cannot be used again for two years, the time needed for the excreta to break down.

Figure 45 shows a block of dry pit latrines, with a superstructure of metal supports and galvanized iron sheeting placed over individual concrete slabs.

Figure 45
Block of dry
pit latrines



Ventilated improved pit latrines

Latrines can be improved and made self-ventilating by installing in a simple pit latrine a vent pipe topped with flyproof wire netting. The pipe creates a flow of air between the pit and the top of the pipe. Air enters through the defecation hole and is evacuated by the pipe, thus reducing the odour due to the decomposition of excrement.

The wire mesh prevents flies from going in and out of the pit and laying their eggs there. The number of flies in this type of latrine can be 100 times less than in a simple pit latrine. Unfortunately that does not solve the problem of the proliferation of mosquitoes in the latrines, especially where liquids are not very efficiently absorbed by the soil.

The latrines should be quite dark inside to prevent flies being attracted by light filtering through the vent pipe. A spiral construction can be used for the superstructure in order to keep the latrine as dark as possible. Alternatively, a door may be installed and kept closed, but there must be an opening of at least three times the diameter of the vent pipe (about 20 cm x 10 cm).

The orientation of latrines is an important consideration. The door is usually placed so that it faces into the prevailing wind. The vent pipe must be painted black and placed where it is exposed to maximum sunlight, as this will improve ventilation by heating the air in the pipe.¹⁶

Figure 46 gives a diagrammatic view of this type of latrine.

Figure 46
Ventilated improved
pit latrine

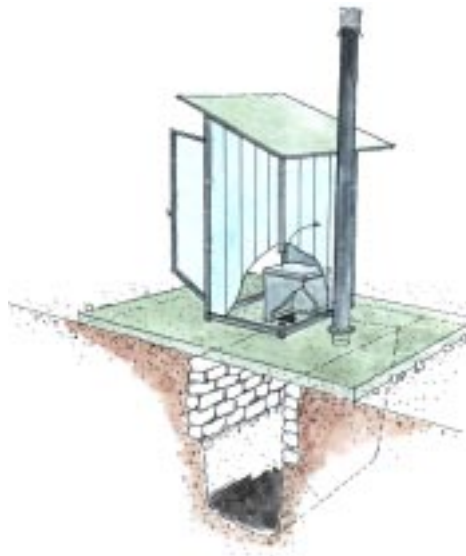

Ventilated improved pit latrines take up the same amount of space as simple pit latrines and fill up at the same rate. Maintenance work is limited to keeping them clean and checking the state of the wire mesh from time to time. The cost of installing them, however, is significantly higher as they require more substantial construction.

Intermittent flush latrines

This type of latrine makes it possible to limit water consumption while ensuring proper flushing.

The latrines – or defecation holes – are placed above a drainpipe which takes the effluent to a septic tank or main sewer. The drainpipe is flushed out from time to time with a large

amount of water to keep it clean and prevent the accumulation of excreta, which often causes blockages (see Figure 47).

Toilet pans, with or without water seals, are placed over the drainpipe.

Figure 47
Intermittent
flushing system
and drainpipe

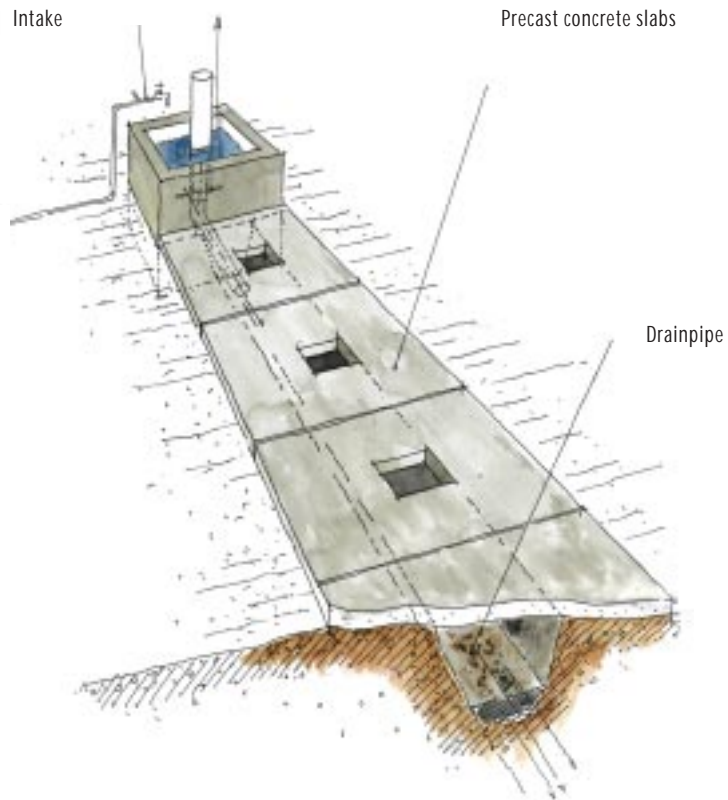
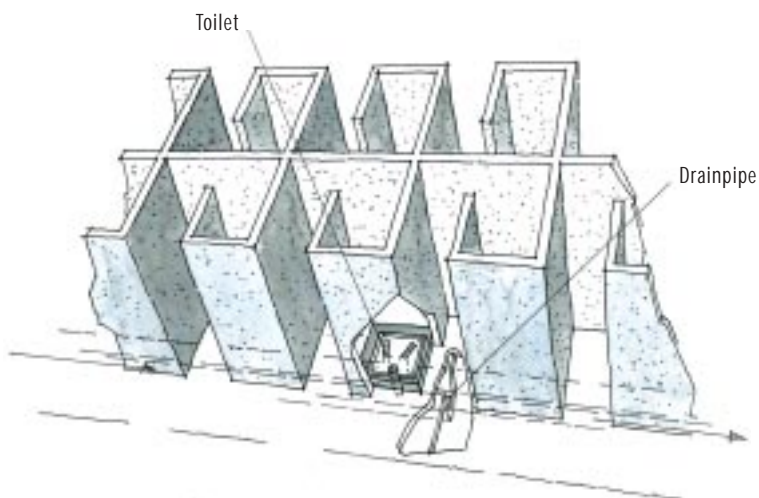

Figure 48 shows a toilet block with a superstructure designed to provide a modicum of privacy without using doors.

Figure 48
Toilet block
placed over
a drainpipe



The drain can also be flushed out by connecting the waste pipe from the showers to that of the latrines (see Figure 49).

Figure 49
Toilet block
connected to showers

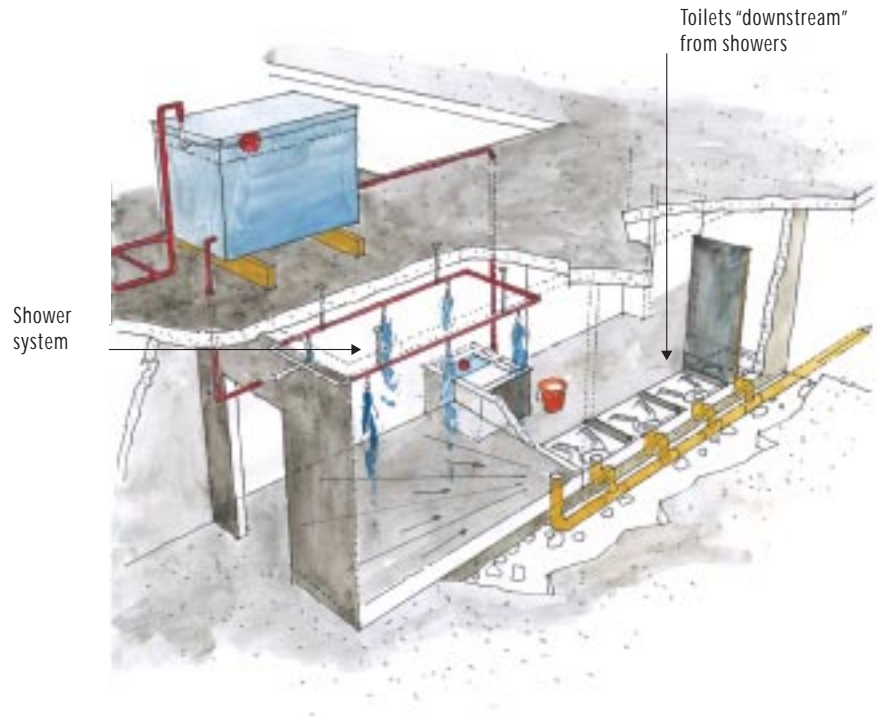

Dimension and slope of drainpipes

The drainpipes must have a diameter large enough to ensure that there is always air above the waste flowing through them. The proper diameter will depend on the number of users, but should never be less than 150 mm.¹⁷

The fall should be sufficient to ensure that the waste flows at a speed which allows self-cleaning. The rate of flow achieved in this way – generally 0.75 m per second – keeps solid matter in suspension while the effluent is going through the pipe.

In practical terms, the fall of the drainpipe should be between 1.25% and 2.5%, that is, 1 m in 40 to 80 m.

The pipes are buried at a depth of about 0.5 m. Extra protection is required if vehicles pass over them.

Inspection hatches

Inspection hatches give access to the drainpipes so that they can be regularly inspected, or unblocked when necessary.

Figure 50 shows the size of an inspection hatch and some indications as to how drainpipes can be unblocked by means of plastic or bamboo rods specially designed for the purpose.

The shape of the hatch makes it easy to insert the rod and unblock the pipe. The manhole covers should be at least 15 cm above ground level so that the inspection hatches do not become flooded during heavy rains.

Figure 50
Inspection hatch and
cleaning process

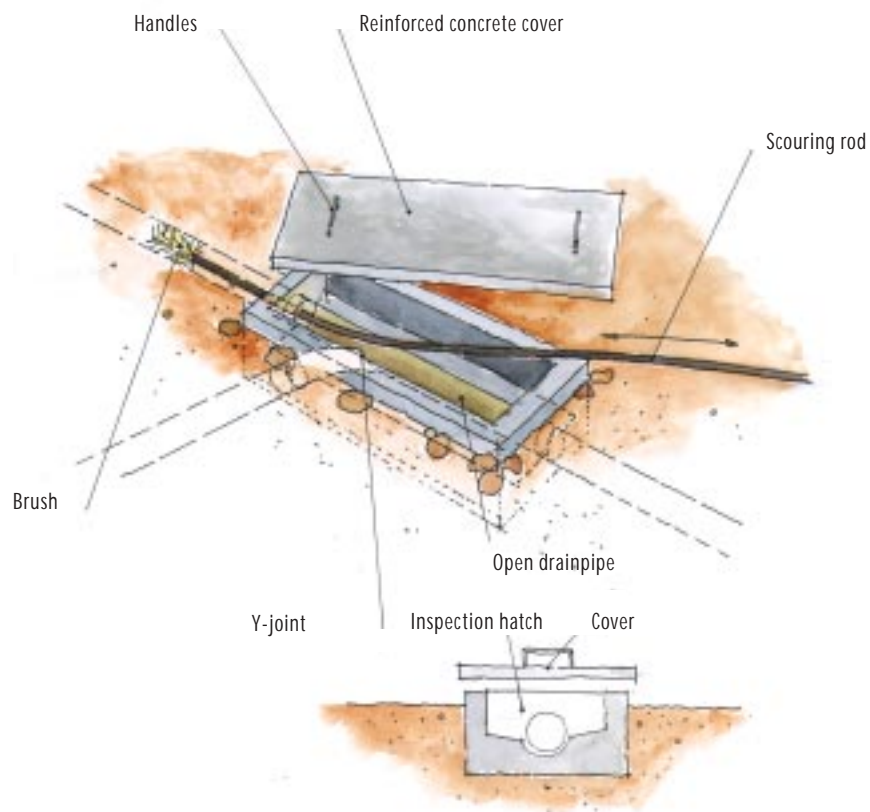

Latrine maintenance

Box No. 10 describes different procedures for the maintenance of latrines and indicates the frequency with which they must be carried out to keep the facilities clean. It also lists the type and quantity of materials needed by the maintenance team.

It is essential to keep latrines clean. Without regular maintenance they will become breeding grounds for diseases transmitted by the faeco-oral route such as diarrhoeal diseases, shigellosis, cholera and typhoid fever.

Proper maintenance means daily sluicing with water and disinfection once a week. In the event of an outbreak of disease, the latrines must be disinfected every day.

The cleaning products required are chlorine-based (see Box No. 6), usually liquid bleach. No other products are necessary.

Weekly washing of the latrine slabs with chlorine-based disinfectants does not affect the fermentation process in the pits. Regular addition of ashes in the pit helps to eliminate the eggs of certain intestinal parasites.

Box No. 10

Latrine maintenance

Maintenance teams are set up under the responsibility of the person in charge of the dormitory or the sector (a floor, a building, the dispensary, etc.). As the average recommended requirement is one latrine per 50 people, and as it may be assumed that it takes two people to clean each latrine, two persons have to be put in charge of cleaning operations for 50 users.





Tasks

Dry pit latrines

- ▶ The slab and the surrounding area must be cleaned **once a day**.
- ▶ The slab and the area around the latrines must be disinfected **once a week** with liquid bleach diluted 1 : 10 (1 litre added to 9 litres of water).
- ▶ If possible, pour ashes into the pit.
- ▶ Check the level of the pit.

Latrines flushed with water

- ▶ Check that there is always water available and fill the tanks regularly.
- ▶ Water used for washing hands should be collected in a bucket and used to rinse the pan. Make sure that no water is wasted.
- ▶ The pan and the surrounding area must be cleaned **once a day**.
- ▶ The slab and the surrounding area must be disinfected **once a week** with liquid bleach diluted 1 : 10 (1 litre added to 9 litres of water).
- ▶ If the latrines become clogged, unblock them without delay.
- ▶ Ensure that the drainpipe is functioning properly by looking in the inspection hatches.
- ▶ Check the level of the septic tank once a week.
- ▶ Inspect the soak pit and its surroundings once a month.

Equipment required by the maintenance team

Personnel

- ▶ 1 pair of rubber boots
- ▶ 1 pair of rubber gloves
- ▶ 1 plastic apron (for use only during unblocking operations)

Materials

- ▶ 1 scraper for cleaning wet surfaces
- ▶ 1 broom
- ▶ 1 scrubbing brush
- ▶ 2 plastic buckets (for the chlorinated solution)
- ▶ Liquid bleach prepared from HTH (70% active chlorine)

Urinals

In some situations it may be necessary to install urinals in the exercise yards. Urinals must be connected to the drainpipes leading to a septic tank or main sewer. Where this is not possible, a percolation system – a sort of small soak pit – must be installed.

Figure 51 shows this type of urinal.

Figure 51
Urinal in
exercise yard



Soil buckets or sanitary pails

Where there are no latrines inside the cells or dormitories and the inmates do not have access to the sanitary facilities at all times, soil buckets or sanitary pails with lids must be provided.

It is essential that these receptacles be emptied every day into a latrine pit or a trench used only for this purpose.

Figure 52 shows a bucket of this type.

Figure 52
Soil bucket or
sanitary pail



Material for anal cleansing

Where there is no toilet paper and it is not the local custom to cleanse the anal area with water, the detainees will use all sorts of materials to wipe themselves: stones, plastic, rags, leaves, newspaper, etc., which will then block the drains. To prevent such objects from falling into the drainpipe, gratings may be installed, but these have to be cleaned constantly because they quickly become clogged. The soiled material removed from the grating must be disposed of properly.

Figure 53 shows an installation of this type.

Figure 53
Grating for retaining
material that may
block drains

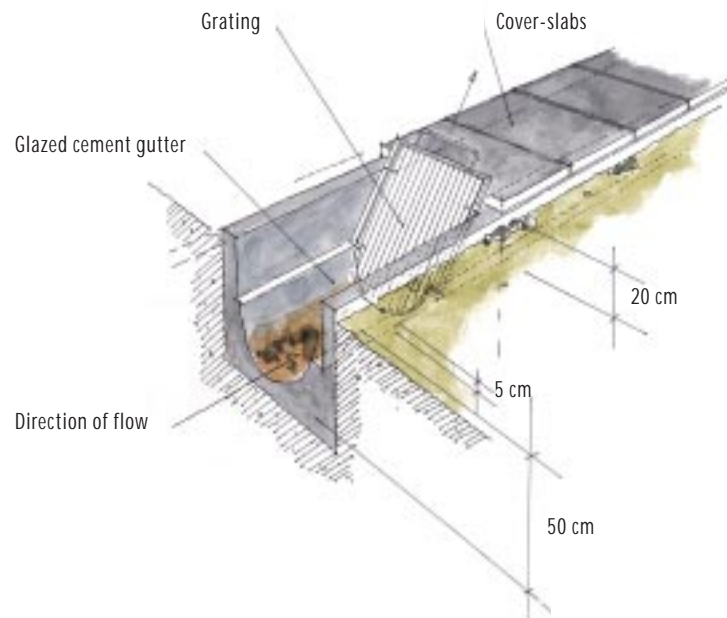

3. 3 Septic tanks

The purpose of a septic tank is to liquefy solid matter, thus facilitating its sedimentation and bacterial degradation. The septic tank prepares waste water coming from toilets, showers, dispensaries, etc., for treatment by the soil or for collection in a main sewer.

Rainwater must not be allowed to flow into a septic tank.

The processes that occur in a septic tank are as follows:

- sedimentation;
- the formation of scum;
- digestion and solidification of sludge;
- stabilization of liquids.

In practice, T-joints (tee-shaped fittings) are used for the inlet and outlet pipes. It is important to install these pipes as high as possible in order to achieve maximum net capacity.

Figure 54 illustrates the different stages in the construction of a septic tank.

Figure 54
Stages in the
construction
of a septic tank

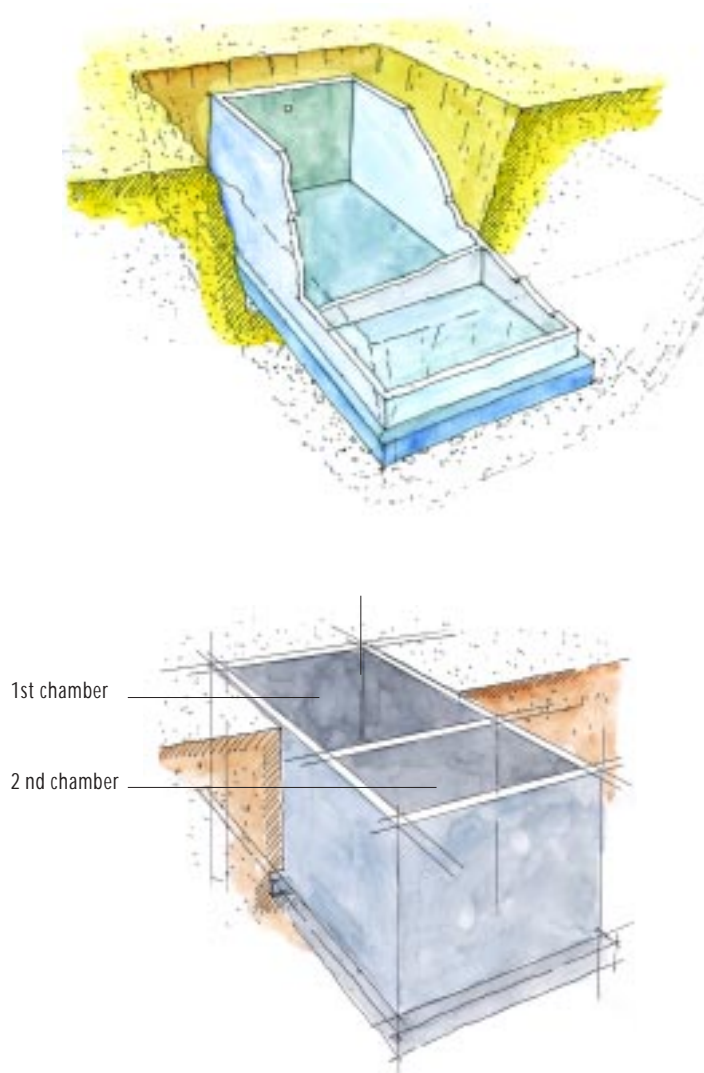

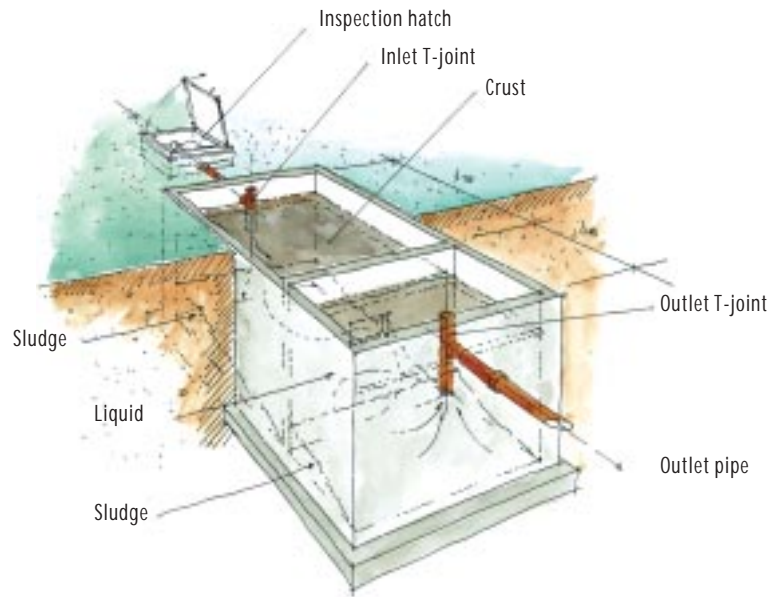

Calculating the capacity of a septic tank

The net capacity of a septic tank is determined by retention time. "Retention time" means the average length of time that the waste water remains in the tank and during which the waste liquefies and sediments. In countries with a hot climate, it is considered that retention time must be at least 24 hours for large tanks. The tank must have a capacity that corresponds to the volume of waste water produced during one day, taking into account the volume of the non-soluble matter which accumulates at the bottom of the tank. The tank must be pumped out when one-third of it is filled with sludge.

Box No. 11 explains how to calculate the dimensions of a septic tank designed to serve 1,000 people. If the daily production of waste water cannot be determined, the requisite net capacity of the tank may be estimated on the basis of the empirical figure of **50 litres per person**.

Figure 55 gives the dimensions of a tank composed of two compartments with a total net capacity of 40 m³.

Figure 55
Dimensions of a
40-m³ septic tank

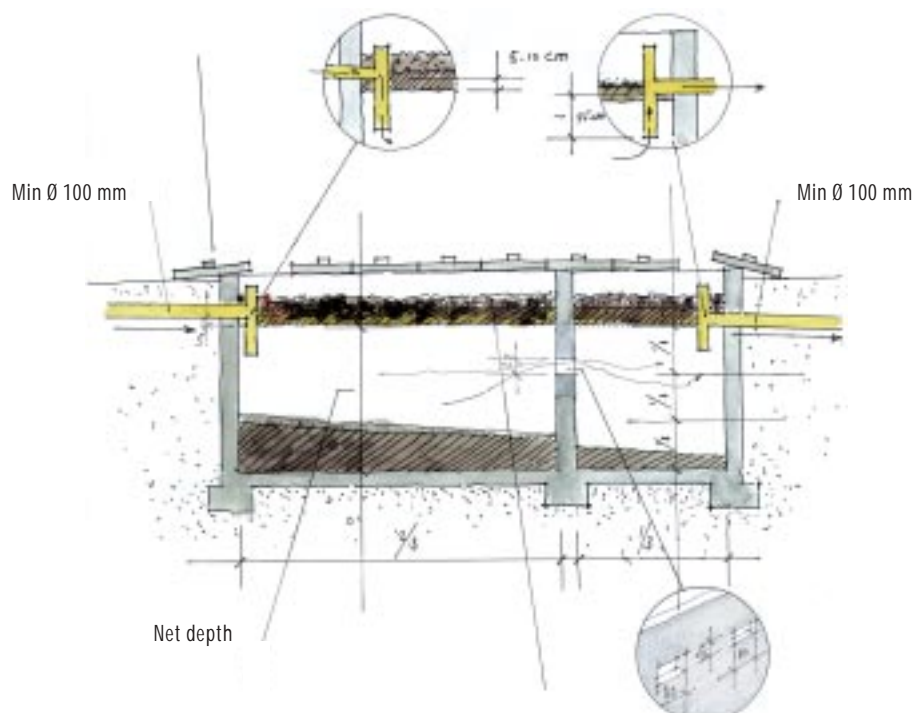

When the tank is being built, a space of 0.3 to 0.5 m must be left above the level of the liquid so as to leave room for scum and for the inlet and outlet pipes.

Box No. 11

Calculating the dimensions of a septic tank for 1,000 people

according to the method of Franceys *et al.*

Parameters

P = number of people using the tank 1,000

V = daily volume per detainee 10 litres/day/person, of which 80% end up in the tank

S = sludge and scum accumulation rate between 30 and 40 litres/person/year

This is the figure used for boarding schools.¹⁸ It is estimated to be 25 litres/person/year in septic tanks which receive only black water, and 40 litres/person/year when the tank receives household waste water as well.

n = number of years between desludging operations

F = sizing factor, which relates sludge digestion rate to temperature and interval between desludging operations.

Varies according to temperature and number of years between desludging operations.

Value of F

NUMBER OF YEARS BETWEEN DESLUDGING OPERATIONS	AMBIENT TEMPERATURE		
	> 20° C	> 10° C	< 10° C
1	1.3	1.5	2.5
2	1.0	1.15	1.5
3	1.0	1.0	1.27

24-hour retention capacity: $V = P \times V$

Volume for accumulation of sludge and scum: $B = P \times n \times F \times S$

Total capacity

= V (24-hour retention capacity) + B (volume necessary for accumulation of sludge and scum).

If the value of 1.5 is used for F, 1 for n, and 8 litres for the input of black water, the total capacity of the septic tank for a population of 1,000 detainees is 53 m³.

The capacity calculated by means of this formula is highly dependent on the value used for the accumulation of sludge on the one hand, and on the frequency of desludging operations on the other.

Principles to be observed in calculating the dimensions of a septic tank¹⁹

Basically, this means determining the length, breadth and depth of the tank.

- Preference should be given to tanks with two compartments.
- For a tank with a breadth of B, the length of the first compartment will be 2 B, and that of the second compartment equal to B.
- The depth of liquid D from the bottom of the tank and the outlet pipe must be at least 1.2 m.
- The distance between the level of the liquid and the lowest point (intake) of the outlet T-pipe must be the net depth (D) divided by 2.5.

- Usually, one or two 20 x 40-cm openings are pierced in the wall separating the two compartments, two thirds of the way between the bottom of the tank and the outlet pipe.
- The horizontal outlet pipe must be between 5 and 10 cm lower than the inlet pipe to allow the liquid to flow into the soak pit.
- The inlet and outlet pipes must be at least 100 mm in diameter.
- Manholes must be positioned above the inlet and outlet pipes for inspection and desludging operations.
- A vent pipe topped with flyproof wire netting must be installed above the septic tank.

Figure 55 shows the correct proportions.

Practical tips

The following principles must be observed:

- when the septic tank is first brought into service it must be filled with water; it may be seeded with sludge from another tank so as to activate the digestive process;
- the tank should not be at too great a distance from flush latrines because excreta do not travel far without large quantities of water; it may be necessary to install several septic tanks;
- septic tanks should be outside the internal security perimeter so as to facilitate access for desludging operations;
- they should be located in a place easily accessible to vacuum trucks;
- there must be enough space to install a soak pit or a system of percolation trenches.

In Figure 56, two septic tanks have been entered on the plan of the prison in accordance with the requirements set out above. They are easily accessible from the outside and are also near flush latrines. Their location makes it possible to take action in the event of any problem, and there is enough space around them to install additional soak pits or even percolation systems.

This example illustrates a simple situation.

Figure 56
General plan of the prison and sewage disposal system

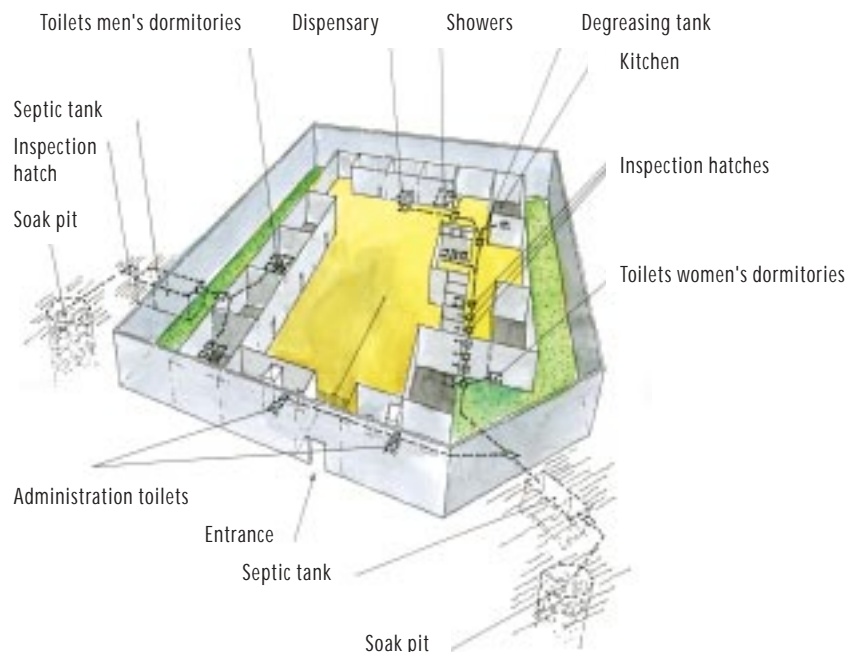

There are greater difficulties to be overcome in prisons located in urban areas, where space is usually at a premium. In such cases septic tanks are often inside the security perimeter, in the exercise yards, which makes maintenance difficult. If they become clogged and overflow, they constitute a serious health hazard for the detainees.

Regular inspection

Septic tanks have to be inspected at least once every three months.

This is particularly important if the number of detainees exceeds the prison's official capacity (overpopulation). In such a case the capacity of the septic tank will be insufficient, retention time will no longer be observed and the liquid flowing out will contain far too much solid matter in suspension. The inevitable result is that percolation in the soak pits will slow down, the sides will become clogged more rapidly, and the pits will overflow.

The purpose of inspection is to determine whether the sludge level has reached one-third of the depth of the tank (desludging required), and to check that the inlet and outlet T-pipes are not clogged by an excessive accumulation of sludge.

Figure 57 shows the different stages of inspection, and Box No. 12 describes the procedure.

Measuring sludge thickness

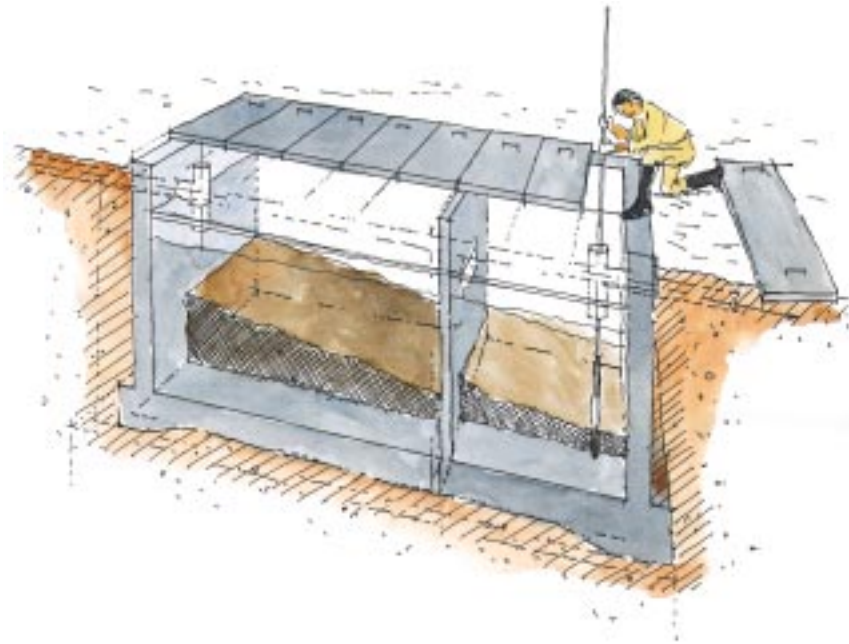

Figure 57
Inspection of
a septic tank

Box No. 12

Inspection of a septic tank

► To be carried out every three months at least

Assessing the thickness of the various layers

1. Wear a plastic apron and rubber gloves.
2. Remove the covers of the inspection hatches over the inlet and outlet pipes.
3. Inspect the sides of the tank between the surface of the crust and the top of the tank to see if there are any signs of overflow.
4. Take a rod at least 4 metres long and plunge it into the crust, noting any changes in resistance; less resistance means that the rod has gone through the thickness of the crust.
5. Push the rod down further until it again encounters resistance, to determine the depth of the liquid layer.
6. Push the rod down until it touches the bottom of the tank.
7. Pull the rod out.
8. Sometimes the thickness of the three layers can be seen on the rod, as the marks left by the liquid, the sludge and the crust are different.
9. Record the measurements observed in the maintenance logbook.
10. Determine the approximate date of the next desludging operation; plan or arrange to have the work done; identify a suitable place for dumping the sludge.

Figure 58
Inspection of
a septic tank

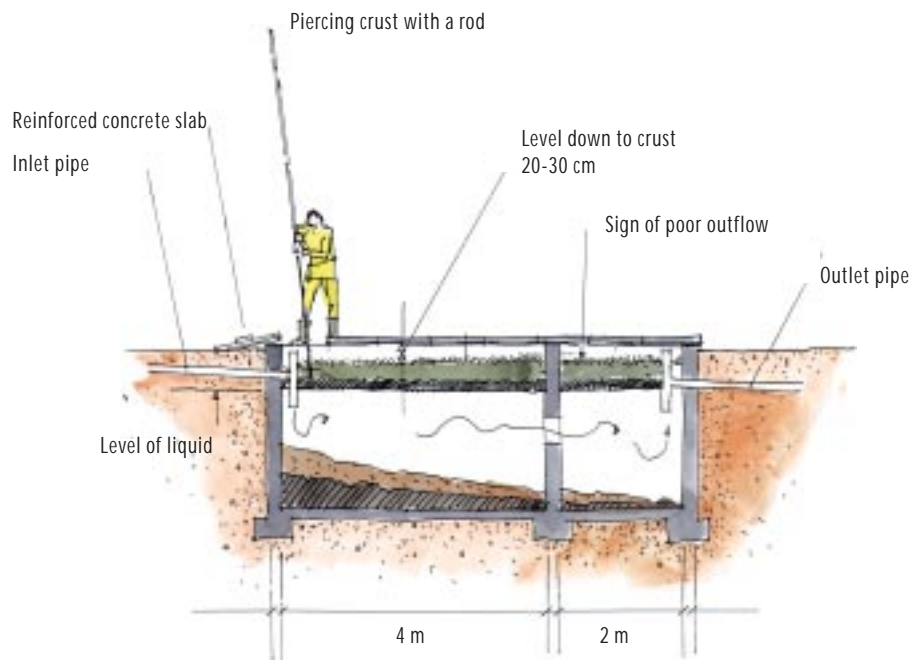

To facilitate regular inspection of a septic tank, when the reinforced concrete slabs are being poured manholes should be installed just above the inlet and outlet T-pipes. This will allow inspection without the lifting of heavy slabs (see Figures 58, 59, 60 and 61).

Figure 59
Manhole and
inspection hatch

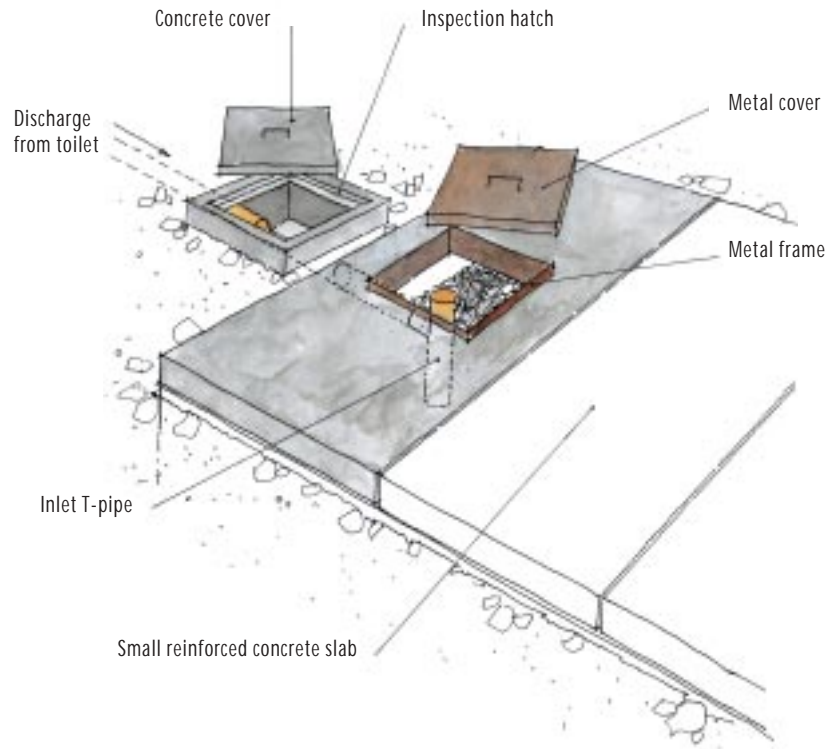

Figure 60
Detail of joints

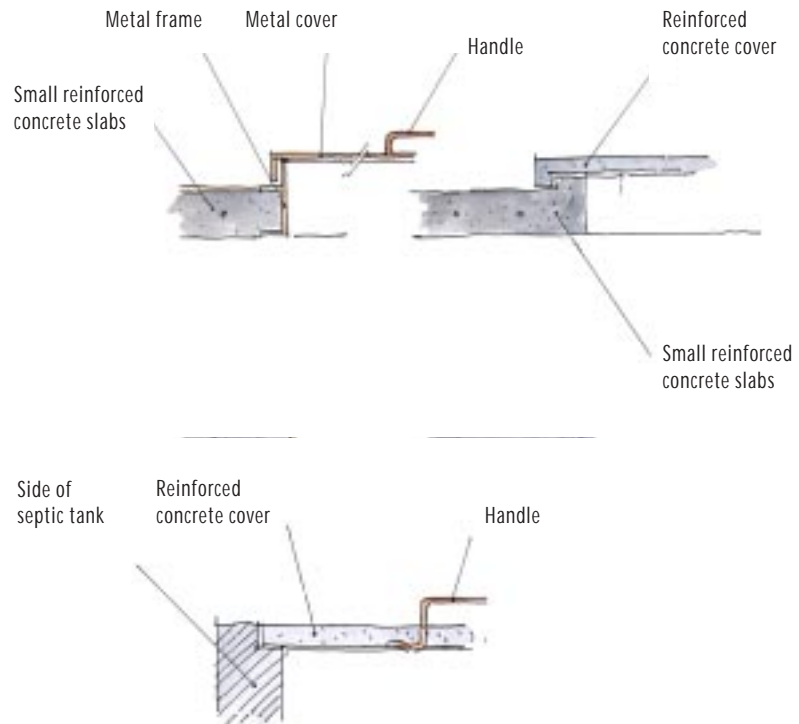

Figure 61

Tools needed
for inspection
of a septic tank



Desludging a septic tank

The rule is that a septic tank must be desludged when the level of sludge reaches one-third of the total depth.

The tank may be desludged by means of a **tanker truck** fitted with a pump. Even if the tanker is in good working order, its sludge suction capacity will be limited to a certain distance,²⁰ usually a maximum of 60 metres. This has to be taken into account if the tank is inside the prison where the truck has no access.

A **membrane or submersible pump** specifically designed to pump out solids is another mechanical means of desludging a septic tank.

Figure 62 shows an example of a desludging operation.

Figure 62

Pump truck
desludging
a septic tank

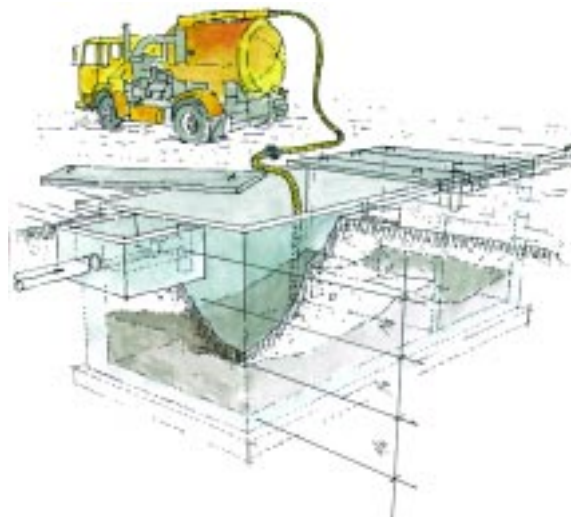

Pumps must be part of the basic equipment of any prison administration. Where this is not the case, private firms must be officially appointed to carry out desludging operations under the supervision of the local sanitation authority.

Systematic planning of the desludging of septic tanks must be among the specified tasks of the relevant department of the prison administration.

Manual desludging

Septic tanks can be desludged manually by means of buckets, which are generally attached to metal rods in order to make it easier to penetrate the sludge. The sludge

and scum are dumped into pits dug nearby. **The tank should never be completely emptied**; some deposit should be left to maintain the digestion process.

Manual desludging operations entail a health risk for those who do the work. It is therefore essential that they be issued with **protective equipment** such as rubber boots and gloves and plastic aprons.

Figure 63 shows the desludging procedure and the materials and equipment required.

Figure 63
Manual desludging
of a septic tank

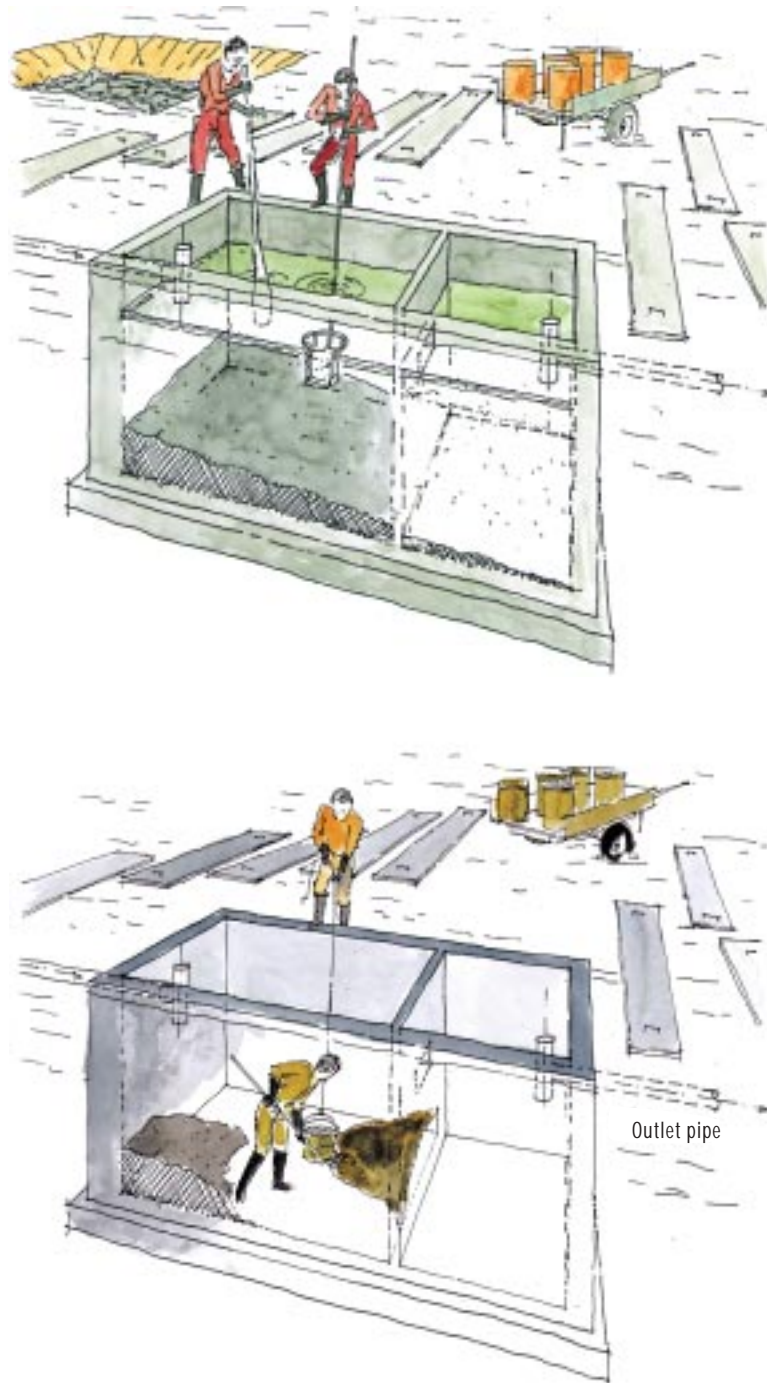

Disposal of effluent from septic tanks

The water from flush latrines which flows into a septic tank has to be removed and disposed of. The water flowing out of the tank (effluent) still contains pathogenic organisms, so it has to be eliminated safely.

At this stage the water still contains large amounts of organic matter. The amount depends on the quantity of suspended matter per unit of volume. This value is expressed as BOD₅ (biological oxygen demand/litre measured over 5 days), which represents the amount of oxygen necessary to oxidize and degrade the organic substances in the faecal matter in suspension in the water. There may be as much as 20,000 mg/l (milligrams per litre) of organic matter in the water at the outlet from the septic tank. This figure should be no higher than 20 mg/l at the end of treatment, when the water is released into the environment, usually into a river or stream.

When the water from the septic tank is discharged into an **urban main sewer**, there is no problem as long as it can flow into the sewer by gravity.

Care must therefore be taken to:

- use drainpipes of suitable dimensions;
- ensure that the fall is sufficient to allow the effluent to flow through the pipes;
- install inspection hatches so that the drains can be checked and unblocked when necessary.

These operations are usually carried out by the public works department or by private firms.

The effluent from septic tanks is often discharged into **soak pits** or **drainage trenches** so that it percolates into the soil. The amount of effluent that can be absorbed will depend on the permeability of the soil, so it is important to allow as little water as possible to end up in the septic tank. If the soil has a low absorption capacity, water from the kitchens and from showers and laundry should not be discharged into the septic tank, as this water is far less hazardous than water from the toilets.

Infiltration capacity of the soil

The infiltration capacity of the soil depends on its nature, its porosity, the level of the water table, and the efficiency of the digestive process in the septic tank. The speed with which the pores of the absorbent side walls of soak pits or drainage trenches become clogged with sludge will depend on the amount of solid matter in suspension in the effluent. When these pores become clogged, absorption will slow down.

The infiltration capacity of the soil – that is, the ability of the ground to absorb effluent from a septic tank – is measured by means of a **percolation test**. The dimensions of the infiltration system can then be determined on the basis of the results obtained.

Box No. 13 gives values for the infiltration capacity of various types of soil in litres/m²/day.

Box No. 13

Infiltration capacity of some types of soil

TYPE OF SOIL	INFILTRATION CAPACITY, DECANTED EFFLUENT (in litres per m ² per day)
Coarse to medium sand	50
Fine sand, loamy sand	33
Sandy loam, loam	25
Porous silty clay and porous silty clay loam	20
Compact silty loam, compact clay silty loam and non-expansive clay	10
Expansive clay	<10

Source: US Environmental Protection Agency, 1980

The procedure for performing a percolation test is described in **Box No. 14** and in **Figure 64**.

Figure 64
Percolation test
for determining
infiltration capacity

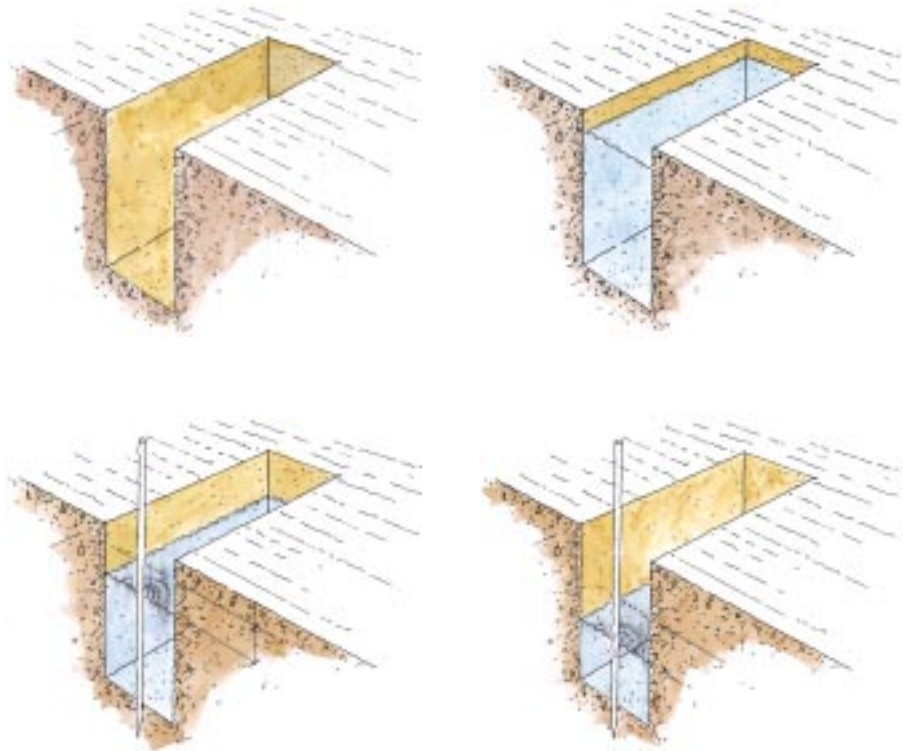

To determine infiltration capacity:

- Dig several holes one metre long, one metre deep and 0.5 metre wide. Position the holes in such a way as to determine the average infiltration capacity of the area concerned.
- Fill the holes with water and let it infiltrate so that it saturates the ground, adding more water from time to time to fill up the holes.
- When the ground is saturated, add water up to the mark indicating the position where the drainpipe will be installed.

- Allow the water to percolate, and measure the rate at which the water level falls over time. This is the value that indicates the infiltration capacity of the soil.

For practical reasons, the percolation test is carried out using clean water. The test gives indicative values which are then compared with the values given in the specialized literature.²¹

The surface area to be taken into account is the area below the liquid level. In the case of an infiltration trench it is the area of **each side**; and for soak pits it is the area of the sides below the average water level. The percolation test should be performed at the end of the rainy season, when the level of the water table is at its highest.

Care must be taken to avoid the risk of contaminating the groundwater table, especially where the soil is coarse and highly permeable.

Box No. 14

Procedure for determining the infiltration capacity of the soil

Percolation test (simplified procedure)

- ▶ Dig at least three holes 50 cm wide, 1 m long and 1 m deep in each zone to be investigated. A minimum of three holes is necessary to obtain an average value.
- ▶ During the night, and at least 4 hours before the test, fill the holes with water and top them up from time to time.
- ▶ The next morning, or 4 hours later, fill the holes with water to a height of 70 cm, that is, the approximate height at which the drainpipe will be placed.
- ▶ Measure the fall in the water level after 30 minutes, then after 90 minutes.
- ▶ Measure the differences in level between the two readings; this will give the infiltration rate in one hour.
- ▶ In fact this is only an approximation, because when the water level falls the infiltration area becomes smaller. Strictly speaking, the new area should be calculated every time. However, the test as described makes it possible to determine whether the soil is sufficiently absorbent.

The following table gives the results for a test performed with clean water in a fictitious case.

FALL IN WATER LEVEL (CM)	VOLUME (LITRES)	INFILTRATION AREA	LITRES/M ²	LITRES/M ² /DAY
0.5	2.5	2.0	1.25	30
1.0	5	2.0	2.50	60
1.5	7.5	2.0	3.75	90
2.0	10	2.0	5.00	120
2.5	12.5	2.0	6.25	150
3.0	15	2.0	7.5	180
3.5	17.5	2.0	8.75	210
4	20	2.0	10.0	240
5	25	2.0	12.5	300
10	50	2.0	25	600





In practice, as the effluent contains solid matter in suspension, the rate of infiltration is slower. This has to be taken into account by introducing a correction factor. As an initial approximation, it is considered that the values obtained with clean water should be divided by a factor of 10, or even of 20.²² If the values shown in the table are taken as a basis, it is considered that the soil has a sufficient infiltration capacity when the water level falls by 4 cm in one hour in each test hole. In other words, it may be estimated in such a case that the soil is capable of absorbing about 25 litres of effluent per day per m².

When it is not possible to perform these tests, the empirical value of **10 litres of effluent per m² per day** may be used. This is an estimate that can be applied to a wide range of soil types.

Soak pits

The function of a soak pit is to allow the effluent from a septic tank to percolate into the ground (see **Figure 65**). The required dimensions of the infiltration area will depend on the results of the percolation tests.

When a soak pit is being built, some rules have to be observed:

- its capacity must correspond to the output of the septic tank;
- it should be between 1.5 and 2.5 metres in diameter;
- the pit must be lined with bricks or concrete blocks with open joints;
- the 50-cm space at the top must be reinforced with masonry to prevent it from caving in;
- the pit must be filled with stones or broken bricks;
- it must be located far from dwellings and water distribution points;
- the bottom of the pit should be at least one metre above the level of the water table during the rainy season;
- where the level of the water table is high, it is preferable to use infiltration trenches.

Figure 65
Cross-section of
a soak pit

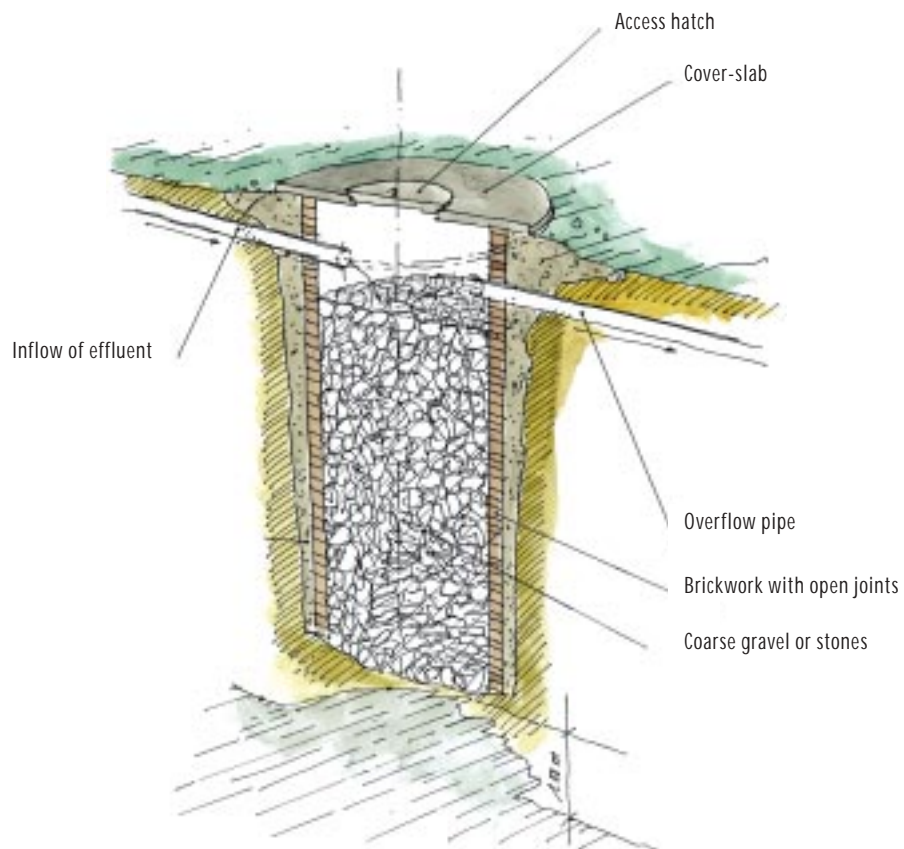

Soak pits are efficient only where the ground is highly permeable.

The larger the diameter of the pit, the greater the infiltration area, but also the greater the volume of soil to be excavated. It is therefore preferable to build two pits each with a diameter of 1.5 m than one pit 2.5 m in diameter, as shown in **Figure 66**, which gives the values for each of these options.

Figure 66
Volume and surface
area of soak pits
with two different
diameters

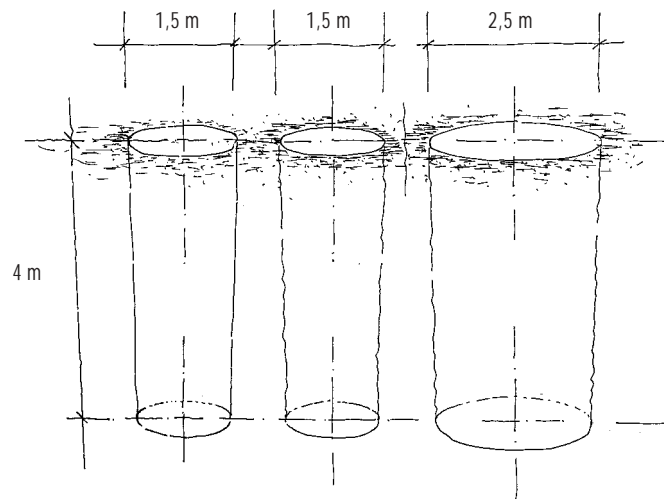

1.5 m diameter:

Infiltration area

for two pits: 39.6 m²

Volume to be excavated: 14.12 m³

2.5 m diameter:

Infiltration area

for one pit: 31 m²

Volume to be excavated: 19.6 m³

In most situations it is preferable to use infiltration trenches, which distribute the effluent over larger surfaces.

Infiltration (or drainage) trenches

These make it possible to dispose of large amounts of water or effluent and constitute an alternative to soak pits in the following circumstances:

- poor soil permeability;
- high-level water table;
- presence of rocky strata near the surface;
- relatively large area available for digging trenches.

The dimension of the trenches is calculated on the basis of the results of the percolation tests, or of the figure of **10 litres per m² per day**, taking into account that the volume of effluent to be treated may increase.

Box No. 15 explains the procedure to be followed in installing the drainage trenches necessary for infiltration of the effluent, estimated at about 4.5-5 m³/day, discharged from the septic tanks of a prison with a population of 250 to 300 detainees.

The trenches are dug to a width of between 30 and 50 cm and a depth of 60 cm to 1 m.

The drainage pipes are then laid on a bed of gravel with a fall of 0.2-0.3%. Plastic pipes 100 mm in diameter with perforated sides and bottom, or cement pipes with open joints, may be used (see **Figure 67**).

Figure 67
Types of drains
and effluent
distribution chamber

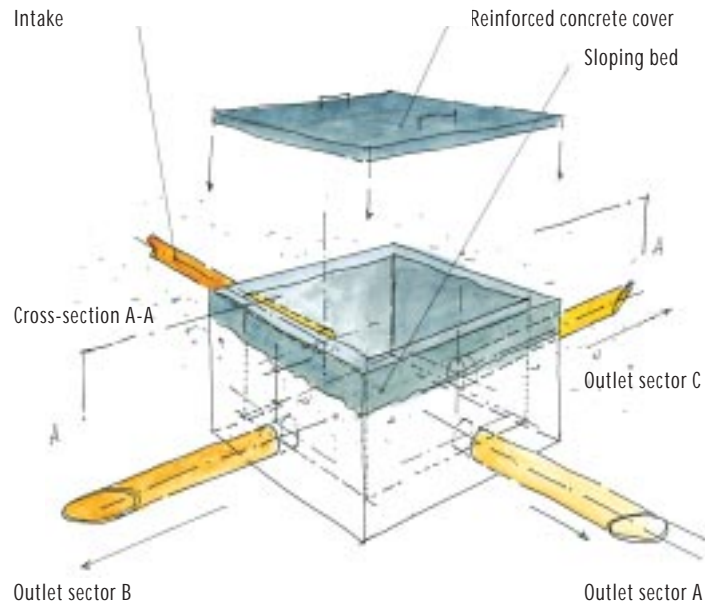
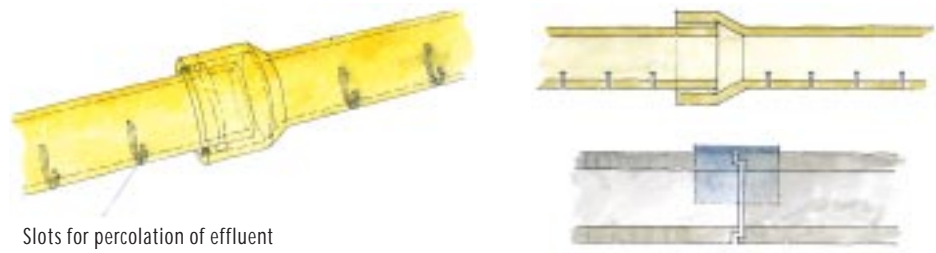

Subsequently the drains are covered with gravel and plastic sheeting, to avoid the infiltration of rainwater and to prevent the trench from becoming filled with earth.

Figure 68 shows a cross-section of a drainage trench, and Figure 69 shows the layout of an infiltration system which ensures distribution of the effluent over the entire infiltration bed.

Figure 68
Cross-section of a
drainage trench

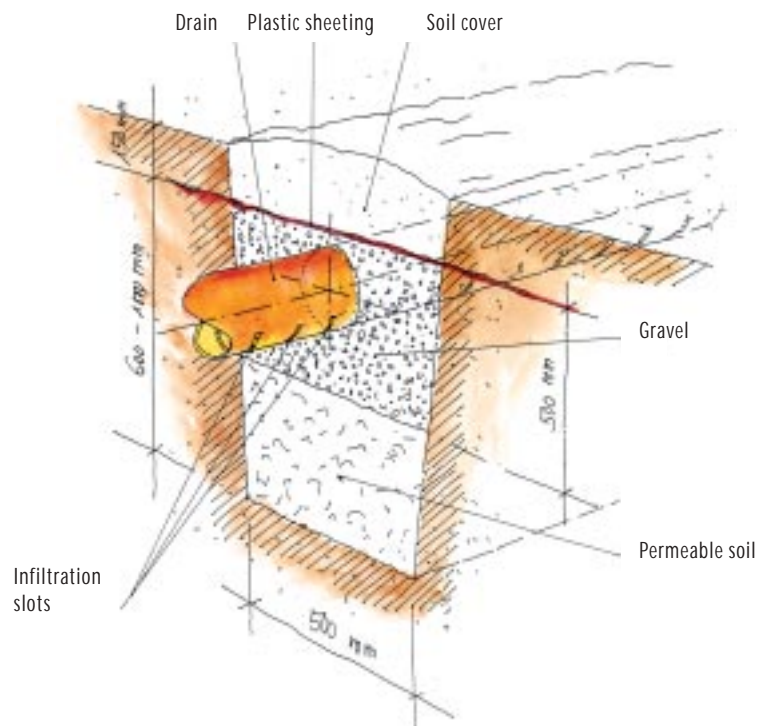
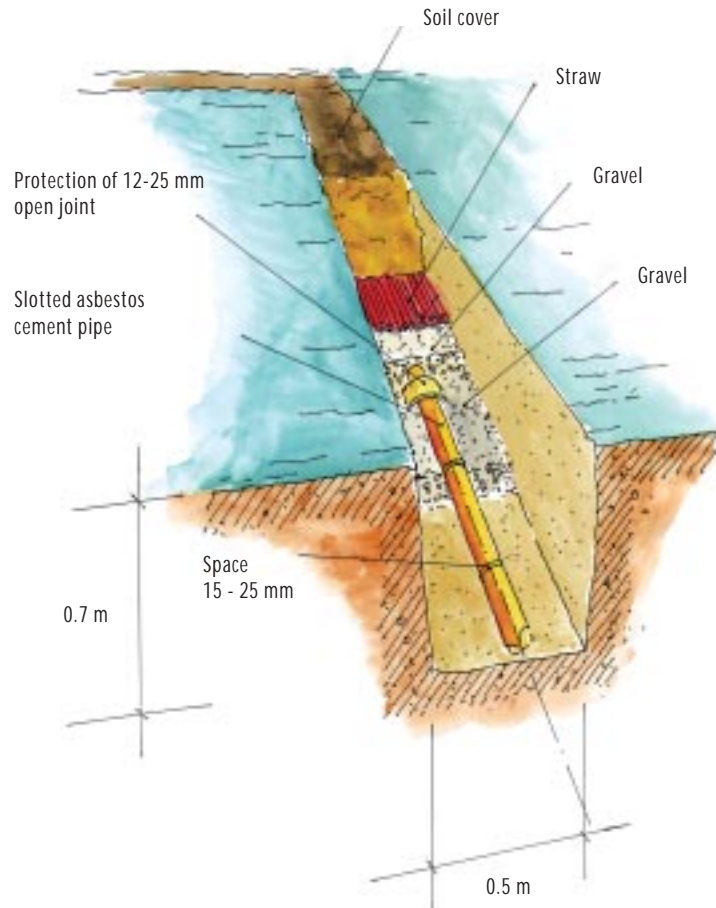

Figure 69
Layout of an
infiltration trench



Variants

In very hot, dry climates, the phenomenon of evapotranspiration by plants can be put to use. In this case the drains are laid closer to the surface and no plastic sheeting is used. The length of the trenches will depend on the climate and the amount of water absorbed by the species planted over them; this can be determined only empirically.

Box No. 15

Calculating the dimensions of drainage trenches: an example

The prison holds 250 inmates and this number may increase up to 300. Water consumption is about **15 litres per person per day**. It is not possible to carry out percolation tests but the ground does not seem very absorbent. In the absence of a measured value, the figure of **10 litres per person per day** will be used. It is estimated that an infiltration capacity of some 5,000 litres per day will be necessary.

Dimensions

- ▶ To treat 10 litres/m²/day, a net infiltration area of 500 m² is required, that is, trenches 250 m long if it is considered that every linear metre gives an effective area of 2 m² (1 m each side). In practice, trenches will be no longer than 30 to 40 m.
- ▶ Thus 6 trenches 40 m long will be dug, a figure slightly smaller than the length calculated. In view of the average prison population, however, 240 m should suffice.
- ▶ The distance between two parallel trenches must be at least 2 m.





- ▶ A relatively flat area of about 12 m x 40 m is therefore required.
- ▶ The effluent flows out of the septic tank into a chamber which distributes it among the various trenches. The openings leading out of the chamber are not at exactly the same height. When one trench is overloaded, the level of effluent in the chamber rises and the surplus is directed into another drainage trench through a slightly higher opening.

Figure 70 gives an idea of a drainage bed.

Figure 70
Drainage bed or
infiltration field

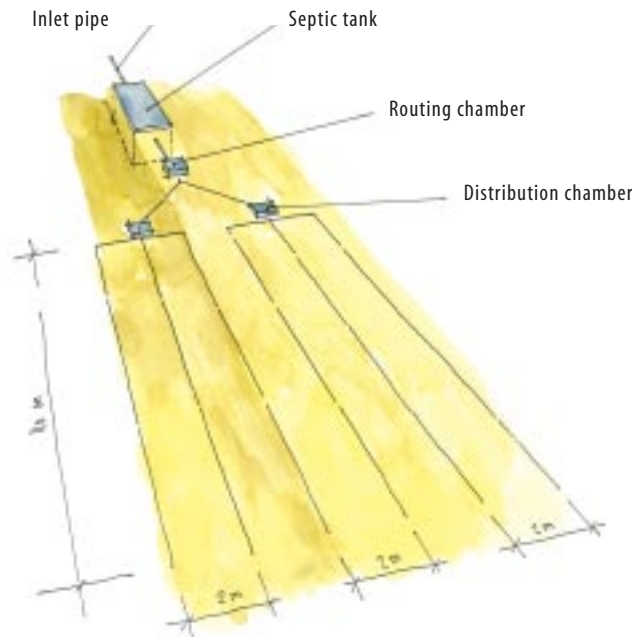

Stabilization ponds (lagooning)

When the soil is not suitable for the infiltration of effluent discharged from a septic tank and there is no main sewer, the only solution is to install stabilization ponds (lagooning).

These are rectangular ponds in which organic matter is treated by natural biological processes involving both algae and bacteria. In hot climates this is the most effective way of eliminating pathogenic bacteria and the eggs of intestinal parasites.

Stabilization ponds also have the advantage of being relatively inexpensive to install and requiring little maintenance. Construction of a pond will depend on topography and available space (see **Box No. 16**). When the waste water has been previously treated in a septic tank, the area required will be much smaller.

The ponds must be located far enough from dwellings to ensure that the inhabitants are not bothered by mosquitoes and foul odours.

Facultative ponds

Facultative ponds, situated downstream from the stabilization pond, promote anaerobic processes at the bottom of the ponds and at the surface of the water. The organic matter in the waste water is degraded by bacteria and by the algae that proliferate on the surface, where light favours their growth by photosynthesis. These algae give the ponds their characteristic green colour. For photosynthesis they need the

carbon dioxide furnished by the atmosphere or by the metabolic processes of the bacteria in the lower levels of the pond.

Figure 71, adapted from Cairncross,²³ shows the symbiotic processes that operate in stabilization ponds and the way in which organic substances are degraded.

Figure 71
Diagram showing degradation of organic matter in the treatment process

- | | |
|---------------------------------|------------------------------|
| 1 BOD on entry | 6 BOD in effluent (soluble) |
| 2 Decantable solids | 7 Light (UV) |
| 3 Soluble fermentation products | 8 BOD discharged in gas form |
| 4 BOD destroyed | 9 Algae-symbiosis-bacteria |
| 5 BOD in effluent | |

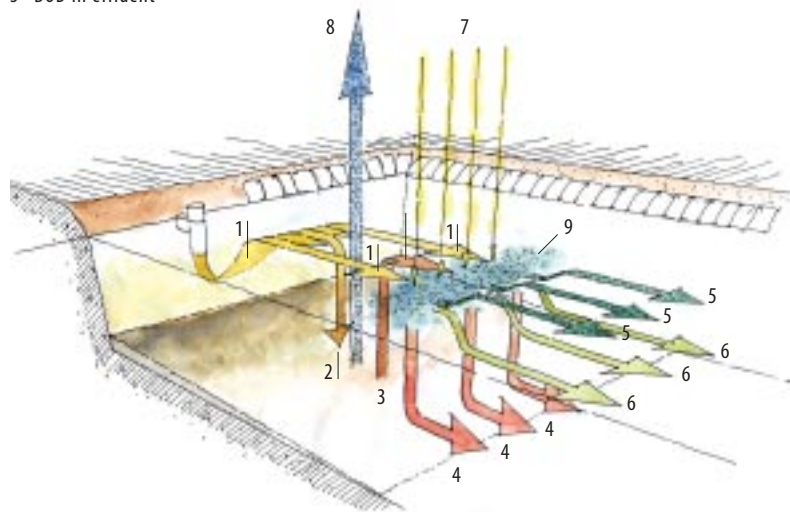

Retention time is generally between 4 and 7 days. The ponds should be no deeper than 1.5 m to prevent anaerobic processes from becoming predominant, for this will considerably slow down oxidation and thus reduce the efficiency of the treatment process.

Maturation ponds

Maturation ponds are installed downstream from facultative ponds. There must be at least two of them. Their function is to eliminate faecal bacteria and improve the final quality of the effluent so that it can be discharged into a river or stream.

Maturation ponds require little maintenance. All that is required is to cut the grass growing on the banks to avoid the proliferation of mosquitoes.

Box No. 16

Stabilization ponds (lagooning)

In calculating the size of stabilization ponds, account must be taken of the amount of organic matter in the effluent (BOD) in mg/l, the rate of flow of waste water in m³/day, and the average temperature during the coldest month of the year.

The BOD can vary between 200 and 800 mg/l. For prisons, the 800 mg/l value will be used because of the relatively small amount of water available. Indeed, in a prison every person contributes 30 to 40 g of BOD per day; if the amount of water used by each inmate is 50 l/day, the BOD of the waste water will be between 600 and 800 mg/l. The BOD decreases by about one half when the waste water passes through a septic tank.





▶ The empirical formula used is: $A = Q \cdot Li / 2T - 6$

A = the surface (expressed in m^2)

Q = the rate of flow of the waste water (in m^3/day)

Li = the BOD (in mg/l)

T = the temperature (in degrees Celsius)

For a prison with a population of 1,000, where the water consumption is 50 litres per person per day, and where the average temperature during the coldest month is $20^\circ C$:

$$Q = 1,000 \times 50 \times 10^{-3} \text{ m}^3/\text{day}$$

$$Li = 40 \times 10^3 / 50 = 800 \text{ mg/l}$$

$$T = 20^\circ C$$

$$A = \frac{1,000 \times 50 \times 10^{-3} \times 800}{(2 \times 20) - 6} = 1,172 \text{ m}^2$$

The dimensions of each pond must therefore be about 40 m x 25 m, which means that, for a pond 1 m deep, some 1,000 m^3 of earth have to be excavated. If the waste water passes first through a septic tank, the load is decreased by about 50%, and consequently the size of the ponds may also be decreased to 25 m x 20 m. These dimensions are therefore important, even though the values used here are rather extreme. A septic tank followed by two waste-water lagoons each measuring 500 m^2 should be sufficient. Retention time is about 10 days. If this is the case, and if the temperature is above $20^\circ C$, the decrease in BOD is usually greater than 70% and it should be possible to discard the water discharged from the second pond.

Figure 72 shows three stabilization ponds connected by inlet and outlet T-pipes.

Figure 72
Stabilization ponds
(lagooning)

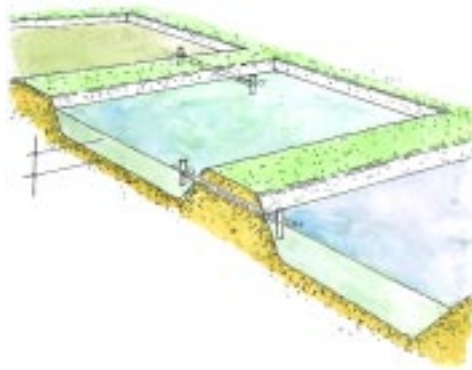

3. 4 Refuse disposal

Refuse attracts flies, cockroaches and rats, which can transmit diseases to man. Refuse therefore has to be **collected and disposed of on a daily basis**.

Sorting and treatment of refuse

Refuse must be sorted and treated according to its nature and origin. There are three types of refuse in places of detention: organic refuse, non-organic refuse and refuse from dispensaries or infirmaries.

Organic refuse results from the preparation of the detainees' meals and from food scraps. Its volume will depend on the number of meals served and the quality of the foodstuffs used.

This refuse may be used to feed animals or to make compost, which can be a substitute for chemical fertilizers in the prison's vegetable plots.

Composting is a biological process during which, under controlled conditions, various types of organisms are broken down into organic substances to form humus.²⁴

To produce compost, the organic refuse must be mixed with plant matter and soil so as to facilitate its decomposition by the presence of air. The detritus composed of plant waste, leaves and organic refuse is piled up in a heap. To speed up the degradation process, the pile should be turned over after a week or two, and then after a month (see **Figure 73**). Depending on the climate and the season, the maturation process may last from one to several months. It is essential to aerate the compost heap so as to ensure that biodegradation takes place rapidly and without odour and that pathogenic organisms are destroyed (see **Figure 74**).

Figure 73
Compost heap and
turning sequence

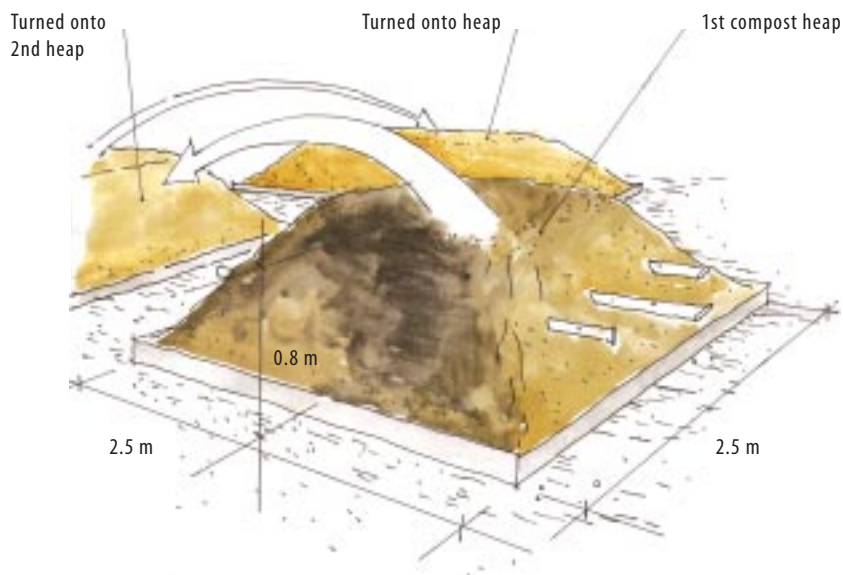

When excreta are added to the compost, it is essential to add plant matter to improve the C/N (carbon/nitrogen) ratio and to enable the microorganisms responsible for the biodegradation process to function properly. The compost heaps must also be turned regularly to reduce moisture content. The compost obtained at the end of the process can be used as a fertilizer, for it contains nitrogen, phosphorus and potassium (3 kg of dry compost contains about 10% of N/P/K), and some trace elements necessary for plant metabolism.

Figure 74
Detailed view of base
and aeration rods

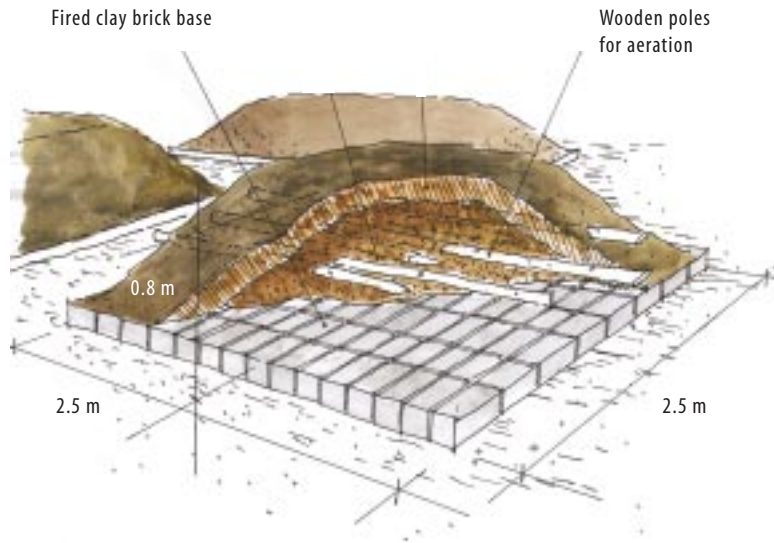

Non-organic refuse is mainly composed of paper or plastic wrappings. Its volume will depend on the number of detainees in a position to obtain, from the canteen or from their families, items which generate non-organic refuse. This type of refuse must be burned in a place designated for the purpose or in an incinerator. The unburned remainder must be buried.

As for waste from dispensaries or infirmaries, it is recommended that it be burned in an incinerator.

Figure 75 shows an incinerator made out of a 200-litre drum.²⁵ In some cases wood may be added to complete the incineration process.

Figure 75
Incinerator for
hazardous waste



Organization of refuse disposal

The daily removal of refuse is important for maintaining a salubrious environment in the prison, and must be organized and supervised accordingly.

Detainees must be designated to perform this task on a daily basis in every cell and dormitory, and also in the kitchens, refectories, infirmaries, etc.

Every cell and dormitory must have at least two refuse bins, one for organic and the other for non-organic waste. The bins must be easy for one or two people to carry when they are full.

Soil buckets employed where there are no toilets in the cells or dormitories must be used only for human excreta.

Figure 76 shows a drum used to collect non-organic refuse.

In **Figure 77**, a half-drum for collection of food scraps is placed on a support which is itself placed on a tray; this arrangement prevents any liquid from leaking out and spreading over the floor. Outside, the tray can be replaced by a masonry curb.

Figure 76
Refuse bin



Figure 77
Half-drum for
food scraps



The refuse can be taken away in a wheelbarrow, as shown in **Figure 78**.

Figure 78
Removal of refuse
in a wheelbarrow



3. 5 Synoptic table

Excreta and refuse disposal

Water in short supply

- dry pit latrines outside the cells and dormitories
- light structure
- there must be enough space to dig new pits when the old ones are full; access to soil buckets with lids needed in cells
- 1 water tap and a bucket for washing hands
- daily cleaning
- disinfection once a week
twice a day in the event of an epidemic

Coverage rate

- Number of latrines per person
WHO recommendations:
1: 25
acceptable:
1: 50
- Refuse
1 half-drum per 50 inmates

Sufficient water supply

- flush latrines with water seals inside cells and dormitories
- permanent structure
- evacuation of excreta to:
septic tank, then to soak pit or drainage trench, or connection to urban main sewer or to a lagooning system; direct infiltration a possibility
- 1 water tap and a bucket for flushing the pan and washing hands
- daily cleaning
- disinfection once a week
twice a day in the event of an epidemic

4.	Kitchens: design, energy and hygiene	
4. 1	Introduction	94
4. 2	Kitchen layout and fittings	94
	Location	94
	Roofed area	94
	Essential infrastructure	96
	Drainage and disposal of waste water	97
	Lighting, ventilation and smoke extraction	98
	Number of stoves and capacity of cooking pots	98
	Utensils	99
	Food storage	100
4. 3	Different types of energy	101
	Wood and wood seasoning	101
	Other sources of energy	103
4. 4	Energy-saving techniques: improved stoves	104
4. 5	General kitchen hygiene	107
	Indispensable hygiene measures	107
	Cleaning and disinfection of kitchen and cooking utensils	108
4. 6	Synoptic table	108

4. 1 Introduction

“Every prisoner shall be provided by the administration at the usual hours with food of nutritional value adequate for health and strength, of wholesome quality and well prepared and served.”²⁶

The organization of a supply of food for the detainees is one of the most important tasks of any prison administration. The food provided must be of adequate quality, and must be purchased in sufficient quantities at a frequency which ensures that there are no shortages and that the quality of the food remains satisfactory until it is consumed.

Prison kitchens must be capable of preparing, every day and in proper conditions, meals for the entire prison population. In many countries these kitchens reflect the conditions prevailing in the rest of the prison: they are antiquated, dilapidated and inadequate to cater for the number of inmates.

Close attention must be paid to the conditions in which meals are prepared, with regard not only to hygiene and equipment but also to the working conditions of the people assigned to this task.

In this chapter we shall describe what can be done to improve prison kitchens, the preparation and distribution of meals, hygiene conditions and the preservation of foodstuffs, and ways of reducing energy consumption in kitchens.

4. 2 Kitchen layout and fittings

Location

The location of the kitchen within the prison is important. Waste water and smoke have to be evacuated properly, without creating a nuisance for the inmates. The choice of location should therefore take into account the direction of prevailing winds and the location of cells, dormitories, exercise yards and other places where the detainees spend their time.

The building where the kitchen is located should be near the premises where stocks of food and fuel are kept so as to limit the work involved in handling supplies. For obvious reasons of hygiene (insects attracted by food, contamination by pathogens, foul odours), the kitchen must not be too close to the latrines.

If the kitchen is outside the prison, special care should be taken to ensure that the food is transported in the best possible hygiene conditions (with lids kept on food containers, for example).

Roofed area

The kitchen must occupy a large enough area to be functional. When the kitchen is too small, this has a negative impact on the working conditions of the people in charge of preparing meals and on hygiene:

- there is a greater risk of accidents (cooking pots upset, jostling, burns);
- the heat from the stoves is often unbearable;
- foodstuffs are temporarily kept on the floor before being used because there are not enough working surfaces;
- finally, adequate ventilation is impossible, so kitchen staff are exposed to toxic fumes emanating from the stoves.

Figure 79 shows an example of a properly ventilated kitchen, and Figure 80 shows the distances to be observed.

Figure 79
Kitchen, water tank,
stoves and ventilation

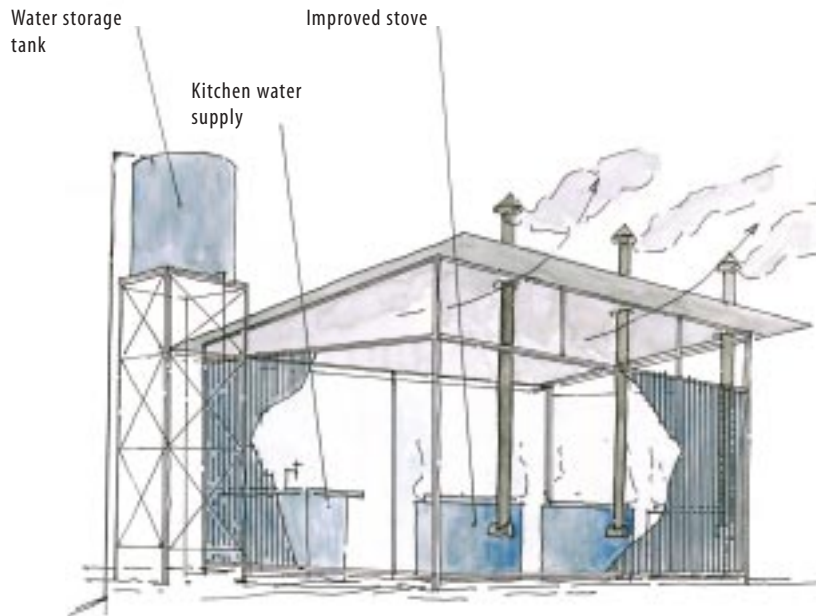
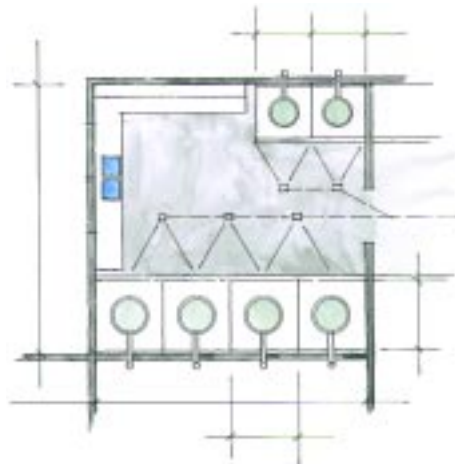

Figure 80
Plan of a kitchen and
distances to be observed
for efficient operation



For proper working conditions, the area of the kitchen in a small prison (100-200 detainees) must be at least 20 m². This area increases along with the number of inmates. For over 200 detainees, the figure of 0.1 m²/detainee is used. That means an area of **100 m² per 1,000 detainees**.

This is an indicative figure based on experience, which shows that there are no major problems in the operation of prison kitchens as long as this requirement is fulfilled.

It is not essential that the kitchen be enclosed by four walls if basic hygiene requirements are met (floor washed daily, suitable system for storing food). In some cases it may even be recommended that one section of the kitchen wall be left open to allow proper ventilation and facilitate the handling of supplies.

It is easier to keep the kitchen clean and to maintain hygiene if the surfaces are cemented. When the concrete is being poured, however, care must be taken to make sure that the floor is fairly smooth so that food will not become embedded in rough areas and attract flies.

Essential infrastructure

The kitchen must have a water-supply and -storage system. There must be at least one tap with sufficient water pressure, and a tank large enough to store the amount of water needed to prepare meals for at least one day.

The required capacity of the storage tank will naturally depend on the number of meals to be prepared every day. It is estimated that a **minimum of one litre of water per detainee per day must be specifically allocated for cooking food.**

To this must be added the amount of water needed to rinse the food, clean the cooking pots and utensils and clean the floor. These tasks require about **two litres of water per detainee per day.**

For a prison with 1,000 inmates, the kitchen should have its own storage tank with a capacity of 3 m³. The tank must have a close-fitting lid and must be cleaned once a month.

The best arrangement, as shown in **Figure 81**, is to have a row of taps over concrete or stainless steel sinks which are big enough to wash and disinfect a large number of utensils.

Figure 81
Working surfaces,
sinks and taps



Drainage and disposal of waste water

Waste water from kitchens contains large amounts of grease and fat. If it is not treated, these will quickly clog the infiltration system.

Fat can be removed by means of a degreasing tank. This is a simple system comprising a tank divided into three parts: an entry chamber which slows the rate of flow of the effluent and spreads it out; a middle chamber in which the grease rises to the surface and heavier solids sink to the bottom, forming a layer of sludge; and finally an outlet chamber through which the degreased water is evacuated (see **Figure 82**).

Figure 82
Degreasing tank
or grease trap

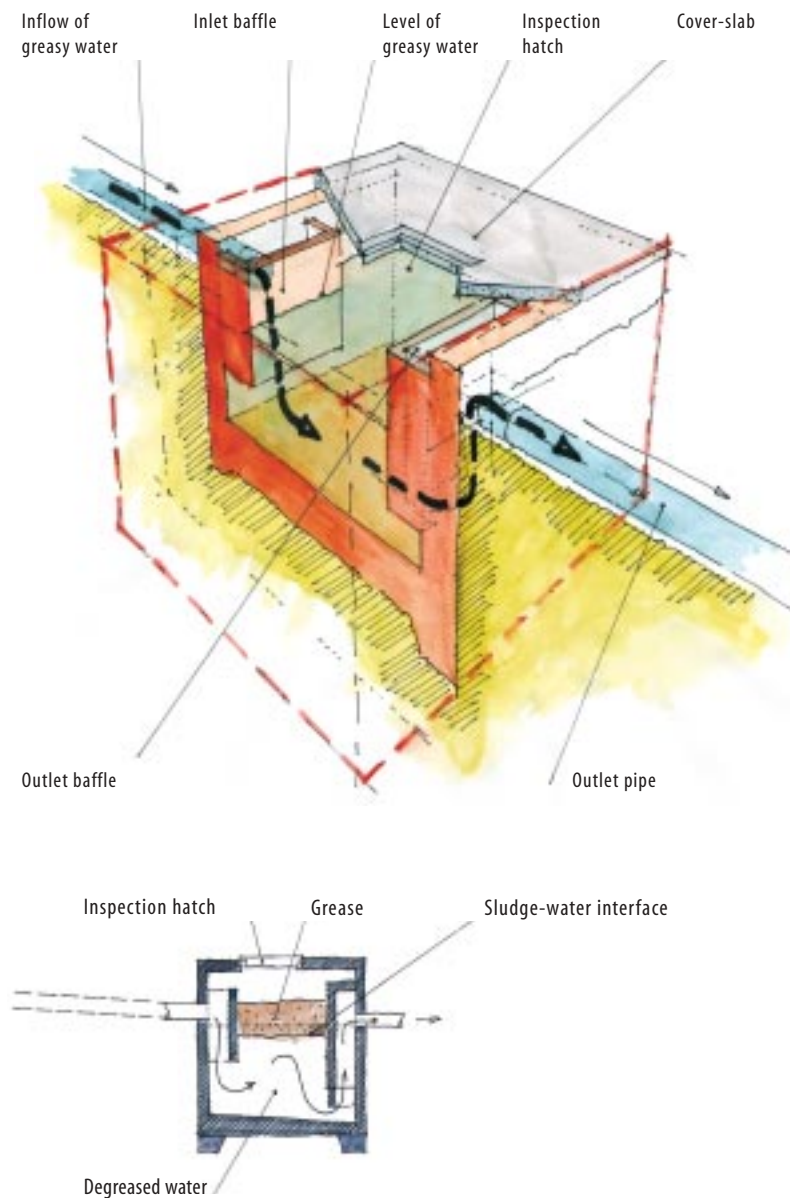

Normally the capacity of the degreasing tank must be twice the maximum volume of liquid flowing into the tank in one hour.²⁷ As this volume is often difficult to estimate, an approximate figure is used, equivalent to one and a half times the capacity of the cooking pots, that is, about 1.5 m³ per 1,000 detainees.

The degreasing tank must be easily accessible. It must be cleaned every week to reduce odour and prevent clogging, and the grease removed during cleaning must be buried. The cover (a concrete lid) must be heavy enough to prevent its being shifted unintentionally and to avoid the risk of accidents.

Lighting, ventilation and smoke extraction

The openings in the kitchen walls must be large enough to provide sufficient ventilation and to let in enough daylight so that electric light does not have to be used during the day. Daylight is essential for good working conditions and also discourages infestation by cockroaches.

The smoke given off by burning wood is toxic, and prolonged exposure to smoke can give rise to respiratory and eye diseases among kitchen staff. Every stove, therefore, must be fitted with a flue pipe ensuring proper smoke extraction.

Figure 83 shows a kitchen in which every stove is connected to a flue pipe.

Figure 83
Kitchen and stoves
fitted with flue pipes

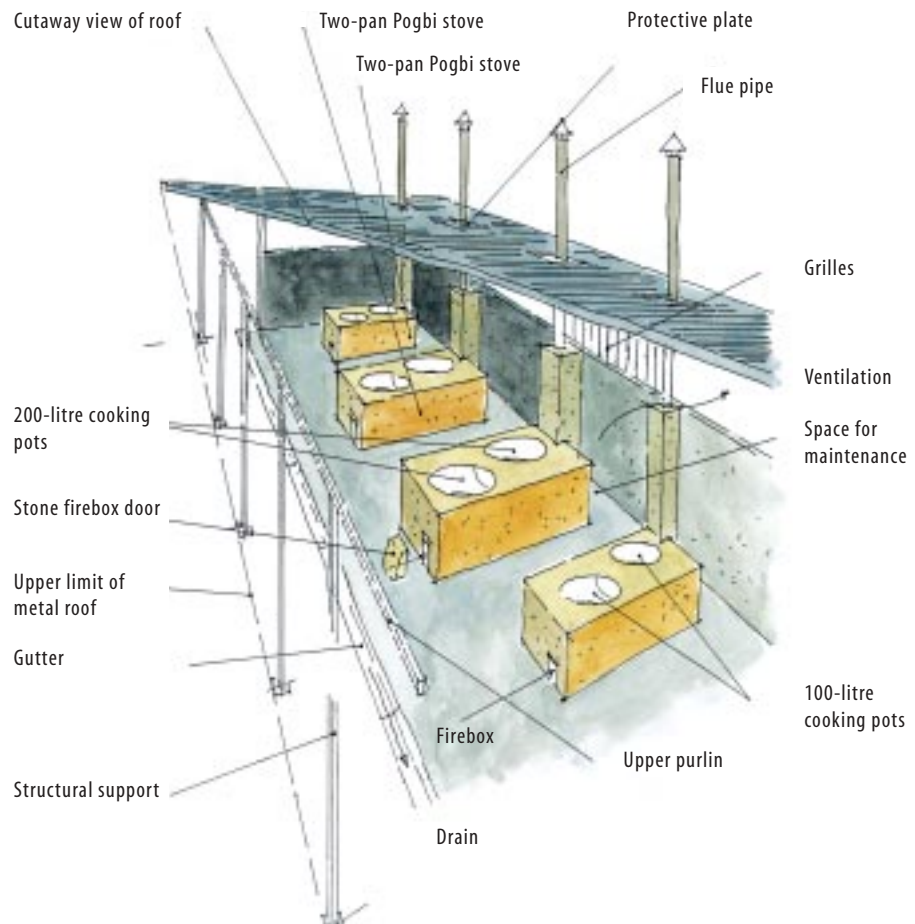

Number of stoves and capacity of cooking pots

The number of stoves required depends on the number of meals to be prepared daily and on the way the distribution of meals is organized.

The capacity of the cooking pots depends on the composition of the food rations.

Table II gives figures for the changes in volume that occur during cooking.

Table II Changes in volume during cooking of basic foodstuffs

FOOD	RAW VOLUME	COOKED VOLUME
Spinach	1	0.65
Cabbage	1	0.8
Potatoes	1	1
Dried beans	1	2.5
Pasta	1	2.5
Rice	1	3
Maize flour	1	4.5

For a basic standard ration (a mixture of cereal flour and a legume, oil and salt), it is considered that **the total capacity of the cooking pots must be at least 1.2 to 1.4 litres per detainee.**

For ergonomic reasons, the capacity of each pot should be no more than 200 litres. Above that, the pots are too heavy to lift and move.

Example:

540 detainees

Calculation: $540 \times 1.4 =$ total capacity in number of litres = 756

Rounded up to the nearest hundred = 800 litres, total capacity required

The choice of capacity (100 or 200 litres) and the number of cooking pots will depend on the composition of the food rations.

In our example:

Total capacity = 800 litres

Option 1: three 200-litre pots = 600 litres + two 100-litre pots = 200 litres

Option 2: four 200-litre pots = 800 litres

For prisons with less than 100 inmates, 50-litre pots can be used.

The cooking pots, preferably made of stainless steel (2-4 mm thick), must have handles on opposite sides so that they can be lifted by two people. They must also have lids.

Saucepans and other containers used for **distributing meals** must be easy to carry and must also have lids.

Utensils

For reasons of hygiene and to show proper respect for the inmates, it is essential that each detainee be given eating utensils similar to those used outside the prison.

The utensils used to prepare meals vary from one country to another. Whatever the local custom, preference should be given to metal utensils or utensils whose working ends are metal, as they are easier to wash and disinfect than wooden ones. They must be put away carefully after each use, preferably in a closed drawer or cupboard to protect them from cockroaches and other insects.

Figure 84 shows some examples of cooking and eating utensils.

Figure 84

Items required for the kitchen and for meals



Food storage

In every prison there must be a place set aside for the storage of foodstuffs to be used for the preparation of meals. Food supplies must be kept in a clean, dry and well-ventilated place.

Foodstuffs can deteriorate during storage. The main factors involved in such deterioration are temperature, humidity and various pests (insects and rodents).

Food storerooms must be designed and managed in such a way as to avoid deterioration of the supplies they contain. The main **rules** to be observed in **building storerooms** are as follows.

- The wall and foundations must be designed to prevent rodents from entering. Walls should not be made of mud bricks, as rats can easily burrow holes in them.
- The floor must be cemented to avoid rising dampness.
- The walls and openings in the walls must not let in water.
- Metal doors are better than wooden doors.
- All windows and other openings must be screened.
- The temperature must be kept as low as possible by means of insulation and a suitable ventilation system; it is useful to have two doors or windows opposite each other, if possible in the direction of the prevailing wind, so as to create a through draught.
- When food supplies are delivered, every bag must be checked. Those that are infested with insects must be put aside and used first, unless the infestation has rendered them inedible.
- The food store must be regularly inspected for the presence of rats or insects.
- Disinfestation and rat extermination operations must be carried out periodically (see Chapter 5).

Food supplies should be stored in crates or bags and on pallets or shelves, and separated according to type of food rather than being heaped together.

In general the layout of the food store will leave:

- a one-metre space between the food supplies and the wall of the storeroom;
- passageways 2 metres wide for handling purposes.

Figure 85 shows a typical storeroom layout.

Figure 85
Typical
storeroom layout

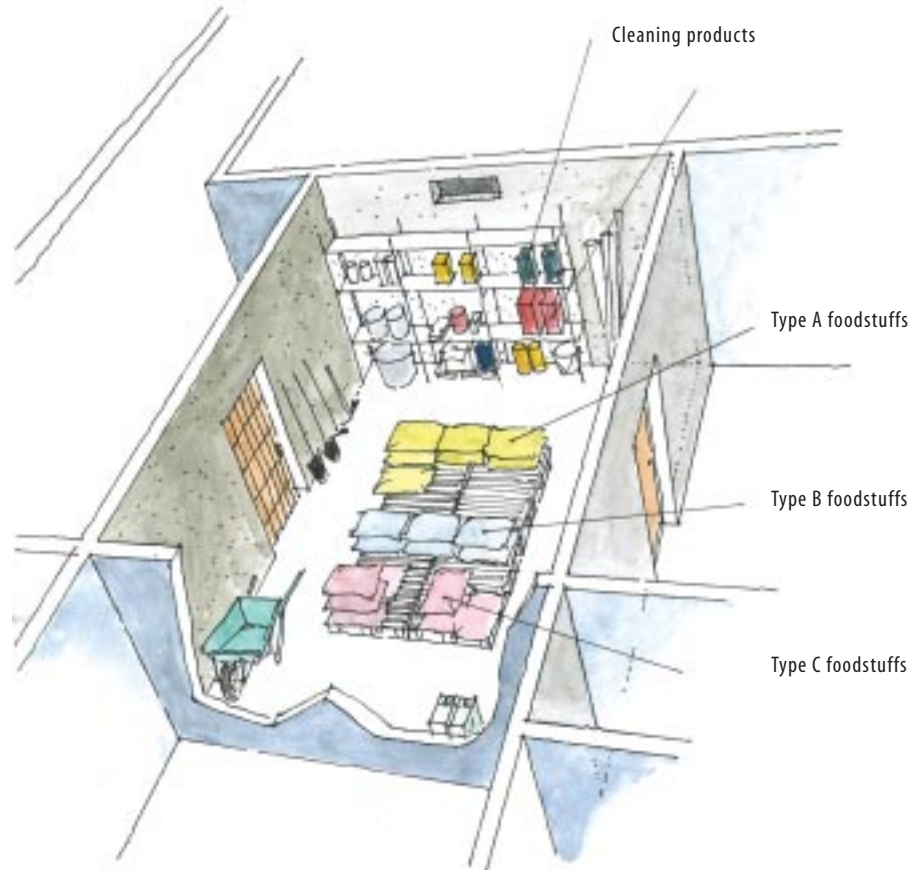

4. 3 Different types of energy

Wood and wood seasoning

Wood is the fuel most commonly used in the prisons of developing countries. Wood-burning performance varies with the type of wood used and the amount of humidity it contains when it is burned. Freshly cut, green wood generates less energy than dry wood, as it has a lower calorific value.

To reduce wood consumption, the wood must be dried.

Wood dries out more rapidly if it is cut into logs and split. The logs must be a suitable size for the type of stove in which they will be used. For efficient combustion, the logs should be 4 or 5 cm in diameter.

It takes a long time to season wood properly, so large stocks should be built up and stacked in a suitable place. By keeping wood for three months before it is used, the amount needed for preparing meals can be reduced by about a third.

Wood must be dried in the open air but under cover to protect it from rain. The stockpile should be close enough to the kitchens to make handling easier, but for reasons of hygiene it is not advisable to keep wood in the kitchens themselves.

An example of a wood stockpile is shown in Figure 86.

Figure 86
Wood stockpile
with different
stages of seasoning



Proper tools are needed for cutting up wood: sawhorses, blocks, saws, axes, and also wedges and sledgehammers for splitting hard, knotty logs.

Figure 87 shows some of these tools.

Figure 87
Woodcutting tools
and procedures



Box No. 17

Wood: calorific value of tropical woods and estimating consumption

The **calorific value** of a given type of wood means the amount of heat produced by combustion per unit of weight. Calorific value (or specific energy) is expressed in kilojoules per kilogram (kJ/kg). This value will vary depending on the moisture content of the wood: the amount of heat produced by combustion declines as the water content increases (variations in the order of 15 to 20% are frequently observed). Tropical woods have a calorific value that ranges between 17,500 and 21,300 kJ/kg.*

In practice, knowing the calorific value of a given type of wood is not much help. On the other hand, to plan expenditure, determine the amount of wood to be stocked or compare the performance of various types of stoves, it is useful to know the wood consumption of a given stove. The figure for consumption is then compared with the amount of food cooked. The procedure for this is as follows.

1. Determine the amount of food cooked during a week (in kg).
2. Determine the amount of wood used during the same week (in kg or m³ – in the latter case the logs have to be properly stacked and aligned to obtain a reliable estimate of the amount used).
3. Calculate the ratio of wood consumption in kg or m³ to kg of food cooked.





The area needed for wood storage can be determined on the basis of the total amount of food to be prepared during the desired storage period.

Example

A truck with a capacity of 4 m³ is filled with wood twice a week for cooking meals in a prison with 1,000 inmates. Every day 450 kg of cereal flour and 150 kg of beans are cooked. Wood consumption is therefore (4+4) m³/7 (450+150) kg, that is, about 0.002 m³ of wood used per kilogram of food cooked.

If the wood is left to dry for 6 months, the period corresponding to the preparation of about 110 tonnes of food, about 200 m³ of wood will have to be kept in stock. Thus a storage area of about 120 m² will be required if the wood is arranged in stacks 1.80 m high. That is a considerable size. These figures are valid only as long as there is no major fluctuation in the number of inmates in the prison.

* See *Mémento du forestier*, Centre technique forestier tropical, French Cooperation Ministry, 3rd edition, 1989.

Other sources of energy

Sources of energy other than wood – gas or electricity, for example – may be used for kitchen stoves. It is obviously important to check whether the energy supply is reliable before installing gas or electric stoves. In a prison environment any interruption in the operation of the kitchens will immediately have disastrous effects.

The use of gas (natural, butane or propane) is widespread,²⁸ as it does not involve the storage and handling problems associated with wood. Working conditions in the kitchen are also better than with wood because gas does not give off toxic smoke.

Certain safety measures have to be observed when gas is used.

Figure 88 shows a stove fitted with a gas burner that can be tilted to facilitate handling of the cooking pots and food, and for cleaning purposes. This makes the work of kitchen staff easier.

Figure 88
 Stove with gas burner

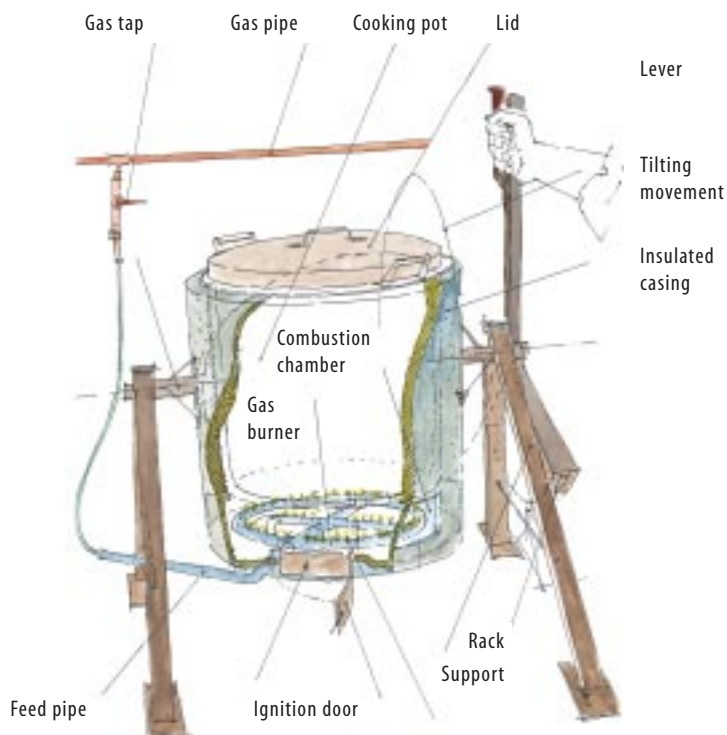

Electric stoves make for good working conditions in kitchens. On the other hand they are expensive to maintain and the cost of electricity is very high, often beyond the budgetary possibilities of prison administrations.

In some countries **kerosene stoves** are used. Kerosene is a popular choice because it is inexpensive and easy to handle (see **Figure 89**).

Figure 89
Gravity-fed burner



4. 4 Energy-saving techniques: improved stoves

The consumption of energy for cooking food can be appreciably reduced by using improved stoves (see below) and applying some basic principles.²⁹ For example:

- always cover cooking pots with a tightly fitting lid that is heavy enough to prevent loss of heat;
- give preference to whole-grain flours, as they cook more rapidly;
- soak legumes (especially beans) overnight, or at least for a few hours before cooking;
- once the water has come to the boil, keep it simmering for efficient cooking by reducing the heat. This will save wood.

In a prison where the kitchen stoves are badly damaged and no longer efficient, or where meals are cooked on open fires, there is tremendous heat loss and very high fuel consumption. **It is estimated that on an open three-stone fire with no protection from the wind, 1 kg of dry wood is needed to bring 1 litre of water to the boil.**

In such circumstances it may be advisable to install what are known as “improved” stoves, which considerably reduce the amount of energy needed in kitchens.

Use of this type of stove makes it possible to:

- reduce wood consumption;
- reduce cooking time;

and therefore to:

- reduce the cost of operating the kitchens;
- improve working conditions (smoke extraction);
- reduce the risk of accidents (stability of stoves).

There are many types of improved stoves. They may be made of bricks, of clay or of metal. Only a qualified person can build and install an improved stove. The stoves need regular maintenance, i.e., cleaning and inspection of the firebox and the firebox door. The wood used must be seasoned in accordance with the recommendations given in point 4.3 above.

Experience has shown that the best results are obtained with stoves comprising an external casing of mild steel 3 mm thick and a cooking pot (see **Figure 90**). The stoves are insulated with fibreglass. Refractory bricks laid at the base of the stove retain heat longer by increasing the thermal mass. They also contribute to the rigidity of the stove.

Improved stoves are supplied with standard-capacity aluminium or steel cooking pots (50, 100 or 200 litres). As a rule stainless steel pots are the best choice; although they considerably increase the cost of the stove, they are much more hard-wearing than aluminium and therefore last longer.

Figure 90
Type of stove
recommended

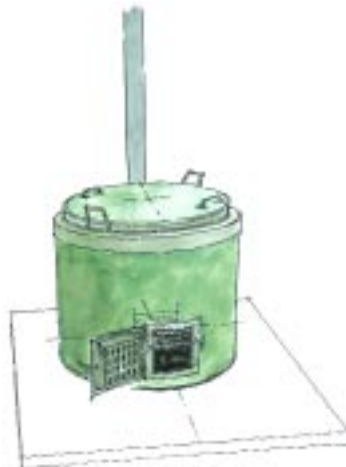
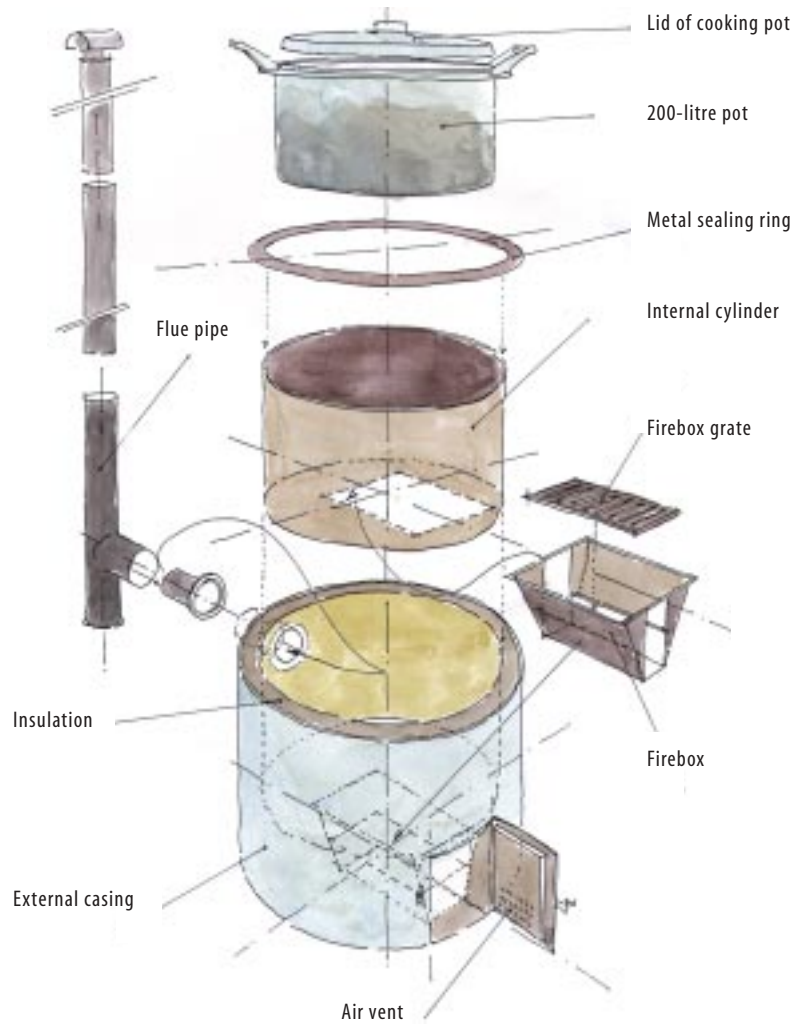

Figure 91 gives an exploded view of an improved stove.

To protect the external casing, a low brick wall 20 cm wide is sometimes built around the sides. Each stove is placed on a concrete plinth measuring 2.40 m x 2.40 m, which leaves enough space between the stoves for the kitchen staff to do their work.

The wood used for the stoves must be dry and cut into logs 20 cm long.

Figure 91
Components of
the stove



One such stove is marketed under the brand name Bellerive; its features are described in **Box No. 18**.

Box No. 18

Features of the Bellerive stove

Approximate fuel consumption

- ▶ 6 kg of wood per hour to boil 135 litres of water in 75 minutes

Main components

- ▶ Stainless steel cooking pot
- ▶ Mild steel internal and external casing
- ▶ Mild steel upper ring to support the pot
- ▶ Cast iron firebox
- ▶ Mild steel chimney flue

Sizes

- ▶ 50, 100 and 200 litres

This type of stove burns up to four times less wood than an open three-stone fire with no protection from the wind.

4. 5 General kitchen hygiene

Indispensable hygiene measures

The same applies to a prison kitchen as to any other community kitchen: unless there is strict hygiene in the handling of food, and unless the food is properly prepared and protected from contamination by pathogens, the health of the detainees will be at risk. As a prison is by definition an enclosed place, any outbreak of disease can spread very rapidly and have serious consequences. Meals must be prepared and served in optimum hygiene conditions so as to minimize the risk of disease transmitted by food.

Table III shows the modes of transmission of the most common diseases occurring in prisons.

Table III Characteristics and prevention of diseases transmitted by food*

DISEASE	RESERVOIRS	MODE OF TRANSMISSION	PROPHYLAXIS
Salmonellosis	<ul style="list-style-type: none"> Animals 	<ul style="list-style-type: none"> Infected meat Vegetables Leftover food 	<ul style="list-style-type: none"> Protect food stocks Cook food carefully Eliminate rodents
Typhoid fever	<ul style="list-style-type: none"> Faeces and urine of infected persons or carriers 	<ul style="list-style-type: none"> Water Milk Milk products Contaminated food Flies 	<ul style="list-style-type: none"> Protect and treat water supply Ensure hygienic disposal of waste water, educate food handlers, check quality of food Eliminate flies Monitor carriers of the bacteria Promote personal hygiene
Cholera	<ul style="list-style-type: none"> Stools Vomits Carriers of the bacillus 	<ul style="list-style-type: none"> Water Excreta Contaminated raw food Flies 	<ul style="list-style-type: none"> Same measures as for typhoid fever Isolate patients
Gastroenteritis	<ul style="list-style-type: none"> Man and animals 	<ul style="list-style-type: none"> Water Food Milk Air 	<ul style="list-style-type: none"> Sanitation, health education, personal hygiene
Infectious hepatitis A	<ul style="list-style-type: none"> Excreta of infected persons Cockroaches 	<ul style="list-style-type: none"> Water Food Contacts 	<ul style="list-style-type: none"> Hygienic sewage disposal, food hygiene, personal hygiene Treat water
Amoebiasis	<ul style="list-style-type: none"> Excreta and infected carriers 	<ul style="list-style-type: none"> Water Food, infected raw vegetables and fruit Flies Cockroaches 	<ul style="list-style-type: none"> Treat water Check foodstuffs





- Leptospirosis**
- Urine and excreta of rats, pigs, dogs, cats, mice, foxes and sheep
 - Food
 - Water
 - Soil contaminated by excreta or urine of infected animals
 - Contacts
 - Exterminate rats
 - Protect food
 - Disinfect utensils

- Teniasis**
- Infected meat eaten raw
 - Food contaminated by human excreta
 - Ensure meat is well cooked
 - Proper sewage disposal
 - Observance of hygiene rules by food handlers

* See J.N. Lanoix, M.L. Roy, *Manuel du technicien sanitaire*, WHO, Geneva, 1976.

Cleaning and disinfection of kitchen and cooking utensils

The kitchen must be kept clean. Cleaning operations must be efficiently organized by the kitchen maintenance team. The floor must be swept every day; if it is cemented or tiled it should be disinfected with a chlorine solution once a week. It should also be washed regularly with detergent so as to remove grease.

The individual dishes, utensils and cooking pots used for preparing meals must be thoroughly cleaned every time they are used and disinfected every week, either with a chlorine solution or, more simply, by plunging them into boiling water.

4. 6 Synoptic table

Kitchen and preparation of meals

Wood consumption on open fire:	1 kg/litre water brought to the boil
Wood consumption with improved stove:	about 0.1 kg/litre water brought to the boil (dry wood, small logs, insulation, lid, good draught)
Minimum number of meals:	2 to 3 meals/day
Capacity of cooking pots:	1.2 to 1.4 litres/inmate
Type of cooking pot:	stainless steel (if possible)
Maximum size of cooking pots:	200 litres, or exceptionally 300 litres
Roofed area of kitchens:	100 m ² /1,000 inmates (minimum 20 m ²)
Water supply:	1 litre/person/day (at least 1 tap)
Water storage in kitchens:	3 m ³ /1,000 inmates
Minimum area of storerooms:	50 m ² /1,000 inmates
Smoke extraction:	chimney
Cleaning of kitchens:	every day
Disinfection:	once a week
Lighting:	at least 3 Watts/m ² (indicative figure)

5.	Vectors of disease and vector control	
5. 1	The main vectors and control measures	110
	Definition of a vector	110
	Knowing the vector's life cycle and habitat	111
	Principles common to vector-control programmes	111
	The main vectors in the prison environment and control measures	112
5. 2	Combating the main vectors with insecticides	119
	Types of insecticide which may be used in prisons	119
	Formulations	120
	Residual effect	121
	Resistance to insecticides	121
	Insecticides used in the prison environment	122
5. 3	Implementation of a vector-control programme	122
	Spraying of walls, bedding and surfaces	122
	Calculating the quantity of insecticide needed	123
	Organization of spraying operations	125
	Spraying equipment	127
	Mosquito nets	129

5. 1 The main vectors and control measures

Definition of a vector

Prisons are places that are conducive to the proliferation of ectoparasites, that is, insects which feed on blood. These insects are not only a nuisance because of their stings or bites; they can also transmit epidemic diseases. Other insects which do not feed on blood are also involved in the cycle of disease transmission.

Box No. 19 lists the insects that play a major role in prisons.

Box No. 19

Main vectors playing a role in the transmission of disease or creating a nuisance for detainees		
VECTOR	DISEASE	POSSIBILITIES FOR CONTROL
Mosquitoes	<ul style="list-style-type: none"> • Malaria • Filariasis • Yellow fever • Dengue • Viral diseases • Japanese encephalitis 	Poor
Lice	<ul style="list-style-type: none"> • Typhus • Relapsing fever 	Moderate
Fleas	<ul style="list-style-type: none"> • Plague • Typhus 	Moderate
Scabies mites	<ul style="list-style-type: none"> • Scabies • Superinfections 	Good
Flies	<ul style="list-style-type: none"> • Trachoma, and may mechanically transport other pathogens (cholera, bacillary dysentery) 	Good
Bedbugs	<ul style="list-style-type: none"> • Nuisance 	Good
Cockroaches	<ul style="list-style-type: none"> • Hepatitis A • Chagas disease • Other pathogens by mechanical transport 	Moderate
Rats	<ul style="list-style-type: none"> • Typhoid (salmonellosis) • Leptospirosis 	Moderate

There are other vectors of disease, but they are of limited importance in places of detention.

Lice, fleas, bedbugs and flies are often to be found in overpopulated prisons.

In prisons where hygiene is poor, many inmates may suffer from scabies.

Such prisons will also harbour cockroaches which, like flies, feed on waste and decomposing organic matter. They come into contact with excrement and other pathogenic agents and deposit them on the detainees' food, which is contaminated as a result.

Knowing the vector's life cycle and habitat

1. Every vector has its own reproductive cycle. Each different stage of this cycle takes a specific form and occurs in a specific environment.
2. It is important to be familiar with the vector's life cycle and habitat so as to be able to take effective action against it, either by environmental or by chemical means, at the right time and in the right place.
3. Mosquitoes in the larval and nymphal stages live in water. Vector-control measures will therefore focus on preventing the adult mosquito from laying its eggs in water.
4. It is also known that if body lice – the vectors of typhus and relapsing fever – are to be eliminated, they have to be attacked on the body or on clothing, and that it is pointless to spray surfaces with residual insecticides. To control bedbugs and other crawling insects such as cockroaches and flies, on the other hand, spraying walls, furniture and floors is an effective measure because these insects rest on such surfaces after feeding.

Principles common to vector-control programmes

Any vector-control programme must aim to:

- make the environment unfavourable for the development and survival of the vector, thus minimizing the number of vectors potentially capable of transmitting a disease or creating a nuisance;
- prevent the different forms taken by each vector during its cycle of development from reaching the adult stage by destroying eggs, larvae, etc.;
- as far as possible, promote passive protective measures (screening and mosquito nets) and prevent the detainees from coming into contact with environments where transmission can occur (Guinea worms, schistosomiasis (bilharzia) —> stagnant water);
- encourage good hygiene.

In the event of a proliferation of pests, and especially if there is an outbreak of disease, **approved** insecticides with **low toxicity** for mammals may be used. The use and proper application of these products is described below.

Priority should be given to measures aimed at making the environment less favourable for the development of vectors. Insecticides should be used only as a last resort. Indeed, it is more effective and less costly to collect and remove refuse regularly than to depend upon insecticides to combat flies or rat poison to eliminate rodents. Frequent cleaning of surface-water drains will prevent the accumulation of stagnant water, which is a breeding ground for mosquitoes. Proper protection of water storage tanks will prevent excessive proliferation of domestic mosquitoes such as *Aedes aegypti*, which transmit yellow fever and dengue. Regular cleaning of places where food is prepared will minimize problems caused by cockroaches and flies.

The main vectors in the prison environment and control measures

Lice are found in detainees' hair and clothing. Head lice are the most common species.

The life cycle of the louse is shown in Figure 92.

Figure 92
Life cycle
of the louse

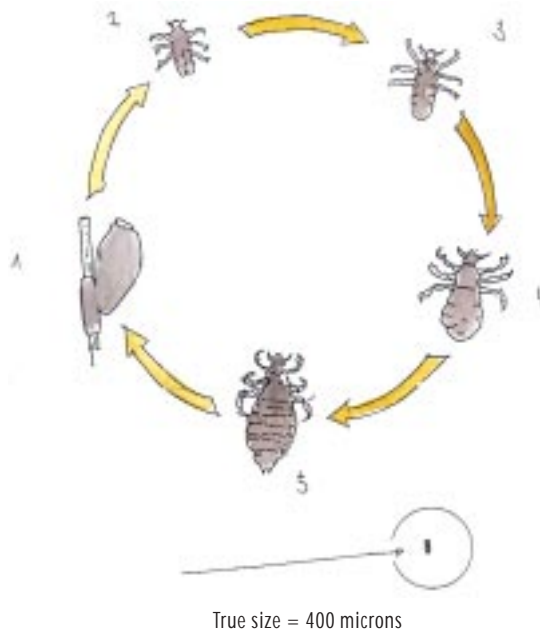

Body lice are found in clothing and underwear, along seams, in the crotch of trousers, in the underarm creases and along collar seams. They occur more frequently in cold climates and mountainous regions. Lice are found in overcrowded places where people live in conditions of poor hygiene, such as prisons.

Body lice transmit typhus and relapsing fever, diseases which can spread rapidly and affect large numbers of people. The louse transmits pathogens via its droppings. In the case of relapsing fever, the pathogen is released only when the louse is crushed.

It is often when the subject scratches himself that the pathogens (*Rickettsia* and *Borrelia*) are able to enter the body.

Pathogens may also gain entry via the mucosa of the nose and mouth (when the insects are crushed between the teeth).

Head lice are transmitted by direct contact between individuals or by the sharing of a comb. Head lice do not transmit any disease.

Control measures

Shaving the detainees' heads is not necessary unless head lice are widespread. Shaving is a risky procedure because the razor blade has to be changed every time to avoid transmitting the AIDS virus.

The primary control measures are as follows:

1. Improve general hygiene and reduce overcrowding.
2. Wash clothing, underwear and blankets. If possible, apply dry heat (ironing at 55-60°C), because lice are less resistant to dry than to damp heat. Using damp heat is very costly in terms of energy, as it involves setting up high-temperature steam baths (one hour at 70°C).

3. Treat all inmates with an insecticide powder (0.5 to 1% active ingredient) which is approved and has low toxicity for mammals. Use between 30 and 50 grams of powder per detainee, and give two treatments with a two-week interval between them.
4. Treat all clothing distributed and the clothes of new arrivals.
5. Inform the detainees of the risk they run when they crush lice, and explain what can be done to combat transmission.
6. Should there be an outbreak of disease, treat all the detainees with antibiotics (chloramphenicol, doxycycline, etc.).

The insecticide powder can be administered by means of either individual puffer packs (usually containing 50-100 g) or refillable pump sprays (in the latter case, insecticide bought in bulk will be used).

The persons handling the powder dusters will be the most exposed to the insecticides and must therefore wear protective gear: gloves, safety goggles and paper face masks (paint spray masks). They must wash themselves carefully once the operation is completed. **Figure 93** gives an idea of the type of equipment used for applying insecticide powder, and **Figure 94** shows the places to be dusted to eliminate body lice.

Figure 93
Dusting equipment

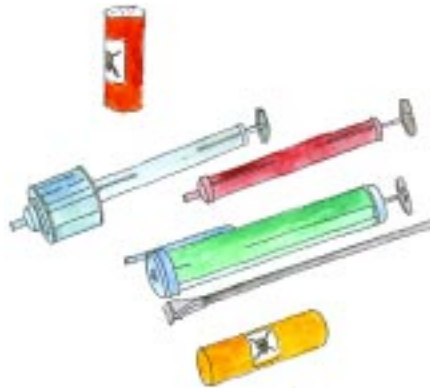

Figure 94
Places to be dusted



Bedbugs do not transmit disease, but they nevertheless create a considerable nuisance in places of detention because they feed on blood and their bite can become inflamed. In prisons with major bedbug infestation the characteristic odour of the insects' secretions

can be smelt, and there will be marks on the dormitory walls where the inmates have squashed bugs.

The life cycle of bedbugs involves various nymphal forms at different stages (see **Figure 95**). They hide in cracks in walls or wood, and also in bedding.

Figure 95
A bedbug and
its life cycle



Bedbugs move quickly, feeding on man at night and then returning to their hiding places. They may bite a victim several times without him noticing. They may be as long as 4 to 7 mm, and double in volume when they are gorged with blood.

Fleas feed on the blood of mammals, and also on that of birds. Fleas are found in beds, in the ground and in clothing. The larval stage takes place on the ground. **Figure 96** shows the stages of the flea's life cycle.

Figure 96
Life cycle
of the flea



The bite of the human flea (*Pulex irritans*) is irritating, but poses no risk to health. Rat fleas, on the other hand, transmit bubonic plague and murine typhus. Plague is transmitted by fleas which have fed on an infected animal. When the rat dies, the fleas abandon the body and may infest man. Murine typhus (*Rickettsia typhi*) is transmitted by flea droppings when the flea is crushed between the fingernails, in the same way as typhus is transmitted by lice.

Control measures

The only way to eliminate bedbugs and fleas is to use insecticides. Walls, bed boards and any other place where insects may hide must be sprayed with residual insecticides. Mattresses and blankets may also be sprayed, but in that case they have to be taken out to dry in the sun. The operation must therefore begin in the morning and when the weather is sunny.

Powder insecticides, such as 0.5% permethrin, may be used to treat bedding. Pyrethroids have an additional irritant effect (especially when used with an additive such as piperonyl butoxide) which drives the insects out of their hiding places, thus making the operation even more effective. Spraying walls also acts against all crawling insects, such as cockroaches, and against mosquitoes and flies, which alight on the walls and thus come into contact with the insecticide. In places infested with fleas, regular sweeping and washing of the floors helps to eliminate eggs and larvae.

In the event of infestation with rat fleas (*Xenopsylla*), the fleas must be eliminated before rat extermination operations begin, by sprinkling insecticide powder in the rats' burrows and on their habitual pathways. This, however, is a difficult task.

Houseflies proliferate in all places where human beings are living. They feed on decomposing organic matter, excreta and food. As they alight successively on these different substances they can transport tiny particles containing pathogens, such as the cholera vibrio and the organisms that cause bacillary dysentery (shigellosis), and thus contaminate food. That is why an effort is made to eliminate flies when there is an outbreak of cholera or shigellosis. But flies are a nuisance in themselves, as they bother people who are trying to work or rest. They also infect open wounds in infirmaries. In tropical climates some species (filth flies, *Musca sorbens*), attracted by lacrymal secretions, actively transmit eye infections (conjunctivitis, trachoma). For all these reasons it is important to prevent their proliferation.

In places of detention as elsewhere, flies usually congregate around rubbish dumps, food scraps and latrines. Figure 97 shows the life cycle of the fly.

Figure 97
Life cycle
of the fly

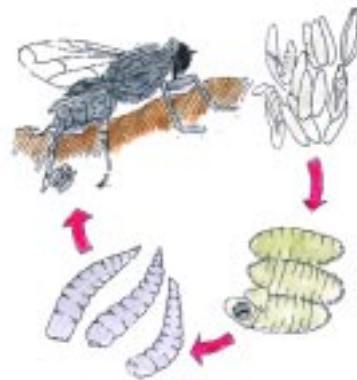

The females lay their eggs (between 120 and 130) in damp places. It takes between 6 and 42 days for the adult fly to develop. The speed of development depends on the temperature (it takes about 10 days in tropical countries). The larvae breathe oxygen and therefore cannot survive where there is no air. They are found in dry pit latrines which are not properly protected with lids, and in refuse dumps, a few centimetres below the surface. Adult flies are active mostly during the day, and rest at night. Fly density is at its maximum at temperatures averaging between 20 and 25°C.

Control measures

The first measures to be taken concern the environment. These are as follows:

- limit or eliminate breeding sites: collect refuse, improve compost heaps (cover with 30 cm of earth), protect latrines (lids), improve drainage, etc.;
- reduce sources of attraction for flies in kitchens, such as food scraps embedded in floors that are not smooth enough to keep clean (see Chapter 4: Kitchens);
- prevent flies from coming into contact with any pathogenic agent;
- protect food and eating utensils with lids;
- install fly traps around the kitchens.

Use of insecticides

Insecticides are used **only when there is an outbreak of disease**, because in that event it is absolutely essential to reduce the number of potential vectors of the pathogen. **Environmental protection measures must be taken at the same time.**

The most important thing is to spray breeding places (refuse bins, rubbish dumps, latrines, kitchens, etc.) using an insecticide with a residual effect. Spraying surfaces where flies alight and rest is not very effective because these surfaces are usually out in the open air, where the insecticide breaks down and quickly loses its effectiveness. **Figure 98** shows an operator spraying a refuse heap in order to prevent the proliferation of flies.

Figure 98

Spraying a place where flies proliferate



The scabies mite (*Sarcoptes scabiei*) causes an intense irritation of the skin which is commonly known as scabies. These mites are tiny arachnids which are almost invisible to the naked eye (between 0.2 and 0.4 mm). The female lays her eggs under the skin and burrows very close to the surface, at a rate of 1 to 5 mm per day. Itching occurs mainly between the fingers, on the wrists, on the elbows and around the armpits. Scabies is transmitted by personal contact, while the hosts are asleep. The mite can travel very quickly from one host to another; scabies is a condition typically found in overcrowded places and prisons. When the infected individuals scratch themselves they cause skin lesions which are vulnerable to superinfection. In newly infected individuals the symptoms do not appear at once. The zones of irritation are often localized, as shown in **Figure 99**.

Figure 99

Zones of scabies infection and irritation



Control measures

All parts of the body have to be treated with insecticide, usually in liquid form or in a cream or soap. Benzyl benzoate (10% lotion), permethrin (5% cream or 1% soap), or flower of sulphur in an oily liquid excipient can be used. Once these products have been

applied, they have to be left to dry for at least 15 minutes. The patient can then put his clothes on but must refrain from washing for at least one day.

Cockroaches are very common insects. Their life cycle is shown in **Figure 100**.

Figure 100
Life cycle of
the cockroach

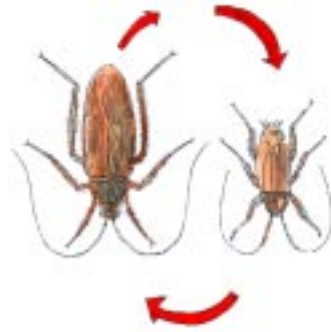

In places of detention they are mostly found in kitchens, in refuse containers, in the inspection hatches of sewage disposal systems, and more generally in all places where there is decomposing organic matter and food. Cockroaches come out at night to feed. They regurgitate part of what they eat and leave their droppings almost everywhere. Cockroaches are associated with filth. Owing to the secretions of their mucosa, they give off a characteristic smell. They play an indirect role in the transmission of the diseases whose pathogens are present in human excrement, such as cholera, dysentery, various forms of diarrhoea, typhoid fever and certain viral conditions. In some regions of Latin America, triatomines (*Triatoma infestans*) actively transmit Chagas disease (South American trypanosomiasis).

Control measures

These are similar to the measures taken to minimize the proliferation of flies.

The use of insecticides is doomed to failure unless accompanied by improvements in environmental hygiene. The spraying of walls, floors and roofing with residual insecticides is quite successful against triatomines, but cockroaches very quickly acquire resistance to insecticides.

Mosquitoes transmit many diseases, including malaria, yellow fever, filariasis, dengue, haemorrhagic dengue and other viral diseases which claim millions of victims around the world. Unfortunately these vectors are very difficult to combat, for mosquitoes can breed wherever there is water, and the adult insect has a flying range of up to several kilometres. Certain species play a more specific role in the prison environment because their habitat is often within the prison compound. These are the mosquito species which live in immediate proximity to man, such as *Aedes* (*Aedes aegypti*), which usually breed in domestic water storage tanks. Another species, *Culex* (*Culex quinquefasciatus*), breeds mainly in waste water and is very often found in septic tanks and latrines. As for *Anopheles*, the species which transmits malaria, its habitat is far too widespread for a control programme to have any chance of success. The life cycle of the mosquito comprises four stages, the first three of which take place in water. So it is in water that control measures are most effective. Eliminating adult mosquitoes is more difficult, because their behaviour varies widely from one species to another. **Figure 101** shows the different stages of development of the mosquito. The reproductive cycle varies between 7 and 10 days in favourable conditions.

Figure 101
Stages of development
of the mosquito

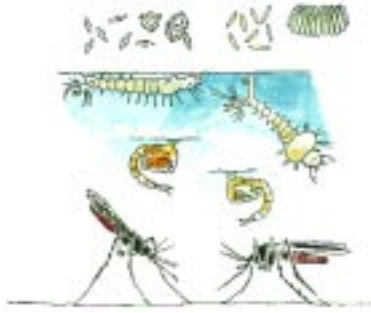

Environmental control measures

First and foremost, these involve techniques designed to change the environment in such a way as to make it unfavourable for the breeding of the species present in the area where the prison is located. The aim is to reduce to a minimum the number of mosquitoes that can hatch out, by:

- eliminating as far as possible pools of stagnant water and any objects that can hold water, such as worn tyres and old tin cans; small water tanks must be completely emptied once a week and the inside surfaces scrubbed to remove mosquito eggs and larvae;
- making sure that the lids of water storage tanks fit tightly and covering the vent pipes with wire netting (fine mesh with spaces no larger than 0.7 mm);
- improving ground drainage and keeping rainwater and sewage pipes clear;
- topping the vent pipes of septic tanks with wire mesh.

These measures will certainly minimize the numbers of adult mosquitoes and keep them below the threshold allowing efficient transmission of various diseases, but they cannot eliminate mosquitoes entirely, especially during the rainy season when there is water everywhere.

Larva control

In addition to the measures listed above, an effort can be made to combat larvae by preventing their development. Mosquito larvae of the *Culex*, *Aedes* and *Mansonia* species breathe oxygen through siphons, and *Anopheles* through tiny tubes on their backs. They therefore have to come to the surface to breathe. If they are prevented from doing so and are kept underwater by covering the surface with a thin film of oil, they will die. The surface of the water in storage tanks may also be covered with Styrofoam chips such as those used for packaging fragile goods. These chips can be made on the spot from discarded polystyrene packing material (moulded to the shape of the item packed), by soaking it in boiling water (100° C) and breaking it up into small pieces.

Oil

Oil is used mainly to eliminate larvae in pit latrines. Used engine oil can be employed for this purpose: 0.1 litre (a glass) of oil may be poured into each latrine once a week. This method must not be used if the water table is near the surface.

In ponds, 140 to 190 litres of diesel oil should be added per hectare. Some oils, such as coconut oil, spread more easily and 30 to 50 litres per hectare may be enough. This procedure, however, is costly and the protection it offers lasts no more than a few weeks. The effluent from the pond must be checked by examining the outlet T-pipes, to make sure there is no contamination of rivers or streams.

Larvicides

Larvicides may also be used. Some substances have such low toxicity and are so effective against larvae that they can be added to drinking water. The relevant government department must be consulted, however, before such products are used. If they are approved, products such as temephos or iodofenphos are extremely effective, and their toxicity for fish and mammals is very low. The recommended dosage is 50 to 100 grams per hectare, but care must be taken with their formulation.

These products can be obtained in the form of water-soluble sachets; in this case all that has to be done is to follow the manufacturer's instructions concerning dosage. Temephos is also available in granules containing 1% active ingredient, which slowly release the larvicide and thus maintain the concentration necessary to eliminate the larvae.

5. 2 Combating the main vectors with insecticides

Environmental management techniques and preventive measures cannot stop the proliferation of ectoparasites in prisons. Admittedly, such action can reduce the number of flies and eliminate breeding grounds for mosquitoes, but it has no effect on vectors such as lice and fleas, which enter the prison on the bodies of individuals who have been arrested. Slowly but surely, all the detainees sharing a dormitory with the new arrivals and then the entire prison population will become infested. Curative measures will therefore be required to eliminate as many ectoparasites as possible and thus to prevent widespread transmission of the various diseases described above. Such measures involve the use of **toxic** substances, so precautions are indispensable to avoid poisoning the detainees treated and the staff dispensing the treatment.

Types of insecticide which may be used in prisons

Insecticides are classified in different categories in accordance with their chemical formulas and their characteristics. **Box No. 20** lists the main categories and gives the names of some common products, together with their toxicity for the rat (mammal), expressed in mg/kg (milligrams per kilogram). **Toxicity** is usually expressed in terms of LD₅₀ (lethal dose) in mg/kg. This figure represents the amount of pure insecticide that has to be ingested per kg of body weight to kill 50% of the test animals. Obviously, among insecticides having the same effect, the one chosen will, where possible, be the one with the lowest toxicity; that is, the one whose LD₅₀ is as high as possible. In other words, the larger the amount that has to be ingested, the less the insecticide is toxic for mammals. **Residual effect** is the period of time during which the insecticide remains effective.

Box No.20

Category, name, toxicity and residual effect of some insecticides

CATEGORY	NAME	TOXICITY*	RESIDUAL EFFECT
Organochlorines	▶ DDT	110	> 6
	▶ Chlorpyriphos	135	





Organophosphates	▶ Malathion	2,100	2 – 3
	▶ Pirimiphos-methyl	2,000	
	▶ Fenithrothion	500	
	▶ Temephos	8,600	
	▶ Iodofenphos		
Carbamates	▶ Propoxur	100	2 – 3
	▶ Bendiocarb		
Natural pyrethroids	▶ Pyrethrum extract	low	nil
Synthetic pyrethroids	▶ Deltamethrin	3,000	4 – 6
	▶ Permethrin	4,000	2 – 3
	▶ Lambda-cyhalothrin	58-80	> 6

* LD₅₀ in mg/kg in one month by oral route (pure compound)

Insecticides are **made up with inert substances**, depending on the purpose for which they are intended, and in varying concentrations of the active ingredient, for example 50%, 25%, 10% and so on. Their toxicity is proportional to the amount of active ingredient contained in the formulation. Before they are used, these insecticides are again diluted so that they can be applied in the proper dosage, which is usually expressed in g/m² or mg/m². Only a few grams, or even a few milligrams, of active ingredient is applied per m². The final degree of toxicity for the detainees is therefore low. On the other hand, the personnel in charge of applying the insecticides are in constant contact with them and have to be specially protected. It is also important to identify precisely the type of product being used, the type of formulation and the concentration so as to avoid errors of preparation. The cans or sachets must be labelled correctly, and the labels must be securely attached so that they do not become unstuck. **Figure 102** shows different types of containers, each bearing a label clearly identifying the product contained.

Figure 102
Types of container



Formulations

The effectiveness of an insecticide depends on the dosage, that is, the amount of active ingredient sprayed per unit of surface area. To achieve uniform distribution, therefore, spraying operations must be carried out by simple methods that anyone can use. To this end, insecticides are formulated in such a way that they can be diluted in a liquid, usually water, and applied by means of hand-held sprayers fitted with a pump. When the insecticide is in powder form, it is sprayed by means of hand-held pressure dusters. **Box No. 21** lists the types of formulation found on the market.

Box No. 21

The most common formulations*

► **Liquid concentrates**

These contain high concentrations of active ingredient and organic solvents, and are usually diluted in diesel oil or kerosene before being applied. They should not be used in a prison environment because they are applied by fogging, a procedure that requires rather complex equipment.

► **Emulsion concentrates (EC)**

These are concentrated solutions of active ingredient in an organic solvent, with the addition of an emulsifying surfactant which allows the compound to be dispersed in water; the resulting solution can be sprayed. This type of formulation is in common use but may be subject to transport restrictions (air transport).

► **Wettable powders (WP)**

In these formulations the active ingredient is mixed with a wetting agent to aid rapid dispersion in water. The mixture is prepared just before use by adding the powder to the water. Wettable powders are often packaged in sachets containing enough powder to prepare 10 or 20 litres of the solution to be applied. They are easy to store and transport, and are often used in prisons for applications with a residual effect.

► **Dusts**

In dusts the active ingredient is finely ground and mixed with an inert powder (talc, etc.) which is insoluble in water. When dusts are used to combat human ectoparasites (lice, fleas) and put in direct contact with the skin, the concentration of active ingredient is low, in the order of 0.5 to 1%.

► **Granules**

These are inert particles (clays, kaolin) impregnated with insecticide. They are used to eliminate the aquatic stages of various vectors (e.g. mosquito larvae). They are not often used in prisons, except to control mosquito larvae in drinking water storage tanks in the event of an epidemic (yellow fever, dengue, etc.).

* See UNHCR/WHO, *Vector and Pest Control in Refugee Situations*, Geneva, 1977

Residual effect

Most insecticides break down under the effect of UV radiation, humidity and temperature variations. This degradation varies with the type of insecticide, its formulation and the surface on which it is sprayed. It is considered that in prisons insecticides remain active for between four and six months, as they are not exposed to the light. Applications therefore have to be repeated every six months, especially when the prison is overpopulated and when there is a rapid turnover of detainees. In the absence of visible infestation, one application per year should be enough. If an infestation occurs, it is obviously time to repeat the application of insecticides. Insecticides should not be sprayed on freshly whitewashed walls, as lime accelerates their breakdown.

Resistance to insecticides

Insects are capable of developing resistance to the action of chemicals. Indeed, many species are no longer sensitive to certain organochlorines, or even to most of the commonly used insecticides. It is therefore important to alternate the insecticides used in order to avoid this type of problem.

WHO has published technical papers describing methods of detecting resistance in each group of arthropods. It also supplies the relevant authorities with the materials needed to perform such tests. Before making any purchases, therefore, all the necessary information must be obtained from those authorities to ensure that the action planned is in compliance with national legislation.

Insecticides used in the prison environment

The rule is to opt for the insecticides which are in use in the country concerned, and which are generally approved by the Ministry of Public Health. The Ministry is usually able to inform users of the level of resistance to a given product approved for use in the country. If no precise information is available, the choice will fall on the insecticides which are the least toxic and against which no resistance has yet been observed. For treating walls and bedding, permethrin and deltamethrin in the form of wettable powder will be used. These insecticides have very low toxicity, their (oral) LD₅₀ for the rat being 3,000 and 4,000 mg/kg respectively. Malathion, pirimiphos-methyl (Actellic) and other insecticides with residual effect, such as iodofenphos, may serve as substitutes.

For treatment against lice, which brings the active ingredient into contact with the skin, the insecticide of choice is 0.5% permethrin (Coopex), which may be replaced by 1% propoxur (Baygon) or 2% pirimiphos-methyl (Actellic). These insecticides have been approved for this type of treatment and, if properly applied, create no risk for the individuals concerned.

5. 3 Implementation of a vector-control programme

Once all the necessary authorizations have been obtained, the right moment for the operation has to be chosen. The treatment must be carried out in the dry season, because the detainees will have to remain outside their cells and dormitories for at least **one full day**. Before the operation proper is launched, the detainees must be informed of its purpose and how it will be conducted. This information can be relayed by the persons responsible for each dormitory, who will have been briefed beforehand on the important details of the operation, including all the precautions to be taken to avoid any possibility of poisoning.

Spraying of walls, bedding and surfaces

Bedframes are usually made of metal and the sleeping surfaces of wood.

When chemicals with residual effects are being used for disinfestation, the wooden parts of the beds must be sprayed.

The detainees' blankets and clothing – also favourite haunts for ectoparasites – must be treated as well.

The aim is to spray the insecticide on the walls and part of the floor and to impregnate the bedding in order to prevent the proliferation of crawling insects. Those who are planning the operation therefore have to know the **total area** to be covered, the number of cells and dormitories to be sprayed, and also the type of surfaces to be treated. If no plan of the prison is available, one should be drawn up with the agreement of the administration so that the exact number of dormitories, cells and other rooms to be treated can be ascertained. The treatment plan must take account of security imperatives and of

the fact that it is not often possible to empty all the prison premises of their occupants. All personal effects, and in particular items used for eating meals and storing water, must be removed from the quarters. It is estimated that one operative can cover a maximum area of 500 m² per half-day of work, the rest of the day, usually the afternoon, being taken up by the drying of the insecticide and the process of returning the detainees and their personal effects to their quarters. **Box No. 22** outlines the different stages of the operation.

Box No. 22

Stages of an insecticide spraying operation

1. Choose an approved insecticide in consultation with prison administration officials and the Ministry of Public Health.
2. Draw up a plan of the prison showing the location of the cells and dormitories, and decide on the order in which operations will be carried out.
3. Calculate the amounts of insecticide and the number of operatives required.
4. Give the operatives the necessary equipment and training.
5. Inform the persons in charge of each dormitory or section and the inmates of the way the operation will be conducted.
6. Take the detainees out of the cells and dormitories in the order established in the plan. Remove items used for eating meals and storing water.
7. Spray the walls, floors and beds; impregnate blankets and mattresses with insecticide and leave them out in the sun to dry.
8. Wait until the walls and other treated surfaces are dry, then return the detainees to their quarters.

Calculating the quantity of insecticide required

The amount of insecticide is calculated as follows:

$$\text{Amount of insecticide required in kg} = \frac{100 \times \text{area} \times \text{dosage}}{1,000 \times \text{concentration}}$$

area = total area to be sprayed in m²

dosage = dose of active ingredient of insecticide in grams to be applied per m²

concentration = concentration of insecticide expressed as a percentage

This formula takes account of the fact that in general it takes 40 ml of insecticide solution to cover an area of 1 m² properly. When the surfaces to be treated are very porous and absorbent, twice that amount may be necessary, and this should be taken into account in calculating the amounts necessary.³⁰

Box No. 23 gives, as an example, the calculation for the typical prison described in previous chapters, with two different insecticides, different initial concentrations and different dosages. When the choice of an insecticide is being made, it is important to take these different parameters into consideration, because what counts is the **dose per m²**, and that is what determines the cost of the operation. The cost of deltamethrin per kilogram of active ingredient may appear high, but as the active dose is very low its cost is in fact comparable with that of other insecticides.

Box No. 23

Calculating the areas to be sprayed and the amounts of insecticide required

These calculations relate to the prison described previously. The dimensions of the various cells are indicated in the plan shown in Figure 3.

Calculating the total area to be treated

For this purpose, the following are taken into account: the area of the walls, which are treated to a height of 2.5 m, of a strip of floor 0.5 m wide along the base of the walls (against fleas), and of the surfaces (slats or planks) used for sleeping, given that there are 10 tiers of two bunk beds accommodating 20 detainees in each dormitory, and one set of two bunk beds in each cell. Each bed measures 2 m x 0.8 m. Dormitories Nos 5 and 6 have a slightly smaller area, their dimensions being 5 x 10 m instead of 6 x 10 m).

QUARTERS	AREA (M ²)
Dormitory No. 1	150
Dormitory No. 2	150
Dormitory No. 4	150
Dormitory No. 3	150
Dormitory No. 5	150
Dormitory No. 6	150
Women's dormitory	150
Cells	150
Kitchen	80
Storeroom	80
Dispensary	90
Administration 1	150
Administration 2	150
Total	1,750
+ 10%	175
Total	1,925

Amounts of insecticide required

The total area is rounded up to 2,000 m². Two types of insecticide are available: deltamethrin 2.5% WP (K-Othrine), to be applied in the dosage of 0.025 g of active ingredient per m², and permethrin 25% WP (Coopex), to be applied in the dosage of 0.5 g of active ingredient per m². The volume of solution required per m² is 40 ml. This gives, in kg:

$$\text{deltamethrin} = \frac{100 \times 2,000 \times 0.025}{1,000 \times 2.5} = 2 \text{ kg} \quad \text{permethrin} = \frac{100 \times 2,000 \times 0.5}{1,000 \times 25} = 4 \text{ kg}$$

On the basis of 40 ml/m², about 80 litres of water will be used. As permethrin is available in boxes containing twenty 25-g sachets, 8 boxes containing a total of 160 sachets will be needed for the operation. Deltamethrin is marketed in 33-g sachets, so 60 sachets will be needed. The dosage may have to be increased, depending on the surfaces to be treated and the type of insect to be eliminated. In this case the amounts required will have to be recalculated accordingly. It is important to make a distinction between liquid coverage and dose. If a double dose is required, you must either double the concentration of the initial solution to be sprayed or double the volume applied, that is, use 80 ml/m² instead of 40 ml. Whatever the option adopted, the number of kg of powder will be doubled, as either twice the number of sachets of powder are put in the spray or twice the amount of solution is prepared.

To simplify matters, we have considered that the area to be sprayed in each dormitory is the same. Figure 103 gives an idea of the zones to be treated.

Figure 103
Zones to be treated

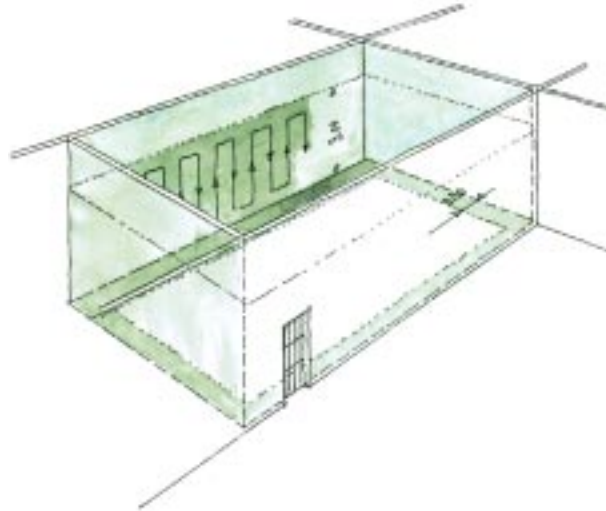

Organization of spraying operations

Any spraying operation begins with the setting-up of teams. Such an operation can be carried out only by specialized technicians who are used to working with insecticides. If necessary, and in the case of a large-scale programme to be conducted in several prisons or even all the prisons in the country, the first thing to do is to select and bring together the relevant officials on the regional level in order to give them training in vector-control techniques. An example of the content of such a training course and the corresponding practical exercises is given in Box No. 24.

Box No. 24

Controlling the vectors of disease in prisons

Example of the content of a training course for trainers (Addis Ababa, 1997)

DAY	SESSION	SUBJECT	METHOD
1	1	▶ Opening of the seminar; preliminary remarks; administrative organization; pre-test to determine initial level of knowledge	Lecture
	2	▶ Prevalence of vectors of disease in prisons; relationship with environmental engineering	Discussion
	3	▶ Diseases carried by vectors and control measures	Lecture
	4	▶ Basic notions of entomology	lecture
	5	▶ Ectoparasites and insects: life cycle and biology	Lecture
2	1	▶ Proliferation of vectors of disease in prisons	Lecture/discussion
	2	▶ Environmental control measures	Lecture
	3	▶ Chemical control measures	Discussion
	4	▶ Information necessary for planning an operation	Lecture/workshop
3	1	▶ Introduction to spraying with residual effect	Lecture
	2	▶ Insecticides, safety measures	Lecture
	3	▶ Planning an operation; staff and equipment needed	Workshop
	4	▶ Familiarization with equipment	Workshop





4	1	▶ Spraying methodology and techniques	Workshop
	2	▶ Maintenance of equipment : problems	Workshop
	3	▶ Louse control methods : with and without insecticides	Lecture/workshop
	4	▶ Organizing a disinfestation operation	Workshop
	5	▶ Case study: visit to a prison	
5	1	▶ Health educatio: techniques, objectives	Lecture/discussion
	2	▶ Supervision and evaluation of the programme	Lecture/discussion
	3	▶ General discussion on implementation of the programme in different prisons	Discussion
	4	▶ Post-test, results of tests, discussion, final remarks	Discussion
Sessions: 1 : 8.30 → 10.00 2 : 10.30 → 12.00 3 : 13.30 → 15.00 4 : 15.30 → 17.00			

The regional officials having attended a course such as the one described above will be given responsibility for training and for the supervision of operations. These officials, who are usually employed by the regional public health services, then train operatives chosen by the prison administration from among the detainees. The team leaders recruited are often the detainees in charge of cleaning activities in the prison. **Box No. 25** gives the minimum number of members of a spraying team for a prison holding no more than 1,000 detainees, together with the minimum equipment necessary to ensure that the operation can be carried out safely.

Box No. 25

Composition of a spraying team, protective gear and equipment needed for preparing the solutions

Composition of the spraying team

- ▶ 1 supervisor
responsible for all the operatives, for training them, for giving courses in basic hygiene, and for explaining the operation to dormitory leaders
- ▶ 2 operatives
working in turns with the same sprayer; they are also responsible for the maintenance of sprayers and other equipment
- ▶ 1 mixer
who prepares the solutions for spraying by adding the wettable powder to the sprayer tank; he is also in charge of the insecticides, the number of sachets used and the amounts sprayed in litres.

In general, one spraying team per prison is quite sufficient. In optimum conditions, one operative can cover a surface area of 500 m² in half a day. In very large prisons, and if the layout of the buildings so requires, a second team may be set up so that the operation can be completed in a week at most.

Equipment needed for preparing and spraying the solutions

- ▶ 1 complete pressure sprayer per team

Protective gear

- ▶ Overalls *2 sets per person*
- ▶ Wide-brimmed hats *1 per person*
- ▶ Rubber boots *1 pair per person*





- | | |
|--------------------------------|--------------------------|
| ▶ Protective goggles | <i>1 pair per person</i> |
| ▶ Rubber gloves | <i>1 pair per person</i> |
| ▶ Face masks (painter's masks) | <i>10 per person</i> |
| ▶ Bars of soap | <i>1 per person</i> |
| ▶ 20-litre jerry can | <i>1 per team</i> |
| ▶ Plastic funnel | <i>1 per prison</i> |
| ▶ Plastic buckets | <i>2 per prison</i> |
| ▶ 200-litre storage tank | <i>1 per prison</i> |

Each operative has to have two sets of overalls so that he can change every day. The soiled overalls must be washed every evening and be ready for use the next day.

Spraying equipment

Pressure sprayers are generally used in prisons. They are easier to handle and can reach places inaccessible to sprayers with piston pumps operated by a lever. The sprayer most commonly used is the type shown in **Figure 104** (Hudson X-Pert). It is also the sprayer recommended by WHO.

Figure 104
Hudson X-Pert™ sprayer



This sprayer is usually made of stainless steel and has a working life of several years if properly maintained. There are plastic sprayers which work according to the same principle, but these have a much shorter working life. The insecticide solution is compressed by an air pump and projected by a wand fitted with a nozzle. For regular spraying, constant pressure has to be maintained and a few basic principles must be observed. The aim is to achieve a constant output per minute. These sprayers are usually calibrated to give an output of 760 ml/minute; therefore if 40 ml/m² are to be sprayed, about 20 m² have to be covered per minute, that is, an area of five metres by four. Consequently, the operator must be trained to cover this area efficiently in one minute.

If the following parameters are respected:

- output of 760 ml/minute;
- spraying angle of 60 degrees between the wand and the surface treated;
- distance of 45 cm between the nozzle and the surface; it should be possible to spray a swath some 75 cm wide. **Figure 105** shows the desired result and how the operative covers successive swaths so as to ensure uniform application of the insecticide. It is sometimes difficult to maintain a regular rhythm of application because beds and

other obstacles get in the way, or because the room being treated has a complicated layout. In these circumstances the operative will tend to increase the amount of insecticide used, which is not a problem in itself except that it increases the amount needed to complete the job.

Figure 105
Operative spraying
insecticide



The procedure for calibrating the sprayer and the action of the operatives is described in **Box No. 26**.

Box No. 26

Procedure for calibrating sprayer output and operatives' rate of application

Calibrating the output of the nozzle

- ▶ Clean all the parts of the sprayer and check for leaks.
- ▶ Fill the sprayer with 8 litres of water.

Example of calibration for the Hudson X-Perf™

- ▶ Bring the pressure up to 40 psi, that is, about 1.8 or 1.9 bar (1 psi = 1 lb/inch²; 1 bar = 1 kg/cm²). Working pressure varies between 55 and 25 psi, falling with the level of the liquid in the tank. It is therefore necessary to pump from time to time so as to maintain the pressure around 40 psi.
- ▶ Measure the output per minute by means of a 1,000-ml graduated receptacle. It must be between 720 and 800 ml per minute. If it is outside this range, the nozzle needs to be replaced.

Calibration of the operatives' spraying rate

- ▶ On surfaces that are not very absorbent, 40 ml/m² are applied. The output of the sprayer is 760 ml/minute. The application rate is therefore 19 m²/minute, close to 20 m²/minute, which is the target figure used for the sake of simplicity. The operatives have to practise maintaining this rhythm.

Procedure

- ▶ On a wall, mark out an area 3 m high and 6.66 m wide. Then mark out vertical swaths 75 cm wide with an overlap of 5 cm. The total area is thus 20 m². The nozzle must be held 45 cm from the wall. Pressure is maintained at 40 psi (1.89 bar).
- ▶ The swaths are sprayed alternately from top to bottom and from bottom to top.
- ▶ Avoid the formation of droplets.

- ▶ The operative must practise covering this surface in one minute, that is, each of the nine 3 m x 0.75 m swaths in about 7 seconds. Taking into account the time it takes to move from one swath to the next, he has to cover the entire surface in 60 seconds.
- ▶ After every 60-second period he must shake the tank, check the pressure, and if necessary pump to keep the pressure at 40 psi. The operative must get used to pumping more often as the level of insecticide in the tank falls.
- ▶ At the end of the operation, the operative must clean the sprayer completely, hang it up with the opening pointing down, and clean the nozzles and valves with clean water. He must take a shower and his clothes must be washed. The water used for cleaning the equipment should be poured into a pit where it cannot contaminate drinking water or rivers. Insecticides are generally much more toxic for fish and birds than for mammals.

After the operation the insecticides and equipment must be cleaned and put away under lock and key (see **Figure 106**).

Figure 106
Insecticides and
spraying equipment
stored separately

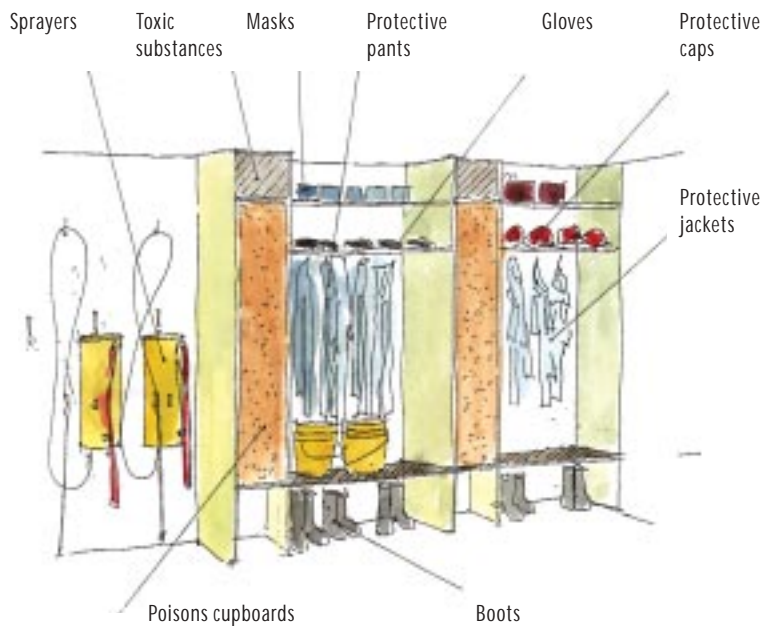

Mosquito netting

It is strongly recommended that mosquito netting be fitted over the windows and other openings in dormitories and toilets. In the dispensary the patients should be given individual mosquito nets (see **Figure 107**). These protect the patients from mosquito bites and prevent the transmission of malaria and other diseases, such as dengue, from one patient to another. They also prevent the transmission of other infectious agents by flies, which settle on wounds and irritate the patients. The protection provided by mosquito nets is significantly increased if they are impregnated with insecticide. It is now possible to buy mosquito nets impregnated with insecticides which have a long-term residual effect. These nets do not require retreatment for 3-5 years.

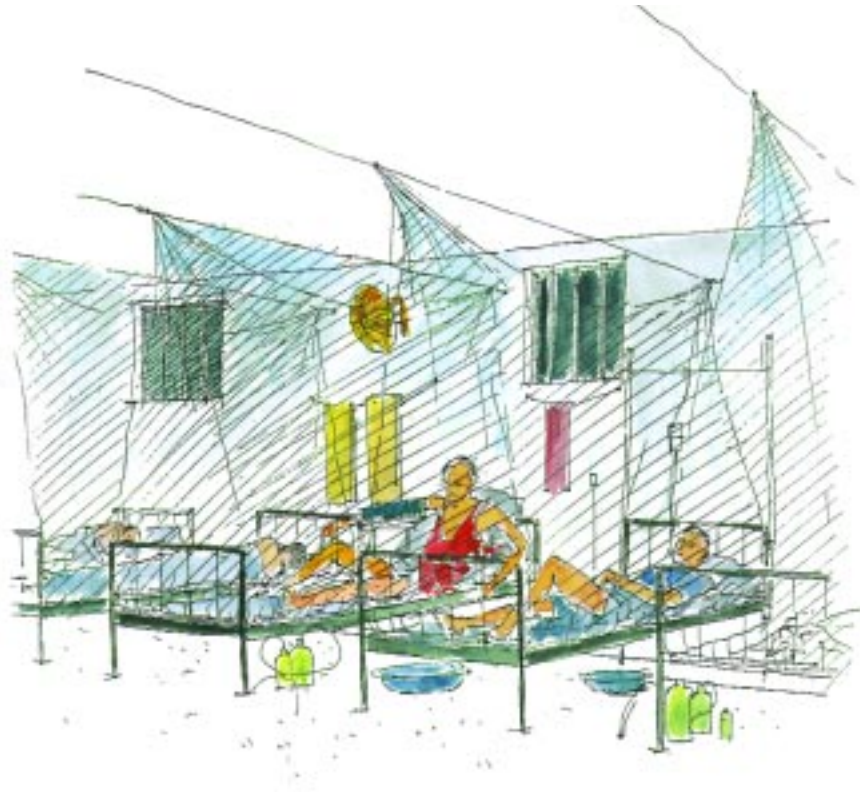

Annex 1

Check list for evaluating environmental engineering problems and their effects on health

Need to take a global view of the problems

In successive chapters we have examined the importance for detainees' health of each domain of environmental engineering. It must be borne in mind that while every problem identified results from a deficiency in the corresponding domain, there is often interaction between several factors: a deficiency in one sector may aggravate the situation in another. For example, restrictions on the water supply may have disastrous consequences for sewage disposal, as the drains will quickly become blocked if they are not regularly flushed out. The toilets will become clogged, and soon there will be an increase in diseases transmitted by the faeco-oral route, which again will be difficult to combat if the detainees do not have enough water to wash themselves properly. Water shortages also have implications for skin diseases and make it difficult to maintain an acceptable level of hygiene in the kitchens.

It is therefore useful to have a means of quantifying the situation in the relevant domains, while at the same time trying to determine the relative importance of the different factors so as to be in a position to establish priorities.

This is an important exercise on the level of one prison, but it is often necessary to compare the situation in several places of detention so as to determine which one of them and, if possible, which sector, requires priority attention. The decision must be based on data that are as objective as possible. Thus information must be gathered on the state of the infrastructure, and this information must be related to the material conditions of detention by means of rapid and simple diagnostic methods. These will enable you to:

- determine which prisons have the most serious problems, by drawing up a scale of comparison between the various penal establishments on the basis of criteria which are as objective as possible;
- plan the action to be taken as a priority, for in most cases the resources available to prison administrations are already stretched because of drastic budget cuts;
- draw up detailed planning budgets for the domains concerned so as to determine, for example, approximately how many measures have to be taken to control outbreaks of disease, and thus what level of preparation there must be on the national scale;
- follow up the problems affecting each prison from one year to another, using the same evaluation criteria.

The check list and evaluation criteria

The check list used is fairly simple. It allows non-specialists to make a rapid assessment of the situation in a prison by asking easy questions which do not require specific expertise in any particular domain. The check list is divided into five parts, each containing questions relating to an area of activity already covered in this manual,

that is, hygiene and health, water supply, sanitation, space and accommodation, kitchens and preparation of meals.

Filling in the questionnaire

For every question there is a choice of four replies, and **only one reply** is possible.

YES	NO	? = NOT KNOWN	NA = NOT APPLICABLE
1	0	0	0

Thus the reply may be: yes; no; not known (?); or not applicable (NA), when the question does not apply to the prison concerned. Each question is allocated a value of 0 or 1. Prisons with the highest total score are those that have the fewest problems in terms of environmental engineering. The fewer the problems in a given domain, the higher the score obtained.

This type of check list is designed to eliminate as far as possible any bias due to the subjective opinions of the person filling in the questionnaire. The questions are formulated in such a way as to "force" the person replying to make a choice, and to limit his own personal appreciation of the situation in the prison.

Obviously, this questionnaire in no way replaces a detailed study conducted by professionals who are used to conducting evaluations and interpreting the results. It does, however, allow rapid visualization of the situation in a prison and in each of the domains considered.

The questions can be adapted to each particular context.

For example, question 5.3: *Are there enough stoves for cooking meals?*

In Ethiopia this will be changed to: *Are there enough wot stoves and injera plates for the preparation of meals?*

Prison questionnaire

Prison:
Capacity:

Date of evaluation:
Total number of detainees:

1. Detainees' hygiene and health

	Yes	No	?	NA	Comments
1. 1 Do the detainees have access to medical care?	1	0	0	0	
1. 2 Is there a dispensary in the prison?	1	0	0	0	
1. 3 Can sick detainees be taken to a hospital?	1	0	0	0	
1. 4 Is diarrhoea a problem?	0	1	0	0	
1. 5 Are there cases of skin disease?	0	1	0	0	
1. 6 Are there cases of respiratory disease?	0	1	0	0	
1. 7 Are detainees with respiratory disease mixed with the other detainees?	0	1	0	0	
1. 8 Have there been any epidemic diseases?	0	1	0	0	
1. 9 Are the detainees regularly supplied with soap?	1	0	0	0	
1.10 Do the detainees have access to showers?	1	0	0	0	

1.11	Are the detainees able to wash their clothes?	1	0	0	0
1.12	Are there any cases of malnutrition?	0	1	0	0
1.13	Is the mortality rate higher than the national average?	0	1	0	0
1.14	Is a nurse present on a regular basis (at least 5 days a week)?	1	0	0	0
1.15	Are the detainees allowed to take exercise in the prison compound or to work outside the prison?	1	0	0	0

Score (total = 15)

2. Water supply

		Yes	No	?	NA	Comments
2. 1	Does the water come from the urban mains supply?	1	0	0	0	
2. 2	Does the water come from a lake, a pond or a river?	0	1	0	0	
2. 3	If the water comes from a well, is the well protected?	1	0	0	0	
2. 4	If the water comes from a spring, is the spring protected?	1	0	0	0	
2. 5	Is water distributed to all parts of the prison?	1	0	0	0	
2. 6	Do all the detainees have free access to water?	1	0	0	0	
2. 7	Are there any restrictions on the use of water in the prison?	0	1	0	0	
2. 8	Does the prison have a water reservoir in working order?	1	0	0	0	
2. 9	Can the detainees store water for use at night?	1	0	0	0	
2.10	Is the amount of water stored for the night sufficient?	1	0	0	0	
2.11	Are there frequent and inconvenient water cuts?	0	1	0	0	
2.12	Does the water have any particular colour, taste or smell?	0	1	0	0	
2.13	As far as you know, is the water treated (chlorinated) before it enters the prison?	1	0	0	0	
2.14	Is the water-collection system (pump, jerry can, etc.) appropriate?	1	0	0	0	
2.15	Is there a maintenance team responsible for the water distribution system in the prison?	1	0	0	0	

Score (total = 15)

3. Sanitation

		Yes	No	?	NA	Comments
3. 1	If the prison has a sewage disposal system, does it become clogged from time to time?	0	1	0	0	
3. 2	If there is a system of dry latrines, do they overflow?	0	1	0	0	
3. 3	Is there at least one toilet block per 50 detainees?	1	0	0	0	
3. 4	Are the latrines or toilets dirty?	0	1	0	0	
3. 5	Are the detainees able to go to the toilet at night?	1	0	0	0	
3. 6	Is there a team responsible for maintenance of the toilets?	1	0	0	0	
3. 7	Is refuse collected regularly?	1	0	0	0	
3. 8	Is refuse burned or buried?	1	0	0	0	



3. 9	Is there a team responsible for refuse collection?	1	0	0	0
3.10	In general, are there pools of stagnant water (rainwater, waste water) inside or outside the prison compound?	0	1	0	0
3.11	Is there at least one shower per 50 inmates?	1	0	0	0
3.12	Can the detainees take at least one shower a week?	1	0	0	0
3.13	Are vectors of disease considered to be a problem?	0	1	0	0
3.14	Can the detainees wash their hands after using the toilets?	1	0	0	0
3.15	Do the detainees receive any health/sanitation education?	1	0	0	0

Score (total = 15)

4. Space and quarters

		Yes	No	?	NA	Comments
4. 1	Can the detainees walk about in the prison compound?	1	0	0	0	
4. 2	In the most densely populated cell, can the detainees stretch out to sleep?	1	0	0	0	
4. 3	Can the detainees stretch out to sleep in more than half of the cells?	1	0	0	0	
4. 4	Are the cells properly ventilated?	0	1	0	0	
4. 5	When it rains, does water leak into the cells?	0	1	0	0	
4. 6	Do the detainees have access to daylight in the cells?	1	0	0	0	
4. 7	If there are toilets in the cells, are they lit at night?	1	0	0	0	
4. 8	Is it too hot or too cold in the cells, according to the detainees?	0	1	0	0	
4. 9	Are the cells clean?	1	0	0	0	
4.10	Are the cells washed or disinfected regularly?	1	0	0	0	
4.11	Are there many insects and other pests?	1	0	0	0	
4.12	Is there a programme for regular disinfestation of the prison?	1	0	0	0	
4.13	Is there a programme for regular whitewashing of the prison cells?	1	0	0	0	
4.14	Is every detainee able to sleep on a mattress?	1	0	0	0	
4.15	Is there a team responsible for cleaning the cells?	1	0	0	0	

Score (total = 15)

5. Kitchen and meals

		Yes	No	?	NA	Comments
5. 1	Is the kitchen clean?	1	0	0	0	
5. 2	Is the kitchen regularly washed or disinfected?	1	0	0	0	
5. 3	Are there enough stoves for cooking meals?	1	0	0	0	
5. 4	Are the stoves in good working order?	1	0	0	0	

5. 5	Does the kitchen produce at least one hot meal a day?	1	0	0	0
5. 6	Is there a water storage tank in the hot kitchen?	1	0	0	0
5. 7	Are the food storage areas clean?	1	0	0	0
5. 8	Are there insects or rodents in the food storage areas?	0	1	0	0
5. 9	Is there a team in charge of kitchen maintenance?	1	0	0	0
5.10	Is there sufficient firewood for cooking meals?	1	0	0	0
5.11	Is there a shelter for storing firewood?	0	1	0	0
5.12	Is smoke a problem in the kitchen?	1	0	0	0
5.13	Do the cooks have the necessary utensils at their disposal?	1	0	0	0
5.14	Are there appropriate containers for the distribution of food?	1	0	0	0
5.15	Do the detainees have plates or bowls for eating meals?	1	0	0	0

Score (total = 15)

Domains evaluated

- *Detainees' health*

The aim here is to pinpoint the most significant health problems, which may be due to a deficiency in one of the other areas of environmental engineering. For example, a prison where the detainees frequently suffer from diarrhoea will often have problems with its water-supply, waste-disposal or food-preparation system. The check list should reveal the most obvious correlations, but cannot serve as a substitute for a diagnosis performed by a health professional such as a doctor or nurse. At most it will draw the attention of the non-specialist to matters about which he has no detailed knowledge and prompt him to request a more specific evaluation, which may or may not confirm these initial findings. It will also provide prison directors with arguments to support their requests, which is quite important because visits by experts are expensive and bound to give rise to discussion.

- *Water supply*

This is an easy means of determining whether, in a given prison, the detainees have access to sufficient amounts of good-quality water. The answers to the questions enable you to identify the source of the water supply, to determine whether the water is distributed in sufficient quantities throughout the prison, and to gain an idea of its quality. A comparison of the results with those of the health and hygiene checklist should provide information on how the water is used and, where necessary, indicate what action needs to be taken.

- *Sanitation*

As is the case for water, the answers to the questions should give an idea of the state of the prison's sanitary infrastructure. The answers should also be analysed in correlation with those relating to the detainees' health and hygiene.

- *Space and quarters*

The domain covered by this checklist is just as important because, as we have seen, overcrowding has considerable implications for water supply and waste-water disposal, and hence for the health of the detainees. These simple questions make it possible to assess accommodation conditions in the cells or dormitories and the population ratio, and will throw light on the results of the checklist relating to the detainees' health.

- *Kitchen and preparation of meals*

The answers to these questions, taken together, indicate the capacity of the prison to provide the detainees with daily meals.

Analysis of the results of the questionnaire

The total number of points obtained for each domain should be expressed in table form, and then on a graph, so that they can be compared visually. As the number of questions is the same for each domain, the presence of problems in any given sector is immediately obvious. Each result may also be expressed as a percentage. In the example given in **Box No. 27**, it can be seen at once that the prison in question has a problem with its water supply, and that the reason for this can probably be found in the source of the water.

Box No. 27

Results for prison P1

Maximum number of points for each domain = 15

Total for the 5 domains = 75

	NUMBER OF POINTS	% OF MAXIMUM
Detainees' hygiene and health	4	26.6
Water supply	3	20
Sanitation	5	33.3
Space and quarters	11	73.3
Kitchen and preparation of meals	12	80
Total	35	100

Figure 108 expresses these results in the form of a histogram. Closer investigation shows that the water comes from a nearby river and is only treated sporadically. There are also restrictions on the use of water, certainly owing to the fact that only a small number of detainees are detailed to draw water from the river and sufficient amounts cannot be brought into the prison for security reasons. Water is therefore rationed. Analysis of the "health and hygiene" domain leads one to believe that the poor quality of the water and the restrictions on its use have direct effects on the health of the detainees (diarrhoea, skin diseases).

Figure 108

Histogram showing scores for each domain evaluated

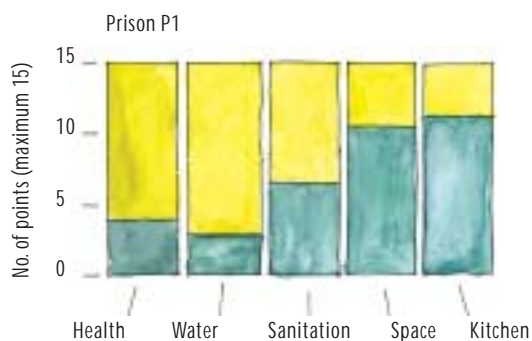

Evaluating a group of prisons

Very often, analysis of the results of a questionnaire highlights problems of which prison directors are already aware. Sometimes it reveals relationships of cause and effect, as in the case of prison P1 described above. On the other hand, a comparative analysis of all the results obtained for a group of prisons in the same region may provide interesting information and allow the prison authorities to determine which prisons require priority attention. In the most obvious cases, such as that of prison P1, it is even possible to identify the domains where the problems arise.

Table IV shows the check-list results for 10 different prisons, from P1 to P10.

Table IV Results of evaluation of 10 prisons

Number of points per domain (max = 15)

	P1	P2	P3	P4	P5	P6	P7	P8	P9	P10
1. Detainees' hygiene and health	4	9	12	7	3	13	12	5	4	11
2. Water supply	3	12	11	9	8	13	11	6	9	13
3. Sanitation	5	8	10	10	7	11	10	7	10	12
4. Space and quarters	11	10	11	6	5	12	12	12	6	10
5. Kitchens and preparation of meals	12	12	9	8	8	14	9	11	9	11
TOTAL	35	51	53	40	31	63	54	41	38	57

The results of the table, expressed in a graph in Figure 109, show that out of the 10 prisons, two present major problems and two others are just at the threshold of 40 points, which is arbitrarily selected as the score below which rapid action is required to prevent a deterioration in the detainees' health.

Figure 109

Results for 10 prisons and scores for each

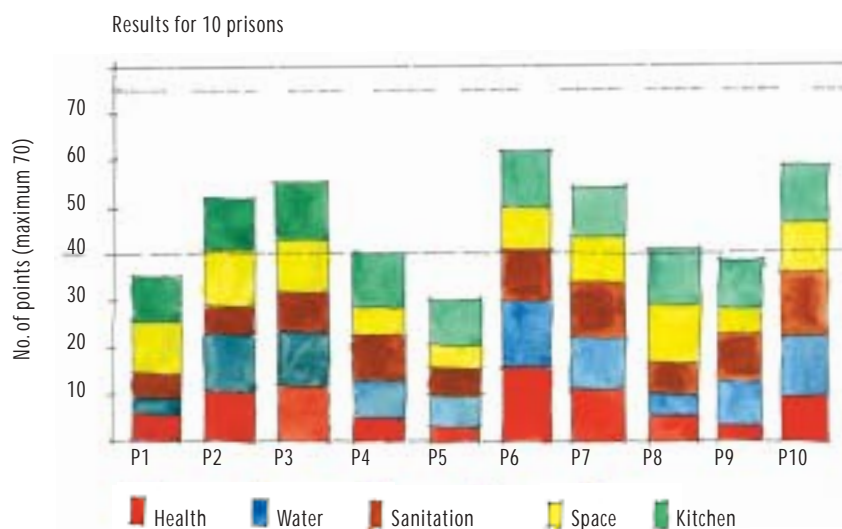

The results can be expressed in histogram form in different ways so as to establish a correlation between health problems and problems noted in the other domains studied. Figure 110 shows the result of an analysis, domain by domain, of four prisons with total scores lower than or near the threshold of 40 points.

Figure 110
Analysis of scores
by domain

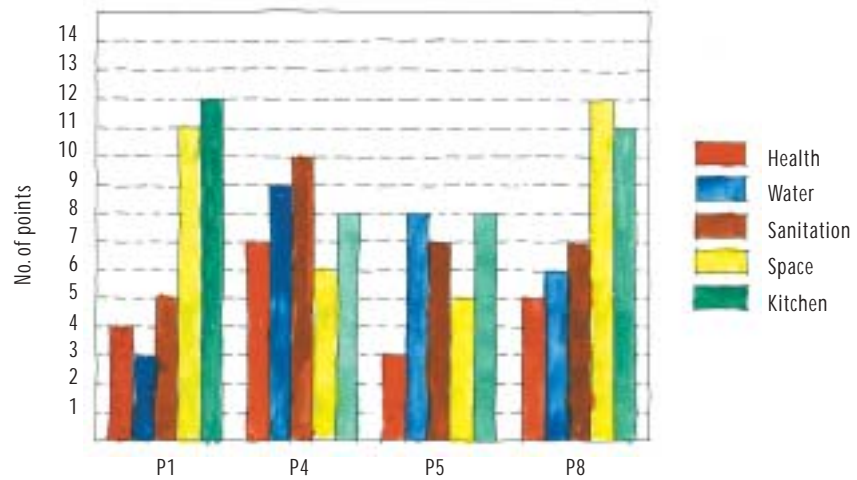

Prison P1 has low scores in the domain of health and in those of water and sanitation, so it is highly likely that the health problems are due to a shortage of water. Prison P5 has low scores in almost all sectors; this can probably be explained by the serious overpopulation, which in turn leads to a water shortage and also creates problems in terms of waste disposal.

Thus some preliminary conclusions can be drawn and, more important, a more detailed evaluation can be planned in the specific domains where problems have been noted. Action is needed as a priority in prisons P1 and P5.

It should be borne in mind that more complicated check lists do exist, in which the various parameters are measured precisely and more or less pertinent weighting factors are brought into play. For the purposes of this manual we propose a simple check list which can be used by everyone.

Annex 2

Example of price specifications for construction of a 50-m³ water reservoir

1. Setting-up of site and preliminary work

	Quantity	Unit price	Unit	Total
1. 1 Installation of site and dismantling at the end of the work, including transport of necessary materials and machines	1	All-inclusive		
1. 2 Grading of the site of the reservoir (30 m ³) and of the wall retaining excavated material (16.8 m ³)	46.8	m ³		
1. 3 Building of a rubble stone wall to retain an excavation 1.8 m high, including 0.6 m foundations; price includes labour, purchase and delivery of rubble stone, cement and sand, mortar 1:3	43.2	m ³		

2. Construction of the reservoir

2. 1 Lean concrete (1:2:4) for foundation, thickness 0.08 m	3.44	m ³		
2. 2 Reinforced concrete (RC) raft foundation 1:1.5:3, diameter 7.4 m, thickness 0.2 m, including reinforcement bars; and installation of intake, dewatering and outlet pipes (+ accessories, valves, etc.), to be supplied by the contractor	8.6	m ³		
2. 3 Circular reservoir wall made of compact quartzite, granite or gneiss rubble, height 2.52 m, thickness 0.5 m, cemented with mortar 1:3, including installation of suction, intake, dewatering, overflow and outlet pipes	25.7	m ³		
2. 4 Core to strengthen the structure (if it cannot be buried), RC 1:1.5:3, height 1 m, thickness 0.15 m	3.13	m ³		
2. 5 Circular footing, RC 1:1.5:3, with reinforcement bars	5.51	m ³		
2. 6 Footing for central column, RC 1:1.5:3, dimensions 1.15 x 1.15 x 0.15 m	0.2	m ³		
2. 7 Central column, RC 1:1:2, height 2.52 m, thickness 0.3 m	0.23	m ³		
2. 8 Two beams to support the cover-slab, RC 1:1.5:3, dim. 7 x 0.3 x 0.3 m	0.63	m ³		
2. 9 Cover-slab, RC 1:1.5:3, diameter 7.1 m, thickness 0.08 m	3.17	m ³		
2.10 Installation of two manhole covers (inspection hatches), dim. 0.8 x 0.8 m, made of steel min. 3 mm thick, including coats of anti-rust paint	2	pc		
2.11 Installation of two air ducts, steel, dim. 0.5 x 0.5 m	2	pc		
2.12 Application of a 1.3-cm layer of waterproof interior plaster on wall and foundation, internal diameter 6 m, cement mortar (CM) 1:3	0.99	m ³		
2.13 Application of a 1.3-cm layer of waterproof interior plaster, CM 1:3	1.14	m ³		

	Quantity	Unit	Unit price	Total
2.14 Application of two 1.3-cm layers of water-repellent cement on wall and foundation, CM 1:3	3.06	m ³		
2.15 Application of a layer of smooth coating on wall and foundation, internal diameter 6 m and thickness 2 mm, neat waterproof cement	0.15	m ³		
2.16 Water-repellent cement for the last three layers, then smooth coating	59	kg		
2.17 Application of two coats of epoxy paint, supplied by the contractor	76	kg		

3. Backfilling

3. 1 Backfilling up to the level of the natural terrain around the reservoir, including the material excavated from the reservoir site (30 m ³) and from the foundation trench of the retaining wall (16.8 m ³)	46.8	m ³		
---	------	----------------	--	--

4. Sub-contracted work

Estimate: hours of sub-contracted work apply only to work not provided for in this price specification sheet

4. 1 Stone-mason (man/day, 8-hr day)	day
4. 2 Labourer (man/day, 8-hr day)	day

5. Materials (estimated quantities and prices proposed)

5. 1 Portland cement 425 (50-kg bag)	bag
5. 2 Water-repellent cement	kg
5. 3 Paint (mixture of epoxy + catalyser + diluent)	kg
5. 4 Clean sand (delivered to site)	m ³
5. 5 Clean gravel	m ³
5. 6 Quartzite, granite, gneiss rubble (delivered to site)	m ³
5. 7 Fired clay bricks	pc

Total

Duration of work as estimated by contractor (in figures and spelt out):

Place and date:

Contractor:

Signature:

50-m³ reservoir

- Rubble block wall (equigranular quartzite)
- Manhole cover (steel, 0.80 x 0.80 x 0.03 m)
- Beams: 0.30 x 0.30 m, 5 Ø 10
- Central column 0.30 x 0.30 m, 4 Ø 14
- Raft foundation on reinforced footing
- Air ducts
- Reinforced cover-slab thickness = 0.08 m, Ø 10, mesh 0.20 m

Cross-section A-A

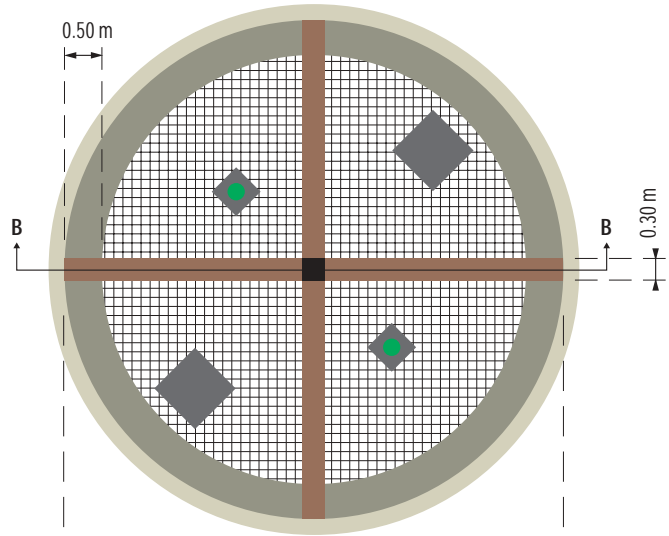

Cross-section B-B

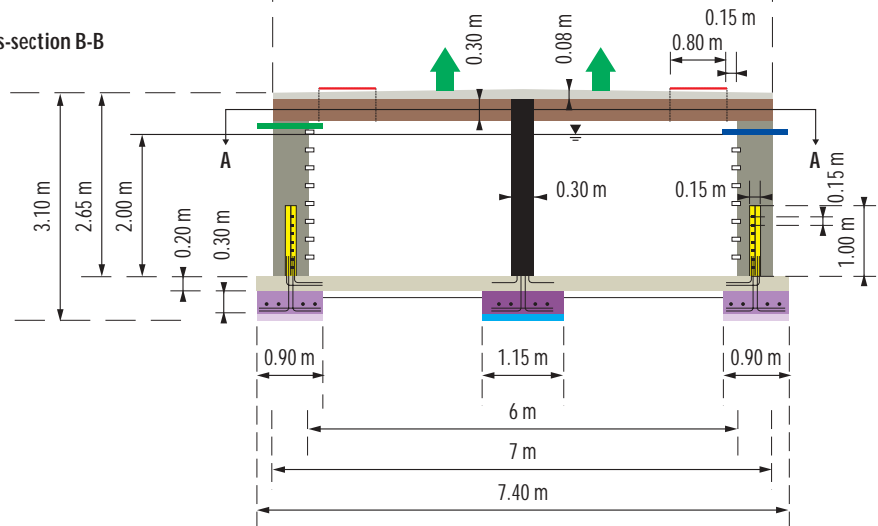

- Sloping concrete cover for runoff
- Inspection hatch
- Feed pipe (galvanized iron)
- Scale
- Core, RC (Ø 10): vertical reinforcement spacing = 0.3 m horizontal reinforcement spacing = 0.15 m if structure cannot be buried
- Raft foundation: lower level 6 Ø 12/m; upper level 7 Ø 10/m (per linear metre)
- Blinding concrete 1:2:4 thickness = 0.08 m
- Overflow pipe (galvanized iron)
- Central footing: 8 Ø 12 ; mesh de 0.15 m (both ways)
- Continuous circular footing: 8 Ø 12 circumference + 6 Ø 12/m radial

Annex 3

Estimates for materials and labour

Round figures are given to facilitate calculations.

Excavation	Per cubic metre	Per man
Ordinary earth	0.50 man/day	2.0 m ³
Gravelly earth	0.75 man/day	1.5 m ³
Altered rock	1.00 man/day	1.0 m ³
Hard rock	2.50 man/day	0.4 m ³

Carpentry	Per m³ finished wood
Carpenter	20 man/day
Labourer	20 man/day

Rubble stone and aggregate production	Per m³ rock broken	Per man
Labourer	15 man/day	0.066 m ³

Concrete	Per m³ of mixture	Mixture 1:2:4	Mixture 1:1:3
Cement		0.25 m ³	0.33 m ³
Sand		0.50 m ³	0.50 m ³
Gravel		1.00 m ³	1.00 m ³
<i>Labour:</i>			
Mason		1 man/day	1 man/day
Labourer		4 man/day	4 man/day

Coating	Per m³ covered (1 cm thick)	Mixture 1:4	Mixture 1:3	Mixture 1:2
Cement		0.0025 m ³	0.0030 m ³	0.0050 m ³
Sand		0.010 m ³	0.010 m ³	0.010 m ³
<i>Labour:</i>				
Mason		0.14 man/day		
Labourer		0.22 man/day		

Brickwork (mortar 1:4)	Per m³
Bricks	75%
Cement	0.063 m ³
Sand	0.25 m ³
<i>Labour:</i>	
Mason	1.4 man/day
Labourer	2.8 man/day

Blockwork (mortar 1:4)	Per m³
Concrete blocks	65%
Cement	0.089 m ³
Sand	0.35 m ³
<i>Labour:</i>	
Mason	1.4 man/day
Labourer	3.2 man/day

Annex 4

Biogas sanitation system

A biogas sanitation system is a system which collects, transports and treats waste water so that it can be discharged into the environment with minimum impact.

During the treatment process, the system releases gas which can be used as a source of energy to help meet the demand for cooking in the prison.

Such systems have been installed in several prisons in Rwanda.

Special features of biogas systems as compared with septic tanks

- Size: 100 m³ digester/1,000 detainees; 30 days' retention time at 20°C.
- The biogas system is airtight and therefore isolated from the outside.
- The system promotes intensive digestion, owing mainly to the high concentration of organic matter available for putrefaction in the effluent to be treated, with substantial production of biogas.
- There is no need to separate the matter in suspension; on the contrary, the entire volume of effluent is treated and it is expected that sludge removal will be necessary only every 5 to 10 years.
- The volume of effluent that has to be infiltrated after treatment is similar to the volume discharged from a septic tank, but the effluent is of better quality in terms of pathogen content.
- The price of a biogas system is about four times higher than that of a septic tank.
- The composition of the incoming effluent must be carefully monitored to ensure efficient treatment.

Technology adopted

- The biogas system comprises a pressure-resistant, hemispheric digester with a fixed dome (the movement of a floating bell would cause problems). The digester has a compensating chamber, whose purpose is to allow for the increase in pressure during the biogas storage phase and the decrease in pressure when the biogas is being used.
- The design adopted was modular, with a maximum unit capacity of 100 m³ and a compensating chamber for each module. This is because under the same conditions a series of small hemispherical digesters generates more gas per unit of feed stock than a single hemispherical shell of the same volume.
- The diameter of the inlet and outlet pipes is large (inlet: 200 mm; outlet: 600 mm) to avoid blockage.
- The materials used (brick masonry and roughcast concrete) were available locally, but skilled labour was required.
- The digester was buried for reasons of insulation and safety.
- The entire system flows by gravity and the overpressure created by the production of biogas.
- The digesters form a continuous series but have a bypass system for maintenance purposes.

- The system is expected to have a lifetime evaluated at dozens of years, even though no system has been observed for such a long period. Inspections should be carried out regularly and the biodigester must be desludged at intervals depending on its performance (about every 5 years)

Biogas system under construction at Gitarama Central Prison



Cross-section of a 100-m³ biodigester module

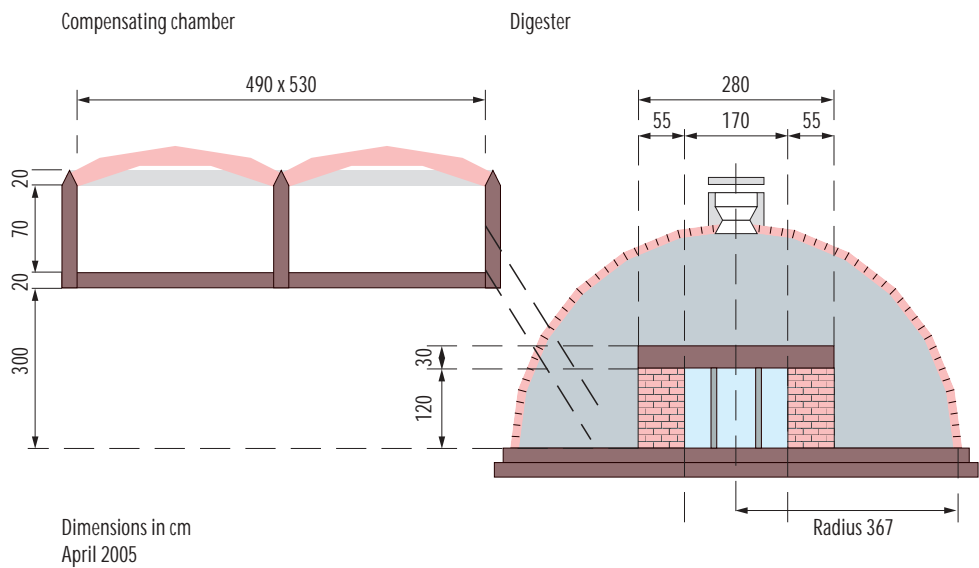

Performance

A study carried out by Kigali University under the supervision of the ICRC gave the following results.

Degradation of dry matter: around 60%.

Destruction of pathogens at 30-35°C, after 20 days:

Escherichia coli: 60%;

Streptococcus faecalis: 85%;

Salmonella: 99%;

Staphylococcus aureus: 99%;

Vibrio cholerae: 100%.

Biogas produced: around 25 l/capita/day.

Saving of firewood for cooking:

- according to energy calculations, between 10 and 15%;
- according to experience, about 32% in Cyangugu CP and between 30 and 50% in Mpanga CP.

This difference may be explained partly by over-consumption of firewood in the prisons, due to the use of damp wood, and the fact that there were no doors for closing the ovens and no lids to prevent loss of heat from the cooking pots.

Notes

- * In this handbook the masculine pronoun is used to designate both men and women.
- ¹ Any resemblance to an existing penitentiary establishment is purely accidental.
 - ² *Standard Minimum Rules for the Treatment of Prisoners*, adopted by the First United Nations Congress on the Prevention of Crime and the Treatment of Offenders, held at Geneva in 1955, and approved by the Economic and Social Council by its resolution 663 C (XXIV) of 31 July 1957 and 2076 (LXII) of 13 May 1977.
 - ³ For example, Europe's *Standard Minimum Rules for the Treatment of Prisoners*, and the US Justice Department's *Federal Standards for Prisons and Jails* (1980).
 - ⁴ *Minimum Standards for Prison Establishments: A NACRO (National Association for the Care and Resettlement of Offenders) Report*, Silvia Casale, 1984.
 - ⁵ In Western Europe, the floor space considered necessary for each prisoner varies between 4 and 10 m²; in some Eastern European States it is between 2 and 4 m². Walmsley, R., *HEUNI Papers, No. 10*, European Institute for Crime Prevention and Control, affiliated with the United Nations, 1997.
 - ⁶ In Western countries, in prisons holding detainees for short sentences the maximum occupancy rate is estimated to be 75/80%, so as to allow for fluctuations in the prison population.
 - ⁷ The prison's capacity and the number of occupants given for each cell are fictitious.
 - ⁸ Calculation of the true occupancy rate rather than the rate according to the prison's official capacity.
 - ⁹ Vazirani, V.N., Chandola, S.P., *Concise Handbook of Civil Engineering*, S. Chand & Co., Ram Nagar, New Delhi, 1996, p. 970.
 - ¹⁰ Davis, J., Lambert, R., *Engineering in Emergencies: A Practical Guide for Relief Workers*, Intermediate Technology, 1995, p. 201; and UNHCR, Programme and Technical Support Section, *Water Manual for Refugee Situations*, Geneva, November 1992.
 - ¹¹ *Standard Minimum Rules for the Treatment of Prisoners*, Rule 13 (see note 2).
 - ¹² This is the price of chlorine in HTH form on the world market (2002). The retail price is probably higher because of transport and packaging costs, etc.
 - ¹³ Franceys, R., Pickford, J., Reed, R., *A Guide to the Development of On-Site Sanitation*, WHO, Geneva, 1992.
 - ¹⁴ Reed, R.A., Dean, P.T., "Recommended methods for the disposal of sanitary wastes from temporary field medical facilities", *Disasters*, Vol. 18, No. 4 (8, A20), 1994.
 - ¹⁵ Delmas G., Courvallet M., *Technicien sanitaire en situation précaire*, 2nd ed., Médecins sans Frontières, Paris, 1994.
 - ¹⁶ *Op. cit.*, note 13.
 - ¹⁷ Reed, R.A., *Sustainable Sewerage: Guidelines for Community Schemes*, Intermediate Technology Publications and WEDC, 1995.
 - ¹⁸ *Code of Practice, Septic Tanks*, Environmental Protection Authority, State of Victoria, Australia, 1996.
 - ¹⁹ *Op. cit.*, note 13.
 - ²⁰ Boesch A., Schertenleib R., *Emptying On-Site Excreta Disposal Systems: Field Tests with Mechanized Equipment in Gaborone (Botswana)*, International Reference Centre for Waste Disposal (IRCWD Report No. 03/85), Dübendorf, Switzerland, 1985.
 - ²¹ Kessler, J., Oosterbaan, R.J., "Determining hydraulic conductivity of soils", in *Drainage Principles and Applications*, Vol. III: *Survey and Investigations*, Publication 16, International Institute for Land Reclamation and Improvement (ILRI), Wageningen, Netherlands, 1974, pp. 253-295.
 - ²² Davis, J., Lambert, R., *Engineering in Emergencies: A Practical Guide for Relief Workers*, Intermediate Technology, 1995, p. 677.
 - ²³ Cairncross, S., Feachem, R., *Environmental Health Engineering in the Tropics*, 2nd ed., J. Wiley & Sons, Chichester, UK, 1996.
 - ²⁴ Lanoix, J.N., Roy, M.L., *Manuel du technicien sanitaire*, WHO, Geneva, 1976.
 - ²⁵ *Op. cit.*, note 15.
 - ²⁶ *Standard Minimum Rules for the Treatment of Prisoners*, Rule 20, para. 1 (see note 2).
 - ²⁷ *Op. cit.*, note 15.
 - ²⁸ Masse, R., *Le butane et le kérosène en chiffres*, GRET, Ministry of Cooperation, Paris, 1990.
 - ²⁹ de Lapeleire, G., Krishna Prasad, K., Verhaart, P., Visser, P., *Guide technique des fourneaux à bois*, Edisud, Aix-en-Provence, 1994.
 - ³⁰ In general, the amount calculated is increased by 10% to allow for a margin of error and possible overdosage by the operatives.

Bibliography

- CAIRNCROSS, S., FEACHEM, R., *Environmental Health Engineering in the Tropics*, 2nd ed., J. Wiley & Sons, Chichester, UK, 1996.
- Code of Practice, Septic Tanks*, Environmental Protection Authority, State of Victoria, Australia, 1996.
- DAVIS, J., LAMBERT, R., *Engineering in Emergencies: a Practical Guide for Relief Workers*, Intermediate Technology, 1995.
- DELMAS, G., COURVALLET, M., *Technicien sanitaire en situation précaire*, 2nd ed., Médecins sans Frontières, Paris, 1994.
- DROUART, E., VOUILLAMOZ, J.M., *Alimentation en eau des populations menacées*, Action contre la faim, Hermann, 1999.
- FRANCEYS, R., PICKFORD, J., REED, R., *Guide to the Development of On-Site Sanitation*, WHO, Geneva, 1992.
- JORDAN, T.D., *Handbook of Gravity-Flow Water Systems*, Intermediate Technology, 1984.
- LANOIX, J.N., ROY, M.L., *Manuel du technicien sanitaire*, WHO, Geneva, 1976.
- PERRIN, P., *Handbook on War and Public Health*, ICRC, Geneva, 1996.
- RHODAIN, F., PEREZ, C., *Précis d'entomologie médicale et vétérinaire*, Maloine, Paris, 1985.
- STEWART, B., *Improved Wood, Waste and Charcoal Burning Stoves: A Practitioner's Manual*, Intermediate Technology, 1987.
- THOMPSON, M.C., *Disease Prevention through Vector Control*, Oxfam, Oxford, 1995.
- UNHCR, *Guidelines for the Use of Disinfectants in Refugee Situations*, Geneva, 1993.
- UNHCR, *Water Manual for Refugee Situations*, Geneva, 1992.
- UNHCR/WHO, *Vector and Pest Control in Refugee Situations*, Geneva, 1997.
- USAID, *Water for the World*, Technical Notes, Washington, D.C., 1999.
- WHO, *Guidelines for Drinking-Water Quality*, 3rd ed., Geneva, 2004.
- WINBLAD, U., KILAMA, W., *Sanitation Without Water*, Macmillan, London, 1985.