

What Happens When the Pit is Full?

Developments in on-site Faecal Sludge Management (FSM)



photo by Jay Bhagwan

Seminar Report

Table of Contents

Introduction	1
Seminar Objective	1
Content Highlights	2
Opening Address and Introduction	3
1. Conference welcome and opening address	3
2. Conference welcome and background	4
Session 1: What happens when the pit is full? A trillion dollar question, and an urgent one	5
1. Sanitation for the billions. Making it work in the global context	5
2. The future of on-site sanitation. Beyond the cesspit	7
Session 2: Inside the pit	9
3. How fast do pits and septic tanks fill up? Implications for design and maintenance	9
4. What is going on inside pits and septic tanks? The science of sludge decomposition	11
5. Sludge under the microscope. The Ascaris story	13
6. Magic Muthis. Can biological additives make the problem go away?	14
Session 3: Getting what's inside outside	16
7. What you need to know about emptying pits and tanks with vacuum tankers, large and small	16
8. In Search of Innovations in Pit Emptying	18
9. Experience with pit emptying in the Eastern Cape: the Franchise Model	20
Session 4: Mechanised emptying for SMMEs	21
10. The quest for sustainable sanitation in Cambodia	21
11. The PETshop toys. Of eVacs, Nanovacs and PSAs	23
Session 5: Grasping the nettle – eThekwini's Pit Emptying Programme	25
12. Lessons from eThekwini's Pit Emptying Programme – from pilot to full scale	25
13. Sludge disposal in eThekwini. Reviewing the options	27
14. Simple sludge disposal with benefits? Deep-row entrenchment with agroforestry	29
15. First do no harm: how do we protect the workers and the public during the process?	31
Session 6: The sludge disposal issue	32
16. The critical cost consideration. Sludge transfer and transport	32
17. Human waste: for how long can we afford to throw it away?	34
18. Experience with Urban Sludge Treatment in Indonesia	35
19. Implications for local government of faecal sludge management	37
Annex A: Agenda	38
Annex B: List of participants	40
Annex C: Sources and websites for more information	43

Abbreviations

B&MGF	Bill & Melinda Gates Foundation
BEE	Black Economic Empowerment
BORDA	Bremen Overseas Research Development Association
BPD	Building Partnerships for Development
CBOs	Community Based Organisation
CLTS	Community Led Total Sanitation
COD	Chemical Oxygen Demand
CSIR	Centre for Scientific and Industrial Research
DALYS	Disability Adjusted Life Years
DEWATS	Decentralised Wastewater Treatment Systems
EAWAG	Eigenössische Anstalt für Wasserversorgung, Abwasserreinigung und Gewässerschutz (Swiss Federal Institute for Environmental Science & Technology)
EWB	Engineers Without Borders
EWS	Ethekwini Water Services
ICC	International Convention Centre
IDE	International Development Enterprises
LCD	Liquid Crystal Display
LSHTM	London School of Hygiene and Tropical Medicine
NGO	Non Governmental Organisation
O&M	Operations and Maintenance
PHAST	Participatory Hygiene and Sanitation Transformation
PID	Partners In Development
PSA	Pit Sludge Auger
SA	South Africa
SADC	Southern African Development Community
SMMEs	Small, Medium and Micro Enterprises
UD	Urine Diversion
VIDP	Ventilated Improved Double Pit latrine
UKZN	University of Kwa Zulu Natal
UN	United Nations
UN-Habitat	United Nations Human Settlements Programme
USD	United States Dollars
VIP	Ventilated Improved Pit latrine
WISA	Water Institute of Southern Africa
WRC	Water Research Commission
WWTP	Waste Water Treatment Plant
ZAR	South African Rand (Zuid-Afrikaanse Rand)

Introduction

South Africa has recently held what has been called the “Toilet Election”. Amidst a welter of recriminations, debates about 'open toilets' have reaffirmed the elemental importance of sanitation and the unbreakable link between human dignity and adequate sanitation. What comes next remains to be seen, but surely it cannot exclude a renewed focus in South Africa, and perhaps in the region, on this most basic of human rights.

Although sanitation is one of the Millennium Development Goals, many regions are performing poorly in attaining their declared sanitation targets, including Sub-Saharan Africa. Whilst much of the focus is, understandably, on the provision of new toilets, the maintenance of those toilets already built cannot be forgotten. Take South Africa as an example, where there are around 2 to 3 million 'VIP' latrines. While the government there has recognised that maintaining its commitment to sanitation as a basic human right means continuing to keep existing toilets operational (as well as providing new ones) it has left it to local government structures to work out how this should be done. Most municipalities do not as yet have policies, budgets or procedures for the maintenance of on-site sanitation. A rough estimate suggests that in the rest of SADC there are perhaps another 5 million 'urban' latrines, many of which will also need emptying within five years or less of construction.

In urban areas it is much rarer for new pits to be dug once old latrines fill (for a variety of reasons). The issue of how to manage the faecal sludge accumulating in urban latrines is therefore a crucial one. Traditionally this is an issue that has attracted relatively little attention and had little prestige. Historically it has also been an area of limited innovation.

As the challenge of faecal sludge management (FSM) grows, things are changing however. Recent years have seen a flourishing of innovation across a range of issues. This has bettered our understanding of what happens in pit latrines, how sludge accumulates and degrades and how it can best be managed. New ways of getting sludge out of pits, in a more hygienic and efficient manner, are being pioneered in many countries worldwide. The final link in the chain, the important issue of how to deal with the sludge collected, is also under the spotlight, with new or better ways of dealing with pit sludge emerging.

The city of Durban has been a focal point for much of this innovation and learning and was therefore an appropriate place to gather a range of practitioners dealing with FSM. In March 2011 approximately 140 participants gathered - from local government, NGOs, research organisations and academia – in order to discuss the latest developments and share experience across four continents. This note captures the proceedings of the two day seminar, hoping to share some of the insights discussed and make research, learning and best practice available to a wider audience.

Seminar Objective

The objective of the seminar was to enable anyone responsible for the sustainable operation of on-site sanitation systems to find out about new developments in the field, and to share their experience with counterparts from elsewhere in Southern Africa and the world.

Content Highlights

The seminar was split across six sessions and ended with two field visits (hosted by eThekweni's Water and Sanitation Department, EWS). The sessions ran as follows:

1

Session 1: What happens when the pit is full? A trillion dollar question, and an urgent one

Introduced faecal sludge management as an issue and discussed some of the latest developments in the sector – not only in removing and treating sludge from pits but discussing broader developments in sanitation approaches that will influence the shape of FSM approaches in the years to come.

2

Session 2: Inside the pit

Talked about what happens inside pits and how sludges accumulate and degrade. It also discussed the pathogenic nature of the contents and the consequences of this for managing the waste streams generated. It discussed whether current 'pit additives' on the market offer potential in addressing the problem inside the pit, reducing the need to extract and treat waste.

3

Session 3: Getting what's inside outside

Talked of innovations in pit emptying – both in the technology used to do so and also in the operational approaches followed. Showcased new experience both in South Africa and further afield that offers great potential of better ways to get waste from pits and ensure that it is dealt with appropriately.

4

Session 4: Mechanised emptying for SMMEs

Discussed existing practice and options regarding the mechanised emptying of latrines as well as more recent developments. The session also showcased recent innovation in emptying techniques, then trialling of new machines and their potential. In doing so it highlighted applied research in South Africa and elsewhere (including Cambodia).

5

Session 5: Grasping the nettle – eThekweni's Pit Emptying Programme

Addressed the lessons eThekweni's Pit Emptying Programme, one of the largest in the world, where a lot of thought, learning and experimentation has gone into developing a full scale pit emptying programme. This programme has led to a large accumulation of sludge and hence research into how to appropriately and safely dispose of pit sludges, including mechanical processing and deep-row entrenchment. An important issue discussed was how to protect manual pit emptiers and the public.

6

Session 6: The sludge disposal issue

Looked at new developments including the decentralised treatment of household sanitation wastes. Reuse is a viable option being explored, particularly in light of depleting phosphorus reserves and the potential of recycling the nutrients within the waste. Existing experience in transporting waste once excavated was showcased and the various consequences thereof debated.

Opening Address and Introduction

1. Conference welcome and opening address

Neil Macleod, Head of eThekweni Water Services (EWS)

Neil has forty years experience in the metropolis of Durban, South Africa's third largest city, where he has risen through the rank to head the water and sanitation department. In his experience, "sludge used to be something nobody talked about", but this has changed in recent years and sludge is increasingly "seen as a resource".

Durban is a large city and, with the expansion of municipal boundaries that took place in South Africa at the turn of the millennium, inherited many pit latrines, not all of which were well designed and built. Consequently it has had quite a challenge on its hands and, after a successful pit-emptying campaign across the city, has accumulated a lot of partly digested sludge. After realising that this could not be processed well by its existing waste water treatment plants, it has been stored onsite at one of them, awaiting a further solution. Disposing of sludge is a particular challenge for EWS (one which they have been experimenting with), as landfill is expensive and dealing with the contaminants in sludge a challenge. In this the national situation has also added complications, with the management of faecal sludge somewhat of a policy vacuum. Regulation of sludge quality is dealt with, but many other aspects are not well outlined. There has also been little innovation on the issue in recent years.

Durban can be considered both a "first world and third world city". A highly technical and expansive sewerage scheme co-exists with many thousands of latrines, some of them quite rudimentary. When first addressing the challenge EWS believed there were around 80 000 VIP latrines in the city, but when it came to emptying these VIPs it was found that the real number was only 35 000 (there had been some errors in previous surveys). All of these have been emptied in last 3 years thanks to an aggressive policy instituted by EWS. In line with their 'free basic services' policy, the local policy is that the municipality offers a free emptying every 5 years – more frequently than that and the householder has to pay.

A specific challenge to EWS has been the amount of solid waste in the pits. There are currently only limited solid waste management services provided in many of the informal settlements and rubbish is dumped into pits instead. As this does not degrade readily, there is a lot of rubbish in the sludge emptied, which poses problems for the emptying and processing of the sludge. Also the sludge cannot be put straight into treatment works – only a limited amount of pit sludge can be disposed of in wastewater treatment plants due to its high concentration. In terms of solids and nutrient loading, the contents of one VIP latrine equates to one megalitre of normal strength sewage.

Durban is trying several new technologies to assist with the manual emptying of pits, in partnership with other organisations. It is also looking at the decentralised treatment of waste (via the DEWATS system) as well as the potential reuse and recycling of sludge as agricultural compost. Internationally there are various developments on the horizon – for instance it seems that the co-digestion of waste and other such innovations may both lead to benefits in waste processing and economic savings.

Research is clearly important and EWS has demonstrated its commitment to this by partnering with various organisations including the University of Kwa Zulu Natal and the WRC. Indeed the city fully supports and encourages applied research and looks to implement the findings in its own work – truly applied research. It has experienced both failure and success – this is all part of being innovative and forward looking. Historically it may be true that FSM has been considered a 'low prestige' topic but it is an important one – and given the forecast 'fertiliser crunch' on the way issues such as how to better process, recycle and reuse waste are only going to grow in importance.

2. Conference welcome and background

Jay Bhagwan, Water Research Commission

Whilst the 1980s were largely seen as 'the water decade', there were developments on the sanitation side too, notably the development of the VIP latrines, dry sanitation and advances in anaerobic digestion approaches. However, arguably, developments over that period were overly influenced by a civil engineering / project management approach and not enough attention was paid to the cultural significance surrounding sanitation and the need for behaviour change. Issues like ergonomic design, user acceptance and behaviour change did not get the attention we now realise they deserve. This is starting to change.

In South Africa, following the advent of democracy in 1994 and the push to deliver services to all, there has been rapid building of VIPs. This has particularly been true over the last ten years – and now the number of VIPs nationwide stands at around 3 million. While this is certainly laudable, the need to empty them has not been given full consideration and only now are municipalities across the country waking up to the fact that latrines eventually do fill up and that something needs to be done, particularly in urban areas where relocation is generally not an option.

This is an issue as there are undeniably large risks in handling VIP contents – pathogens remain active for long periods (and recent studies have even shown that they can go airborne). Thus there are significant health and safety challenges to be overcome (both in South Africa and elsewhere, people actually climb into the pit to earn money by emptying latrines). Coastal regions are in particular prone to endemic sanitation-related diseases.

User behaviour is another challenge – with solid waste management in informal settlements often found wanting, disposal of nappies, plastics and other solid waste into pits is very common. Newspapers are often used for anal cleansing. The large quantities of solid waste found in pits thus challenge mechanical emptying approaches.

On the research front, admittedly little has been done over the last 40 years. As such there is a certain lack of evidence based on the actual usage of pits – too much of the research that does exist is based on theory rather than practice. Recognising this, WRC took a strategic decision circa 2006/7 to better understand the nature of faecal sludge, in particular the nature of its decomposition, the efficacy of using additives, pathogen survival rates etcetera.

Accordingly, there are four prongs to WRC's commissioned work:

1. What happens in pits? – the nature of sludge accumulation, efficacy of pit additives, the 'science' happening within a pit.
2. Desludging techniques.
3. The appropriate management of sludges (and exploration of whether any benefits can be gleaned from sludge).

4. Exploration of better construction techniques (including making structures lighter, using modular systems, ways to make latrines cheaper etcetera).

As a consequence, there are various outputs and reports dealing with the four prongs above, all of which can be found on the WRC website (www.wrc.org.za).

Session 1: What happens when the pit is full? A trillion dollar question, and an urgent one

1. Sanitation for the billions. Making it work in the global context

Steven Sugden: London School of Hygiene and Tropical Medicine

Sanitation progress has lagged behind that of water provision even though they have long been 'joined' together in theory. Some argue that this is an historical artefact and that in 2011 there are good reasons for reconsidering this link, particularly as the way communities and households make decisions about water and sanitation (as well as hygiene) are quite different. Although sanitation seems particularly prone to fads, hopefully new 'lasting' insights are coming out in recent years. Some of these stem from recent work on sanitation marketing, which highlights why users do and do not 'adopt' improved sanitation. This work also highlights the existence and potential of sanitation businesses, whose incentive structures hopefully force us to think more holistically and sustainably about long-term sanitation provision at scale.

For at least a couple of decades now, sanitation has been promoted as part of a 'holy trinity' that tightly binds sanitation together with water provision and hygiene promotion. Why is it that these three, quite different disciplines, are bound together?

Part of the explanation is found in the 'Big Stink' of Victorian London (during the mid 1800s) and 'miasma theory' (which held that if you can smell bad odours then these are contributing to your ill health). Now we know that miasma theory was erroneous and that 'waterborne' diseases were to blame, but at the time British Parliamentarians were afraid that poor sanitary conditions of the general populace were affecting all members of society and that legislation and a massive drive for better sanitation were the only way to protect their rapidly growing cities and 'new' industries. At the time there was some debate between the relative merits of 'wet' and 'dry' sanitation but, in the end, the legislators felt they both wanted and needed sewers to solve their immediate challenges. The only organisations then with the technical and financial capacity to provide these were the water companies; arguably the century-long link between water companies and sanitation began there. Reinforcing this link was the 'water decade' of the 1980s that brought deliberate attempts to hitch sanitation to water (in order to raise its profile).

Several decades on, some observers are asking if this link has actually worked. The evidence seems at best debatable, if not downright challenging. Indeed, when one returns to first principles, some argue that decision-making involved in the three disciplines (water / sanitation / hygiene) is in fact quite different. Decisions around water are typically communal decisions, whilst sanitation is typically considered a household decision. As for handwashing, arguably this is a very personal and individual decision.

If this is true, perhaps sanitation has more in common with solid waste management than it does with the provision of water?

A specific concern is that sanitation seems particularly prone to fads. In recent years these have included trends such as technology transfer, sanimarts, PHAST (Participatory Hygiene and Sanitation Transformation), eco-san, sanitation marketing and CLTS (Community Led Total Sanitation). One of the more recent among these is sanitation marketing, which has hopefully contributed to some new and lasting insights.

Sanitation marketing puts particular emphasis on why households do and do not 'adopt' improved sanitation. It has contributed to insights on why users actually want sanitation. This often has less to do with (real or imagined) health benefits than it does with dignity and convenience, peace and quiet. In particular, sanitation marketing work in Tanzanian and Vietnam has helped us understand what actually triggers household decisions around sanitation (including the decision to invest).

This work has also highlighted the existence and potential of sanitation businesses, whose incentives hopefully force us to think more holistically and sustainably about long-term sanitation provision and what this means at scale. For instance, we now better understand why it is that many households express a strong preference for pour-flush toilets and for showers. Partly this is because with pour-flush toilets you cannot 'see' your own faeces (permitting the user to 'flush and forget'). Partly this is because these facilities are made of porcelain and viewed as 'modern'. It is also easy to keep them clean.

It gives particular prominence to the important issues of cleanliness and aspiration. These are too often underplayed by existing sanitation programmes. Frequently well-meaning governments and NGOs are caught in the trap of promoting the 'technology of the poor', which accordingly attracts few lasting devotees. Sanitation marketing has found ways to overcome this cul-de-sac by promoting 'solutions' that actually speak to the needs and aspirations of both poor and middle-class householders.

A further insight has been the appeal of 'permanent solutions'. The example of a rich lady in Blantyre, Malawi is pertinent. She invests little in her latrine as space on her plot allows it to be moved every time it is full. This lady has little incentive to invest serious money in a 'temporary solution'. Arguably though, should Blantyre be able to develop a viable and trusted emptying service, this lady would be motivated to invest in a higher quality latrine (i.e. a 'permanent solution'). While this remains solely theory for now, advances in sanitation marketing are pushing NGOs and governments in the direction of viable sanitation businesses, which many hope will deliver these types of breakthroughs.

For many in the sanitation sector, such 'business-minded' approaches offer significant potential. They could solve the long-term viability of sanitation programmes by ensuring there are incentive structures that are sustainable for long-term sanitation provision at scale. Sanitation businesses are assumed to want to increase their business and through this push the market to grow over time (independent, hopefully, of any limits to subsidy provision). Organic sanitation businesses should not be 'donor-dependent'; we hope therefore that they will still be operational 15 years hence (in contrast to too many sanitation programmes, that end as soon as government or donor money stops flowing).

Contact: Steven Sugden, E: ssugden@waterforpeople.org

Where to go for further information (web): The Great Stink of London finally persuaded investment in competent sanitation authorities in London. Read more at www.martinfrost.ws/htmlfiles/great_stink.html

WELL FACTSHEET : The Process for Sanitation Marketing at [http://www.lboro.ac.uk/well/resources/fact-sheets/fact-sheets-htm/Sanitation marketing.htm](http://www.lboro.ac.uk/well/resources/fact-sheets/fact-sheets-htm/Sanitation%20marketing.htm).

2. The future of on-site sanitation. Beyond the cesspit

Professor Chris Buckley: Pollution Research Group, UKZN

A recent challenge by the Bill & Melinda Gates Foundation has asked research institutions to “reinvent the toilet”. Their 'stretch' target, while ambitious, forces us to go back to first principles to consider what excreta is made up of and how and why it decomposes over time. For instance, the energy content from burning faeces is sufficient to evaporate all the water content whilst also provide enough surplus to charge a cellphone and operate an LCD bulb. As it stands, Durban's experience with urine diversion toilets offers a stark contrast to the performance of VIP latrines within the municipality. A particular challenge with Durban's VIP is the accumulation of non-biodegradable solid waste – this leads to the pit filling faster and the sludge being difficult to empty and treat. Could drastic innovations allow us to extend the life of existing pits thus 'buying time' whilst we reinvent the toilet?

The Bill & Melinda Gates Foundation recently invited 21 institutions from around the world to participate in a challenge titled “Reinvent the Toilet”. The brief was to “reinvent the toilet such that sewers are not required”. The B&MGF committed to funding the up-front concept, demonstration and tooling of any 'reinvented toilets' in order to incentivise innovation and allow suggestions that could, in time, generate sufficient economies of scale to cover the full economic costs of the 'new' system.

In some respects this challenge supports those who view waterborne sanitation as an historical artefact – a 'solution' that may have made sense in a particular time and place – but whose continued application on a global scale is, at best, unproductive. In this view, some consider flush toilets and waterborne sewers to be a 'dead-end' technology that could well be superseded by a more appropriate and environmentally-sensitive technology.

The University of Kwa-Zulu Natal (UKZN) was one of the chosen institutions and began its approach by first considering what human excreta consists of. On average people excrete 1.5 litres per person per day of urine and 0.4 kg per person per day of 'faecal paste'. This latter is only around 0.1 kg of dry mass and contains sufficient energy, when burnt appropriately, to evaporate all the liquid in both the faecal paste and the urine. This suggests that one possible solution could be to burn the waste, evaporating the water and even leaving surplus energy for other uses (such as powering LCD lights, powering cellphones, charging fuel cells, etcetera). Apart from its chemical components, human waste also contains viruses, bacteria etc. These pathogens are harmful to human health. In a context such as Durban, where there are tens of thousands of existing pit latrines, there is also a need to protect people that empty latrines from these pathogens as well as those who use them. Indeed research by UKZN has shown that in some poor communities in eThekweni that up to 60% of people living within the vicinity of pit latrines have either Giardia or Cryptosporidium infections. Up to 80% may have Ascaris.

Urine diversion (UD) toilets, some 70 000 of which have been installed to date in more rural areas of eThekweni municipality, offer an alternative to the traditional pit latrine (as well as the Ventilated Improved Pit Latrine, or VIP). By separating the solid and liquid waste stream these can make both easier and safer to handle.

UD toilets also allow each waste stream to be viewed differently, particularly from a perspective of 'reuse' – the majority of 'useful' nutrients are found in urine rather than faeces, particularly phosphorus and nitrogen.

Prevalence of helminth and protozoan parasitic infections

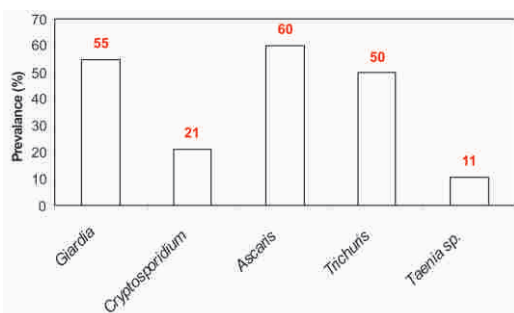

D Hawksworth, C Archer, A Hanssen, L Tronberg, R Lutchminarayan, S Knight, M Smith and N Rodda. WISA conference, Sun City 2008

Figure 1 : Prevalence of common parasitic infections associated with pit sludge

These may even have a commercial value if a scaleable and economic way can be found to recover them from urine. eThekweni Water and Sanitation, together with EAWAG and UKZN, is looking at how to incentivise people to use UD toilets and how to recover any value from human waste streams. A further question being posed is “can we improve VIP toilets”. A specific challenge relates to solid waste removal, which is often lacking in poor communities that rely on VIP toilets (as well as traditional latrines). A consequence is that much rubbish gets disposed of into latrines. In eThekweni it has been found that after ten years pits contain about 25% of non-faecal material.

As the pit ages the percentage of rubbish in it increases and research undertaken at UKZN university by Kirsten Wood estimates that the useful life of pit latrines could be extended by 75% if we could stop rubbish being dumped into the latrines. Although pit additives (said to speed up the waste degradation process) generally have a bad name, in theory there could be potential to extend the 'life' of the pit by using enzymes that can degrade fibre and the walls of cells. If these could act at the bottom of the pit, where hard to degrade biological matter builds up (and we could keep rubbish out of pits), then potentially the life of pit latrines could be extended from five up to perhaps fifty years. This is something that the London School of Hygiene and Tropical Medicine is also exploring (supported by the Bill & Melinda Gates Foundation).

Protozoan parasitic infections

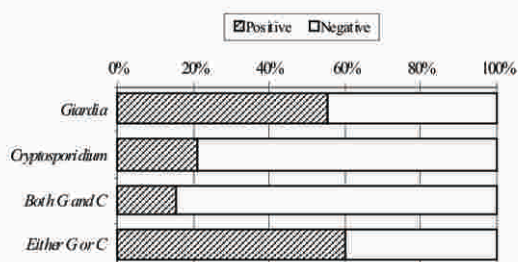

D Hawksworth, C Archer, A Hanssen, L Tronberg, R Lutchminarayan, S Knight, M Smith and N Rodda. WISA Conference, Sun City 2008

Figure 2 : Prevalence of Giardia and Cryptosporidium infections

By increasing the life of existing pits, by whichever means, we 'buy time' for other innovations to take place and for any 'reinvented toilet' to be developed. Moreover, it is not only to developing countries that we should look for such innovations – arguably developed countries, with their strong research and development capability, could play a leading role in pushing innovation in this sphere.

Urine Diversion Toilet

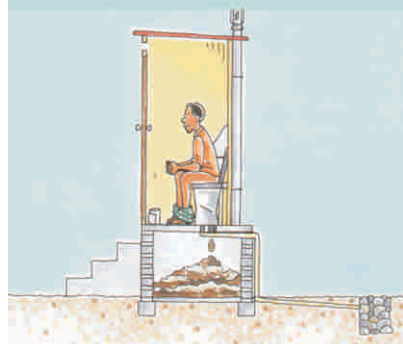

Figure 3 : Common UD toilet used in Durban

Contact: Chris Buckley, E: buckley@ukzn.ac.za

Where to go for further information (web): Urine diversion ventilated improved double pit (UD/VIDP) toilets: Physical and health-related characteristics of UD/VIDP vault contents
<http://www.wrc.org.za/Pages/DisplayItem.aspx?ItemID=7926>

Session 2: Inside the pit

3. How fast do pits and septic tanks fill up? Implications for design and maintenance

Kitty Foxon, Chris Buckley, Chris Brouckaert & Babatunde Bakare, Pollution Research Group, UKZN; Dave Still & Frances Salisbury: Partners in Development

Any programme to manage faecal sludge can benefit from knowing how fast pits fill up. This depends on a host of factors, such as number of users, nature of the waste entering the pit, soil characteristics, pit design and decomposition processes. Nevertheless research can inform design and maintenance by giving more insight into this area. UKZN, partnering with PID, EWS and others, have looked at this issue in Kwa-Zulu Natal. Their findings tend to confirm wider international experience, where a sludge accumulation of 40 litres per person per year is taken as a typical filling rate for design purposes. This work suggests a conservative planning estimate of 60 litres per person per year, something that EWS will take forward in its current and future maintenance programmes.

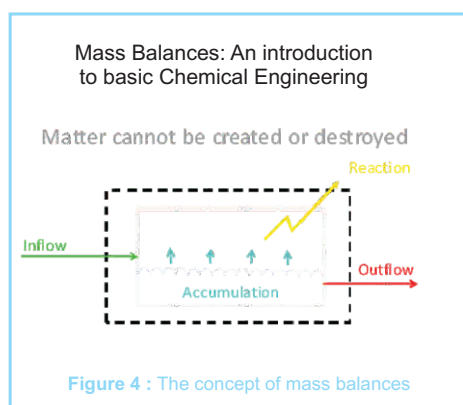

A basic principle of chemical engineering is that mass cannot be created or destroyed. This guiding principle permits us to understand what happens in both pit latrines and septic tanks and how fast they take to fill.

Inflow – Reaction - Outflow = Accumulation

Inflow consists of urine and faeces, anal cleansing material, water, detergents, rubbish, disinfectants, etc. Reactions can be either anaerobic (in the absence of oxygen) or aerobic (in the presence of oxygen). Outflow consists of drainage from the pit (or septic tank) along with any solids dissolved in this outflow. Accumulation is therefore due to a build up of 'bugs', salts, non-biodegradable matter (including rubbish), plus some undegraded, but potentially biodegradable material. The same principles apply to septic tanks, save with these there is usually more water both entering and exiting (and much less rubbish).

Study area	Filling rate [l/ person.year]	Reference
Soshanguve	24	Norris (2000)
Philippines	40	World Health Organisation (1958)
Besters Camp (eT Muncip.)	<20 to >80 (70)	City of Durban
Mbazwana (northern KZN)	10 to 78 (25)	Partners in Development
Limpopo	43	Tsonang NGO
Mafunze	11 to 146 (48)	Partners in Development
Ezimangweni (eT Muncip.)	27±10	UKZN
Savana Park (eT Muncip.)	31±21	UKZN
Folweni (eT Muncip.)	44±46	UKZN

Figure 5 : Pit filling rates recorded by various sources

Sludge accumulation rate vs. no. of users

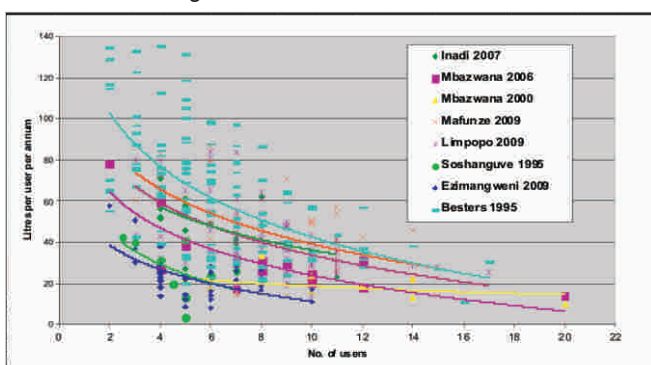

Figure 6 : Sludge accumulation rate appears to fall as number of users rise, but investigation shows that this owes more to the way usage is perceived than any physical reason

For a typical pit latrine, the average addition per person per year consists of faeces ($0.3 \text{ l/d} \times 365 \text{ d/year} = 110 \text{ l/ca.year}$) and urine ($1.2 \text{ l/d} \times 365 \text{ d/year} = 440 \text{ l/ca.year}$) which leads to a total volume of $550 \text{ l/person.year}$. The rate at which the latrine then fills depends partly on the rate of addition and partly on the rate of degradation. Estimating this in the field is fraught with difficulty, and studies worldwide have come up with a range of filling rates (see Figure 5).

An important point to remember is that in pit latrines the sludge goes through a biological process that stabilises it, with sludge from the base being mostly

stabilised. As such it does not need to enter a wastewater treatment works as most of the volatile organics have already been removed.

During this process most pathogens die off, however helminths are particularly durable and can survive, particularly *Ascaris*. Findings have shown that long residence in pits (and septic tanks) does not deactivate helminths; these pose a hazard to human health for a considerable period. For pit latrines, given the wide range of numbers observed in field, a filling rate of 40 l/person.year seems a reasonable mean. As such, 60 l/person.year seems a reasonable figure for the planning of maintenance programmes.

The accumulation rate appears to decrease with number of users. However, the accumulation rate does decrease as the pit fills (i.e. the rate of filling slows with time).

But it can be shown that this phenomenon is simply due to the difficulty in estimating average usage.

Septic tanks also show a wide range of numbers observed in the field. Given this, 60 l/person.year seems a reasonable mean, with 80 l/person.year a reasonable figure for design. In general septic tanks generate greater volumes than pit latrines, but the solids content is much less (around 10%). There too, the accumulation rate decreases with time.

One can design pits around engineering criteria (where needed volume, $V = r \times n \times t$, where r = accumulation rate, n = number of people using the toilet and t = frequency of emptying). The UKZN recommend though that one should actually design around the emptying programme. Large pits require professional emptying whereas shallow pits could be emptied by householders. Whatever the decision though, there is 100% guaranteed helminth infection of the emptiers and this requires certain health and safety considerations.

UKZN therefore suggest that if there is no local capacity for an organised emptying programme, one should build shallow pits that can be emptied by householder. If there is high capacity for an organised emptying programme, one should in any case consider building shallow pits that can be quickly emptied with an associated reduced risk of helminth infection.

Contact: Kitty Foxon, E: foxonk@ukzn.ac.za or Chris Buckley, E: buckley@ukzn.ac.za

Where to go for further information (web): Buckley CA, Foxon KM, Brouckaert CJ, Rodda N, Nwaneri C, Balboni E, Couderc A and Magagna D (2008) Scientific support for the design and operation of ventilated improved pit latrines (VIPs) and the efficacy of pit latrine additives. Water Research Commission Report No. TT 357/08, ISBN 978-1-77005-718-0 www.wrc.org.za

4. What is going on inside pits and septic tanks? The science of sludge decomposition

Kitty Foxon, Chris Buckley, Chris Brouckaert, Kirsten Wood, Babatunde Bakare: Pollution Research Group, UKZN

Sludge decomposes in one of two ways; aerobic or anaerobic. Aerobic decomposition is faster but does not reduce the volume of sludge as much as anaerobic decomposition does. Inside a typical pit there is a zone of aerobic activity near the surface, with the rest of the pit being subject to anaerobic decomposition. A similar division applies to septic tanks. Many factors, including the design of the pit or tank, affect the balance between the two. This suggests that we can influence how sludge decomposes and therefore influence the volume of sludge to be removed, as well as its physical, biological and chemical composition. This has important consequences for pit design and sludge transport and treatment.

Typically 30% of the dry mass of faeces is made up of bacteria and 80% can be considered biodegradable. 70-80% of wet sludge is made up of water. Over time in the pit biodegradable organics generally degrade, dissolved components leach out, whilst sand and rubbish remains unchanged. Importantly, the micro-organisms that do the work of degradation are already present in faeces, which counters suggestions that artificial additives are needed to enhance the process.

The sludge decomposes in one of two ways; aerobic or anaerobic. Inside a typical pit there is a fairly small zone of aerobic activity near the surface while the rest is anaerobic. When bugs die inside a pit their insides become food for other bugs, whilst the cell walls are harder to break down – these become non-degradable organics. Anaerobic digestion produces fewer bugs as lots of the organic components are turned to methane.

The diagram below reveals that around 26% of the contents undergoing aerobic digestion do not degrade, versus 20% for anaerobic digestion. Thus aerobic digestion, while quicker, leaves more solids and therefore accumulation is greater. This explains the field observation that 'wet' pits fill more slowly, as they are more anaerobic. A similar situation applies to septic tanks. Many factors, including the design of the pit or tank, affect the balance between the two.

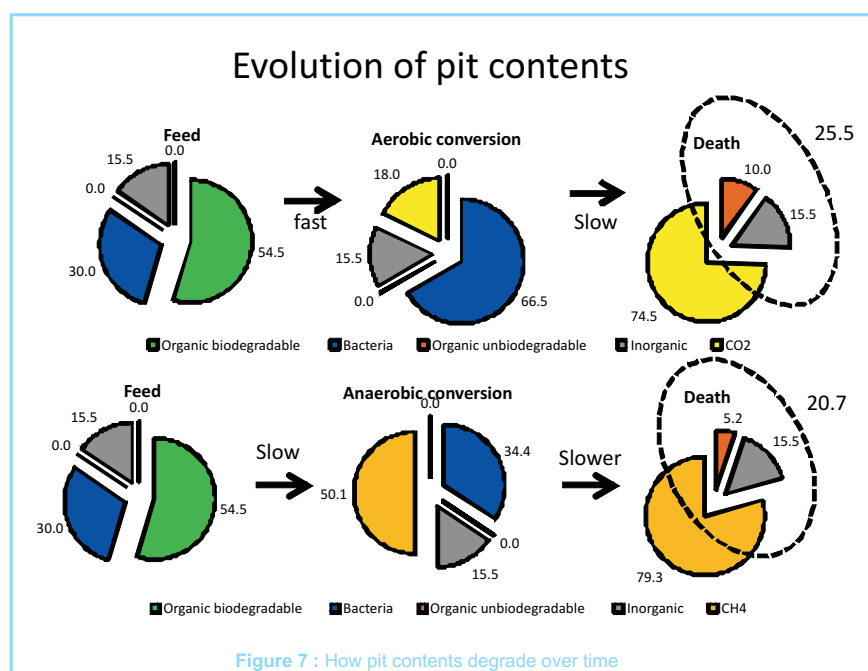

Aerobic digestion

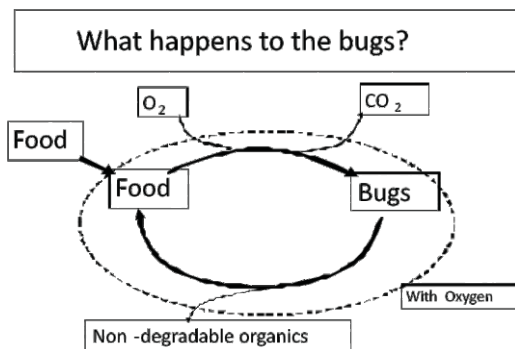

Figure 8: Patterns of aerobic and anaerobic digestion

Unaerobic digestion

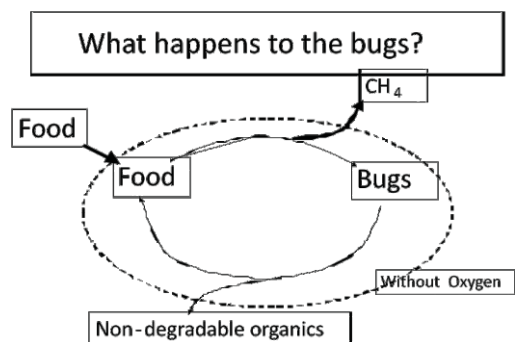

Figure 8: Patterns of aerobic and anaerobic digestion

Researchers at UKZN have come up with a mathematical model of pit degradation:

This incorporates experimental findings that suggest that below a depth of 0.7m material becomes fully stabilised (i.e. there is no chemical oxygen demand, or COD).

Volume of contents in pit

$$V(T, \bar{T}) = R_u \cdot T \int_{T_0}^T f_u(t) \cdot \phi(t) dt = R_u \cdot \left[\left(1 + k \cdot \frac{V_{bo}}{V_{uo}} \right) (T - T_0) + \frac{\left((1 - k) \frac{V_{bo}}{V_{uo}} \right)}{r} \left[e^{-rT_0} - e^{-rT} \right] \right]$$

Biodegradability of pit contents of a certain age

$$\beta(\theta) = \frac{v_b(\theta)}{v(\theta)} = \frac{V_{bo} e^{-r\theta}}{V_{uo} + kV_{bo} + (1 - k)V_{bo} e^{-r\theta}} = \frac{\frac{V_{bo}}{V_{uo}} e^{-r\theta}}{1 + k \frac{V_{bo}}{V_{uo}} + (1 - k) \frac{V_{bo}}{V_{uo}} e^{-r\theta}}$$

Figure 9 : A model for pit degradation

The presence of rubbish in a pit (common in Kwa Zulu Natal) artificially inflates the material in a pit and alters this equation (i.e. COD persists at deeper levels). Furthermore, the presence of rubbish significantly shortens the life of a pit.

The model suggests that if a pit (of typical area for South Africa) is 3 metres deep we can expect to have to empty it (under typical conditions) every 11 years. If there were no rubbish present, then this would extend to 20 years.

An important factor is, of course, temperature, and temperatures below 15 degrees Celsius tend to stop reactions within the pit; consequently one needs to design pits differently in a cold area (such as Underberg) than in a warm humid climate such as Durban.

Both the design and 'management' of pits can influence how sludge decomposes and influence the volume of sludge to be removed, as well as its physical, biological and chemical composition. This has important knock-on consequences for pit design and sludge transport and treatment.

Contact: Kitty Foxon, E: foxonk@ukzn.ac.za or Chris Buckley, E: buckley@ukzn.ac.za

Where to go for further information (web):

Buckley CA, Foxon KM, Brouckaert CJ, Rodda N, Nwaneri C, Balboni E, Couderc A and Magagna D (2008) Scientific support for the design and operation of ventilated improved pit latrines (VIPS) and the efficacy of pit latrine additives.

Water Research Commission Report No. TT 357/08, ISBN 978-1-77005-718-0
Still DA, Salisbury RH, Foxon KM, Buckley CA and Bhagwan JN (2010) The challenges of dealing with full VIP latrines. Proceedings WISA Biennial Conference & Exhibition, Durban ICC, South Africa, 18-22 April 2010

5. Sludge under the microscope. The Ascaris story

Colleen Archer: Biological Science, UKZN

Pit latrines contain four principle groups of pathogens. These are viruses, bacteria, protozoans and helminths. Helminths are parasitic worms that infect the host and live off them. Ascaris, one of several commonly found in pit latrine sludge, can have devastating consequences for human health, particularly in children. Ascaris is also important for pit emptying as its eggs are very hardy and can survive for long periods in the soil and in pit sludge. They are an important biological marker, for, if Ascaris eggs are dead one can safely assume that the other pathogens in human waste have also been rendered inactive. UKZN have developed a new method of testing for Ascaris eggs, which can be difficult to recover from sludge/soil mixtures and need an experienced microscopist to accurately count and categorize them according to whether they are viable or not. Their work has shown that Ascaris eggs can, in Durban, survive for much longer than was previously thought. Large numbers have been found in 15 year old sludge that has spent 2 years buried outside the original pit. These findings have important consequences for toilet design, pit emptying techniques, sludge treatment methods and deworming programmes. Ascaris is endemic in South Africa's coastal zones, but it is less of a problem at high altitudes (>1800 m).

One billion people worldwide are infected with Ascaris, a parasitic worm whose eggs are commonly found in pit sludge. It can lead to extreme discomfort, malnutrition and disease and is particularly devastating for children.

Ascaris is also extremely hardy and outlives other parasites found in human waste – as such it is used as a biological marker to see whether waste can be safely handled and / or reused. A challenge to doing so is that identifying and classifying Ascaris eggs as viable or dead is not easy and, until recently, no standard method for doing so existed. Since 2007 WRC and the UKZN have collaborated to develop a standardised method for this process, which has shed new light on the danger which Ascaris eggs in particular and pit sludge more generally pose to human health.

Life cycle of *Ascaris lumbricoides*

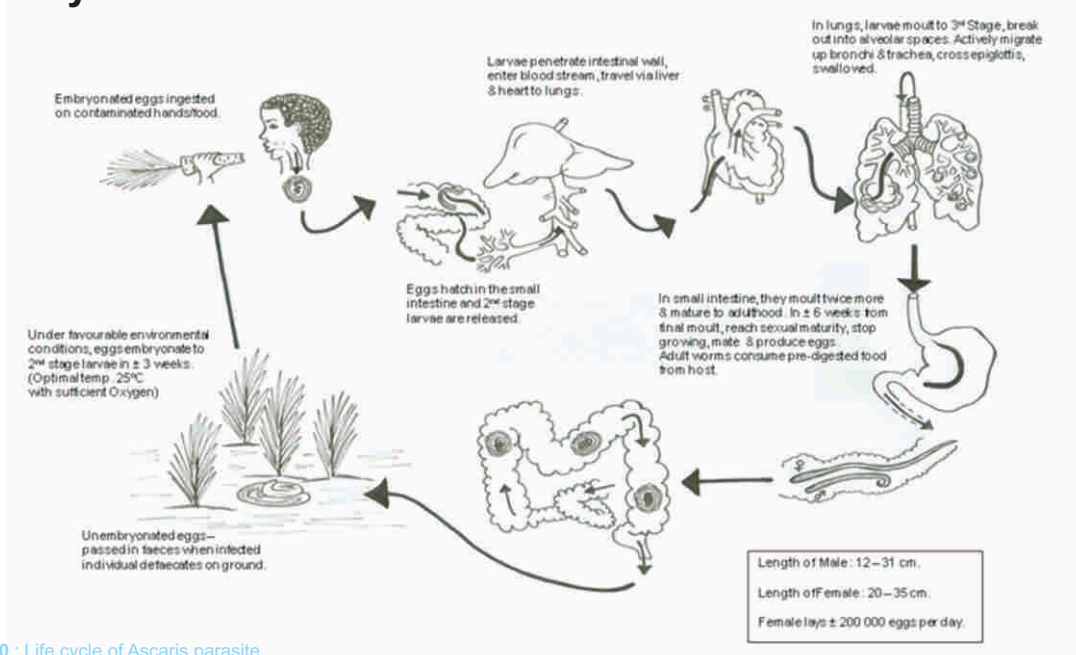

Figure 10 : Life cycle of *Ascaris* parasite



Figure11: Ascaris worms ejected from their human host

The worms, that develop in the small intestine, can reach 35 cm in length. Mature females can lay up to 200 000 eggs in a day. These eggs harden in the gut and are extremely hardy outside their human host. People are usually infected via ingestion linked to dirty hands and food contamination, but you could also inhale eggs borne on the wind (much more rarely). Hyper infection can lead to boluses, gangrene of the intestines and other severe effects.

Those that empty pits are particularly at risk from infection and elevated numbers of eggs were found on the masks used by trained and professional pit emptiers employed by the city of Durban (prompting them to be given additional training, more secure masks, as well as regular health checks and deworming tablets). Deworming programmes are effective at reducing the particular risk associated with Ascaris, but do not deal with all pathogens associated with pit sludge (Tinia being one exception amongst many).

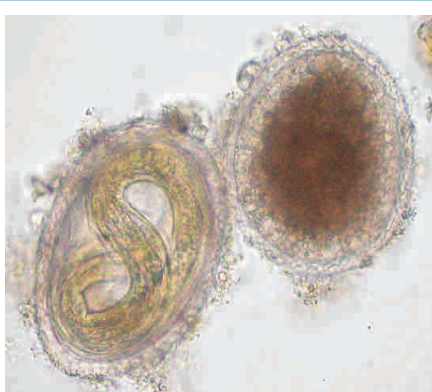

Figure 12 : Ascaris eggs under the microscope

As for the reuse of sludge – this should be safe when deep burial methods are employed and trees planted – but reuse on ground crops should generally be considered unsafe.

UKZN's work has shown that Ascaris eggs can, in Durban, survive for much longer than was previously thought (for instance, in studies by Feacham). Large numbers of potentially viable eggs are found in freshly excavated pit sludge and current research shows that these eggs can live for up to three years outside the pit. These findings have important consequences for toilet design, pit emptying techniques, sludge treatment methods and deworming programmes. Ascaris is endemic in South Africa's coastal zones, but it is less of a problem at high altitudes (>1800 m). There helminths such as hookworm and bilharzia are more common.

Contact: Colleen Archer, **E:** archerc@ukzn.ac.za

Where to go for further information (web): See www.wrc.org.za / Report: TT 322/08

Standard methods for the recovery and enumeration of Helminth Ova in wastewater, sludge, compost and urine-diversion waste in SA. <http://www.wrc.org.za/Pages/DisplayItem.aspx?ItemID=8871>

Research into UD/VIDP (urine diversion ventilated improved double pit) toilets: Prevalence and die-off of Ascaris Ova in urine diversion waste, <http://www.wrc.org.za/Pages/DisplayItem.aspx?ItemID=3627>

6. Magic Muthis. Can biological additives make the problem go away?

David Still: PID with Dr Kitty Foxon: UKZN

In South Africa there are various outfits that sell biological pit additives. The vendors claim that adding these to the pit reduces the contents and, by thus reducing the filling up rate, extends the 'life of the pit'. While theoretical evidence for their efficacy is at best scarce, vendors claim that experience in the field has proven their worth. To test this claim more scientifically, PID (in conjunction with UKZN and others), conducted two series of tests on around fifteen of the most common products on the market. They found that there was no evidence these additives have any effect. Indeed they were often outperformed by controls. Even were the products (which have largely been developed to deal with animal manure and not human waste) effective, cost considerations would render them an inappropriate investment. Poor householders, with little cash to spare, should be warned accordingly. Interestingly, one by-product of the testing is the suggestion that adding water to pits can actually slow the rate that pits fill.

Faecal sludges contain a wide range of naturally occurring bacteria which feed on the sludges, and are usually host to a large population of other small organisms, which also feed on the sludge. Some bacteria depend on oxygen for survival – these are called aerobes. Other bacteria operate below the surface and do not need oxygen – these are called anaerobes.

Simplistically put, aerobic digestion (which is relatively fast) can reduce sludge mass by approximately 30% (i.e. 70% will remain). Anaerobic digestion (which is relatively slow) can reduce sludge mass by approx 70% (i.e. 30% will remain). No amount of biological manipulation will make the pit contents disappear altogether. Not all matter can be transformed into gas and liquid. Unless a pit is sterile, some digestion is always taking place, both aerobic and anaerobic – mainly anaerobic lower down in the pit.

The case for bio-additives rests on the assumption that nature is not fully efficient and can usefully be assisted, by adding the “right” kinds of bacteria. On this basis there are in South Africa various organisations that sell biological pit additives. The vendors claim that adding these to the pit reduces the contents and, by thus reducing the filling up rate, extends the 'life of the pit'.

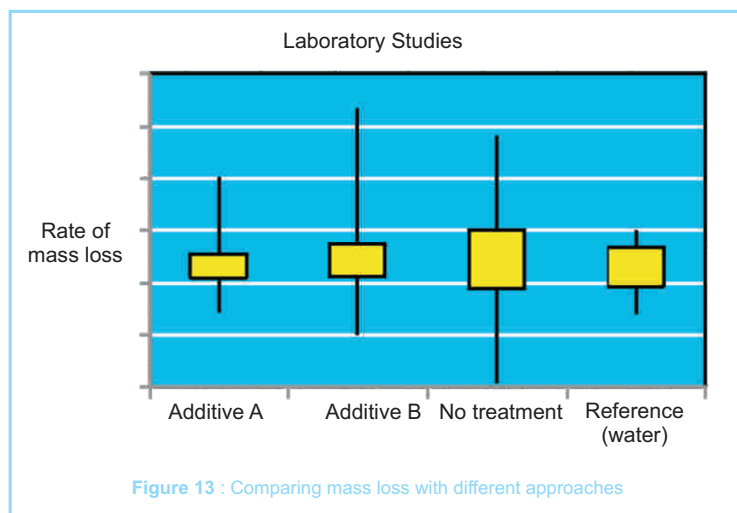

While theoretical evidence for their efficacy is at best scarce, vendors claim that experience in the field has proven their worth. To test this claim more scientifically, PID (in conjunction with UKZN and others), conducted two series of tests on around fifteen of the products on the market.

In the laboratory, no evidence could be found that any of 17 different additives tested made any difference (2006/2007). Lab work was repeated with 4 more additives in 2009/2010 – with the same result.

Six additives were also tested in the field. Care was taken with experimental method e.g. use of controls, measurement of height of pit contents. Again, no statistical improvement of additives over controls could be found. Indeed, in the two types of testing, additives were often outperformed by controls.

In asking householders it was shown that adding controls (water) generated the perception of reduced smell (a positive often claimed by vendors). Meanwhile, a typical additive treatment costs R20 per month (this can be much more). Over five years this will come to R1 200, R1 500 including interest. At best this additive will only slow the rate of filling, not stop filling. Yet for R1 500 (around \$200 USD) you can empty a pit completely and dispose of the contents using manual or mechanical methods, therefore there is no financial basis for making such an investment.

So, even were the products (which have largely been developed to deal with manure and not human waste) effective, cost considerations would render them an inappropriate investment. Poor householders, with little cash to spare, should be warned accordingly.

Contact: Kitty Foxon, E: foxonk@ukzn.ac.za or Dave Still, E: dave@pid.co.za

Where to go for further information (web): Bakare BF, Nwaneri CF, Foxon KM, Brouckaert CJ, Still D and Buckley CA (2010) Pit latrine additives: laboratory and field trials. Proceedings WISA Biennial Conference & Exhibition, Durban ICC, South Africa, 18-22 April 2010. Foxon KM, Mkhize S, Reddy M, Brouckaert CJ and Buckley CA (2009) Laboratory protocols for testing the efficacy of commercial pit latrine additives. Water SA 35(2) pp.228-235

Session 3: Getting what's inside out

7. What you need to know about emptying pits and tanks with vacuum tankers, large and small

Manus Coffey: Vacuum Pumping Specialist

Although pit sludge has existed for thousands of years, science has largely bypassed it. For instance, there are very few studies that explore sludge's mechanical properties (few too looking at its biological and chemical properties). Mechanical properties, including density, viscosity and others, are of particular importance to any emptying of sludge by vacuum tankers. Vacuum tankers (the predominant means by which septic tanks are emptied) have varying success rates in emptying pits as pit sludge differs significantly from septic tank waste. Manus Coffey, working with UN-Habitat and others, has been at the forefront of work to improve the ability of vacuum tankers to both access and empty pits. Technical innovation and 'learning by doing' has generated a wealth of information, which the University of Cambridge and others are now seeking to build on. One innovation is the categorising of sludge by its mechanical properties. Another is the development of an 'artificial sludge' which allows controlled lab tests to be done. Another is the potential of fluidising sludge to improve its 'suckability'. A particular challenge to sucking pit latrine sludge is the common presence of solid waste – a particular challenge in eThekweni. Sadly 'easy' solutions to this remain elusive.

When it comes to emptying latrines, the mechanical properties of sludge are as important as its biological and chemical composition. This is particularly so for any mechanical emptying. Yet there are very few studies that have explored sludge's mechanical properties.

Vacuum tankers have been designed to empty septic tanks and can struggle with pit latrines as the waste in them is quite different. Within any given pit, the properties vary according to depth. At the top of pits there can be a lot of water, the sludge within them getting progressively denser near the bottom. The 'suckability' of waste is determined by five characteristics: the density, viscosity and thixotropy (the tendency to a material to act like a gel) of the sludge and the static head and pipe friction of the machine being used. One, commonly overlooked, result is that the height of the tanker is crucial to its ability to suck out pit sludge (and many conventional tankers are too high to have much success). Indeed it is around six times harder to suck sludge from the bottom of a typical pit than from the top.

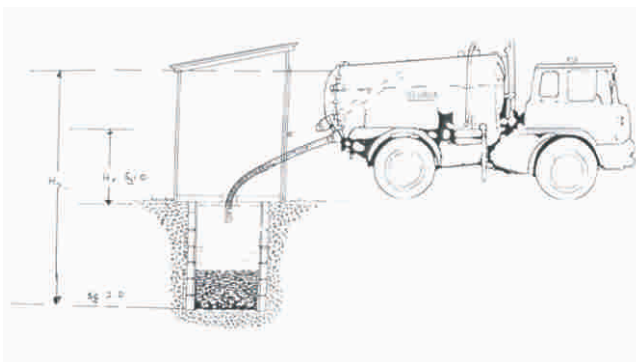

Figure 14 : Understanding vacuum truck performance

A typical situation

A vacuum truck's pump performance is shown to
0.5 bar (5.0m water)
Due to water

Waste density at bottom pit is 1.5sg

Waste height in truck 2.5m

Theoretical static head is $5.0 - 1.5 = 3.2\text{m}$

**Truck can only suck from $3.2 - 2.5 = 0.8\text{m}$ below
Ground level**

In 1987 there were a series of tests with mechanized equipment in Gaborone, Botswana (the EAWAG Botswana Trials) which highlighted the limits of existing machines in dealing with pit latrine sludges. Since then a range of mechanical devices, more appropriate to dealing with latrines, have been developed (the Vacutug is one) but their number and spread remains sorely limited.

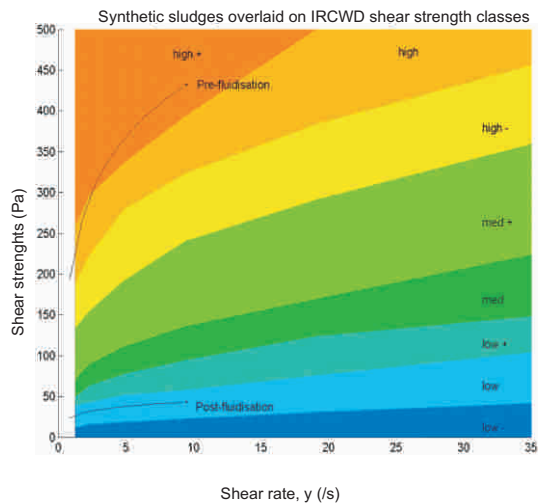

Figure 15 : Decreasing shear strength through fluidisation

A major dilemma for all pit emptying devices is that, while it is easy to extract the low density waste from the top of the pit, high density sludge progressively builds up at the base of pits and becomes increasingly difficult to remove. There are three potential responses to this challenge: i) the design of smaller pits (as little as one metre deep) that are emptied more frequently; ii) the development of better emptying devices; and iii) render the sludge at the base more 'pumpable' (for instance, via fluidisation).

The chart on the left suggests that there may be some promise in fluidisation (which is currently being tested at Cambridge University). A small amount of water and low pressure compressed air introduced to pit sludge has a surging and mixing action which can fluidise these dense wastes and make them 'suckable'.

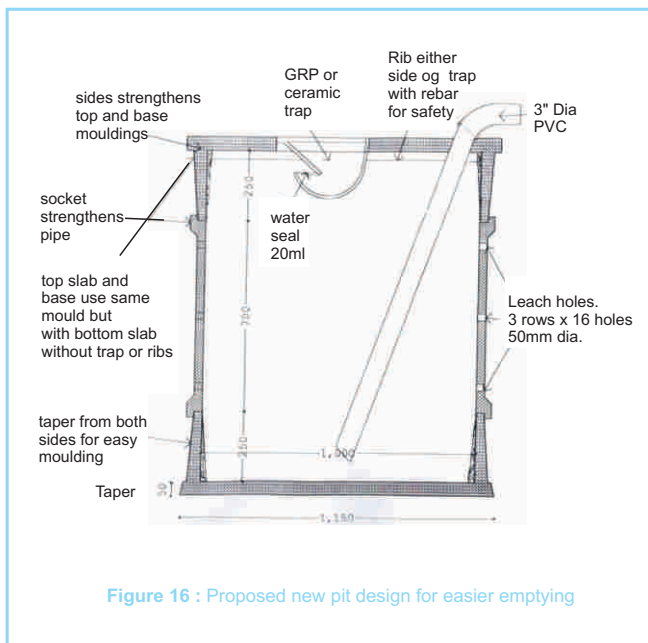

Figure 16 : Proposed new pit design for easier emptying

An innovation here has been the categorising of sludge by its mechanical properties. Another is the development of an 'artificial sludge' which allows controlled lab tests to be done.

To take this work further, Cambridge University are leading experimental work on new pit design that incorporates a means to fluidise and empty sludge more easily. The hypothesis is that the introduction of a built-in suction / blowing pipe that leads to the base of the pit will enable dense sludges to be removed and for a pit to be emptied from outside the superstructure without spillage.

The design allows for the pre-fabrication and manual placing of panels (and thus quality control) as well as pour-flush toilets (preferred by householders and ideal for keeping rubbish out of the pit). The design can also cope with high water tables, which can otherwise trouble pit latrines. The latrine is smaller than the typical one, designed to be emptied every two years.

Contact: Manus Coffey, E: manuscoffey@eircom.net or Roland Schertenleib: www.linkedin.com/pub/rolandschertenleib

Where to go for further information (web):

For details of full tests with mechanized equipment in Gaborone, Botswana (the EAWAG Botswana Trials), see the International Reference Centre for Waste Disposal-WHO Collaborating Centre for Waste Disposal on the topic of Emptying On-Site Excreta Disposal Systems.

8. In Search of Innovations in Pit Emptying

Steven Sugden: LSHTM

Manual pit emptying is the predominant form of emptying worldwide. While innovations in mechanical emptying offer some promise, a large opportunity exists to improve manual pit emptying via new emptying tools and techniques and better pit design. The London School of Hygiene and Tropical Medicine (LSHTM) has conducted a worldwide survey to identify existing and potential innovations. They (as well as Water for People and other organisations) are working on new and improved tools to assist manual pit emptiers. Local CBOs and entrepreneurs are being supported to test out new emptying techniques in several African cities. As yet there is no consensus on the 'best' business models (which will depend on context), so there is great room for progress. Innovations in pit designs can certainly make emptying easier, safer and cheaper. There is also potential to explore new biological processes (e.g. black soldier fly) and physical processes (e.g. solar drying) to make sludge safer and easier to handle.

In rural areas when a pit latrine fills, households can dig a new pit and move the superstructure. The old pit contents decay underground. In urban areas though, this approach to a full pit is not always possible. As slums grow and plots are subdivided the space available for new pits diminishes and eventually householders faced with a full pit need to have it emptied, rather than covering it over and digging elsewhere.

Globally the predominant means of emptying a full pit is by hand. This is partly because it tends to be cheaper and partly as mechanical trucks can be in short supply. A big factor however is the physical difficulty of accessing plots in urban slums. Indeed, the technologies used to empty pits can be regarded as a continuum, with manual emptying by bucket on one end and mechanical emptying via vacuum tanker on the other. There are only a few options between these two poles and none are in widespread use. These include the Vacutug (developed by UN Habitat) and the Mapet (developed by WASTE). One area for innovation is at the lower end of the spectrum where new technologies for improving manual pit emptying are being developed and tested in the field.

LSHTM developed specifications for an 'ideal' advice to assist with manual emptying. This would be able to access pit contents without demolishing the latrine, would not require direct contact with the sludge, would allow local manufacturing and maintenance and would cost less than \$200 USD. It should also be lightweight and carried across the shoulder. Ideally it would allow for operation by one person, withstand huge misuse and be capable of emptying at least the top metre of the pit.

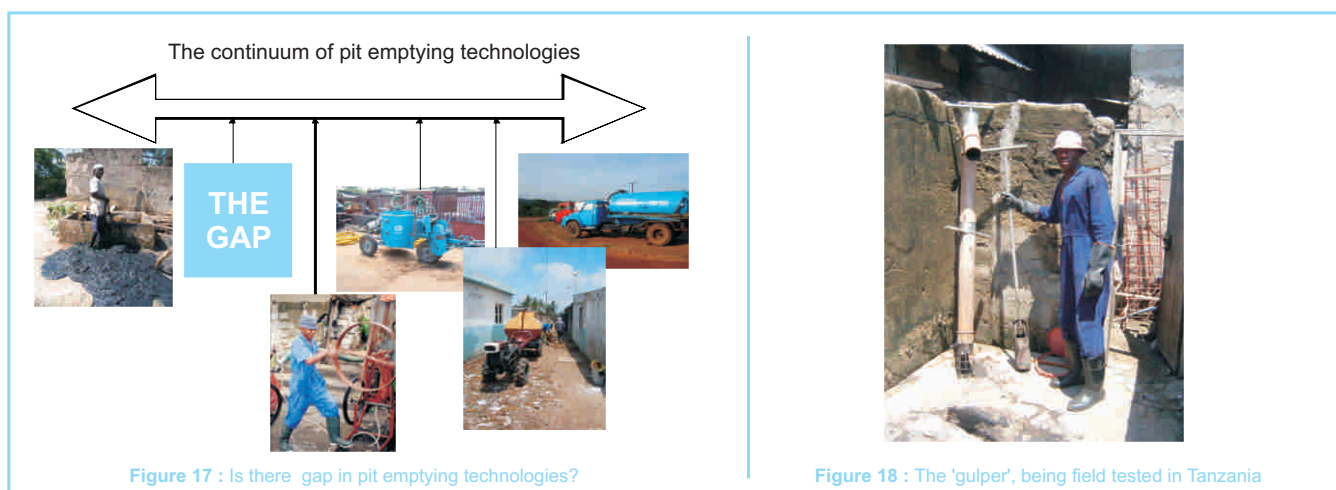

Figure 17 : Is there gap in pit emptying technologies?

Figure 18 : The 'gulper', being field tested in Tanzania



Figure 19 : Experimental solar dryer

The Gulper (figure 18) was the first of a few new options developed in order to improve the traditional manual emptying of pit latrines. Other technologies are also promising, including 'rope washer' technologies, indirect action hand pumps and screw augers. Several of these are being piloted, in Durban and elsewhere.

Once sludge has been emptied it typically needs to be safely transported to a final dumping / treatment site (sometimes it is buried nearby). Depending on the approach, this may require the use of a temporary transfer station, positioned near the toilets that are being emptied. As sludge collects there it can then be transported en masse (and at lower cost) to its final destination. Water for People are working on this aspect, hypothesising that there is sufficient energy in solar radiation dry out wet pit latrine sludge and kill off all pathogens. A valuable soil improver is generated. They are exploring the possibility of micro- treatment plants for small neighbourhood-based emptying services.

New toilet designs are also being explored; these should produce denser sludge, allow easier access and shorten the emptying frequency. Doing so may be vital for emptying businesses to become sustainable (and allow economies of scale) – long lags between emptying jeopardise current business models. Indeed, the viability of a pit emptying 'business' depends on several factors. These include the effectiveness and cost of any device used to assist emptying, the ability to physically access the pit and its contents, pit fill rates and the emptying frequencies needed. Where dumping occurs, the distance to dump sites, any dumping fees incurred, the speed of transport and the capital and operation costs of any transportation are important. Tackling these issues is the key to improving pit emptying and several organisations are trying to innovate in this area. Last of all, there may be ways to reduce sludge accumulation in pits through the addition of certain enzymes or larvae. In a preliminary test black soldier fly larvae, feasting on pit sludge, caused a 15% decrease in faecal wet weight over a period of 10 days.

In short, innovation is rife!

Contact: Steven Sugden, E: ssugden@waterforpeople.org

Where to go for further information (web):

Pit Emptying Systems - Practical Action 2009 ... The methods used to empty pit latrines can be categorised into four main groups ...
http://practicalaction.org/practicalanswers/product_info.php?products_id=395
 Sanitation Partnerships: Bringing pit emptying out of the darkness
www.bpdws.org/bpd/web/d/doc_131.pdf?statsHandlerDone=1

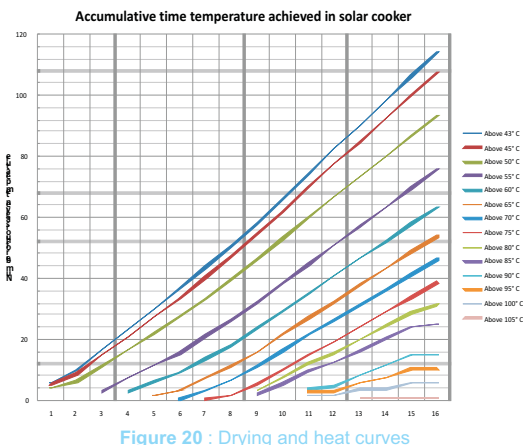

Figure 20 : Drying and heat curves



Figure 21: Dried sludge



Figure 22 a,b,c: Toilet facilities in many schools are unusable due to poor maintenance, vandalism and inappropriate usage



Figure 23 : Manual emptying of chambers



Figure 24 : On-site deep burial of sludge

9. Experience with pit emptying in the Eastern Cape: the Franchise Model

Oliver Ive: Amanz'Abantu and Kevin Wall: CSIR

School sanitation in South Africa is in a lamentable state. Toilet facilities in many schools are unusable due to poor maintenance, vandalism and inappropriate usage. This applies to many of South Africa's 25 000 schools, particularly in rural areas.

Franchising, now being pioneered by Impilo Yabantu in the Eastern Cape, offers an opportunity to 'kill two birds with one stone'. Firstly, the Department of Education is offered reliable, cost-effective, suppliers that solve an immediate problem and help it to keep school toilets in good condition. Secondly, local jobs are created and small BEE businesses set up, but with the support and backstopping of a larger firm.

Impilo Yabantu typically empties school latrine pits and household pits manually and buries the waste on-site. The franchise model they use allows the larger firm (franchisor) to seek out new technologies and better ways of dealing with the waste. The smaller franchisees grow with the business and plough the benefits back into local communities. A particular challenge is in the way school toilets are designed, making maintenance harder than it needs to be. Hopefully the 'sanitation sector' can feed such lessons back into any new school developments.

School sanitation in South Africa is in a lamentable state across many of South Africa's 25 000 schools, particularly in rural areas. This sets back education as well as causing ill health.

Around 2005/6, the WRC commissioned a study into the potential of franchising models in water and sanitation services. On the back of this, Amanz'Abantu, a private South African company (with support from Irish Aid and CSIR) undertook to explore the how a franchising model could be applied to school sanitation. It set up a subsidiary, Impilo Yabantu, in the Eastern Cape, which works on contract to the Department of Education. The pilot project is in Butterworth District where there are 400 schools, whose sanitation is often in poor condition.

Butterworth's schools typically have insufficient access to maintenance support (due to their geographical spread and internal constraints in the education system). The consequential non-existence of sanitation facilities, or their poor maintenance, undermines the dignity of students and staff. Wider challenges exist; health & hygiene related matters are rarely prioritised; there are difficulties with solid waste management and waste disposal; budgets are short (with other activities given priority) and; there is a general lack of understanding of how to service and maintain on-site sanitation systems.

The franchising approach allows local jobs to be created and small BEE businesses set up, but with the support and backstopping of a larger firm. Currently Impilo Yabantu typically empties latrine pits (both for schools and households) manually and buries the waste on-site. The franchise model they use allows the larger firm (the franchisor) to seek out new technologies and better ways of dealing with the waste. The smaller franchisees grow with the business and plough the benefits back into local communities.

They not only clean and maintain toilets, but conduct health and hygiene awareness campaigns at schools. This helps to pass messages about proper user usage, needed as pits are often full of rubbish (that complicates toilet maintenance).

A particular challenge is in the way school toilets are designed, making maintenance harder than it needs to be. Sometimes the chambers cannot be accessed from above and maintenance workers need to dig in and break chambers from the side.

Applicants to become franchisees are not in short supply, but finding the right people can be a challenge. Running a business gives the owner status (owners are typically women). Franchisees and those who work for them are paid a premium over standard manual labour, given the nature of the job. Medical bills are covered and more safety equipment and training is involved.

Contact: Kevin Wall, E: kwall@csir.co.za or Oliver Iwe, E: oive@aserve.co.za

Where to go for further information (web): See <http://www.wrc.org.za> for:

Wall KCA (2005), Development of a framework for franchising in the water services sector in South Africa. WRC Report KV 161/05, January 2005.

Wall KCA; Iwe OM (2010), Water services franchising partnerships, a set of seven reports. WRC Research Reports No's: TT 432-1-10 to TT 432-7-10, May 2010.

Wall K, Bhagwan J, Iwe O and White M (2010) Bucking the Water Services Trend – Franchising O&M in the Eastern Cape. Proceedings WISA Biennial Conference & Exhibition, Durban ICC, South Africa, 18-22 April 2010.

Session 4: Mechanised emptying for SMMEs

10. The quest for sustainable sanitation in Cambodia

Jared Wood: International Development Enterprises (IDE)

Thanks to a successful sanitation marketing programme Cambodia has seen a rapid increase in recent years in its uptake of improved sanitation. Cambodia's population is 80% rural, and thousands of its householders have recently been investing in improved pit latrines. Like many other countries, Cambodia has a vibrant market for the mechanical emptying of latrines in the capital city of Phnom Penh, but its rural pit latrines are predominantly emptied, unhygienically, by hand. The international NGO IDE and French NGO GRET are working with several entrepreneurs in order to test business models for the improved emptying of latrine pits and transportation of the waste. They are also looking into low cost treatment options (using aquaculture and vermiculture, amongst other methods) so that pit sludge can be treated appropriately and the by-product can be seen as a valuable and safe resource. Marketing and education are cornerstones of the testing and implementation stages of IDE's project, in which the involvement of government departments, the sanitation sector and entrepreneurs is crucial.

Successful sanitation marketing in Cambodia has seen more latrines bought and sold in the last two years than in the previous four years combined. This increase in formal sanitation is bringing in its wake a growing challenge (and opportunity) in the need to empty latrines as they fill up.

Cambodia's population is 80% rural and cultural considerations around the handling of faecal waste are significant. Householders associate the smell of sludge with pathogens and rather than empty latrines themselves often employ other people to empty them. This is often into the neighbouring padi fields. If householders cannot afford to pay someone to empty, then there is a significant risk of them reverting to open defecation.

The international NGO IDE and collaborators GRET are working to address the challenge ahead. They are working with several entrepreneurs who already have nascent emptying businesses and are looking to engage latrine salesmen and producers (who see that their sales market will eventually saturate, but the market for emptying is potentially on the verge of a boom).

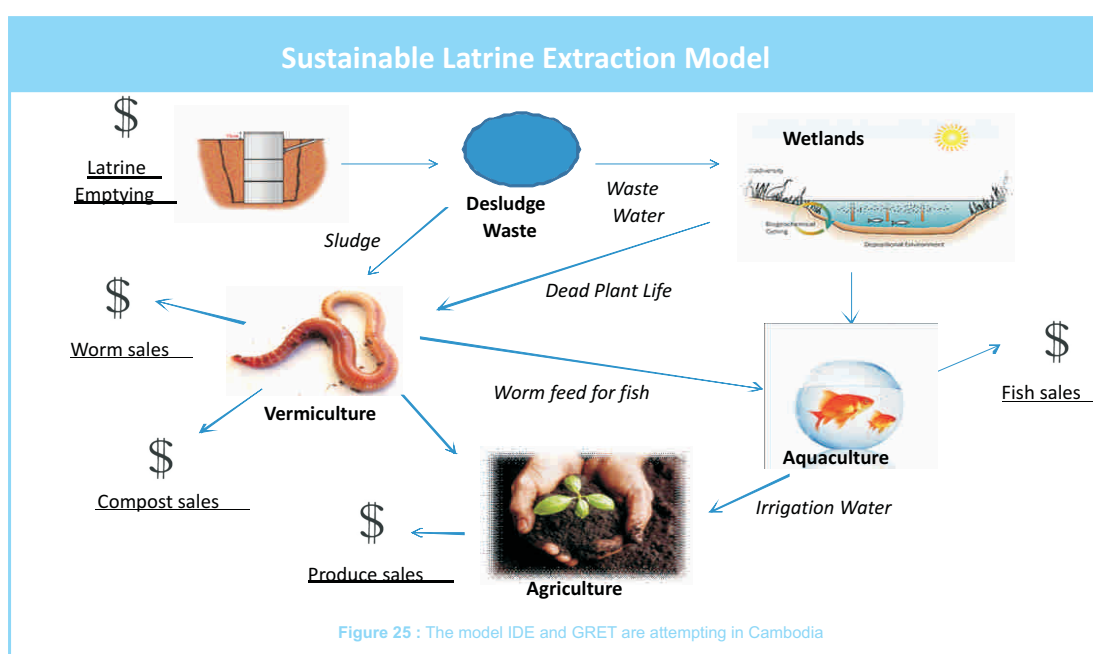

IDE's model looks to balance the need for business viability with environmental considerations. It hopes to add revenue to the waste stream through vermiculture, aquaculture and valuable by-products of nutrient-enriched wetlands. It is also working on lowering the costs of sludge extraction (and improving the process).

Should a subsidy be required, IDE are looking at principles such as Output Based Aid or similar 'payment for performance' to ensure that market distortions are kept to a minimum and potential for scaling up their work is not unduly harmed.

In Phnom Penh, the capital, there are currently 7 operators of vacuum trucks – demand is growing with time. In total there are up to 14 or 15 vacuum trucks in the city. One entrepreneur with which GRET has engaged charges \$15 USD for rural emptying (versus \$30 typically charged in the capital), but this remains beyond the willingness and ability to pay of many poorer Cambodian citizens. A second operator sold his motorbike and took a loan in order to buy his first pump truck, 4 years later he purchased a \$20k USD truck.



Figure 26: Cambodian vacuum truck dumping into fields

Marketing and education are also vital to the success of their plans. They wish to get the entrepreneurs to incorporate this in their activities – both to raise awareness of their services amongst consumers, but also to spread health and hygiene messages. In this vision, the need to spread a message of 'clean and green' pumping out of latrines is important – in this IDE and its partners seek to work with community leaders, respected community members, religious institutions, public health centres and schools.

IDE was also involved in a successful sanitation marketing project in Vietnam, which helped boost the demand for and supply of rural latrines. Its approach in Cambodia is firmly in line with the philosophy of sanitation marketing, in this instance applied to the challenge of faecal sludge management.

Contact: Jared Wood, E: jwood@ide-cambodia.org

Where to go for further information (web):

See <http://www.ide-cambodia.org/> & <http://www.makingsanitationeasy.com/>

11. The PETshop toys. Of eVacs, Nanovacs and PSAs.

David Still: PID

After a long period in which progress in pit emptying techniques was sorely lacking, recent years have seen an explosion in innovation. Standard vacuum tankers, efficient at emptying septic tanks, often struggle to empty latrines, both due to the nature of the sludge and the difficulty in physically accessing toilets in many poor urban communities. PID, along with EWB and several others, have tested a range of options for the mechanical emptying of pits. These aim to make the manual emptying process easier and more hygienic. Many designs are still prototypes but valuable lessons are being learnt on what works and what does not work. There are high hopes that an ergonomic, cheap and reliable breakthrough will soon be available to municipalities and others faced with the unenviable yet vital task of emptying full pit latrines.

On-site sanitation is very common in Southern Africa and in South Africa is the level of service preferred by many municipalities (who have a constitutional obligation to provide adequate sanitation to their residents). In South Africa, as elsewhere, there are essentially two options once a pit is full. The first is to cap the old pit, dig another and move or rebuild the superstructure of the toilet. This can cost in the region of 6000 ZAR or more (around \$800 USD). The second is to empty and recommission the old pit. There are several advantages to doing this.

It costs less (between 600 and 2000 ZAR), local labour is used (which puts money back into the local community) and can be completed as part of a cleansing sweep over an area. Arguably this approach is more sustainable as existing infrastructure is re-commissioned rather than bypassed.

Yet standard vacuum tankers, although efficient at emptying septic tanks, often struggle to empty latrines, both due to the nature of the sludge and the difficulty in physically accessing toilets in many poor urban communities. To overcome this, a range of organisations have been working on the development of other, more appropriate options for the mechanical emptying of pits. Most of these accept the viability and practicality (and sometimes necessity) of manual emptying and seek to make this process easier and more hygienic. Researchers and practitioners seek an ergonomic, cheap and reliable technology.

The main difference is between devices that use mechanical means to lift out the sludge (such as an auger) and those that use a vacuum. The Vacutug was an early pioneer of this latter method and has been trialled both inside and outside South Africa. PID tested this in Pietermaritzburg, finding that sites could be emptied for around 250 ZAR to remove 1 m³ of sludge (this cost did not include the cost of a municipal truck, used to transfer the waste to a treatment station). The equipment is heavy and difficult to move between sites and hills and narrow access points present a definite challenge. In these trials the pits were linked to low flush toilets, so the sludge was wetter and contained less rubbish than normal pit sludge. On top of the 'Gulper' and 'Nibbler', discussed in Section 2, PID have tested the 'Gobbler' and a 'Pit Screw Auger' (see photos below). The Gobbler uses a chain and scoops to lift out waste. However, it weighs a lot, it can jam easily and in many ways and has lots of moving parts. The Pit Screw Auger is essentially a modified fence post driller. This technology has looked promising in trials and is simple to use. Importantly, it also deals with the common challenge of solid waste in the pit better than some other technologies. On the negative side, it needs quite precise positioning, is of fixed length, is heavy and hard to clean. Both options can be hard to get into the pit if they have to go through the pedestal.



Figure 27 : Gobbler using chain system



Figure 28 : Early prototype of a Pit Screw Auger (PSA)



Figure 29 : Nano-Vac prototype

'Nano-vac' and 'E-vac' prototypes use vacuum to suck out the waste. These either suck the waste out and then blow it into a transfer tank, or include the transfer tank in the design. Prototypes are still undergoing testing but look promising, partly due to the ease of use and partly as they are potentially more hygienic. However such vacuum devices are only good for relatively liquid sludge.



Figure 30 : Vacutug being trialled in Pietermaritzburg

Importantly, all these technologies struggle to deal with the sheer volume of solid waste dumped into pits. A conclusion of the work is that “manual emptying will remain the only practical option if we cannot change the habit of dumping rubbish into pit latrines”. With this in mind the research team started to look at technological solutions to a behavioural challenge. This focuses on the potential use of pour flush toilets in pit latrines. Pour flush toilets solve the rubbish challenge as people will not throw rubbish down a water seal toilet (it immediately blocks and needs to be fixed by the user). Fifteen pour flush units are now under testing and steps are being taken to minimise the water needed for adequate flushing (currently between 0.75 and 1.5 litres of water is required – greywater is of course suitable). These trials are going well, with no blockages reported to date.

Contact: Dave Still, **E:** dave@pid.co.za or Steven Sugden, **E:** ssugden@waterforpeople.org

Where to go for further information (web):

http://practicalaction.org/practicalanswers/product_info.php?products_id=395

<http://www.unhabitat.org/categories.asp?catid=548>

Session 5: Grasping the nettle – eThekweni's Pit Emptying Programme

12. Lessons from eThekweni's Pit Emptying Programme – from pilot to full scale

Dave Wilson: eThekweni Water Services

The expansion of eThekweni's municipal boundaries in the late 1990s threw up a new and urgent challenge. Alongside its existing latrines the municipality inherited a large number of pit latrines that were filling up rapidly. Many of these were poorly designed or poorly maintained, making emptying exceedingly difficult. Full and overflowing latrines not only deprived communities of access to sanitation but posed a drastic health threat. eThekweni launched an ambitious programme to explore how best to empty these full latrines, many of which contain not just faecal waste but large quantities of solid waste. It tested various options, finally settling upon a manual emptying programme which was best from both a cost and operational perspective. Along the way the municipality learnt many lessons about manual emptying techniques, health and safety risks and contracting options. It confirmed the pre-eminent role played by education in the use of pit latrines and waste management. eThekweni now offers households free emptying every five years and continues to explore improvements in how to empty, transport and treat sludge from pit latrines (around 35 000). eThekweni also has many urine diversion toilets (around 70 000), which currently householders empty. For future non-networked sanitation, urine diversion toilets are preferred, partly as emptying them is far easier.

In the last two decades many formal VIP latrines were built across Kwa-Zulu Natal (and, indeed, South Africa). Sadly, during construction of these facilities a few key elements were neglected, such as proper education of the users, consideration of how to access the latrines in order to empty them and the cost of doing so, once full. In the mid 2000s, eThekweni turned its attention to the new and urgent challenge it had inherited when its municipal boundaries were extended. Full and overflowing latrines not only deprived communities of access to sanitation but posed a drastic health threat.



Figure 31: Waste is buried on site where space permits



Figure 32: Many latrines are poorly designed for later emptying



Figure 33: Using specialised tools to extract wet sludge from septic tanks



Figure 34: Example of user education poster

eThekweni launched a pilot study, based on 500 latrines, exploring how best to empty latrines and dispose of the waste. For both cost and operational practicality it settled on a manual emptying programme, which would offer a free emptying to each householder every 5 years. Teams of 6 work, via a sub-contract arrangement, emptying in a sweep one community's latrines.

Health and safety risks were a prime concern and addressed by full training, safety equipment and research into the full risks entailed. Beyond this, one of the key challenges was in how pits were constructed, the wide variance in design which often made emptying unnecessary difficult. On top of this many households use the latrines as an easy way to dispose of solid waste (formal collection mechanisms are not always as they should be). Manual emptying was chosen as the suitable method as slopes, space and the nature of sludges often make mechanical emptying difficult or impossible. eThekweni created special tools to assist with this emptying as well as testing new technologies.

For transporting and treating the sludge several models were proposed. Adding sludge to sewers proved a mistake as the solids loading and nutrient content overwhelmed sensitive systems at treatment plants, which were not designed for such waste. Deep trenching is now being piloted, as is heat treatment and pelletizing of the sludges. Burial on-site is used wherever space permits (approximately 70% of cases).

Many lessons were learned. Emptying is typically messy, smelly and unhygienic and emptying VIPs is costly and difficult. The average cost, all factors taken into account, including disposal, came out at around 1500 ZAR (\$200 USD a pit).

As a result of this, plus the difficulties of dealing with the waste, eThekwini proposes that all new on-site toilets should be urine diversion (UD) toilets, which are designed for easier emptying. Solid waste management and user education are crucial challenges as the amount of solid waste in a pit confounds hygienic emptying – until this is addressed, problems shall continue.

Contact: Dave Wilson, E: DaveWi@dmws.durban.gov.za

Where to go for further information (web):

BPD Sanitation Partnerships Series: Bringing pit emptying out of the darkness – the ePLEP programme in Durban
www.bpdws.org/bpd/web/d/doc_131.pdf?statsHandlerDone=1

13. Sludge disposal in eThekwini. Reviewing the options

John Harrison: eThekwini Water Services

The progress of eThekwini's pit emptying programme threw up a significant challenge in how best to deal with the significant quantities of digested sludge unearthed. Early hopes that rudimentary primary treatment of the sludge would allow it to be discharged to sewers and the existing sewage treatment plant proved unfounded. Pit sludge is approximately 700 times more concentrated than conventional sewage and therefore the large-scale addition of such sludge to a conventional works quickly overloads it, sometimes with disastrous consequences. Consequently a large backlog of pit sludge has accumulated in Durban (under temporary storage), but recent trials of two technologies offer significant promise. One option is to dewater, heat treat and pelletize the sludge, using a mobile plant patented by EWS and partners. The pellets can potentially be used as fertiliser for agriculture. A second option (discussed in the next session report) is the entrenchment of the sludge along with agroforestry.

eThekwini's pit emptying programme generated significant quantities of partly digested sludge. Early plans were to discharge the sludge into the existing sewers (where possible) after rudimentary primary treatment. Doing this proved a mistake however, throwing the existing wastewater treatment plants into serious disarray. As can be derived from Figure 35, in terms of Total Suspended Solids (TSS) and Total Kjeldahl Nitrogen (TKN), 1,5m³ VIP sludge can be considered the equivalent of 1 megalitre of sewage!

Parameter	VIP Sludge (mg/l)	Sewage (mg/l)
COD	157000*	750
TSS	204000	310
TKN	42000	60

Figure 35 : Comparison of pit sludge with typical sewage

Going back on the pit emptying programme was not an option so quick solutions needed to be found for the backlog of pit sludge accumulating (under temporary storage at a wastewater treatment works).

At other times and places this type of sludge has been added to farmland, but in this case the risk of pathogens, the presence of large quantities of detritus and the difficulty of repeated material handling quashed that option.

Fortunately officials from eThekwini came into contact with a few groups who offered a technological solution (a second, more 'organic' option, of entrenching the sludge along with agroforestry is discussed in the next session report). In Cape Town there is a sludge pelletizer that deals with sludges from the Cape Flats wastewater treatment works. Using a similar method, with a means of drying out the VIPs sludges beforehand offered some promise. On this basis eThekwini have developed a machine that compacts the pit sludge, dries it (using medium-wave infrared radiation) and turns it into pellets that can be used in agriculture.

This machine is currently running at one of their wastewater treatment works, housed in two containers (one of which contains a diesel generator and the control mechanisms – but could be done without were a power supply to hand). The whole set up is designed to be portable so it can move around and therefore reduce the cost and complexity of transporting the sludge to its final treatment location. Developing it has cost in the region of 2.5 million ZAR (\$400 000 USD). Preliminary analysis suggests that such a machine could service a community of around 60 000 people and that it is effective at removing harmful pathogens from the waste.

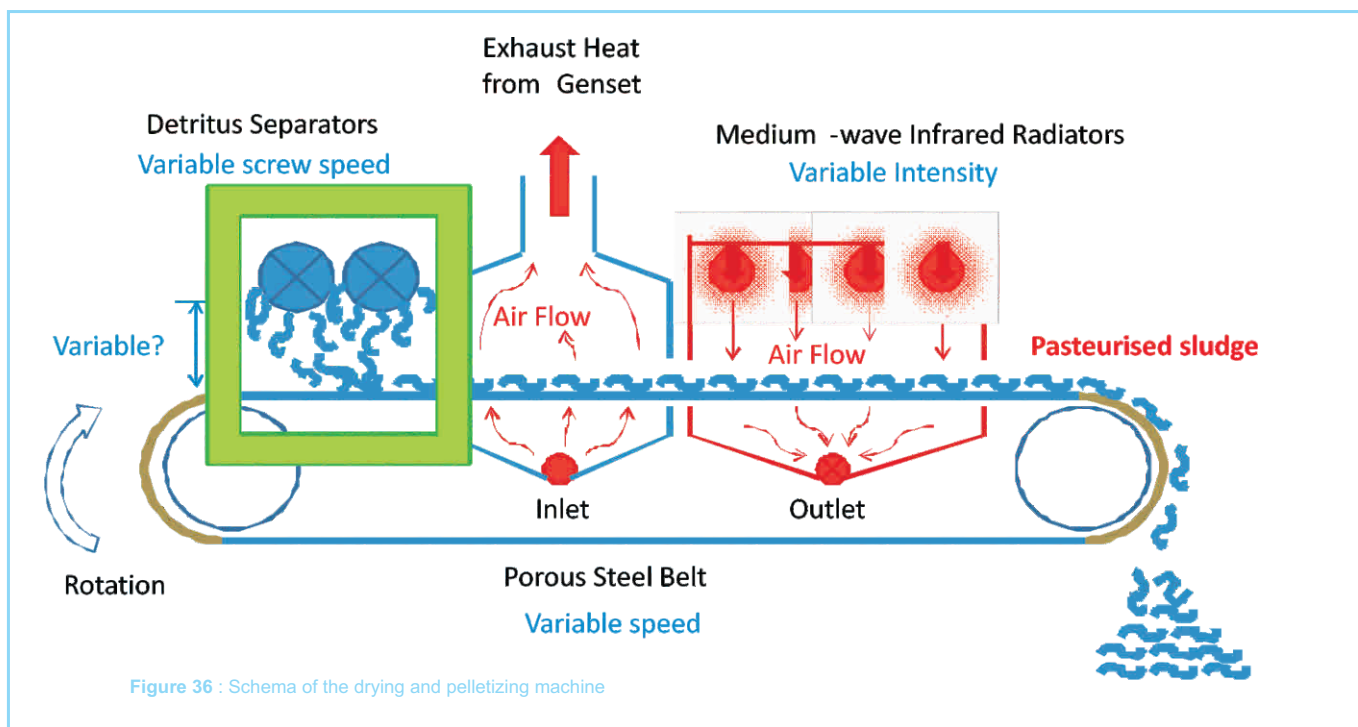

Figure 37 a,b: Semi-dried sludge being loaded into the machine



Figure 38 : Dried sludge pellets



The machine and method are still undergoing testing, with the next steps being to: i) re-evaluate the overall objectives; ii) establish settings and ranges for the treatment process; iii) improve the reliability of the machine and; iv) establish the agricultural value of the end product.

Contact: John Harrison, E: JohnHa@dmws.durban.gov.za or Dave Wilson, E: DaveWi@dmws.durban.gov.za.

14. Simple sludge disposal with benefits? Deep-row entrenchment with agroforestry

David Still: PID and Craig Taylor: UKZN

Recent trials in South Africa have suggested that the controlled addition of faecal sludge can strongly benefit the growth of certain plants and trees. Indeed faecal sludge can outperform fertiliser. Previously the burial of untreated faecal sludge has raised concerns about the environment and particularly the contamination of groundwater. Preliminary results suggest however that these fears can be reasonably allayed and, as such, the burial of faecal sludge along with careful planting offers a promising means for its safe disposal. South Africa's research thus tallies with international experience.



Figure 39 : Sadly typical means of waste disposal, often into streams and wasteland

A major challenge for municipalities across SADC is what to do with the digested sludge removed from pit latrines. In South Africa dealing with sludge is essentially the role of the municipality – in other countries it is hoped that sludge emptied by private providers is delivered to the 'public system' in order to be treated (and possibly, reused). Current disposal methods are often severely inadequate, putting health and the environment at risk.

Internationally a fair amount of work has been done on sludge disposal (albeit more so on sludges from wastewater treatment plants). In the United States such sludge is referred to as 'biosolids' and deep row entrenchment followed by the planting of trees is one of the disposal options.

Inspired by such examples, recent trials have taken place in Kwa-Zulu Natal, South Africa. Early trials took pit sludge and planted it on private land, along with fruit trees. Controls were used, with other trees planted with standard fertiliser or nothing added. These initial trials suggested that digested pit sludge contributed to enhanced growth and tree health.

In 2008 larger scale trials started at Umlazi East ponds in Durban. The site chosen was eminently suitable – it had formerly been used for sewage disposal, was below the 1:50 year flood line and therefore 'valueless'. Stringent control measures were put in place (to test groundwater and also to compare 'sludge-enhanced' growth with standard growth). These tests, planting fast-growing eucalyptus and wattle, showed that the addition of digested pit sludge enhanced the growth of the trees, whilst borehole monitoring has to date detected no pollution of the groundwater.

Follow up work with the multinational forestry company, Sappi, has suggested similar benefits in using the sludge for forestry projects, with sludge seeming to outperform the company's usual fertiliser additions. As fast-growing forestry trees take water and nutrients out of the ground, there seems little danger of groundwater pollution, although stringent monitoring is ongoing.

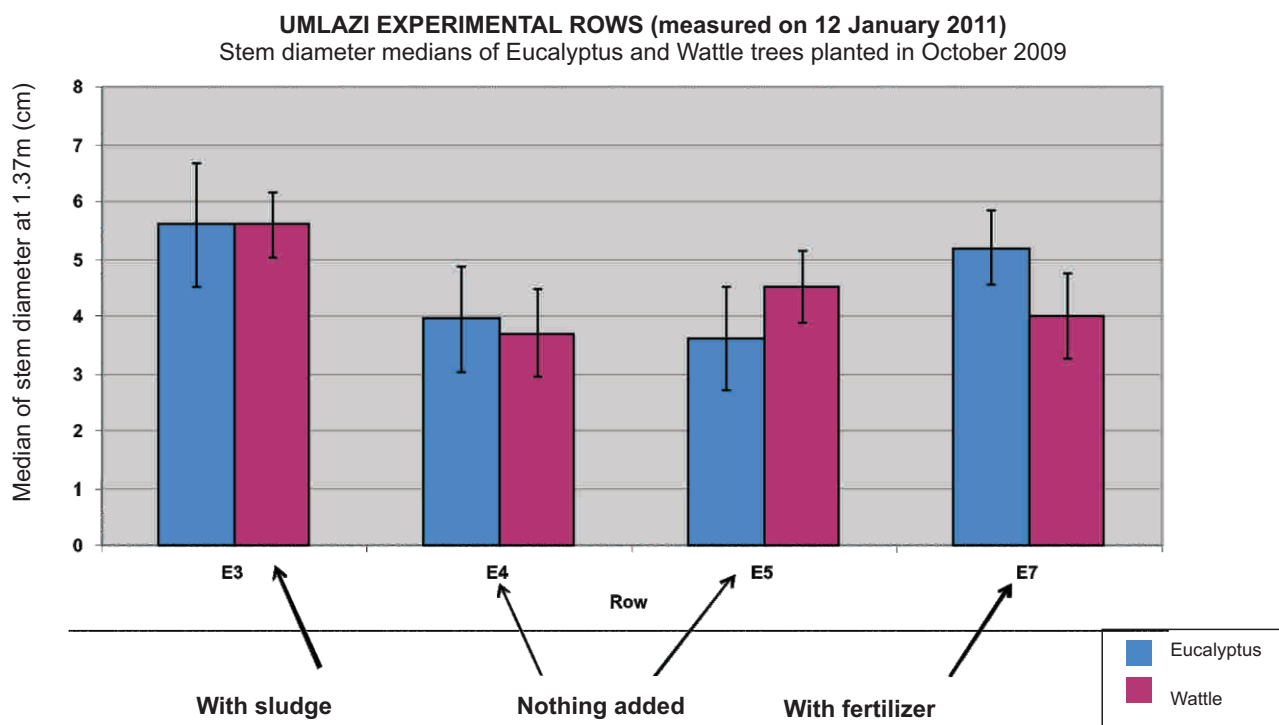

Figure 40 : Test results from Umlazi, showing better growth (trunk diameter) with sludge



Figure 41 : Deep row entrenchment of pit sludges



Figure 42 : Early tree growth at test site

Lab tests, looking closely at the growth and photosynthesis of test plants have confirmed the benefits of sludge addition, concluding that “faecal sludge is a valuable nutrient source with sludge-enhanced tree growth comparing favourably that aided by traditional fertilisers”. On a practical level, deep row entrenchment has one large advantage, in that the large amount of plastic waste typically found in pits does not pose a significant problem.

Contact: David Still, E: dave@pid.co.za or Craig Taylor, E: 205518269@ukzn.ac.za

Where to go for further information (web):

<http://www.biosolids.com.au/>

http://www.naturalresources.umd.edu/Publications/BiosolidResearch/Biosolids_Overview.pdf



Figure 43a,b: Unregulated pit emptying (outside South Africa)



Figure 44a,b: Formalised pit emptying in eThekweni

15. First do no harm: how do we protect the workers and the public during the process?

Dr Nicola Rodda: UKZN Biological Sciences

The emptying of pit latrines and urine diversion toilets exposes both the emptiers and nearby householders to hazardous waste and pathogens. Previously the full risks of doing so were poorly understood, but recent research (studying eThekweni's pit emptying programme) has quantified these risks and allowed a better understanding of what protection measures bring the risk within reasonable bounds (and which do not). Better guidelines on health and safety for workers in such programmes have resulted, as well as insights on how to reduce the exposure of poor communities to the various pathogens found in faecal sludge.

The emptying of pit latrines and urine diversion toilets exposes both the emptiers and nearby householders to hazardous waste and pathogens. Yet few studies have actually looked at what those risks are and how they can best be mitigated. For an organisation like EWS, which seeks to develop a formal and regulated pit emptying programme, quantifying these risks is important. Accordingly the municipality teamed up with UKZN to look at this, with the end goal of developing protection measures that bring the risk – to both workers and householders within reasonable bounds.

There are four classes of pathogenic micro-organisms found in latrine sludges. These are viruses (the smallest and simplest, relatively resistant that do not multiply in the environment and have a low infective dose), bacteria (which are unicellular, do multiply in the environment and have a high infective dose), protozoa (larger again, with resistant cysts that do not multiply in the environment and have a low infective dose) and helminths (worms, some of whom are parasites with highly resistant eggs. They do not multiply in the environment and have a very low infective dose).

The risks entailed are determined by estimating the probability of infection, with one excess infection per 100 000 per year thought to be 'acceptable'. Ideally one would reduce risk by treating the waste before handling, but this is not possible with pit latrine waste. Hence the approach is to introduce barriers to exposure.

At first workers, along with gloves and boots, were given basic dust masks to wear (of the sort hardware shops sell). Analysis of the masks being worn by users after a cycle of emptying however revealed very high counts of *Ascaris* eggs on the masks, especially for those spraying waste through a separation grid (before it was washed into sewers).

It was clear that a basic dust mask was insufficient and that a heavy duty breathing mask would need to be used. This, together with the other measures, plus deworming after exposure, was judged sufficient to reduce the risk of additional infections to 2.5 people per million people – and thus within satisfactory levels.

Observations of potential exposure after UD emptying and burial of waste

Faecal waste left exposed after UD emptying and burial of contents	72%
Burial sites highly accessible	84%
Waiting period by householders before burial site	12%

Figure 45: Field observations on exposure risk in Ethekwini

Questions remain about how protected householders are from infection, if they are to empty their own pits or the waste is to be buried on-site near them. But the best has been done to protect the people involved in the pit-emptying programme. In locations other than Durban the disease profile will be different, so risk factors will be different, but the methodology used in this study would remain valid.

Contact: Nicola Rodda, E: roddan@ukzn.ac.za

Where to go for further information (web):

Health Risk Assessment of the Operation and Maintenance of a Urine Diversion Toilet, Rodda et al
www.ewisa.co.za/literature/files/173%20Rodda.pdf

Session 6: The sludge disposal issue

16. The critical cost consideration. Sludge transfer and transport

Manus Coffey: Sludge Management Consultant

There are strong parallels between the management of liquid waste and that of solid waste. In solid waste the challenge of efficient collection and transport has been much studied and there are valuable lessons for the sanitation sector. There are various ways to transport waste once evacuated from latrines, using manual, animal and mechanical means. Distance and load are two prime considerations, as is the speed of traffic on transport routes. Whilst vacuum tankers are commonplace in the sanitation sector there are potentially significant benefits to be had in looking at other options, including tractors and trailers, motorbikes etc.

There are strong parallels between the management of liquid waste and that of solid waste. In solid waste the challenge of efficient collection and transport has been much studied and there are valuable lessons for the sanitation sector.

Two of these are found in the maxims of David Jackson, somewhat of a guru in the solid waste sector. **He said :**

H	Handle	K	Keep
O	Only	I	It
O	Once	S	Simple
		S	Stupid

Both of which can be applied to the issue of transporting sanitation waste.

There are various ways to transport waste once evacuated from latrines, using manual, animal and mechanical means. These each have advantages and disadvantages – and broadly, the further the waste needs to be transported, the more advantageous the more 'advanced' forms of transportation (and vice versa).

Whatever system is chosen (and there a whole range of options: handcarts; tricycles; motorcycle trailers; piki-pikis; donkeys and carts; tuk-tuks; modified tractors and trailers; pick-up containers; and trucks) local modification is key to success. This will have to take into account cultural factors, familiarity with the mode chosen, repair options and local legislation, amongst others.

In peri-urban areas there is often an access problem, making it difficult for larger vehicles to get to the latrines. This lends itself to a two-stage solution – with small, highly manoeuvrable machines operating within the area (for instance, inside a slum) and then transfer vehicles



Figure 46 : Tractors are cheaper to buy and run than trucks

suitable to the often large distances to the final dump site (which can be as far as 10-20 kilometres and thus favour large traffic-worthy vehicles). This 'split' solution lends itself to separate tanks being used for the final transport – this allows the smaller vehicle taking waste from latrines to shuttle back and forth and a tractor or other vehicle to transport the tank only once full. This saves on transport costs and means that fewer emptiers are 'held-up' by the absence of a dumping point during transfer.

As it is, vacuum tankers are commonplace in the sanitation sector. But there are potentially significant benefits to be had in looking at other options, including tractors and trailers for larger loads, or motorbikes for smaller ones. In particular, tractors are cheaper than trucks to begin with (often as much

as half the price) and depreciated over a longer period of time (10 years versus 7 years) – so it can make financial sense to adopt this solution. For short distances a useful maxim is therefore “always go with a tractor” – although this happens less in practice than one would expect. The wide turning circle of tractors could be one reason – cultural reasons also play a part.

Contact: Manus Coffey, **E:** manuscoffey@eircom.net

Where to go for further information (web):

UN Habitat "Collection of Municipal Solid Waste in Developing Countries" www.unhabitat.org

17. Human waste: for how long can we afford to throw it away?

Professor Chris Buckley: Pollution Research Group, UKZN

Phosphorus and nitrogen turned into artificial fertilisers permitted the 'green revolution' in agriculture to take place. Yet, unlike nitrogen, phosphorus is a finite resource, mined from the environment. The concept of 'peak phosphorus' is now gaining ground internationally. This has parallels to the concept of 'peak oil', save that phosphorus is a vital ingredient for all living matter and cannot be substituted. Whilst phosphorus use for fertiliser in developing countries exploded in the last 50 years (since declining with more efficient application techniques), in Sub-Saharan Africa the use of phosphorus is still minimal (4% of East Asian levels), which holds back crop yields. In such a context it is arguable that the phosphorus in urine should be considered a valuable resource rather than an inconvenient waste stream and ways should be found to collect and use it productively.

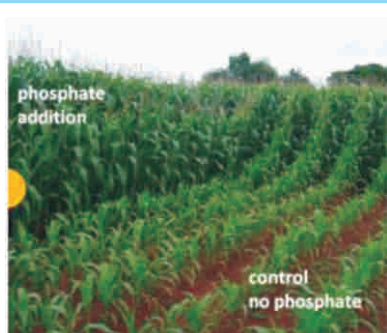

Figure 47: A visual reminder of the power of fertiliser

Malnutrition is linked to 14% of the global disease burden (in terms of DALYS). A fertiliser shortage, particularly in developing countries and particularly in Africa is linked to that situation. It can be argued that Africa has largely missed out on the 'green revolution', which was brought about by the large scale transformation of phosphorus and nitrogen into artificial fertilisers. In Sub-Saharan Africa the use of phosphorus is still minimal (4% of East Asian levels). This is a travesty as Africa's red soils (iron oxide rich) sequester phosphorus, making the addition of fertiliser even more important.

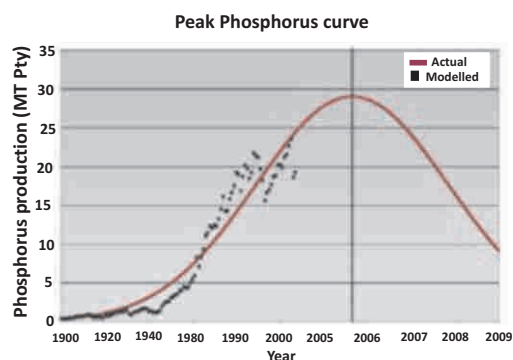

Figure 48: 'Peak' phosphorus forecast for around 2035

Unlike nitrogen, phosphorus is a finite resource, mined from the environment. A lot of Africa is far from the sea and far from where this it is mined, making fertiliser more expensive. Yet there is significant phosphorus content in urine, and some argue that it should be viewed as a valuable resource.

Whilst the amount of phosphorus that can be reclaimed from human waste is small in relation to the amounts currently mined for fertiliser use (around a tenth of use in Africa), as mining reserves diminish, this will increase in importance. It is also a local resource for African countries that does not require transporting long distances. For subsistence farmers and others this therefore represents good potential, particularly given the

low usage of phosphorus rich fertilisers currently.

There is twice as much phosphorus in urine as in faeces (and eight times as much nitrogen). As urine is sterile there are few risks to reusing urine in food crops (not the case for faecal matter). This is an argument in favour of urine-diverting toilets, which allow the urine to be captured uncontaminated and potentially reused.

Table: Proposed new Swedish default values for excrete mass and nutrients (Vinneras, 2002)

Parameter	Unit	Urine	Faeces	Toilet paper	Blackwater (urine+faeces)
Wet mass	kg/person, year	550	51	8.9	610
Dry mass	kg/person, year	21	11	8.5	40.5
Nitrogen	g/person, year	4000	550		4550
Phosphorus	g/person, year	365	183		548

Figure 49: 'Peak' phosphorus forecast for around 2035

There are three principal options for reuse: the direct application to crops (after dilution); the addition of magnesium in order to recover struvite through precipitation; and the evaporation of urine to recover all nutrients save ammonia.

Trials have been taking place in Durban which show the use of recycling phosphorus – these trials are also exploring issues related to 'safe' use of any additives. Cultural attitudes surrounding reuse are important – China has reused excreta for thousands of years – but is not a large 'salad-eating' country. Reuse of urine is therefore to be handled with due caution and 'marketed' appropriately and sensitively.

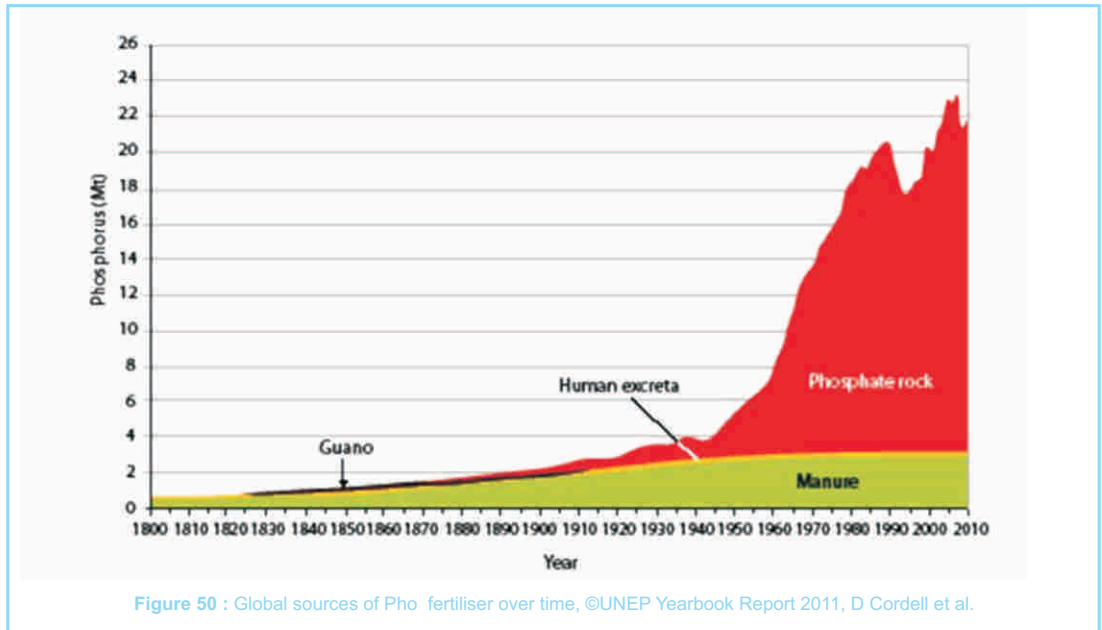

In such a context it is arguable that the phosphorus in urine should be considered a valuable resource rather than an inconvenient waste stream and ways found to collect and use it productively.

Contact: Chris Buckley, E: buckley@ukzn.ac.za or Dana Cordell, E: Dana.Cordell@uts.edu.au

Where to go for further information (web):

Peak Phosphorus: the sequel to Peak Oil

www.phosphorusfutures.net/peak-phosphorus

The era of peak phosphorus is coming | Energy Bulletin 20 Jun 2008 www.energybulletin.net/node/45534

18. Experience with Urban Sludge Treatment in Indonesia

Stefan Reuter: Borda

It is possible to decentralise the treatment of wastewater coming from septic tanks, as the NGO BORDA have shown in Indonesia and other countries. Their self-contained DEWATS system localises the treatment of waste, without the need for external energy inputs to the process. This localised treatment makes the waste streams easier to handle, as well as generating tangible benefits for local communities (such as biogas and compost for urban farming). In Indonesia there are now more than 500 DEWATS systems operational, with the oldest one having been installed in 1996. BORDA also have extensive experience in India and China and have recently expanded to the SADC region.

In the management of faecal sludge, worldwide there are common issues that act in favour of new ways of handling and treating human waste. In dealing with sludge from septic tanks and latrines, transport is often the main cost, whilst existing disposal and treatment plants are often

dysfunctional and pose a threat both to the health of operators and the environment. Vacuum trucks emptying septic tanks too often discharge sludge direct into the environment, partly due to a lack of regulation and a lack of incentives for the private (and public) sector to deal adequately with waste.

One way of getting round these issues is to decentralise the treatment of wastewater coming from septic tanks, a system advocated by the NGO BORDA. These systems can localise the treatment of waste and eliminate the need for external (costly) energy inputs to the process. Indeed they can generate energy via biogas (the waste from 100 households can generate enough gas to meet 10 households' needs).

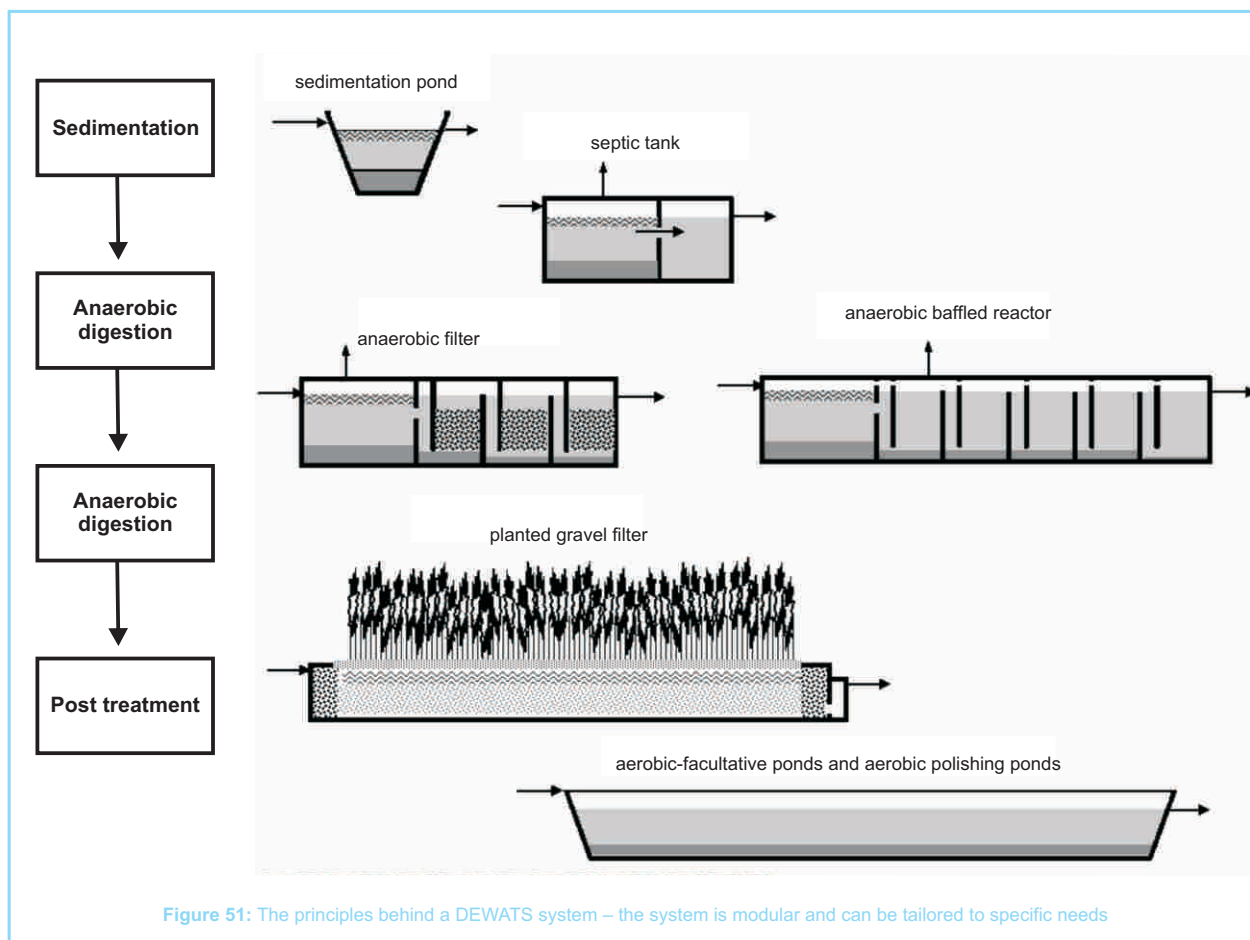

There are now approximately 100 000 systems working on similar principles operational worldwide (up from 20 000 or so in 1983).

Since 2005 BORDA has taken some of these principles and applied them to plants designed to treat municipal sludges. The advantages of doing so are several: it uses 50% of the space of normal ponds, it does not require outside energy and is a closed system that is easy for entrepreneurs and municipalities to run. A current system in place can accept the equivalent of 18 trucks per day (at an investment cost of about \$2000-\$3000 USD to cope per m³ of septic tank wastewater brought in – which, in Indonesia, relates to roughly \$150 USD per person). An interesting incentive system applies to one Indonesian plant – rather than trucks being paid in cash by households, they are given tokens (that householders purchase from the municipality). These tokens are only redeemed once the truck operator deposits their load at the treatment plant – which overcomes the perverse incentives that lead to illegal dumping elsewhere. Such a system also permits easy management of any subsidies that may be introduced.

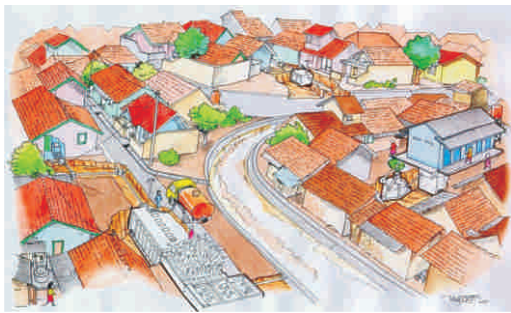

Figure 52: Schema showing how a DEWATS plant may function within a community

One advantage of anaerobic systems such as DEWATS, is that they are more robust than aerobic systems and can handle 'batch' loading better. Yet sensitivities remain as the micro-organisms need to be 'fed' – so systems take poorly to idling for two weeks, for instance. DEWATS systems, of which there are 500+ in Indonesia, still produce sludges, which after solar drying can be used for agricultural compost (tests are still being run on issues such as pathogen survival rates, safety of use etcetera. Tree nurseries are an ideal and safe use). An advantage of decentralised systems is that the source of the sludge is known, which opens up alternative pathogen management strategies (for instance, it may be cheaper to provide an 'upstream' deworming programme than ensure 'downstream' that all *Ascaris* eggs are fully destroyed).

Contact: Stefan Reuter, E: reuter@borda.de

Where to go for further information (web):

See www.borda-sadc.org, for instance
www.borda-sadc.org/fileadmin/borda-net/Service_Packages/O2MSTP_web.pdf

19. Implications for local government of faecal sludge management

Jay Bhagwan: WRC

WRC started to look at the issue of FSM five years ago and to think about the implications for local government. They concluded that there is not only a need to “re-engineer the toilet, but also how we go to the toilet”. Hence some of their interest in dry sanitation as well finding ways of working with communities on behaviour change and other issues (such as the need to keep rubbish out of pits).

One of the key learning points to emerge is that pit sludge is not only infective but remains so for long periods. We must understand this and its consequences, seeking to eliminate the risk of dealing with (and reusing) sludge.

Consequently it is important that we design from the beginning for operations and maintenance (O&M) and not be swayed by political considerations that are driven by other considerations. We must also guard against civil engineering 'over-design' which has been a particular plague in South Africa. For instance, keeping pits small would enable easier emptying.

Beyond this, we should not fear permitting small amounts of water from entering the pit – perhaps we can better design systems that can accept small amounts of greywater (and therefore be more ergonomic and tailored to household needs). Fluidising waste can help with its 'suckability' and offer the promise of easier emptying.

It is also clear that a range of appropriate on-site and treatment systems exist, but these are not always promoted in a way that local governments and others can make informed decisions. It is important for local government to consider a range of systems and not necessarily prioritise 'high-end' civil engineering systems.

Annex A

Seminar Programme

Registration of Participants	8.30-9.00
Opening Session: Introduction (Moderator: David Still)	
Introduction and welcome to eThekweni.	
- Neil Macleod: Head of eThekweni Water Services	9.00–9.15
What happens when the pit is full? A trillion dollar question, and an urgent one.	
- Jay Bhagwan: Water Research Commission	9.15–9.35
Sanitation for the billions. Making it work in the global context.	
- Steven Sugden: London School of Hygiene and Tropical Medicine	9.35–10.00
The future of on-site sanitation. Beyond the cesspit.	
-Professor Chris Buckley: Pollution Research Group, UKZN	10.00-10.20
Tea	10.20-10.45
Session 2: Inside the pit (Moderator: Chris Buckley)	
How fast do pits and septic tanks fill up? Implications for design and maintenance.	
- Kerstin Wood and Dr Kitty Foxon: Pollution Research Group, UKZN	10.50-11.10
What is going on inside pits and septic tanks? The science of sludge decomposition.	
- Dr Kitty Foxon: Pollution Research Group, UKZN	11.15-11.35
Sludge under the microscope. The Ascaris story.	
- Colleen Archer: Biological Science, UKZN	11.40-12.00
Magic Muthis. Can biological additives make the problem go away?	
- David Still: PID with Dr Kitty Foxon: UKZN	12.05-12.30
Lunch	12.30-13.30
Session 3: Getting what's inside outside (Moderator: John Harrison)	
What you need to know about emptying pits and tanks with vacuum tankers, large and small.	
- Manus Coffey: UN-Habitat	13.35-14.30
In Search of Innovations in Pit Emptying.	
- Steven Sugden: LSHTM	14.35-15.00
Experience with pit emptying in the Eastern Cape: the Franchise Model.	
Oliver Ive: Amanzabantu and Kevin Wall: CSIR	15.05-15.25
Tea	15.30-15.50
Session 4: Mechanised emptying for SMMEs (Moderator: Jay Bhagwan)	
The quest for sustainable sanitation in Cambodia.	
- Jared Wood: International Development Enterprises (IDE)	15.55-16.25
The PETshop toys. Of eVacs, Nanovacs and PSAs.	
- David Still: PID	16.30-17.00

Session 5: Grasping the nettle – eThekweni’s Pit Emptying Programme (Moderator: Kitty Foxon)

Lessons from eThekweni’s Pit Emptying Programme – from pilot to full scale.

- Dave Wilson: eThekweni Water Services 8.30–8.55
Sludge disposal in eThekweni. Reviewing the options.
- John Harrison: eThekweni Water Services 9.00-9.25
Simple sludge disposal with benefits? Deep-row entrenchment with agro-forestry.
- David Still: PID and Craig Taylor: UKZN 9.30-9.55
First do no harm: how do we protect the workers and the public during the process?
- Dr Nicola Rodda: UKZN Biological Sciences 10.00–10.20

Tea

10.20-10.45

Session 6: The sludge disposal issue (Moderator: Chris Buckley)

The critical cost consideration. Sludge transfer and transport.

- Manus Coffey: Sludge Management Consultant 10.50-11.15
Human waste: for how long can we afford to throw it away?
- Prof. Chris Buckley: University of Kwa Zulu Natal 11.25-11.50
Experience with Urban Sludge Treatment in Indonesia
- Stefan Reuter: Borda 11.55-12.25
The challenge of on-site faecal sludge management: Implications for local government.
- Jay Bhagwan: WRC 12.30-12.40

Lunch

12.45-13.45

FIELD VISITS

Option 1: South to Umlazi to see Deep-Row Sludge Entrenchment / Agroforestry Trial Site and demonstration of various pit emptying technologies

Option 2: North to Tongaat to Pit Sludge Pelletizing Machine and visit to DEWATS plant and permaculture centre

Return to Hotel

13.45-16.30

16.30

Annex B

NAME	SURNAME	COMPANY/ORGANISATION	EMAIL
Johannes	Adams	City of Cape Town	
Hylton	Alcock	Insight eThekweni	
Nick	Alcock	Khanyisa Projects	nick@khanyisapr.co.za
Colleen	Archer	University of KwaZulu Natal	archerc@ukzn.ac.za
Linda	Baas	Frisian Urban Sanitation Programme	linduinabaas@gmail.com
Babatunde	Bakare	University of KwaZulu Natal	206502332@ukzn.ac.za
Sakhiwo	Balfour	Amathole DM	sakhiwob@amatoledm.co.za
Susan	Barclay	University of KwaZulu Natal	suebar@iafrica.com
Keith	Bennett	Talbot & Talbot	
Markus	Berger	Sud Chemie	markus.berger@sud-chemie.com
Jay	Bhagwan	Water Research Commission	jayb@wrc.org.za
Mfundu	Biyela	Envirosan	
Steffen	Blume	Gesellschaft fur Internationale Zusammenarbeit	steffen.blume@giz.de
Chris	Buckley	University of KwaZulu Natal	BUCKLEY@ukzn.ac.za
Chimulambe	Chimulambe	TM Associates - NWDP Sanitation	eliaschimulambe@iafrica-online.net
Manus	Coffey	Manus Coffey Consulting	manuscoffey@eircom.net
Milne	Conwright	Uthukela Water	ilne.crown@uthukelawater.co.za
Luqmaan	Cornelius	City of Cape Town	
Ruth	Cottingham	Care	ruthcottingham@googlemail.com
Piers	Cross		piers.cross@gmail.com
Craig	Daniel	Envirosan	info@envirosan.co.za
Nathalie	Fernandes	Talbot & Talbot	nathalie@talbot.co.za
George	Forder	Partners in Development	george@spindrifft.co.za
Kitty	Foxon	University of KwaZulu Natal	Foxonk@ukzn.ac.za
Paul	Gaydon	SSI	paulg@ssi.co.za
Mukosayi	George	Mulonga Water & Sewerage Comopany	
Ronald	Gillmer	Uthukela Water	ronald.gillmer@uthukelawater.co.za
Ezio	Gori	E Gori & Associates	
Teddy	Gounden	Ethekweni Water Services	teddygo@dmws.durban.gov.za
Kamethran	Govender	University of KwaZulu Natal	
Xavier	Gras	Practica Foundation	xavier.gras@practica.org
Johannes	Haarhoff	University of Johannesburg	jhaarhoff@uj.ac.za
Ndila	Hamalambo	Southern Water & Sewerage Company	
John	Harrison	Ethekweni Water Services	johnha@dmws.durban.gov.za
Peter	Hawkins	WSP	phawkins@worldbank.org
Dave	Hawksworth		dave.sanafrica@hotmail.com
Elisabeth-Maria	Huba	Technologies for Economic Development	elisabeth@ted-biogaz.org
Oliver	Ive	Amanz'abantu	oliver@aserve.co.za
Gert	Jacobs	Johannesburg Water	gjacobs@jwater.co.za
Nico	Jonker	Amathole DM	nico@amatoledm.co.za
Josef	Kafuko	Devolution Trust Fund	
Loreen	Katiyo	Institute of Water & Sanitation Devel	lkatiyo@iwsd.co.zw
Nombuso	Khuluse	Dept of Human Settlements	nombusokh@webmail.co.za
Bongani	Khumalo	Department of Education	
John	Kings	Tsongang Water and Sanitation	

Mary	Kings	Tsogang Water and Sanitation	johnkings@tzaneen.co.za
Frank	Kirwan	Irish Aid	
Troels	Kolster	Frisian Urban Sanitation Programme	troelskolster@gmail.com
Mantopi	Lebofa	Technologies for Economic Development	mantopi@yahoo.com
Brian	Lewis	Envirosan	info@envirosan.co.za
Claire	Lipsett	Talbot & Talbot	claire@talbot.co.za
Bobbie	Louton	Partners in Development	bellway@gmail.com
Ramasedi Elias	Mafoko	Dept of Basic Education	mafoko.radbe.gov.za
Ditshego	Magoro	Win-SA	ditshegom@win-sa.org.za
Joseph	Magoya	Water for People	Jmagoya@waterforpeople.org
Belinda	Makhafola	Dept of Health	makhaB@health.gov.za
Hasani	Makhubela	Dept of Human Settlements	hasani.makhubele@dhs.gov.za
Solomon	Manyisa	Dept of Water Affairs	manyisas@dwa.gov.za
Maria	Masemola	Limpopo Business Support Agency	mariam@libsa.co.za
Thembi	Masilela	Govan Mbeki Municipality	thembi.m@govanmbeki.gov.za
Valdemiro Bernado	Matavela	National Directorate of Water	matavald@dnaguas.gov.mz, matavald@gmail.com
Bernard Rapule	Matsane	Limpopo Dept of Education	MatsaneBR@edu.limpopo.gov.za
Ronald	Matukane	Dept of Human Settlements	matukaner@dwa.gov.za
Christopher	Maunda	CPUT	muandac@cput.ac.za
Annekatrien	Mayer	Borda	a.mayer@borda-sadc.org
Reuben	Mbedzi	Limpopo Business Support Agency	mbedzi@libsa.co.za
Hlazo	Mchumane	Dept of Water Affairs	hlazom@dwa.gov.za
Gabriel	Menezes	Department of Education	
Marina	Milstein	Dept of Water Affairs	milsteinm@dwa.gov.za
December	Miya	Govan Mbeki Municipality	december.n@govanmbeki.gov.za
Bhekithemba	Mlambo	Department of Education	bhekithemba.mlambo@kzndoe.gov.za
Sandile	Mngadi	Uthungulu DM	
Oaphela	Moatole		
Takalani	Modau	Dept of Water Affairs	modaut@dwa.gov.za
Gomolemo	Mokete	Southern African Regional Environmental Programme	gmokete@bergstan.co.bw
Gillian	Moloto	Lepelle Northern Water	gillianm@lepelle.co.za
Speedy	Moodliar	Ethekweni Water Services	
William	Moraka	SALGA	wmoraka@salga.org.za
William	Mosefowa	DWA	
Viv	Mostert	Viv Mostert & Associates	
Reginald	Mpe	Limpopo Business Support Agency	reggiem@libsa.co.za
Ednick	Msweli	Ethekweni Water Services	ednickms@dmws.durban.gov.za
Bryan	Mthembu	Partners in Development	
Nelisiwe	Mthembu	Department of Education	Pberridge@mhlathuze.co.za
Siduduzo	Mtshali	Ethekweni Water Services	sidudumth@dmws.durban.gov.za
Kutlwano	Mukokomani	Kalahari Conservation Society	kutlwano@kcs.org.bw
Sheleni	Mukosa	Bosch Projects	
Morgan	Muleya	North-Western Water & Sewerage Company	
Farusani	Mutavhatsindi	Makhado Municipality	mayor@makhado.co.za
Sagren	Narasimulu	Makhaotse, Narasimulu & Assoc	snarasimulu@mna-sa.co.za
Carl	Nel	Bosch Projects	floydj@bproj.co.za
Mfuneko	Ngqoyiyana	Chris Hani DM	mngqoyiyana@chrishanidm.gov.za
Freddy	Nkambule	Govan Mbeki Municipality	freddy.n@govanmbeki.gov.za
Thabo	Nkosi	Department of Education	
Ndzaliseko	Ntebe	Dept of Human Settlements	nteben@dwa.gov.za
Mxolisi	Ntleki	Dept of Human Settlements	ntlekim@dwa.gov.za

Jaime	Palalane		jpalalane@gmail.com
Bernard	Phiri	Kafubo Water & Sewerage Company	
Theo	Pienaar	Envirosan	info@envirosan.co.za
Sibusiso	Potwana	Dept of Human Settlements	potwanas@dwa.gov.za
Robbie	Prior	Envirosan	info@envirosan.co.za
Dhamendra	Ragoonandan	Msunduzi Municipality	dhamendra.ragoonandan@msunduzi.gov.za
Mangie	Rakale	Dept of Human Settlements	mangie.rakale@dhs.gov.za
Mushaisano	Ramusetheli	Polokwane Municipality	mushair@polokwane.gov.za
Stefan	Reuter	Borda	reuter@borda.de
Nicola	Rodda	University of KwaZulu Natal	roddan@ukzn.ac.za
Kate	Roper	Inkanyezi Initiative cc	
John	Sarng	Mvula Trust	john@mvulaptb.co.za
Salome	Sathekge	Polokwane Municipality	salomes@polokwane.gov.za
David	Schaub-Jones	Win-SA / BDP Water & Sanitation	daidschaubjones@gmail.com
Dakalo	Serite	Polokwane Municipality	DakaloS@polokwane.gov.za
Simanga	Shange	WSSA	sshange@wssa.co.za
Moses	Shasha	Ngcobo Municipality	mshasha@chrishanidm.gov.za
Nompumelele	Shezi	Amathole DM	mpumelelos@amatole-dm.co.za
Herman	Shokane	Dept of Human Settlements	shokaneh@dwa.gov.za
Nonceba	Sineke	Dept of Water Affairs	sineken@dwa.gov.za
Jimmy	Singh	Uthukela Water	jimmy.singh@uthukelawater.co.za
Mbongeni	Sithole	UKZN	
Nathi	Sithole	Dept of Human Settlements	nombusokh@webmail.co.za
Don	Spiers	Conloo	
David	Still	Partners in Development	dave@pid.co.za
Lindi	Still	Partners in Development	lindi@pid.co.za
Steven	Sugden		
Wade	Swannell	Goba Consulting Engineers	wades@goba.co.za
Craig	Taylor	University of KwaZulu Natal	205518269@ukzn.ac.za
Riana	Terreblanche	Envirosan	info@envirosan.co.za
Uahorekua	Usurua	Ministry of Rural Water & Sanitation	usuruau@africaonline.com.na
Dorothy	Visagie	Envirosan	info@envirosan.co.za
Gideon	Visser	WSSA	gvisser@wssa.co.za
Kevin	Wall	CSIR	kwall@csir.co.za
Rowan	Whittington	Talbot & Talbot	rowan@talbot.co.za
Dave	Wilson	Ethekweni Water Services	davewi@dmws.durban.gov.za
Jared	Wood	International Development Enterprises - Cambodia	jwood@ide-cambodia.org

Annex C: Sources and websites for more information

Various outputs and reports dealing with faecal sludge management can be found on the WRC website: <http://www.wrc.org.za>

Seminar presentations can be found on the SAKNSS website: <http://www.afrisan.org.za>

For issues of deep-row entrenchment & agroforestry: <http://www.biosolids.com.au/> & http://www.naturalresources.umd.edu/Publications/BiosolidResearch/Biosolids_Overview.pdf

For discussion of 'peak phosphorus': www.energybulletin.net/node/45534 & www.phosphorusfutures.net/peak-phosphorus

For discussion of pit emptying techniques and challenges, including information on the ePLEP programme in Durban and common practise in Nairobi: 'Sanitation Partnerships: Bringing pit emptying out of the darkness': www.bpdws.org/bpd/web/d/doc_131.pdf?statsHandlerDone=1

For information on Ascaris monitoring see: <http://www.wrc.org.za/Pages/DisplayItem.aspx?ItemID=3627> & <http://www.wrc.org.za/Pages/DisplayItem.aspx?ItemID=8871> & www.wrc.org.za Report: TT 322/08

For information on Pit Emptying Systems: http://practicalaction.org/practicalanswers/product_info.php?products_id=395 & <http://www.unhabitat.org/categories.asp?catid=548>

For information on sanitation marketing: http://www.lboro.ac.uk/well/resources/fact-sheets/fact-sheets-htm/Sanitation_marketing.htm

About health risk assessments: www.ewisa.co.za/literature/files/173%20Rodda.pdf

On the design and operation of ventilated improved pit latrines (VIPs) & pit latrine additives.

Water Research Commission Report No. TT 357/08, ISBN 978-1-77005-718-0: www.wrc.org.za

About the physical and health-related characteristics of UD/VIDP vault contents: <http://www.wrc.org.za/Pages/DisplayItem.aspx?ItemID=7926>

For transportation aspects see: UN Habitat 'Collection of Municipal Solid Waste in Developing Countries' www.unhabitat.org

On the Great Stink of London that finally persuaded investment in competent sanitation authorities in London. Read more at: www.martinfrost.ws/htmlfiles/great_stink.html

Miscellaneous other websites:
<http://www.makingsanitationeasy.com/>
<http://www.ide-cambodia.org/>
www.borda-sadc.org & www.borda-sadc.org/fileadmin/borda-net/Service_Packages/02MSTP_web.pdf

About SAKNSS

The Southern Africa knowledge node on sustainable sanitation aims to fast track and accelerate the delivery of sanitation through sustainable solutions. The node aims to facilitate and coordinate capacity and skills development, knowledge sharing and collaboration.



Southern Africa knowledge node on sustainable sanitation



The website aims to facilitate collaboration and information sharing among stakeholders in the SADC region. It serves as a SADC gateway to sustainable sanitation information. The website is the first regional website with dedicated on sustainable sanitation information. We encourage our stakeholders to register on the website and share with us any documents that will contribute to knowledge sharing and capacity building in the region.

The SAKNSS website consists of:

Document management system

The SAKNSS document management system is a user friendly component that allows users to search documents by Document Type, theme, country, keyword and advanced search

Benefits for members:

- Link and exchange information with peers
- Access to new information and experience
- Practical support and capacity building
- Lessons learned
- Analysis of policies and sector trends
- Documentation and sharing of best practice
- Facilitating platforms for sustainable sanitation dialogue
- Awareness raising and Networking

www.afrisan.org

How to access SAKNSS items?

Users should first register their details before they can have full access to the SAKNSS items.

Contact management module

The contact management module provides an opportunity for the stakeholders to access their peers, contractors, suppliers, NGOs and government officials. It further allows stakeholders to advertise their own organisations/companies on the website.

Links database

The Links database provides access to organisations, private companies and government ministries working with the water and sanitation field.

SADC country information on sanitation

The country information page presents the status of sanitation in SADC countries with links to the responsible ministries and their contact details.



WINSA

Address: 491 18th Avenue, Rietfontein, Pretoria

Postal Address: Private Bag X03, Gezina, 0031

Tel: (012) 330 0340 **Fax:** (012) 331 2565

E-mail: info@win-sa.org.za

Website: www.win-sa.org.za

To know more about faecal sludge management
contact Director Water Use and Waste Management:
Mr Jay Bhagwan Tel: 012 330 9042
email jayb@wrc.org.za

What Happens When the Pit is Full?

Developments in on-site Faecal Sludge Management (SSM)

Seminar Report