



# DECENTRALISED SANITATION AND WASTEWATER TREATMENT

Revised 2<sup>nd</sup> Edition, January 2008



Second edition, January 2008

Layout, production and printing:

Bundesanstalt für Geowissenschaften und Rohstoffe

*Federal Institute for Geosciences and Natural Resources*

Stilleweg 2, 30655 Hannover, Germany

Phone +49 (0511) 643-0

Internet: [www.bgr.bund.de](http://www.bgr.bund.de)

Author: Torsten Krekeler, E-mail: [Torsten.Krekeler@bgr.de](mailto:Torsten.Krekeler@bgr.de)

Figures: Ulrich Gersdorf

Coordination Groundwater: Dr. Wilhelm Struckmeier

This brochure may be shared, copied, distributed, transmitted or translated, in part or as a whole, for non-commercial purposes and with attribution of the source as follows: Krekeler, T. Decentralised Sanitation and Wastewater Treatment. BGR, Hannover, 2008. You may not alter, transform, or build upon this work.

This brochure is available for download from the BGR homepage:

<http://www.bgr.bund.de/decentralised-sanitation-pdf>

# Table of Contents

1	Introduction .....	1
2	Dry sanitation.....	4
2.1	Dry toilets: modus operandi.....	5
2.1.1	Pit latrine .....	6
2.1.2	Dehydrating toilets .....	8
2.1.3	Composting toilets.....	10
2.2	Common dry toilet systems.....	12
3	Wastewater.....	16
3.1	Carbon.....	17
3.2	Biochemical oxygen demand BOD <sub>5(20)</sub> .....	17
3.3	Chemical oxygen demand COD.....	18
3.4	Total suspended solids TSS .....	18
3.5	Nitrogen N .....	18
	Ammonium NH <sub>4</sub> <sup>+</sup> -N .....	19
	Nitrate NO <sub>3</sub> <sup>-</sup> -N .....	19
3.6	Phosphorus .....	20
3.7	Other constituents .....	20
4	Wastewater treatment .....	21
4.1	Quality of treated wastewater.....	21
4.2	General wastewater treatment concept .....	23
4.3	Primary wastewater treatment (mechanical).....	25
	Septic tank .....	26
	Imhoff tank .....	28
	Settling pond.....	30

4.4	Secondary wastewater treatment (biological) .....	31
4.4.1	The process steps .....	32
	Carbon elimination .....	32
	Nitrification .....	33
	Denitrification .....	35
4.4.2	Methods without artificial aeration.....	36
	Waste stabilisation pond .....	36
	Anaerobic baffled reactor .....	39
	Anaerobic filter .....	40
	Constructed wetland .....	42
	Trench filter .....	44
	Filter tank .....	46
4.4.3	Methods using artificial aeration .....	48
	Activated sludge tank.....	48
	Fixed bed reactor .....	50
	Sequencing batch reactor (SBR) .....	52
	Trickling filter .....	54
	Biodisk.....	56
5	How to choose the appropriate technology? .....	58
6	Location selection .....	61
7	Common construction defects .....	62
8	References .....	63

# 1 Introduction

Presently, 1.1 billion people lack access to improved water supply and 2.6 billion to improved sanitation. In the vicious poverty/ill-health circle, inadequate water supply and sanitation are both underlying cause and outcome: invariably, those who lack adequate and affordable water supplies are the poorest in society (Cit. UNESCO World Water Development Report, 2006).

In 2002, the estimated mortality rate due to water sanitation hygiene-associated diarrhoeas and other water/sanitation-associated diseases was 57,029,000. A large part of those affected by water-related mortality and morbidity are children under five (Cit. UNESCO World Water Development Report, 2006).

The United Nations have declared 2008 as the International Year of Sanitation (IYS) to address this preventable tragedy by raising awareness for the global sanitation crisis which consists one of the major obstacles to human development in many developing countries. BGR, as the German implementation agency for development cooperation in the groundwater sector, addresses sanitation issues since long time in many projects from the angle of groundwater protection. Lacking or insufficient sanitation facilities threaten the quality of groundwater resources which provide drinking water to many people. The vicious circle of dissipating pollutants and contaminated drinking water is shown in the figure.

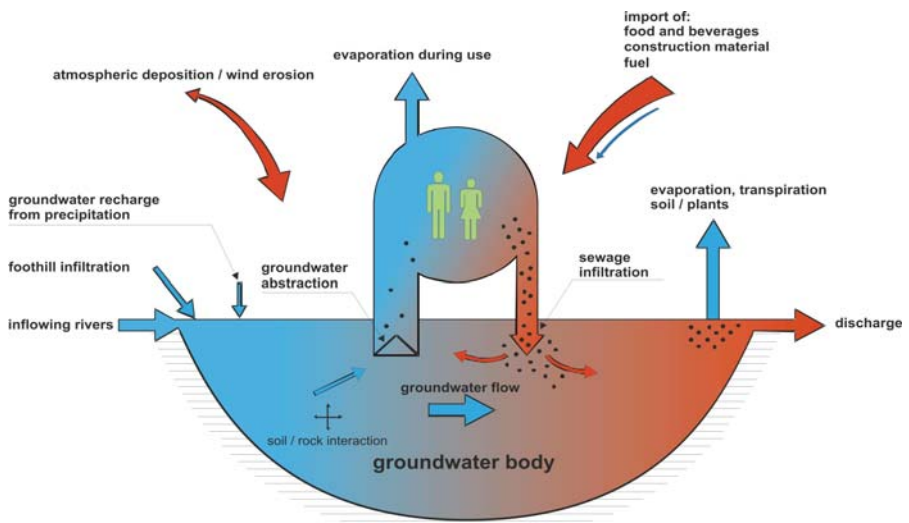

Safe and properly adapted sanitary practices are a key for protecting drinking water resources and preventing the spread out of water related diseases. The US Geological Survey found out that 70% of all wells in the Kabul basin are polluted by faecal bacteria. This constitutes a major reason for the enormous child mortality in Kabul where one of four children dies before its fifth birthday.

BGR compiled this brochure mainly based on its experiences from a groundwater protection project in Kabul which was implemented from 2003 to 2006. The brochure provides an overview on standard wastewater treatment methods using small scale sewage treatment units, as well as sanitary technologies which do not require water. The compilation of these methods shows how a great deal can be achieved by using less complex measures appropriately adapted to the circumstances as the highly technical wastewater treatment methods used in Northern countries has often proven not suitable for developing countries.

Dry toilet systems are presented in chapter 2 followed by a description of the constituents of sewage and each of the process steps required to breaking down these undesirable constituents (chapter three). The various

water based installations are outlined in chapter four. The methods range from highly technical to close-to-nature and simple sanitation technology options. Obviously, not all of the methods can be adapted for use under all circumstances. Some of the technical standards might be out of tune with the conditions prevailing in many developing countries. Therefore the informed choice about the adequate technical solution is crucial for the sustainability of a sanitation system.

## 2 Dry sanitation

When analysing different sanitation techniques it is essential to draw a big line between dry sanitation and water based systems.

The simplest form of dry toilets is the pit latrine. Other concepts are usually based on the use of dried or composted excrement and of untreated urine in agriculture. Urine contains the highest proportion of nutrients directly absorbable by plants. Faeces contain a large amount of organic carbon and because of their hygienic significance, should always be treated.

**The objective of dry sanitation is processing the materials to render them hygienically safe without destroying the nutrients.**

Removing pathogenic germs is the main hygienic target of dry sanitation. The following factors effect the survival of pathogenic germs:

Factor	Effect on pathogenic germs
Temperature	Rapid destruction at high temperatures (> 40°C)
	Strong multiplication at warm to moderate temperatures
	Inhibited multiplication but lengthy survival at low temperatures (< 5°C)
pH	Low pH leads to short survival times
	High pHs deactivate micro-organisms
	Very rapid sterilisation at pH > 12
	Sterilisation takes approx. 6 months at pH > 9
NH <sub>3</sub>	Ammonia leads to the deactivation of micro-organisms



Humidity	Moisture supports the survival of pathogens; most germs die off when dry
Sunlight	The survival time of micro-organisms is reduced when exposed to sunlight because of sensitivity to UV radiation
Other micro-organisms	Different types of micro-organisms compete and displace one another. Higher micro-organisms eat lower micro-organisms
Nutrient content	Intestinal bacteria are adapted to cope with nutrient excess, shortages of nutrients reduce their reproduction rates and considerably lower their chances of survival
Oxygen	Many pathogenic germs are anaerobic and are therefore displaced by other organisms in an aerobic environment.

(Esrey, 1998; Cave, Kolsky 1999; Winblad, 2004)

## 2.1 Dry toilets: modus operandi

Dry toilets can be divided into three basic types: **pit latrines, dehydrating toilets and composting toilets**. All three types share the same problems of having to remove odours and prevent flies from entering the collector tanks. It is very important to prevent flies from coming into contact with faeces and food as this constitutes a common route for the spreading of diseases.

Special applications like e.g. bucket latrines and overhung latrines are not described in this brochure as they are only suitable in exceptional circumstances.

## 2.1.1 Pit latrine

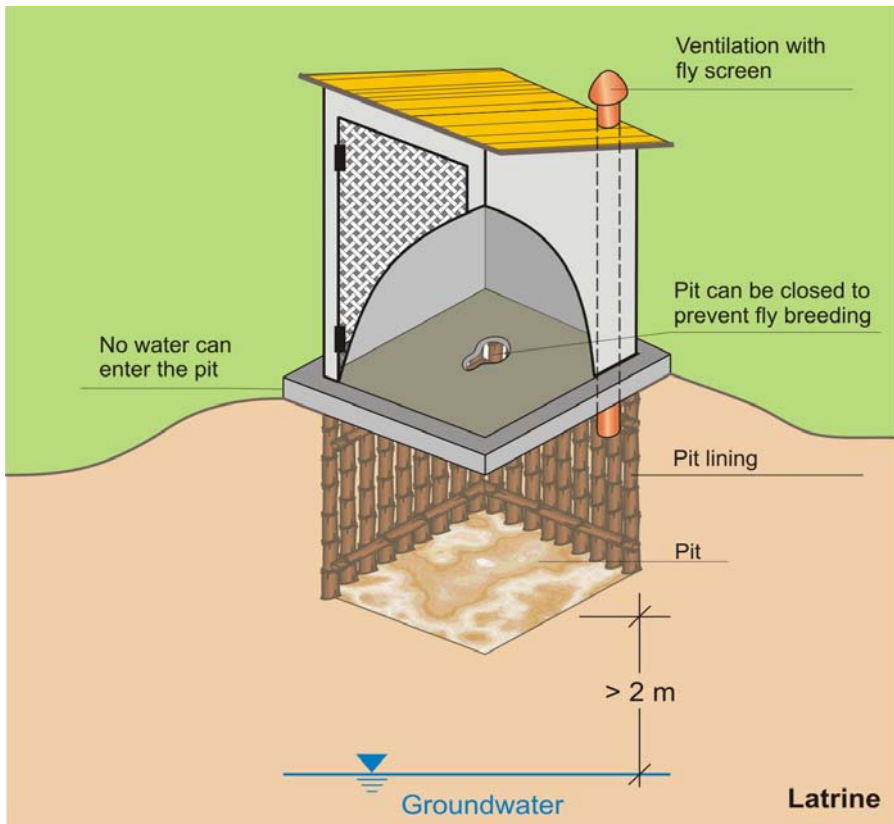

A pit latrine is a mean of directly disposing faeces in a hole in the ground. When the pit is full, the toilet is moved to a new hole and the old one is covered up. The faeces in the old hole are broken down by bacteria and soil organisms. In some cases the faeces are removed from the pit later on.

Unlike the more highly developed methods in dehydrating and composting toilets, the faeces in latrines are not stored in a closed system thus resulting in a risk to contaminate groundwater.

Pathogenic germs dissipating from latrines can be transported by groundwater to surrounding wells becoming a threat to the health of users.

For protecting groundwater resources it is fundamental to keep a vertical minimum distance between the bottom of the pit and the groundwater table. Percolating water moves particularly slowly in the unsaturated zone, meanwhile germs die off in the unsaturated zone during long retention times. The unsaturated zone therefore effectively protects underlying aquifers.

**It is very important that no water from external sources be allowed to enter the pit. Less liquid in the pit means less risk of groundwater contamination.**

**The larger the vertical distance between the base of the pit and the groundwater table the better the protection of the groundwater.** For most soil types a minimum distance of 2 m is recommended. (Ch.6, Location Selection)

**The horizontal distance between the latrine and a water point should be larger than 15 m.** (Ch.6, Location Selection)

**In areas with high groundwater levels or areas that are periodically flooded pit latrines are not suitable.**

A pit latrine is one of the simplest forms of sanitation facilities. The suitability of pit latrines strongly depends on the natural conditions. If groundwater is sufficient protected from leaching human wastes a pit latrine can represent a safe and cost-effective solution.

Further information:

Franceys, R., et al. (1992)

[http://www.who.int/docstore/water\\_sanitation\\_health/onsitesan/begin.htm#Contents](http://www.who.int/docstore/water_sanitation_health/onsitesan/begin.htm#Contents)

Cave, Kolsky (1999)

<http://www.lboro.ac.uk/orgs/well/resources/well-studies/summaries-hm/task0163.htm>

Cotton, A. (1998)

<http://www.lboro.ac.uk/departments/cv/wedc/publications/opsq.htm>

## 2.1.2 Dehydrating toilets

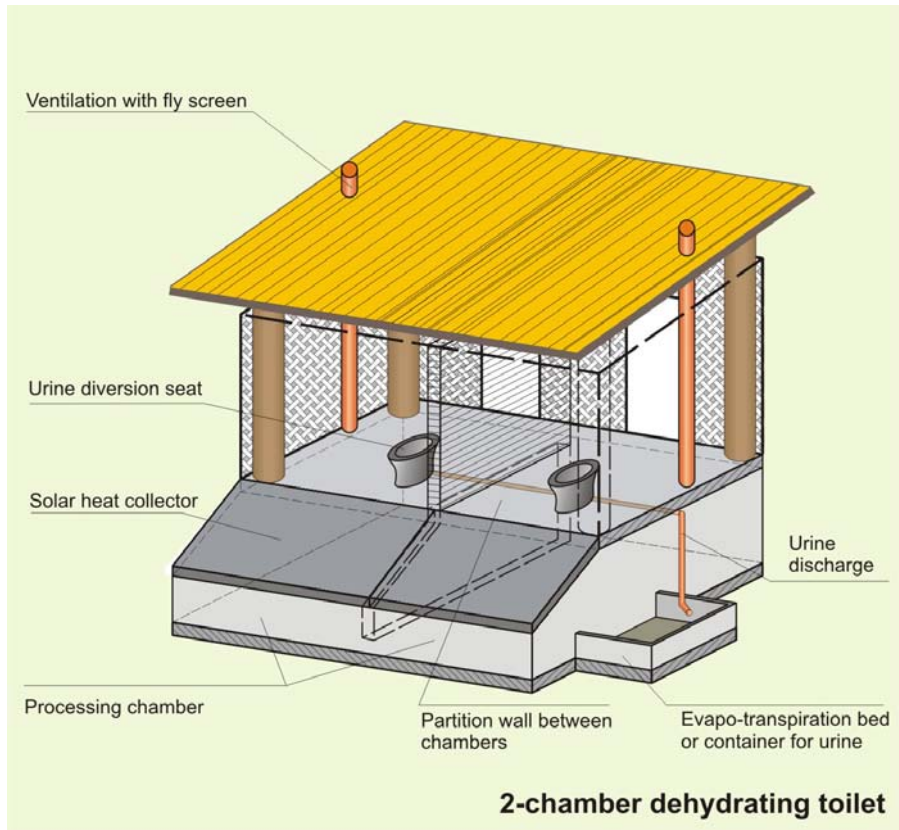

Dehydrating toilets can be installed in yards/gardens just like old-fashioned latrine. They can also be installed in houses.

Dehydration usually takes place at high temperatures. Good ventilation is required to remove the condensation. Urine and faeces are usually separated. To ensure the separation, toilet seats have built-in urine separators as shown in the picture. The processing chamber can be fitted with a flap which opens when someone sits on the toilet seat.



Source: Öko-Energie

The processing chamber and the way the urine is collected separately have any number of shapes and designs. They are dependent on various factors such as the type of soil and cultural habits.

Unlike composting toilets which are usually purchased as ready-made plastic toilets, dehydrating toilets usually come in the form of brick-built or wooden structures constructed by the owners on site.

Generally it makes sense for the processing chambers to be large enough to enable complete drying of contents. These contents can be directly spread on fields as fertilisers later on without any additional intermediate storage or treatment.

The system depends on maintaining dry conditions in the collector tank and therefore requires complete segregation of all liquids.

The flap to extract the dried faeces should face the sunny side and should be painted black to enhance drying.

Structural improvers and drying agents such as wood shavings or ash are regularly added to the processing chamber. Combustion is also possible in addition to using the dried faeces for fertiliser.

Dehydration kills off most of the germs but some more resistant ones can survive for long periods of time. Disinfection is primarily dependent on the pH and the drying time. Higher pH enhances disinfection by killing off bacteria. It is therefore beneficial to add lime or ash (Peasey, 2000).

Dehydration toilets are available in countless shapes. They have different advantages over pit latrines or water based systems: they are cheap in construction and operation; they represent closed systems that do not contaminate groundwater when properly operated. However, dehydration

toilets require appropriate operation and maintenance by users, otherwise they can lead to significant health danger when products are reused in agriculture.

Further information:

Winblad, U. et al. (2004)

[http://www.ecosanres.org/pdf\\_files/Ecological\\_Sanitation\\_2004.pdf](http://www.ecosanres.org/pdf_files/Ecological_Sanitation_2004.pdf)

Peasey, A. (2000)

<http://www.lboro.ac.uk/well/resources/well-studies/full-reports-pdf/task0324.pdf>

### 2.1.3 Composting toilets

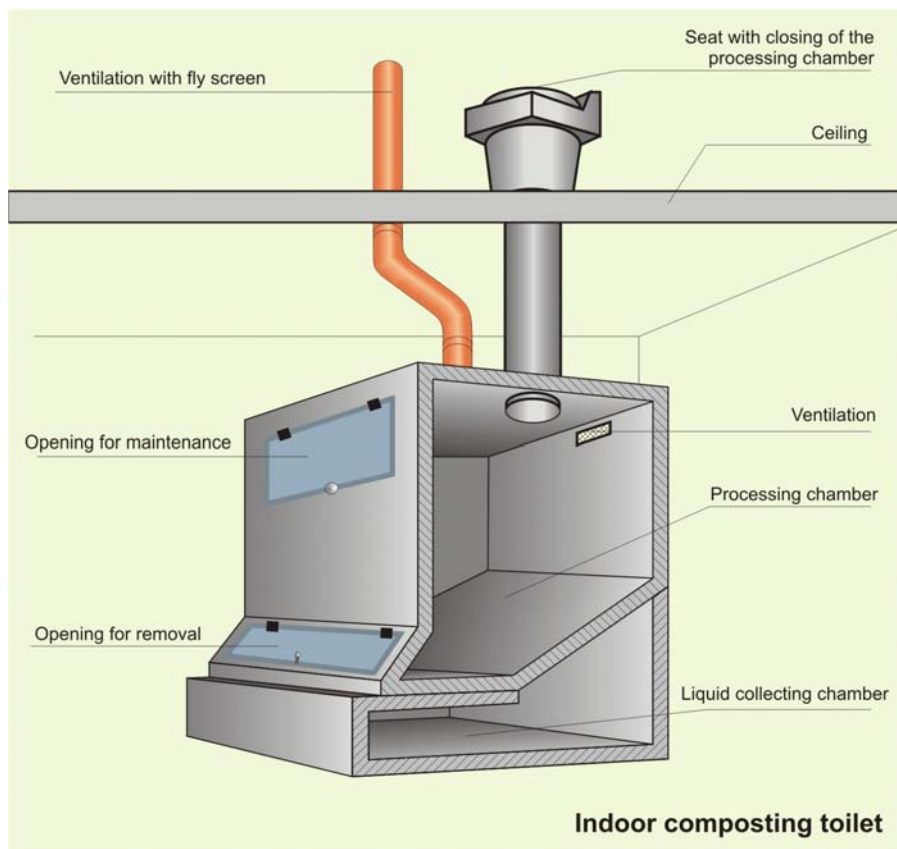

Composting is the aerobic decomposition of organic matter by micro-organisms and worms. The end products are carbon dioxide, water, heat and humus.

Composting can be divided up into three phases:

- Mesophile phase: lasts a few days, temperature 20 – 40°C
- Thermophile phase: lasts days to months, temperature 40 – 70°C
- Cooling down over several months

(Kunst, 2002)

The temperature in compost containers should always be above 15°C. All of the pathogenic germs are killed off at 50 – 60°C within a few days during composting. This process only takes a few hours at 70°C. However, high temperatures also kill off the composting worms and bacteria (Kunst, 2004). This slows down the decomposition process which means that cooling may be necessary to prevent this temperature being reached. The moisture content should ideally be 50 – 60 % (Kunst, 2002).

Urine is usually not separated out prior to composting.

Composting toilets can either be built on site or purchased in pre-fabricated form. Many products are also suitable for installing inside houses. The Swedish-built *Clivius Multirum* toilet is widely used in North European holiday cottages. These toilets contain a single composting container for faeces, urine and organic kitchen waste.

A general recommendation is to add structural material such as vegetable left-overs, straw or wood shavings. The composting container requires a suitable sealing system.

Composting in a new container can be speeded up by adding humus and possibly also earthworms. Composting containers should never be completely emptied because useful composting organisms would also be removed.

Further information:

Winblad, U. et al. (2004)

[http://www.ecosanres.org/pdf\\_files/Ecological\\_Sanitation\\_2004.pdf](http://www.ecosanres.org/pdf_files/Ecological_Sanitation_2004.pdf)

Peasey, A. (2000)

<http://www.lboro.ac.uk/well/resources/well-studies/full-reports-pdf/task0324.pdf>

## 2.2 Common dry toilet systems

There are countless different dry toilet systems which are often based on a combination of drying and composting. The many different systems available open up a whole range of applications, end products and properties.

The following table summarises the most common models and their most important properties. This list only includes a selection of available common products. Dry toilets can be constructed in any number of different designs to comply with the particular circumstances in each case.

<b>Dehydrating toilets</b>	<b>Characteristics</b>
Dry Ecological Toilet (Mexico)	2 chambers Seat with urine separation Pre-fabricated seat, the rest built on site Approx. € 150/unit Successfully used in various climatic zones
Vietnamese Dry Toilet	2 chambers No seat: 2 holes in the floor for squatting Urine separation: urine in container or percolating 2-3 steps high Addition of ash, soil or lime to improve drying Separate disposal of toilet paper Wooden lid above collecting tank When full, covered with earth and sealed with mud Needs to be emptied after 2 months



DAFF (Guatemala)	<p>2 chambers</p> <p>Seat with urine separation: urine in a tank</p> <p>Pre-fabricated seat, the rest built on site</p> <p>Addition of ash, soil or lime to improve drying</p> <p>The lid of the drying chamber is outside</p> <p>Retention time: 10 – 12 months</p> <p>€ 40 – 100/unit</p> <p>Good results in the slums of El Salvador</p>
Urine Diversion Dry Toilet (South Africa)	<p>1 chamber with 2 containers</p> <p>Seat with urine separation: urine percolates into the ground</p> <p>When first container is full, seal and use second</p> <p>Add ash for drying, No aeration or ventilation</p>
EcoSan (Ethiopia)	<p>2 chambers</p> <p>Urine separation with collecting container</p> <p>Built completely on site</p> <p>Add ash, soil, leaves, grass or saw dust</p> <p>Alternating use of both chambers</p> <p>Retention time: approx. 1 year, Approx. € 100/unit</p>
Single Chamber Dehydrating Toilet (Yemen)	<p>In-house toilet</p> <p>Urine separation: 2 downpipes: urine pipe outside, faeces pipe inside the house walls (several floors)</p> <p>Urine and grey water evaporate in the pipe, the rest percolates into the ground</p> <p>Dry faeces collected and used as fuel</p> <p>Hot dry climate speeds up drying</p>
Tecpan Solar Heated Toilet (El Salvador)	<p>1 chamber</p> <p>Solar heating</p> <p>Many pre-fabricated components, or as a complete system</p> <p>Added ash, soil or lime</p> <p>Mix up layers after 1-2 weeks</p> <p>Remove odourless dried faeces after 2-3 months</p>

<p>Two Chamber Solar Heated Composting Toilet (Ecuador)</p>	<p>2 chambers          No urine separation. Fast evaporation at high altitude          Addition of saw dust or ash          Ventilation in each chamber          Seat, lid and ventilation pre-fabricated, remainder built on site</p>
<p>Ecological Sanitary Unit (Mexico)</p>	<p>2 chambers          Urine separation and percolation into the ground          Completely fabricated in HDPE          Separate toilet paper disposal          Add ash, soil and lime in equal proportions to 0.5 kg/(Capita · day)          Higher pH by adding lime: good at killing germs          bad for crops</p>

<b>Composting toilets</b>	<b>Properties</b>
Clivius Multirum (Sweden)	1 chamber for toilet and kitchen waste No urine separation, Pipe for ventilation Completely pre-fabricated Suitable for cellar installation Add peat and humus before using for the first time Approx. 10 – 30 l compost produced per capita per year Emptied once per year
Sirdo Seco (Mexico)	2 chambers No urine separation, with solar heating Combination of drying and composting unit Moisture 40 – 60 % Temperature up to 70°C Completely pre-fabricated Composting takes approx. 6 months Emptying once per year
Carousel Toilet (Pacific Islands)	4 chambers consisting of fibre glass tanks Rotates around an axle (carousel) so that when one chamber is full, the next empty one can be rotated into place Electrical ventilation for drying Gravel drainage Tanks full after two years, contents can be used as fertiliser Aerobic operation requires addition of organic material, e.g. leaves or coconut fibres System requires very hot conditions

(Esrey, 1998; Winblad, 2004; Peasey, 2000)

### 3 Wastewater

If water is used to flush toilets, wastewater is generated. For one flush 3 - 9 l water is required. Wastewater from toilets is called black water while minor polluted wastewater from bath and kitchen is called grey water. Grey water is not containing excrement and therefore less infective than black water. In large scale wastewater collection and -treatment systems black and grey water is usually mixed. In decentralised systems it often makes sense not to mix these two different kinds of wastewater. The decision of mixing or not-mixing depends mainly on the type of treatment; this in turn depends on the expected use of the treated wastewater, the climate, the availability of electricity and technical equipment, etc.

Sources of wastewater constituents:

	<b>Grey water bath/kitchen</b>	<b>Urine</b>	<b>Faeces</b>
<b>Volume [l/(cap. · a)]</b>	25,000 - 100,000	500	50
<b>Nitrogen</b>	3 %	87 %	10 %
<b>Phosphorous</b>	10 %	50 %	40 %
<b>Potassium</b>	34 %	54 %	12 %
<b>COD</b>	40 %	10 %	50 %

Source: Geigy, Scientific tables Basel, volume 2. Fitschen and Hahn (1998)

Industrial and commercial effluent has a different composition and therefore in some cases needs completely different treatment compared with domestic wastewater.

### 3.1 Carbon

Carbon is organically bound in vegetable and animal matter, measured as TOC (Total Organic Carbon), DOC (Dissolved Organic Carbon), inorganic in the form of  $\text{CO}_2$ ,  $\text{HCO}_3^-$

Carbon concentrations are usually reported indirectly via the amount of oxygen required for oxidation (cf. BOD, COD). The German wastewater ordinance now includes a correlation factor to give a measure of the total amount of organic carbon:  $\text{TOC} / \text{COD} = 4$

### 3.2 Biochemical oxygen demand $\text{BOD}_{5(20)}$

BOD is the main evaluation parameter for the organic contamination of wastewater.

$\text{BOD}_{5(20)}$  describes the oxygen required over 5 days at a temperature of  $20^\circ\text{C}$  to oxidise the organic constituents of sewage. It consists of four sub-reactions:

- Substrate respiration of the bacteria during the physiological utilisation of the dissolved organic substance
- Endogenic internal respiration of the bacteria at the end of substrate respiration
- Respiration by higher micro-organisms (bacteriophages)
- Respiration by nitrifiers

(Hosang/Bischof, 1998)

Amount: A BOD of up to 60 g is generated every day by each inhabitant. This means that the concentration in untreated sewage corresponding to a water consumption of approx. 150 l/d is approx. 400 mg/l. In rural areas where water is scarce, BOD can be up to 1000 mg/l (Veenstra, et al. 1997).

### 3.3 Chemical oxygen demand COD

The chemical oxygen demand is the amount of oxygen required to oxidise all of the oxidisable constituents including those which are not biologically degradable. This figure is therefore always higher than the BOD. COD serves mainly as a makeshift for BOD as the evaluation of the latter needs 5 days, while COD is determined within some hours.

Amount: The maximum COD per capita is 120 g per day. The concentration in untreated sewage corresponding to a daily water consumption of 150 l is therefore approx. 800 mg/l. In rural areas where water is scarce, the figure can rise to approx. 2500 mg/l (Veenstra, et al. 1997).

### 3.4 Total suspended solids TSS

TSS is the summation parameter for suspended solids in the sewage. High amounts of suspended solids cause problems in open water bodies by increasing the turbidity, reducing the available light for light depending organisms.

Concentration: The specific production per capita amounts to 40 - 80 g/d (Veenstra et al. 1997). Assuming a daily water consumption of 150 l, the concentration in untreated wastewater is 250 - 550 mg/l.

### 3.5 Nitrogen N

Nitrogen stems particularly from urea and protein

Nitrogen is usually quoted as Total-N or as Kjeldahl-N the latter represents the sum of organically bound nitrogen and ammonium-nitrogen.

Conversion products:  $\text{NH}_3$ ,  $\text{NH}_4^+$ ,  $\text{NO}_2^-$ ,  $\text{NO}_3^-$

Concentration (Kjeldahl-N): One inhabitant generates maximum 12 g nitrogen per day. Assuming a water consumption of 150 l/d, this gives a concentration of 80 mg/l in untreated sewage. This figure often reaches up to 200 mg/l in rural areas (Veenstra, et al. 1997).

## Ammonium $\text{NH}_4^+\text{-N}$

The conversion of ammonium to nitrate is the first step in the nitrogen elimination chain. A high ammonium concentration in the sewage plant discharge indicates that nitrification is not functioning properly. This may be attributable to high levels of organic load in the plant (only organic carbon is oxidised) and also the faulty aeration and bad mixing and thus poor oxygen availability.

The non-toxic ammonium  $\text{NH}_4^+$  and the toxic ammonia  $\text{NH}_3$  are in equilibrium with one another. The balance is pH dependent.

$$\text{pH}7 : \frac{\text{NH}_4^+}{\text{NH}_3} = \frac{99}{1}$$

$$\text{pH}9 : \frac{\text{NH}_4^+}{\text{NH}_3} = \frac{70}{30}$$

In some literature  $\text{NH}_3$  is referred as unionised ammonia and  $\text{NH}_4^+$  as ionised ammonia.

When determining of wastewater, usually not the concentration of ammonium ( $\text{NH}_4^+$ ) is quoted, but the portion of nitrogen in the ammonium ( $\text{NH}_4^+\text{-N}$ ). The reason is an easier balance of different nitrogen appearances in the sewage. The conversion formula can be written as follows:  $\text{NH}_4^+ = \text{NH}_4^+\text{-N} \cdot 1.3$ .

Nearly all nitrogen in untreated sewage occurs as ammonium.

## Nitrate $\text{NO}_3^-\text{-N}$

Water discharged from a sewage treatment plant usually contains more nitrate than the inflowing water because untreated sewage contains nearly no nitrate. High nitrate concentrations in the discharge primarily indicate a high level of oxygen availability in the system and properly functioning nitrification. In addition, high nitrate concentrations in the discharge indicate that little denitrification is taking place.

When determining the quality of wastewater, usually not the concentration of nitrate ( $\text{NO}_3$ ) is quoted, but the portion of nitrogen in the nitrate content ( $\text{NO}_3\text{-N}$ ). The reason is an easier balance of different nitrogen appearances

in the sewage. The conversion formula can be written as follows:  $\text{NO}_3 = \text{NO}_3\text{-N} \cdot 4.4$ .

**The parameters  $\text{NH}_4^+\text{-N}$  and  $\text{NO}_3^-\text{-N}$  must always be considered in relation to one another. If for instance there are very small amounts of  $\text{NO}_3^-$  in the discharge from a treatment plant, this could either mean properly functioning denitrification or very poorly functioning nitrification.**

### 3.6 Phosphorus

Phosphorus enters into wastewater from detergents and excrement, as  $\text{PO}_4^{3-}$

Concentration: one person generates up to 2.5 g phosphorous per day. With average water consumption of 150 l/d this corresponds to a concentration of 17 mg/l, the concentrations in rural areas reaches up to 50 mg/l (Veenstra, et al. 1997).

Sewage also contains nutrient salts in the form of  $\text{K}^+$ ,  $\text{Ca}^{2+}$ ,  $\text{Fe}^{2+}$ ,  $\text{Fe}^{3+}$ ..., and trace elements.

### 3.7 Other constituents

**Toxins** have a negative effect on micro-organisms and are toxic to living things in water. They should not be present in domestic sewage. Intermediate products (metabolites) can be formed at certain stages of breakdown during the biochemical treatment of wastewater constituents. These metabolites can be more toxic than the original substances.

**Disruptive materials** include sand, oil and corrosive substances which disrupt the breakdown processes.

**Bacteria, viruses, protozoa and worms** can spread diseases and cause epidemics. Indicator: Coli bacteria.



## **4 Wastewater treatment**

When wastewater engineering was first implemented, it was limited to transporting contaminated water out of settlements. This simple but today inadequate solution aimed at protecting urban inhabitants from epidemics which proliferated in European cities in the previous centuries and claimed many lives.

The focus of wastewater treatment in most industrial countries today is on eliminating nutrients. The objective is to protect surface water and groundwater.

If sewage is to be used for irrigation, the main aim of wastewater treatment is to eliminate pathogenic germs. The nutrients are welcome in this case and used to fertilise crops.

### **4.1 Quality of treated wastewater**

The quality of treated sewage is often related to its expected use. Typical treated effluent standards applied in many countries are given in the following table.

Typical discharge standards in many countries

Parameter	Discharge in surface water		Discharge in sensitive water	Use in irrigation or aquaculture
	High quality	Low quality		
<b>BOD [mg/l]</b>	20	50	10	100
<b>TSS [mg/l]</b>	20	50	10	<50
<b>Kjeldahl-N [mg/l]</b>	10	-	5	-
<b>Total N [mg/l]</b>	-	-	10	-
<b>Total P [mg/l]</b>	1	-	0.1	-
<b>Faecal coliforms [No./100ml]</b>	-	-	-	<1000
<b>Nematode eggs/l</b>	-	-	-	<1
<b>Total dissolved solids (salts) [mg/l]</b>	-	-	-	<500

(Veenstra et al., 1997)

In Germany, the decomposition capacities of treatment plants have to comply with its dimension, measured as connected inhabitants. The larger the plant, the higher the decomposition capacity must be.

Maximum load of effluent from treatment plants in Germany [mg/l]

Inhabitants	BOD <sub>5</sub>	COD	NH <sub>4</sub> -N	Total N	Total P
< 1,000	40	150	-	-	-
1,000 - 5,000	25	110	-	-	-
5,000 - 10,000	20	90	10	-	-
10,000 - 100,000	20	90	10	18	2
> 100,000	15	75	10	18	1
<i>Input</i>	<i>400</i>	<i>800</i>	<i>80</i>	<i>80</i>	<i>17</i>

(BGBl. Abwasserverordnung, 2002)

## 4.2 General wastewater treatment concept

Various processes take place in special reactors, chambers or stages:

1. Separating out solids and suspended substances  
→ Primary (mechanical) wastewater treatment
2. Breakdown of dissolved organic sewage constituents by micro-organisms  
→ Secondary (biological) wastewater treatment

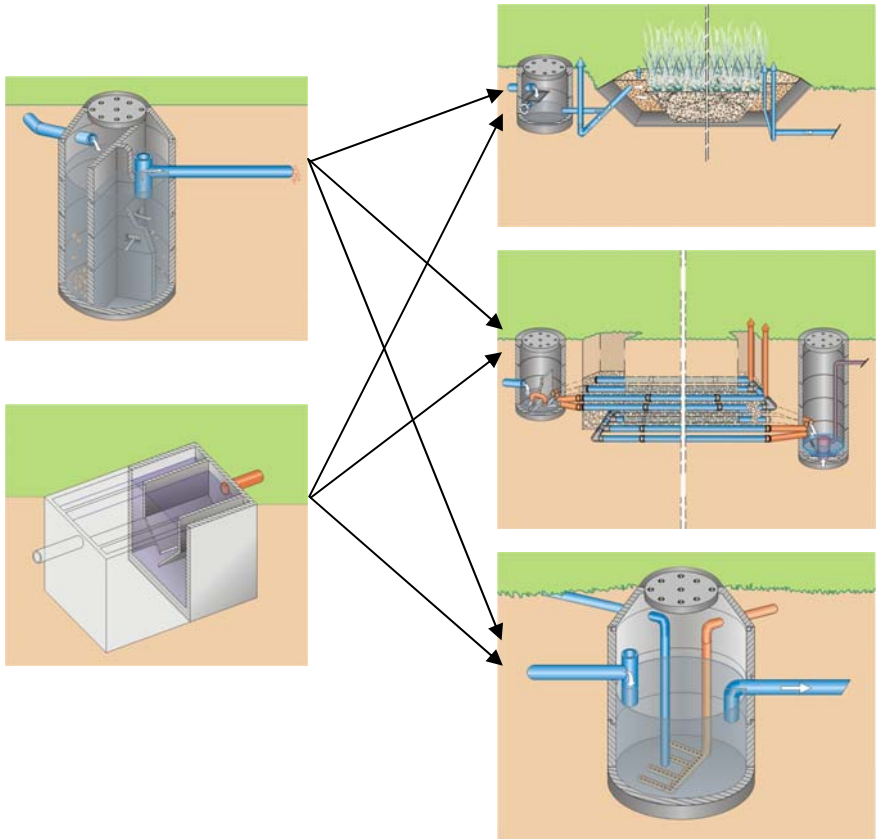

1. Primary treatment

2. Secondary treatment

As shown in a few typical installations in the figure, different types of reactors can be combined with one another. All of the arrangements follow a common principle: the first step in the treatment of sewage is to slow down its movement to enable the mechanical separation of coarse constituents before the pre-treated sewage is fed into a reactor for secondary treatment.

If micro-organisms are artificially kept in suspension (e.g. by an aeration system) a final settling chamber is necessary to enable the micro-organisms to settle out.

The treatment process must be considered as the sum of the mechanical and biological processes taking place in each reactor.

Installations are given for a wide range of sewage volumes: very small sewage treatment plants can be used to treat the wastewater from single buildings, while much larger treatment plants can accommodate the effluent from whole city districts.

### **4.3 Primary wastewater treatment (mechanical)**

Primary wastewater treatment is the first step in the treatment process. The aim of this stage is to separate out heavy constituents (suspended solids) and particularly light constituents (floating solids and scum) from the sewage. Movement of the sewage is reduced to a minimum to enable the solids to settle out. This is conducted in small-scale treatment plants via septic or digestion tanks, Imhoff tanks, or settling ponds.

## Septic tank

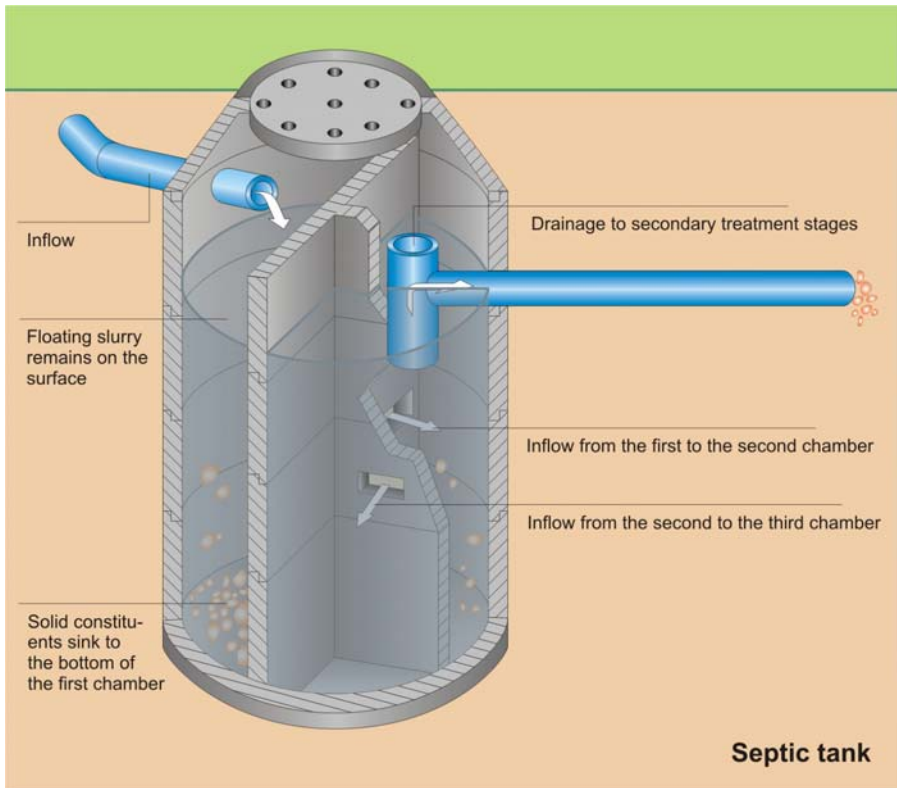

(Münster, 2002)

Septic tanks (or multi-chamber settling tanks) involve a varying number of chambers. In two-chamber tanks, the first tank must hold  $\frac{2}{3}$  of the total working volume. In three-chamber and four-chamber tanks, the first tank must hold  $\frac{1}{2}$  of the total working volume (Finke, G., 2001).

The working volume of septic tanks is strongly depending on the climatic conditions and the wastewater composition. A septic tank on household scale in the tropics which is designed to treat only toilet-wastewater can have a working volume of about  $1 \text{ m}^3$ ; while a septic tank in moderate climate which is containing the complete household wastewater may have

a working volume of about 6 m<sup>3</sup>.

A BOD reduction of 30 – 50 % can be achieved by settling the slurry in a septic tank (University Bremen, 2000).

The sludge from a septic tank must be disposed of every 2 - 5 years.

Further information:

Franceys, R., et al. (1992)

[http://www.who.int/docstore/water\\_sanitation\\_health/onsitesan/begin.htm#Contents](http://www.who.int/docstore/water_sanitation_health/onsitesan/begin.htm#Contents)

## Imhoff tank

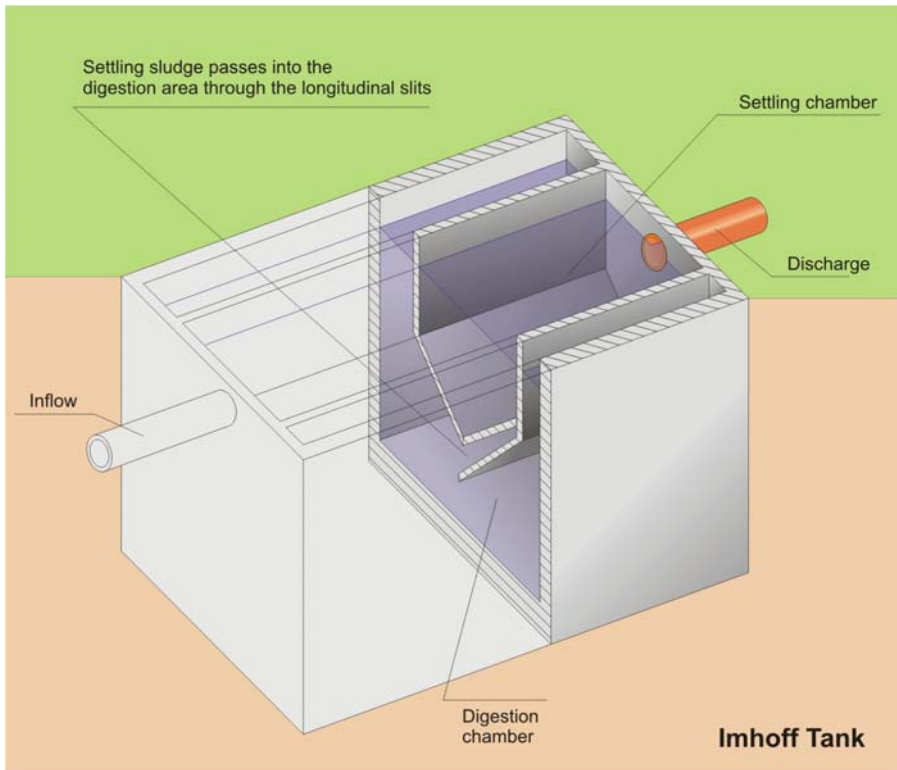

The Imhoff tank is a special form of multi-chamber tank. This method was patented as long ago as 1906. Because Imhoff tanks are not modern technology, no standard design method can be quoted. However, because of its major international significance, this method will be briefly described here.

The volume of the settling chamber should correspond to at least 50 l/capita. The volume of the sludge digestion chamber should be at least 120 l/capita (Sasse, L., 1998). An Imhoff tank serving the wastewater of one household has a working volume of at least 1 m<sup>3</sup>.

Wastewater flows horizontally through the settling chamber. The settling



chamber is underlain by a digestion chamber. The floor of the settling chamber is conical (45°) and has slits at the base. These slits constitute the boundary between the settling and the digestion chamber. Sludge that settles out passes through these longitudinal slits in the roof of the digestion chamber where it becomes compacted and digested. The digestion time is approx. 3 months. The BOD breakdown rate is 25 – 50 % (Sasse, L., 1998).

Rising scum and foul sludge that is formed during digestion is prevented from entering the settling chamber by the special conical design of the bottom of the settling chamber.

The displaced sludge water in this design is filtered by the newly settled sludge at the base of the settling chamber. This filters out the floating sludge flakes. The simple construction of the Imhoff tank and the low operating costs very quickly made it popular around the world (University of Bremen, 2000).

The large height of the tank is a significant disadvantage of the system.

Further information:

Sasse, L. (1998)

[http://www.borda-net.org/modules/wfddownloads/uploads/062%20BORDA\\_Dewats-Handbook.pdf](http://www.borda-net.org/modules/wfddownloads/uploads/062%20BORDA_Dewats-Handbook.pdf)

## Settling pond

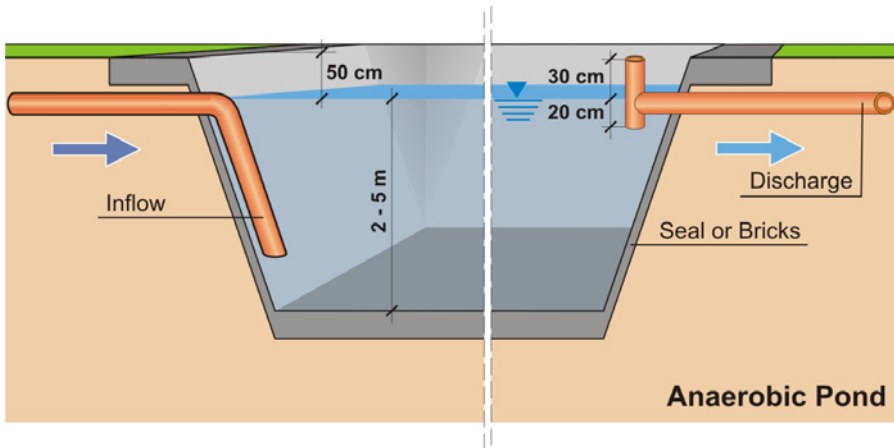

Settling ponds are used to separate out the suspended constituents in wastewater which can settle out. The sludge which settles out is then digested. In a temperate climate the dimensions are calculated using the formula  $\geq 500$  l/cap (Finke, G., 2001). In hotter climate the ponds often show smaller dimensions, e.g. after Sasse (1998) a sedimentation pond should provide a volume of approx. 200 l/cap. This corresponds to a hydraulic retention time of about one day. The depth of the settling and sludge zone should be 2 - 5 m.

The BOD reduction in temperate climate amounts to 20 – 50 %, or less at lower temperatures (University of Bremen, 2000). In hot climate BOD reduction can amount to 60 - 70 % (Mara, D., 1997).

The base of settling ponds should be sealed if the soil has a permeability of  $k \geq 10^{-8}$  m/s. Settling ponds create an odour nuisance and need to be securely fenced in (Finke, G., 2001).

The inflows and outflows need to be cleaned every year and the depth of the sludge needs to be measured. When the height of the sludge reaches  $\frac{1}{4}$  of the original water depth, it needs to be removed.

On top of the wastewater a scum layer is formed that prevent odour nuisance.

Further information:

Ramadan, H. et al. (2007)

<http://stabilizationponds.sdsu.edu/>

Mara, D. (1997)

<http://www.personal.leeds.ac.uk/%7Ecen6ddm/WSPmanualindia.html>

Sasse, L. (1998)

[http://www.borda-net.org/modules/wfdownloads/uploads/062%20BORDA\\_Dewats-Handbook.pdf](http://www.borda-net.org/modules/wfdownloads/uploads/062%20BORDA_Dewats-Handbook.pdf)

If primary sludge (sludge from mechanical stage of a treatment plant is just settled out and not fully stabilised, **it stinks, is unhygienic and contains high levels of organic material**. The sludge must always be treated. Sludge basins can be used for digestion of the organic matter. Digested sludge can usually be spread on fields as fertiliser.

#### **4.4 Secondary wastewater treatment (biological)**

Wastewater contains micro-organisms which live on the nutrients in the sewage and thus reduce the nutrient level.

The living conditions of these micro-organisms are maintained at the optimum level in biological wastewater treatment plants to maximise the micro-organism population and boost the decomposition capacity.

Organic carbon directly depletes the amount of oxygen in water (main proportion of BOD). Other nutrients such as phosphorous and nitrogen promote plant growth (eutrophication) and thus give rise to secondary oxygen depletion.

**The primary biological process which takes place is the elimination of organic carbon by bacteria.**

**Advanced effluent treatment involves the oxidation of ammonium to form nitrate (nitrification) and its subsequent reduction to molecular nitrogen (denitrification) – which leaves the treatment plant in the form of gas.**

**Simple, decentralised systems are usually not designed for the removal of ammonium and nitrate.**

#### **4.4.1 The process steps**

##### **Carbon elimination**

The breakdown of carbon is extremely complex. Carbon exists in numerous organic compounds which can be removed from wastewater by aerobic, anoxic and anaerobic processes.

As an example, the following shows the breakdown of glucose in extremely simplified form which takes place under the following conditions:

- Aerobic respiration:  $C_6H_{12}O_6 + 6 O_2 \rightarrow 6 CO_2 + 6 H_2O$
- Anoxic respiration:  $C_6H_{12}O_6 + 4 NO_3 \rightarrow 6 CO_2 + 6 H_2O + 2 N_2$
- Anaerobic fermentation:  $C_6H_{12}O_6 \rightarrow 3 CH_4 + 3 CO_2$

Organic substances are most extensively broken down during aerobic respiration. This process is also the fastest one (Sasse, L., 1998). Anoxic respiration plays a crucial role in nitrate reduction (denitrification). Anaerobic processes are quite effective in hot climate, especially associated with wastewater of high organic load (ref. ch. 5). The greatest advantage of anaerobic wastewater treatment is that it does not require electricity. On the other hand it is sometimes associated with major odour nuisances. However, anaerobic decomposition processes also generate methane which can be used as an energy source.

## Nitrification

Nitrification is the conversion of ammonium to nitrate. It is carried out in surface water and during biological wastewater treatment by nitrifying bacteria.

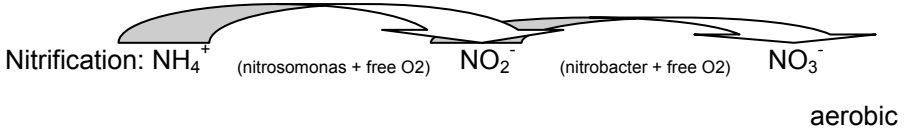

The ammonium oxidisers (nitrosomonas) convert ammonium into nitrite by bacterial oxidation. The nitrite oxidisers (nitrobacter) oxidise the nitrite formed by bacterial oxidation and convert it into nitrate. Ammonium and nitrate are electron donors.

Additional oxygen must be added to support the nitrification process.

Nitrification is dependent on various aspects including:

---

Temperature	Optimum between 28 – 36°C, nitrification is slowed down at temperatures below 12°C and stops at temperatures below 8°C
Dissolved oxygen	≥ 2 mg/l is necessary for nitrification
pH	Optimal pH between 7.5 and 8.3
Organic load	Treatment plants with high organic loads only oxidise carbon
Relevant substrate concentration	Higher concentrations of ammonium and nitrite lead to higher degradation rates
Potential inhibitors	Can impede nitrification
Contact time	The longer the contact time between nitrifying biomass and wastewater is the higher is the decomposition

---

(University of Bremen, 2000)

## Denitrification

Denitrification describes the ability of micro-organisms to reduce nitrate to molecular nitrogen. This process only takes place if there is no free oxygen available in the water (anoxic).

Denitrification:

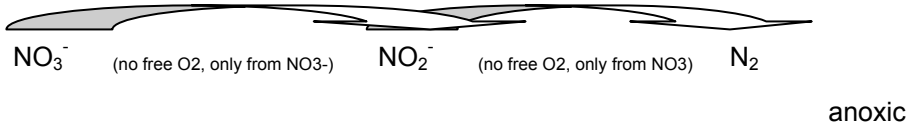

Denitrifiers can only break down nitrate to molecular nitrogen in the presence of organically-bound carbon which acts as an electron donor. This relationship is expressed in the ratio of  $\text{BOD}_5 : \text{NO}_3^-$  which should be around 4:1. If there is an inadequate amount of dissolved organic carbon in the wastewater, i.e. low  $\text{BOD}_5$  levels, decomposition can stop early at an intermediate stage. This can cause the accumulation of nitrate or nitrous oxide. This is undesirable. It is therefore important that the denitrifiers are constantly supplied with an adequate amount carbon (University of Bremen, 2000).

## 4.4.2 Methods without artificial aeration

### Waste stabilisation pond

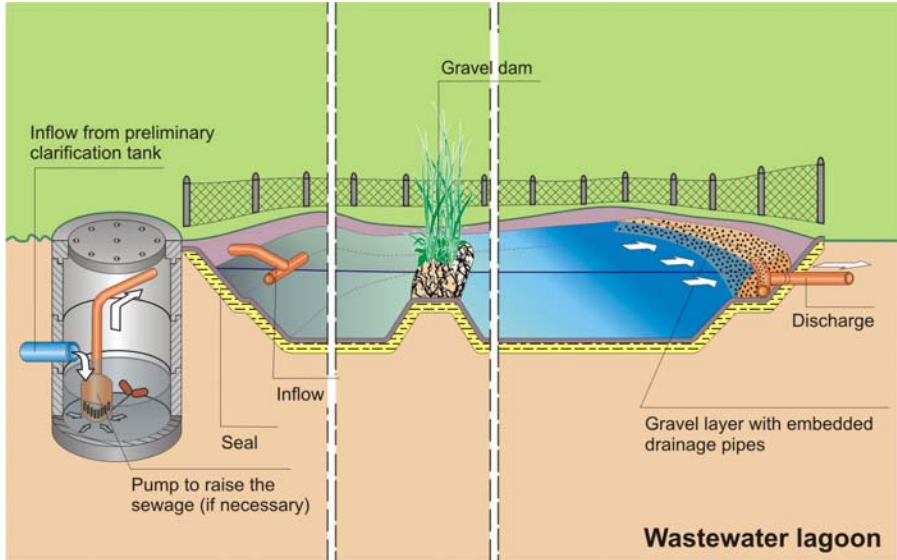

(Münster, 2002)

Treatment in waste stabilisation pond systems is carried out in different ponds. The use of the effluent is the main criteria for the constellation:

Discharge into surface water: - anaerobic pond  
- facultative pond

Irrigation: - anaerobic pond  
- facultative pond  
- maturation pond

**Anaerobic ponds** (see also ch.4.3) serve as a pre-treatment stage. They are small and deep (2 - 5 m). Anaerobic ponds provide space for about one day retention time and thus have a volume of about 200 l/cap. The BOD reduction can amount to 60 - 70 % in hot climate (Mara, D., 1997). On top of the wastewater a scum layer is formed that prevent odour nuisance.



**Facultative ponds** are 1 - 2 m deep and quite large. The main design parameter for BOD removal is the surface BOD loading (100 - 400 kg BOD/(ha·d) (Mara, D., 1997). A surface area of 10 - 20 m<sup>2</sup>/cap is common. In the upper region close to the surface aerobic conditions are predominant. On the ground settled sludge is digesting, here anaerobic conditions are prevailing. Some oxygen is taken up at the surface, but the majority of oxygen for BOD removal is generated by algal photosynthesis. In a well operating facultative pond alga contain the highest amount of BOD: faecal BOD is converted into algal BOD. So Alga must be prevented from discharging out of the pond system. Rock filters, grass plots, herbivorous fish and maturation ponds are common techniques to detain alga. Facultative ponds provide effluent that is mostly suitable for direct discharge into surface waters.

**Maturation ponds** are shallow (about 1 m) and significant smaller than facultative ponds. The primary function is the removal of pathogens. Maturation ponds are often necessary when treated wastewater is used for irrigation.

The ground in which any wastewater lagoons are constructed, should have a permeability (k-value) of  $\leq 10^{-8}$  m/s. Ground with higher permeability needs to be sealed off with impermeable sheeting which is then covered with sand.

The biological processes taking place in waste stabilisation ponds are temperature-dependent. Because of its large surface area, the external temperature has a significant effect on the ponds. Waste stabilisation ponds are therefore unsuitable for locations exposed to large temperature fluctuations. In hot climate they are quite well working and need significant smaller space than in colder climate.

A drawback of this method in urban areas is the large amount of space required and the non-optimal hygienic conditions. Possibly insects can multiply in waste stabilisation ponds and can therefore spread diseases and cause epidemics.

Past experience shows that the sludge only needs to be removed once every ten years (Finke, G., 2001).

An often successful practised variation of waste stabilisation ponds is duckweed based sewage treatment. When waste stabilisation ponds are used for fish farming, wastewater must be diluted, e.g. with river water. A description of some alternative systems can be found in (UNEP, 2004).

Waste stabilisation ponds can be understood as the most important treatment option for developing countries. Their main advantages are low investment and operation cost, long life, easy maintenance, minimal technical equipment, high effluent quality and optional recovery of resources: water, energy and humus.

Further information:

Ramadan, H. et al. (2007)

<http://stabilizationponds.sdsu.edu/>

Mara, D. (1997)

<http://www.personal.leeds.ac.uk/%7Ecen6ddm/WSPmanualindia.html>

Sasse, L. (1998)

[http://www.borda-net.org/modules/wfdownloads/uploads/062%20BORDA\\_Dewats-Handbook.pdf](http://www.borda-net.org/modules/wfdownloads/uploads/062%20BORDA_Dewats-Handbook.pdf)

## Anaerobic baffled reactor

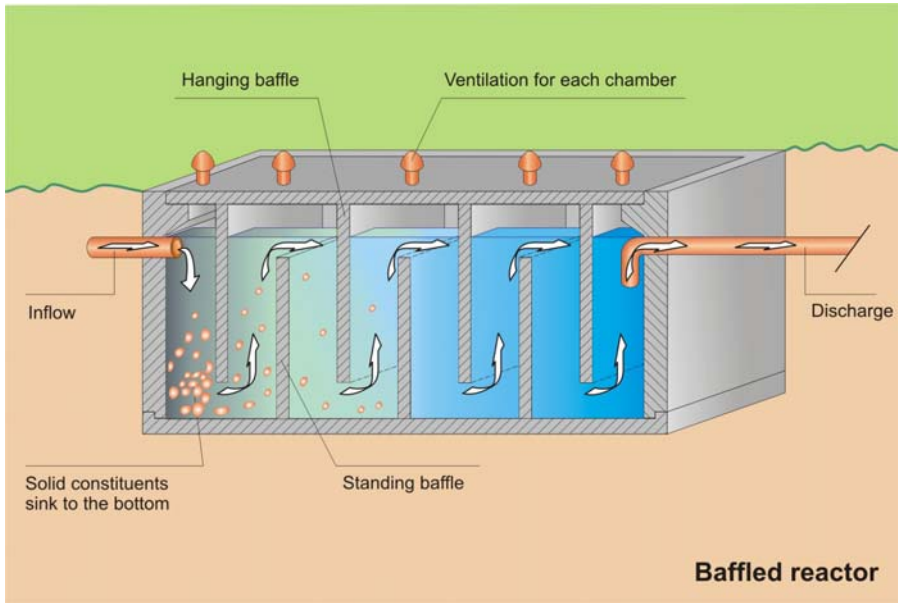

As the first stage a settling and digestion chamber is installed.

Anaerobic baffled reactors (ABR) consist of several chambers for settling and digestion. The inflow is forced through the sludge which settles at the base of the tank to come into contact with the biologically active bacteria. Baffled reactors usually have at least four chambers. The treatment capacity increases with the number of chambers.

Baffled reactors are simple to construct and operate. Another advantage is their relatively small size. This system also requires no electricity. The wastewater constituents are broken down anaerobically.

The treatment capacity lies between 70 to 90 % BOD decomposition according to Sasse, L. (1998).

The space required for a baffled reactor for 8 persons is  $< 5 \text{ m}^2$ . Calculating the size of the reactor is based on the maximum up-flow velocity of approx. 1.4 m/h (Sasse, L., 1998) and the retention time of the wastewater in the

reactor of 40 h (Foxon, 2005).

Clearing out the sludge which collects in the reactor is only required at very long intervals. The retention time can be 5 to 10 years as long as no paper or other poorly digestible material enters the plant (Foxon, 2005).

Prerequisites for anaerobic wastewater treatment are outlined in ch. 5.

For high-loaded sewage in a hot climate, ABR represents a simple technology that is highly effective and requires only small space.

Further information:

Sasse, L. (1998)

[http://www.borda-net.org/modules/wfdownloads/uploads/062%20BORDA\\_Dewats-Handbook.pdf](http://www.borda-net.org/modules/wfdownloads/uploads/062%20BORDA_Dewats-Handbook.pdf)

Foxon, K. (2004):

<http://www.wrc.org.za/archives/watersa%20archive/2004/No5-special/69.pdf>

### Anaerobic filter

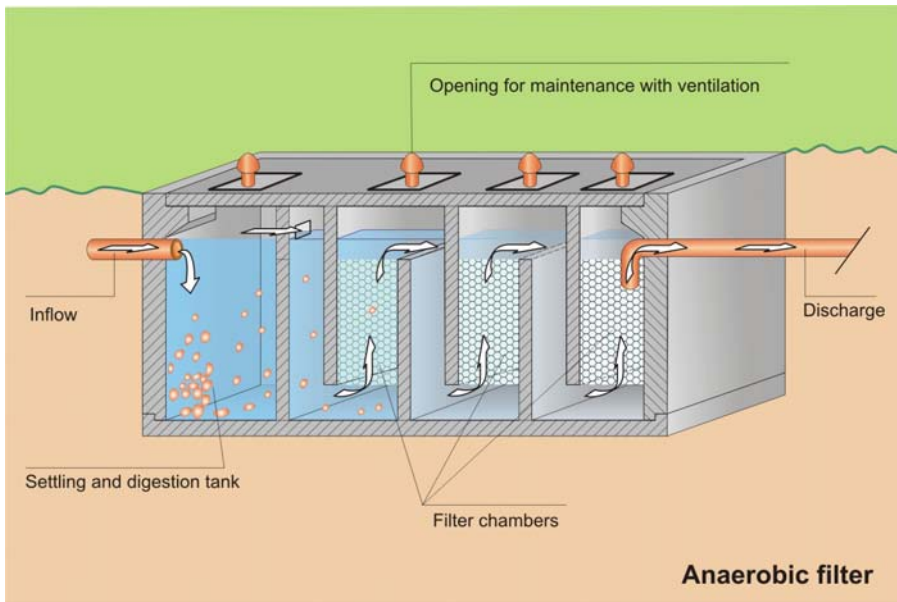

An anaerobic filter plant requires an appropriately large digestion chamber to settle out suspended solids before the wastewater enters the anaerobic filter. This is necessary to prevent the pore spaces from being blocked.

The anaerobic filters are designed to also be capable of breaking down dissolved and permanently suspended materials. The micro-organisms are encouraged to colonise the filter medium and form a biological film.

Anaerobic filters are designed for downflow or upflow operation. The filter material consists of gravel, coarse gravel or slag with diameters of 5 - 15 cm. This lies above a perforated concrete slab. A 50 – 60 cm gap is required between the concrete slab and the floor of the tank for the sludge to settle.

The treatment capacity lies between 70 to 90 % BOD decomposition (Sasse, L., 1998).

The size of anaerobic filters is calculated based on approx. 0.5 m<sup>3</sup>/capita which means that a plant treating the wastewater from 8 people takes up < 10 m<sup>2</sup>.

Anaerobic filter systems are simple to operate. However, construction of the perforated concrete slabs can be relatively expensive.

The sludge only needs to be removed once a year at most. The filters also need to be flushed clean if required.

Prerequisites for anaerobic wastewater treatment are outlined in ch. 5.

Further information:

Sasse, L. (1998)

[http://www.borda-net.org/modules/wfdonloads/uploads/062%20BORDA\\_Dewats-Handbook.pdf](http://www.borda-net.org/modules/wfdonloads/uploads/062%20BORDA_Dewats-Handbook.pdf)

## Constructed wetland

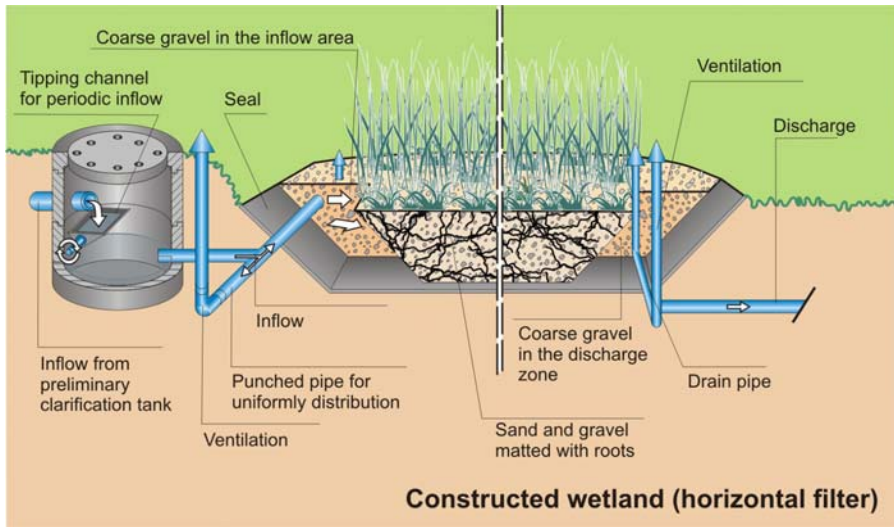

(Münster, 2002)

Before wastewater is entering a constructed wetland, a mechanical pre-treatment through a large septic tank, Imhoff tank or anaerobic pond is required to prevent the pore spaces from being blocked. The COD content should not be higher than 500 mg/l (Sasse, L., 1998).

There are two different types of wetlands with different sewage flow directions: horizontal and vertical filters. The figure above shows a horizontal filter plant.

In case of a vertical filter, wastewater flows downwards through the filter bed and is collected at its bottom through a drainage pipe. Aeration is improved by the periodical inflow of wastewater; enabling oxygen to enter the pore spaces between sewage flushes. A pump is usually required to lift the wastewater. Vertical filter plants only require a surface of  $\geq 2.5 \text{ m}^2/\text{capita}$ . The total area of the plant, however, must be at least  $10 \text{ m}^2$  (Finke, G., 2001).

In horizontal filters wastewater flows horizontally through the filter and is

collected on one end of the plant. (Figure above) Horizontal filters are often permanently soaked with sewage. In some cases Installations like tipping buckets and self acting siphons are used to dose the sewage-inflow into the filter. These installations enhance the aeration of the wastewater and cause considerable higher BOD removal than permanently flooded filters. The space required for a horizontal filter plant is about 5 m<sup>2</sup>/capita. The total area must be at least 20 m<sup>2</sup> (Finke, G., 2001). The top of the filter should be flat to prevent erosion, while the bottom should have a slope of approx. 1 % from inlet to outlet.

The filter medium for horizontal filters should consist of equally sized round gravel. The following parameters are quoted by Finke, G. (2001):

$$\begin{aligned}
 k\text{-value:} & & 10^{-4} - 10^{-3} \text{ m/s} \\
 U: d_{60}/d_{10} & & \leq 5 \\
 d_{10} & & \geq 0.2 \text{ mm} \\
 & \leq 0.063 \text{ mm} & \leq 5
 \end{aligned}$$

If the permeability of the underlain soil is higher than  $k = 10^{-8}$  m/s, it must be sealed off with waterproof sheeting.

Typical inflow and outflow values for constructed wetlands (Kunst, 2002)

	<b>COD [mg/l]</b>	<b>NH<sub>4</sub>-N [mg/l]</b>	<b>NO<sub>3</sub>-N [mg/l]</b>
<b>Inflow</b>	400	70	0
<b>Outflow: vertical filter</b>	70	10	40
<b>Outflow: horizontal filter</b>	90	30	5

The differences in the nitrification and denitrification capacities of these two systems primarily reflect the availability of O<sub>2</sub>. The smaller vertical filter provides better aeration. Horizontal filters have the advantage that they are simpler to construct and require no operational pumps.

The filter medium is completely blocked with sludge after 10 to 20 years and needs to be replaced (Finke, G., 2001).

Constructed wetlands are basically simple and low-maintenance systems if

they are properly constructed. The disadvantages are the poor clarification capacity at low temperatures and the relatively large amount of space required. Constructed wetlands are no proper technology for high loaded wastewater and wastewater containing high amounts of suspended solids.

Further information:

Sasse, L. (1998)

[http://www.borda-net.org/modules/wfdownloads/uploads/062%20BORDA\\_Dewats-Handbook.pdf](http://www.borda-net.org/modules/wfdownloads/uploads/062%20BORDA_Dewats-Handbook.pdf)

Merz, S.K. (2000)

<http://www.sanicon.net/titles/title.php3?titleno=528>

### Trench filter

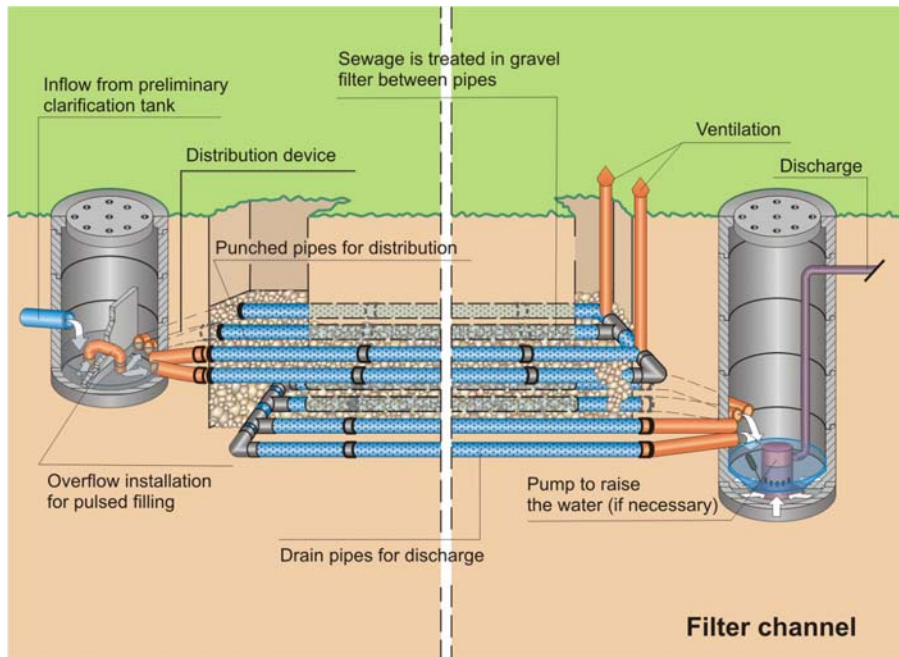

(Münster, 2002)

The sewage needs to be pre-treated in an appropriately large septic tank,



an Imhoff tank or an anaerobic pond from where it flows via a shallow drainage pipe, then passes through a filter layer and enters the underlying discharge drainage pipe. Both ends of the upper pipe are led to the surface to allow ventilation. The lower pipe is 60 cm deeper and terminates in a collection shaft.

This is a reasonably simple system, although electricity is required in some cases to pump the clarified wastewater from the collection shaft up to the specified discharge height. As trench filters are not directly exposed to the weather the influence of low temperatures on the treatment capacity is less compared to wetlands and ponds.

Pulsed inflow is very important for proper operation.

Trench filters need to have a minimum surface area of 3 m<sup>2</sup> per capita. The minimum total area is 12 m<sup>2</sup>. The ground needs to have very low permeability of  $K \leq 10^{-8}$  m/s (DIN 4261). Fine gravel is used as the filter medium.

The filter medium has to be replaced after 8 – 10 years.

Trench filters are no proper technology for high loaded sewage and sewage containing high amounts of suspended solids.

Further information:

Washington State Department of Health (2007)

<http://www.doh.wa.gov/ehp/ts/WW/sandlined-trench-rsg-7-1-2007.pdf>

## Filter tank

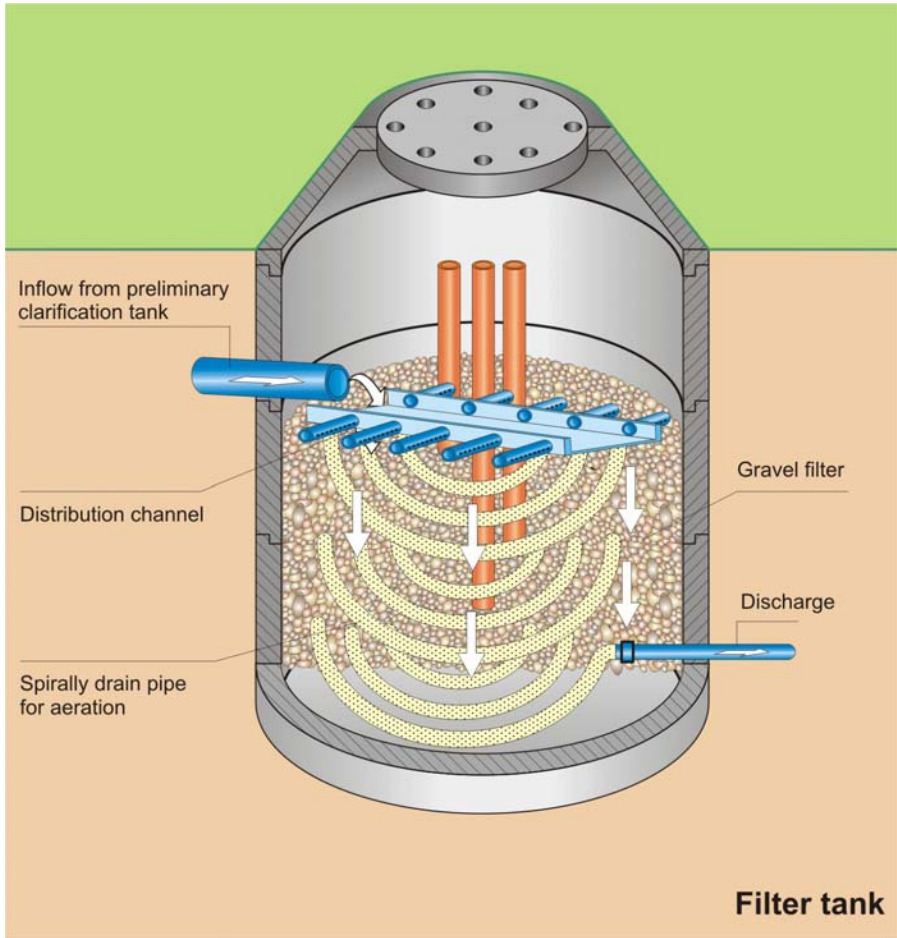

The sewage needs to be pre-treated in an appropriately large septic tank or Imhoff tank.

The filter tank principle is basically a trench filter constructed in a shaft. The amount of space required by a filter tank is less than a trench filter.

Filter height	$\geq 1.50$ m
Filter volume	$\geq 1.50$ m <sup>3</sup> /capita
Filter surface	$\geq 1$ m <sup>2</sup> /capita

(Finke, G., 2001)

Filter tanks can have various distribution systems; designed to allow wastewater to inflow periodically (pulsed inflow) and to ensure uniform distribution of the wastewater throughout the filter tank.

Depending on the external conditions (nature of the ground), installing a filter tank can either be easier or more complex than constructing a trench filter.

Possibly a pump is required to raise the wastewater.

Due to the depth of the shaft filter tanks are less sensitive to low external temperatures than waste stabilisation ponds or constructed wetlands. Due to size limits filter tanks are only suitable for a small number of users. They are adverse to fluctuations in inflow rate.

The filter tank needs to be serviced twice a year.

Further information:

DWA Standard ATV-A 122E

<http://www.dwa.de>

## 4.4.3 Methods using artificial aeration

### Activated sludge tank

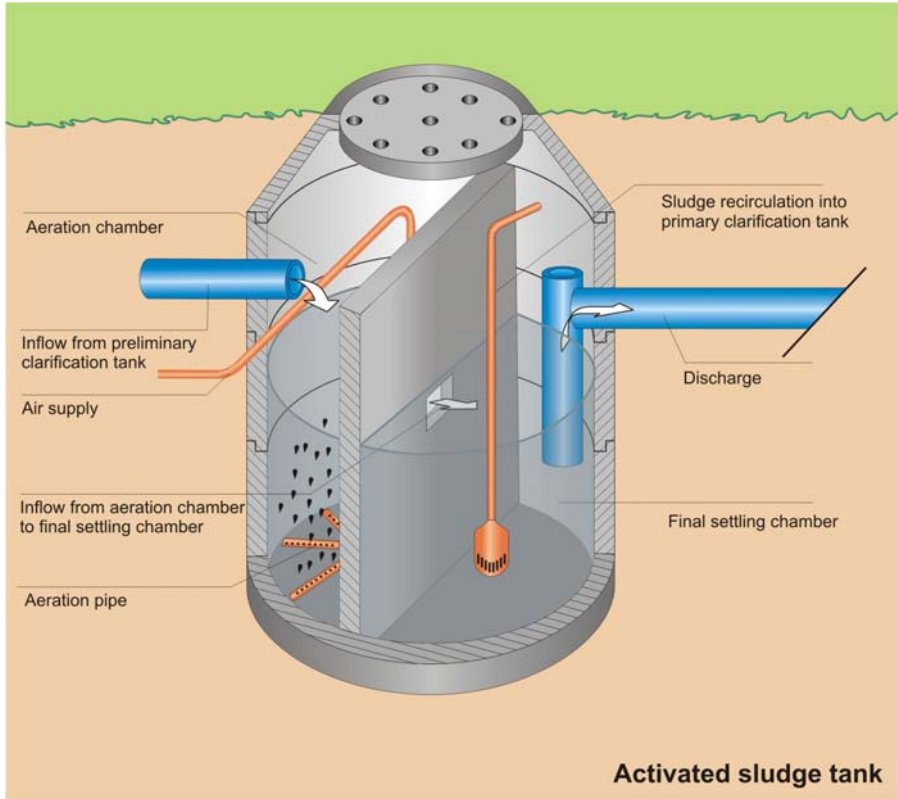

The wastewater must undergo mechanical pre-treatment by either a settling chamber, or in best case in a septic tank.

The activated sludge process is one of the high-tech measures. It requires aeration equipment and pumps. The sludge from the final clarification basin is partially recirculated into the aeration tank. This plant can only be operated with electricity.

The processing costs are very high what explains why activated sludge methods are usually not carried out in small-scale treatment plants. The

method also requires continuous flows of wastewater and is therefore only suitable for units handling at least 15 inhabitants (Pabst/Flasche, 2004).

According to German DIN standard 4261 the size of the aeration tank should correspond to approx.  $0.3 \text{ m}^3/\text{capita}$  for mechanically pre-treated wastewater. The minimum volume is  $1 \text{ m}^3$ . The space required for a plant handling the sewage from 8 persons is  $< 10 \text{ m}^2$  (Pabst/Flasche, 2004).

Activated sludge plants must be serviced three times a year and controlled daily.

Methods that depend on electricity and highly developed technical installations are only suitable if operated and maintained by skilled personnel. Electricity must be permanently available.

Further information:

DWA Standard ATV-A 122E

<http://www.dwa.de>

## Fixed bed reactor

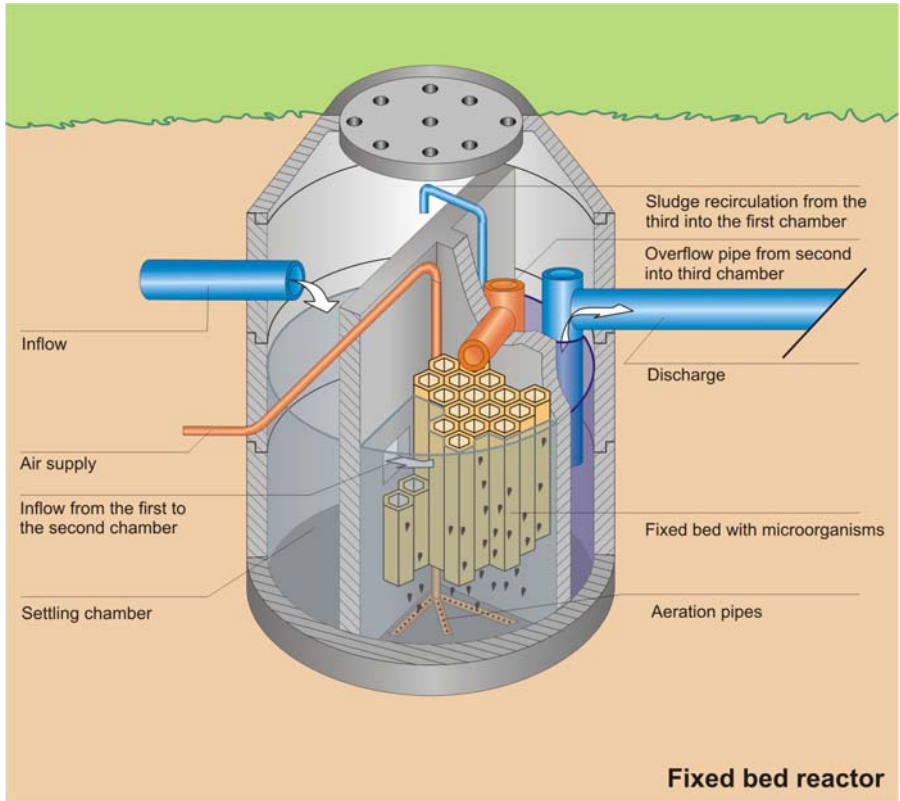

(Münster, 2002)

A settling chamber or a septic tank is required for pre-treatment.

Plastic grids are used as growing media in the fixed-bed reactors. Compressed air is used to aerate and mix up the sludge in the chamber. The fixed-bed is completely submerged in the sewage.

Fixed-bed reactors are a further development of conventional activated sludge plants. They use additional growth media for sessile microorganisms. In most cases, it involves sludge recirculation from the final clarification stage.

In a similar way to the activated sludge method, this high-tech equipment requires electricity and a large amount of equipment.

Aeration takes place intermittently and is externally controlled.

The size of a fixed bed reactor should correspond to approx.  $0.3 \text{ m}^3/\text{capita}$  for mechanically pre-treated wastewater. A plant to handle the sewage from 8 persons requires  $< 10 \text{ m}^2$  (Pabst/Flasche, 2004).

Fixed-bed reactors have to be serviced three times a year and controlled daily.

Methods that depend on electricity and highly developed technical installations are only suitable if operated and maintained by skilled personnel. Electricity must be permanently available.

Further information:

DWA Standard ATV-A 122E

<http://www.dwa.de>

## Sequencing batch reactor (SBR)

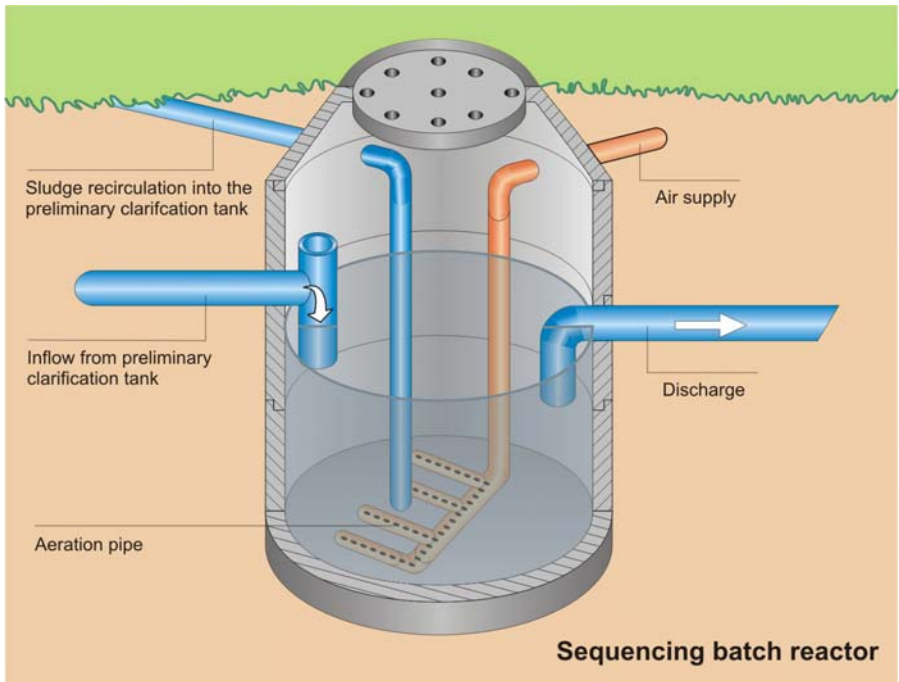

(Münster, 2002)

A settling chamber or a septic tank is required for pre-treatment.

SBRs are discontinuous, cyclically-operated, activated sludge installations. The treatment stages take place one after the other in one tank. Thus there is no need for any final clarification basin with sludge recirculation.

However, a coarse separator is needed upstream because SBRs with one tank are not completely reliable.

The processes take place successively in the reactor: mixing, aeration, sludge sedimentation, clarified water removal and excess sludge removal.

SBRs are high-tech reactors requiring electricity, pumps, sensors and aeration equipment.



In Europe a large number of small-scale treatment plants are currently being constructed according to the SBR method. Existing septic tanks can be converted to SBR plants without the need to build any new tanks.

The size of SBRs corresponds to 0.3 – 0.5 m<sup>3</sup>/capita (Boller 1995). An 8-person reactor takes up < 10 m<sup>2</sup> (Pabst/Flasche, 2004).

SBRs must be serviced three times a year and controlled daily.

Methods that depend on electricity and highly developed technical installations are only suitable if operated and maintained by skilled personnel. Electricity must be permanently available.

Further information:

DWA Standard ATV-A 122E

<http://www.dwa.de>

## Trickling filter

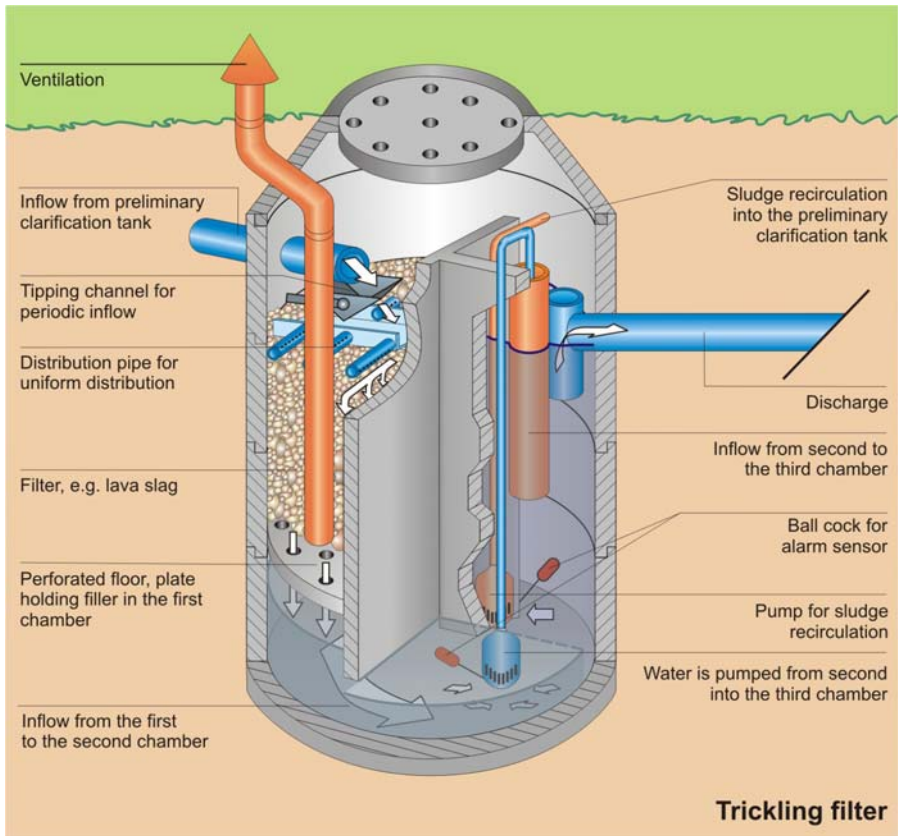

(Münster, 2002)

A septic tank is required for pre-treatment.

This technique has already been used for many decades and is therefore tried and tested. It is the simplest form of high-tech system. The pumps require electricity.

The wastewater trickles over the filter via distribution channels, atomising disks, stationary or rotating sprinklers. Micro-organisms colonise the filter material consisting of lava slag or plastic granules to form a bio-film. The wastewater percolates through the filter from top to bottom and comes into

contact with the bio-film where the micro-organisms break down the constituents of the wastewater.

The chimney effect supports aeration. At the base of the chamber, the wastewater flows beneath a scum-board into a second chamber where the fixed biological film which may have become flushed off can settle.

The filter is sprayed with wastewater several times by a pump. The frequency of pumping depends on the height of the trickling filter. A trickling filter with a height of 1.5 m needs to be sprayed three times. Higher filters need less spraying.

The basin size for trickling filters providing nitrification is about 0.3 m<sup>3</sup>/capita. The minimum size of the basin is 2 m<sup>3</sup>. A plant for treating the wastewater from 8 persons occupies 10 – 20 m<sup>2</sup> (Pabst/Flasche, 2004).

Trickling filters must be serviced three times a year and controlled daily.

Methods that depend on electricity and highly developed technical installations are only suitable if operated and maintained by skilled personnel. Electricity must be permanently available.

Further information:

DWA Standard ATV-A 122E

<http://www.dwa.de>

## Biodisk

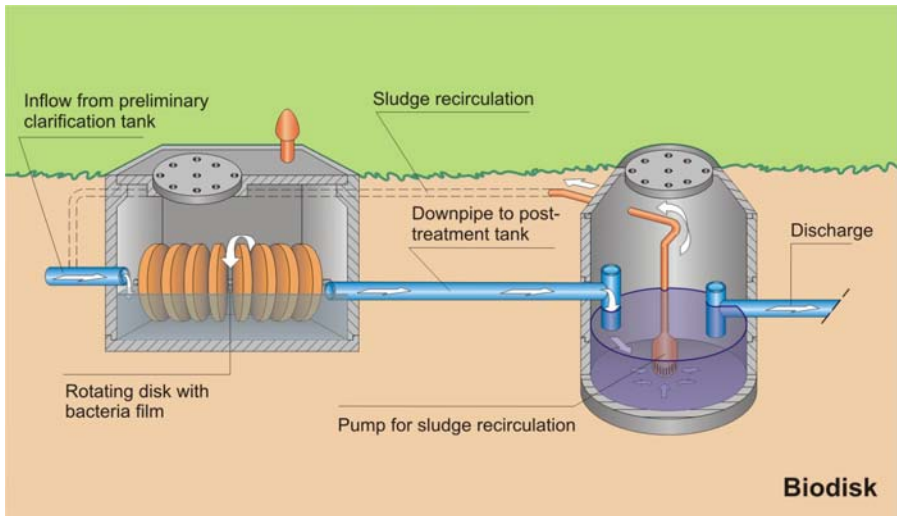

(Münster, 2002)

A septic tank is required for pre-treatment.

The plant engineering for biodisk reactors (or RBC: Rotating Biological Contactor) involves quite expensive installation and maintenance. Biodisk reactors also use a large amount of electricity because the disk rotates continuously.

A partially submerged disk is fixed to and rotates around an axle. Oxygen is taken up when the disk is in the air above the wastewater. The biological films washed off the rotating disk accumulate as surplus sludge in the final clarification stage.

The size of rotating disk filter plants is calculated on the basis of a colonisation surface of  $\geq 10 \text{ m}^2/\text{capita}$  (DIN 4261). A plant to handle the sewage from 8 people takes up less than  $10 \text{ m}^2$  (Pabst/Flasche, 2004).

Biodisk filter systems have to be serviced three times a year and controlled daily.

Methods that depend on electricity and highly developed technical installations are only suitable if operated and maintained by skilled personnel. Electricity must be permanently available.

Further information:

DWA Standard ATV-A 122E

<http://www.dwa.de>

The following applies to all methods with artificial aeration: designs are available which integrate the settling basin for pre-treatment, final clarification and the basin for the biological stage within one tank. **Some systems are designed for installation below ground, but also surface installations exist.**

**All of the methods require electrical power for aeration and to operate the pumps.** The secondary sludge generated by these processes (from the biological stage) is usually pumped into the pre-clarification basin and disposed of together with the primary sludge (from the mechanical pre-treatment stage).

Although the tanks shown here are round, they are constructed often with a rectangular shape.

## 5 How to choose the appropriate technology?

The success of dry sanitation is depending of various cultural and natural factors: willingness of the use of the facilities and of the products, availability or shortage of water, climatic conditions. **Where water is scarce, dry sanitation must be taken into account.**

The general disadvantage of **technical plants** is the **need of professional operation and service** and the large **energy consumption**. In general these technical options are not very well know in developing countries. Waste stabilisation ponds, septic tanks and eventually wetlands are the common techniques in the developing world. One negative aspect of “natural” systems is the **large amount of space required**.

In general, technology selection is depending on:

- **Water availability and -use:** where water is scarce, dry sanitation is the first option. In wastewater systems the organic load is an important factor for the choice of the treatment option. The organic load is primarily dictated by the amount of water that is used to dilute organic waste.
- **Self help potential** (availability of skilled labour): if facilities are operated and maintained by the users, the applied technology must be adapted to their ability. In either case it is more effective to operate a well working simple technology (that provides only low treatment capacity) than to build up a high-tech application that is not working at all. Unfortunately there are countless wastewater treatment plants around the world that are not working due to a lack of electricity, maintenance, spare parts, etc.
- **Housing density** (space availability): different treatment techniques require different amounts of space; hence the applied technology is to be chosen in accordance to the availability of space. Further important factors are odour nuisance and a possible

mosquito breeding ground provided by a treatment plant.

- **Reuse potential:** dry sanitation techniques like dehydrating or composting toilets are an option if products are reused. In case of water-based techniques, treated wastewater that is to be used for irrigation should contain nutrients like nitrate and phosphate, but should be hygienically safe. Treated wastewater that is going to be discharged into any water body should contain as little nutrients as possible.
- **Climate:** any biological activity is depending on temperature; also the treatment capacity is generally rising with temperature. The higher the temperature the more oxygen in the wastewater is needed. If there is a lack of oxygen, the organic conversion proceeds anaerobically. In stable hot climate anaerobic digestion has proven most effective.
- **Soil conditions:** for natural systems like ponds, wetlands or trench filters, the soil conditions are an important factor regarding construction costs. If the soil is of very low permeability, a pond or filter can be built without high costs, otherwise a sealing is necessary. For the construction of pit latrines, the permeability is also an important factor: soil must have a certain permeability to allow leaching of fluids, but a very high permeability leads to a higher minimum distance between latrine and drinking water wells.
- **Availability of electricity:** if there is no reliable power source available, systems that rely on electricity are completely unsuitable.
- **Groundwater table and seasonal fluctuation:** no water from external sources should be allowed to enter a treatment plant. When talking about wastewater treatment plants, dilution of the wastewater decreases the treatment capacity. When dehydrating toilets are used, the complete process will fail if the processing chamber is flooded.

- **Costs:** costs are a crucial factor for the decision. Besides construction, also operation and maintenance may generate costs. On the other hand it is possible to gain a profit by a sanitation system, e.g. biogas, or urine as a field fertiliser.

The **choice between aerobic and anaerobic treatment** depends on the following items:

Desired effluent quality	aerobic treatment provides higher efficiency in removal of organic matter and nutrients
Effluent use	anaerobic treatment remains more nutrients and thus effluent have higher potentials for use in irrigation
Sewage characteristics	for high concentrated sewage (BOD > 1000 mg/l) in hot climate (average sewage temperature above 20°C, minimum of 18°C over a maximum period of 2 month) anaerobic treatment is effective
Sludge handling and disposal	anaerobic treatment provides small amounts of stabilised sludge, while sludge from aerobic treatment processes is of higher volume and requires further processing

(Veenstra et al. 1997)

Further information:

Kalbermatten, J., et al. (1982)

<http://go.worldbank.org/WFDP9UYRW0>

Veenstra, et al. (1997)

[http://www.who.int/water\\_sanitation\\_health/resourcesquality/watpolcontrol/en/](http://www.who.int/water_sanitation_health/resourcesquality/watpolcontrol/en/)

Franceys, R., et al. (1992)

[http://www.who.int/docstore/water\\_sanitation\\_health/onsitesan/begin.htm#Contents](http://www.who.int/docstore/water_sanitation_health/onsitesan/begin.htm#Contents)



## 6 Location selection

It is often standard procedure to locate latrines and drinking water wells on the same plot. It is essential in such cases to **ensure that the latrine is downstream of the drinking water well** with respect to groundwater flow. Usually the direction of groundwater flow corresponds with the topography.

The general rule for most soil types is to keep a **minimum distance of 15 m** between drinking water wells and latrines, as well as a minimum distance of 2 m between the base of the latrine pit and the water table (Cave, Kolsky, 1999).

**Sanitation facilities are to be constructed in a flood-safe place.**

In ARGOSS (2001) and WHO Guidelines for drinking water quality, Vol. 3 principles for the location of drinking water and sanitation facilities can be found.

Drying and composting toilets in general are less of a hazard to groundwater than latrines because many of these more highly developed systems have water-tight collecting containers.

The soil does, however, also have the potential to detain contaminants. Very effective protection is provided by the unsaturated zone which is usually characterised by very low flow rates. The key to germ reduction is the retention time of contaminants in the soil. In this context it should be noted that latrines often represent less of a hazard to groundwater than cesspits with downstream percolation as these cesspits are associated with much higher flow rates because of the volume of grey water entering the tanks. The same applies to defective sewage pipes.

(Cave, Kolsky, 1999) describes in detail the dispersal routes of pathogenic germs from latrines and the associated health risks.

## 7 Common construction defects

The following defects are common when constructing sanitation facilities and small-sized wastewater treatment plants:

---

Insufficient pipe gradient causing clogging

---

Destroyed pipes due to mechanical stresses and UV radiation

---

No access of adequate size for lorries collecting the sludge

---

Inadequate ventilation via the lids (the lids are often completely covered. This means there is no guarantee that proper ventilation is taking place)

---

Defective connections or no backflow preventer on the outflow at the end of the discharge pipe

---

Rainwater not prevented from entering the treatment plant

---

Tanks not adequately protected from uplift when empty in areas with high water tables

---

Distribution channels not built perfectly horizontal

---

Leaks

---

Distance to drinking water wells too small

---

## 8 References

ARGOSS (2001): Guidelines for Assessing the Risk to Groundwater from On-Site Sanitation. British Geological Survey, 2001. Download:

<http://www.bgs.ac.uk/hydrogeology/argoss/manual.html>

BGBI. Abwasserverordnung (2002): Verordnung über Anforderungen über das Einleiten von Abwasser in Gewässer (Wastewater ordinance), Bürgerliches Gesetzblatt, 2002

Boller (1995): Abwasserentsorgung im ländlichen Raum, gwa 75 Heft 7

Cave and Kolsky (1999): Groundwater, latrines and health. Water and Environmental Health at London and Loughborough. Task No. 163. July 1999. Download:

<http://www.lboro.ac.uk/orgs/well/resources/well-studies/summaries-hm/task0163.htm>

Cotton, A. (1998): On-Plot Sanitation in Low-Income Urban Communities, Guidelines for Selection. Water, Engineering and Development Centre, Loughborough University, UK. Download:

<http://www.lboro.ac.uk/departments/cv/wedc/publications/opsg.htm>

DIN 4261 Kleinkläranlagen. Deutsches Institut für Normung e. V. Beuth Verlag, Berlin

DWA Standard ATV-A122E. Deutsche Vereinigung für Wasserwirtschaft, Abwasser und Abfall; *German Association for water management, wastewater and waste*: Principles for Dimensioning, Construction and Operation of Small Sewage Treatment Plants with Aerobic Biological Purification Stage for Connection Values between 50 and 500 Total Numbers of Inhabitants and Population Equivalents, 1991

Homepage: <http://www.dwa.de>

Finke, G. (2001): Kleinkläranlagen. ATV/DVWK Landesverband Nord, Hildesheim, 2001

Foxon, K. (2004) The Anaerobic Baffled Reactor (ABR): An appropriate technology for on-site sanitation, University of Kwazulu-Natal. Download: <http://www.wrc.org.za/archives/watersa%20archive/2004/No5-special/69.pdf>

Foxon, K. (2005): University of Kwazulu-Natal, South Africa. unpublished messages

Franceys, R. et al. (1992): A guide to the development of on-site sanitation, WHO; Geneva, 1992. Download:

[http://www.who.int/docstore/water\\_sanitation\\_health/onsitesan/begin.htm#Contents](http://www.who.int/docstore/water_sanitation_health/onsitesan/begin.htm#Contents)

Hosang, Bischof (1998): Abwassertechnik. Teubner Verlag, Stuttgart, 1998

Kalbermatten et al. (1982): Appropriate Sanitation Alternatives - A Planning and Design Manual, The World Bank, Washington D.C. USA, Download:

<http://go.worldbank.org/WFDP9UYRW0>

Kunst, S. (2002): Sustainable Water and Soil Management. Springer Verlag 2002

Mara, D. (1997): Waste Stabilisation Ponds: Design Manual. Download:

<http://www.personal.leeds.ac.uk/%7Ecen6ddm/WSPmanualindia.html>

Merz, S.K. (2000): Guidelines For Using Free Water Surface Constructed Wetlands To Treat Municipal Sewage, Brisbane Australia, 2000, Download:

<http://www.sanicon.net/titles/title.php3?titleno=528>

Münster, Ed. (2002): Kleinkläranlagen. Informationen zum Bau und Betrieb.

Download: <http://www.muenster.de/stadt/umwelt/kleinklaeranlagen.html>

Pabst/Flasche (2004): Kommunale Umwelt-Aktion, Hannover. Hinweise für Betreiber zum Bau und Betrieb von Kleinkläranlagen. Download:

[www.uan.de](http://www.uan.de)

Peasey, A. (2000): Health Aspects Of Dry Sanitation With Waste Reuse. Water and Environmental Health at London and Loughborough. Task No. 324. London, 2000. Download:

<http://www.lboro.ac.uk/well/resources/well-studies/full-reports-pdf/task0324.pdf>

Sasse, L. (1998): DEWATS Decentralised Wastewater Treatment in Developing Countries. BORDA, Bremen Overseas Research and Development Association Bremen, Germany 1998 Download: [http://www.borda-net.org/modules/wfdownloads/uploads/062%20BORDA\\_Dewats-Handbook.pdf](http://www.borda-net.org/modules/wfdownloads/uploads/062%20BORDA_Dewats-Handbook.pdf)

UNEP (2004): Improving municipal wastewater management in coastal cities. Download: <http://www.gpa.unep.org/training/>

UNESCO World Water Development Report (2003) UNESCO Division of Water Sciences, Paris, 2003

University of Bremen (2000) Abwasserlexikon <http://www.wasser-wissen.de/abwasserlexikon.htm>

Veenstra, et al. (1997): Technology selection. In: Helmer, Hespanol (eds) Water Pollution Control, a guide to the use of water quality management principles, E & FN Spon, London, 1997. Download: [http://www.who.int/water\\_sanitation\\_health/resourcesquality/watpolcontrol/en/](http://www.who.int/water_sanitation_health/resourcesquality/watpolcontrol/en/)

WHO (2006): Guidelines for drinking-water quality. Third edition, First Addendum, Geneva. Download: [http://www.who.int/water\\_sanitation\\_health/dwg/gdwg3rev/en/](http://www.who.int/water_sanitation_health/dwg/gdwg3rev/en/)

Winblad et al. (2004): Ecological Sanitation. SIDA Swedish International Development Cooperation Agency. Stockholm 2004. Download: [http://www.ecosanres.org/pdf\\_files/Ecological\\_Sanitation\\_2004.pdf](http://www.ecosanres.org/pdf_files/Ecological_Sanitation_2004.pdf)