

SWAMP

SUSTAINABLE WATER MANAGEMENT AND WASTEWATER PURIFICATION IN TOURISM FACILITIES

EVK1-CT-2000-00071
www.swamp-eu.org

A project under the Energy, Environment
and Sustainable Development Programme
of the 5th Framework Programme.

January 2005

Guidelines for Sustainable Water Management in Tourism Facilities

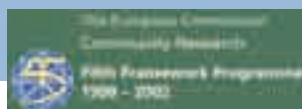

Project funding



bm:bwk



lebensministerium.at



Ministerium für Umwelt,
Naturschutz und Landwirtschaft
des Landes Schleswig-Holstein



Project partners



AEE INTEC
Gleisdorf, Austria



Ambiente Italia s.r.l.
Milano, Italy



Carl Bro Latvia
Riga, Latvia



AWA Ingenieure Dr. Bahlo & Ebeling
Uelzen, Germany



IRIDRA Srl
Firenze, Italy



Ökologisches Projekt
Technisches Büro für Kulturtechnik
Graz, Austria



Sia Aprite
Cesis, Latvia



target GmbH
Hannover, Germany



**Water Management Institute of the
Lithuanian University of Agriculture**
Kėdainiai, Lithuania

ACKNOWLEDGEMENTS

These guidelines are the joint result and work of the SWAMP project team (Sustainable Water Management and Wastewater Purification in Tourism Facilities). They include the experiences collected at the SWAMP demonstration sites and knowledge of all the project partners.

The Partners are

- AEE INTEC, Gleisdorf, Austria as project co-ordinator
- Ambiente Italia s.r.l, Milano, Italy
- Carl Bro Latvia, Riga, Latvia
- AWA Ingenieure Dr. Bahlo & Ebeling, Uelzen, Germany
- IRIDRA Srl, Florence, Italy
- Ökologisches Projekt Technisches Büro für Kulturtechnik, Graz, Austria
- Sia Aprite, Cesis, Latvia
- target GmbH, Hannover, Germany
- Water Management Institute of the Lithuanian University of Agriculture, Kėdainiai, Lithuania

The project partners were assisted by the owners of the sixteen tourism facilities, where demonstration sites were implemented. They accepted to experiment with sustainable water techniques and assisted in the probing and monitoring of the plants.

We hope that these guidelines help owners of tourism facilities to decide in favour of a sustainable water use and gives engineers and technicians the know-how they may perhaps need in order to implement the most advantageous solutions.

SWAMP is a demonstration project under the 5th Framework Program. 35 percent of the budget were funded by the European Commission. The balance was contributed by national bodies, the partners and the owners of the tourism facilities.

Disclaimer

This publication has been produced with the assistance of the European Union. The contents of this publication is the sole responsibility of AEE INTEC and can in no way be taken to reflect the views of the European Union.

CONTENT

PREFACE	7
ABBREVIATIONS	9
Section 1 SUSTAINABLE SANITARY CONCEPTS	11
1.1 Sanitary concepts in general	11
1.2 Wastewater and sludge in tourism facilities	14
1.3 Separation of substance flows	19
1.4 Water saving potential	22
1.5 Rain water harvesting	24
1.6 Experiences and recommendations from SWAMP	25
Section 2 DESCRIPTION OF TECHNIQUES	31
2.1 Sensitisation and awareness raising	31
2.2 Water saving devices, appliances and techniques	33
2.3 Separate grey and black water collection and treatment	38
2.4 Urine separation	50
2.5 Vacuum toilet systems	57
2.6 Waterless urinals	62
2.7 Compost toilets	66
2.8 Constructed wetlands for wastewater treatment	70
2.9 Aerobic sludge treatment	81
2.10 Rainwater harvesting	87
2.11 Irrigation	96
Section 3 IMPLEMENTATION	107
3.1 Step by step procedure: design of a water management scheme	107
3.2 Decision tree	110
Section 4 ANNEX	111
• Sample texts and examples of measures	111
• Leaflet of Fischerhof	113
• Information and awareness raising through environmental management tools: the EU Ecolabel and EMS (Environmental Management Systems)	115
• Questionnaire for tourism facilities	119

Imprint

Guidelines for Sustainable Water Management in Tourism Facilities

Authors

- Martin Regelsberger (editor)
- Klaus Bahlo
- Giulio Conte
- Bernd Ebeling
- Fabio Masi
- Gabriele Mitterer-Reichmann
- Christian Platzer
- Barbara Regelsberger
- Loreta Urtane
- Gerd Wach

Prepared with the financial contribution of

- European Commission, Fifth Framework Programme
- Austrian Federal Ministry for Education, Science and Culture
- Austrian Federal Ministry for Agriculture, Forestry, Environment and Water
- Latvian Ministry of Environment
- Province of Styria

ISBN 3-901425-99-3

1st Edition 2005

Published by

Arbeitsgemeinschaft ERNEUERBARE ENERGIE GMBH
Feldgasse 19, A-8200 Gleisdorf

Design and Layout

- target GmbH, D-30163 Hannover
- set-up design.print.media, D-30163 Hannover

All rights reserved. No part of this publication may be reproduced in any form or by any manual, electronic or mechanical means, including photocopying, recording, taping or other information storage and retrieval systems, without the prior written permission of the publisher. Every reasonable care has been taken in the compilation of these guidelines, but no responsibility is accepted for errors or omissions of any kind.

PREFACE

Concerning their water management, tourism facilities in remote areas frequently share the same characteristics: They have high variability of water consumption and a wastewater flow, depending on the season, the weather or a weekly rhythm; no connection to a public sewer and the drinking water supply may be limited; often they are located in a sensitive environment.

The expression Sustainable Water Management (SWM) implicates the use of water in the most efficient way and treatment of the produced wastewater with the least impact to the environment. These guidelines give recommendations

- how to reduce the water consumption and thus the sewage quantity
- how to make use of unconventional water resources like rainwater and treated wastewater
- how to reuse the nutrients contained in the wastewater
- how to treat sewage with least impact to the environment
- how to discharge the treated wastewater

Reducing water consumption

Although people will accept measures to reduce water consumption at their homes because of economic reasons, they will not accept it to be limited as tourists. Therefore, a very important aspect of the reduction of water consumption is awareness raising of the users and their acceptance of the idea. This can only be done if reliable figures of the water consumption of every apartment or rented item are known and reported. That means that water metering is essential in the strategy for an efficient and sustainable tap water use.

Besides the explanation of the necessity to protect water resources or to reduce pollution in a sensitive environment, user friendly systems can be applied: Technical measures without loss of comfort as shower heads, special faucets, waterless urinals, dishwashers or washing machines can be applied. If the hotel manager or inn keeper can communicate difficulties with wastewater treatment due to local conditions clients will also use without problems composting toilets or urine separation toilets with less water for flushing.

Treating wastewater

The reduction of water consumption means also a reduction of the wastewater quantity which results in reduced costs for wastewater treatment. Besides less water use also an equalization of the water flow by buffering the consumption peaks will optimise the treatment plant size. The use of composting toilets and urine separation could additionally reduce the load considerably and so the plant size.

Segregation of flows

The treatment can be optimised if it is possible to segregate different wastewater flows and to treat them separately according to their characteristics. Black water from toilets requires a more thorough treatment than for example grey water from showers and lavatories. Grey water can be treated easily and then reused. Urine can be collected separately. It contains hardly any micro-organisms and is a valuable nutrient resource for use in agriculture.

The treatment technology of constructed wetlands (like reed bed treatment systems – RBTS) shows that it suits very well to the demands of tourism facilities in remote areas, being

- very efficient in BOD reduction and pathogen elimination
- easy to handle

- constructed with local materials
- not sensitive to peaks
- fitting well into the environment
- easy maintenance and low running costs

Other water resources

According to needs, different water qualities could be offered for consumption: Tap water with drinking-water quality only for cooking and personal hygiene. Rainwater or purified grey or black wastewater can be used for purposes where no drinking water quality is required like landscaping or irrigation, toilet flushing or washing.

In the following detailed information will be given about possible measures and technologies suitable for sustainable water and wastewater management in tourism facilities of remote areas. The possibilities of their application depend on the local situation first, and the needs and its acceptance by the tourists.

ABBREVIATIONS

A	Austria
ARPAT	Agenzia regionale per la protezione ambientale della Toscana
ATV	Abwassertechnische Vereinigung
AWA	AWA – Ingenieure Dr. Bahlo & Ebeling
BOD ₅	Biochemical oxygen demand over 5 days
BUND	Bund für Umwelt- und Naturschutz Deutschland, Friends of the Earth
COD	Chemical oxygen demand
CW	Constructed wetland
D	Germany
DIN	Deutsche Industrienorm
E.coli	Escherichia Coli
EC	European Commission
EEA	European Environment Agency
EDC	Endocrine Disrupting Chemicals
EMAS	Eco-management and audit scheme
EMS	Environmental Management System
EN	EuroNorm
EU	European Union
FBR	Fachvereinigung Betriebs- und Regenwassernutzung
FC	Faecal coliforms
FWS	Free water surface (constructed wetlands)
GRP	Glass fibre reinforced plastic
GTZ	Deutsche Gesellschaft für Technische Zusammenarbeit GmbH
HF	Horizontal flow (constructed wetlands)
I	Italy
ISO	International Standardisation Organisation
IWA	International Water Association
l/cd	litres per capita and day
LV	Latvia
LT	Lithuania
MBR	Membrane Bioreactor
NTU	Nephelometric Turbidity Units
ÖNORM	Austrian standards
ÖWAV	Österreichischer Wasser und Abfallverband
pe	person equivalent
RBC	Rotating Biological Contactors
RBTS	Reed bed treatment system
SBR	Sequencing batch reactor
SS	Settleable solids
STRB	Sludge treatment reed beds
SWAMP	Sustainable water management and wastewater purification in tourism facilities
SWM	Sustainable water and wastewater management
TKN	Total Kjeldal Nitrogen
TOC	Total organic carbon
TSS	Total suspended solids
USEPA	United States of America environmental protection agency
UV	Ultra-violet
VF	Vertical flow (constructed wetlands)
WFD	Water Framework Directive
WHO	World Health Organisation
SI units	

Section 1

SUSTAINABLE SANITARY CONCEPTS

1.1 Sanitary concepts in general

Conventional sewage treatment

Conventional sewage treatment bases on flush-and-discharge systems that require large amounts of water for flushing, and world-wide for many municipalities unaffordable investments into sewer systems and treatment plants. Within a year for each Western European about 500 litres of urine and 50 kilograms of faeces are flushed away with 15,000 litres of drinking water. Grey water from bath, kitchen and laundry amounts to further 15,000-30,000 litres for each person. Rainwater from roofs, streets, paved areas, percolating water and wastewater from trades and industries are added to sewer systems doubling the water quantity from households. Thus, in this flush-and-discharge-technology the problem becomes obvious: the hygienically dangerous 50 kilograms of faeces contaminate not only the relatively harmless urine but also the large amount of flushing water and the complete water quantity added to the sewer.

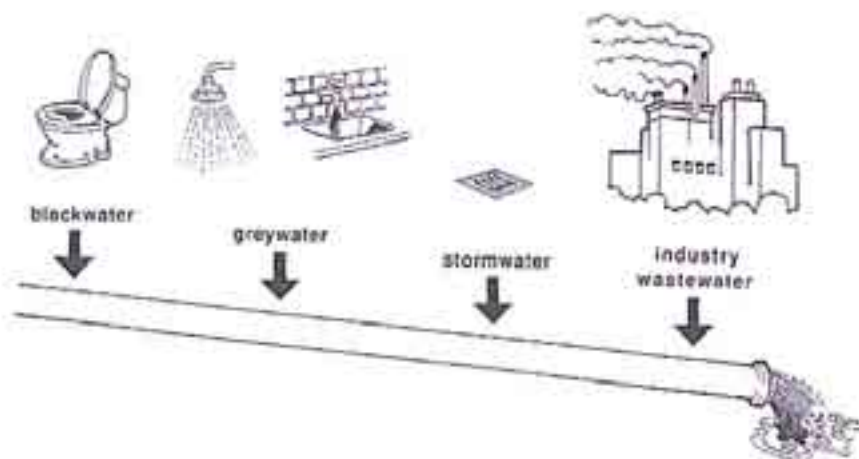

Figure 1: End-of-pipe-problem (Windblad & Simpson-Hébert, 2004)

The shortcomings of end-of-pipe-technologies may be summarised as follows:

- Dissipation of large quantities of pure water by using it as means of transport
- Mixing up different sewage ingredients requires an extensive operating process for purification but still leaving various more or less harmful substances in outlets and sludges
- Impossibility to recover nutrients as nitrogen (N) and phosphorus (P) due to high-grade dilution of sewage
- High energy and investment inputs for degradation of organic compounds and elimination of N and P
- Production of large quantities of sludge that in future may not be used in agriculture but combusted in expensive incineration plants
- Eutrophication, salinisation and virulent germ burden of surface waters

Sustainable sanitary concepts

Sustainable sanitary concepts are based on the fundamental principle that human expulsions are rather considered as valuable resource than as useless waste. This new approach contains a cycle in which nutrients from urine and faeces are stored on site and sanitised and then, if necessary, further processed for recycling them in agriculture.

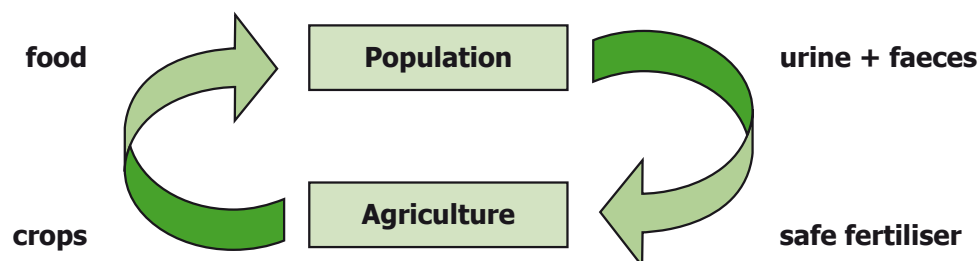

Figure 2: Sustainable usage of human excreta

Additionally, apart from this approach there are some more considerable benefits associated with the idea of "sanitise-and-recycle". For single households in rural areas as well as for housing estates in urban areas or even whole districts a systematic approach is needed that considers and combines the various available technical possibilities in sustainable sanitation. The table below gives a survey how separated substances may be treated and utilised covering low-tech solutions as well as complex high-tech designs. For example, a technical approach for a multiple family estate may consist of urine separation toilets, a storage tank, a vacuum transport system for faeces, and a biogas plant combined with planted soil filters for grey water purification and its following reuse.

Substance	urine	faeces	greywater	rainwater
Treatment	storage, direct application, precipitation of N and P, drying for reuse in agriculture	anaerobic digestion, composting	planted soil filters, wastewater ponds, SBR, membrane technique, filtration, UV-radiation	harvesting and filtration
Utilisation	liquid and dry fertiliser	biogas, soil conditioner	infiltration, irrigation, gardening, washing purposes	infiltration, toilet flushing, laundry

Table 1: Separation and reuse of substances from wastewater

It has to be pointed out that for a long-term implementation of intelligent and adapted solutions affordability for construction and operation are as important as a continuous user acceptance. In this, it should to be kept in mind, that approximately only 5% of the worldwide produced sewages are biologically treated, the rest is released completely untreated into surface and ground waters or the marine

environment. Considering this enormous field of work and potential for an application in practice one may resume that sustainable sanitary concepts stand for:

- Preventing pollution at the place of origin of wastewater by avoidance of hazardous substances
- Effective use of pure water by installation of water saving devices and use of rainwater and grey water where no drinking water quality is needed
- Reuse of nutrients on site by separating urine, faeces and grey water
- Production of energy from faeces and organic waste in biogas plants
- Agricultural reuse of biologically treated wastewater and sludge
- Providing evidence of economical efficiency of wastewater treatment
- Socially accepted solutions

SWAMP – sustainable water management and wastewater purification in tourism facilities as hotels, camping sites, holiday estates, etc. is of particular concern throughout the world. A great number of tourism facilities of various types throughout Europe do not yet have an adequate sewage treatment system or need to improve the existing one. In addition, tourism industry is more and more attracted by isolated virgin locations where neither water supply nor wastewater collection is available. A welcomed development beside these aspects is a growing tendency of tourists to consider the environmental matters and, relating requirements are increasing in all segments of the conventional tourism market. In the following chapters decentralised, but sustainable sanitation techniques are described to meeting typical features of tourism facilities as there are high seasonal or short-term wastewater flows and load variations, lacks of water, lacks of receiving waters, low maintenance capabilities of owners and, natural environments deserving special protection.

References

Deutsche Gesellschaft für Technische Zusammenarbeit (GTZ) & International Water Association (IWA) (2003)

ecosan – closing the loop

Conference materials, 2nd Int. Symp. on ecological sanitation, April 7–11, 2003
Lübeck, Germany

Windblad, U.; Simpson-Hébert, M. (ed.) (2004)

Ecological Sanitation

Stockholm Environment Institute, Sweden; 141 pp.

1.2 Wastewater and sludge in tourism facilities

Wastewater from tourism facilities in most cases are comparable with domestic wastewater, because generating sewage in a hotel or at an inn are similar to human activities in kitchen and bathrooms from households. But the concentration of the typical sewage parameters like BOD₅ or Nitrogen will differ according to the main focus of the site (restaurant, overnight stays, seminars, ...) and in relation to the addressed target groups (from pupils to seniors). So the composition of the wastewater will be specific for every tourism facility, and it can also change through the seasons and during a week, if there are special events scheduled.

To get an overview and data about the wastewater situation of a facility it is recommended to take 24 h mixed samples from the raw or settled wastewater for a typical period of the facility. A fortnight sampling period will give enough data for designing a treatment plant purifying the sewage of the site. At the best investigations should be done after water saving measures had be already installed. The survey should also include the water consumption and if available data about served hot meals, overnight stays and numbers of staff. Load, water volume and the concentration are the important parameters for designing the treatment facility. Data given in guidelines referring to the number of chairs in a restaurant or number of beds are very rough and in most cases plant designs based on these figures will be overdimensioned.

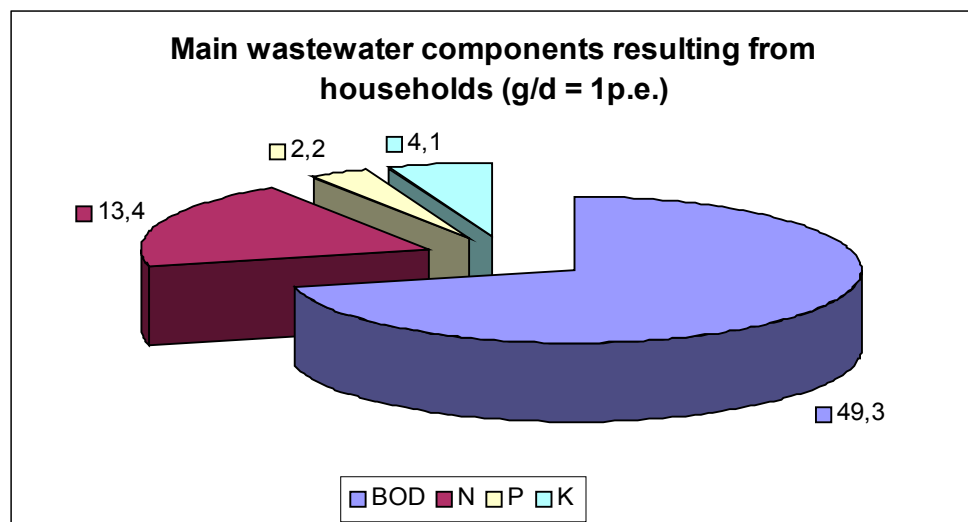

Figure 1: Main wastewater components resulting from households

Figure 1 shows the load of the main components in wastewater of a Western European household. Based on the above loads figure 2 shows average concentrations of the same wastewater components in mg/l, assuming a water consumption of 125 litres/day:

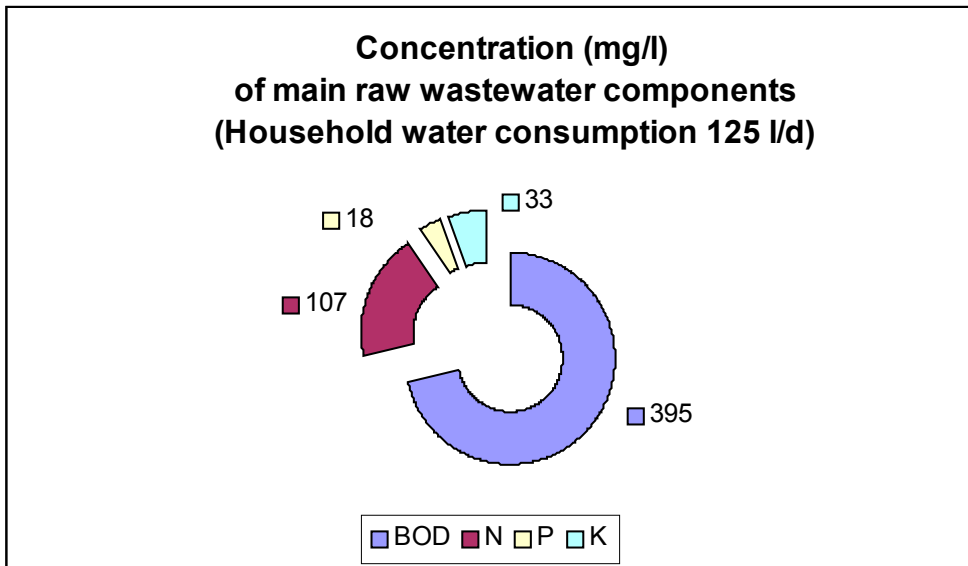

Figure 2: Concentration of main raw wastewater components

Concentrations of settled or raw wastewater of 13 demonstration sites of the SWAMP-project are given in the table below:

Plants	BOD ₅ mg/l		Nitrogen, total mg/l		Phosphorus, total mg/l	
	Range	Average	Range	Average	Range	Average
Pedvale, raw	449–1,464	847	32–107	66	2.2–29	17
Pedvale, settled	144–1,464	555	36–133	84	3–21	14
Tervete, settled	13–246	84	8–45	22	1–7	2
Pastoge, raw	240–400	320	89–176	117	10–28	19
Nikola, settled	132–388	247	127–199	157	13–20	16
Moränasee, settled	49–521	198	28–104	64	5–18	9
Pleschwirt, settled	491–2,161	967	60–266	149	9–22	16
Klug Veitl, settled	300–1,150	584	20–106	66	5–21	12

Plants	BOD ₅ mg/l		Nitrogen, total mg/l		Phosphorus, total mg/l	
	Range	Average	Range	Average	Range	Average
Fischerhof, settled	236–500	373	61–103	83	12–29	20
Weissmann, settled	83–310	177	75–150	113	12–39	21
Certosa, settled	9–82	40	17–86	54	0.6–9	5
Baggiolino, settled	13–140	84	10–142	79	1–16	7
Abetina, settled	7–105	65	11–78	51	0.01–9	5
Poppi grey, settled	364–502 (COD)	655 (COD)	0.4–3.7	1.7	6.4–6.7	6.6
Poppi black, settled	612–859 (COD)	745 (COD)	11–78	51	2	2

Table 1: Concentrations of settled or raw wastewater of 13 demonstration sites

Wastewater sludge

Wastewater sludge can be distinguished between two main kinds: One is originating from primary treatment and the other is produced during biological treatment by aeration with the activated sludge technology (surplus sludge). The last one consists only of bacteria with maximum 2% of dry mass and is less contaminated by hazardous substances like i. e. heavy metals as the sludge from pretreatment. Primary treatment sludge consists of 5 till 6% dry mass, completely composed by organic substances which settle inside a primary treatment system according to an appropriate retention time and flow speed. There are different technologies available to get rid of the sludge from simple septic tanks till four-chambers-tanks or Imhoff-tanks. Also open settlement ponds are in use. If using RBTS for biological treatment only primary sludge occurs and it has to be taken away for not invading the reed beds, creating clogging problems mainly in the vertical flow (VF) – systems but also in the horizontal flow (HF) ones. The following table shows figures of the SWAMP demonstration plants reporting how much sedimentation volume was installed in comparison to expected p. e. or average wastewater amount/d.

SWAMP-Plant	Pretreatment	Sedimentation volume [m ³]	Plant design pe	Sewage average [m ³ /d]
Pedvale (LV)	3 Septic tanks	23	45	5.4
Tervete (LV)	Septic	30	110	>70
Pastoge (LT)	2 * 1-chamber and 1* 2-chamber septic tanks	34	60	1.1–8.0/3.7
Nikola (LT)	4 * 1-chamber septic tanks	70	90	1.4–12/3.4
Moränasee (D)	Wastewater pond	1,900	900	150
Pleschwirt (A)	3-chamber septic tank	19	24	0.44
Klug Veitl (A)	3-chamber septic tank	11	42	1.7
Fischerhof (A)	3-chamber septic tank	61	162	13–24
Weissmann (A)	3-chamber septic tank	18	32	0.8–8
Certosa Hotel (I)	3 Imhoff tank, 1 one-chamber tanks	21	140	28
Baggiolino Farm (I)	2 two-chamber septic tank, 1 Imhoff tank	9	28	6
Abetina Shelter (I)	1 Imhoff tank, 1 Three-chamber tanks	12	40	8
Camping Poppi grey (I)	5 one-chamber septic tank	15	80	9.4
Camping Poppi black (I)	2*3-chamber septic tank, 1 Imhoff septic	28.4	80	6.5

Table 2: Key layout data of SWAMP constructed wetlands

There is a wide range of sedimentation volumes per pe Obviously it depends on the kind of the settling tanks and the suspended solids concentration. In average 376 l settling volume/designed p.e. has been calculated, the data of the wastewater settling pond are not included in this figure.

References

Swedish Environmental Protection Agency: Swedish EPA (1995)
What does household wastewater contain?
Report 4425, Stockholm

1.3 Separation of substance flows

Domestic wastewater can be distinguished and also separated according to its sources. The following sketch describes their names and their origin.

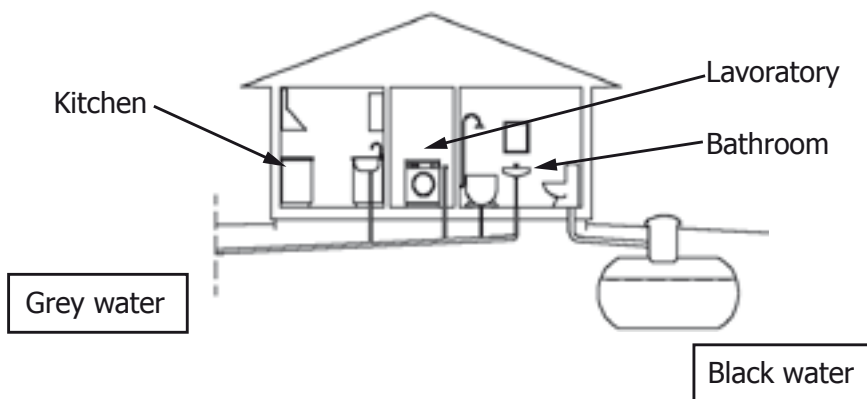

Figure 1: Domestic wastewater of different origin

The simplest segregation is obtained with the realisation of the different collecting systems, as shown in the picture above, for the grey and black waters. Normally grey water means summarizing all wastewater from a household except the flushing water with faeces and urine (black water). But for special purposes, i.e. to get more unspoiled grey water, it can be collected only from showers, bath and washing machine and the whole water from kitchen sinks or dish washer will be added to the black water. Another option is to install a degreaser before the septic tanks and to treat the whole greywater, including its kitchen fraction. Additionally the black water can be more diverted. Using water free urinals and/or urine separation toilets the urine can be collected and discharged separately and the faeces can be treated also separately or combined with the grey water. The sketch below shows one possibility of a diverting technology for black water:

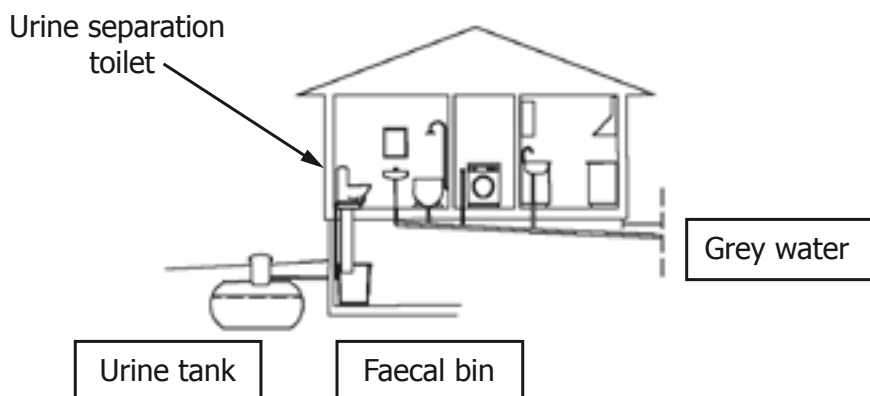

Figure 2: Diverting technology for black water

Looking at the wastewater components like BOD (the biodegradable organic content), nitrogen, phosphorus and potassium at black and grey water and urine and faeces, their specific composition differs very much. That is the most important reason for using separation technologies to create more efficient ways for wastewater treatment, nutrient reclamation and water saving.

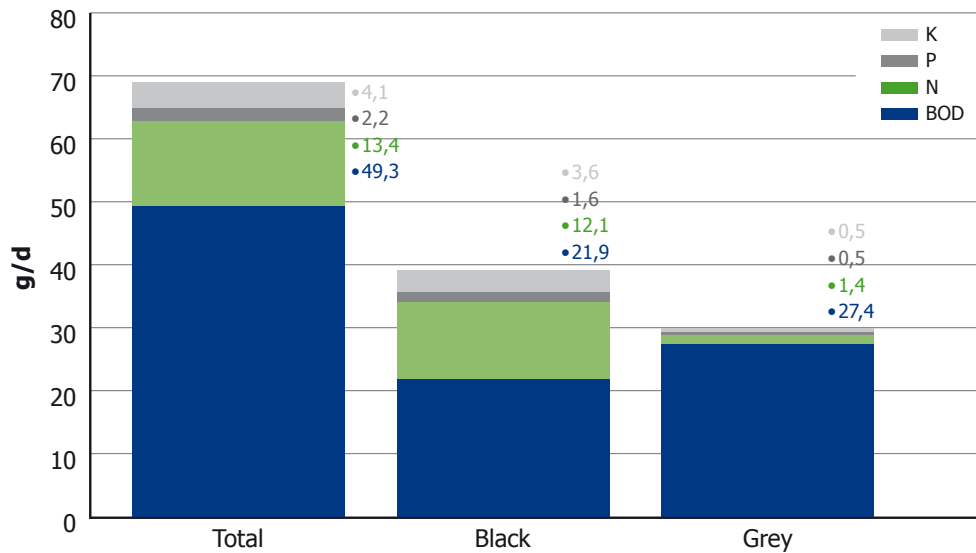

Figure 3: Composition of nutrients in black and grey water from households

The upper graph shows clearly that the main difference between grey and black water is related to the amount of nitrogen. But also the figure for BOD in grey water is less than in black water. The nutrients like N, P, K have three till ten times higher portions in the black water. It is well known that detergents are characterizing the grey water. Some of them, in particularly the non ionic poliethoxylates surfactants, can produce environmentally harmful biodegradation products, like bisphenols, which need to be removed before reusing the treated wastewater. It appears anyway very clear that greywater treatment isn't affected by concerns about nitrogen removal, which is one the most economical and technical difficult steps in a wastewater treatment process.

The graph below is investigating the black water on its main sources faeces and urine. Almost 91 % of the nitrogen, 69% of the phosphorus and also 69% of potassium stems from the urine. Faeces can be described mainly by BOD and bacteria, pathogens and non-pathogens. The urine, originally sterile will also contain hormones and pharmaceutical substances from drugs.

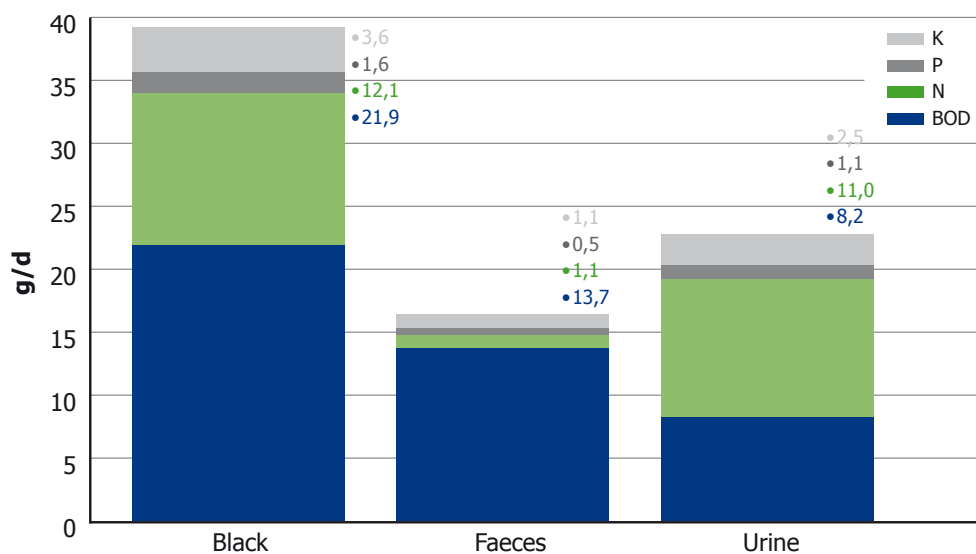

Figure 4: Composition of nutrients in black water, faeces and urine

References

Johansson, M.; Lennartsson, M. (1999)

Sustainable Wastewater Treatment for Single-Family Houses

Coalition Clean Baltic

1.4 Water saving potential

Water savings can be achieved by using various water saving devices and by behavioural changes in water consumption. It is recorded that by applying water-saving devices on taps and toilets in households the water consumption could be reduced about 50 % [EEA, 2002]. Combined with behavioural changes in water consumption substantial amounts of water can be reached. The potential of water saving in tourism facilities is similar to that in households, yet the user behaviour is more difficult to influence. A few sensitisation tools for owners, personnel and clients are described in chapter 2.1. Especially in tourism facilities water saving should not lead to a loss of comfort. Mainly technical solutions will be effective to reduce water consumption (chapter 2.2.)

Most of the water used for household consumption is for toilet flushing, bathing and showering, and for washing machines and dish washing [EEA 2001, EEA 2002]. From these, toilet flushing (33%), bathing and showering (20–32%) constitute the largest share of household water consumption pattern. The proportion of water used for cooking and drinking is minimal if compared to the above mentioned (3%).

Behavioural aspects in water saving are very important. It is relatively easy to reduce the demand for water in buildings while maintaining modern hygiene standards. The initial step in water conservation comprises simple measures such as showering instead of bathing, turning off taps, and fixing leaks promptly, all of which can contribute to significant water savings.

Like in households also in tourism facilities it is important to underline the relevance of water metering as a precondition for water saving measures. The experience shows that without water metering and supervision of water consumption no water saving effects occur. For example, after the installation of water meters in households in Hamburg the water consumption decreased immediately by 15%. Similar results have been acquired in the city of Copenhagen where after the installation of water meters the water consumption was reduced about 17%. Other studies report 10–15% decrease in water consumption only after installation of water meters.

A general description of water saving applications and the potential for water saving is given in the table below.

Equipment	Description	Water saving
Taps		
Taps with aerators	Introduce the air into the water flow thus increasing volume and reducing flow	Flow reduction of 50 %
Taps with thermostats	Temperature control – maintain constant selected temperature	50 % water and energy economy
Taps with infrared sensors	Water flow duration limitation	Highest water economy potential – between 70 % and 80 %
Taps with time control	Water flow duration control by specifying flow time	
Toilets		
Double command toilets	Command for 4-6 l/flush Command for 2-3 l/flush	50 % reduction
Water saving devices for old equipment		
Aerators	Increase the volume of water and thus reduce the flow	Reduction of around 40 %
Button to interrupt toilet flush	Water flow duration limitation	Reduction around 70 %
Devices to limit shower flow		Reduction of between 10 % and 40 %

Table 1: Typical water saving devices in households (Source: Fundación Ecología y Desarrollo 1999)

1.5 Rainwater harvesting

Rainwater is an alternative source of water, freely available and with some advantages compared to most mains water. However, rainwater harvesting should not be implemented before exhaustion of water saving measures.

Reasons to implement a rainwater collection system:

- water shortage alleviation
- more suitable water – soft water, particularly suitable for laundry, humidification, irrigation
- saving of money
- protection of the environment through restraint in use of resources
- reduction of stormwater peaks and flow¹, thus assisting in flood protection.

Conserving our valuable drinking water and reducing the demand on water supply becomes increasingly important with growing water stress. The Water Utilities response to increased demand has been increased abstraction from existing sources, completed with current plans to develop new reservoirs. This approach solves immediate problems, but does not provide a long-term sustainable solution to the problem of supply. Therefore demand management needs to be employed before further supply side measures are considered. Conserving water also reduces the chemical and energy requirements for treating and transporting water to your home via the mains water supply.

Using your rainwater for day-to-day purposes like toilet flushing creates space in your tank for more water the next time it rains. Surface run-off of rainwater from buildings accounts for approximately 60% of the burden on already overworked sewage systems. With an increase in storms and weather surges expected due to global warming, this will also help alleviate flooding at peak times in the future.

¹ In Germany this aspect is particularly interesting also from an economical point of view as the connection to the rainwater drainage system is subject to a fee related to the roof area connected.

1.6 Experiences and recommendations from SWAMP

1.6.1 Importance of preliminary assessment and variant analysis

In SWAMP we started our work on the tourism sites with extensive investigations about the actual situation. This turned out to be very useful for several reasons:

- Figures found can be quite different from those given in literature and regulations and differ substantially from one site to another
- Owners have or give no exact appreciation of their situation
- Results are directly available for the design of the water management measures and the wastewater treatment.

The investigation focused on the following issues.

1. Flow and flow variations

In order to get a fair appreciation of the actual flow to be expected, own measurements are often necessary. As existing wastewater systems, which are often not built in view of a treatment in the first place, are mostly not suitable for measurements, the easiest way is to meter the water consumption. The results have then to be checked towards water usages in order to obtain the expected wastewater flow. A list of water consuming devices together with an assessment of their water consumption is most helpful at this stage. A standard form was developed, that is attached as annex to these guidelines. Additionally it was very important to get figures how many people or guests were living at or visiting the facility during the flow measuring period. The water consumption is directly related to the number of users.

For direct wastewater flow measurement we either used a small bore magnetic flowmeter or a tipping bucket gauge we developed for that purpose. The tipping bucket gauge is more suitable for the relatively small flows normally encountered with remote tourism facilities.

The flow variations are an important input for the treatment design. There are most likely distinct variations, which may or may not have a defined frequency: weekly or seasonal with peaks on weekends or during the warm or the cold season for example, or both, related to the type of tourism. The flow of peak periods has been almost 20 times higher than that of low flow periods.

2. Very different specific water consumption

But for two sites all plants were receiving wastewater only, i.e. no rainwater entered the sewerage systems (exceptions were the Tervete sanatoria in Latvia and the Moräna plant in Germany). Comparing the different sites which were investigated, however, specific water consumption and resulting discharges per pe differed a lot. The values were ranging from less than 100 l per pe to 600 l and more. In our cases the smallest discharges were observed in Austria, the highest in Italy. This may have to do with national particularities but may also be linked to the type of tourism facility.

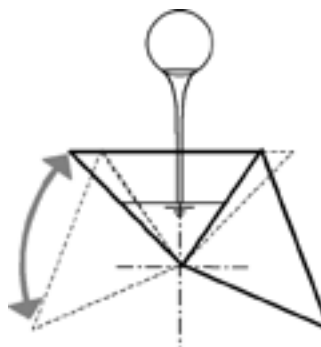

Sites	Hydraulic load variations [m ³ /d]			
	max	min	average	ratio
Baggiolino	6.6	0.38	2.0	17.4
Certosa	37.0	17.7	26.6	2.1
Pleschwirt	1.1	0.58	0.85	1.9
Reinischkogel	3.1	0.6	1.7	5.2
Karawankenblick	8.0	0.5		16.0
Fischerhof	6.2	1.2	2.8	5.2
Moränasee	90.0	20.0		4.5
Pastoge	6.0	1.0	2.0	6.0
Pedvāle	3.9	0.7	1.5	5.6
Tērvete	147	12	71.7	12.3

Table 1: Measured flow variations in tourism facilities

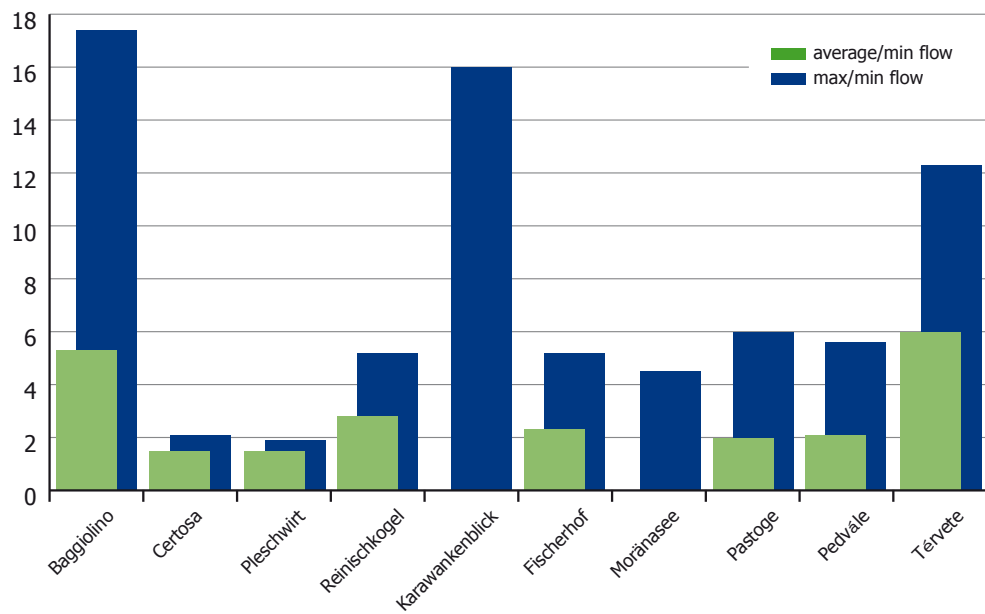

Figure 1: Ratio of minimum to average and maximum flow for some of the SWAMP sites

3. Very different concentrations

In correspondence to the water consumption the concentrations of the main pollutants in the wastewater are strongly varying. Values of COD between 120 and 1,500 mg/l were found at the different sites and remained quite stable throughout the monitoring period for each site. It is obvious that this has an impact on the treatment process and therefore must affect the design and performances.

Analysis of the wastewater before implementation of the wastewater scheme however may prove difficult. Sampling raw wastewater may result in random results, which are not taken into consideration if too far out of the most common literature figures, even if they might be confirmed later. Taking samples of an existing primary treatment is another option. The technician has to be careful to really analyse wastewater and not a mixture of wastewater and old sludge or scum. One or two samples and analysis of TOC (or COD) and ammonia–nitrogen may be a first indication as for the quality of the wastewater to be expected.

The best method to characterise the quality of the raw wastewater of a facility is to take 24 h samples from the flowing raw sewage. For the detailed description of the procedure see chapter 1.2.

The data obtained may be checked towards the consumer behaviour and water consumption of that particular site. Possible water saving measures should be taken into consideration, of course, for the evaluation of the final wastewater to be treated.

In this respect the sole concept of limits for concentrations in the outlet can be a disappointing approach. Extensive water saving measures could lead to outlet concentrations exceeding the requirements of the water authority, although the pollutant load is effectively reduced. Thus water saving is penalised by the false impression that the treatment performance drops due to water saving measures, which is against a sustainable approach to water management. Therefore it is recommended to include loads into the assessment of the treatment performance.

The detailed investigation leads to the following results concerning the water management and the wastewater treatment:

1. Optimisation of the water management

The knowledge of the systems allowed to decide about the best improvements to the water management systems. These included but may not be limited to:

- Consumption reduction, e.g. choice of better flushing systems, exchange of taps, shower heads, water consuming appliances. Implemented examples are infrared controlled urinal flushing valves, waterless urinals, a water efficient dishwasher (3 l instead of 25 l per cycle) and an up-to-date washing machine. For taps and showerheads used see the catalogue;
- Grey water segregation, which is one of the most efficient water saving measures. In SWAMP this was only possible at one site where the treated greywater was used for landscaping. At all the other sites the owners could not yet be convinced of implementing this technology. Grey water segregation would also allow to recover the energy contained in the grey water;
- Reuse needs and possibilities; the reuse purpose influences the treatment requirements, for the available regulations on one side or in order to optimise the reuse, e.g. combine reuse of water and nutrients for irrigation. There are different reasons to aim at the reuse of wastewater, especially in decentralised sites: Water scarcity, natural water reserves preservation, lack of a final receiving water body, nutrients recovery and related energy savings (at wastewater treatment and chemical fertiliser production).

2. Sizing of the primary treatment (buffering section and sedimentation)

SWAMP used three different types of primary treatments:

- 3-chamber septic tanks: volume of 600 l per pe minimum or according to national regulations
- Imhoff tanks (for layout see Section 2)
- Facultative pond

No rack or grit channel was installed, as the owners run the plant themselves and can widely influence what is disposed of via the sewer. There was no problem because of the lack of these devices during the monitoring period. A degreaser, best for the kitchen wastewater only and anyway only for the grey water, is imperative in order to protect the constructed wetland. If weekly load variations were observed a buffer tank was implemented in order to even the flow over the whole week. In one case the seasonal peak was buffered in a polishing pond in order to reduce peak flow into the receiving water, which was limited to a maximum value by the water authorities, and to accumulate during winter.

3. Sizing of the wastewater treatment

The sizing of the wastewater treatment components are covered in detail in Section 2. Below a few special recommendations are listed.

It is obvious that decentralised systems are more subject to load variations than larger systems. This is even more true for most tourism facilities, which are depending on holidays and other traveling seasons. Buffering peak flows can therefore have an important impact on the dimension of the core wastewater treatment element, which was a constructed wetland in most SWAMP cases. Buffering is easiest for short periods, e.g. weekly cycles where load may mainly occur on week-ends.

Whereas the constructed wetland itself may buffer short peaks, it will have to be dimensioned for the average flow of longer peaks.

In this case the period when peak flows will occur should be taken into consideration. If the tourism facility has a distinct summer season the treatment, which is temperature sensitive, has to have its maximum yield during the warm period, when it performs best anyhow. Especially in cold climates you may have a winter season peak, e.g. in a winter sports resort, which means the treatment needs to achieve best performances when it is most difficult from the environmental conditions point of view (cold temperatures, snow cover). These aspects should be taken into account for the sizing of constructed wetlands. Horizontal bed kinetic formulas take temperature into account. For vertical beds, such a tool does not exist, but the specific areal coefficient (m^2/pe) could be decreased or increased according to which season is the limiting one for the size of the structure.

1.6.2 Wastewater secondary treatment by constructed wetlands (RBTS)

Generally speaking the application of constructed wetlands as secondary treatment stage in the SWAMP facilities has shown how this kind of wastewater treatment satisfactorily complies with the requirements in each different case. The main advantage using RBTS has been the quite constant quality of the effluents despite the high seasonal fluctuations of the loads. These extensive treatment techniques can be considered very reliable, due to their high buffering capacity, especially for an efficient treatment of wastewater of touristic facilities during all the time, without temporaneous failures caused by sudden variations in quantity and quality of the inlet water. All the different techniques that have been chosen in the SWAMP demonstration sites (HF RBTS, VF RBTS, Pond + VF RBTS, HF+VF RBTS) have

obtained the expected removal rates for all the monitored pollutants. The SWAMP plants monitoring results have suggested the following conclusions and reflections:

1. A clearly lower elimination of micro-organisms in vertical beds than in horizontal beds has been observed; it is therefore advisable to choose a HF bed whenever disinfection must be obtained with natural treatment alone (for instance absence of electric power close to the plant).
2. Winter operation at nominal load (maximum eligible load) has been found being quite critical in two cold climate plants according to Austrian design (5 m²/pe), having obtained outlet values very close to the regulation limits; unluckily during those peak events the operation of the RBTs was affected by extraordinary malfunctions (like for instance a leakage in the floating valve for pulse feeding) which is why it is not clear if the outlet concentration peaks are related or not to the low temperature.
3. The hybrid RBTs HF+VF has shown the best performances in terms of obtained results in comparison with the area of the plant itself; since the "Phragmites" plantation grew up the Relais Certosa Hotel plant has constantly reached the national regulation limits for irrigation water; this kind of configuration permits furthermore to complete the nitrogen removal process, when needed, with the recirculation of the final effluent into the primary stage.
4. Amongst the several VF RBTs that have been realised in the SWAMP project, some different energy free feeding systems have been tested: Siphons as well as floating valves have shown that they can work properly when well conceived and rightly applied. The design has to guarantee that the ratio between inlet and outlet flows in the whole pulse feeding system is always less than 1.
5. If there is no tourist peak during all winter the sizing of RBTs can be based on summer operating conditions, especially when using HF or hybrid systems; this assumption can produce a considerable reduction of the needed area for obtaining the chosen treatment goals.

1.6.3 Easy-to-implement water saving measures

This section and also other sections in these guidelines present and discuss water saving appliances and techniques. Such appliances are also listed in the catalogue prepared in SWAMP. We recommend however a more comprehensive approach with a European wide certification system for water efficiency of appliances, similar to the energy certification introduced by the EU. For example WCs working with 6 litre for flushing solids should be the standard, lesser amounts could be declared as water saving. Every toilet should provide for the possibility to interrupt the flushing stream, which is important to save water when flushing away urine.

Swamp sites comprised new as well as existing buildings. With a building to be newly erected the engineer or architect is free to choose among the complete range of water saving measures, the choice finally depending on the economic feasibility and very much on the personal wishes of the owner. In an existing building there are much more constraints. However, SWAMP showed there are a few measures, which are very easy to implement and have a short pay-off time. These include:

- Water saving taps, with thermostat taps for showers and bath tubs and one lever taps with cold water in the middle position together with an adjustable flow limitation;
- Water saving shower heads;
- Infrared controlled valves for single urinals, which can be easily fixed in the feeder pipe of each urinal.

Replacement of old flushing toilets or household appliances with water efficient ones may have to wait until the end of the old appliance's lifetime, even though replacement can save a lot of water. Immediate exchange may be possible when water fees are sufficiently high to allow for very short payback periods, as is the case in Germany.

1.6.4 Wastewater segregation: experiences with grey water

Even though grey water segregation is a very interesting and sustainable technique we could only identify one site where the owner was willing to try it in order to reuse the treated grey water for landscaping. No domestic reuse could be implemented. Further efforts have to be made to spread this interesting technique, which can be combined with the recovery of the energy contained in the grey water from bathrooms. A few encouraging examples already exist, e.g. the Arabella Hotel in Munich.

SWAMP could realise two examples of urine segregation at Burg Lenzen and Augustenhof. The experiences were very encouraging from a technical point of view. Reuse of the urine, however, could not be tested during the project period, as permits by the authorities were still pending. Segregation of urine eliminates most of the nitrogen and at least half of the phosphorus from the wastewater. Urine is a quite pure substance with high fertilising value.

1.6.5 The SWAMP experience with water reuse regulations

Some countries, especially those with scarce water resources, have recently developed and introduced regulations for wastewater reuse. This is an important first step towards generally accepted rules for wastewater reuse. However, regulations are not available for all countries and are not coherent throughout Europe. Whereas they emphasise the protection of the consumer, the regulations still contain obstacles for an integrated water management (see the Italian law D. Lgs. 185/03 that limits nutrients content in reclaimed wastewater to 15 mg/l of N and 2 mg/l of P), which do not contribute to the protection of the consumer.

Especially tourism, but also irrigation of export crops are cross-border activities, where national guidelines are not sufficient to satisfy the needs of all those involved. Therefore regulations for reuse should be developed at a European level and they should aim at encouraging reuse rather than preventing it. This lack of regulations was one of the main obstacles SWAMP encountered when discussing wastewater reuse with owners and authorities.

Section 2

DESCRIPTION OF TECHNIQUES

2.1 Sensitisation and awareness raising

Involving the stakeholders, i.e. the owner, the guests, the personnel of a tourism facility, to contribute to the common goal of sustainable water management is a condition sine qua non of the success of any (such) project. Its importance is easily overlooked by technical consultants, especially in industrialised countries. Obviously at least the owner must already have a certain readiness to implement environmentally friendly techniques.

It is very clear that until now authorities, too, are reluctant to engage in sustainable techniques. But though this is also due to personal experiences and inclination to a great extent, authorities are mainly depending on laws and regulations. That is the level, which has to be dealt with in order to reach out to authorities.

Information and sensitisation of the owner

Providing information about products and techniques is a first step. Most owners are not aware of developments in sanitation. Trying new techniques may also raise fears about clients objecting or uncontrollable costs.

Visiting other sites, where sustainable techniques have been implemented, discussions with owners or managers of such premises may be able to convince interested persons to go for a try. Presenting advantages, e.g. autonomy, reduced costs, reliability of systems and resource availability on one side and possible problems on the other assists the owner in making her or his own assessment and decision.



The tourism facility should make its sustainability efforts public, best under a friendly logo, as does the city of Zaragoza, the water saving town with its water harvesting umbrella

The consultant should discuss actual water consumption and reduction possibilities (see also chapter on auditing), compare actual consumption to figures from other places. It should be made clear that a wide set of water saving measures are possible without loss of comfort for the clients. The owner must see a possibility to make an asset of the facilities sustainability effort, either because the help saving money or because they generate income through more satisfied guests.

The owner will want to have a set of tools for information of clients and personnel. Information for guests must be provided in order to prevent the management to fear negative reactions by the guests. The implementation of an Environmental Management System (EMS) such as ISO 14001 or EMAS could be very useful to improve internal and external communication about the company's environmental commitments, but it is often not

applicable, given the average dimension of tourism companies. Another useful tool could be the application of an Environmental label, such as the EU Ecolabel for tourism accommodation, that could be more easy to achieve. Both EMS and Ecolabels, however cover all the environmental aspects of the activity and not only water management (see below).

A few water related examples of information texts are given as annex.

Sensitisation of the personnel

The personnel is involved in a lot of water related activities and may also be responsible for the procurement, depending on the size of the facility. On one side the personnel can assist in water saving, procurement of environmentally friendly products, abolition of inappropriate practices. On the other side they are confronted with unfamiliar techniques, e.g. waterless urinals, new cleaning methods and products. Changes are not necessarily welcome with personnel. According to field reports the biggest problem with waterless urinals having a liquid seal is the cleaning personnel pouring large amounts of water into the urinals and thus flushing out the seal, which causes the urinal to smell thus making it a nuisance, and in the long run generating high cost for seal liquid.

Therefore the personnel must be won as partners in the drive to sustainability. Involving concerned personnel in the decision process is good practice, may yield useful ideas and increases dedication during implementation. A general commitment by the facility to sustainability will encourage the personnel to endeavour in this direction. Information about advantages is important to make changes accepted more easily. The owner should receive information material and adopt a strategy to inform his personnel and provide training for the familiarisation with the new requirements.

Participation of the customers

The clients are on holiday. It is sure they want to relax and not bother about a lot of new and complicated rules let alone restrictions. Still they can and mostly are willing to contribute to the owners efforts. Best is to give them a choice. What can they do:

- close taps, e.g. during tooth brushing;
- save laundry, especially by keeping towels;
- take showers instead of bath, no cooling or heating under the shower;
- prevent undesirable objects of entering into the sewer by using the appropriate and provided for way of disposing of.

Make your clients feel good if they participate at your efforts at keeping the site environmentally friendly. Information of the customer is of paramount importance, at the hotel entrance, in the bathroom ...

A few examples of how to inform the guests are attached as an annex you will find in SECTION 4 APPENDICES. They include:

- Leaflets of SWAMP
- A text concerning towels
- The example of an action by a hotel in Seville, Spain.

People must consider their contribution and sustainability efforts not a nuisance but an asset and they will be happy to participate.



The information must not necessarily look as makeshift as this communication in a hotel in Kenya, but the meaning remains valid.

2.2 Water saving devices, appliances and techniques

2.2.1 Water saving potential

Taps

A typical basin tap or shower running at mains pressure can easily deliver 20 litres per minute or more. This will apply to most cold water supply and hot water supply running from a combination boiler or pressurized hot water storage cylinder. The most effective methods of reducing water from taps are to fit spray inserts, flow restrictors or aerators to new or existing taps. Most European taps have threaded outlets to which these can be fitted. There are also taps where the user has to consciously increase the water use and switch to hot water (saving energy). Many companies provide monoblock taps with a water saving cartridge or water-saving inserts. There can also be such solutions as valves with integral flow restrictors, which not only can save water, but also can improve the performance of piping system by balancing flow and so helping to stabilize shower temperatures. Generally, showers use less water than baths except in the case of power showers. For water saving the flow restrictors can be used. Flow restrictors for showerheads are available for different types of showers and many different types are available in the market. The easiest way to save water with existing basins and showers is to fit a flow restrictor. For basins flow regulating access valves are recommended. All outlets are now required to incorporate an isolating valve so that the supply can be turned off for maintenance. Flow regulating access valves simply replace the standard access valve. For showers, the flow regulator is most easily fitted to the flexible hose to the shower head.

Toilets

The WC typically uses 30–40% of total household water use, and even more in many commercial premises, so the potential for water saving is significant. The easiest way of saving water in toilets is to install a volume reducer in a conventional cistern, for example a 'hippo' or a brick. This can, however reduce the efficiency of the flush to the point where there is a need to flush again, defeating the object. Many pans simply don't work well with reduced, or even full, flush volumes. The more effective answer is to install, water-efficient WCs. These are specifically designed to clear the pan effectively with smaller flush volumes. Not only are they good for the environment, but where water is metered the financial payback can be as little as 2–4 years, depending on household size and local water and sewerage charges. Water efficient toilets make sense on all fronts. Standard urinals require a lot of water. Waterless urinals are now being installed more extensively, leading to a reduction in commercial water use. These can often be justified on purely financial reasons. However, almost all-waterless urinals currently utilize some sort of disposable cartridge or other consumable, which results in significant running costs as well as environmental impact. It is however quite feasible to design waterless urinal systems with no consumables which are virtually maintenance free. It should also be considered that especially for flushing toilets fresh water can also be replaced by rain water or purified grey water.

Other domestic appliances

Dish washers and washing machines for clothes contribute to a significant share of water consumption in households. The general rule of their water consumption pattern is that older equipment is very inefficient in terms of water consumption whereas newer models require less water. A study carried out within activities of the SWAMP project showed significant difference in dish washing machine water

consumption patterns i. e. newer dish washing machine models consume up to 8 times less water than older machines (see Table 1).

Dish washer	Unit	Old washing machine	Newer washing machine models
Water consumption/cycle	litre	25	3
Cycles per day*	unit	25	25
Total water demand	litre	625	75
pe hydraulic	litre	150	150
Hydraulic load by dish washer	pe	4.17	0.50

Table 1: Dish washing machine water saving potential (Data: SWAMP project)

* 100 meals per day @ 4 pieces of tableware were assumed. This is conservative, as the inn has 25 beds, and guests to the restaurant (60 seats) and terrace (30 seats)

Similar is the water consumption pattern at washing machines. Over the past 25 years water consumption per washing cycle has fallen from 150 litres to approximately 50 litres for most efficient models. But still there are low-end machines in the market that can consume more than 100 litres of water per washing cycle.

2.2.2 Water saving devices

Flow regulating devices

Flow regulators

A flow regulator is used to maintain a predefined constant flow rate independent of the prevailing line pressure. Typically flow regulators can automatically compensate for pressure variations up to 10 bar. Applications: faucets, showers and instantaneous water heaters. Flow regulators can be used in any appliance where water should be intelligently distributed, particularly in areas where a severe mix of line pressure occurs, flow regulators provide a stabilized rate of flow. Flow regulators are a very cost efficient alternative to more complicated mechanical regulating devices due to their small size and rugged design. Flow regulators are often used in combination with faucet aerators to reduce water consumption.

Faucet aerators

Faucet aerators break the flowing water into fine droplets and entrain air while maintaining wetting effectiveness. Aerators are inexpensive devices that can be installed in sinks to reduce the volume of used water. They can be easily installed and can reduce the volume of water use at a faucet by as much as 60% while still maintaining a strong flow. More efficient kitchen and bathroom faucets that use less than 7.5 l/min, in contrast to standard faucets, which use 12 to 20 l/min, are also available [Jensen, 1991].

A project was carried out in Gothenburg, Sweden to evaluate the cost effectiveness of water saving measures: old two-handle mixers have been exchanged with new mixers on a house with 65 flats. Results showed that 26% of cold water and 28%

of hot water could be saved by installing modern taps, thermostatic mixers in the bath/shower and single-lever mixers in the kitchen. In addition, the single-lever mixers were thereafter supplied with two water saving techniques and this resulted in 51% cold water and 38% hot water savings. The yearly energy saving for the whole house, including the gains from water saving techniques, was calculated to 84 MWh.

Low flow showerheads

By replacing the standard 18 l/min showerheads with 10 l/min showerheads, which cost less than 10 Euro each, up to 80 m³ of water can be saved per year for family of four. Properly designed low-flow showerheads, currently available, are able to provide the quality of water delivery found in higher volume models. Although individual preferences determine optimal shower flow rates, properly designed low-flow showerheads are available to provide the quality of service found in higher-volume models. It is estimated that by installation of low flow showerheads, indoor water use per person can be reduced by up to 10 percent.

Low-flush toilets

3 to more than 5 gallons of water are utilised per flush in a conventional toilet. Low-flush toilets use only about 1.6 gallons of water per flush. Since low-flush toilets use less water, they also reduce the volume of wastewater produced [Pearson, 1993].

So far for 1993. While in some cases the "standard" flushing cisterns of 3 to 5 gallos, or 12 to 20 l, still exist, 1.6 US gallons are 6 l, which is present day standard. Low flushing toilets use less than 3 litres.

Pressure reduction

The maximum water flow from a fixture operating on a fixed setting can be reduced if the water pressure is reduced. For example, a reduction in pressure from 6 to 3 bar at an outlet can result in a water flow reduction of about one third [Brown and Caldwell, 1984].

Homeowners can reduce the water pressure in a home by installing pressure-reducing valves. The use of such valves might be one way to decrease water consumption in homes that are served by municipal water systems. For homes served by wells, reducing the system pressure can save both water and energy. However many water use fixtures in a home, such as washing machines and toilets, operate on a controlled amount of water, so a reduction in water pressure would have little effect on water use at those locations. Reduction in water pressure can save water in other ways: it can reduce the likelihood of leaking water pipes, leaking water heaters, and dripping faucets. It can also help reduce dishwasher and washing machine noise and breakdowns in a plumbing system.

Other low cost technical solutions

Toilet displacement devices

In order to reduce the amount of water used for toilet flushing, plastic containers (plastic milk bags, for instance) can be filled with water or pebbles and placed into a tank. By placing one to three such containers in the tank (making sure that they do not interfere with the flushing mechanisms or the flow of water), more than 4 litres of water can be saved per flush. A toilet dam, which holds back a reservoir of water when the toilet is flushed, can also be used instead of a plastic container to save water. Toilet dams result in a savings of a couple of litres of water per flush [USEPA, 1991b].

2.2.3 Operation requirements and costs

System Costs

According to Article 9 of the European Water Framework Directive (WFD) Member States are obliged by 2010 to ensure, that their water-pricing policies recover the costs of water services and provide adequate incentives for the sustainable use of water resources. Thereby full-cost recovery requirement can be considered as important instrument to stimulate a more sustainable use of water resources and enhance the introduction of water saving technologies and devices.

There are very few data about costs of implementing water saving measures in Europe. Available information shows that the cost of water conservation measures may vary with the cost of equipment required and size and location. The cost of replacing a conventional toilet with a low-flush toilet can be in range from 100 Euro up to several hundred Euro. Costs for low-flow showerheads, are starting from 10 Euro each. The costs for the installation of water meters range from about 100 Euro for interior meters up to 1,000 Euro for external meters [data from European producers].

The existing experience shows that the payback time for the installation of water saving devices can vary in wide range. For low-flush toilets the payback time ranges between 2 and 5 years depending on particular installation. The installation of flow restricting devices and aerators can have a payoff time from several months to several years.

An economical evaluation of the Gothenburg project showed that to change to thermostatic mixers and single-lever mixers with eco-effect with all installation costs included, gave a payback time of 2.4 years. The payback time of switching to single-lever sink mixers has been estimated 1.3 years (without installation costs). Corresponding the payback time for the single-lever basin mixer or a thermostatic mixer in the bath/shower is less than 1.9 years.

Maintenance requirements

Given the variety of measures that might be undertaken to address water conservation, of which most are mechanical but many may be technological or informational, it is difficult to identify specific operational and maintenance requirements. However water saving devices are designed for prolonged operation, and require periodic maintenance. Some of the more obvious requirements include the following: low-flow water conservation devices require periodic maintenance and repair; water meters require periodic testing and repair. Maintenance requirements include regular inspections of mechanical devices.

References

Brown and Caldwell, 1984

Residential Water Conservation Projects

Summary Report. US Department of Housing and Urban Development

Commission of the European Communities, 1999

Pricing water – Economics, Environment and Society

Sintra

Commission of the European Communities, 2000

Pricing policies for enhancing the sustainability of water resources

EEA ETC/IW, 1999

Sustainable water use in Europe. Part 1: Sectoral use of water

European Environment Agency

Sustainable water use in Europe. Part 2 Demand management

Copenhagen 2001

European Environment Agency

The water indicator report: An indicator based assessment of Europe's water resources

Copenhagen 2002

Fundación Ecología y Desarrollo 1999,

El periódico del agua

March 1999, Zaragoza, Spain

<http://www.epa.gov/ow/you/>

Jensen, R. 1991

Indoor water conservation

Texas Water Resources

Pearson, F.H. 1993

Study documents Water Savings with Ultra Low Flush Toilets

Small Flows 7(2)

Roth, E. 2001

Water pricing in EU: A review

European Environmental Bureau

USEPA, 1991b

Water Conservation Measures for Everybody

Fact Sheet Nr. 21

Washington D. C.

2.3 Separate grey and black water collection and treatment

2.3.1 Characteristics and yield/efficiency

Any water that has been used in households, excluding fecal water from toilets (black water), is called greywater. Shower, sink, laundry, and dishwashing effluents represent up to 60% of residential wastewater.

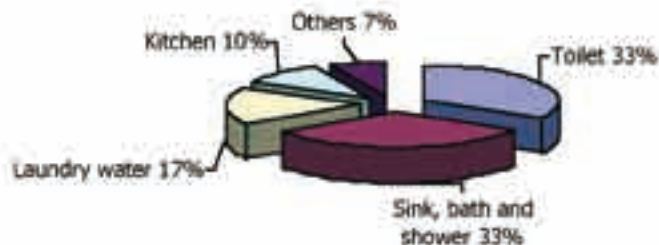

Figure 1: Relative quantity rates of residential wastewater

The absolute amount of greywater produced can vary considerably from West-European 40 l/cd in rural regions up to more than hundred litres. Presupposing the installation of watersaving devices at showers, taps and toilet flushings a West-European household (drinking water consumption: 80–130 l/cd) on average produces 40–80 litres of greywater per capita and day. As drinking water is constantly used, domestic greywater is available in a constant quality and quantity. This is an important advantage for the reuse of greywater for toilet flushing, indoor and outdoor irrigation of plants and cleaning purposes. Major benefits of greywater reuse are the reduction of need for fresh water supply and sewage treatment. Especially in areas with low precipitation rates and water supply deficiencies, reuse for landscaping also has a benefit in reducing demands on public water supply. Energy in greywater especially from hot-water showers may be reclaimed by heat exchangers.

	BOD₅ [mg/l]	COD [mg/l]	TOC [mg/l]	Dry Solids [mg/l]	N_{tot} [mg/l]	P_{tot} [mg/l]	Faecal Coliforms [cfu/ml]	Coliforms [cfu/ml]
WOHNSTADT, 1998	100–130	200–250	120–130	70–90	–	–	–	–
Jefferson & Laine, 1997	–	257	–	78	–	–	–	–
Bahlo, 1999	240	470	–	–	22.0	2.0	–	–
Fitschen & Niemczynowicz, 1997	165	361	–	–	18.1	3.9	–	–
Nolde, 1999	BOD ₅ : 5–360	100–600	–	–	5–18	0.2–4.5	10 ⁰ –10 ⁵	10 ³ –10 ⁶

Table 1: Quality of untreated greywater

The composition of greywater reflects the lifestyle of the residents and their use of household chemicals for washing-up, laundry etc. From the perception of purification the composition of greywater varies only to a small extent. Greywater is characterised by less suspended solids and contains only about 50% of easily degradable organic substances (BOD), 10–20% of the nitrogen compounds and 10–30% of the phosphorus compared to a normal mixture of domestic grey and blackwater. Phosphorus concentrations can be elevated originating from dishwasher detergents in special cases. In comparison with faecal sewage abundance of pathogens in greywater is generally low. Although raw greywater may contain faecal indicator organisms, it is extensively free from high-risk microorganisms and, therefore normally regarded as rather hygienically harmless [Ridderstolpe, 2004].

2.3.2 Design and layout recommendations/devices available

Before deciding on any course of action concerning reuse of greywater first of all an owner should scrutinise the full technical and organisational potential of saving drinking water. Secondly, in regions with adequate rainfall one should take into account harvesting of rainwater which is of higher hygienic quality than greywater, reduces consumption of detergents and, does not need a complex treatment procedure. In case sufficient greywater can be collected for treatment a greywater recycling system may preferably be applied in dry regions and in places where for local terms rainwater harvesting has to be dropped.

Collection of greywater

The installation of greywater treatment plants and reuse of treated greywater requires the compliance with national technical regulations for drinking water installations, drainage systems and wastewater treatment. Strict separation of pipes for drinking water and service water (rain water, greywater, etc.) and clear labelling of taps and devices are mandatory.

Plumbing trade for blackwater and greywater does not differ very much. Within a building both types of wastewater will be transported in permanently separated plastic pipes. While household wastewater downpipes are normally 100 mm in diameter, 60 mm are sufficient for greywater pipes. Pipe systems in general must be equipped with an air vent above rooftop. Greywater treatment plants can be installed within a building in order to recycle the water for purposes that do not need drinking water quality (as toilet flushing or washing machines). This is especially an advantage for buildings that are not connected to a public sewer and water supply system as tourism sites in remote areas. Thus, the water consumption and the wastewater quantity are reduced and with them the costs for water supply and wastewater treatment.

Greywater treatment

There are many ways to treat greywater for a hygienically safe reuse. In practice, greywater which is intended for reuse should be collected free from high organically loaded kitchen wastewater. The remaining greywater from baths, showers, washstands and washing machines has to be collected separately from the black water, treated, biologically purified and stored as "service water" that must not necessarily have drinking water quality. For needs with high hygienic requirements, greywater can be treated with UV disinfection. Treatment schemes for greywater collecting nets in tourism facilities may comprise of:

- degreaser (kitchen water)
- primary treatment/buffering tank
- secondary biological treatment
- UV-disinfection (optional)

- storage tank
- booster pump station

Examples of technical treatment systems that have been proved and tested in routine operation are shown in the graph below.

1. Vertical- or horizontal-flow reed beds
2. Multiple Rotating Biological Contactors (RBC)
3. Modular multi-stage Sequencing Batch Reactors (SBR) with an aerated flow-bed
4. Membrane techniques (MBR, ultrafiltration, etc.)

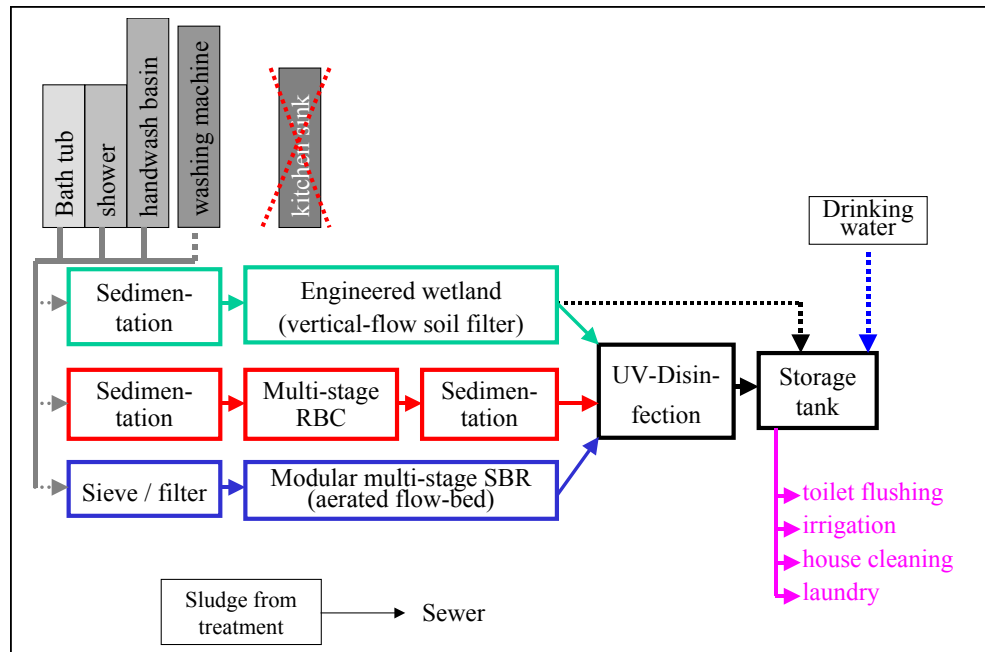

Figure 2: Processing paths for greywater recycling (NOLDE, 2005)

Depending on local conditions, requirements and regulations, the systems will be operated with or without a final UV-disinfection. Biologically treated and disinfected greywater can safely be used as laundry water. Compared to faecal sewage in greywater treatment only a small amount of primary sludge is produced. Due to process-related production of excess sludge (secondary sludge) technical plants as RBC, SBR and MBR do need a sewer connection. Stored greywater will be distributed by a compressor waterworks or discharged. In case of a technical breakdown of a treatment plant or high demand of treated greywater a storage tank should be automatically fed with drinking water. In order to prevent algae growth service water should be stored in darkness and at low temperatures. It is recommended to directly store the treated greywater in a concrete or polyethylene earth tank outside the building or in an opaque tank in the ground-floor.

Constructed wetlands – Reed bed treatment systems (RBTS)

After more than 20 years of development and practical experiences in many European countries of warm, moderate and cold climatic conditions soil filtration in reed bed systems has been successfully applied for purification of household sewage and greywater. This very reliable low-tech systems now belong to the generally accepted rules of sewage treatment techniques (for technical description see chapter 2.8). The biodegradable organic content of greywater is almost completely removed, the low concentrations of faecal indicator organisms (E.coli) of untreated greywater are reduced to about 10^2 – 10^3 /100 ml. The systems effluent is a clear and odourless water that allows safe storage times of several days and does not

necessarily need a UV-treatment (see 2.3.3). It has to be taken into consideration that particularly in warmer climatic regions considerable amounts of water evaporate from the reed beds. It is assumed that on a single hot and windy day up to 20 l/m²*d may be lost. Due to a secondary production of organic compounds by algae growth in summer, ponds are not usable for storage of purified greywater. The purification of household greywater in a vertical-flow reed bed requires a specific area of 1–2 m²/pe (minimum bed area: 10 m²). For Germany, Austria and Italy construction costs for vertical-flow beds (without pretreatment) may vary in 2005 between 135–75 €/m² (total area: 50–500 m²).



Figure 3: Garden-integrated vertical-flow reed bed for all-season greywater purification (10 pe) (Neumühlen/Böhme, Lower Saxony; Photo: B. Ebeling)

Rotating biological contactor (RBC)

Compact small-scale biological treatment plants such as multi-stage rotating biological contactors (RBC) proved to be very effective in greywater treatment. These techniques need a pretreatment and final clarification tanks for removal of the biomass. In recent years some plants have been preferably installed in cellars of single residential buildings or apartment houses. The required area for an RBC is about 0.5 m²/pe. Most extensively monitored plants with satisfactory results have been run in Germany for approximately 10 years treating greywater from showers, bath tubs and hand-washing-basins for reuse within the building. The use of common personal hygiene products, household-cleaning chemicals and medical baths or even a deliberate contamination of greywater with faeces and pathogenic bacteria did not pose a problem to a properly and efficiently functioning greywater system. The photograph below shows a RBC plant providing purified greywater for toilet flushing at a capacity of about 10 households. In the foreground: UV-disinfection unit.



Figure 4: Rotating biological contactor (RBC) for greywater treatment in Hannover, Hagewiesen
(Photo: B. Ebeling)

Sequencing batch reactor (SBR)

Greywater treatment systems of the SBR type that are also suitable for single and multiple-family houses have also been developed in the past three years. The system consists of a primary settlement tank, an aerated flow-bed reactor in which the biomass is floating or fixed onto foam cubes and a storage tank. The different purification phases as feeding the reactor, aeration of the greywater, settlement of biomass take place in one container. Interfering particles are held back from the system by a sieve. The system is tightly closed in order to prevent the escape of condensation water and air from the reactor into the surroundings. For information on available SBR systems see the product database <<http://www.swamp-eu.org>>.

Membrane bioreactor technique (MBR)

MBR are based on the biologically activated sludge process known from the common industrial and communal sewage treatment plants. The technique is applicable for greywater and normal wastewater purification. The unit consists of a pretreatment tank for settlement of primary sludge and/or a connection to a central sewer, an aerated settlement tank that also stores the intermittently produced greywater and the aerated activated sludge tank. Instead of settling the activated sludge in a sedimentation tank, in MBR the sludge is held back by a submerged membrane filter module that is directly installed in the aeration tank. With a pressure of about 0.1–0.3 bars, the purified wastewater is sucked through the membranes. Pore sizes of about 0.4 mikrons allow the production of bacteria-free service water. Due to its module design capacity of MBR may be expanded to units for app. 100 inhabitants. For further information see <www.busse-gmbh.de> or <www.weise-water-systems.com> (e.g. MBR Micro Clear MAO3-8 or the SWAMP product database).



Figure 5: MBR system, (MF-HKA 4, capacity 48 l/h) Busse Inc., Leipzig

2.3.3 Operation requirements

Service water from greywater recycling systems should provide hygienic safety, environmental compatibility and economic feasibility. At present a few regional or state regulations exist for the reuse of treated greywater. In Germany, hygienic demands for greywater reuse must meet requirements of the Bathing Water Quality Directive of the EC. For this reason, in practice, biologically treated greywater will be sanitised precautionally by UV-disinfection units. Control measurements have shown that, providing a sufficient maintenance of the plants, a re-growth of pathogens following UV disinfection may not be expected. In Berlin, where technical greywater recycling systems for households and public buildings were strongly encouraged first, special guidance requirements for toilet flushing water produced from greywater have been issued by the federal states government (see table below).

	Greywater for toilet flushing (Senate Department for Urban Development Berlin, 1995)	EC, Bathing Water Quality Directive, 1975, 2002	
		Guide standards	Imperative standards
Sensory test	Colorless, clear, almost odourless	–	–
Suspended solids	Minor amounts	–	–
Oxygen saturation	> 50 %	–	–
Transmission _{254 nm, 1 cm}	≥ 60 %	–	–
Digestibility	> 5 d	–	–
BOD ₇	< 5 mg/l	–	–
Total coliforms	0/0.01 ml (< 10,000/100 ml)	< 500/100 ml	< 10,000/100 ml

	Greywater for toilet flushing (Senate Department for Urban Development Berlin, 1995)	EC, Bathing Water Quality Directive, 1975, 2002	
		Guide standards	Imperative standards
Faecal coliforms	0/0.01 ml (< 1,000/100 ml)	< 100/100 ml	< 2,000/100 ml
Faecal streptococci	0/0.01 ml (< 1,000/100 ml)	< 100/100 ml	–
Pseudomonas aeruginosa	0/1.0 ml (< 1/ml)	–	–
Iron	< 0.5 mg/l Fe	–	–
Salmonella sp.	–	–	0/1,000 ml
Enteroviruses	–	–	0/10,000 ml

Table 2: Quality requirements for treated greywater and bathing water

Regulations in the EU are not harmonised yet. In Germany, any type of greywater purification plant requires a construction license if planned outside a building. A permission of the water authority is needed in case excessive treated greywater is to be discharged into a surface water or infiltrated into the ground. With a new drinking water ordinance that came into force in Germany in 2003, greywater recycling plants must be registered with the local health authorities. It is recommended to guarantee that no cross-connections exist between drinking water and service water supply. At the start-up this can easily be controlled by a dyeing staining test using food dyes. Pipes and tubes have to be colour-coded and non-potable water taps have to be labelled and protected against unauthorised use. It is of utmost importance that greywater system installations are properly made in order to exclude cross-connections between drinking water and non-potable water networks.

Comparing legal requirements on an international level, different quality parameters exist for reuse of biologically treated sewage. Limit values in the table below refer to the specific use of recycled water for crop and landscape irrigation or toilet flushing. Although there is an analog reuse of the treated water, kind of parameters and standard values differ to a large extend.

Institution	Reuse	Requirements
World Health Organisation WHO, 1989 (ASANO, 1999)	Irrigation of prospectively unboiled crops, sports grounds and public parks	Faecal coliforms: < 1,000/100 ml (hotel lawns with direct human contact: 200/100 ml)
Environmental Protection Agency, EPA, 1992, Florida (Jefferson/Laine, 1997)	Urban use, car-washing, extinguishing water and toilet flushing	<ul style="list-style-type: none"> pH: 6–9 BOD₅: < 10 mg/l Turbidity: < 2 NTU Faecal coliforms: 0 CPU/100 ml Chlorinated water: 1 mg/l Cl₂ clear, odourless, non toxic for food intake
National Sanitation Foundation, GB (Jefferson/Laine, 1997)	Reuse of black and greywater from sanitary facilities	<ul style="list-style-type: none"> Coliforms: < 240/100 ml Turbidity: < 90 NTU BOD₅: < 45 mg/l O₂ no bad smell, oily coating or foam
Building Services Research and Information Association (BSRIA), UK (Jefferson/Laine, 1997)	Toilet flushing	<ul style="list-style-type: none"> Faecal coliforms: 0/100 ml
Ministry of Construction and Japan Works Association (Maeda/Nakada/Kawamoto/Ikeda, 1996)	Toilet flushing Irrigation water	<ul style="list-style-type: none"> Faecal coliforms: < 1,000/ml clear, odourless, no turbidity BOD₅ < 20 mg/l pH 5.8–8.6 Faecal coliforms: < 50 /ml Chlorinated water: < 0.4 mg/l clear, odourless, no turbidity BOD₅ < 20 mg/l pH 5.8–8.6
State of California, Plumbing Code Appendix J (Ludwig, 1995)	Subsurface irrigation	disinfection and biological treatment not required

Institution	Reuse	Requirements
State of California, Wastewater Reclamation Criteria, 1978 (Ludwig, 1995)	Surface and landscape irrigation, e. g. public parks	Coliforms: 2.2/100 ml
DIN 19650 (Irrigation), Berlin, Germany 1999	<p>Irrigation water: Acceptability class 2: Greenhouse and outdoor vegetables for uncooked consumption, school sports fields, public parks</p> <p>Acceptability class 3: Greenhouse cultures unfit for consumption, fruits and vegetables for conservation, greenlands</p>	<ul style="list-style-type: none"> • Faecal streptococci: $\leq 100/100$ ml • Escherichia coli: $\leq 200/100$ ml • Salmonella: not detectable • Faecal streptococci: $\leq 400/100$ ml • Escherichia coli: $\leq 2,000/100$ ml • Salmonella: not detectable

Table 3: Requirements for reuse of treated greywater in different countries

The Australian Office of Housing, Department of Human Services recommended in a draft specification < 1 virus (Adenoviruses) per 50 litres, < 1 Cryptosporidium per 50 litres, < 1 helminth per litre, total N (incl. NO_x, TKN, Ammonia) < 5 mg/l and total P < 0.5 mg/l in a project where treated greywater was to be used for toilet flushing and irrigation [Office of Housing, 2003].

2.3.4 Maintenance requirements and costs

Successful management of greywater requires a proper design and realisation of pipes and treatment plants in accordance with the appropriate technical rules. In reed bed treatment systems, horizontal- and vertical-flow types are to be distinguished. Storage of purified greywater for several days requires a high treatment efficiency that may best be achieved by vertical-flow reed beds (BSB₅ < 5 mg/l, see 2.3.3), which are characterised by a simple robust design and very reliable operation throughout the year. However, it is recommended to close a technical service contract for controlling pumps or feeding ventiles, pipe systems and storage tank equipment. As there is only a minor production of primary sludge, pretreatment tanks (2-chamber septic tank) may be reduced to useful volumes and the first chamber normally emptied if required. Costs for a maintenance contract including a-twice-a-year-service will differ depending on the region.

Due to the high technical complexity of SBR and MBR, compact greywater systems may be rather susceptible to operational interferences. They rely upon a continual electric energy supply and a regular control by the operator and a maintenance of the technical equipment at regular intervals. First of all, using environment-friendly washing powders and cleaning agents and a responsible behaviour of the users, will improve a satisfactory operation significantly. Toxic household chemicals as strong detergents or chlorine should always be avoided in order to prevent a breakdown of the biological purification process. Starting or re-starting of a SBR or

MBR system to full effectiveness takes app. 2–4 weeks time. During a long-term absence (e.g. holiday time) the plants operation will be reduced down to a minimum in order to keep the biological functions alive.

The owner has to keep a log book (water quantities, operating hours, any disturbances, etc.) and must strictly attend the operating constructions and, will daily have to check whether the purification and disinfection units run properly. In most cases the owner also will have to place a maintenance contract with an authorised specialist firm. Routine maintenance should normally be carried out twice a year. This comprises functional checks of aeration units, pressurising pumps, UV-radiation, membrane regeneration and control of the purified water. Manufacturers give German operational costs, including costs for energy, maintenance contract and minor repairs in a range of 1.20–2.00 €/m³ for purified and UV-disinfected greywater. Interested users are advised to contact manufacturers for owner addresses to check experiences and costs close to reality.

2.3.5 System costs

Considering the permanently increasing costs for public drinking water supply and wastewater treatment, saving on fresh water use can significantly reduce water bills. One example of a greywater treatment unit available in Germany is the SBR module AquaCycle® (8–50 pe) with a; maximum processing capacity of 2,400 l/d, which provides toilet flushing water for app. 50 inhabitants. Total investment costs are about 6,000 € including transport and installation. Energy costs are about 30–50 €/year, drinking and wastewater fees for app. 500 m³/year can be saved. Assuming a price for water and wastewater of 2.5 Euro and a total of 10 hours at 50 Euro of maintenance per year this would lead to a write-off period of 14 years for the greywater treatment system. As a general rule, the more people are supplied with service water produced by one treatment unit, the quicker an economical operation is achieved. The pay-back of investment and operational costs depends on water consumption and drinking and sewage water prices.

On an even larger scale, the first greywater recycling plant was built in 1996 as an RBC for a four-star Hotel (Arabella-Sheraton near Frankfurt/Main) with 400 beds. Investigations have shown that each guest produced on average about 90 litres greywater per day. The need for service water for toilet flushing was about 50 litres per guest and day. The greywater recycling plant was designed to process a maximum quantity of 20 m³/d. With an average utilisation of 80%, an initial water price of 4.00 Euro and an increase in the water price of 7% per year, taking into consideration operation and maintenance costs, the amortisation period was calculated to be about seven years. Under favourable conditions and a minimum plant size a cost-effective operation should be achieved after 8–10 years. For decisions on greywater recycling using small-scale plants (e.g. for a single household, capacity: 300 l/d; gross price without installation: app. 3,500 €) one is advised to compare exact and complete investment and operation costs with the water saving potential in order to calculate the profitability. It has to be mentioned explicitly that these examples did not consider the costs for the always necessary service water supply and return systems within a building. <www.grauwasser.de> <www.gepumwelttechnik.com>

2.3.6 Trouble shooting

Main aspects of trouble shooting in greywater reuse have been pointed out in the chapters before. Public health authorities mainly focus on hygienic health risks. The application of greywater management systems depend on factors as climate, density and type of habitation, land-use patterns, existing drainage systems, degree of pollution and sensitivity of recipients. The requirements for treatment and precautionary measures are governed by how the greywater is regarded in the area from an environmental and public health point of view. Acceptance of purified greywater or sewage reuse differs from one culture to another. While greywater systems are applied by governmental directive rule in Japan, German or Dutch local authorities are reserved, arguing that public health is at stake. In the meantime, two thirds of experts questioned on "water technology in the year 2010", considered greywater systems technically feasible without public health risks.

Any chosen solution must suit the local conditions and consider potential risks the different techniques may cause. It is recommended to always study and compare different alternative solutions when planning for new or retrofitting old systems. It is recommended that solutions, new in a region or innovative in general, always should be tested and evaluated in a small scale before erecting large-scale plants. When planning for new wastewater treatment systems, different tools can be used to facilitate the planning process. An 'open wastewater planning' will find the right technical solution, targets for hygiene, environmental protection, and resource reclamation on one hand and operational and economical considerations on the other hand, that have to be taken into account.

References

Asano, T. (1999)

Wastewater Reclamation and Reuse

Water Quality Management Library, Vol. 10; Techn.Publ.Com.
Lancaster, USA.

Bahlo, K. (1999)

Bewachsene Bodenfilter zur Grauwasserreinigung

In: Fachvereinigung Betriebs- und Regenwassernutzung (ed.): Grauwasser-Recycling, Schriftenreihe fbr 5: 85-95.

DIN 19650 (Deutsches Institut für Normung, Berlin 1999)

FBR (Fachvereinigung Betriebs- und Regenwassernutzung)(1999)

Grauwasser-Recycling

Schriftenreihe fbr 5

Fittschen, I. and Niemczynowicz, J. (1997)

Experiences with dry Sanitation and Greywater Treatment in the Eco-village Toarp, Schweden

Wat. Sci. Tech. Vol.35, No. 9, 161-170.

Jefferson, B.; Laine, A. (1997)

Wastewater recycling; the potential for membrane bioreactors

Water Quality International WQI November / December 1997, 12-13

Ludwig, A. (1995)

Create an Oasis with Greywater

2nd Edition, Oasis Design, ISBN 0-9643433-0-4

Maeda, M.; Nakada, K.; Kawamoto, K.; Ikeda, M. (1996)

Area-wide Use of Reclaimed Water in Tokio

Japan-Wat. Sci. Tech. 33, No 10-11, 51-57

Nolde, E. (1999)

Qualitätsanforderungen und hygienische Aspekte beim Grauwasser-Recycling

In: Fachvereinigung Betriebs- und Regenwassernutzung (fbr)(ed.)Grauwasser-Recycling, Schriftenreihe fbr 5: 131-153

Nolde, E. (2005)

Wasserrecycling und das Geschäft mit dem Wasser

fbr-Wasserspiegel 2: 6-7, Fachvereinigung Betriebs- und Regenwassernutzung Darmstadt

Ridderstolpe, P. (2004)

Introduction to greywater management

EcoSanres Publications Series, Stockholm Environment Institute, 32 pp.

Senatsverwaltung Bau- und Wohnungswesen (1995)

Merkblatt Betriebswassernutzung

Berlin

WOHNSTADT (1998): Arbeitsgemeinschaft Umweltplanung Bullermann Schneble, Staatliches Medizinal- und Veterinäruntersuchungsamt Nordhessen

Begleituntersuchung zur Grau- und Regenwassernutzung Kassel-Hasenhecke

2. Report, unpubl.

2.4. Urine separation

2.4.1 Characteristics and yield/efficiency

Excretions are separated by the human body into urine and faeces and have quite differing characteristics. Therefore it is advantageous to process them separately. Segregation of the different fractions of excreta facilitates their purification and the reuse of nutrients and allows a reduction of water consumption for the transport (flushing).

In average, one person excretes about 1.5 kg urine and 200 g faeces per day. The urine contains 85% of the nitrogen, 70% of the phosphorus and 70% of the potassium; faeces contain 15% of nitrogen, 30% of phosphorus and 30% of potassium of the total human excretion. While fresh urine is normally sterile, faeces consists of microorganisms and may be highly infectious if from a sick person or carrier of diseases.

Pathogen		Average number of organisms per g of faeces	Median infective dose [ID50]
Viruses	Enteroviruses	10 ⁶	low (<10 ²)
Bacteria	'Pathogenic' E.coli	10 ⁸	high (>10 ⁶)
	Salmonella spp.	10 ⁶	high (>10 ⁶)
	Vibrio cholerae	10 ⁶	high (>10 ⁶)
Protozoa	Entamoeba histolytica	15*10 ⁴	low (<10 ²)
Helminth	Ascaris lumbricoides	10 ⁴	low (<10 ²)
	'Hockworms'	800	low (<10 ²)
	Schistosomia mansoni	40	low (<10 ²)
	Taenia saginata	10 ⁴	low (<10 ²)
	Trichuris trichiura	2*10 ³	low (<10 ²)

Table 1: Sanitation and disease health aspects of excreta and wastewater management

To be able to process urine and faeces separately, toilet systems have to be applied that do not mix the excretions. Designs and constructions of sorting toilets are known already for 200 years in Europe but only in the last 20 years such toilets have been developed in Scandinavia into a marketable commodity and are available on the market.

Separated urine can be collected in tanks and used as an optimal N-P-K-plant fertilizer in agriculture, spread in spring and autumn. In case of non-flushing by the so called dry toilet systems, the comparable small amounts of faeces can be degraded in composting toilets or collected in little bins and then composted outside the house. In case of using a WC the faeces can be flushed and conducted to a wastewater treatment plant, which has only to take care of BOD degradation

and bacteria minimization, as the remaining contents of nitrogen and phosphorus in faeces are quite low. The flushing water volume can be reduced considerably as flushing is mainly needed for the transport of the faeces.

Urine is a very clean natural fertiliser. It does not contain normally any microorganisms and very low concentrations of heavy metals. Håkan Jönsson's (Swedish University of Agricultural Sciences) investigation of human urine revealed that the concentrations of mercury, cadmium and lead were below detection limits (0.0004, 0.0013 and 0.027 mg/l respectively).

Also the energy balance of using urine separation and reusing urine in agriculture is positive: A study by Mats Johansson and Mirjam Nykvist showed that transporting and spreading the urine saved energy compared to treating the urine in a treatment plant and using commercial mineral fertilisers in agriculture. There are several possibilities to sort faeces from urine, reuse the nutrients, optimise the purification process and minimise the flushing water volume. These possibilities are reflected in the different sorting toilet systems.

2.4.2 Design and layout recommendations/devices available

Every sorting toilet consists of a normal toilet seat, which can be manufactured of pottery, porcelain or plastic. There are two outlets, one in front of the bowl for urine and a second in the middle or back of the bowl for the faeces. The toilet can be equipped with flushing devices for both, urine and faeces, or only for faeces or only for urine or not at all (see composting toilets, 2.7).

Main types of urine separating toilets

Type 1: Complete separation, no urine flushing at all, normal flushing for faeces; reduction of water consumption 80 %, for example the ROEDIGER "NO MIX" toilet

The ROEDIGER "NO MIX" toilet looks, and can be used, like a conventional modern toilet, with the exception that men have to sit during use. The toilet has two separate outlets: A conventional outlet for faeces and paper located in the back part of the bowl, and an outlet for urine, which is closed by a movable plug. While the toilet seat is in use, the plug is mechanically opened by a lever. Urine flows to the front inlet. Standing up closes the plug again. The two parts of the toilet bowl are not separated by a barricade. As soon as the toilet is flushed, the plug closes. Only if necessary faeces and paper will be washed away with minimal amounts of water through the rear outlet. Urine is taken away undiluted.

Idle

Outlet for urine drainage is closed by a movable plug



In Use

While the toilet is in use (person sitting), the plug is mechanically opened by a lever. Urine flows to the front inlet.

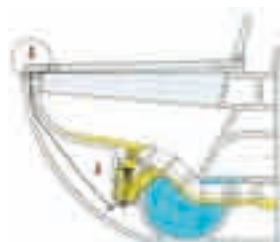

Flushing

After the user is getting up, the toilet can be flushed. While the plug for the urine outlet is closed, faeces and paper can be flushed out with minimal amounts of water through the rear outlet.



Figure 1: ROEDIGER "NO MIX" toilet

Type 2: Toilets with normal flushing but with 2 buttons one for urine and one for faeces, reduction of water consumption 60%, for example the BB Dubbletten Toilet



The WC DUBBLETTEN's design is based on two, well separated bowls, one for faeces, which has a bulge that prevents overflows of flushing water infected with bacteria and viruses, and one separated urine bowl. Through the two well separated bowls and two flushing systems which are independent of each other a minimum of water is required. For flushing the urine bowl only 120 till 150 ml are necessary, for the faeces the other flushing system is used, requiring water according to local circumstances (from 4–6 litres).

Figure 2: BB Dubbletten Toilet

Type 3: Urine diverting porcelain toilets: Urine is flushed with 0.1 l, faeces are composted; reduction of water consumption 95%, for example the WM-toilet ES

The urine section is rinsed with approximately 0.1 litres of water each use. Solids fall into a bin situated in an insulated box in which negative pressure is created by a fan and vent. The solid waste dries and thus bacteria and viruses are eliminated

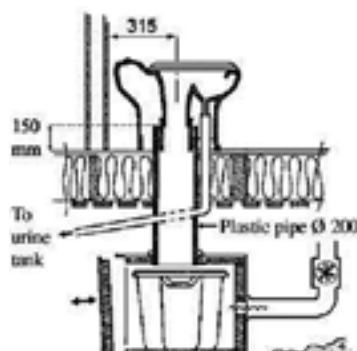

by a simple and reliable method. After a drying period of six months the waste material can be composted, burned or dug down into soil. A standard bin (holding 80 litres) will need to be emptied every three months for normal family use. It is a simple operation to empty the bin as the weight of a full bin is no more than 10–20 kg. It is recommended in every case to treat the faeces by final composting on a compost pile. The negative pressure ensures no unpleasant odour even when the toilet is in use.

Figure 3: WM-toilet ES

Pipes and tanks of the urine system

Recommendations

- installations must be water tight (pipes should be welded or similar). Ground water leaking into the system was the most frequent problem found
- no metals in the system to avoid metal contamination of the urine and corrosion (urine is very corrosive)
- horizontal pipes should have a slope of at least 1% and a diameter of >75 mm (preferably 110 mm), because sludge continuously precipitates from the urine mixture. The sludge is easy to flush away
- the system should not be ventilated to avoid loss of nutrients (ammonia nitrogen). If it is correctly constructed the total ammonia emission from collection, transport and storage is <1 %
- the pipes should have good opportunities for inspection and cleaning
- the inlet should be at the bottom of the tank which should have the man hole above the inlet pipe
- the tank consists of concrete or plastic (not metal) and has to have an overflow connected to the sewer (e.g. greywater treatment or public sewer)

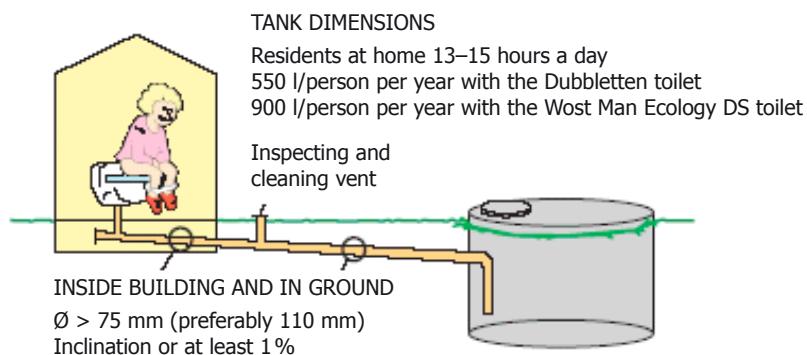

Figure 4: Recommendations concerning the dimensions and inclination of pipes and the capacity of holding tanks for urine separation systems

Urine storage and collection tank dimensioning

Urine is recommended to be stored for 6 months for disinfection, unless it is used on private property for private use. Concerning recommendations on storage time for disinfection see www.stockholmavatten.se/pdf_arkiv/english/urinsep_eng.pdf) The volume of the collection tank is calculated based on the type of the toilet, the number of users and the storage time in the collection tank. If the inhabitants are at home 16 h/day the systems should be dimensioned for a flow of 1 litre if urine is not flushed (350 litres/person and year) and for 1.5 litres/person and day (550 litres/person/year) if the toilet bowl is well divided and urine is flushed by 0.2 litre water and for more till 1,000 litres/person and year in other cases. If the collection tank is used both for collection and for storage/disinfection, an alternative with two tanks has to be considered, so one tank is being filled while the other one is storing for 6 months.

Storage temperature	Storage period	Presence of pathogens in the urine mixture b)	Recommended crops
4°C	≥ 1 month	Viruses, protozoa	forage ad food crops that are to be processed
4°C	≥ 6 months	Viruses	Food crops that are to be processed, forage crops c)
20°C	≥ 1 month	Viruses	Food crops that are to be processed, forage crops c)
20°C	≥ 6 months	Probably none	All crops d)

a) „Larger systems“ in this case means that human urine is used to fertilise crops that are consumed by persons other than the members of the household where the urine is collected
b) Gram-positive and sporulating bacteria are not included
c) Except grassland for the production of animal food
d) In the case of food crops consumed raw it is recommended that fertilisation with urine be discontinued at least one month prior to harvesting and that the urine is incorporated into the soil.

Table 2: The relationship between storage conditions, the pathogen content of the urine mixture and recommendations for crops in larger systems a)

Using urine as fertiliser

The urine tank is emptied regularly. There are different ways to do this, either by pumping the urine by an installed pump or by using a septage pumper truck. A thin layer is formed of particulate-rich bottom sludge with high levels of nitrogen, phosphorus, calcium, magnesium and potassium but this is not likely to affect the emptying of the tank. Great care has to be applied if it is necessary to go down into the urine tank, this task should never be undertaken by one person alone. If the urine is not used in the family garden, long-term agreements with contractors (farmers) are recommended. The tank trucks should be clean as the urine is very pure. The tank connections should be within easy reach of the truck; if permanent suction pipes are installed they should be of large diameter (preferably 150mm) in order to minimise loading times. To spread the stored urine on the fields, ordinary agricultural equipment for spreading liquid manure can be used. Urine is a well balanced source of nutrients (NPK) in an easily accessible form for the plants. The exact nutrient content depends on the nutrition of the users of the system. No plant toxicity has been detected. The most effective time to spread the urine for plant uptake is on the growing crop, since a high percentage of the nutrients are water soluble at time of application. The highest risk of ammonia loss occurs during spreading. Spreading should therefore best take place on a cloudy and humid day, carried out as close to the ground as possible and if possible, the urine should be plowed in as quickly as possible after spreading. Due to the comparatively high content of chlorides in urine (0.3.–0.6%) makes it necessary to carry out field trials for different crops and to made further investigations on the chloride influence to soil in different climates. After six months of storage without addition of any new urine, sanitation is sufficient for the urine to be used on any type of crop. The storage time can be shortened depending on the crop where the fertiliser is to be used and how the urine is stored. Quantities used for fertilisation in agriculture: Although the nutrients (N, P, K) in urine are well balanced for fertilizing plants, but how much of the urine can be used on agricultural fields depends on the soil and the plants which have to grow.

Mats Wolgast has calculated that the nutrients from our excreta are enough to manure the crops feeding us.

2.4.3 Operation requirements and costs

As for all toilet systems also urine separation needs regular attention and maintenance to keep the system working and clean. The users have to pay some attention to direct their excreta in the right bowl. Men have to be either seated or urinate carefully in the correct bowl. The better the separation works (no mix of urine with faeces) the less problems will occur with odour. The amount of flushing water saved by a urine separating system depends on the motivation of the users. Savings of 80% and more are possible. Faecal matter contamination can appear in small amounts in the urine, related to the use of the toilet system (misdirected faecal matter). This means small amounts of microbial pollution of the urine which is addressed through disinfection (6 months storage) of the urine. Otherwise the same rules apply as to normal toilet systems:

- no contamination with chemicals (artificial odours, bactericides) that we do not want in agriculture, all detergents used in the toilet should be ecolabelled and biodegradable
- not to use the toilet for disposal of unwanted waste

2.4.4 Maintenance requirements

Using urine separation toilets will be new in the beginning, especially for men, because they have to sit down. But after people become accustomed to these toilets they will use it without problems. They have also to take care of it as they have to take care of every toilet, especially according to hygiene. WC are normally connected to a municipal sewer system, and the municipal water works does the maintenance of it. Using urine separation the owner or a owner community has to organize the service for the whole system which is quite more than the toilets themselves. The urine has to be stored in tanks, the tank has to be emptied, the urine has to be transported to a field and a farmer has to spread it. Besides this organization work the installations like a special pipe for urine and the tanks and man-holes and pumps had to be maintained. This work can be done by the owner or by service companies.

2.4.5 System costs

Comparing costs of systems is always very difficult, because of the national support and tax systems. But looking at energy and water consumption will help to draw comparisons. Urine separation toilet bowls themselves are 4 till 5 times more expensive than normal WC, this is mainly caused by the small amount of toilets which are produced and sold now. There will be no big differences if both toilet systems are used in a similar large numbers. Normal WC sold today are using 6 litres water for one flush, there are toilets in the stock using quite more but there are also models available which are using only 3–4 litres for flushing and then – which becomes more and more common – are toilets in operation with stop buttons, to interrupt flushing. The water saving effect of urine separation toilets stems mainly from the very small (0.1–0.2 litres) or zero amount necessary to change the water in the urine traps. So water saving has been calculated at 80% in average. At a tap water and sewage price of 3 €/m³ a family with 4 persons can save for water

flushing about 100 l of water a day (4 pers. * 5 times * 6 litre * 80% = 96 litre), that means 0.3 €/d or 108 €/year. This would correspond to 27 € per bed and year. Looking at the energy side according to the report of Mats Johansson and Mirjam Nykvist: Energy, 24 MJ/person and year, was required for transporting the urine mixture 33 km with a truck and trailer to a farm and for spreading it as a fertiliser. However, the decreased nutrient load on the sewage system meant that 31 MJ/person and year were saved in the sewage system. In addition, the source separated urine replaced mineral fertilisers, which would have required 75 MJ/person and year to produce. Thus, urine separation saved in total 82 MJ/person and year. A sensitivity analysis showed that the urine mixture could be transported 220 km by truck and trailer before the urine separating system used as much energy as the conventional one.

2.4.6 Trouble shooting

Blockages in urine pipes

The most important problem reported was that stoppages normally appeared in the u-bend of the toilet after a short time. A trap may not be necessary. However, where it is used, blockages will occur on a regular basis (every 6–24 months, depending on the users). Depositions and hair create the blockages. Roughly 20–25% of the blockages are hard coatings, but most of them are soft and can easily be removed by using a plumber's snake. The hard blockages can be removed with a solution of liquid caustic soda; add it to the pipe, let it stay overnight and flush the trap with water. As soon as any sign of reduced flow of urine to the outlet appears, clean the trap with a plumber's snake.

References

- Feachem, R. G.; Bradley, D. J.; Garelick, H.; Mara, D. D. (1983)
Sanitation and disease health aspects of excreta and wastewater management
World Bank Studies in Water Supply and Sanitation 3
- Jönsson, H., Swedish University of Agricultural Sciences (2001)
Urine separation - Swedish experiences
http://www.iees.ch/EcoEng011/downloads/EcoEng011_F1.pdf
- Johansson, M.; Nykvist, M. (2001)
Urine separation
The Stockholm Water Company
www.stockholmvatten.se/pdf_arkiv/english/urinsep_eng.pdf
- Johansson, M.; Nykvist, M. (2001)
Urine separation – closing the nutrient cycle
The Stockholm Water Company
www.stockholmvatten.se/pdf_arkiv/english/urinsep_eng.pdf
- Wolgast, M. (1993)
Recycling system
Brochure produced by WM-Ekologen ab
Stockholm

2.5 Vacuum toilet systems

2.5.1 Characteristics and yield/efficiency

Although vacuum toilet systems are mainly used in modern means of transport as marine ships, commercial aircrafts and railroad carriages, the technology is now being used for land-based projects. It has been proved to work reliably as stationary outdoor sewerage systems as well as within private, public and industrial buildings for the collection and transportation of sewage from plumbing fixtures including toilets, urinals sinks and showers through a pipe network to a central vacuum collection module. The system principle bases on a vacuum with a pressure of about 0.5–0.7 bar achieving flowing velocities of about 2.0 m/s within a closed valve-pipe-tank module system. Main components of a vacuum sanitary system are a central vacuum station including a pump, that generates the vacuum, a pipe system and the plumbing fixtures. Bathroom devices are equipped with special pneumatic push-buttons and valves. If a user presses a button the discharge valve opens and the content inside the bowl together with a small amount of flushing water will be sucked into the pipe system. Evacuated sewage is collected in a vacuum tank for storage and intermittently discharged into a gravity sewer by an ejector pump. A programmed control panel interfaces all of the components. A typical arrangement of these system components is shown below.

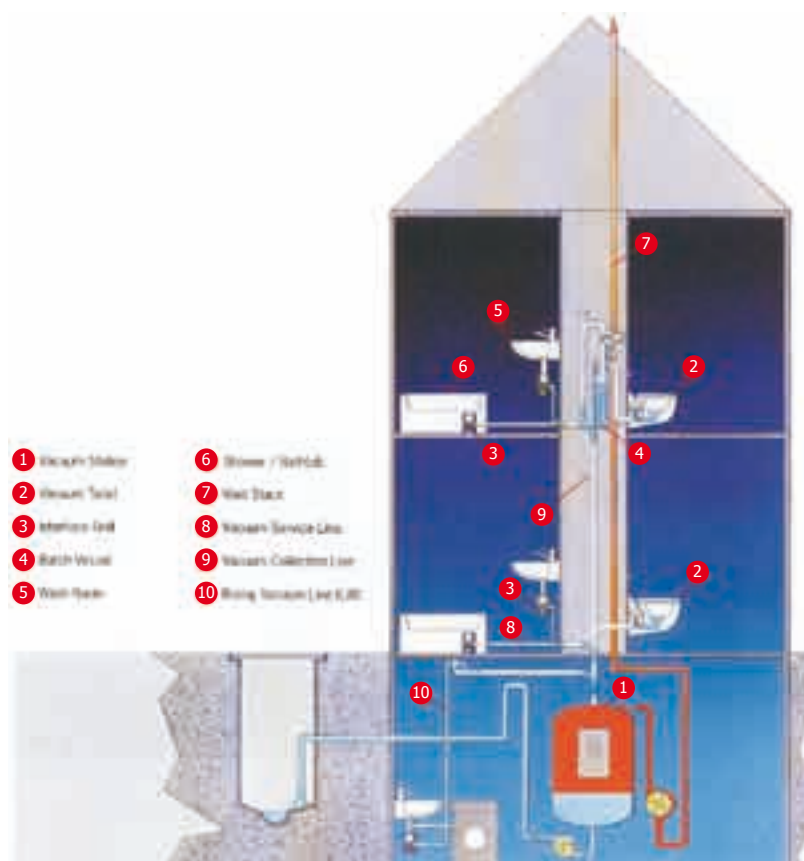

Figure 1: Vacuum system for toilets and bathroom equipment (Source: ROEDIGER, Hanau)

Water consumption is considerably reduced by the installation of a vacuum sanitary system, that therefore is an ideal solution where the water supply is scarce. While a gravity toilet system needs a quantity of water of about 6–9 litres per flush, for a vacuum toilet it can be reduced down to 0.7–1.2 litres per flush. However, vacuum toilets are currently mainly used where it is necessary for environmental reasons to

use a minimum of water, control limitation of water consumption, solve particular drainage problems in reconstruction or modification of existing building structures, or for cost reasons (www.roevac.com)

From the water consumption and hygienic point of view vacuum toilets provide convincing solutions. Vacuum toilet systems allow a separated collection of both faecal (black) and grey water from kitchens, washing machines, showers and sinks. As first practical experiences have shown faeces are highly concentrated in a volume of 5–9 l/cd and may be processed together with organic household waste in an anaerobic digester by producing biogas, electricity and a high quality fertilizer (www.flintenbreite.de)

2.5.2 Design and layout recommendations/devices available

There are different types of vacuum toilet systems from a couple of providers available on the market. Detailed information may be easily detected directly from suppliers or via internet. In comparison with a gravity drainage system a vacuum toilet system provides constructional flexibility since it can flush downwards, horizontally or even upwards to a maximum height of six meters. Drainage pipes can be installed at ceilings and have not to be installed underfloor or in rooms underneath. This introduces many possibilities and ideas, whereas a gravity system is much more restrictive. While gravity sewage drain pipes sizes are typically 60–100 mm in diameter, vacuum pipes are sized down to 40–60 mm, which minimizes installation costs, maintenance costs, and future modification costs.

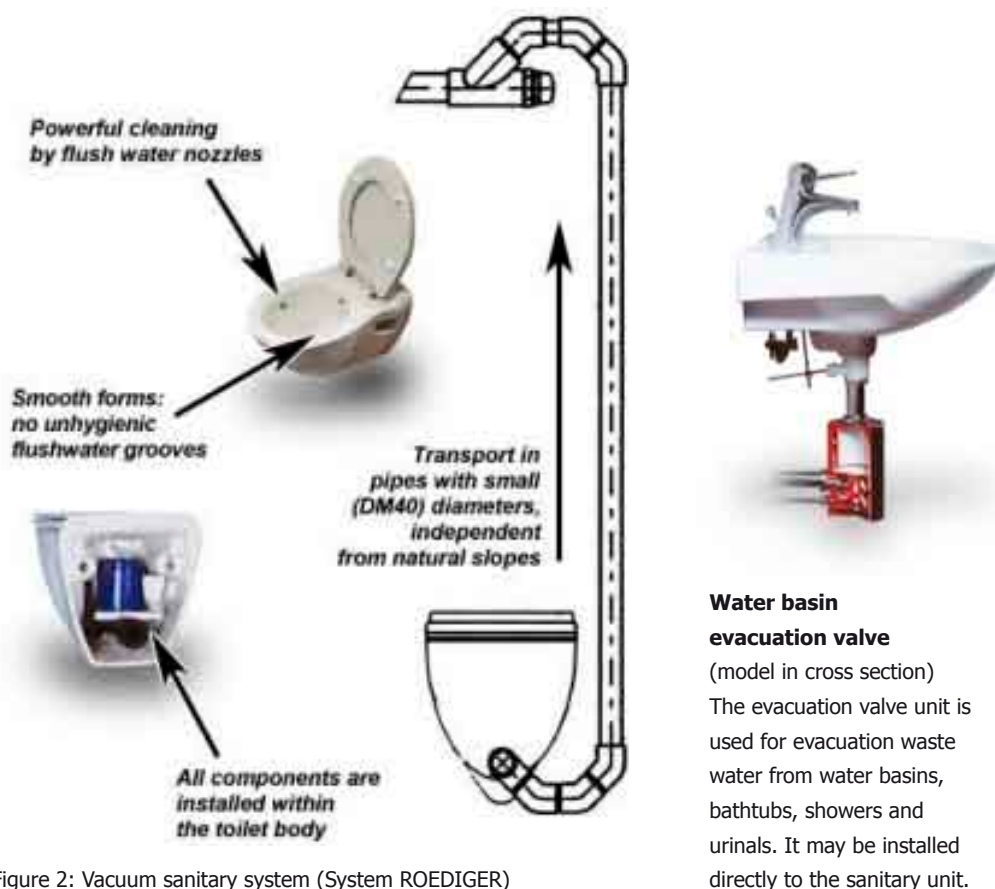

Figure 2: Vacuum sanitary system (System ROEDIGER)



Figure 3: Basement vacuum station in the historical main building at Burg Lenzen, Germany

Vacuum pumps generate a sub-atmospheric pressure within the whole system. Waste water is evacuated from vacuum toilets, wash basins, bathtubs and showers, and will be collected in the vacuum tank. The discharge pumps (see figure 3, foreground) push the collected waste water through the black pipe to the connected communal sewer system. The vacuum pump (not visible behind the tank) is connected to the stainless steel pipe. Grey unit to the right: Steering device.

2.5.3 Operation requirements

Using a vacuum toilet does not differ very much from a normal WC. The better toilet designs are more or less silent, odour free and do not splash. As it is no good for a normal WC it is even worse for a vacuum toilet system trying to pipe off alien waste. Users must be informed about the systems particularities and trouble that can occur if any wrong stuff gets into the pipe system. Blocking material can be taken away by opening an evacuation valve at any plumbing fixture concerned. In worse cases the closing mechanism of an evacuation valve can be disturbed and has to be exchanged. However, any flushed item that gets through the toilet opening, is usually sucked through the piping system, and stored in the vacuum tank until being discharged into the sewer. Bathroom fixtures have to be cleaned as regularly as normal WCs.



Figure 4: Ceramic sinks in an stainless steel washstand with vacuum connection at Burg Lenzen



Figure 5: Ceramic vacuum toilet with built-in vacuum valve at Burg Lenzen

2.5.4 Maintenance requirements and costs

Normally, if thoroughly installed a vacuum system works reliable. In case of any replacements plumbing fixtures, ventilation and excavation valves or pipes of the vacuum system have to be controlled, and if necessary readjusted. The vacuum station has to be checked once or twice a year by a professional service for correct operation and steering, signs of wear, and regular oil changes at pumps will be carried out. One may see it as a disadvantage that another electricity dependent facility is installed in the house, which needs professional services and energy for running the pumps. There are only a few reliable cost statements available, but the demand of electrical energy for a vacuum station varies between 20–30 kWh/(pers.*a).

2.5.5 System costs

Vacuum drainage is not currently cost-effective or practical for small houses. Vacuum sanitary systems can provide cost savings and ecological benefits when installed in large buildings as hotels, business centres, factories, public buildings or

larger housing estates where sanitary facilities are frequently used and the water bill is high. Examples include the addition of sanitary facilities to historic buildings as it was realized in the SWAMP project at Burg Lenzen. Although vacuum toilet systems in buildings have been working for a couple of years there are no general quotes on construction prices possible. As vacuum system equipment is rather expensive it may be assumed, that a minimum number of connected devices is needed in order to achieve cost advantages in comparison with a gravity system. The potential for an overall cost-effectiveness depends on the local building situation, drinking water supply and prices, sewage treatment and fees. The economic conditions should be proved carefully by considering the expected lifetime of the facility, and calculating the complete investment and operational costs including the reduction of drinking water and waste water fees for different technical variations of sewage collection.

2.5.6 Trouble shooting

Vacuum toilet systems became standard solutions for passenger steamers, aircrafts, comfortable high-speed trains and even in public buildings. In recent years they have been developed to a reliable technique. But, due to the high technical complexity these systems are more susceptible to interferences than gravity systems. As they rely upon a continual electric energy supply, a net-independent generator is needed if a safe and permanent operation has to be ensured. Whereas operation of the first vacuum toilet techniques was a rather noisy business nowadays modern vacuum plants are operated with moderate and generally accepted noise production, although sometimes occupiers and tenants will have to get used to this new technique. In order to prevent disappointments potential users are advised to make their own investigations before deciding on any course of action. Manufacturers are advised to introduce plumbing firms thoroughly to the rules of installation and maintenance requirements.

References

www.roevac.com
www.flintenbreite.de

2.6 Waterless urinals

2.6.1 Characteristics

Waterless urinals do not use any water for flushing and they are entirely based on gravity. With a standard urinal, bad smelling canal gases are locked out by a water filled siphon. Waterless urinals, use special siphon systems to prevent bad smells to leak out of the canal. Common urinals use at minimum about 3 litres of flushing water per flush, which means that more than 10 litres flushing water per person and day could be saved. Although waterless urinals are slightly more expensive than conventional urinals, their installation is economical in comparison to common urinals, because of the reduction of installation costs for freshwater connection and flushing devices (electrical sensors).

The cost effectiveness becomes more obvious in the long run because of low running costs. Once installed, the efficiency of waterless urinals is very high. There is no need for additional energy supply and flushing water. Compared to a common urinal, a waterless urinal does not need much more service or know-how.

2.6.2 Devices available

Waterless urinals come in a variety of models and brand names as well as different shapes and designs. The urinals are made of ceramic or glass fibre. Two types of waterless urinals, which can be used in tourism facilities are presented here. There are two different systems:

- Waterless urinals with sealing liquid siphon systems
- Waterless urinals with rubber-membrane siphon systems

Waterless urinals with sealing liquid siphon systems

The urine passes through a trap with an oil-based barrier liquid that acts as a stench barrier. The urine, which is heavier in specific gravity than the sealing liquid, sinks down through the liquid and is evacuated through the drain. The oil-based liquid acts as a stench barrier. Bad smells cannot leak out of the canal.

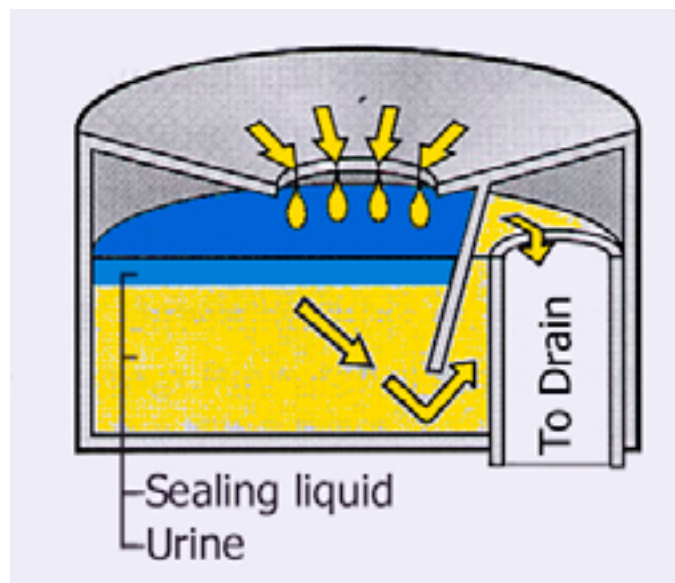

Figure 1: Section of sealed trap cartridge

The figure above shows a sealed trap cartridge in section. The cartridge is installed in the bottom of the urinal and has to be changed from time to time. Depending on the frequency of visits and the manufacture of the cartridge the average useful life of the trap is about 5,000–1,000 visits. A average household has to change the trap once a year. The price of a sealed trap cartridge is about 40 EUR (Austria).

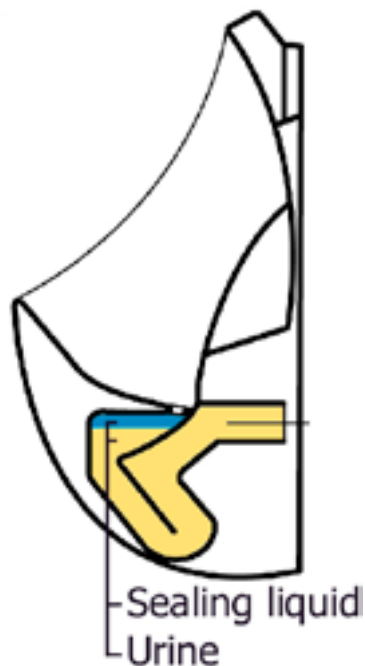

Figure 2: Urinal with a built-in trap in section

The figure shows an urinal with a built-in trap in section. No parts have to be changed, only sealing liquid has to be added every month or after 5,000 uses. Trials with a urinal have shown that the sealing liquid may last more than a month. The sealing liquid consists of hexyldecanol and a small amount of perfume. It might also be possible to replace the mineral oil with vegetable oil products. The price of one charge is about 5 EUR (Austria).

Waterless urinals with rubber-membrane siphon systems

A new type of rubber-membrane allows liquids to discharge completely and closes instantly after it has been used. Bad smells cannot leak out of the canal. The anti siphon-trap does not require water, any chemicals or energy and it is environmentally friendly/neutral. The urinal is produced with a flushless rim, the internal parts being protected by the ceramic body equipped with a special glaze (a highly polished smooth surface) preventing dirt adherence. This new kind of urinal is on the market since November 2003. During the first year, no rubber membrane tube replacement was sold by the German manufacturer. The price of a new rubber membrane is about 17 EUR (Austria).



Figure 3: Rubber-membrane tube "anti siphon-trap"

The figure shows a rubber-membrane tube "anti siphon-trap" (instead of a siphon odour seal). The rubber-membrane allows liquids to discharge completely and closes instantly afterwards.

2.6.3 Maintenance requirements

Experiences with waterless urinals in use show that there are no special requirements for cleaning or changing of the trap. The urinals should be rinsed with cold water from time to time. Ceramic urinals with special glazes are equipped with a disinfectant coating to prevent bacterial growth that causes stench. The manufacturer guarantees that these urinals have to be cleaned only once a week. Glass fibre models (GRP) are more difficult to keep clean. Most of the available GRP models are to be cleaned with special detergents or protection waxes, marketed by the manufacturer, that are sprayed on the urinals.

2.6.4 System costs

The investment costs of waterless urinals are comparable to conventional urinals, if the advantages of reduced installation costs for water supply and flushing are considered. Market prices (Austria, 2004) are approximately

- 300 EUR for a glass fibre manufactured urinal with exchangeable siphon cartridge
- 500 EUR for a porcelain urinal with rubber membrane tube system
- 700 EUR for a porcelain urinal with integrated siphon (built-in trap)

2.6.5 Trouble shooting

The cleaning staff is to be informed about any cleaning and maintenance specialities of the urinals according to the manufacturers instructions. Particular attention has to be paid to a suitable cleaning agent. Dirty cleaning water should not be emptied into the urinal.

2.6.6 Summarised advantages

- 100 % flushing water is saved
- operation costs are reduced
- no installation cost for freshwater connection
- no installation cost for flushing devices (electrical installation)
- no urine matter formation on the ceramics and the drainpipe-system
- hygienic advantages: no physical contact with the urinal (no flushing button)
- simple implementation of separate urine collection possible, (see urine separation, chapter 2.4)

2.7 Composting toilets

2.7.1 Characteristics and yield/efficiency

Composting toilets are toilet systems which treat human waste by composting and dehydration to produce a useable end-product that is a valuable soil additive. They come in a variety of models and brand names as well as different shapes and designs to enhance the natural composting process. They need water only for cleaning and they are not connected to sewer systems, cause no environmental damage and produce a valuable resource for gardening. The systems can be broadly divided into two different types.

Batch systems

With the batch systems, a container is filled and then replaced with an empty container. The composting process is completed inside the sealed container or in another, larger container, or, mixed with other organic material on a garden compost heap. Some systems have a single, replaceable container. Others have a carousel system where 3 or 4 containers are mounted on a carousel and an empty container is spun into the toilet area every time one is full. At the end of a full cycle, the first container is fully composted and ready for emptying.

Continual process systems

These systems are in a constant state of composting. Urine and faeces enter into the system and are possibly mixed with dry organic matter to give structure to the material, like 2–7 cm long woodchips. The composting process reduces the volume and the matter moves downward where it can be harvested as fully composted material after 6–12 months or more, depending on the climate conditions. All systems are designed to treat urine and faeces by composting, which means dehydration, worm processing, micro and macro-organism breakdown.

Composting is an aerated degradation process. Therefore it is important that oxygen is able to enter the system and prevents anaerobic conditions inside the material. This can be achieved by an electric or wind-driven fan which is sucking air through the container.

Once installed the efficiency of composting toilets is very high. There is no need for additional treatment of faeces or urine and for flushing water. That means that more than 30 l flushing water per person and day can be saved. Mature compost can be used in the garden, saving artificial fertilizer. However, compared with a normal WC a composting toilet needs more service and know-how. If an electric fan is needed it may consume up to 0.4 kWh electricity a day.

2.7.2 Design and layout recommendations/devices available

Different types of composting toilets are available. They are mainly used in areas without public sewers or where it is difficult to build sewer systems. Although the investment costs are rather high they become economical in the long run because of their low running costs.

In Scandinavia and in the U.S. and Canada composting toilets are very common, different products are available on the market. Two types of composting toilets, suitable for tourism facilities are presented here:

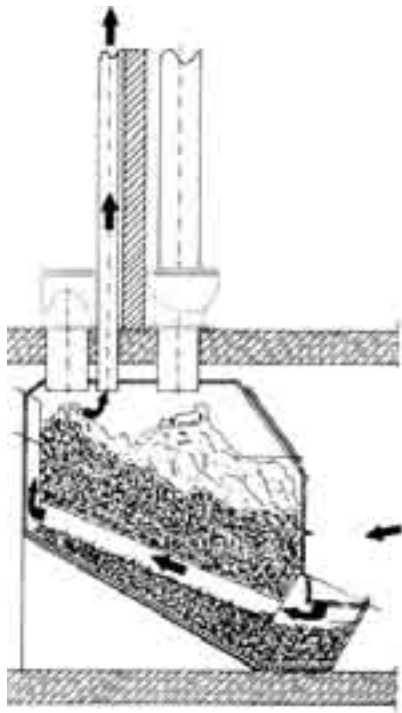

The system TERRA NOVA (www.berger-biotechnik.de) consists of a 1 m³ large fibre plastic container, which is positioned in the basement of a building and receives faeces and urine as well as organic material from the kitchen. Two toilet seats can be connected to the container which can be situated on different floors.

A fan and a ventilation pipe are aerating the material and are transporting moisture and gases by a pipe to the chimney. 10–40 litres of mature compost per person and year are produced and have to be taken out of the container for use in the garden.

The installation costs are about 7,000 € for one unit which serves 4 persons the whole year round. This dry toilet system is used mainly for family houses, but also for summer houses, holiday flats and vacation houses.

Figure 1: Function diagram of a TERRA NOVA composting toilet

The composting toilet VILLA 9000 (www.separett.com) is made of polypropylene plastic (1) and contains a bucket for collection of the faeces. Additionally the toilet has an urine separation device (4), to collect the urine separately which helps to keep the faecal matter dry.

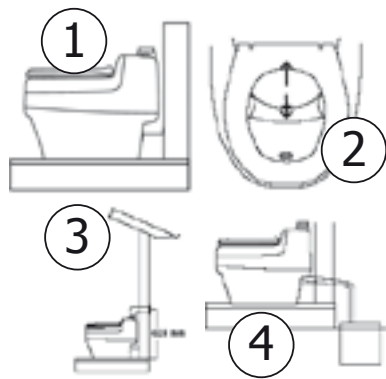

If the bucket is full it has to be emptied and the material is covered with other organic material in the garden or the bucket is replaced by a second bin and the material is composted in the original bin.

The bucket inside the toilet is covered by two lids. The first is for opening the toilet, the second (2) is opened only when the user sits down on the toilet. The toilet is equipped with a fan, which is sucking air through the toilet out of the toilet room to outdoors (3).

It is a dry toilet system mainly for weekend houses but also for summer houses, holiday flats and vacation houses. The price for the toilet alone amounts to 500 €.

Figure 2: Composting toilet VILLA 9000

2.7.3 Operation requirements and costs

Using a composting toilet requires basic knowledge about composting. Although the composting procedure is simple, the basics have to be known.

- The C:N-ratio should be 20:1 till 30:1. That means if urine and faeces are composted together additional carbon sources like straw, wood chips or branches, peat, saw dust, kitchen waste, leaves or bark chips have to be added into the faecal bin. If the urine is collected separately this material is not necessary.

- To prevent bad smell in the restroom, a good ventilation has to be provided either by a fan or by a venting pipe with a wind driven propeller.
- If the faeces are not fully composted in the toilet container, additional compost containers must be available regularly changed.
- The duration of the composting process depends on the climate conditions. In Central Europe under summer conditions earth worms will be retiring after approximately 6 months. For hygienic safety reasons mature compost originating from faeces should only be used for fertilizing trees, bushes or ornamental plants.

The simplest odourless composting toilet costs – only for the toilet itself – about 300 €. For larger ones and more comfortable ones, e.g. for a composting bin like TERRA NOVA, the costs can go up till 10,000 €. Additional costs for installation of ventilation pipes, a fan, a urine tank will increase the investments. Operation costs will be electricity for the fan which can reach 30 € ($500 \text{ Wh/d} * 365 \text{ d} * 0.15 \text{ €/kWh} = 27 \text{ €}$) a year, if the fan will work every day the whole year. Other running costs are difficult to calculate like emptying the faeces bin or taking out the compost and distributing it in the garden. Using a composting toilet a client will save 100 litres of flushing water a day for a four person family. That could mean for German conditions about 100 € a year ($100 \text{ litres} * 365 \text{ d} * 3 \text{ €/m}^3$). So there is a large investment of money or individual know-how in the beginning, but will result in very little running costs.

2.7.4 Maintenance requirements

Experiences with composting toilets in use show that there is a need of active composting management due to the large amount of liquids in the containers originating mainly from urine. One possibility is to pump off the liquid from time to time and spread it in the garden or to add dry organic material like straw, hay, leaves or paper to the composting container. The latter is more advantageous because it is favourable for the C:N-ratio. Human excreta contain too much nitrogen for a suited aerobic carbon hydrate degradation. Too much nitrogen allows rapid microbial growth and accelerates decomposition, creating serious odour problems as oxygen is quickly depleted and anaerobic conditions occur. Some of this excess nitrogen will evaporate as odorous ammonia gas allowing valuable nitrogen to escape. If the compost toilet is equipped with an urine separation device, urine will be collected and treated separately.

The composting process of the faecal matter has to be managed. Either a plastic – composting container can be used or a normal compost heap in a garden. The faeces material has to be covered and/or mixed with earth or other dry material like wood chips, bark chips or peat to prevent the development of flies or other unwanted animals.

2.7.5 System costs

The simplest composting toilet is a bucket with a lid. The faeces are covered regularly with sand, earth or peat and the bin is emptied regularly. If more comfort is requested, more installation and equipment is needed (ventilation, urine separation). Composting toilets have to be considered under an economic view with such results:

- Electricity for artificial aeration of sewage in wastewater treatment plants to oxidise our faeces to carbon dioxide it is not necessary anymore.

- Human beings will not be anymore the source for nitrogen and phosphorus eutrophivating lakes, rivers and seas. These nutrients and others like potassium will go back to the soil.
- Composting toilets are saving flushing water. This water amount has not to be abstracted.

The fertilising equivalent of excreta is, in theory at least, nearly sufficient for a person to grow its own food (Drangert, J. O.). So using composting toilets will minimize world hunger problems and protect the resources of nutrients, especially of phosphorus.

The positive economic facts will only become reality if people are educated to deal with their excreta, especially their faeces in a better way as they do today – flushing it away or dumping it. Also to learn what composting means and how it works will be a precondition for a larger acceptance of composting toilets and its use.

2.7.6 Trouble shooting

Troubles can occur by odour and flies. Odour is a result of how ventilation has been organized. A fan is the most efficient way to keep the restroom odourless. For simpler solutions like venting pipes with a wind driven propeller or only a venting pipe, urine separation will be advantageous. If urine gets into the container with the faeces it will cause a latrine-type odour.

Flies can be prevented by

- covering the excreta with earth or peat
- sealing the venting pipes with a mesh additionally
- tighten up all the joints in the venting pipe and urine waste pipe.

References

Drangert, J. O. (1998)

Fighting the Urine Blindness to Provide More Sanitation Options

Water South Africa, Vol. 24, No. 2, April

Richard, T. et al. (1996)

The science and engineering of composting

Cornell Waste Management Institute

www.cfe.cornell.edu/compost/science.html

2.8 Constructed wetlands for wastewater treatment

2.8.1 Characteristics and yield efficiency

A main part of the pollutants contained in wastewater are nutrients that can be removed in wastewater treatment plants by reproducing natural self purification processes. Conventional treatment plants like activated sludge plants enforce biological organisms with energy-intensive mechanical equipment to decompose complex compounds, to incorporate the nutrients in biomass and finally to separate that biomass from the purified water. Thus such plants are energy intensive reactors with relatively small area demand that are suitable for centralized wastewater treatment.

Constructed wetlands are principally using the same natural degradation processes and nutrient uptake but they are acting as "extensive systems". The high degree of biodiversity present in these systems allows multiple and various degradation pathways for several classes of compounds, and therefore higher performances in comparison with the technological treatment plants in which only few families of specialized bacteria are grown. There is no excess sludge to be removed since there is a balance of biomass growth and decomposition in the constructed wetland system. As compensation to the low energy demand there is a relatively large area demand. Accordingly constructed wetlands are usually suitable and cost effective for small and medium size wastewater treatment plants.



Figure 1: Fischerhof constructed wetland for 160 pe, Sirnitz/Austria

Within the last 20–30 years various types of constructed wetlands have been developed in several countries. There is a wide acceptance and interest within the population because of the following advantages:

- Simple construction, operation and maintenance
- Low operation and maintenance costs
- High ability to tolerate fluctuations in flow

- High process stability
- Sludge only from primary treatment
- High pathogen removal – good water reuse and recycling options
- Aesthetic appearance
- Creating biotopes

The usual applications of constructed wetlands are:

- Domestic wastewater: Treatment of domestic wastewater (blackwater and grey-water) meanwhile is a conventional application.
- Industrial wastewater: There are numerous possibilities also for industrial wastewater like chemical industry, laboratory effluents, landfills, acid mines and agricultural wastewaters, e.g. from wineries, olive oil mills, dairies ...
- Sludge drying: Special reed beds can be used to dewater and stabilize excess sludge from technical plants and sludge from primary pretreatments
- Furthermore highway runoff, polluted groundwater, surface water and storm water can be treated in constructed wetlands



Figure 2: Constructed wetland of a winery, Italy

Classified within treatment process constructed wetlands are usually applied as secondary treatment for mechanically pretreated wastewater. They can also be used as tertiary treatment; in this case they will work for upgrading conventional biological treatment plants. Constructed wetlands can be classified according the life form of the macrophytes (plants) in the system:

1. Floating macrophyte-based system
2. Submerged macrophyte-based system
3. Rooted emergent macrophyte-based system

Following only type 3 is described with more detail because it is the most common used in Europe and in the world. It can be categorized according to the flow pattern:

Subsurface flow

a) Systems with horizontal subsurface flow (HF)

This type of RBTS consists in a properly designed water proof basin that contains a filter material, wetland plants (normally reeds) and microorganisms. The bed is fed with wastewater coming from a suitable primary treatment by a simple inlet device. The filling material (coarse gravel, fine gravel and coarse sand) has to offer an appropriate hydraulic conductivity but also a large surface for the biofilm growing. The water level remains always under the surface of the bed; the wastewater flows horizontally by a slope (about 1%) which is obtained by a sand layer under the membrane liner.

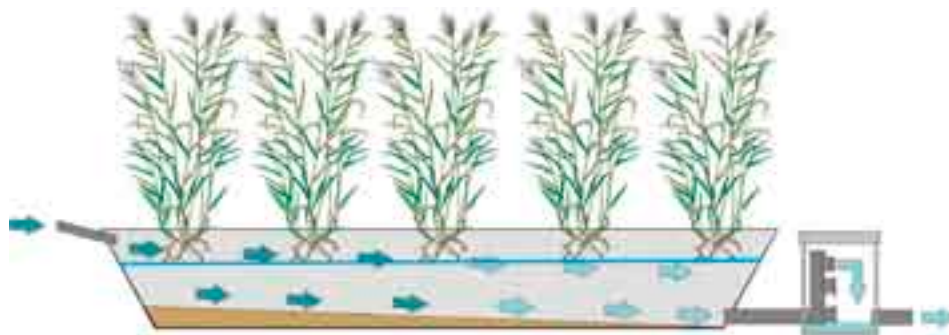

Figure 3: Flow scheme of a horizontal flow constructed wetland

The subsurface flow prevents odors and mosquitoes and permits public access in the wetland area. This kind of CW is particularly efficient in suspended solids, carbon and pathogens removal, as well as for denitrification, while, due to its prevalently anoxic conditions, nitrification is limited.

b) Systems with vertical subsurface flow (VF)

In the vertical flow systems (VF) the wastewater is applied through a distribution system on the whole surface area and passes the filter in a more or less vertical path. The pre-treated wastewater is dosed on the bed in large batches (intermittent feeding), thus flooding the surface. During the time between the feedings the pores within the filter media can fill up with air which is trapped by the next dose of liquid. Thus oxygen requiring nitrifying bacteria are favored and full nitrification can be achieved, but only a small part of the formed nitrate is denitrified under aerobic conditions. The denitrification and thus total nitrogen elimination can be increased by a partial recirculation of the nitrified effluent into the first chamber of the septic tank. The treated water is collected in a bottom drainage system to be discharged.

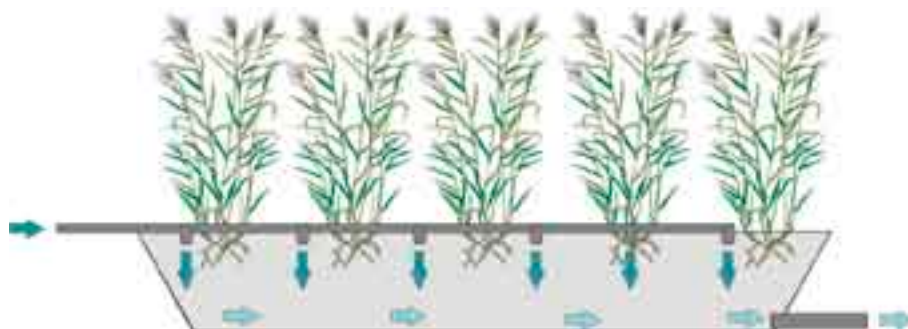

Figure 4: Scheme of vertical flow constructed wetland

The water level can be maintained with a height of about 5–10 cm from the bottom of the bed, or otherwise the beds can be totally empty after each feeding pulse. This kind of CW is particularly efficient in nitrification, carbon and suspended solids removal. Due to its prevalently aerobic conditions denitrification is poor.

Free water surface

c) Systems with free water surface (FWS)

Surface flow wetlands are densely vegetated basins optionally including open water areas. They need some sort of subsurface barrier to prevent seepage and soil or another suitable medium to support the emergent vegetation. The water flows through the unit at a relatively shallow depth. Particulates tend to settle and to be trapped in the system; in such a way they enter into the biogeochemical element cycles within the water column and surface soils of the wetland. At the same time dissolved elements enter the overall mineral cycles of the wetland system. This kind of constructed wetlands is particularly efficient in the pathogens removal, due to the high exposure of the wastewater to the UV component of the sunlight. For that reason, and also for a good denitrification power, these systems are often used as tertiary treatment (polishing stage).

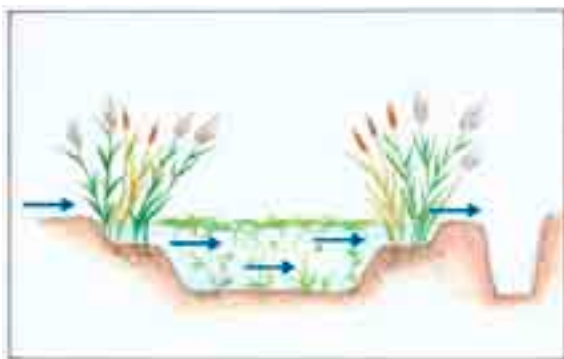

Figure 5: Scheme of a free water surface constructed wetland

Wastewater ponds without vegetation that are used as primary and/or partly secondary treatment are not described in this chapter but in pretreatment systems.

Hybrid systems

Combinations of a,b,c: Using the different properties and abilities of the above mentioned three types a wastewater treatment plant can be assembled out of the different types.

2.8.2 Design and layout recommendations/devices available

Pretreatment

A good mechanical pretreatment of the wastewater is an important precondition for the functioning of all subsurface flow systems. Especially in VF filters filled with fine sand the entry of high amounts of solids might cause the clogging of the filter. As exception the special “French type” of VF is designed to work without separate pretreatment [Molle, 2004]. This system is described more detailed in chapter 2.9.2. Apart from the below described pretreatment systems, grids or degreasers have to be installed if necessary.

Three chamber septic tanks

Three chamber septic tanks are particularly suitable for small-medium tourist facilities as agro tourism, hotels, camping and villages. Their functionality is also

guaranteed in case of floating hydraulic load or seasonal use. In the three chamber septic tank a fall-out of the sedimentable solids contained in the wastewater (primary sedimentation) takes place. The three chambers of the septic tank are hydraulically connected in series. The minimum design requirements are described in the national guidelines for constructed wetlands.

Emscher Brunnen/Immhoff tanks

The Emscher Brunnen or Immhoff tank consists of two separate compartments, a first sedimentation compartment and second a digestion compartment, where anaerobic fermentation and stabilization takes place. The sedimentable solids are captured in the first chamber of the septic tank and then fall down through the slots that are connecting the second chamber, where the organic substances are subject to anaerobic fermentation and stabilization processes.

Wastewater ponds

Ponds are used as a pretreatment before vertical constructed wetlands especially at bigger constructed wetlands (up to 4,000 pe) in Germany. The size of wastewater ponds for pretreatment ranges from 1.5 to 4 m² per pe. A partly reduction of COD, BOD₅ and a very effective reduction of settleable (SS) and suspended solids (TSS) <100 mg/l can be achieved. Floating macrophytes, like Lemna, can be used in order to reduce odor and isolate the wastewater from the surrounding. The usage of large volume primary treatment can also provide a better quality of the secondary treatment influent, especially if it consists in VF reed beds

Sealing of the filter beds

Bottom and sidewalls of the filter bed have to be waterproof, if a contamination of the groundwater can be expected. In the case of sealing with natural soil a $K_f < 10^{-7}$ m/sec is required and a minimum thickness of 30 cm should be given. Artificial sealing with impermeable layer: The material should be acid-resistant and alkali proof, frost-resistant, roots and rodent resistant, non toxic, easy to carry and move, made of recyclable materials (preferred material: HDPE or LDPE).

Construction and sizing of the filter

In several European countries national guidelines for constructed wetlands have been established that differ from each other in their sizing and construction recommendations. They are derived from the experiences with different construction practices, different materials used and different purification requirements prescribed. The examples in table 1 and 2 show the variety of possible construction ways. Constructed wetlands are not yet a wide spread way for waste water treatment, but they are a prospering technique. In some countries the official guidelines do not necessarily represent the state of the art.

Experts specialized on constructed wetlands can choose the appropriate system according to the needs of the user, the treatment requirements prescribed by the water authorities and the local circumstances, like the special aspects at tourism facilities.

An important fact for tourism facilities is how to deal with seasonal, weekly or other fluctuations in wastewater flow which is typical in hotels, restaurants, holiday apartments, camping sites and others. They should be measured or estimated as precise as possibly before planning the system (see also chapter 1.1). The size (and costs) of the filters also can be reduced by implementing a buffer tank before or after the pre treatment. Constructed wetlands usually are dealing very well with fluctuations of wastewater quantity. They can also be rested for a period and "switched on" again without losing purification efficiency.

Horizontal flow filter

The sizing procedure can be performed using the scientifically approved methods, like the various first order kinetic equations [Kadlec et al., 2000] for the pollutants removal and the Darcy law for the hydraulic aspects.

As alternative and simpler way it is possible to use guideline recommendations for the design (see table 1). They are based on area coefficients like "area per pe" or "area per gram of COD" (area loading rate, EPA manual).

Parameter	Germany ATV DVWK A 262 (draft 2004)	Austria ÖNORM B2505 (draft 2003)	Great Britain Cooper et al., 1996	Denmark Brix and Jo- hansen 2004	France Molle et al., 2004
Area (m ²)/pe	5 min. 20 m ²	5 (2) 2 (3)	5 (2) 0.5-1 (3)	5 min. 25 m ²	5 (BOD 150√300 after a 1° septic tank or Imhoff tank) 2-3 (for BOD 100 mg/l, after vertical filters as 1 st stage)
Filling material Main layer	> 50 cm	> 50 cm sand: 0/4 (greywater) > 50 cm sand: 1/4 (3°) > 50 cm sand: 4/8 (2°)	gravel: 3/6 mm or 5/10 mm or 6/12 mm	0.3 mm < d ₁₀ < 2 mm 0.5 mm < d ₆₀ < 8 mm	Pea gravel: 4/8 1/4 in second stage vertical filters
Permeability of the main layer K _f (m/s) U = d ₆₀ /d ₁₀	10 ⁻⁴ -10 ⁻³ < 5	≈ 0 ⁻⁴	≈ 0 ⁻³	1*10 ⁻³ < 4	≈ 1x10 ⁻³ – 3x10 ⁻³ in operation: 3x10 ⁻³ – 5x10 ⁻³
Hydraulic surface load	40 mm/d	50 mm/d	< 50 mm/d (2) < 200 mm/d (3)	–	–
Organic load	–	112 kg/ha*d	–	–	–
depth	0.5 m	–	0.6 m	0.6 m	0.6 m

Table 1: Examples for the design of horizontal flow systems
(2) = secondary treatment; (3) = tertiary treatment

Vertical flow filter

The sizing procedure for VF beds is mainly based on the nitrification process; in fact, when the treatment goals required for ammonium concentration are fulfilled, all the other parameters are satisfactory eliminated too. A common practice for dimensioning VF reed beds is to calculate an area coefficient per person equivalent like described in several national guidelines.

Parameter	Germany ATV DVWK A 262 (draft 2004)	Austria ÖNORM B2505 (draft 2003)	Great Britain Cooper et al., 1996	Denmark Brix and Jo- hansen 2004	France Molle et al., 2004
Area m ² /pe	4 min. 16 m ²	4 (2) 1 (3)	(2): 1 (BOD ₅), 2 (BOD ₅ +N) < 100 pe: 1 st 3,5 x pe ^{0,35} + 0.6 pe 2 nd 50% of the 1 st	3.2 m ² /pe min. 16 m ²	1 st 1,2 (3 x 0,4) 2 nd 0,8 (2 x 0,4)
Filling material (from top to bottom)	> 50 cm sand	10 cm gravel 8/16 mm	8 cm sand 15 cm gravel 6 mm 10 cm gravel 12 mm	15 cm woodchips or seashells	1 st : > 30cm 2/8 mm 10–20 cm 5/20 mm 10–20 cm 20/40 mm
Main layer	20 cm gravel 2/8 mm	> 50 cm sand 0/4	15 cm gravel 3/6 cm	90 cm sand	10–20 cm 20/40 mm
drainage		20 cm gravel 16/32		15 cm gravel	2 nd : >30 cm 10–20 cm 3/10 mm 10–20 cm 20/40 mm
Permeability of the main layer K _f (m/s) U=d ₆₀ /d ₁₀	10 ⁻³ –10 ⁻⁴ U < 5	≈10 ⁻⁴	–	d ₁₀ 0,25– 1,2 mm d ₆₀ 1-4 mm U < 3,5	1 st : clean surface media ≈ 5,0 x 10 ⁻⁴ with organic deposits ≈ 0,2 x 10 ⁻⁴ 2 nd : upper layer 0,25 mm < d ₁₀ < 0,4 mm
Hydraulic surface load mm/d	80	–	70–80	100	400 mm on the filter in operation(dry weather flow)

Parameter	Germany ATV DVWK A 262 (draft 2004)	Austria ÖNORM B2505 (draft 2003)	Great Britain Cooper et al., 1996	Denmark Brix and Jo- hansen 2004	France Molle et al., 2004
Organic load (g/m ² *d)	COD < 20	–	BOD ₅ 20-25	–	1 st up to 40 g BOD ₅ BOD ₅
Depth	0.8 m	0.5–0.8 m	1 m	> 1 m	0.6–0.8 m

Table 2: Examples for the design of vertical flow systems

(2) = secondary treatment; (3) = tertiary treatment

1st = first stage 2nd = second stage

Another approach for the sizing is to calculate the necessary area demand by verifying the oxygen availability within the filter with respect to the oxygen demand [Platzer, 1998].

With respect to clogging prevention one attempt is to define maximum organic and hydraulic loads. A German investigation [Umweltbundesamt, 2003] led to the recommendation of a maximum TSS concentration of 100 mg/l or a TSS loading rate less than 5 g/m² d to prevent clogging.

The main filter layer consists of washed sand of selected size. The drainage can be achieved either with drainage pipes and/or with coarse gravel. In cold climate a shallow gravel cover upon the main sand layer is recommended.

In Norway the vertical beds are worked out as so called "Pre-Filters" which are covered to keep the temperature [Vatmarksfilitre, 2001]. The French VF construction [Molle, 2004] is working without special pretreatment. In the UK the vertical reed beds are assembled in series (multistage) and the beds consist of several layers of filter substrates (multilayer).

Intermittent feeding system

Through intermittent feeding the pre-treated wastewater can be charged to the filter area in intervals. The wastewater is distributed on the whole surface by perforated pipes. Depending on the terrain different options are given: the presence of a difference in height between the pre treated wastewater and the vertical filter bed allows the utilization of mechanical devices without using electric, fossil or solar energy. The intermittent feeding device could be switched either quantity or time related, or both. Usually a quantity related feeding is applied.

Different mechanical systems have been developed like valves, siphons or tipping buckets. Alternatively electric systems like pumps and electric slides can be used.

Distribution system

An even distribution of the wastewater on the whole surface has to be achieved. It is dependant on the cross section of the pipes, the distance of pipes, the distance of holes and the feeding quantity per interval. The feeding system should be situated above the surface to be accessible for maintenance works.

Free water surface system (FWS)

In order to improve the denitrification and disinfection processes it is recommended to insert deep water zones in the inlet (denitrification, settling) and shallow water zones close to the outlet (UV activity). Denitrification is taking place especially during summer season when biomass production through algae provides the necessary carbon. One or more gravel barriers near the outlet can prevent pres-

ence of algae in the outlet. Due to the different depth zones in such systems a rich and natural-like ecosystem can be easily obtained.

Investigations about pathogen removal in free water systems showed, that the total elimination increases when the whole area is divided into several single units instead of one.

Vegetation

The filter beds are usually planted with the same types of emergent macrophytes as present in the natural wetlands. Most common is 'Phragmites australis' (reed) but also 'Typha ssp.' (cattail) and 'Scirpus ssp.' (bulrush) can be used.

2.8.3 Operation requirements

Pretreatment

The sludge of the pretreatment has to be emptied in time in order to prevent sludge drift into the reed beds. The emptying intervals depend on the size of the pretreatment system and vary between one year and several years. The sludge can be stabilized in a separate sludge drying reed bed on the spot. Alternatively it can be transported to a central sewer plant for further treatment.

Horizontal flow filter

Operation and maintenance routine for the HF Systems is easy to do and requires no specialized personnel (in most cases there are no electro-mechanical units). The main periodic checks are listed below:

- Wetland vegetation uniform diffusion
- Presence of weeds
- Presence of vegetal diseases or damages by insects or animals.

The plants density must be kept over 10 plants per square meter; otherwise it is necessary to plant new reeds.

Vegetation management: the first action is to cut the reeds mechanically or manually 3 years after the plant started. The reeds debris must be subsequently removed from the bed. Further vegetation cuttings will be performed every 2 years. The inlet pipe and the first meters of the filling medium should be checked every 6 months, to verify if clogging by sedimentation of the suspended solids and biomass growing on medium surface has occurred.

Vertical flow filter

During the first year attention should be paid to the growing of the plants. Weeds should be removed until the reed is established. The following parts should be controlled in regular intervals:

- functioning of the mechanic devices especially the intermittent feeding device
- even distribution of wastewater on the filter area
- water level in the filter bed
- cutting of the plants is not necessary each year and depends on the climatic conditions. Every second or third year is reasonable in alpine climate, preferably in spring.

Free water system

The inlet settling zone has to be emptied whenever necessary. Bank vegetation maintenance is required with frequency depending on the used plants.

2.8.4 System costs

Costs are varying in the different countries. Since the technique is quite simple it is possible to reduce building expenses (cost of labour) considerably by involving the owner in the construction process.

	Vertical filter			Horizontal filter		
	Area [m ²]	50–500	500–1,000	1,000–10,000	50–500	500–1,000
Austria	120–75	–	–	–	–	–
Germany	125–110	110–90	90–75	140–105	105–70	
Italy	145	120	105	130	110	100
Latvia	150–80	–	–	–	30	–
Lithuania	110–80	–	–	–	–	–

Table 3: Costs for vertical and horizontal flow filters, €/m² including distribution, sealing, control shaft and pipes to the pretreatment

2.8.5 Trouble shooting

Reasons for malfunctioning and the adequate trouble shooting can be:

Horizontal filter

- Superficial runoff, overload: Enlarge filter area or reduce hydraulic load
 - Sludge drift from the pretreatment system: Empty pretreatment or reconstruct pretreatment
 - Clogged inlet pipes: clean pipe system
- Consecutively the inlet coarse rock has to be removed and washed for the first 30 centimeters.
- Plant disease: If vegetal diseases or damages by insect or animals have happened, an intervention of specialized personnel is required to achieve the right solutions.
 - Presence of weeds: remove them manually or by controlled flooding of the bed

Vertical filter

Apart from to the above mentioned points in VF systems the following troubles might occur:

- Displacement of distribution system upon the filter area: Adjust distribution system
- Uneven building of the sand layer: adjust sand layer
- Clogged distribution system: clean pipe system

In the case of long term these malfunctions might lead to soil clogging. After the repairing a complete restoration of the filtration capacity is possible giving a resting period of few weeks. If a resting period is not possible the filter will also recover after the clogging layer is opened and the reasons for clogging are restored.

References

- Brix, H.; Johansen, N. H. (2004)
Guidelines for vertical flow constructed wetland systems up to 30 PE (in Danish)
Økologisk Byfornyelse og Spildevandsrensning No. 52. Miljøstyrelsen, Miljøministeriet.
- Cooper et al. (1996)
Reed Beds and Constructed Wetlands For Wastewater Treatment
Medmenham, Marlow, UK: WRC Publications
- Kadlec, R. et al. (2000)
Constructed wetlands for pollution control
IWA Publishing, London
- Platzer, C. (1998)
Design recommendations for subsurface flow constructed wetlands for nitrification and denitrification
In: Proceedings – 6th Int. Conf. on Wetland Systems for Water Pollution Control. Sep 27th to Oct 2nd 1998, São Pedro, Brazil
- Vatmarksfiltre (2001)
VA/Miljø-blad av Vatmarksfiltre Nr. 49, 2001
Norwegian guideline for constructed wetlands
- Molle, P. et al. (2004)
How to treat raw sewage with constructed wetlands: An overview of the french systems
In: Proceedings – 9th Int. Conf. on Wetland Systems for Water Pollution Control. 26th to 30th Sept 2004, Avignon, France
- Umweltbundesamt (2003)
Bewachsene Bodenfilter als Verfahren der Biotechnologie
ISSN 0722-186X, Berlin
- U. S. EPA Environmental Protection Agency (1993)
Subsurface flow constructed wetland for municipal wastewater treatment
EPA 832/R/93/001 Office for Water, Cincinnati Ohio
- U. S. EPA Environmental Protection Agency (2000)
Constructed Wetland Treatment of Municipal Wastewaters
EPA/625/R-99/010 Office for Research and Development, Cincinnati Ohio
- ATV – Abwassertechnische Vereinigung (draft 2004)
Behandlung von häuslichem Abwasser in Pflanzenbeeten
German ATV – Standards Wastewater/Waste, Guideline A 262
- ÖNORM B2505 (draft 2003)
Bepflanzte Bodenfilter (Planted soilfilters) – application, design, construction and operation
Vienna, Austria

2.9 Aerobic sludge treatment

Optimal sludge treatment aims at:

- Closing the natural cycle
- Reuse in agriculture and landscaping
- Reducing landfill disposal of sludge
- Reduce chemicals and energy consumption through nature-orientated sludge treatment techniques

Two nature-orientated procedures are introduced here:

- Sludge treatment reed beds (STRB) are successfully used in Europe for more than 10 years.
- Raw wastewater application to constructed wetlands: Reed bed filters for raw domestic wastewater combine waste water and sludge treatment in one system. Research on this process has been carried out by CEMAGREF Lyon in France. This may well be a key solution for wastewater treatment in climates without freezing temperatures.

Both systems combine the following advantages:

- low investment and operation costs
- easy maintenance and plant management
- low or modest level of mechanisation
- minimum of external energy input
- reliability

2.9.1 Sludge treatment reed beds

The treatment of sewage sludge in a reed bed means dewatering, volume reduction and stabilisation of the sludge without additional energy input. The sludge reed bed is in operation for an average of 10 years and achieves a sludge residue with a dry matter content of approx. 30–40%. The filter beds resemble the conventional drying beds with a filter layer of sand and gravel and a drainage. The leachate from the drainage is led back to the sewage treatment plant. The second function of the drainage system is the aeration of the filter and the sludge residue. The decomposition mechanisms in a sludge drying reed bed are very complex and result from the co-operation between reed, micro-organisms, sludge and filter material. In the planted beds, the reeds create a large drying and ventilation network along the stems, rhizomes and roots. Following these paths, the water percolates to the bottom of the beds. Due to dewatering, decomposition and compaction of the material the volume of the sludge is reduced by 85% in the reed bed during an operation cycle. The total nitrogen content is reduced by nearly 50%. Potassium, calcium, magnesium and sodium show only a slight decrease in relation to the original mineral input.

The end-product "mineralised sludge" is a crumbly, light, brown-coloured material with a typical earthy smell. After 10 years of treatment, organic components and pathogenic micro-organisms are reduced and the final product is suitable for agricultural use. Pollution with heavy metals should be avoided from the beginning. Sensitisation and information campaigns have been very successful in achieving this.

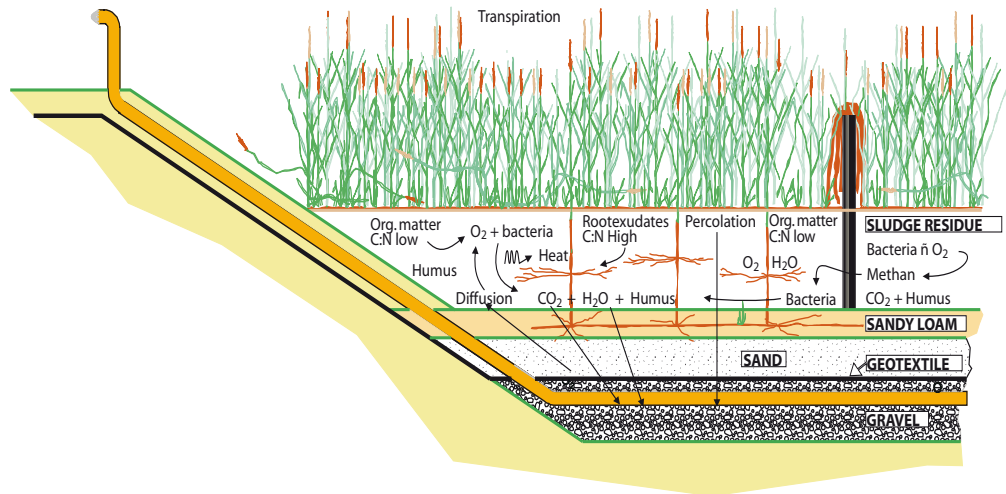

Figure 1: Decomposition and drying processes in a STRB (Nielsen, 2004)

Dimensioning of the sludge treatment reed bed is based on sludge quantity, quality and climate. For treatment of secondary sludge (i. e. after an activated sludge plant in extended aeration for the treatment of domestic wastewater) the total required surface is 0.25 m²/pe. This means a specific load of 50–70 kg dry matter/(m²y). In climates having periods without vegetation (winter) an increase of the surface up to 0.5 m²/pe is recommended. At least 4 separate beds shall be provided which are fed in rotation.

When the STRB is used for primary sludge after a pretreatment (i. e. Imhoff tank or 3-chamber septic tanks) combined with an RBTS an area of 0.4–0.5 m²/pe is needed. At least two beds are required to allow a switch for the emptying process. A drying and resting period without addition of new material for 6 months to 1 year should be respected before emptying. During this time the one bed to be emptied is not fed and the sludge is directed to the remaining beds



Figure 2: Sludge treatment reed beds for a one family house

The STRB for a one family house consists of a prefabricated concrete bottom slab and rings of 2.5 m diameter as they are used for a 3-chamber septic tank. Once a year, the sludge is withdrawn from the septic tank with a vacuum cistern or pump and spread onto the surface of the filter bed. The bed is located on the slope above the septic tank so the leachate can easily be conducted back into the septic tank.



Figure 3: An STRB for primary sludge from a 3-chamber septic tank of a 32 pe RBTS ("Weissmann" demonstration site)

The STRB is fed with a vacuum cistern. The leachate returns to the septic tank by gravity flow. Shortly after construction, the reed was still very small.



Figure 4: Kolding Sludge Reed Bed System (Denmark)

The picture shows the Kolding Sludge Reed Bed System (Denmark) which was established in connection with the Kolding Wastewater Treatment Plant for a load of 125,000 pe and started operation in 2000. The sludge comprises excess sludge from biological removal of phosphorous (65%) and sludge from a sludge digester (35%). The system has 13 planted basins and an area of approximately 62,000 m² [Nielsen, 2004].

2.9.2 Raw wastewater application

Research has been carried out by CEMAGREF Lyon in France about raw wastewater application to constructed wetlands, i.e. implementation of constructed wetlands without prior primary treatment.

General configuration of the system

A typical plant consists of two stages of filters: a first stage of vertical flow reed beds, which are fed with raw wastewater is followed by a second stage of vertical flow filters. Only a bar screen has to be installed for pretreatment at the inlet of the 1st stage. Coarse grained filter medium (gravel) is used in the first stage. The second stage filter beds are filled with two layers of sand and gravel. Both stages have a drainage layer of pebbles or drainage bricks at the bottom.

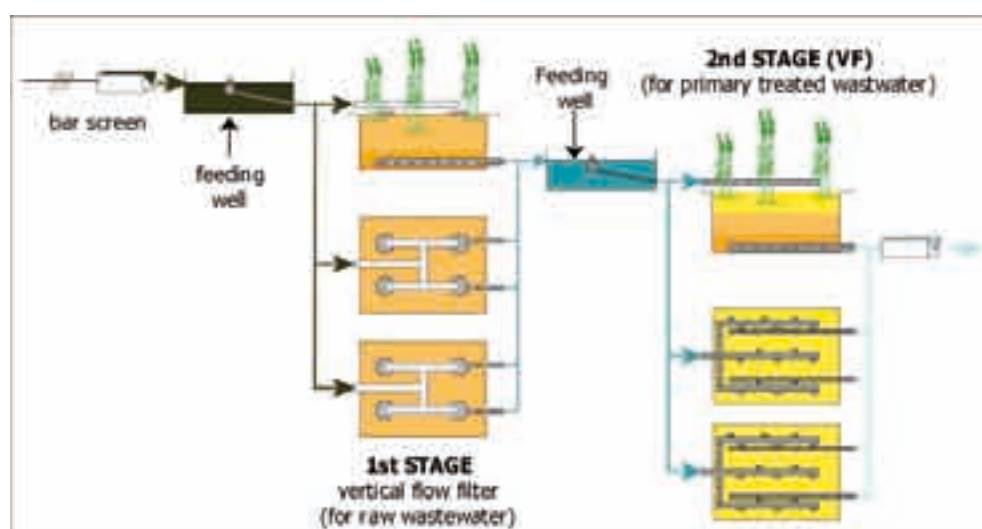

Figure 5: General configuration of the system (Liénard, 2003)

Each stage is divided into 3 units that operate independently. Each of the first stage units (type A filter) receives the full organic load during the feeding period, which lasts 3 to 4 days and is followed by a resting period twice as long. For very small plants, ≤ 100 pe, the investment cost per capita can be reduced if only 2 units per stage are implemented.



Figure 6: First stage bed just after completion and before reed planting (Photo: Liénard, 2003)

The feeding system with outlets and the top ends of the drainage pipes which are also used for ventilation of the beds from the bottom are well visible. A concrete slab below the outlets prevents erosion.

Dimensioning

The dimensioning is based on experience. The first stage filters receive the larger part of organic load and suspended solids and require a larger total surface of 1.2–1.3 m² per pe, divided into 3 identical, alternately fed units of 0.4–0.45 m² per PE (global organic load of 100 g COD/(m² d)). This dimensioning allows a reduction of more than 80% of COD and 85% of TSS as well as a beginning of nitrogen oxidation. The dimensioning of the 2nd stage filter area depends mostly on the hydraulic load that is applied and the distribution on the surface. The minimum is 1 m² per pe [Boutin et al., 1997, 2000].

Operation

Wastewater is supplied to the filters in hydraulic batches by a high capacity feeding system (pumps or self-priming siphon if topography allows). This ensures a distribution of wastewater over the available infiltration area and improves oxygen renewal between the feedings due to convection induced by the water movement. The alternating phases of feed and rest are important for microbial growth on the filter material (sand, gravel and rhizomes), to maintain aerobic conditions within the filter bed and to mineralise the organic deposits.



Figure 7: 1st stage filter 3 and 10 weeks after sludge withdrawal, french plant (Liénard, 2003)

It can be assumed that both systems, the sludge treatment reed bed and the reed bed filter for raw wastewater, will be more effective with higher treatment rates and final dry matter content in warm and dry climates without freezing periods. After 10 years of treatment, hazardous organic compounds and pathogenic microorganisms are extensively reduced and the end product is suitable as a high-quality fertiliser in the agriculture. Therefore pollution with heavy metals should be avoided from the beginning. Sensitisation and information campaigns have been very successful in achieving this.

References

Boutin, C.; Liénard, A.; Esser, D. (1997)

Development of a new generation of reed-bed filters in France:

First results

Wat. Sci. Tech, 35 (5), 315-322

Boutin, C.; Liénard, A.; Lesavre, J. (2000)

Wastewater treatment plants for small communities: Five attached-growth cultures on fine media

In: 1st world water congress of IWA, Paris, FRANCE, 3-7 juillet 2000, Poster CD ROM, ref. L.179

Liénard, A.; Boutin, C. (2003)

Constructed Wetlands for Wastewater Treatment and Sludge Dewatering

The French Experience, Confernece on Constructed Wetlands: Applications and Prospects, ARPAT, Florence

Steen Nielsen (2004)

Sludge treatment and drying in reed bed systems

Erneuerbare Energie 2/2004, AEE INTEC, Gleisdorf

2.10 Rainwater harvesting

Rainwater is an alternative source of water, freely available and with some advantages compared to most mains water. However, rainwater harvesting should not be implemented without exhausting water saving measures simultaneously.

2.10.1 Characteristics and yield/efficiency

Rainwater is perfectly safe in tourism facilities for use:

- In WC's for flushing toilets
- In urinal systems
- In washing machines; rainwater is very soft and allows to save tensides
- Cleaning of floors, outside pavements, cars
- In the garden

	Potable water	Bathing water (76/160/EEC ¹)		Gourmet salad	Median values of 102 cisterns during a prolonged test period
		Guide standard	Imperative standard		
Escherichia Coli	0/100 ml	100/100 ml	2,000/100 ml	1,000/g	26/100 ml
Coliform bacteria	0/100 ml	500/100 ml	10,000/100 ml		198/100 ml
CFU [20 °C]	1,000/ ml				1,200/ml
CFU [37 °C]	100/ ml			1,000,000/g	230/ml

Table 1: Bacteriological standards of drinking and bathing water compared to microbial load observed in rain water cisterns and salad [König K., 2004]

1 Council Directive 76/160/EEC of December 1975 concerning the quality of bathing water, OJ L 31 of 5.2.1976 – Bathing Water Quality Directive

A disinfection of rainwater stored in a light-proof tank is not necessary, even if rainwater is used for laundry. Many investigations about water quality, especially with respect to microbiological parameters, and about user satisfaction have been carried out and yielded equal or even better marks for rainwater than for water from the mains as far as the applications listed above are concerned.

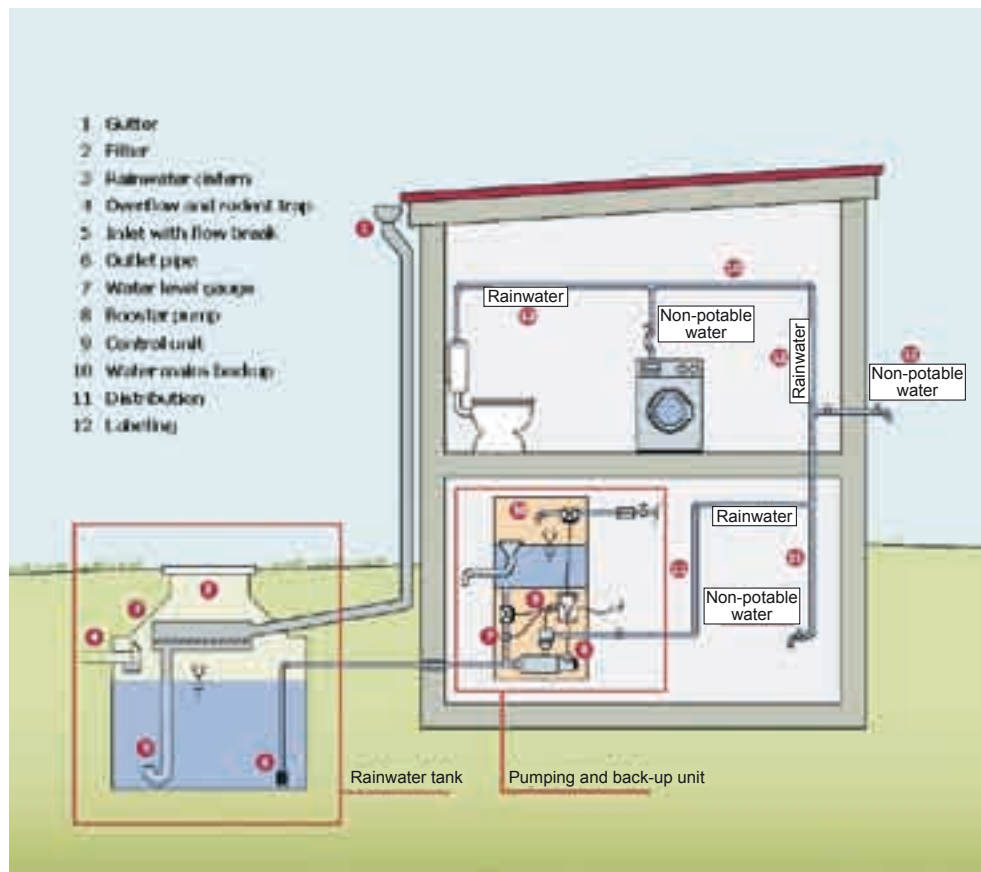

Figure 1: Rainwater system with its main components [modified from Hessisches Ministerium für Umwelt, 2004]

Components

- The collecting surface: only connect suitable roof surfaces if the system does not include a treatment. Take into consideration possible erosion of hazardous matter from the roof. With an appropriate treatment water from pavements can also be used (see corresponding further elements within brackets).
- Gutters and downspouts (gullies and rainwater drains)
- Filter – to suit roof surface area (treatment system, e.g. constructed wetland)
- Tank – above or below ground
- Controls and Pump – Use long life booster systems. Single and Duo pump systems can be installed, with varying pump sizes dependant on project size / flow requirements. Duo pump systems alternate pump start ups and have the additional benefit to enable both pumps to run at times of high water demand.
- A distribution system – which must be clearly separated from the potable water distribution system. All pipes and outlets must be labelled accordingly².



² No European standard for non-potable water pipes exists until now. In Australia such pipes are colour-coded (deep purple or lilac) in accordance with AS/NZS 3500.5:2000, section 2.16.6.1. In the EU usually rainwater pipes are labelled according to COUNCIL DIRECTIVE 92/58/EEC, in Germany (and other countries, e.g. Spain) concretised with DIN 2403.

Dimensioning

Service level of rainwater systems

The type of service level the rainwater system is intended for, and the required degree of security, will strongly influence its layout, especially the storage volume. Maintaining water supply under almost all conditions, including extended dry spells (high security), will require a larger tank than that needed to maintain supply under normal or average conditions (lower security). Lower security will mean water rationing or alternative sources of supply may have to be used more frequently. We can distinguish 3 types of service levels:

Intermittent

This type of pattern is one where the requirements of the user are met for a part of the year. A typical scenario is where there is a single long rainy season and, during this time, most or all of the user needs are met. During the dry season an alternative water source has to be used.

Partial

This type of pattern provides for partial coverage of the water requirements of the user, during the whole of the year.

Full

With this type of system the total water demand of the user is met for the whole of the year by rainwater only. This is sometimes the only option available in areas where other sources are not available (e. g. for high alpine shelters). Sufficient a/ rainfall, b/ collection area, c/ storage capacity is required to meet the needs of the user and a careful feasibility study must be carried out before hand to ensure that conditions are suitable. This level of service will only be required in very remote and dry places, e. g. some high mountain shelters.

Volume of water needed

The volume of water needed may vary from one area to another. Water demand will depend on:

- the number of people using the water
- average consumption per person
- the range of uses (human consumption, food preparation, bathroom, laundry, toilet, garden, etc.)
- the use of water conservation devices.

Water consumption per customer and/or unit as a restaurant seat or a meal may greatly vary from one location to another and more especially from one country to another. In SWAMP water consumption rates per pe³ ranged from 90 to 1,000 l per day. A detailed assessment for the specific facility is indispensable (see chapter 3.1 Auditing of tourism facility).

Input

Average rainfall

In general, the most accurate source of rainfall information is the national meteorology service. Check also with nearby airports, agricultural research stations, etc. for rainfall data. In addition to average rainfall (annual and monthly) it is important to consider yearly variations, seasonality of rainfall and the occurrence and length of dry spells. A detailed simulation of rainfall data will normally not be feasible for the size of installations envisaged.

³ It was not possible to obtain the precise number of guests. Therefore water consumption is related to PE, expressed as 60 g/BOD₅.

Area of roof catchment

Calculate the area covered by the parts of the roof from which the water is to be collected. It is the flat or plan area (including eaves) that should be determined. The slope or pitch of the roof and the actual area of tiles or metal is not important. The maximum amount of rainwater available can be calculated using the formula:

$$\text{run-off (litres)} = A \times (\text{rainfall} - B) \times \text{roof area}$$

'A' is the efficiency of collection as a percentage of total rainfall. It can be assumed that a self cleaning filter has a 90% efficiency, other losses compared to measured rainfall may occur at the gutters, through wind etc. Values of 0.8–0.85 (that is, 80–85% efficiency) have been used.

'B' is the loss associated with absorption and wetting of surfaces and a value of 2 mm per month (24 mm per year) has been used. B is a constant value, independent of the amount of rainfall. It is rather a function of the frequency of rainfall.

- 'Rainfall' should be expressed in mm and
- 'Roof area' in square metres (m²).

If the maximum volumes are less than the annual water demand, then either the catchment area will need to be increased or water demand will need to be reduced.

Storage tank

There are several methods to dimension rainwater tanks. In some regions a rule of thumb is available for the dimensioning of small tanks as a function of the number of users and the roof area. These rules are well known and generally applied by suppliers of ready-made tanks. The method, though very suitable for single houses and household uses, however can not be recommended for larger tanks and more commercial applications. Two other methods, described here, are

- A. a rough dimensioning based on average monthly rainfall data
- B. a detailed calculation of the storage volume needed based on measured rainfall series

A) Rough dimensioning (Australian Government 2004)

The simplest way of checking a tank size estimated to provide water throughout an average year, is to use monthly rainfall data. The following formula should then be used for each month:

$$V_t = \text{Minimum}(V_{t-1} + (\text{Run-off} - \text{Demand}); V_{ST})$$

V_t = theoretical volume of water remaining in the tank at the end of the month.

V_{t-1} = volume of water left in the tank from the previous month.

V_{ST} = total storage volume available

Run-off should be calculated as discussed above ('A' = 0.8; 'B' = 2 mm).

Starting with the tank empty then $V_{t-1} = 0$. If, after any month, V_t exceeds the volume of the tank, then water will be lost to overflow. If V_t is ever a negative figure then demand exceeds the available water. Providing the calculated annual run-off exceeds the annual water demand, the year will end with a certain volume of water remaining in the tank, V_{t-1} . This volume can be used as a starting input for a next calculation run. If not the first, then in one of the next years, the volume will not be negative anymore, except if periodic overflows reduce the amount of water collected so the total stored is less than the total demand. In this case the size of the tank chosen must be increased in order to reduce overflows. The mini-

imum storage volume needed is the difference between the highest and the lowest volume (plus any reserve volume).

$$V_{ST} = \text{Maximum}(V_i) - \text{Minimum}(V_i) + V_{\text{reserve}}$$

$$V_i = V_{1'}, V_{2'}, \dots V_{12}$$

B) Detailed calculation

A more detailed dimensioning is possible with daily rainwater data, if such data are available. Either real data can be used or randomised series are synthesised. In order for this method to yield better results than method A) detailed information about water demand and demand patterns must also be available. For the computation of the input 'B' will be a wetting loss per rain event rather than per month (If no other information is available a value of 1 mm can be used).

The computation of the storage volume is the same as with Method A), except for the more detailed input data. Overflow events and periods when the tank is empty can be statistically assessed and the tank volume fine-tuned to an acceptable level of security.

Example for method A): Hotel with summer peak season

We assume a hotel with the following characteristics: roof area 920 m²

Domestic demand	Demand/Guest	Potable Water	Rainwater
Human consumption	3	3	
Dish washing	10	10	
Washing	10	10	
Shower/bath	60	60	
Laundry	22		22
Toilet flushing	45		45
Cleaning	15		15
Irrigation *)	8		
Others	12		12
Total	185	83	94

Table 2: Specific water demand (result of audit)

*) Irrigation demand is taken into account separately (see table 3)

Waterdemand [m³]	days/month	Average # of guests/residents	# of guest-days	Monthly domestic demand	Irrigation	Monthly demand incl.
January	31	5	155	12.9		12.9
February	28	5	140	11.6		11.6
March	31	5	155	12.9		12.9
April	30	21	630	52.3		52.3
May	31	19	589	48.9		48.9
June	30	24	720	59.8	12.0	71.8
July	31	29	899	74.6	12.0	86.6
August	31	30	930	77.2	12.0	89.2
September	30	21	630	52.3	7.7	60.0
October	31	10	310	25.7		25.7
November	30	5	150	12.5		12.5
December	31	5	155	12.9		12.9
Total Demand	365		5,463	453.6	43.7	497.3
Dry year run-off	m ³ /year					556.1
Covering rate						112%

Table 3: Monthly water demand for domestic and landscaping purposes

	Rainfall [mm/M]	Dry year Rainfall (75%)	Run-off	Demand	Storage Volume
January	31	23.3	19.6	12.9	6.7
February	36	27.0	140	11.6	18.1
March	49	36.8	23.0	12.9	30.0
April	52	39.0	34.0	52.3	11.7
May	84	63.0	56.1	48.9	19.0
June	119	89.3	80.3	71.8	27.4
July	126	94.5	85.1	86.6	25.9
August	115	86.3	77.5	89.2	14.2
September	76	57.0	50.6	60.0	4.8
October	58	43.5	38.2	25.7	17.3
November	59	44.3	38.9	12.5	30.0
December	33	24.8	20.9	12.9	30.0
Total		658.5	556.1	497.3	25.2

Table 4: Calculation of rainfall proceeds and storage volume. For greater coverage a dry year with 75% of normal rainfall was assumed. Run-off was calculated with 'A' = 80%, 'B' = 2 mm/month

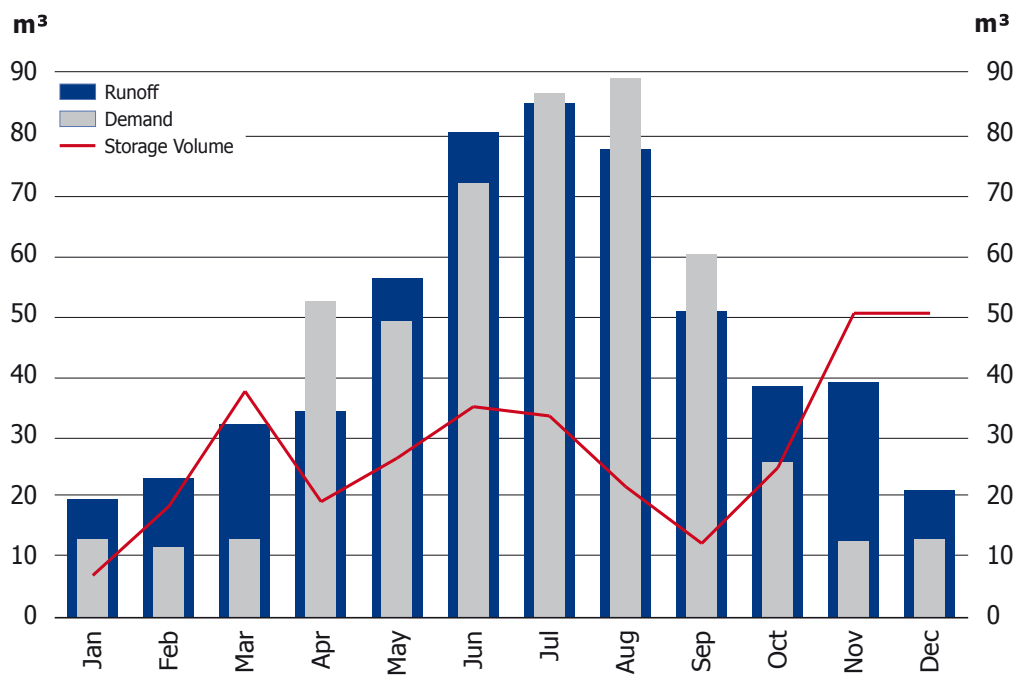

Figure 2: Monthly run-off, demand and water volume in storage

The necessary storage volume is the difference between the maximum and the minimum value plus any reserve volume. In this example the minimum storage volume is 25.2 m³ excluding reserve volume.

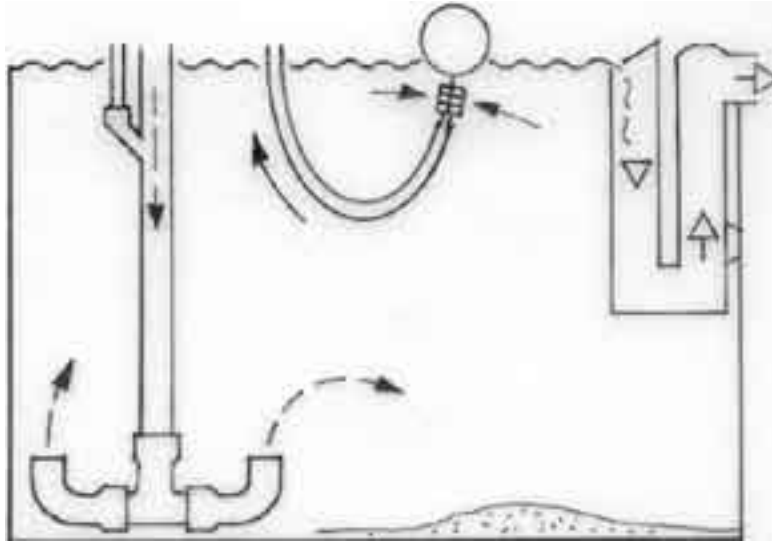

Figure 3: Layout of the key elements of the storage tank: Inlet with flow break, outlet with strainer and float, overflow as siphon with a rodent trap.

Operation and maintenance requirements and costs

There are no special maintenance requirements. The following maintenance tasks have to be carried out in order to guarantee a stable water quality and permanent operation of the system.

Check once a year

- function, especially grade and state of gutters, downspouts and connections
- odour and visual aspect of rainwater in the cistern
- tightness of cistern, connections and cover
- function of electro-mechanical equipment
- state of rainwater distribution pipes
- tightness and protection of taps
- labelling of distribution system and taps.

Every 5 to 10 years

- clean the tank.

Check according to supplier's instructions

- state and function of filter.

System costs and economic feasibility

A general assessment of the economic viability of a rainwater system is not possible as this depends of the local cost for the system components, most of all the tank, and the cost for water. Payoff periods of a few years to sometimes more than 10 years are possible. However, the main components, i. e. the tank and the collection and distribution system have a lifetime of 30 to 50 years.

Trouble shooting

The following factors have to be taken into account for the safe operation of a rainwater system:

- suitable roof surfaces free of hazardous pollution.
- a suitable filter between collection surface and storage tank

- guaranteed sedimentation through flow breaker at the tank inlet (two 90° elbows from a tee upwards at the bottom of the tank are most suitable, see Figure 3)
- the tank should be light-proof
- protection of the rainwater from sewer gas
- protection of the overflow pipe against rodents and backflow from the sewer
- the outlet should have a strainer and be suspended on a float just below the surface
- the system needs regular inspection.

If these issues are taken into consideration the rainwater can be used without limitations for the purposes given under 2.10.1.

References

Australian Government Department Of Health and Ageing (2004)

Guidance on Use of Rainwater Tanks

Australian Government 2004

DIN 2403 - Kennzeichnung von Rohrleitungen nach dem Durchflusstoff

("Marking of pipes according to medium carried")

Hessisches Ministerium für Umwelt, ländlichen Raum und Verbraucherschutz (editor), (2004)

Nutzung von Regenwasser in Haus und Garten ("Use of rainwater in house and garden")

Wiesbaden

König, K. (2004)

Rainwater Harvesting

In: Train of Trainer Seminar, Sustainable Concepts towards a Zero Outflow Municipality

AEE INTEC 2004

2.11 Irrigation

The ancient practice of applying human excreta to the land has maintained soil fertility in many countries of Eastern Asia and the Western Pacific for over 4,000 years, and remains the only agricultural use option in areas without sewerage facilities [Mara, 1989].

This chapter is not so much about irrigation, which was not part of SWAMP investigations, but rather about the particular aspects related to irrigation with reclaimed water and a few other aspects of sustainability relevance. With respect to irrigation, wastewater from tourism facilities is equivalent to domestic wastewater. Each person typically produces 1.8 litres of excreta daily; this comprises 350 grams of dry solids, including 90 grams of organic matter, 20 grams of nitrogen, plus other nutrients – mainly phosphorus and potassium. One person can produce as much fertiliser as necessary for the food needs of one person [Niemczynowicz, 1997]. Safely recovering and reusing human wastes as soil conditioner offers several benefits, including a reduction in effluents to receiving water bodies and the opportunity to re-build soil with valuable organic matter. This approach can also reduce the amount of so-called chemical fertilisers produced, or mined¹. Under conventional sanitation conditions 45 l of drinking water are used to evacuate these 1.8 l of excreta. Saving part of that water consumed can make unpolluted, potable water available for other uses, e.g. irrigation. This means that additional water is available without any further treatment, ready to be used for the most sensitive cultures.

Irrigation with reclaimed wastewater can have several quite different goals. We can distinguish:

1. reuse of treated wastewater in agriculture
2. reuse of nutrients in agriculture
3. saving irrigation water for landscaping of green areas around the tourism facility by using treated wastewater
4. disposal of wastewater for lack of another receiving body.

The choice will much depend on the location of the facility, including climatic conditions, availability of agricultural areas in the vicinity and availability of water. The different goals have implications on the system design and layout. Therefore, the goal must be clear before starting to design the system. Sensitivity to health-hazards caused by wastewater will also differ from one application to another. A discussion of technical implications follows below, whereas potential hazards are treated at the end of the chapter.

2.11.1 Reuse of wastewater in agriculture

SWAMP designed two examples, where wastewater was intended to be reused in agriculture:

- "Fischerhof" restaurant and sanatorium
- Park Moräne See (see also below)

In both examples the irrigation part of the scheme was not implemented. At Fischerhof the problem was that the sanatorium uses a substantial quantity of pharmaceuticals which are partly released into the wastewater. For this reason the

¹ Nitrogen is synthesised through the Haber-Bosch process with high inputs of energy (1.2 tons of petrol for 1 ton of nitrogen), whereas phosphorus is exclusively mined and is therefore a limited resource, the world reserves being predicted to last another 150 to 200 years.

authorities did not issue a permit for the reuse of the wastewater treated in a CW. The effluent of the plant is instead released into the nearby Gurk river. At Park Moränasee efforts are still ongoing to implement the scheme. However the effort to co-ordinate all the stakeholders, i.e. the authorities, farmers, camping resort, is such that an agreement could not yet be reached. There is, however, a long history of wastewater use for crop irrigation. The list in table 1 gives an overview of some examples.

Americas	
Mexico	• Cereals, vegetables, fodder, parks
Peru	• Vegetables, fodder, cotton
Chile	• Vegetables, grapes
Argentina	• Vegetables, fodder
U.S.A. (Calif.)	• Vegetables, cereals, fodder
Middle East and Asia	
Kuwait	• Cereals, fruit trees, fodder
Jordan (indirect)	• Vegetables, crops consumed processed
Israel	• Cotton
Saudi Arabia	• Cereals, fodder
India	• Cereals, vegetables
Europe	
Germany	• Cereals, sugar beet, potatoes
S. Europe	• Non-food crops, parks
North Africa	
Tunisia	• Citrus, fodder
Morocco	• Vegetables, fodder
Egypt	• Trees, fruit trees, cereals

Table 1: Selected examples of wastewater reuse in agriculture

Nevertheless, the attitude towards new projects of wastewater reuse is very sceptical. Reason is probably the lack of appropriate guidelines and the fear of hazards. This fear is however not substantiated by existing experiences even though hazards exist and a proper management of those hazards and handling of the wastewater used in irrigation is necessary. For more information on hazards see below.

All available irrigation techniques have been used to apply wastewater to crops, from traditional surface irrigation to the most advanced subsurface irrigation. They are all suitable for the reclamation of wastewater, even though they are not all equally appropriate with any crop. They will also need different degrees of preparation of the wastewater from a technical point of view.

Subsurface irrigation, however, is only applicable with special prevention against microbial growth inside the tubes and prevention of root growth into the drippers. This is achieved through chemical liners releasing toxic chemicals over a long period or the addition of such chemicals to the irrigation water, which is not recommended from a sustainability point of view.

Irrigation technique	Minimum treatment requirements	Crop exposure	Labour exposure
Surface irrigation	Grit removal, especially plastics	medium	high
Spraying with watering can	Grit removal	low to medium	medium
Spraying with vacuum cisterne	Grit removal, especially plastics	high	high
Sprinkler irrigation	Elimination of coarse solids	high	high
Drip irrigation	Elimination of solids	low	low
Subsurface irrigation	Very high degree of solids elimination; addition of chemicals against growth in tubes and root intrusion, therefore not recommended	low	low

Table 2: List of irrigation techniques with respect to wastewater irrigation

2.11.2 Reuse of nutrients in agriculture

SWAMP has two examples, where the reuse of nutrients was an explicit goal of the system implemented. Both examples are located in Germany:

- Burg Lenzen from BUND Niedersachsen
- Stranddorf Augustenhof

At both sites, the wastewater system comprises a separate collection of urine for its further reuse as nitrogen and phosphorus fertiliser in agriculture (see also chapter 2.4.). Urine contains more than 80% of the nitrogen and 50% of the phosphorus produced. Thus, separate collection of the urine is the easiest way to reclaim the better part of the nutrients contained in excreta. In order to avoid hazards from microorganisms, storage of the urine during 6 months will be sufficient to eliminate pathogens.

Urine separation toilets, flushing toilets as well as dry toilet systems are readily available on the market. Urinals, which do not need flushing and thus reduce the volume to be stored and handled, are equally available. A list of products with description can be found in the SWAMP product catalogue on the SWAMP homepage.

Modern agriculture may now be responsible for one-half of the nitrogen fixation on earth through

- the use of fertilisers produced by industrial fixation
- the growing of legumes like soy beans and alfalfa [Kimball, 2005].

It would seem that nutrients contained in wastewater should be directly reused through irrigation instead of removing them with high cost on one side and producing fertiliser by industrial fixation on the other. However, in the case of wastewater containing nutrients it will be necessary to check the nutrients demand of the irrigated plants and make a water nutrient balance in order to comply with the water and nutrients demand of the plants, which is different from crop to crop and varying with the season. The nutrients contained in human excreta can of course be applied on crops through irrigation of the entire wastewater. Wasterwater analysis in SWAMP have found the following average concentrations of nutrients:

	N [mg/l]		P [mg/l]	
	Median	Range	Median	Range
Settled wastewater				
Median	80	22–157	11	2–21
Extreme values		8–266		0.01–39
Outlet from CW (Median)	30	7–74	2.2	0.3–10

Table 3: Amounts of nitrogen and phosphorus in the wastewater of SWAMP demonstration sites

The wide range of nutrient concentrations will make it necessary to carefully look at the nutrient content in every individual case in order to properly assess the potential and develop irrigation schedules adapted to crop water and nutrient demand. In comparison to the figures above, table 4 shows the amounts of nitrogen needed in Austria for different cultures.

Crop	kg N/ha
Wheat	130
Barley	120
Rye	100
Oat	90
Brewing barley	70
Maize	140
Sugar beet	0

Crop	kg N/ha
Potato	130
Pea, Bean	0
Soy bean	0
Sunflower	60
Vine (open surface)	70
Vine (mulch)	50
Grass	110

Table 4: Maximal nitrogen doses in kg N/ha for average yield expectations of different crops [Amlinger, 2002]

It is obvious from table 4 that those cultures, which do not need nitrogen, e.g. sugar beans or all leguminosae, would rather not be irrigated with reclaimed wastewater if other water sources are available. Even though denitrification is possible, this would be a waste of valuable resources. On the other hand irrigation amounts of up to 360 mm can be applied to grass without exceeding the nitrogen demand.

If nutrients, especially nitrogen, are not needed by the plants, but only water, as with leguminosae, instead of eliminating the nutrients through a costly treatment, it is possible to use suited fractions of treated wastewater. One option is the segregation of greywater at the source, separate collection and treatment and reuse for irrigation. Greywater only contains about 10% of the nitrogen and 25% of the phosphorus comprised in wastewater. Greywater is normally also less contaminated than complete wastewater (This was not true with the greywater collected at Fischerhof).

Another possibility to get water without nutrients for irrigation is to reuse greywater for minor purposes in the facility, e.g. toilet flushing, laundry and cleaning. The saved freshwater is readily available for irrigation. For more details on greywater treatment see chapter 2.3.

	Nutrients [kg]				
Nutrient	Urine (500 l/y)	Faeces (50 l/y)	Greywater * (25,000 l/y)	Total	Required for 250 kg of cereals
N Nitrogen	4.0	0.5	0.3	4.8	5.6
P Phosphorus	0.4	0.2	0.1	0.7	0.7
K Potassium	0.9	0.3	–	1.2	1.2

Table 5: Nutrient contents in different fractions of wastewater, comparison to plant nutrient demand

* Greywater excluding kitchen effluent

Whilst greywater from the kitchen contributes least to the total greywater volume it accounts for the bulk of fats, oils and food particles, which are the components that cause an irrigation system and the soil to quickly clog. In contrast, greywater from the bathroom and laundry accounts for the majority of the greywater volume but generally contributes least to the components that clog an irrigation system. Consequently, greywater from the kitchen is often excluded from the greywater system. Greywater from the bathroom and laundry requires only minimal treatment to remove suspended particles such as lint and hair.

Greywater contains contaminants, which vary in their effect from beneficial to detrimental for irrigation of plants. These contaminants include nitrogen, phosphorus and potassium, which in most cases are beneficial to plants, except for plants that have a low phosphorus tolerance. Greywater also generally has a slightly alkaline pH making it preferable not to use greywater to irrigate acid loving plants, unless the pH is managed by digging soil conditioners such as peat or compost into the soil.

Some laundry detergents and bleach can result in greywater with high levels of sodium salts which in higher concentrations can be detrimental to plant growth. Therefore, it is preferable to use products with low sodium levels, as found in most but not all liquid laundry detergents.

Some strong household products such as caustic soda (drain cleaner) can be quite detrimental to plant growth and should not be used. Alternative less harmful products are normally available for the same purpose. When greywater is being reused for garden irrigation users simply need to think about what is being sent to the greywater system and ultimately into the garden and ensuring that detergents, bleaches, or other cleaners and disinfectants are used sparingly to reduce impact on plants.

The black water from the toilet can be treated and used as fertiliser. Another possibility is to further segregate urine in the toilet seat and from the urinals as urine contains the major part of the nutrients with 80% of the nitrogen and 50% of the phosphorus and very low microbial contamination (see also chapter 2.4). The remaining faecal sludge contains a small residual amount of nutrients. It can be treated in a reed bed or co-composted with organic refuse leading to organic matter for land application or anaerobic treatment to yield biogas and organic matter.

2.11.3 Water saving

Especially in dry climates saving valuable drinking water, or water in general, can be the main reason to reclaim wastewater. In SWAMP this was the case for two Italian sites, Relais Certosa Hotel near Florence and "La Cava" camping site at Poppi. The camping site has implemented a greywater collection and treatment system. Using greywater only was one way to meet the Italian limits for micro-organism contamination of reclaimed wastewater (200 E.coli/100 ml max.; 50 E.coli/100 ml for 80% of samples). The greywater can be stored in a pond and is then used for landscaping of the camping site.

Relais Certosa Hotel uses wastewater treated in a hybrid horizontal and vertical flow CW for irrigation of green areas or landscaping. The hybrid system allows to comply with the stringent Italian limits for micro-organisms in reclaimed water. Using greywater only, 50% to 75% of the total water demand, which are only slightly polluted can be reclaimed quite easily. Greywater is easier to treat to high standards. See also chapter 2.11.2 about nutrients.

In this context it must be mentioned that in order to save water on irrigation the first step is to design a garden or landscape, which requires little irrigation water.

Xeriscape (USA) or xerogardening (Spain) has been developed in order to respond to this need in dry climates. It means the conservation of water and energy through creative landscaping. The name comes from the Greek word "Xeros" meaning dry.

"Your landscape is an investment in your comfort and in the value of your property. A good Xeriscape will increase your property value by as much as 15%. Xeriscape can also reduce water and maintenance costs by up to 60%" promises Xeriscape Colorado Inc. on their homepage (<http://www.xeriscape.org>).

2.11.4 Disposing of treated wastewater

Park Moränasee is a camping site near Hanover, Germany, with app. 1,000 pe. Its wastewater treatment plant discharges into the Heidbach. As the Heidbach, has a rather low flow with a water quality of 2 according to the saprobic system the requested treatment efficiency of the plant is very high. Additionally, the outflow to the Heidbach has been limited to 104 m³/d by the local water authority.

The following threshold concentrations have to be guaranteed in the outflow:

COD	70 mg/l
BOD ₅	15 mg/l
NH ₄ -N	10 mg/l
N _{tot}	35 mg/l
P _{tot}	6 mg/l

Due to the limitation of the outflow to the receiving river part of the outflow has to be stored during peak periods. A storage pond of 5,000 m³ has been provided for this purpose. During the vegetation period the treated wastewater from the storage pond should be used for irrigation. In this way the pond is emptied for the periods where no irrigation is possible. However, the irrigation was not implemented during the project period for various reasons, so that no concrete experience is available from SWAMP.

Quite often with on-site treatment of wastewater of remote tourism sites no sufficient receiving water is available. This was the case for three Austrian plants:

- Klug Veitl
- Pleschwirt
- Weissmann hotel & dairy farm

Instead of using the wastewater for irrigation, however, the effluent of the RBTS is infiltrated into the ground. This is a technique, which is much better accepted in Austria than wastewater reclamation for irrigation. The attitude of authorities, farmers and customers may change in the future due to climate change and thus an increasing stress on water resources.

If wastewater is disposed of in agriculture, nutrients leachate into the groundwater should be avoided. Dosing of water amounts must take into consideration plant nutrient requirements and soil adsorption capacity. During cold periods another means to dispose of the wastewater must be available or it has to be stored.

Hazards

Chemical contaminants remaining in the purified wastewater are often considered a lower priority than microbial contaminants, because adverse health effects from chemical contaminants are generally associated with long-term exposures, whereas the effects from microbial contaminants are usually immediate. Nonetheless, several chemicals can cause very serious problems depending on the kind of reuse.

The main concern is related to the contamination of the food chain and consumption over a long period whenever treated wastewater is going to be reused for irrigation of crops.

Chemical substances that can interfere with the normal functioning of the human endocrine system have been termed Endocrine Disrupting Chemicals (EDCs). Normal domestic wastewater contains usually some EDCs, with concentrations of $\mu\text{g/l}$ or ng/l , so they can be classified as "organic micropollutants". The most common ones are the steroid estrogens, naturally secreted by women, the phthalates, used world-wide as plastifiers, some particular surfactants contained in very common commercial formulates, like the alkylphenol polyethoxylates (APEOs) and their breakdown products, alkylphenols (APs) and alkylphenol carboxylates (APECs), and also few pesticides and PAHs (source: deposition on the soil during the dry period and then transported in the water cycle by stormwater runoff).

The discharge of effluents from treatment facilities is likely to be a significant source of input of contaminants to many systems, and the potential for concentration of hydrophobic compounds and transformation products within sludges has implications for their disposal. The nonpolar and hydrophobic nature of many EDCs produces as general effect of the wastewater treatment process an accumulation of them in the sewage sludge or on the biofilm. Any mechanical separation process, such as filtration and sedimentation, would result in significant removal from the aqueous phase to the settleable or fixed biomass and organic matter. The four generally recognised main removal pathways for organic compounds in the wastewater treatment process are:

- 1) Aerobic and anaerobic biodegradation;
- 2) Chemical degradation (abiotic);
- 3) Adsorption onto suspended solids or biofilm or association with oils and fats;
- 4) Volatilisation.

These different main pathways can strongly influence each other under specific conditions related to the kind of wastewater treatment applied. For example, partitioning to the solid phase, like a fixed biofilm growing over a filling media surface, can enhance the likelihood of reductive processes by anaerobic bacteria, often very effective for the degradation of complex organic compounds, much more than the aerobic processes. When using a natural treatment system, like reed beds, due to the high efficiency of such systems for "Total Suspended Solids" removal by sedimentation and filtration, and also for the elevated biofilm binding capacity towards organic substances contained in the incoming wastewater, three of the four removal pathways are strongly enhanced.

Reed beds can act as a trap for the bioresistant organic molecules, permitting to the very slow biological and chemical degradation pathways to develop on the long run. Furthermore, this kind of natural treatment considerably reduces the sludge production (only some primary sludges), thus minimising their disposal related problems if contaminated with EDCs. So, depending on the way the wastewater has been treated, the chemical risk correlated with irrigation/reuse applications can be considered as negligible or to be further evaluated. The general advice is to analyse the organic micropollutants set that is present in the effluents before to plan their reuse, in order to select the most appropriate irrigation method keeping in mind also the chemical long-term risk. It's anyway to be highlighted that usually the micropollutants concentrations are so low that the quantity uptaken by the crops after irrigation and soil adsorption are negligible.

Anyway, the best practice we can observe is probably to prevent potentially harmful substances from entering the wastewater cycle (see sludge experiences in Denmark, Cologne/Germany ...). As an important evidence and achieved result within SWAMP project, it has been proved that the domestic wastewater treatment by

RBTS (or extensive treatments in general, with a high hydraulic retention time and a large variety of removal pathways) seems to be very effective in trapping these substances, preventing their diffusion by a further reuse of the effluents [Masi et al., 2004].

Hygienic risks and new common regulation proposal

Hygienic risk depends strictly on the irrigation method. In the newest WHO guidelines draft for the reuse of treated wastewater there are some categories for the different kind of reuse.

"The applications listed in category III (restricted irrigation) exclude direct contact of humans and animals with reclaimed water (at the exception of incidental contacts with workers). Crops cultivated for the canning industry will be disinfected in the canning process. No direct grazing of green fodder will be allowed. Other crops, cereals, fibre, industrials, seeds, dry fodder,..., are harvested a long time after the irrigation has ceased. Therefore health related risks are considerably reduced. It is proposed not to include any bacterial limit for restricted irrigation. Essential eventual health risks are not related to crop consumption but to workers and neighbours contamination in case of sprinkler irrigation. Therefore, in case of sprinkler irrigation, setback distances between irrigation sites and residential areas, roadways, sports fields, ... must be established. This measure is preferred to setting a bacterial limit of 10^5 FC/100 ml as suggested by Blumenthal et al. (2000), though such a quality would be reached after the minimum treatment required to meet the SS guideline limit. Including a distinction between sprinkler irrigation and flood and furrow irrigation, with a limit of 10^3 FC/100 ml for the latter does not seem relevant. Wherever frequent contact of children or workers with wastewater is observed and cannot be avoided, such a limit should be set and enforced. A water category IV is proposed when the combination of the irrigation technique and the agricultural practice results in very low microbiological health risks. The applications include:

- *irrigation and cultivation practices, which guarantee the absence of contact of vegetables and fruits with wastewater and the absence of aerosols and run off ;*
- *irrigation with techniques able to prevent aerosols and run off of crops listed in category III and of green areas where the public has no access;*
- *irrigation of green areas open to the public and sports fields, which guarantees the absence of contact of the public with the irrigation water.*

Given the very low level of health risks related to the applications listed in category IV, no microbial guideline is set." [Bahri et al., 2004].

There is a need to be very pragmatic about evaluation of risks with the aim to allow and encourage reuse (too strong rules are encouraging the already existing illegal reuse).

Advantages

The question is: are nutrients in wastewater a "pollution" or a "resource"? If they are a pollution, they must be removed, which involves costs. If nutrients in wastewater can be reused in agriculture, this allows to achieve the following targets:

- reduce industrial production and mining of fertiliser and making use of readily available fertiliser at no extra cost
- reduce release of nutrients into receiving water bodies, preventing their eutrophication
- reduce treatment costs through intelligently designed systems, especially including segregation of streams.

This is of particular interest for remote tourism sites, which are often combined with or in the vicinity of a farm, where the agricultural area is available and fertiliser is needed. Simultaneously or in addition to the reuse of nutrients, depending

on the system chosen, water is made available for agriculture. This may not be of particular interest in wet climates but in dry countries or on very light soils water is becoming an increasingly sensitive issue. Mobilising new water resources in dry countries may not only be a question of economic survival for a resort but of survival at all.

References

Amlinger, F. et al (2002) editor

Fachliche Grundlagen zur Stickstoffbewertung der Kompostdüngung

ÖWAV-Fachgrundlage, ÖWAVVienna

Bahri, A.; Brissaud, F. (2004)

Setting Up Microbiological Water Reuse Guidelines For The Mediterranean

Report prepared for the WHO/EURO Project Office and the Mediterranean Action Plan

http://www.med-reunet.com/docs_upload/bahri_and_brissaud.pdf

Blumenthal, U. J.; Mara, D. D.; Peasey, A.; Ruiz-Palacios, G. and Scott, R. (2000)

Guidelines for the microbiological quality of treated wastewater used in agriculture: recommendations for revising WHO guidelines

Bulletin of the WHO 78 (9), 1104-1116.

Kimball, J. (2005)

Kimball's Biology Pages

Webpage <http://biology-pages.info>, 2005

Mara, D. (1989)

Guidelines for the safe use of wastewater and excreta in agriculture and aquaculture

World Health Organisation

Masi, F.; Conte, G.; Lepri, L.; Martellini, T.; Del Bubba, M.

Endocrine Disrupting Chemicals (EDCs) and Pathogens removal in an Hybrid CW System for a Tourist Facility Wastewater Treatment and Reuse

Proceedings of the IWA 8th International Conference on Wetland Systems for Water Pollution Control Avignon (France), 461-469, 2004

Niemczynowicz, J. (1997)

The Water Profession and Agenda 21

Water Quality International, March/April: 9-11

World Health Organization (1989)

Health guidelines for the use of wastewater in agriculture and aquaculture

Tech. Bull. Ser. 77, WHO, Geneva, Switzerland

Section 3

IMPLEMENTATION

The following two chapters consist of

- a step by step description of the activities to be carried during the project implementation phase and
- a decision tree assisting in the choice of sustainable measures suitable to a certain set of conditions.

This should assist the owner and the engineer to go beyond the standard solutions and follow a process leading to a sustainable water and wastewater system.

3.1 Step by step procedure: design of a water management scheme

These steps describe measures suggested in addition to the standard procedures required by local regulations for the design of a water or wastewater system in order to achieve sustainability.

Step 1 Auditing of tourism facility

With the help of a questionnaire (see in ANNEX) information is given by the owner of the tourism facility on:

Type of facility: Purpose and seasonality, accommodation,

- local characteristics
- number of hot meals served per day
- number of beds
- permanent staff
- existing sanitary devices
- average water consumption (maximum, average, season)
- type of existing water devices (taps, showerheads, toilets, washing machines)
- legal requirements and restrictions are checked

For further calculations the needs of the main season will be considered (maximum water consumption and purification needs).

Step 2 Determination of SWM measures

Based on the information on existing infrastructure the potential of measures is evaluated.

- Potential and advantages of reduction of the water consumption
- Possibilities of separate collection of wastewater fractions (grey and black water and urine) and decentralised treatment
- Possible reuse of treated wastewater (for toilet flushing, irrigation)
- Possible reuse of nutrients (as fertiliser in gardening, agriculture)

For determination of the potential measures use the decision tree (chapter 3.8).

All the measures have to consider the seasonality and fluctuation of water consumption and wastewater production typical of the tourism facility. They also have to consider the legal requirements for reuse, treatment and discharge of wastewater

Step 3 Water saving potential

In the discussion with the owner of the tourism facility the economical aspects of the possible watersaving measures have to be discussed:

- Costs of water (drinking water quality from the tap, price per m³, availability), how much money can be saved by economising in water consumption or with reuse?
- Costs of wastewater, wastewater treatment
- Continuity of water supply (are there periods of supply deficiencies?)
- Energy and money savings through reduction of water consumption (less warm water, less waste water to treat)

Step 4 Water saving devices

Advise the tourism facility owner on procurement and implementation costs (compare with savings)

- How and where can I get water saving devices?
- How much do I have to invest?

Step 5 Water quality requirements for reuse

Examine water system with respect to minimum water quality required for different purposes.

Possible water qualities are

- potable water
- treated grey water
- treated waste water
- rain water

Possible uses for non potable water are

- laundry
- toilet flushing
- cleaning
- outside cleaning
- landscaping and crop irrigation

Step 6 Wastewater reuse potential and techniques

The importance of the reuse of clean (treated) wastewater depends on the individual situation of the tourism facility.

- Water scarcity (is the reuse desired/economical/not acceptable)
- Nutrient reuse (replacement of artificial fertilisers)
- Wastewater treatment costs (change of quantity and quality of wastewater)
- Legal requirements, both for reuse and discharge

Step 7 Rain water potential

In addition to the reuse of treated wastewater the potential for use of rainwater is examined. Check

Rain water availability

Possible uses for rain water

Develop variants comprising rain water system

Step 8 Cost estimate for variants

Variants of water supply and wastewater treatment are compared economically and discussed with the owner, respecting the values of sustainability:

- Water saving potential economically
- Effects of reduction of wastewater quantity for costs of wastewater treatment
- Profit from water and nutrient reuse
- Lifetime costs

Step 9 Discussion of water saving and wastewater reuse variants with owner

The advantages and disadvantages of suggested SWM measures are discussed with the owner of the tourism facility who decides on the realisation, regarding legal requirements, both for reuse and discharge.

Step 10 Detailed design of system

- Refer to Section 2 for detailed description of techniques to be implemented.
- Regular communication with facility owner is important.

Step 11 Implementation of system**Step 12 Training for operation and maintenance, submission of documentation**

- Operation and maintenance manual
- Awareness raising material

3.2 Decision tree

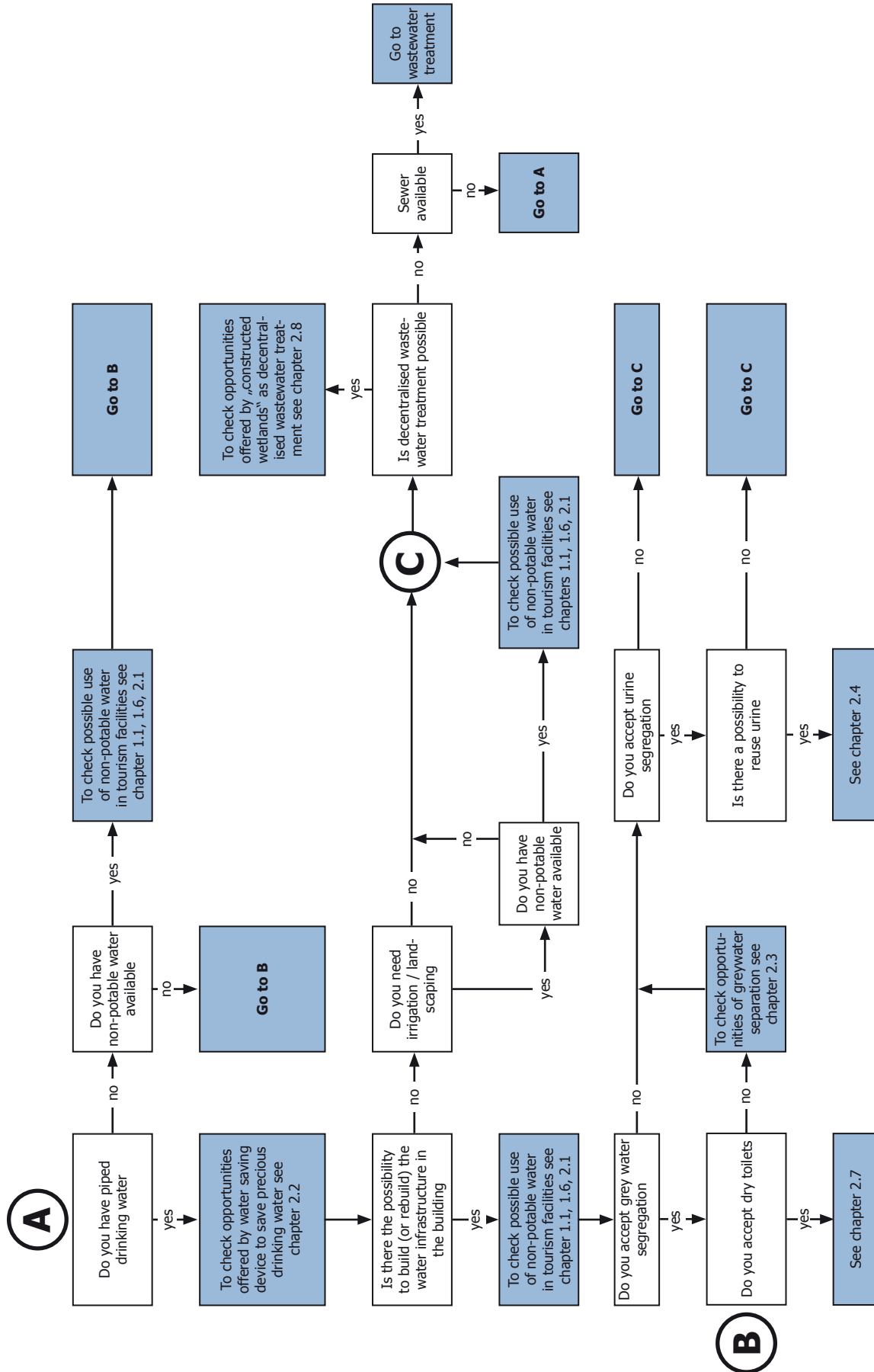

Section 4

ANNEX

Sample texts and examples of measures

1. Towel text

Dear Guest!

Did you imagine that tons of towels are needlessly washed every day all over the world. This consumes huge amounts of washing powder and pollutes our waters.

Decide yourself.

Your towel on the floor or in the bath tub/shower means you want it to be changed.

Your towel on the rack means you are using it again.

The environment is thanking you.

2. The Mélia Sevilla, Spain, to cite an example, has a sticker next to each wash-basin with a funny drawing of a tap and the following text: "Help us save water" (Ayuda ahorrar agua).

3. Sample text for an information leaflet (see also leaflet sample attached)

This hotel (inn ..., use appropriate designation) treats wastewater as a resource. ... Describe the system in simple words ... Thus every guest helps us save x l water every day and keep the environment clean. We reuse our composted organic matter as fertiliser in our flower beds.

Advantages for the hotel

- cost-effective wastewater treatment,
- low water consumption with high comfort for guests,
- a reliable sanitation
- an enhanced landscape and environment (e. g. in the case of a constructed wetland)
- and thus fulfilment of key criteria for a sustainable tourism.

Information for guests

You can assist this hotel in reaching its target to keep the environment clean and to save precious drinking water. Very simple measures, which do not demand a high effort from your side will save up to 40 l per day. If you keep doing the same things at home you may save 70 Euro per person and year from your water bill (choose applicable texts).

- Keep the taps closed while you don't need the water, e. g. when you brush your teeth,
- Read the instruction for towels in the bathroom and help us save water and detergents
- If you feel cold, use our sauna or come to the cosy living room. Do not warm up under the shower.
- All our toilets have stop buttons to interrupt the flushing. Push the stop button once you feel the toilet is clean.

4. Solid wastes

Clients must be informed that certain solid wastes do not belong into the toilet and a comfortable alternative for disposal of these items must be provided for. Have containers (e. g. specially marked bags) for sanitary products, e.g. sanitary towels, panty liners, tampons, condoms ... at the bathroom and a dust bin with a lid. Make your clients aware of the opportunity, with a sticker on the wall, with the right label on the articles ...

5. Chemicals

Household chemicals for dishwashing, washing and cleaning have a great impact on wastewater. You can reduce your footprint on the environment and make water more easily reusable with a few simple measures, without any investment in infrastructure.

- Choose the right detergents and cleaning products. You can reduce the phosphorus output by selecting appropriate, phosphorus-less washing powders and detergents for you dishwasher.
- Avoid toxic substances in the wastewater from disinfectants in cleaning products. These are needless additives to household cleaning products. They do not lead to germfree surfaces but have very negative effects on wastewater treatment plants and the environment. Clean your toilets, bathroom and kitchen with an all-purpose cleaner.
- Do not use toxic urinal blocks or screens, rim hangers and other deodorants. Best is not to use any such products at all. Keep your restrooms clean and use waterless urinals (no uric acid salts and limescale formation) instead. For information about products consult www.swamp-eu.org/cat.
- Do not use chemical drain openers.

6. Use alternative base cleaning

Save cleaning costs with dust-trap zones

- Install a textile dirt-trap zone to supplement conventional scrapers in metal or rubber and the familiar coir doormats in your entrance, allies, in front of the elevator.
- Textile dirt-trap zones prolong the intervals between thorough cleaning. Daily care and routine cleaning of a carpet is also made easier as a result of the lower uptake of dirt. Installing a dirt-trap zone of adequate length thus pays for itself within a short time and in the long term appreciably reduces routine and thorough cleaning needs. It must also be taken into account that the useful life of the textile floor covering is thereby extended
- Dirt-trap floor coverings are designed in terms of construction and colour to be capable temporarily – until they are next cleaned by suction/brush machine – of retaining relatively high amounts of dirt without appearing dirty. In rainy weather they keep moisture away from the adjacent floor covering. The incorporation of a textile dirt-trap zone is ultimately a necessary auxiliary measure for all textile floor covering installations in the contract sector and is also very useful in the domestic sector
- Have sufficient coat racks
- Provide clean surfaces outside, e. g. pavements, gravel walks ...

- Consider using water saving shower heads, as here in this inn?
- Fix your dripping water taps as fast as possible, you save up to 500 l/d?
- Water your garden with rain water.
- Low-volume aerators or water-savings diaphragms can be fitted into existing faucets.

Concept Fischerhof

Water saving:

To reduce water consumption water saving faucets and shower heads are installed. New water efficient washing machines further save water. Urinals have been equipped with water and energy saving control valves. One of the urinals is a waterless type, which the owner and personnel agreed to test.

Grey water collection:

It was not possible to implement a general grey water system. One part of the newly erected sanatorium has a separate greywater collection. The collected greywater is monitored by SWAMP and will add to the experience with this type of technique.

Natural wastewater treatment:

After a three chamber septic tank the wastewater is stored in a buffer tank, which allowed to reduce the size of the following treatment stage because weekend peaks are levelled out over the following week. From the buffer tank the wastewater is fed to 6 vertical flow reed beds in 3 to 4 batches per day.

The treatment plant is the largest of this type in Austria (2004).

The treated wastewater is released into the Gurk river. A planned storage pond, which would allow reuse of the treated wastewater for irrigation of meadows is yet to be implemented.

The sludge from the pretreatment is composted in a special reed bed on site.

Design

AEE INTEC
Feldgasse 19
A-8200 Gleisdorf
03112 5886-0
m.regelsberger@aee.at
www.aee.at

SWAMP partners

- Ökologisches Projekt GmbH, Graz/Austria
- Ambiente Italia srl, Mailand/Italy
- IRIDRA srl, Florence/Italy
- AWA Ingenieure, Uelzen/Germany
- target GmbH, Hannover/Germany
- Carl Bro Latvia, Riga/Latvia
- Sia Aprite, Cesis/Latvia
- Water Management Institute, Kedainiai/Lithuania

Funding

bm:bwk



KOMMUNAL
K R E D I T



SUSTAINABLE WATER MANAGEMENT
AND WASTEWATER PURIFICATION
IN TOURISM FACILITIES

www.swamp-eu.org

Sustainable water
management at Fischerhof
inn and sanatorium

Gasthof
Fischerhof



SWAMP is a project under the Energy, Environment and Sustainable Development Programme of the 5th Framework Programme of the European Commission's Directorate General for Research.

SWAMP develops economic and reliable wastewater treatment processes for tourism sites without connection to a sewer mains. These include:

- Water saving to reduce wastewater flow,
- Separate collection of greywater (from bath and kitchen) and blackwater (from the toilet),
- Treatment of wastewater with constructed wetlands,
- Reuse of treated wastewater or greywater. This allows to further save valuable drinking water.

Constructed wetlands have the following advantages:

- simple operation,
- low or no energy demand and low operation cost,
- high tolerance towards fluctuations of guest numbers,
- simple structures, without complicated electro-mechanical equipment,
- high treatment efficiency, including for micro-organisms,
- good integration into landscape and environmentally friendly.

Sustainable water management concepts are developed and tested on 16 concrete examples in 5 European countries (Austria, Germany, Italy, Latvia and Lithuania) and monitored throughout the project duration.

The main innovation of **SWAMP** is to treat wastewater as a resource. The separate collection of different components, as is widely accepted with solid wastes, offers new possibilities concerning treatment and reuse of water and nutrients. Blackwater, greywater and urine can be collected, treated and reused separately. Greywater treated in a constructed wetland easily reaches bathing water quality and can be reused for toilet flushing. This allows each guest to save 40 l of potable water every day. SWAMP implements such examples and tests them.



Plant after beginning of construction

Owner's advantages

The innkeeper has several advantages from solutions offered by SWAMP:

- cost efficient wastewater treatment,
- low maintenance,
- low water consumption without loss of comfort for guests,
- a reliable wastewater treatment,
- well integrated into the landscape,
- and corresponding to the criteria of a soft tourism

For the guest

The wastewater at Fischerhof is treated in an environmentally friendly constructed wetland. The owner and all users thus contribute to the protection of our valuable water resources.

Here and at home you can further contribute to a comprehensive protection of our waters. Simple measures can save you 30 to 40 l of water per person daily. With Austrian water prices and five persons in a household this is equivalent to up to 350 Euro per year.

- Has your flushing cistern a stop or double button?
- Mind the water demand when buying new household appliances?

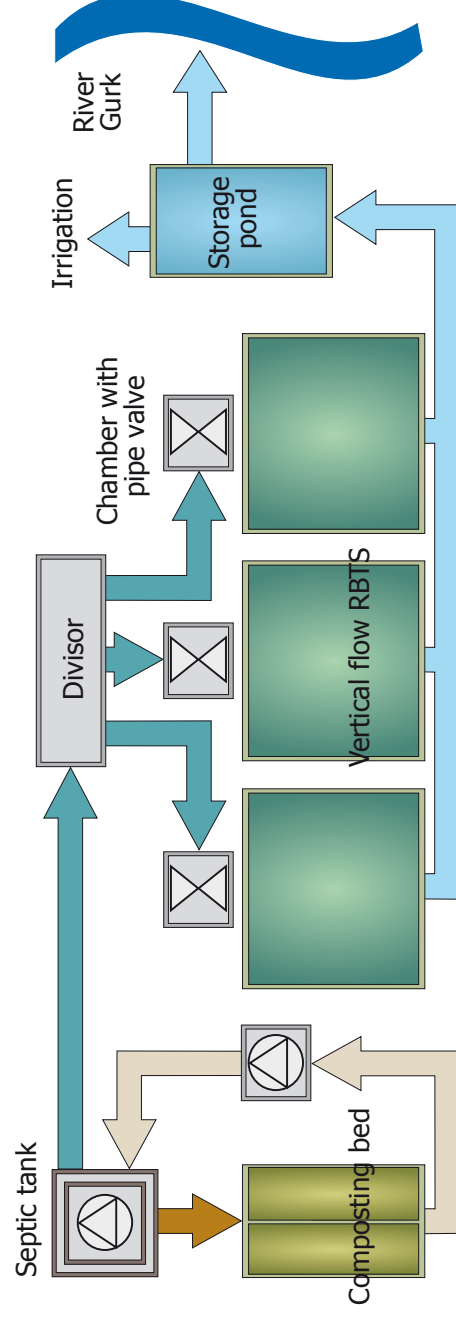

Information and awareness raising through environmental management tools: the EU Ecolabel and EMS (Environmental Management Systems)

Most of the examples described above could be included in a wider action involving the overall environmental management of the company. If the tourism company decides to implement an environmental management system, according either to the international ISO 14001 scheme or to the European EMAS scheme (EU Regulation n. 761/2001), an environmental policy and an environmental improvement program with measurable objectives and targets will have to be adopted, involving all relevant environmental aspects of the activity.

Therefore the above initiatives related to information and awareness raising of clients and personnel could be integrated in the environmental program and improvement targets. Moreover, environmental management systems require the company to inform and involve all stakeholders; external and internal information is particularly important in the EMAS scheme, requiring the definition of an environmental statement. However, EMS are in general very difficult to achieve for small and seasonal activities such as the majority of tourism companies; for this reason these tools are not very popular in this sector.

A more appropriate tool could be the application of an environmental label. Environmental labels provide a set of requirements (criteria) especially designed for a specific product or service. Products or services that are able to fulfil them obtain an "environmental excellence" award (the label) that can be used in marketing and communication. The official EU Ecolabel can be applied to tourism accommodation services since 2003 (Decision n. 287/2003). A new decision concerning the criteria for campsites will be issued in 2005. Both contain a set of mandatory and optional criteria also on water use. Below the mandatory and optional Ecolabel criteria for tourism accommodation concerning water are listed:

Mandatory criteria

Water

11. Water source

The accommodation shall declare to the water authority its willingness to switch to a different water source (e.g. mains water, surface water) if local water protection plan studies show evidence of a high environmental impact from using its current source of water. This criterion only applies if the tourist accommodation is not receiving its water from a mains water pipe.

Assessment and verification: The applicant shall provide a declaration as above, together with appropriate documentation including the results of local water protection plan studies (if any), an indication of any necessary action to be taken, and documentation of relevant actions taken.

12. Water flow from taps and showers

The water flow of the taps and showers shall not exceed 12 litres/minute.

Assessment and verification: The applicant shall provide a declaration of compliance with this criterion, together with an explanation as to how the accommodation fulfils the criterion, and relevant documentation as appropriate.

13. Water saving in the bathroom and toilets

In the bathroom and toilets there shall be adequate information to the guest on how to help the accommodation save water.

Assessment and verification: The applicant shall provide a declaration of compliance with this criterion, together with relevant information to guest.

14. Waste bins in toilets

Each toilet shall have an appropriate waste bin and the guest shall be invited to use the waste bin instead of the toilet for appropriate waste.

Assessment and verification: The applicant shall provide a declaration of compliance with this criterion, together with an indication of the information to the guest.

15. Urinal flushing

Urinals shall have an automatic or manual flush such that no more than five urinals shall be flushed together.

Assessment and verification: The applicant shall provide a declaration of compliance with this criterion, together with relevant documentation on the urinals installed.

16. Leaks

Staff shall be trained to check every day for visible leaks and to take appropriate action as necessary. The guest shall be invited to inform the staff of any leaks.

Assessment and verification: The applicant shall provide a declaration of compliance with this criterion, together with relevant documentation on the topics covered in the training, and a copy of the information addressed to the guests.

17. Changing towels and sheets

The guest shall be informed of the environmental policy of the tourist accommodation whereby sheets and towels shall be changed either at his or her request, or by default once a week for lower class accommodation, and twice a week for higher class accommodation.

Assessment and verification: The applicant shall provide a declaration of compliance with this criterion, together with relevant documentation showing how the guest is informed.

18. Watering plants and gardens

Flowers and gardens shall normally be watered before high sun or after sunset, where regional or climatic conditions make it appropriate.

Assessment and verification: The applicant shall provide a declaration of compliance with this criterion.

19. Waste water treatment

All waste water shall be treated. If no link is possible to the local sewage treatment plant, the tourist accommodation shall have its own treatment system that meets the requirements of relevant local, national or European legislation.

Assessment and verification: The applicant shall provide a declaration of compliance with this criterion, together with documentation on the connection to the local sewage treatment plant or on its own waste water treatment system as appropriate.

20. Waste water plan

The accommodation shall ask the local administration for its waste water plan and if there is one will follow it.

Assessment and verification: The applicant shall provide the letter to the local waste water management requesting the local waste water design plan and the reply received. If there is a plan, the applicant shall provide documentation on the steps taken to follow it.

Optional criteria

55. Use of rainwater (1.5 points) and recycled water (1.5 points)

(a) (1.5 points): Rainwater shall be collected and used for non-sanitary and non-drinking purposes.

Assessment and verification: The applicant shall provide a detailed explanation of how the accommodation fulfils this criterion, together with appropriate supporting documentation, and appropriate assurances that the sanitary and drinking water supply is kept entirely separate.

(b) (1.5 points): Recycled water shall be collected and used for non-sanitary and non-drinking purposes.

Assessment and verification: The applicant shall provide a detailed explanation of how the accommodation fulfils this criterion, together with appropriate supporting documentation and appropriate assurances that the sanitary and drinking water supply is kept entirely separate.

56. Water flow from taps and shower heads (1.5 points)

The average flow from all taps and shower heads excluding bath taps shall not exceed 8.5 litres/minute.

Assessment and verification: The applicant shall provide a detailed explanation of how the accommodation fulfils this criterion, together with appropriate supporting documentation.

57. WC flushing (1.5 points)

At least 80 % of WCs shall consume six litres per flush or less.

Assessment and verification: The applicant shall provide a detailed explanation of how the accommodation fulfils this criterion, together with appropriate supporting documentation.

58. Dishwasher water consumption (1 point)

The water consumption of the dishwashers (expressed as W (measured)) shall be lower or equal to the threshold as defined in the equation below using the same test method EN 50242 and programme cycle as chosen for Commission Directive 97/17/EC:

$$W_{(\text{measured})} = (0.625 \times S) + 9.25,$$

where:

$W_{(\text{measured})}$ = the measured water consumption of the dishwasher in litres per cycle, expressed to the first decimal,

S = the applicable number of standard place settings of the dishwasher.

Assessment and verification: The applicant shall provide a technical report from the professional technicians responsible for the manufacture, sale or maintenance of the dishwashers or evidence that the dishwashers have been awarded the Community eco-label.

59. Washing machine water consumption (1 point)

The washing machines used by the accommodation or by its laundry service provider shall use 12 litres of water or less per kg of wash-load measured according to EN 60456:1999, using the same standard 60 °C cotton cycle as chosen for Directive 95/12/EC.

Assessment and verification: The applicant shall provide a technical report from the professional technicians responsible for the manufacture, sale or maintenance of the washing machines or evidence that the washing machines have been awarded the Community eco-label. The accommodation structure shall provide technical

documentation from its laundry service provider that their washing machine complies with the criterion.

60. Tap water temperature and flow (1 point)

At least 80% of taps shall allow a precise and prompt regulation of the water temperature and of the water flow.

Assessment and verification: The applicant shall provide a detailed explanation of how the accommodation fulfils this criterion, together with appropriate supporting documentation.

61. Shower timers (1 point)

Showers in kitchens or outdoors shall have a system to stop the flow of water automatically after a certain time or if not in use.

Assessment and verification: The applicant shall provide a detailed explanation of how the accommodation fulfils this criterion, together with appropriate supporting documentation.

Questionnaire for tourism facilities

No.		
1	General information	
1.1	Name of object*	
1.2	Owner*	
1.2.1	Contact person*	
1.2.2	Address*	
1.2.3	Telephone/fax/e-mail*	
1.3	Tenant/leaseholder*	
1.3.1	Contact person*	
1.3.2	Address*	
1.3.3	Telephone/fax/e-mail*	
1.4	Municipality in charge: Name and number of inhabitants	
1.5	Administrative region	
1.6	Tourism region	
1.7	Nature reserve/protection area	

2	Landscape	
2.1	Architecture plain/hilly/mountainous	
2.2	Altitude above sea level [m] of the facility	
2.3	Average temperature [°C] Year/January/July/tourism season	
2.4	Average precipitation [mm] Year/10–4/5–9 or monthly	
2.5	Main use [%] of landscape: Agriculture/ forestry/tourism/ settlement/...	

3	Neighbourhood	
3.1	Area use around the facility, describe clockwise	
3.2	Soil: Stone/sand/loamy sand/ sandy loam/clay/swamp	
3.3	Groundwater level [m] below surface.	

3.4	Main natural growing plants, esp. trees	
3.5	Next running water: Name/distance [m]/average low water flow/water quality	
3.6	Another running water: Name/distance [m]/average low water flow/water quality	
3.7	Lake, near by: Name/distance [m]/area [m ²]/depth [m]/quality/use	

4	Traffic connections	
4.1	Local road/main road/railway: Distances [m]	
4.2	Next large city (> 100,000 inh.) Name/distance [km]	
4.3	Next gravel pit: Distance [km] Price [€] for 1 m ³ gravel 8/16	
4.4	Next sand pit: Distance [km] Price [€] for 1 m ³ sand 0/2	
4.5	Transportation price [€] for 20 tons/km	

5	Labour	
5.1	Plumber hour [€]	
5.2	Unskilled labour hour [€]	
5.3	Excavator hour [€]	
5.4	National value added tax (VAT) in %	

6	Locality	
6.1	Real estate [m ²]	
6.2	How many occupied buildings for guests and for private/other use?	
6.2.1	Used living area for guests [m ²]	
6.3	Tourism activities	
6.3.1	How many places for tents and/or caravans?	

6.3.2	Special events a year: specify	
6.4	Opening time: Which months a year/main season: specify	
6.5	Accommodation	
6.5.1	Number of simple bedrooms	
6.5.2	Number of bedrooms with showers or baths	
6.5.3	Total beds	
6.5.3.1	Bed linen will be washed at premise or by laundry service?	
6.5.4	Total showers	
6.5.4.1	Total baths	
6.5.6	Total toilets	
6.5.6.1	Kind of toilets:specify if different kinds; How many litres for one flush?	
6.5.7	Total wash-basins	
6.5.8	Overnight stays: Year/season/maximum per day/average in every of the last three years	
6.5.9	Price [€] for bed and breakfast*	
6.6	Restaurant or kitchen	
6.6.1	Opening time: days a week/ hours a day	
6.6.2	Average staff number a week	
6.6.3	Average number of visitors a day	
6.6.4	How many chairs	
6.6.5	How many warm meals: average per week/maximum per day/ tendency the last three years	
6.6.6	Dish washer/type or age	
6.6.7	Washing-machine/type or age	
6.6.8	Grease trap installed	
6.6.9	Kind and number of urinals	
6.7	Other activities	
6.7.1	Number of permanent inhabit- ants	

6.7.2	Domestic animals, specify number of heads and kind	
6.7.3	Farming, specify area and crops	
6.7.4	Gardening, specify area and crops	
6.7.5	Forestry (ha and type of trees)	

7	Water supply/consumption	
7.1	Supplier: Name and address Telephone/e-mail	
7.2	Self or partly self-sufficiency: What kind, distance, flow, and depth if it is a well? [m]	
7.3	Shortages of water: How many days a year/five years?	
7.4	Water price [€] for 1 m ³ or flat rate?	
7.4.1	If own water, cost per year? [€]	
7.4.2	Water price [€] for 1 m ³ in the municipality nearby?	
7.5	Piping material in the building	
7.6	Tap water quality: [mg/l] Total hardness/ nitrate/phosphorus/iron	
7.7	Total water consumption in every of the last three years [m ³]	
7.8	Water consumption for special purposes (watering grass or cattle, etc.) [m ³] in the last three years	
7.9	Water pressure [bar]	

8	Energy	
8.1	Kind of energy for water and space heating	
8.2	Total electricity consumption [kWh] in every of the last three years	
8.2.1	Electricity consumption [kWh] for water supply per year?	

8.2.2	Electricity consumption [kWh] for sanitation devices (specify) per year?	
8.2.3	Electricity consumption [kWh] for wastewater discharge per year?	
8.3	Total gas consumption [kWh] in every of the last three years	
8.4	Total oil consumption [litre] in every of the last three years	
8.5	Electricity price [€/kWh]	
8.6	Gas price [€/kWh]	

9	Wastewater discharge	
9.1	Material and diameter of sewers	
9.2	Is it easy to separate grey from black water in the buildings?	
9.3	Installed treatment devices, specify	
9.3.1	Septic tank, volume [m ³]	
9.3.2	Imhoff tank, type and sedimentation volume [m ³]	
9.4	Recipient of the sludge	
9.5	Recipient of the wastewater: Name of the receiving water	
9.6	Recipient of the rainwater from the roofs	
9.7	Material of the gutters	
9.8	Recipient of the storm water from the yard and the streets	
9.9	Municipal WWTP: Name, distance [km], technology and capacity	
9.9.1	Distance (km) to the next sewer	
9.9.2	Price [€] for 1 m ³ of sewage?	

10	Refuse	
10.1	Refuse disposal service Name and address	
10.2	On site separating technology: Installed/suggested/specify	
10.3	Organic domestic waste [kg] or [m ³ /week]	
10.3.1	Use of kitchen refuse	
10.4	Composting sites available/already installed	

11	Legal framework	
11.1	Catchment (river basin) area and responsible authority	
11.2	Responsible water authority for giving permissions, name and address	
11.3	Responsible water authority for monitoring, name and address	
11.4	Requirements for discharging treated wastewater till 50 pe	
11.5	Requirements for discharging treated wastewater till 2,000 pe	
11.6	Special requirements for reclama- tion of treated wastewater	
11.7	Special requirements for infiltra- tion of treated wastewater into the ground	

Note:

- All given prices should take into consideration national VAT.
- Questions marked with * will not be published or will be made anonymous.
- pe = person equivalent (i. e. 60 g BOD₅/d)
- If available give more or detailed information, also on an additional page.

ISBN 3-901425-99-3