

VIETNAM
Case Study 1: Vinasanres Ecosan Toilets Demonstration in Cam Duc Commune, Cam Ranh District

<p>Project Owner(s) Project Partner(s) Primary Contacts <i>Partner</i></p>	<ul style="list-style-type: none"> ▪ Cam Duc Commune ▪ Swedish International Development Cooperation Agency (SIDA) ▪ Pasteur Institute in Nha Trang <ul style="list-style-type: none"> ▪ SIDA; e-mail: sida@sida.se ▪ Dr. Paul Calvert, Ph. D; email: pcalvert@umassd.edu
--	--



Introduction

This case study describes how the Vinasares Ecosan toilets were appraised in Cam Duc Commune, Canh Ran District, Vietnam which was funded by the Swedish International Development Cooperation Agency (SIDA) and the Pasteur Institute in Nha Trang.¹

Background

Ecological sanitation has long been in use in a number of countries around the world, like in China, Mexico and Sweden and has been widely accepted over the past 25 years. One classic example of this kind of system is the Vietnamese double-vault toilet and it is widely used in northern Vietnam.

Objectives

The purpose of the Vinasanres project was to develop new and/or improved sanitation systems for Vietnam and to promote South-South cooperation in the field of non-conventional sanitation. The project originally aimed to increase the status of dry sanitation systems like the traditional double-vault toilet by developing types that could be attached to the house or even placed inside the house. The project took off in 1996 until end of 1998.

¹ Calvert, Paul, et. al., Appraisal of the Vinasanres Ecosan Toilet Demonstration Project. Nha Trang, Vietnam. October 2000.

Beneficiaries

The initial trial of the ecosan toilets was done in the Cam Duc Commune, Can Ranh District, Khanh Hoa Province, about 30 km south of Nha Trang. The commune was comprised of 9,440 residents and 1,831 households. The residents in the project area had neither pit toilets nor pourflush toilets since the commune had always been vulnerable to the risk of groundwater pollution. Farming was the main source of livelihood and each household owned a house that stands on a 300-600 sq.m plot. The source of water of the residents were their open wells (52% of the households own a well that is 5-15 meters deep). The majority also harvested rainwater for their water source. The rest got their water from their neighbors. There was no piped water supply in the commune, so many of the households only depend on shallow wells for the source of their drinking water. But the pressing issue was that the commune's water sources are mostly contaminated by feces because of the open defecation practice. About one third of households (30%) have a "hygienic" toilet (hygienic means pour-flush, septic tank or double vault in good condition), two thirds (65%) have a simple, shallow pit toilet and the rest (5%) have no toilet at all.

Sanitation Technology / System

The development of the Vinasanres toilets seemed to be competitive with the alternatives that were made available in Cam Duc. The current cost of a basic Vinasanres toilet was around 1.03 million Vietnamese Dong [VND] (US\$83) and a tiled one with Chinese squat pan, or similar was about 1.32 million VND (US\$67.71). In comparison, a septic tank model would cost around 2 million VND (US\$102.59) and a Twin Pit Pour Flush toilet would also cost around the same as the Vinasanres toilet of similar quality. Noting the discrepancy on the cost, it was pretty obvious that the simple pit and basic vault toilets were cheaper than the said models above. The only negative factor to the cheaper toilets was that they were not hygienic and the people of Cam Duc had been progressively seeking for even something better for the improvement of their sanitation.

The project also offered six types of toilets and these six different models of Vinasanres toilet were initially tested in order to determine the storage time necessary in order to make the dried feces safe for reuse as fertilizer in agriculture.

Reuse Component and Other Features

After the results of the initial test, the dried feces was found to be useful as fertilizer and being sought after by the farmers. The people in the Commune became aware of the reuse value of the dried feces that some of them even pay in cash or in kind just to have the supply of dried feces. Most of the treated feces had been used on cassava fields which was the principal crop of the commune.

Urine reuse also became common to the people of the commune although the awareness of its economic value was not yet intensely achieved. Some people just added the urine to their manure or composting heaps. Other people diluted it, used it on mango trees and mixed it with animal manure. The urine was also use on flowering plants, vegetables, coconut and cashew. The people were generally happy with the results.

Partners

The project had been carried out in cooperation with the Ministry of Health and the Nha Trang Pasteur Institute with the support from the Swedish International Development Cooperation Agency (SIDA) through the Sanres programme in October 2000.

Sanres is an international research and development programme funded by Sida (the Swedish International Development Cooperation Agency). Current activities in Vietnam include support to pilot projects on sanitation as well as workshops, conferences and training courses.²

The Swedish International Development Cooperation Agency (SIDA), is a government agency under the Ministry for Foreign Affairs. The agency's main goal is to contribute to making it possible for the poor people to improve their living conditions. Sida works independently within the framework laid down by the Swedish Parliament and Government just like the other Swedish government agencies.

Impacts / Challenges

The project offered significant breakthrough on the protection of public health and protection of the environment. Also a significant development is the realization that the dried feces and the urine can actually improve the soil quality and a big savings on the cost of commercial fertilizer. The government and the people of Cam Duc had benefitted so much in their adoption of the ecological approach to sanitation. Such approach also provided the community significant savings in water supply and wastewater treatment in urban and peri-urban areas.

Based from the appraisal, it showed that Ecosan toilet has created interest from people, although others still favored septic tanks and pour-flush toilets. This is true in many other rural areas where the urine reuse and dried feces as fertilizers do not level with the commercial fertilizers that the people used in farming.

The result of the Cam Duc demonstration should be the stepping stone in the sanitation revolution which is already a hot commodity in other countries around the world.

References

- Calvert, Paul, *et al.* (2000). *Appraisal of the Vinsanres Ecosan Toilet Demonstration Project. Nha Trang, Vietnam.*
- Carlandar and Westrell. (1999). "A microbiological and sociological evaluation of urine-diverting double-vault latrines in CamDuc, Vietnam", *Minor Field Studies No.91*, Swedish University of Agricultural Sciences. December 1999.
- Winblad, Uno, *et al.* (2004). *Ecological Sanitation*. Revised and enlarged edition. Sweden: Stockholm Environment Institute.
- Winblad, *et al.* (1997). *Rapid Assessment of the Pilot Project in Cam Duc Commune, WKAB2Sml*. Sweden: Stockholm Environment Institute.

² Winblad, et. al., Rapid Assessment of the Pilot Project in Cam Duc Commune, WKAB2Sml. Stockholm. 1997)

VIETNAM

Case Study 2: Double Vault Composting Latrine Program in Northern Vietnam

Project Owner(s)	<ul style="list-style-type: none"> Households in the 3 communes (Chinh Ly, Don Xa and Yen Thanh) in Northern Vietnam
Project Partner(s)	<ul style="list-style-type: none"> Plan Vietnam Center for Rural Water Supply and Sanitation (CERWASSS2), Ha Nam, Vietnam
Primary Contacts <i>Partner</i>	<ul style="list-style-type: none"> Ben Cole and John Collet of Plan Vietnam; address: 10th Floor, Capital Building , 72 Tran Hung Dao, Hanoi, Vietnam; Tel: +844 3 8220 661



Introduction

This case study is based from the findings of Plan Vietnam from the investigation made by Ben Cole and John Collet in Ha Nam and Nam Dinh provinces in Vietnam in May and June 2007. The investigation basically tackles the perception and attitude of the people who have been using the double-vault composting (DVC) latrine. Based from studies conducted by the World Bank (WB) thru their Water and Sanitation Program (WSP), Vietnam is one of the countries in Southeast Asia faced with serious problems on sanitation. In a survey made by the Ministry of Health and UNICEF in 2007 in rural Vietnam, 25% of households had no latrine and 19% had an unhygienic latrine.

Background

To address the growing need of a proper sanitation, the Vietnam Government set a target of 2,600,000 constructed hygienic latrines by 2010. The government also set as hygienic options the double-vault composting latrine (DVC latrine), septic tank latrine, pour-flash water sealed latrine and ventilated pit latrine.

Although DVC has been quite popular among the Vietnamese and Chinese farmers because of the value and convenience that they can get from the fertilizer by-product, septic tank latrine still ranked the most popular and desired option. The DVC latrine only became known to the Vietnamese with its introduction in the 1950s and since then has been advocated as an appropriate sanitation facility throughout rural Vietnam.

Objectives

The objectives of the investigation were:

1. to assess DVC performance and user attitudes,
2. to identify any design or construction concerns, and
3. to make recommendations for remedial actions, if necessary.

Beneficiaries

Three communes¹ in Vietnam, namely: Chinh Ly, Don Xa and Yen Thanh comprising 120 households were assessed by Plan in their investigation. Interviews were also conducted with the Commune Health Workers, Women's Union staff, Commune People's Committee (CPC) staff, Plan staff and Plan volunteers, and household members in each of the three communes in order to grasp an understanding of the attitudes and perceptions of the Vietnamese towards DVC latrines.

Sanitation Technology / System

The introduction of the DVC latrine was openly accepted by a large number of households in Vietnam. And because of high rates of participation, Plan subsidized 700,000 Vietnamese Dong [VND] (US\$43) given to every participating household. It would then be assumed that the household will shoulder the rest of the amount from the total cost of constructing a typical DVC latrine ranging from 1,100,000 to 1,500,000 VND (US\$68.92).

Given the high value cost of the typical DVC latrine, Plan thought of inventing similar latrine but with low cost. Thus, the advent of the 'Granito', a locally manufactured and affordable DVC pan. The granito, a pre-molded pan made out of cement with a polished surface was collaboratively developed by Plan and Ha Nam's Center for Rural Water Supply and Sanitation (CERWASSS2).

The invention of the granito has helped the households saved on their latrine since the cost of one granito is only 70,000 VND (US \$4.30) as compared to the old pre-molded double pans which cost 165,000 VND (US \$10). Aside from the savings, the household's choice for the granito is the convenience and durability because it is easy to clean and less seepage of urine into the concrete causing lesser odors.



Figure 1: An example of an uninstalled Granito pan (Photo courtesy of PLAN Vietnam)

¹ Communes typically comprise 5-10 villages.



Figure 2: An example of an installed Granito pan with 2 covered defecation holes (Photo courtesy of PLAN Vietnam)

Partners

The Plan in Vietnam is responsible for the innovation of the DVC in partnership with Ha Nam's Center for Rural Water Supply and Sanitation (CERWASSS2).

Impacts / Challenges

The study found out that majority (97%) of the households regularly uses their DVC latrine and their latrines are maintained in a good condition. A good 91% of the correspondents also expressed their satisfaction with their DVC latrine. The one person responsible in cleaning the DVC latrine is mostly women. They are the ones to remove the contents from the vaults and empty the urine jar. Majority of the households immediately use the contents from the vaults to fertilize their crops. But some of them engaged in secondary composting of the excreta. The stored urine, on the other hand is used on their leafy crops and garden trees.

Looking at the technical aspect, the challenge is focused on the construction concerns, such as: 1) narrow and inappropriately located vent pipes; 2) absence of lids covering the defecation holes; 3) poor sealing of vault doors; and 4) uncovered urine collection jars. There are also other identified main causes of technical concerns such as the poor design of the latrine and the limited understanding of the builders on the principles of the DVC latrine construction.²

In response to the technical considerations, the study recommended four low-cost technical improvements as follows:

- 1) vent pipes should have a minimum diameter of 90mm;
- 2) simple locking systems should be installed for vault doors;
- 3) lids for defecation holes should be clearly identified to distinguish the *in-use* and *storage* vault; and
- 4) urine collection jars with lid should be part of the latrine 'package'. The NHPU Water and Sanitation Consultant stated the *Granito* could be improved by increasing its length for greater comfort of the users and less likelihood of urine splashing onto the concrete floor.³

² Cole, Ben, et.al. The sum is greater than the parts: An investigation of Plan in Vietnam's double-vault composting latrine program in northern Vietnam. March 2008. p.19

³ Id. p. 20

There should also be a review of the DVC latrine design since it is one area that is problematic. Construction of the DVC latrine is another area of importance and builders should be given prior training on its principles such as, understanding the importance of airflow over the compost pile to facilitate the aerobic composting process and to remove bad odors.

There is a challenge on the practice of the households using the DVC latrine. It should not be taken for granted that the DVC latrines need regular maintenance in order to properly function. Another area that would cause probable health risk is the early removal of the contents of the vaults. It was found out that farmers often remove the contents of their vaults not in accordance to the six-month storage time but according to their cropping patterns. It is recommended that there should be a review of the government guidelines for DVC latrine operation in Vietnam in order to clarify the needed guidance for proper DVC latrine operation.

Plan's DVC latrine program was generally well accepted by participating households. Through improvements and some technical modifications, the performance of these DVC latrines would significantly progress. A key challenge to scaling up this program will be changing the public's perception that DVC latrines are less hygienic than septic tank latrines. Improvements in DVC latrine construction and marketing approach could greatly enhance their appeal and ensure their continued (and renewed) popularity as perhaps the most ecologically sound and affordable household sanitation option currently available in many parts of Vietnam.⁴

References

- Cole, Ben, *et.al.* (2008). "The sum is greater than the parts: An investigation of Plan in Vietnam's double-vault composting latrine program in northern Vietnam". *Sharing Experiences*. A joint Publication of Water Aid Australia and International Water Center. p. 17-21
- Ministry of Health and UNICEF (2007). *Environmental Sanitation in Rural Vietnam*.
- Winblad, U. and Simpson-Hebert, M. (2004). *Ecological Sanitation*. Revised and enlarged ed. Sweden: Stockholm Environment Institute.

⁴ Cole, Ben, *et.al.* The sum is greater than the parts: An investigation of Plan in Vietnam's double-vault composting latrine program in northern Vietnam. March 2008. p.21

Vietnam
Decentralized Wastewater Treatment System for Xom Cau 1 – Kieu Ky Commune
An ADB-funded Pilot and Demonstration Activity with BORDA-Vietnam in Vietnam

Project Owner(s)	<ul style="list-style-type: none"> Residents of Xom Cau 1, Kieu Ky Commune
Project Partner(s)	<ul style="list-style-type: none"> Funding Agencies: Asian Development Bank (ABD), Bremen Overseas Research and Development Association (BORDA) Vietnam, & Institut des Metiers de la Ville (IMV) Executing Agency: Eau Agriculture et Sante en Milieu Tropical (EAST) Vietnam Cooperating Agency: No. 5 Assembly Construction & Investment Joint Stock Company (Contractor), District and Commune People’s Committees
Primary Contacts	<ul style="list-style-type: none"> Contact: EAST Vietnam, eastvietnam@fpt.vn

Introduction and Background

As Asian cities grow and develop, so too do the peri-urban areas surrounding these cities, where rural and urban aspects both play a role in the daily lives of citizens in these areas. However, these peri-urban areas often go largely unrecognized by city policymakers, who place emphasis on the urban city center for their development planning. This has resulted in some of these peri-urban areas gathering the ‘defects’ of development, such as large, polluting industries, landfills, and a lack of some of the essential infrastructure present in the city center, such as piped water or sewerage.

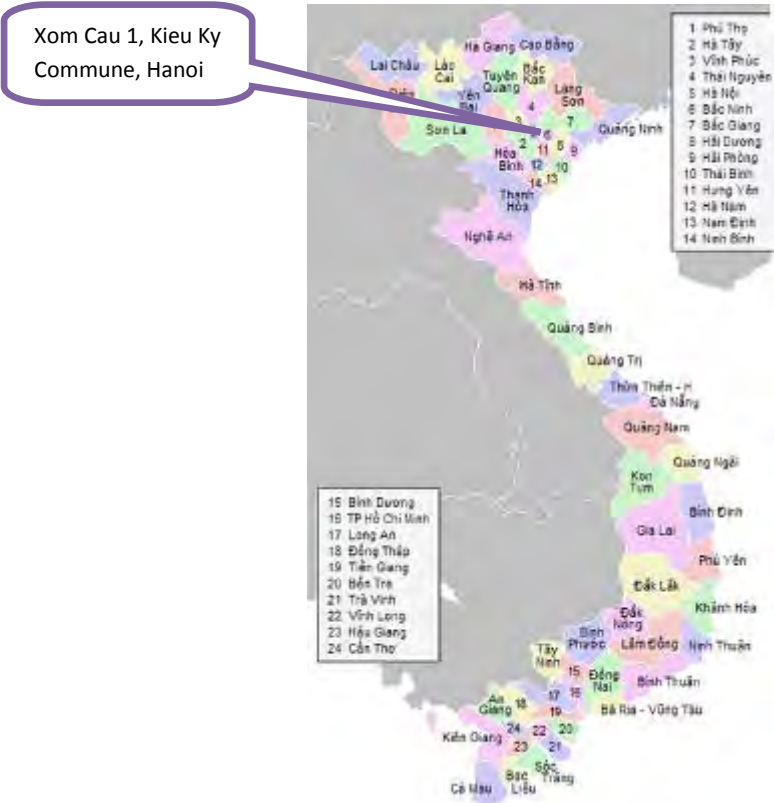

This was the case in Kieu Ky Commune, a peri-urban commune of the Hanoi Capital District. Located 20km downstream from the city center, it is directly affected by the polluted urban wastewater draining down from the city, while also containing an unsanitary landfill, and, at the time, was lacking a central water supply system and any form of sanitation program or treatment infrastructure. As well, the village's primary economic activities are traditional crafts, such as gold leaf production, which use inefficient production processes that can further contribute to environmental air and water pollution.

Recognizing this problem, the French NGO Conseil Regional d'Ile de France (CRIF) began a water supply and sanitation program in the town in 2006, in partnership with the Hanoi People's Committee. It contracted another French NGO – EAST Vietnam (Eau Agriculture et Sante en Milieu Tropical) – to prepare a proposal for this program. The water supply and sanitation aspects were then split into separate projects and the sanitation aspect was led by EAST Vietnam. Partnership funding and technology was then secured from the Asian Development Bank's (ADB) Pilot and Demonstration Activities (PDA) fund, which aims at promoting effective water management policies and practices at the regional level, as well as from the Institut des Metiers de la Ville (IMV) and the Bremen Overseas Research and Development Association (BORDA), whose modular, decentralized, and cost-effective wastewater treatment service packages that they have termed "DEWATS" (decentralized wastewater treatment systems) were used for this project.

Project Purpose and Objectives

This project in Kieu Ky had three main components: 1) select appropriate domestic wastewater collection and treatment systems, 2) select appropriate domestic wastewater collection and treatment systems for craft workshops, and 3) implement a pilot package of a wastewater plant. The purpose of these tasks was to research, investigate, and perform surveys, along with the implementation of a DEWATS plant. This had the objective of developing a sanitation model for peri-urban areas of Vietnam, to also be applicable to other parts of Southeast Asia, through a bottom-up approach. This model was aimed at enabling choices of appropriate technologies for domestic and crafts wastewater disposal, preparing the community for a water and sanitation program and ensuring their future involvement, and enabling local expertise to be widely involved and grow stronger in their credentials. Finally, the installed DEWATS would immediately help to prevent continued pollution of the local environment by treating the wastewater generated by 60 households of the commune, in the Xom Cau 1 area, with users paying a monthly fee for O&M costs.

Partners and Funding Distribution

For this project, the main funding agency was ADB, through its PDA grant. This grant, of \$50,000, covered all of the research, analysis, surveying, and outreach tasks of the project, with \$10,000 of this grant also being allotted for the DEWATS project. BORDA Vietnam then supplied an additional \$14,000 towards the DEWATS portion of the project, and IMV also supplied \$7,000 towards it. The main executing agency for the entire project was EAST Vietnam, while BORDA (through provision of its DEWATS technology), the contractor (No. 5 Assembly Construction and Investment Joint Stock Company), and the District and Commune People's Committees of Kieu Ky all served as cooperating agencies. The total project cost for all parties was therefore \$71,000.

Project Activities

This project ran from approximately March, 2008, until January, 2009, with construction of the DEWATS beginning in November, 2008. For the first component (domestic wastewater), the project

activities included: investigating current wastewater disposal practices, researching potential decentralized wastewater treatment systems available, surveying on local specialized trade skills that could work in the sanitation sector, surveying on availability of sludge removal services, and assessments of residents' willingness to pay for sanitation. For the second component (crafts wastewater), the project activities included: identifying the craft workshops activities and their current sanitary situation, chemically analyzing effluents from craft workshops, proposing appropriate technologies to reduce the pollution, and assessing craftsmen's willingness to pay for sanitation. For the third component (DEWATS), the project activities included: identifying 3 potential sites for a DEWATS, identifying necessary administrative requirements and assessing pre-feasibility of technical requirements, deciding on the location, the technology, and the user fee, chemically sampling the current wastewater at the proposed site, designing the DEWATS layout and performing a detailed engineering design, selecting the contractor construction company, constructing the DEWATS and connecting piping to the selected households, and inaugurating the plant.

Sanitation Technology / System

The module of DEWATS recommended by BORDA-Vietnam and implemented by the project consists of the following sections, in order of wastewater flow: gravity-fed sewer, primary settling unit, anaerobic baffled reactor, anaerobic filter, horizontal gravel filter, and discharge pipe.

The gravity-fed sewer line proposed by the project consisted of small-bore piping installed for each connected household to carry its septic tank effluent and greywater to the DEWATS. Using no pumps or other machinery along its length, the sewer pipes must constantly slope downward, which can lead to problems in uneven terrain or if a particular septic tank or other effluent pipe is located vertically below the trunk sewer line it is supposed to connect to, meaning that careful design of the layout is crucial. This separate sewer line was chosen to connect the majority of DEWATS households, rather than just connecting a communal drainage trench, so that it would minimize the size and land requirements, prevent the wastewater from craft workshops from entering the stream (which, of different chemical composition, could disrupt the anaerobic bacteria of the DEWATS), prevent overly high flows into the DEWATS during rainy season (by avoiding any rainwater collection), and prevent solid wastes from entering and clogging the DEWATS.

The primary settling unit serves as a wastewater retention point and an area for control of influent fluctuations (an equalization tank), which allows any large sludge, debris, and other floatable/visible wastes to settle or be screened out and also allows a relatively constant flow of wastewater to proceed to the subsequent chambers (rather than having high flows during peak hours and no flow during nighttime). This unit is single-chambered for this project.

The anaerobic baffled reactor (ABR) is then the main treatment area of the DEWATS. As the name implies, this multi-chambered tank is closed from the air and anaerobic. Wastewater flows slowly up (and back down through pipes) through its several identical chambers, each time entering the chamber at its bottom, where it passes through the accumulated sludge. This allows solids to settle out into the sludge and anaerobic bacteria living in the sludge to degrade much of the harmful organic and chemical components of the wastewater. The number of chambers can vary depending on available land area, wastewater strength, and funds – this project uses a 4 chamber ABR.

The anaerobic filter (AF) follows the ABR and consists of a tank with a submerged layer of material like crushed gravel or specially formed plastic. On to this media grows a thick layer of anaerobic bacterial biofilm, which the upflowing influent wastewater then passes through. These biofilms help remove more of the dissolved solids in the wastewater, as well as other pathogens and chemicals still remaining in the wastewater. This project uses a 3 chamber AF.

The horizontal gravel filter (HGF) (synonyms include: planted gravel filter & horizontal constructed wetland) follows the AF and consists of a shallow concrete basin filled with fine gravel, with influent and effluent pipes on opposite ends of the basin. Hardy reed plants, such as Canna, are planted in high density in this gravel layer before the DEWATS becomes operational and are allowed to grow in clean water that is initially flowed through the basin. Once the plants are established, the DEWATS can become operational and introduce the wastewater from the AF into the basin. The plant roots within the gravel help to oxygenate the wastewater, which has been anaerobic to this point and still usually has a noticeable odor, as well as remaining organic compounds. This oxygenation helps to degrade these remaining organic pollutants, which also reduces the odor. After the HGF, the effluent is usually considered clean enough for discharge to a nearby creek or canal.

For this project, this DEWATS was designed to treat 40m³/day of wastewater.

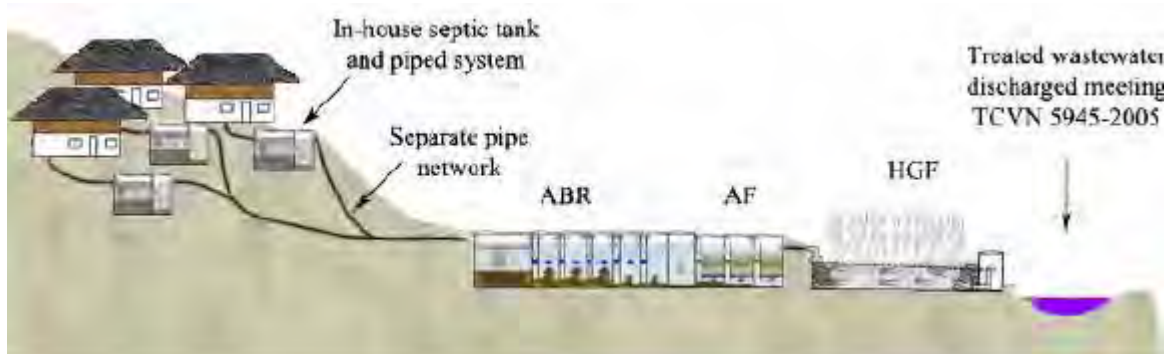

Figure 1. Schematic of the project's gravity-fed sewer lines, DEWATS, and output

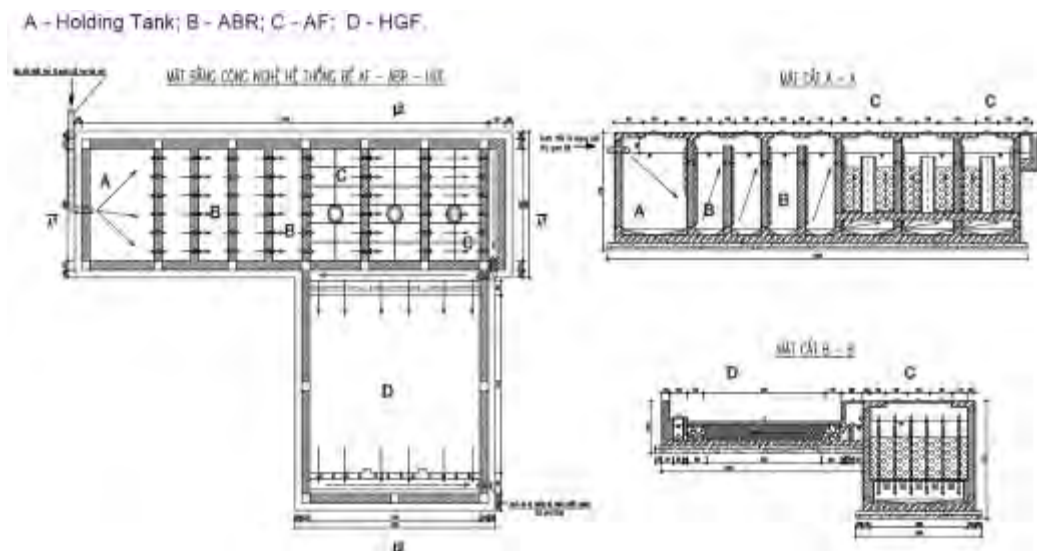

Figure 2. An overhead and cross-sectional view of the Kieu Ky DEWATS, showing the primary settling tank, ABR, AF, HGF, and influent and effluent piping.

Number, Type, and Location of Beneficiaries

For the DEWATS portion of this project, the wastewater generated from the domestic use of the 60 connected households is now covered by the DEWATS, thus reducing the potential health and environmental risks of this wastewater to nearby citizens and natural life. As well, the research generated in the other components of the project served to embolden the citizens and local experts of Kieu Ky, build their capacity, and ensure their cooperation in future sanitation projects.

Impacts and Challenges

This project is now underway and is being operated and maintained successfully by the members of the Kieu Ky Commune People’s Committee. The committee members were trained in appropriate O&M and will take this responsibility. The costs of this O&M and the costs of desludging the system every 2 to 3 years are currently being covered by the People’s Committee and are averaging about 200,000VND per month (~\$10USD). This is financially sustainable thanks to the user fee implemented on each participating household of 5000VND per month (~\$0.25USD), which is well within the budget of these residents.

One issue of the project was that not all of the 60 households were able to be connected to the gravity-fed sewer that was installed. This was due to unforeseen elevation issues, such as a septic tank located vertically lower than the trunk line, making it impossible for effluent to flow to that main sewer by gravity. Connection rate of the 60 households to the sewer was about 80%, while the effluent of the rest was taken from a connected drainage canal.

The water quality testing carried out upon the completion of the project indicates the efficient nature of the DEWATS design. The treated effluent had BOD and COD values (in mg/L) that complied with the national regulations for wastewater effluent discharged into public drainage systems, the standards of which are: COD < 80 and BOD < 50. This compliance should continue given proper O&M and indicates that this project was successful in its objective of treating the wastewater from this commune enough to comply with the standards and result in reduced health and environmental issues in the surrounding area. Together with the other research and analysis conducted, this project created a good sanitation foundation in Kieu Ky, a neglected peri-urban area, that will be able to be expanded both in the commune itself as well as in similar areas across Southeast Asia.

Photos



Figure 2. Photos of the DEWATS under construction



Figure 3. The gravity-fed sewer line under construction



Figure 4. A drainage canal before and after the installation of the DEWATS & gravity-fed sewer

References:

Asian Development Bank. (2009). *Final Report for PDA: “Developing Appropriate Sanitation Solutions for Peri-Urban Areas in Viet Nam”*. From: <http://www.adb.org/water/pda/vie/sanitation-solutions-peri-urban.asp> [Accessed 02 May 2011]

Asian Development Bank. (2007). *Project Proposal for PDA: “Developing Appropriate Sanitation Solutions for Peri-Urban Areas in Viet Nam”*. From: <http://www.adb.org/water/pda/vie/sanitation-solutions-peri-urban.asp> [Accessed 02 May 2011]

BORDA-Vietnam. (2010). *Technical Data Sheet for Xom Cau 1, Kieu Ky Commune*.

Vietnam
Decentralized Wastewater Treatment Systems for a Prison and 2 Hospitals
Three BORDA-Vietnam DEWATS Projects in Vietnam

Project Owner(s)	<ul style="list-style-type: none"> ▪ 1) Owner of the Ninh Khanh Prison ▪ 2) Owner of the Kim Bang District Hospital ▪ 3) Owner of the Thanh Hoa Pediatric Facility
Project Partner(s)	<ul style="list-style-type: none"> ▪ 1) Funding Agency: Owner of the Ninh Khanh Prison; Executing Agency: Bremen Overseas Research and Development Association – Vietnam (BORDA-Vietnam) and the Ninh Khanh Prison staff ▪ 2) Funding Agency: BORDA-Vietnam & Kim Bang District Hospital Executing Agency: BORDA-Vietnam ▪ 3) Funding Agency: Thanh Hoa Provincial Government Executing Agency: Thanh Hoa Project Management Unit & Thanh Hoa Construction Company Cooperating Agency: BORDA-Vietnam
Primary Contacts	<ul style="list-style-type: none"> ▪ Contact: Hanoi@borda-sea.org or Fladerer@borda.de

Introduction and Background

The Bremen Overseas Research and Development Association (BORDA) has a mission to improve the living conditions of disadvantaged communities and to preserve the environment through decentralized sanitation projects. As part of this mission, the Association has developed modular, decentralized, and cost-effective wastewater treatment service packages that they have termed ‘DEWATS’ – decentralized wastewater treatment systems, which, with the help of funding agencies, are being installed throughout Asia and Africa.

Water and sanitation are one of the most pressing issues facing people in rural Vietnam. Of particular difficulty for sanitation advocates in Vietnam is the habit of using raw feces to fertilize rice fields, with the result of exposing human excreta to the environment. This leads to water and soil contamination and to widespread disease outbreaks. The UN estimated that, in 2010, only 18% of rural households, 12% of rural schools, and 37% of commune health stations had a hygienic latrine that met Ministry of Health standards, which means the country still has a long way to go to achieving ‘sanitation for all’.

With this in mind, BORDA established itself in the country in 2001, as BORDA-Vietnam. The Association has completed eight projects in Vietnam to date, three of which use essentially the same modular technology and are outlined here.

The first area chosen for DEWATS was the Ninh Khanh Prison, in Ninh Binh Province. As a fairly large prison of the province, it was relying solely on an outdated septic tank for treatment of all the wastewater generated by the prisoners and staff. However, due to significant increases in the prison population, the septic tank had been overloaded and was discharging essentially untreated wastewater to the surroundings, creating high health and environmental risks. Indeed, the staff and prisoner’s health was already been adversely impacted, especially in terms of foul odor and pollution of the local groundwater resource.

The second area chosen for DEWATS was the Kim Bang District Hospital, in Ha Nam Province. As a medium-sized hospital in the province, it was discharging its wastewater in the nearby field without adequate treatment. Blackwater from toilets was treated only in outdated septic tanks, while all greywater and other wastewater sources were simply run through a soak pit before discharge. This was creating an unsafe situation for the local surroundings, as the inadequately treated wastewater was causing groundwater pollution and environmental and health risks, with further danger introduced from the higher levels of disease-causing organisms present in hospital wastewater.

The third area chosen for DEWATS was the Thanh Hoa Pediatric Facility, in Thanh Hoa Province. As a large hospital (twice the size of the Kim Bang hospital), it too was discharging its wastewater in a similar manner, with blackwater treated only in an outdated septic tank before discharge, and greywater and other wastewater sources being discharged to the surroundings totally untreated. With the high wastewater flows from this facility, this was creating a very unsafe situation for the local surroundings, as the inadequately treated wastewater was causing groundwater pollution and environmental and health risks, with further danger again introduced from the higher levels of disease-causing organisms present in hospital wastewater.

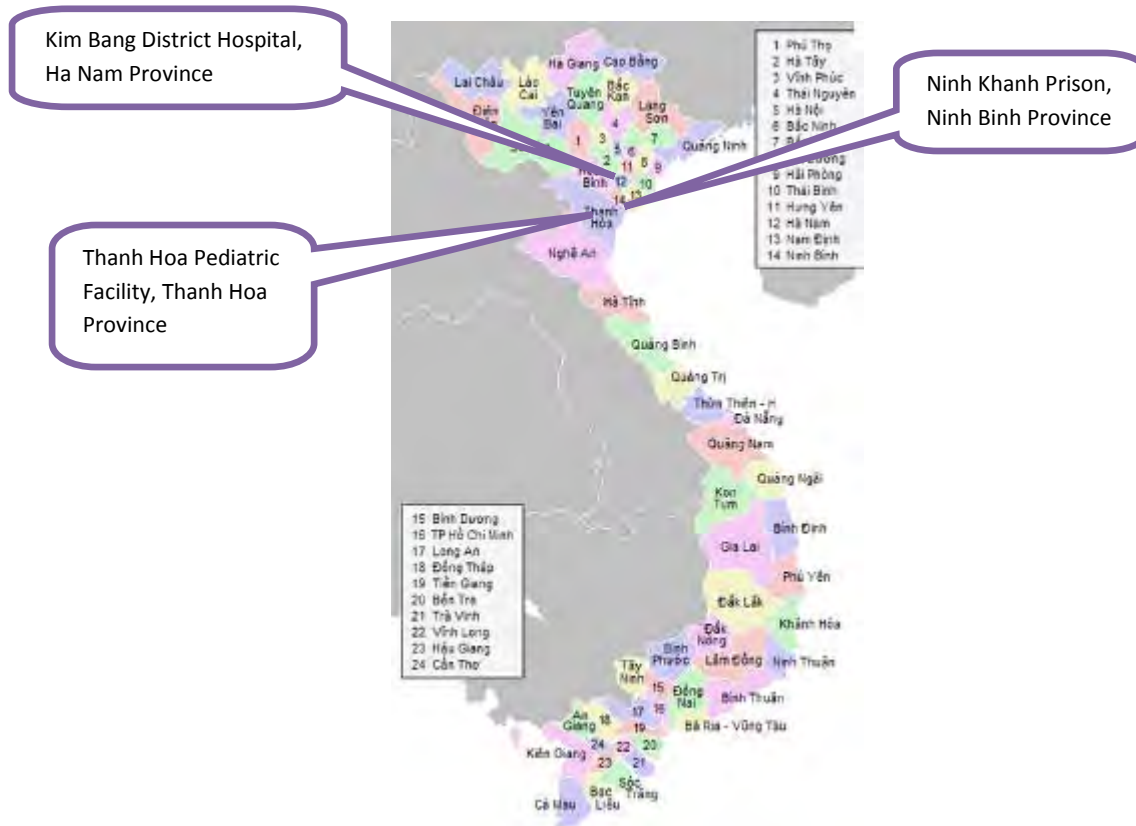

Project Purpose and Objectives

BORDA’s general purpose for the DEWATS projects is to further their goal of “Improved Sanitation for All”. Their systems help to fulfill this purpose, which can provide wastewater treatment for domestic or industrial sources and for flows as high as 1000m³ per day, and are tolerant to flow fluctuations, require low maintenance, and are durable. In addition to this general purpose, each project undertaken by BORDA has its own purpose and objectives, based on the problems being experienced by the project site.

For the Ninh Khanh Prison project, the purpose was to prevent continued pollution of the local environment by prison wastewater by installing a DEWATS capable of treating up to 105m³/day of wastewater from the 1150 prisoners and 150 staff using the prison toilets, clinic, kitchen, and wash basins. This had the objective of ensuring that the area around the prison would stop being polluted, with subsequent reduction in the health issues that were affecting the prison community.

For the Kim Bang District Hospital project, the purpose was to prevent continued pollution of the local environment by hospital wastewater by installing a DEWATS capable of treating up to 125m³/day of wastewater from the 250 beds (at 80% average occupation rate with patients) and 100 employees using the hospital toilets, wash basins, laundry services, kitchen, and medical laboratory. This had the objective of ensuring that the area around the hospital would stop being polluted, with subsequent reduction in the health and environmental issues that were occurring.

For the Thanh Hoa Pediatric Facility project, the purpose was to prevent continued pollution of the local environment by hospital wastewater by installing a DEWATS capable of treating up to 300m³/day of wastewater from the 500 beds (at 80% average occupation rate with patients) and 150 employees using the hospital toilets, wash basins, laundry services, kitchen, and medical laboratories. This had the objective of ensuring that the area around the hospital would stop being polluted, with subsequent reduction in the health and environmental issues that were occurring.

Partners and Funding Distribution

For the Ninh Khanh Prison project, the funding agency was the owner of the prison, who was also the beneficiary, and who shared the executing agency tasks with BORDA-Vietnam. The total project cost was 1.842 billion VND (approximately \$103,000USD at the time).

For the Kim Bang District Hospital project, the funding agencies were the owner of the hospital and BORDA-Vietnam, with BORDA-Vietnam also performing executing agency functions. The total project cost was 720 million VND (approximately \$45,000USD at the time).

For the Thanh Hoa Pediatric Facility project, the funding agency was the Thanh Hoa Provincial Government, with their affiliated Project Management Unit & Construction Company being the executing agencies. BORDA-Vietnam was the cooperating agency, providing the technical designs and advice. The total project cost was \$135,000USD.

Project Activities

The Ninh Khanh Prison project ran from July, 2008, until April, 2010, with construction beginning in November, 2009. The project activities included: consultation with the staff of the prison, construction of the DEWATS, connecting the drainage pipes of the cell blocks, kitchen, clinic, culture house, and other toilets and wash basins to the DEWATS, and training the staff on operation and maintenance.

The Kim Bang District Hospital project ran from 6 September, 2005, until 30 April, 2007, with construction beginning on 14 November, 2006. The project activities included: consultation with the staff of the hospital, construction of the DEWATS, connecting the drainage pipes of the toilets, bathrooms, laundry units, kitchen, and medical laboratory to the DEWATS, and training the staff on operation and maintenance.

The Thanh Hoa Pediatric Facility project ran from May, 2007, until November, 2008, with construction beginning in July, 2008. The project activities included: consultation with the staff of

the hospital, construction of the DEWATS, connecting the drainage pipes of the toilets, bathrooms, laundry units, kitchen, and medical laboratories to the DEWATS, and training the staff on operation and maintenance.

Sanitation Technology / System

The module of DEWATS used by these three projects of BORDA-Vietnam consisted of the following sections, in order of wastewater flow: primary settling unit, anaerobic baffled reactor, anaerobic filter, horizontal gravel filter, polishing pond, and discharge pipe. A grease trap was also used for the Kim Bang District Hospital project, prior to this treatment module.

The grease trap preceding the module in the Kim Bang District Hospital project is a simple tank of three chambers, with influent and effluent pipes positioned fairly deep below the anticipated water level. Since grease (oil) floats on water, influent grease rises to the surface and is trapped there, while the remaining wastewater exits through the sunken effluent pipe. This grease trap is connected solely to the kitchen wastewater pipes, where most grease is generated, and which can disrupt the proper functioning of the treatment module if not removed, due to the difficulty in treating grease.

The primary settling unit serves as a wastewater retention point and an area for control of influent fluctuations (an equalization tank), which allows any large sludge, debris, and other floatable/visible wastes to settle or be screened out and also allows a relatively constant flow of wastewater to proceed to the subsequent chambers (rather than having high flows during peak hours and no flow during nighttime). This unit is single-chambered for these projects.

The anaerobic baffled reactor (ABR) is then the main treatment area of the DEWATS. As the name implies, this multi-chambered tank is closed from the air and anaerobic. Wastewater flows slowly up (and back down through pipes) through its several identical chambers, each time entering the chamber at its bottom, where it passes through the accumulated sludge. This allows solids to settle out into the sludge and anaerobic bacteria living in the sludge to degrade much of the harmful organic and chemical components of the wastewater. The number of chambers can vary depending on available land area, wastewater strength, and funds – the ABR for the Ninh Khanh Prison project has 4 chambers, the Kim Bang District Hospital project has 2 parallel 8 chamber ABRs (each treating half of the wastewater), and the Thanh Hoa Pediatric Facility project has a 20 chamber ABR.

The anaerobic filter (AF) follows the ABR and consists of a tank with a submerged layer of material like crushed gravel or specially formed plastic. On to this media grows a thick layer of anaerobic bacterial biofilm, which the upflowing influent wastewater then passes through. These biofilms help remove more of the dissolved solids in the wastewater, as well as other pathogens and chemicals still remaining in the wastewater. This unit has 3 chambers for the Ninh Khanh Prison project, while the Kim Bang District Hospital project has 2 parallel 4 chamber AFs, and the Thanh Hoa Pediatric Facility project has a 12 chamber AF.

The horizontal gravel filter (HGF) (synonyms include: planted gravel filter & horizontal constructed wetland) follows the AF and consists of a shallow concrete basin filled with fine gravel, with influent and effluent pipes on opposite ends of the basin. Hardy reed plants, such as Canna, are planted in high density in this gravel layer before the DEWATS becomes operational and are allowed to grow in clean water that is initially flowed through the basin. Once the plants are established, the DEWATS can become operational and introduce the wastewater from the AF into the basin. The plant roots within the gravel help to oxygenate the wastewater, which has been anaerobic to this point and still usually has a noticeable odor, as well as remaining organic compounds. This oxygenation helps to

degrade these remaining organic pollutants, which also reduces the odor. The Ninh Khanh Prison project has one of these units, while the Kim Bang District Hospital and Thanh Hoa Pediatric Facility projects have two in parallel.

After the HGF, the effluent proceeds to a polishing pond. This pond allows the effluent further aeration and settling time, and can also serve as an indicator for the effluent's quality. That is, if surrounding plants or small animals that were living around the pond suddenly die, this indicates a problem in the treatment process. After this pond, the effluent is usually then considered clean enough for safe river discharge. The Ninh Khanh Prison project has one of these units, while the Kim Bang District Hospital project has 4 in parallel and the Thanh Hoa Pediatric Facility project has 2 in parallel.

For the Ninh Khanh Prison project, the DEWATS was designed to treat $105\text{m}^3/\text{day}$ of wastewater. For the Kim Bang District Hospital project, the DEWATS was designed to treat $125\text{m}^3/\text{day}$ of wastewater. For the Thanh Hoa Pediatric Facility project, the DEWATS was designed to treat $300\text{m}^3/\text{day}$ of wastewater.

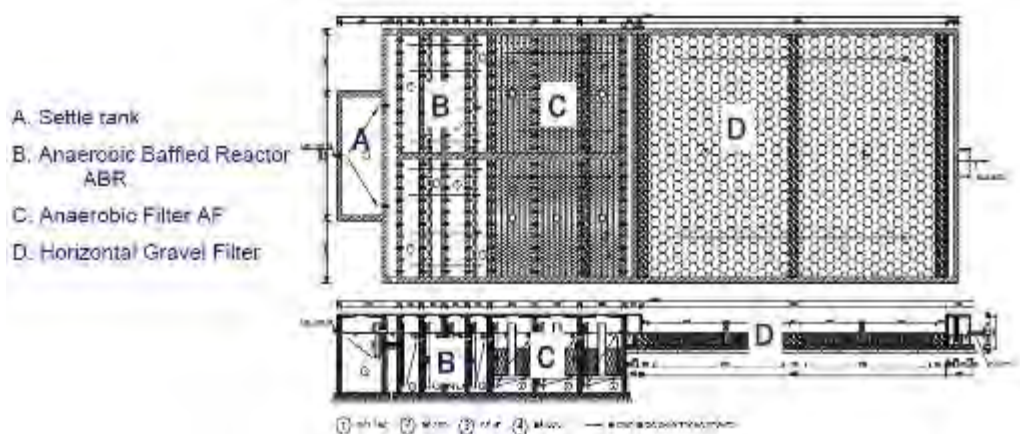

Figure 1. A cross-section and overhead view of the Ninh Khanh Prison project's DEWATS, showing the 1 chambered settling tank, the 4 chambered ABR, the 3 chambered AF, the HGF, and the polishing pond, as well as influent and effluent piping.

A. - Sedimentation Tank ; B - Anaerobic Baffled Reactor; C - Anaerobic Filter; D - Horizontal Gravel Filter
 E.- Indicator pond; F - Grease trap

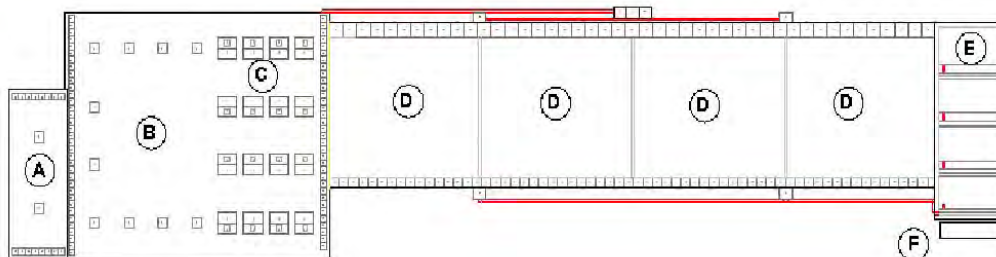

Figure 2. An overhead view of the Kim Bang District Hospital project's DEWATS, showing the 1 chambered settling tank, the 2 parallel 8 chamber ABRs, the 2 parallel 4 chamber AFs, the 2 parallel HGFs, and the 4 parallel polishing ponds, as well as influent and effluent piping.

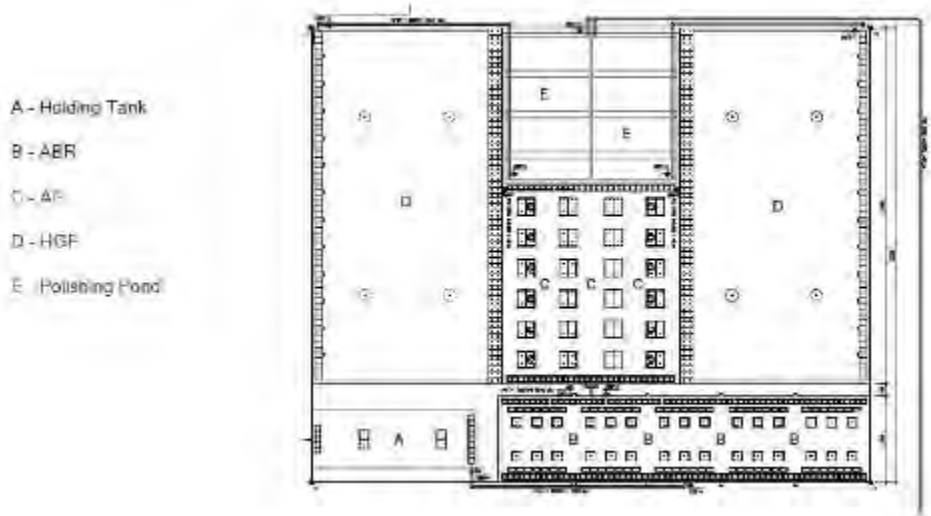

Figure 3. An overhead view of the Thanh Hoa Pediatric Facility project’s DEWATS, showing the 1 chambered settling tank, the 20 chamber ABR, the 12 chamber AF, the 2 parallel HGFs, and the 2 parallel polishing ponds, as well as influent and effluent piping.

Number, Type, and Location of Beneficiaries

For the Ninh Khanh Prison project, the wastewater generated from the prison cells, kitchen, clinic, culture house, and other washings as a result of the 1150 prisoners and 150 employees who use the facility are now covered by the DEWATS. The improvements made in wastewater management, however, extend beyond this prison, as this large source of water/groundwater pollution to the surrounding area has been eliminated, thus reducing the potential health and environmental risks that had already been affecting the prisoners, nearby citizens, and natural life.

For the Kim Bang District Hospital project, the wastewater generated from the toilets, bathrooms, laundry units, kitchen, and medical laboratory as a result of the hospital patients (250 max.) and 100 employees who use the facility are now covered by the DEWATS. The improvements made in wastewater management, however, extend beyond this hospital, as this large source of water/groundwater pollution to the surrounding area has been eliminated, thus reducing the potential health and environmental risks to the nearby citizens and natural life.

For the Thanh Hoa Pediatric Facility project, the wastewater generated from the toilets, bathrooms, laundry units, kitchen, and medical laboratories as a result of the hospital patients (500 max.) and 150 employees who use the facility are now covered by the DEWATS. The improvements made in wastewater management, however, extend beyond this hospital, as this large source of water/groundwater pollution to the surrounding area has been eliminated, thus reducing the potential health and environmental risks to the nearby citizens and natural life.

Impacts and Challenges

These projects are now underway and are being operated and maintained successfully by the staff members of each facility. The funding grants were used to cover construction costs, community engagement costs, and initial water quality testing costs. The staff of each facility were trained in appropriate O&M and will take this responsibility. The costs of this O&M and the costs of desludging the system every 2 to 3 years are currently being covered by the owners of each facility, with O&M averaging about 500,000VND per month (about \$23USD) for the Ninh Khanh Prison, and 200,000

VND per month (about \$10USD) for the Kim Bang District Hospital and Thanh Hoa Pediatric Facility projects.

The water quality testing carried out upon the completion of each project indicates the efficient nature of the DEWATS design. The treated effluent of each project had BOD and COD values (in mg/L) that complied with the national regulations for wastewater effluent discharged into public drainage systems, the standards of which are: COD < 80 and BOD < 50. For example, the Kim Bang District Hospital project, in a 2007 sampling, had COD = 20mg/L and BOD = 11mg/L. This compliance should continue given proper O&M and indicates that these projects were successful in their objective of treating the wastewater from these facilities enough to comply with the standards, and result in reduced health and environmental issues in the surrounding areas.

Photos



Figure 4. Photos of the Ninh Khanh Prison project under construction, as well as the completed HGF



Figure 5. Photo of the completed HGF of the Kim Bang District Hospital project



Figure 6. Photo of the Thanh Hoa Pediatric Facility project under construction

References

- BORDA-Vietnam. (2010). *Technical Data Sheet for Ninh Khanh Prison*.
- BORDA-Vietnam. (2008). *Technical Data Sheet for Kim Bang District Hospital*.
- BORDA-Vietnam. (2009). *Technical Data Sheet for Thanh Hoa Pediatric Facility*.
- UN Vietnam. (2010). *Achieving the MDGs with Equity – MDG 7: Ensure Environmental Sustainability*. From: http://www.un.org.vn/images/stories/MDGs/MDG7_Eng.pdf
[Accessed 18 Apr. 2011]

Vietnam
Decentralized Wastewater Treatment Systems for the Bear Rescue Center at Tam Dao
A BORDA-Vietnam DEWATS Project in Vietnam

Project Owner(s)	<ul style="list-style-type: none"> ▪ Staff of Animals Asia Foundation (AAF)
Project Partner(s)	<ul style="list-style-type: none"> ▪ Funding Agency: Animals Asia Foundation; ▪ Executing Agency: Bremen Overseas Research and Development Association – Vietnam (BORDA-Vietnam)
Primary Contacts	<ul style="list-style-type: none"> ▪ Contact: Hanoi@borda-sea.org

Introduction and Background

The Bremen Overseas Research and Development Association (BORDA) has a mission to improve the living conditions of disadvantaged communities and to preserve the environment through decentralized sanitation projects. As part of this mission, the Association has developed modular, decentralized, and cost-effective wastewater treatment service packages that they have termed ‘DEWATS’ – decentralized wastewater treatment systems, which, with the help of funding agencies, are being installed throughout Asia and Africa.



Water and sanitation are one of the most pressing issues facing people in rural Vietnam. Of particular difficulty for sanitation advocates in Vietnam is the habit of using raw feces to fertilize rice fields, with the result of exposing human excreta to the environment. This leads to water and soil contamination and to widespread disease outbreaks. The UN estimated that, in 2010, only 18% of rural households, 12% of rural schools, and 37% of commune health stations had a hygienic latrine that met Ministry of Health standards, which means the country still has a long way to go to achieving 'sanitation for all'.

With this in mind, BORDA established itself in the country in 2001, as BORDA-Vietnam. The Association has completed eight projects in Vietnam to date, one of which is outlined here.

One area chosen for DEWATS was the Bear Rescue Center in Tam Dao National Park, in Vinh Phuc Province. This rescue center rehabilitates bears that had been used in zoos, street performances, or other cruel practices, with an average of 50 bears in the center. Each bear, plus the human staff, produce wastewater, and since the center is located inside a national park – which is bound by strict laws regarding the discharge of wastewater – the center's wastewater could not legally be discharged to the nearby creek and needed an effective treatment system.

Project Purpose and Objectives

BORDA's general purpose for the DEWATS projects is to further their goal of "Improved Sanitation for All". Their systems help to fulfill this purpose, which can provide wastewater treatment for domestic or industrial sources and for flows as high as 1000m³ per day, and are tolerant to flow fluctuations, require low maintenance, and are durable. In addition to this general purpose, each project undertaken by BORDA has its own purpose and objectives, based on the problems being experienced by the project site.

For this project, the purpose was to ensure that the effluent of the rescue center complied with national law regarding wastewater discharge in a national park by installing a DEWATS for the 50 bears and 10 staff that lived and worked there, capable of treating up to 22m³/day of wastewater flow. This had the objective of ensuring that the Tam Dao National Park remained in a pristine state, free of pollution from harmful wastewater.

Partners and Funding Distribution

For this project, the funding agency was the Animals Asia Foundation (AAF), which also manages the rescue center, with BORDA-Vietnam being the executing agency. The total project cost was 600 million VND (approximately \$36,000USD at the time).

Project Activities

This project ran from 25 June, 2006, until 30 April, 2008, with construction beginning on 20 September, 2007. The project activities included: consultation with the staff of the center, construction of the DEWATS, connecting the existing septic tank (for staff toilets/sinks) and bear houses of all the center's buildings to the DEWATS, and training the staff on operation and maintenance.

Sanitation Technology / System

This module of DEWATS used by BORDA-Vietnam required very clean effluent to comply with national park standards, and so consisted of the following sections, in order of wastewater flow:

septic tank (for staff's wastewater only), holding tank, 2 biogas digesters, settling unit, anaerobic baffled reactor, anaerobic filter, horizontal gravel filter, WATTs system, storage tank, and discharge pipe.

The initial septic tank receives all wastewater from the staff toilets and wash basins for initial settling of solids and some primary degradation of organics by bacteria in the tank. The effluent then joins raw effluent from the bear houses (which consists of bear urine, feces, hair, food remnants, etc. that is washed from the houses into connecting drains) draining into the holding tank.

The holding tank receives all of this wastewater and serves as a wastewater retention point and an area for control of influent fluctuations (an equalization tank), which allows large sludge, debris, and other floatable/visible wastes to settle or be screened out before pumps deliver the wastewater at a relatively constant flow to the subsequent biogas reactor (rather than having high flows during peak hours and no flow during nighttime).

The biogas reactor is an anaerobic, sealed chamber that serves as a primary settling tank, with relatively fast passage of the liquid effluent through the chamber and digestion of much of the settled sludge by anaerobic bacteria. In this way it is much like a septic tank, except that its sealed nature allows all of the 'biogas' – a mixture of methane and carbon dioxide that is released from anaerobic digestion – to be captured and used. Depending on the size of the biogas reactor, this generated gas can be used either for small scale applications like operating a gas stove or larger scale applications like powering a gas heater system for a building. Since most of the organic matter is converted to biogas, sludge production is relatively low. The settled sludge usually remains in the unit for several years and, when removed, is relatively pathogen-free, requiring only some post-composting to ensure sterility. As well, biogas units are climate-friendly, since the generated biogas is offsetting the need for additional gas at the project site. This project uses two biogas reactors in series, due to the high flow rates and greater difficulty in maintaining a single large biogas reactor as opposed to two smaller ones. The biogas generated is being used for cooking.

The next settling unit serves as another wastewater retention point and an area for control of influent fluctuations (an equalization tank), which allows any remaining large sludge, debris, and other floatable/visible wastes to settle or be screened out and also allows a relatively constant flow of wastewater to proceed to the subsequent chambers (rather than having high flows during peak hours and no flow during nighttime). This unit is single-chambered for this project.

The anaerobic baffled reactor (ABR) is then the main treatment area of the DEWATS. As the name implies, this multi-chambered tank is closed from the air and anaerobic. Wastewater flows slowly up (and back down through pipes) through its several identical chambers, each time entering the chamber at its bottom, where it passes through the accumulated sludge. This allows solids to settle out into the sludge and anaerobic bacteria living in the sludge to degrade much of the harmful organic and chemical components of the wastewater. The number of chambers can vary depending on available land area, wastewater strength, and funds – the ABR for this project has 4 chambers, though 5 or 6 are also common.

The anaerobic filter (AF) follows the ABR and consists of a tank with a submerged layer of material like crushed gravel or specially formed plastic. On to this media grows a thick layer of anaerobic bacterial biofilm, which the upflowing influent wastewater then passes through. These biofilms help remove more of the dissolved solids in the wastewater, as well as other pathogens and chemicals still remaining in the wastewater. This unit has 8 chambers for this project, in order to help obtain very clean effluent (2 chambers is more common).

The horizontal gravel filter (HGF) (synonyms include: planted gravel filter & horizontal constructed wetland) follows the AF and consists of a shallow concrete basin filled with fine gravel, with influent and effluent pipes on opposite ends of the basin. Hardy reed plants, such as Canna, are planted in high density in this gravel layer before the DEWATS becomes operational and are allowed to grow in clean water that is initially flowed through the basin. Once the plants are established, the DEWATS can become operational and introduce the wastewater from the AF into the basin. The plant roots within the gravel help to oxygenate the wastewater, which has been anaerobic to this point and still usually has a noticeable odor, as well as remaining organic compounds. This oxygenation helps to degrade these remaining organic pollutants, which also reduces the odor.

After the HGF, effluent is usually considered clean enough for safe river discharge, but since this project was in a national park, a chlorination tank and subsequent storage tank were also installed. However, this chlorination step was soon replaced by a new system called WATTs, which is manufactured by a Vietnamese company known as Thietbiloc. This process passes the effluent through an activated carbon filter column, ion exchange columns, and finishes with ozone treatment. At this point, the clean effluent is then discharged to a rainwater canal.

For this project, this DEWATS was designed to treat 22m³/day of wastewater.

Number, Type, and Location of Beneficiaries

For this project, there are approximately 50 bears and 10 staff who are now covered by the DEWATS. The improvements made in wastewater management, however, extend beyond this rescue center, as the downstream national park life will now remain pristine and free from pollution.

- A. Holding tank
- B. Biogas digester
- C. ABR
- D. AF
- E. HGF
- F. Chlorination tank

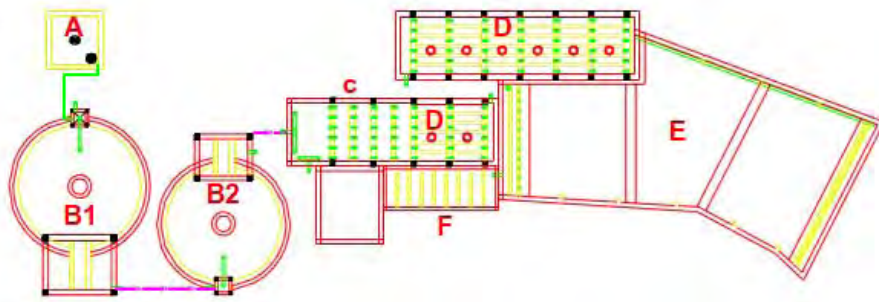

Figure 1. An overhead view of the bear rescue center project’s DEWATS, showing the holding tank, the 2 biogas reactors, the 1 chambered primary settling tank, the 4 chambered ABR, the 8 chambered AF, the HGF, and the “chlorination tank” (which now contains the aforementioned WATTs system), as well as influent and effluent piping.

Impacts and Challenges

This project is now underway and is being operated and maintained successfully by the staff members of the rescue center. The funding grant was used to cover construction costs, community engagement costs, and initial water quality testing costs. The staff of the rescue center were trained in appropriate O&M and will take this responsibility. The costs of this O&M and the costs of desludging the system every 2 to 3 years are currently being covered by the rescue center through the AAF, with O&M averaging about 1 million VND per month (currently about \$50USD/month).

The water quality testing carried out upon the completion of the project indicates the efficient nature of the DEWATS design. The treated effluent had BOD and COD values (in mg/L) that complied with the national regulations for wastewater effluent discharged into a national park, the standards of which are: COD < 50 and BOD < 20, with the most recent sample values being 29 and 18.5 for COD and BOD, respectively. This compliance should continue given proper O&M and indicates that this project was successful in its objective of treating the wastewater from this rescue center enough to comply with national park standards and allow the park to be maintained in its pristine state.

Photos



Figure 2. Photos of the bear rescue center’s DEWATS under construction and completed

References

- BORDA-Vietnam. (2008). *Technical Data Sheet for Project Code ID-02*.
- Spulher, D. (2010). *Biogas Settlers*. From: <http://www.sswm.info/category/implementation-tools/wastewater-treatment/hardware/semi-centralised-wastewater-treatments/b> [Accessed 18 Apr. 2011]
- Thietbiloc. (2011). <http://thietbiloc.com/> [Accessed 9 May 2011]
- UN Vietnam. (2010). *Achieving the MDGs with Equity – MDG 7: Ensure Environmental Sustainability*. From: http://www.un.org.vn/images/stories/MDGs/MDG7_Eng.pdf [Accessed 18 Apr. 2011]

Vietnam
Decentralized Wastewater Treatment Systems for the Khac Niem Commune
A VAWR/BORDA-Vietnam DEWATS Project in Vietnam

Project Owner(s)	<ul style="list-style-type: none"> Residents of the Khac Niem Commune
Project Partner(s)	<ul style="list-style-type: none"> Funding Agency: Ministry of Agriculture and Rural Development; Executing Agency: Vietnam Academy for Water Resources (VAWR); Cooperating Agency: Bremen Overseas Research and Development Association (BORDA) Vietnam
Primary Contacts	<ul style="list-style-type: none"> Contact: Hanoi@borda-sea.org or Mr. Vu Hai Nam of CTIC, namvhicd@gmail.com, or Mr. Nguyen Tung Phong, phongicd@gmail.com

Introduction and Background

The Bremen Overseas Research and Development Association (BORDA) has a mission to improve the living conditions of disadvantaged communities and to preserve the environment through decentralized sanitation projects. As part of this mission, the Association has developed modular, decentralized, and cost-effective wastewater treatment service packages that they have termed 'DEWATS' – decentralized wastewater treatment systems, which, with the help of funding agencies, are being installed throughout Asia and Africa.

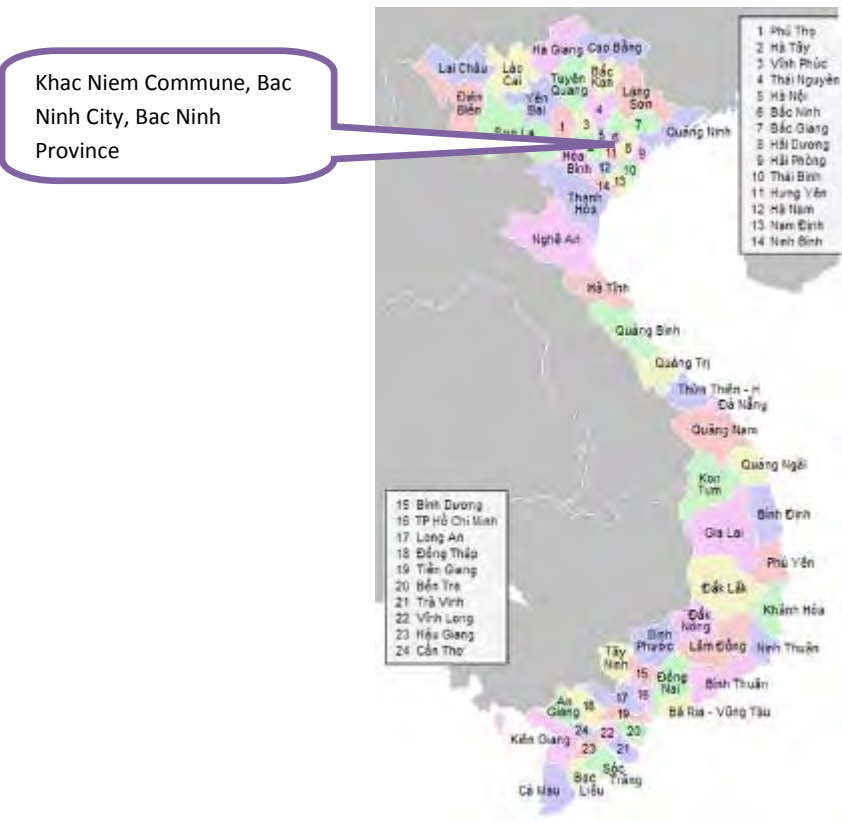

Water and sanitation are one of the most pressing issues facing people in rural Vietnam. Of particular difficulty for sanitation advocates in Vietnam is the habit of using raw feces to fertilize rice fields, with the result of exposing human excreta to the environment. This leads to water and soil contamination and to widespread disease outbreaks. The UN estimated that, in 2010, only 18% of rural households, 12% of rural schools, and 37% of commune health stations had a hygienic latrine that met Ministry of Health standards, which means the country still has a long way to go to achieving 'sanitation for all'.

With this in mind, BORDA established itself in the country in 2001, as BORDA-Vietnam. The Association has completed eight projects in Vietnam to date, one of which is outlined here. However, BORDA has since 2001 been cooperating with a local partner, the Vietnam Academy for Water Resources (VAWR), to whom BORDA has been training and providing knowledge transfers to. This was, as a result, the first pilot project undertaken by VAWR as executing agency, while BORDA performed coordination and support.

One area chosen for DEWATS was the Khac Niem Commune, in Bac Ninh City. This traditional craft village is known for its rice noodle processing industry. The domestic wastewater from the households of this commune, as well as wastewater from the noodle processing facilities in the commune – which has a high organic load – was discharging untreated into the local environment. This was creating health and environmental risks from the polluted groundwater and surface waters, including foul odor and the potential for waterborne disease outbreaks. An effective wastewater treatment system was therefore needed, which was recognized by the national government through the Ministry of Agriculture and Rural Development, who enlisted the help of BORDA-VAWR.

Project Purpose and Objectives

BORDA-VAWR's general purpose for the DEWATS projects is to further their goal of "Improved Sanitation for All". Their systems help to fulfill this purpose, which can provide wastewater treatment for domestic or industrial sources and for flows as high as 1000m³ per day, and are tolerant to flow fluctuations, require low maintenance, and are durable. In addition to this general purpose, each project undertaken by BORDA/VAWR has its own purpose and objectives, based on the problems being experienced by the project site.

For this project, the purpose was to prevent continued pollution of the local environment by the wastewater generated by the households and businesses of the commune by installing a DEWATS capable of treating up to 400m³/day of wastewater from the 320 households and businesses of the commune. This had the objective of ensuring that the groundwater and surface water around the commune would stop being polluted, with subsequent reduction in the health, environmental, and odor issues that were occurring.

Partners and Funding Distribution

For this project, the funding agency was the Ministry of Agriculture and Rural Development, with VAWR being the executing agency and BORDA-Vietnam serving in a coordinating and supporting role. The total project cost was 6.601 billion VND (approximately \$370,000USD at the time).

Project Activities

This project ran from August, 2007, until September, 2010, with construction beginning in April, 2009. The project activities included: consultation with the Commune People's Committee, construction of the DEWATS, connecting the drainage pipes of the septic tanks/bathrooms/kitchens

of the households/businesses to the DEWATS, and training the People's Committee members on operation and maintenance.

Sanitation Technology / System

This module of DEWATS used by BORDA-Vietnam consists of the following sections, in order of wastewater flow: primary settling unit, anaerobic baffled reactor, anaerobic filter, polishing pond, and discharge pipe.

The primary settling unit serves as a wastewater retention point and an area for control of influent fluctuations (an equalization tank), which allows any large sludge, debris, and other floatable/visible wastes to settle or be screened out and also allows a relatively constant flow of wastewater to proceed to the subsequent chambers (rather than having high flows during peak hours and no flow during nighttime). This project uses two of these single-chamber units in parallel, with each processing half of the influent wastewater.

The anaerobic baffled reactor (ABR) is then the main treatment area of the DEWATS. As the name implies, this multi-chambered tank is closed from the air and anaerobic. Wastewater flows slowly up (and back down through pipes) through its several identical chambers, each time entering the chamber at its bottom, where it passes through the accumulated sludge. This allows solids to settle out into the sludge and anaerobic bacteria living in the sludge to degrade much of the harmful organic and chemical components of the wastewater. The number of chambers can vary depending on available land area, wastewater strength, and funds – this project uses two parallel 3 chamber ABRs, though 4 or 5 chambers are also common.

The anaerobic filter (AF) follows the ABR and consists of a tank with a submerged layer of material like crushed gravel or specially formed plastic. On to this media grows a thick layer of anaerobic bacterial biofilm, which the upflowing influent wastewater then passes through. These biofilms help remove more of the dissolved solids in the wastewater, as well as other pathogens and chemicals still remaining in the wastewater. This project uses two parallel 3 chamber AFs.

After the AF, the effluent proceeds to a polishing pond. This pond allows the effluent to aerate (it had been anaerobic up to this point and usually still has a foul odor) and provides further settling time, and can also serve as an indicator for the effluent's quality. That is, if surrounding plants or small animals that were living around the pond suddenly die, this indicates a problem in the treatment process. Aeration allows the anaerobic odor of the wastewater to dissipate and aerobic bacteria living in the pond to further degrade remaining organic compounds. After this pond, the effluent is usually then considered clean enough for discharge to a nearby creek or canal.

For this project, this DEWATS was designed to treat 400m³/day of wastewater.

A - Sedimentation Tank; B - Anaerobic Baffled Reactor; C - Anaerobic Filter; D - Biological Pond

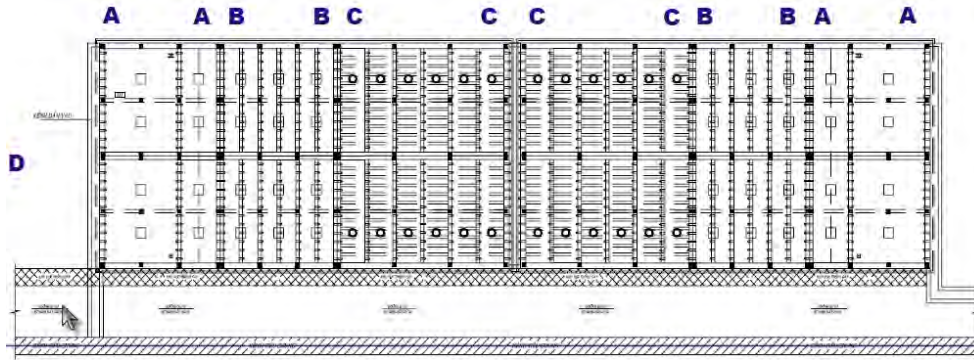

Figure 1. An overhead view of the commune project's DEWATS, showing the 2 parallel sedimentation tanks, ABRs (3 chambered), and AFs (3 chambered), as well as the polishing pond area, and influent and effluent piping.

Number, Type, and Location of Beneficiaries

For this project, the wastewater generated from the domestic use of the households, the discharges from the noodle processing businesses in the commune, and the other results of the 320 households and businesses discharging wastewater in this commune are now covered by the DEWATS. The improvements made in wastewater management, however, extend beyond this commune, as this large source of water/groundwater pollution to the surrounding area has been eliminated, thus reducing the potential health and environmental risks to nearby citizens and natural life, as well as eliminating the previously foul odor from the noodle processing discharges.

Impacts and Challenges

This project is now underway and is being operated and maintained successfully by the members of the Khac Niem Commune People's Committee. The funding grant was used to cover construction costs, community engagement costs, and initial water quality testing costs. The committee members were trained in appropriate O&M and will take this responsibility. The costs of this O&M and the costs of desludging the system every 2 to 3 years are currently being covered by the funding agency, with O&M averaging about 500,000 VND per month (currently about \$23USD/month).

The water quality testing carried out upon the completion of the project indicates the efficient nature of the DEWATS design. The treated effluent had BOD and COD values (in mg/L) that complied with the national regulations for wastewater effluent discharged into public drainage systems, the standards of which are: COD < 80 and BOD < 50. This compliance should continue given proper O&M and indicates that this project was successful in its objective of treating the wastewater from this commune enough to comply with the standards and result in reduced health and environmental issues in the surrounding area.

Photos



Figure 2. Photos of the commune DEWATS under construction and completed

References

BORDA-Vietnam. (2010). *Technical Data Sheet for Khac Niem Commune*.

UN Vietnam. (2010). *Achieving the MDGs with Equity – MDG 7: Ensure Environmental Sustainability*. From: http://www.un.org.vn/images/stories/MDGs/MDG7_Eng.pdf [Accessed 18 Apr. 2011]

Vietnam
Decentralized Wastewater Treatment Systems for a Private Household in Huu Hoa Commune
A BORDA-Vietnam DEWATS Project in Vietnam

Project Owner(s)	<ul style="list-style-type: none"> ▪ 1) Owner of the private home – Mr. Hau
Project Partner(s)	<ul style="list-style-type: none"> ▪ 1) Funding Agency: Owner of the private home – Mr. Hau; Executing Agency: Owner of the private home – Mr. Hau; Cooperating Agency: Bremen Overseas Research and Development Association – Vietnam (BORDA-Vietnam)
Primary Contacts	<ul style="list-style-type: none"> ▪ Contact: Hanoi@borda-sea.org

Introduction and Background

The Bremen Overseas Research and Development Association (BORDA) has a mission to improve the living conditions of disadvantaged communities and to preserve the environment through decentralized sanitation projects. As part of this mission, the Association has developed modular, decentralized, and cost-effective wastewater treatment service packages that they have termed ‘DEWATS’ – decentralized wastewater treatment systems, which, with the help of funding agencies, are being installed throughout Asia and Africa.

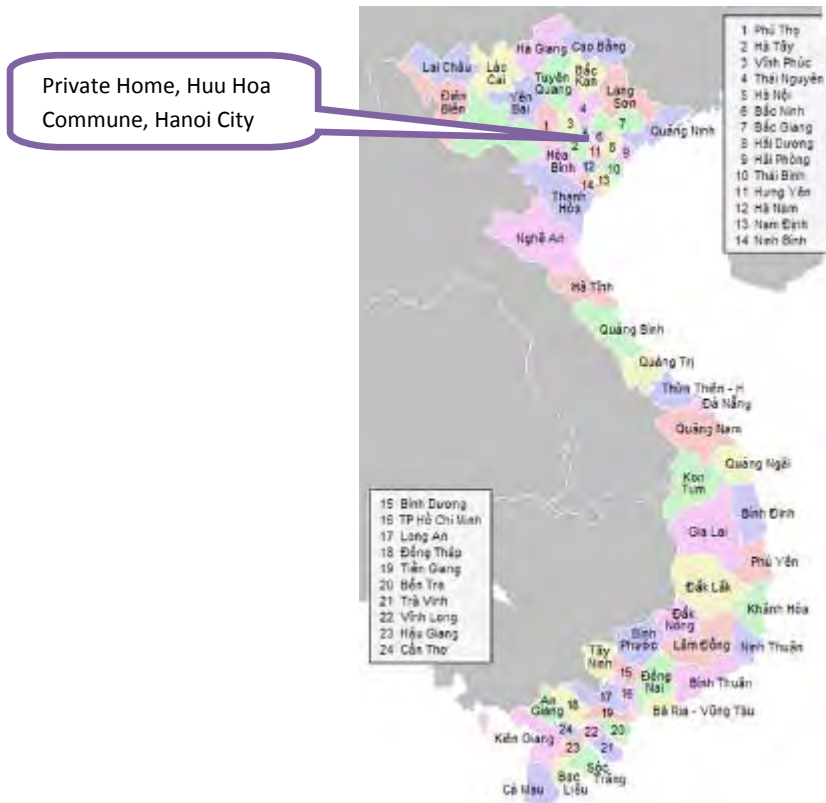

Water and sanitation are one of the most pressing issues facing people in rural Vietnam. Of particular difficulty for sanitation advocates in Vietnam is the habit of using raw feces to fertilize rice fields, with the result of exposing human excreta to the environment. This leads to water and soil contamination and to widespread disease outbreaks. The UN estimated that, in 2010, only 18% of rural households, 12% of rural schools, and 37% of commune health stations had a hygienic latrine that met Ministry of Health standards, which means the country still has a long way to go to achieving 'sanitation for all'.

With this in mind, BORDA established itself in the country in 2001, as BORDA-Vietnam. The Association has completed eight projects in Vietnam to date, one of which is outlined here.

One area chosen for DEWATS was the private household of Mr. Hau, in Huu Hoa Commune, Hanoi City. As one of the thousands of households in Vietnam using only a simple, bottomless septic tank that had never been desludged, this house was not effectively treating its wastewater, with groundwater pollution resulting from the leaching of wastewater from the septic tank. While this single house generates only a small environmental and health risk from its pollution, when this issue is compounded across the thousands of similar households in Vietnam (and elsewhere in Asia), this small problem becomes a major one. Indeed, improperly maintained or constructed septic tanks are one of the biggest issues currently facing the urban sanitation situation of Asian cities.

Project Purpose and Objectives

BORDA's general purpose for the DEWATS projects is to further their goal of "Improved Sanitation for All". Their systems help to fulfill this purpose, which can provide wastewater treatment for domestic or industrial sources and for flows as high as 1000m³ per day, and are tolerant to flow fluctuations, require low maintenance, and are durable. In addition to this general purpose, each project undertaken by BORDA has its own purpose and objectives, based on the problems being experienced by the project site.

For this project, the purpose was mainly to highlight the capability of BORDA's DEWATS technology for very small scale applications, as a pilot project for wider-scale implementation. The project itself had the objective of improving the wastewater treatment capability of this private home, with subsequent reduction in local health and environmental pollution that was occurring.

Partners and Funding Distribution

For this project, the funding agency was the owner of the private house, Mr. Hau, who was also the beneficiary and the executing agency, with BORDA-Vietnam simply providing design consultation. The total project cost was 12 million VND (approximately \$600USD at the time).

Project Activities

This project ran from July, 2010, until December, 2010, with construction beginning in August, 2010. The project activities included: consultation and provision of DEWATS design by BORDA to the homeowner, construction of the DEWATS by the homeowner, connecting the drainage pipes of the home's toilets and wash basins to the DEWATS, and training the homeowner on operation and maintenance.

Sanitation Technology / System

This module of DEWATS used by BORDA-Vietnam consists of the following sections, in order of wastewater flow: septic tank, anaerobic baffled reactor, anaerobic filter, and discharge pipe.

The initial, single chamber, septic tank receives all wastewater from the home for initial settling of solids and some primary degradation of organics by anaerobic bacteria in the tank.

The anaerobic baffled reactor (ABR) is then the main treatment area of the DEWATS. As the name implies, this multi-chambered tank is closed from the air and anaerobic. Wastewater flows slowly up (and back down through pipes) through its several identical chambers, each time entering the chamber at its bottom, where it passes through the accumulated sludge. This allows solids to settle out into the sludge and anaerobic bacteria living in the sludge to degrade much of the harmful organic and chemical components of the wastewater. The number of chambers can vary depending on available land area, wastewater strength, and funds – the ABR for this project has 2 chambers, though 4 or 5 are common for larger projects.

The anaerobic filter (AF) follows the ABR and consists of a tank with a submerged layer of material like crushed gravel or specially formed plastic. On to this media grows a thick layer of anaerobic bacterial biofilm, which the upflowing influent wastewater then passes through. These biofilms help remove more of the dissolved solids in the wastewater, as well as other pathogens and chemicals still remaining in the wastewater. This unit has 2 chambers for this project. The effluent of the home is then considered clean enough for safe discharge to the ground or nearby drainage canal.

For this project, the DEWATS was designed to treat 2m³/day of wastewater. No pumps or chemicals are used at any stage, which lowers O&M costs and maximizes wastewater retention (and thus treatment) time. Desludging is predicted to be needed only once over 3 years.

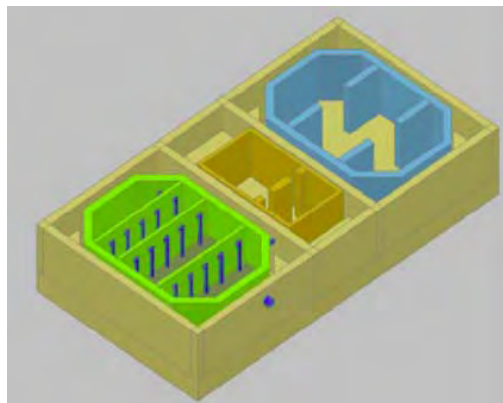

Figure 1. An overhead view of the private home project’s DEWATS, showing the single chambered septic tank, the two chambered ABR, and the two chambered AF

Number, Type, and Location of Beneficiaries

For this project, the wastewater generated from the 6 residents that use the home is now covered by the DEWATS. The improvements made in wastewater management, however, extend beyond this home, as the reduction in wastewater pollution will make a small reduction in the potential health and environmental risks that nearby citizens and natural life were facing from this discharge.

Impacts and Challenges

This project is now underway and is being operated and maintained successfully by the home owner. The aforementioned cost of the project included the construction costs, BORDA consultation costs, and initial water quality testing costs by BORDA. The homeowner was trained in appropriate O&M and will take this responsibility. The costs of this O&M and the costs of desludging the system every 3 years are currently being covered by the homeowner, with no data yet available on the average monthly cost.

The water quality testing carried out upon the completion of the project indicates the efficient nature of the DEWATS design, even for individual homes. The treated effluent had BOD and COD values (in mg/L) that complied with the national regulations for wastewater effluent discharged into public drainage systems, the standards of which are: COD < 80 and BOD < 50. This compliance should continue given proper O&M and indicates that this project was successful in its objective of treating the wastewater from this home enough to comply with the standards, and results in reduced health and environmental issues in the surrounding area.

This project most importantly demonstrated the success and applicability of the DEWATS to individual homes. With an affordable price for middle or upper class homeowners, with effective results, with low maintenance requirements, with a small land area requirement, and with fast construction time, this model project demonstrates the broader applicability of DEWATS for individual homes. Hopefully BORDA will begin promoting this system for more private homes in Asia, as there are many, many more in need of a simple and cost-effective DEWATS like this.

Photos



Figure 2. Photos of the private home's DEWATS under construction

References

BORDA-Vietnam. (2010). *Technical Data Sheet for Project Code 2010.VBOR.SME.2.*

UN Vietnam. (2010). *Achieving the MDGs with Equity – MDG 7: Ensure Environmental Sustainability.* From: http://www.un.org.vn/images/stories/MDGs/MDG7_Eng.pdf [Accessed 18 Apr. 2011]

Vietnam
Decentralized Wastewater Treatment Systems for the Ha Phong Slaughterhouse
A BORDA-Vietnam DEWATS Project in Vietnam

Project Owner(s)	<ul style="list-style-type: none"> ▪ 1) Owner of the Ha Phong Slaughterhouse
Project Partner(s)	<ul style="list-style-type: none"> ▪ 1) Funding Agency: Owner of the Ha Phong Slaughterhouse; Executing Agency: Bremen Overseas Research and Development Association – Vietnam (BORDA-Vietnam) and USAID Eco-Asia
Primary Contacts	<ul style="list-style-type: none"> ▪ Contact: Hanoi@borda-sea.org

Introduction and Background

The Bremen Overseas Research and Development Association (BORDA) has a mission to improve the living conditions of disadvantaged communities and to preserve the environment through decentralized sanitation projects. As part of this mission, the Association has developed modular, decentralized, and cost-effective wastewater treatment service packages that they have termed ‘DEWATS’ – decentralized wastewater treatment systems, which, with the help of funding agencies, are being installed throughout Asia and Africa.

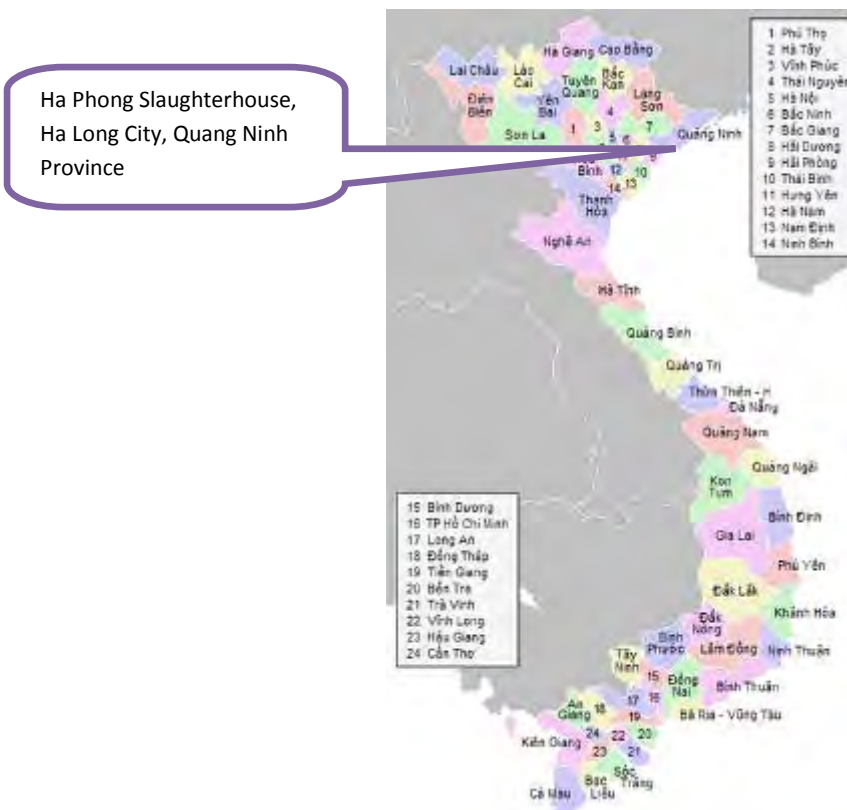

Water and sanitation are one of the most pressing issues facing people in rural Vietnam. Of particular difficulty for sanitation advocates in Vietnam is the habit of using raw feces to fertilize rice

fields, with the result of exposing human excreta to the environment. This leads to water and soil contamination and to widespread disease outbreaks. The UN estimated that, in 2010, only 18% of rural households, 12% of rural schools, and 37% of commune health stations had a hygienic latrine that met Ministry of Health standards, which means the country still has a long way to go to achieving 'sanitation for all'.

With this in mind, BORDA established itself in the country in 2001, as BORDA-Vietnam. The Association has completed eight projects in Vietnam to date, one of which is outlined here.

One area chosen for DEWATS was the Ha Phong Slaughterhouse, in Ha Long City. As a fairly large slaughterhouse in the city, the untreated wastewater that it was producing prior to the project was polluting the surrounding area of the city. The health and environmental risks were high, as slaughterhouse wastewater is more potent than domestic wastewater, and an effective treatment system was therefore needed, especially since Ha Long City sits alongside the world-famous Ha Long Bay tourism area, which is too precious to become polluted.

Project Purpose and Objectives

BORDA's general purpose for the DEWATS projects is to further their goal of "Improved Sanitation for All". Their systems help to fulfill this purpose, which can provide wastewater treatment for domestic or industrial sources and for flows as high as 1000m³ per day, and are tolerant to flow fluctuations, require low maintenance, and are durable. In addition to this general purpose, each project undertaken by BORDA has its own purpose and objectives, based on the problems being experienced by the project site.

For this project, the purpose was to prevent continued pollution of the local environment by slaughterhouse wastewater by installing a DEWATS capable of treating up to 40m³/day of wastewater from the 150 pigs/day and 1000 chickens/day that are being slaughtered there. This had the objective of ensuring that the area around the slaughterhouse would stop being polluted, with subsequent reduction in the health and environmental issues that were occurring.

Partners and Funding Distribution

For this project, the funding agency was the owner of the slaughterhouse, who was also the beneficiary, with BORDA-Vietnam and USAID's Eco-Asia project team being the executing agencies. The total project cost was 600 million VND (approximately \$32,000USD at the time).

Project Activities

This project ran from May, 2007, until May, 2010, with construction beginning in May, 2009. The project activities included: consultation with the staff of the slaughterhouse, construction of the DEWATS, connecting the drainage pipes of the corrals, slaughtering, and butchering areas to the DEWATS, and training the staff on operation and maintenance.

Sanitation Technology / System

This module of DEWATS used by BORDA-Vietnam consists of the following sections, in order of wastewater flow: 2 biogas digesters, settling unit, anaerobic baffled reactor, anaerobic filter, horizontal gravel filter, polishing pond, and discharge pipe.

The biogas reactor is an anaerobic, sealed chamber that serves as a primary settling tank, with relatively fast passage of the liquid effluent through the chamber and digestion of much of the settled sludge by anaerobic bacteria. In this way it is much like a septic tank, except that its sealed nature allows all of the ‘biogas’ – a mixture of methane and carbon dioxide that is released from anaerobic digestion – to be captured and used. Depending on the size of the biogas reactor, this generated gas can be used either for small scale applications like operating a gas stove or larger scale applications like powering the scalding vats of the slaughterhouse. Since most of the organic matter is converted to biogas, sludge production is relatively low. The settled sludge usually remains in the unit for several years and, when removed, is relatively pathogen-free, requiring only some post-composting to ensure sterility. As well, biogas units are climate-friendly, since the generated biogas is offsetting the need for additional gas at the project site. This project uses two biogas reactors in parallel (one for each of the main slaughterhouse buildings) to remove much of the suspended solids and organic compounds from the wastewater, before the two wastewater streams rejoin and move on together to the settling unit. Two smaller biogas units are easier to maintain than a single large unit, which is the reason for the duplication. The biogas is planned on being used for cooking, but it is not yet being generated in high enough quantities to do so, due to the relatively low usage of the slaughterhouse at present.

The next settling unit serves as a wastewater retention point and an area for control of influent fluctuations (an equalization tank), which allows any remaining large sludge, debris, and other floatable/visible wastes to settle or be screened out and also allows a relatively constant flow of wastewater to proceed to the subsequent chambers (rather than having high flows during peak hours and no flow during nighttime). This unit is single-chambered for this project.

The anaerobic baffled reactor (ABR) is then the main treatment area of the DEWATS. As the name implies, this multi-chambered tank is closed from the air and anaerobic. Wastewater flows slowly up (and back down through pipes) through its several identical chambers, each time entering the chamber at its bottom, where it passes through the accumulated sludge. This allows solids to settle out into the sludge and anaerobic bacteria living in the sludge to degrade much of the harmful organic and chemical components of the wastewater. The number of chambers can vary depending on available land area, wastewater strength, and funds – the ABR for this project has 6 chambers, though 4 or 5 are also common.

The anaerobic filter (AF) follows the ABR and consists of a tank with a submerged layer of material like crushed gravel or specially formed plastic. On to this media grows a thick layer of anaerobic bacterial biofilm, which the upflowing influent wastewater then passes through. These biofilms help remove more of the dissolved solids in the wastewater, as well as other pathogens and chemicals still remaining in the wastewater. This unit has 3 chambers for this project.

The horizontal gravel filter (HGF) (synonyms include: planted gravel filter & horizontal constructed wetland) follows the AF and consists of a shallow concrete basin filled with fine gravel, with influent and effluent pipes on opposite ends of the basin. Hardy reed plants, such as Canna, are planted in high density in this gravel layer before the DEWATS becomes operational and are allowed to grow in clean water that is initially flowed through the basin. Once the plants are established, the DEWATS can become operational and introduce the wastewater from the AF into the basin. The plant roots within the gravel help to oxygenate the wastewater, which has been anaerobic to this point and still usually has a noticeable odor, as well as remaining organic compounds. This oxygenation helps to degrade these remaining organic pollutants, which also reduces the odor.

After the HGF, the effluent proceeds to a polishing pond. This pond allows the effluent further aeration and settling time, and can also serve as an indicator for the effluent’s quality. That is, if

surrounding plants or small animals that were living around the pond suddenly die, this indicates a problem in the treatment process. After this pond, the effluent is usually then considered clean enough for safe river discharge.

For this project, this DEWATS was designed to treat 40m³/day of wastewater.

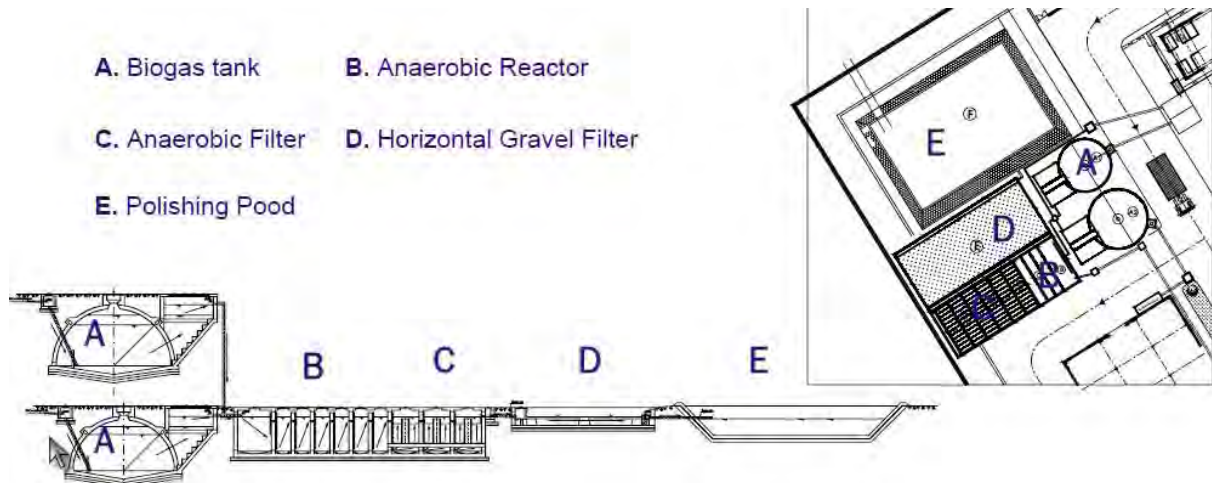

Figure 1. A cross-section and overhead view of the slaughterhouse project's DEWATS, showing the 2 biogas reactors, the 1 chambered settling tank, the 6 chambered ABR, the 3 chambered AF, the HGF, and the polishing pond, as well as influent and effluent piping.

Number, Type, and Location of Beneficiaries

For this project, the wastewater generated from the excrement, blood, trimmings, hair, and other results of the 150 pigs/day and 1000 chickens/day that are slaughtered at this plant are now covered by the DEWATS. The improvements made in wastewater management, however, extend beyond this slaughterhouse, as a strong source of water/groundwater pollution to the surrounding area has been eliminated, thus reducing the potential health and environmental risks to nearby citizens and natural life.

Impacts and Challenges

This project is now underway and is being operated and maintained successfully by the staff members of the slaughterhouse. The funding grant was used to cover construction costs, community engagement costs, and initial water quality testing costs. The staff of the slaughterhouse were trained in appropriate O&M and will take this responsibility. The costs of this O&M and the costs of desludging the system every 2 to 3 years are currently being covered by the slaughterhouse owner, with O&M averaging about 200,000 VND per month (currently about \$10USD/month).

The water quality testing carried out upon the completion of the project indicates the efficient nature of the DEWATS design. The treated effluent had BOD and COD values (in mg/L) that complied with the national regulations for wastewater effluent discharged into public drainage systems, the standards of which are: COD < 80 and BOD < 50. This compliance should continue given proper O&M and indicates that this project was successful in its objective of treating the wastewater from this slaughterhouse enough to comply with the standards, and results in reduced health and environmental issues in the surrounding area.

Photos



Figure 2. Photos of the slaughterhouse DEWATS under construction

References

BORDA-Vietnam. (2010). *Technical Data Sheet for Ha Phong Slaughterhouse*.

Spulher, D. (2010). *Biogas Settlers*. From: <http://www.sswm.info/category/implementation-tools/wastewater-treatment/hardware/semi-centralised-wastewater-treatments/b>
[Accessed 18 Apr. 2011]

UN Vietnam. (2010). *Achieving the MDGs with Equity – MDG 7: Ensure Environmental Sustainability*. From: http://www.un.org.vn/images/stories/MDGs/MDG7_Eng.pdf
[Accessed 18 Apr. 2011]

Vietnam
Decentralized Wastewater Treatment System for Lai Xa – Kim Chung Commune
A Youth with a Mission – Mercy, Relief, and Development Asia Project in Vietnam

Project Owner(s)	<ul style="list-style-type: none"> Residents of Lai Xa Hamlet – Kim Chung Commune
Project Partner(s)	<ul style="list-style-type: none"> Funding Agencies: Youth with a Mission – Mercy, Relief and Development Asia (YWAM-MRDA) and Kim Chung Commune People’s Committee Executing Agency: YWAM-MRDA & Kim Chung Commune People’s Committee
Primary Contacts	<ul style="list-style-type: none"> Dr. Viet Anh Nguyen, Hanoi University of Civil Engineering, vietanhctn@gmail.com

Introduction and Background

As Asian cities grow and develop, so too do the peri-urban areas surrounding these cities, where rural and urban aspects both play a role in the daily lives of citizens in these areas. However, these peri-urban areas often go largely unrecognized by city policymakers, who place emphasis on the urban city center for their development planning. This has resulted in some of these peri-urban areas gathering the ‘defects’ of development, such as large, polluting industries, landfills, and a lack of some of the essential infrastructure present in the city center, such as piped water or sewerage.



This was the case in Lai Xa Hamlet of the Kim Chung Commune, a peri-urban commune of the Hanoi Capital District. With a population of 4000 in 855 households, a per capita GDP of \$129, and located 15km west from the city center in the Red River delta region, the area was traditionally agricultural, but is experiencing rapid industrialization as fields are sold off for expanding Hanoi industry. As a result, the environmental conditions of the area were poor, with no systems in place to manage solid or liquid waste. The few public drains that existed were blocked with rubbish, resulting in flooding on rainy days, there was rubbish strewn throughout the hamlet, and all stormwater and household wastewater drained directly to nearby marshes, ponds, and fields. This was causing health problems for the workers in the fields, promulgating diseases such as mosquito-carried dengue, and polluting the natural environment. The rapid industrialization could only be expected to make things worse.

Recognizing this problem and having been on the ground in Kim Chung Commune since 2001, the NGO Youth with a Mission – Mercy, Relief and Development Asia (YWAM-MRDA) began funding and executing a solid waste management and sanitation program in the hamlet in 2003 that ran until 2009, in partnership with the Kim Chung Commune People’s Committee. The project involved community IEC (Information, Education, Communication) campaigns on solid and liquid waste management, capacity building for sanitation, and the installation of decentralized wastewater treatment systems (DEWATS) throughout the hamlet.

Project Purpose and Objectives

This project in Lai Xa had two sub-projects: a solid waste management project and a liquid waste management project. The liquid waste project in turn had three components: 1) a training of trainers on sanitation issues and solutions, 2) an awareness-raising IEC campaign, and 3) construction of decentralized drainage and treatment systems. The purpose of these tasks was to: 1) ensure solid waste would be more properly disposed and not clog the forthcoming wastewater systems, 2) build capacity for sanitation, and 3) demonstrate a workable small-scale decentralized sanitation project in a low income area of Vietnam. This had the objectives of: 1) improving practices and creating behavior change on hygiene, sanitation, and solid waste activities, 2) innovating in technology design for wastewater treatment, and 3) improving local management capacities. As well, the installed DEWATS would immediately help to prevent continued pollution of the local environment by treating the wastewater generated by the hamlet, with users helping to pay for its installation and operation.

Partners and Funding Distribution

This was a very small-scale project by the NGO, with low financial contributions by the NGO compared to similar projects by other groups. As well, the NGO limited its contributions to 50% of the total direct project costs, while the 50% was raised from the Lai Xa community and the Kim Chang People’s Committee. No other NGOs or higher level government agencies assisted in this project, YWAM-MRDA was the main executing agency.

Project Activities

This project ran from 2003 until 2009, with the solid waste management portion of the project running in 2003 and 2004 and the liquid waste management portion beginning at the start of 2005.

For the solid waste management portion, activities included various IEC campaigns and training sessions on the environmental and health effects of improperly disposed solid waste, followed by the formation and training of an environmental workers group to single-handedly operate waste

collection and all O&M. Households were trained on organic and inorganic waste separation and the hamlet provided land for a landfill and composting area. A 10,000VND (\$0.50USD) per month O&M fee was then implemented on the participating households for this solid waste service.

For the liquid waste management portion, the first activity was to carry out trainings on the causes, effects, and consequences of liquid waste and sanitation to a selected core group of 50 villagers, who would then act as trainers to the rest of the Lai Xa community on these issues, with the trainers strategically selected so as to reach up to 90% of the population through second teaching. The second activity was a wide IEC campaign by the NGO to raise awareness of the local leaders and villagers on liquid waste management and sanitation. These two IEC activities urged villagers to, amongst other things, improve their individual toilets, drainage, and septic tanks, undertake better personal hygiene, connect their homes to the common drainage system and improve it with a screen/grid chamber, and to install a simple filter for their well water or else use rain water for drinking/washing. The third activity was the construction of the decentralized drainage and treatment systems for the hamlet. This involved creation of a local construction supervision committee, decision on the technology, fundraising by the community for the technology, and construction of the treatment plants and common drainage system. The committee members and environmental workers group (also handling the solid waste) were trained for O&M on this system and are also supporting constructions of domestic septic tanks by residents. A 6,000VND (\$0.30USD) per year O&M fee was then implemented on the participating households for this sanitation service.

Sanitation Technology / System

The technology package implemented by this project consists of the following sections, in order of wastewater flow: gravity-fed sewers and drainage canals, five 'wastewater treatment stations' consisting of: primary settling unit, anaerobic baffled reactor, and anaerobic filter, with effluent then draining, depending on the specific station, to one of two waste stabilization ponds and vegetated horizontal rock flow filters or directly to an improved irrigation canal.

The gravity-fed sewer line proposed by the project consisted of piping and open canals installed for each connected household to carry its septic tank effluent and greywater to the DEWATS. Using no pumps or other machinery along its length, the sewer pipes must constantly slope downward, which can lead to problems in uneven terrain or if a particular septic tank or other effluent pipe is located vertically below the trunk sewer line it is supposed to connect to, meaning that careful design of the layout is crucial. To prevent high inputs of water flow into the following components during rainy season, a number of overflow areas were installed along the network's length. The prior solid waste management program of the community and IEC on installing screens for solid waste to each household's connection piping will help minimize clogging of the DEWATS.

The primary settling unit serves as a wastewater retention point and an area for control of influent fluctuations (an equalization tank), which allows any large sludge, debris, and other floatable/visible wastes to settle or be screened out and also allows a relatively constant flow of wastewater to proceed to the subsequent chambers (rather than having high flows during peak hours and no flow during nighttime). There are five of these single-chambered units for this project.

The anaerobic baffled reactor (ABR) is then the main treatment area of the DEWATS. As the name implies, this multi-chambered tank is closed from the air and anaerobic. Wastewater flows slowly up (and back down through pipes) through its several identical chambers, each time entering the chamber at its bottom, where it passes through the accumulated sludge. This allows solids to settle out into the sludge and anaerobic bacteria living in the sludge to degrade much of the harmful

organic and chemical components of the wastewater. The number of chambers can vary depending on available land area, wastewater strength, and funds – this project uses five 5-chamber ABRs.

The anaerobic filter (AF) follows the ABR and consists of a tank with a submerged layer of material like crushed gravel or specially formed plastic. On to this media grows a thick layer of anaerobic bacterial biofilm, which the upflowing influent wastewater then passes through. These biofilms help remove more of the dissolved solids in the wastewater, as well as other pathogens and chemicals still remaining in the wastewater. These units follow each of the 5 ABRs.

The waste stabilization ponds with vegetated horizontal rock flow filters then follow for three of the five wastewater treatment stations. This pond allows the effluent to aerate (it had been anaerobic up to this point and usually still has a foul odor) and provides further settling time, and can also serve as an indicator for the effluent’s quality. That is, if surrounding plants or small animals that were living around the pond suddenly die, this indicates a problem in the treatment process. Aeration allows the anaerobic odor of the wastewater to dissipate and aerobic bacteria living in the pond to further degrade remaining organic compounds. The vegetated horizontal rock flow filters do this even further, with the plant roots among the rocks also helping to oxygenate the wastewater.

For the two other wastewater treatment stations (as well as the previously mentioned three, after the ponds) the effluent then flows out to irrigation canals, for its use in nearby fields. The canal receiving effluent from four of these stations was also improved with the planting of aquatic plants along its length, which, like the plants in the waste stabilization ponds, help to oxygenate the wastewater and degrade remaining organic compounds. At this point, while still not safe for drinking, the effluent is ideal for use in irrigation and fertilizing.

For this project, this DEWATS was designed to treat the wastewater of approximately 400 households of Lai Xa, with each wastewater treatment station able to treat the wastewater of about 80 households.

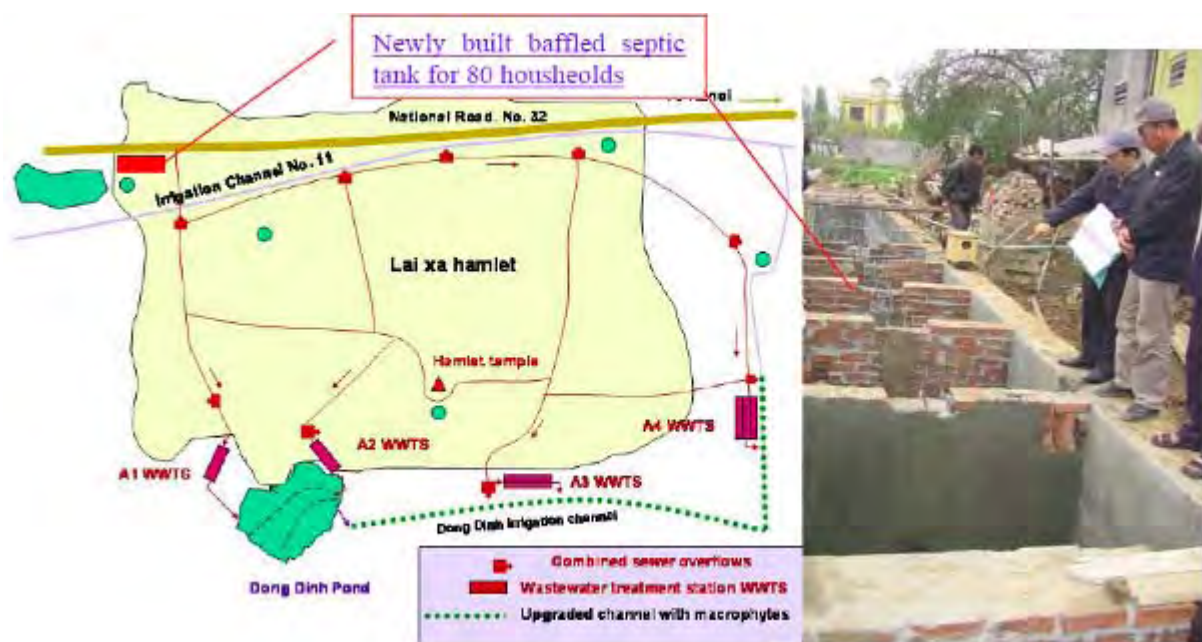

Figure 1. Schematic of the project’s gravity-fed sewer lines, DEWATS, and output, as well as a photo of one of the primary settling unit / ABR / AF tanks under construction

Number, Type, and Location of Beneficiaries

Because of the long term nature of this project, as well as its heavy focus on IEC and training activities, it is difficult to quantify the number of beneficiaries of the project. It is likely that a majority of the villagers had at least some knowledge gained from the activities, with many contributing to the success of both the solid waste and liquid waste projects' activities through the personal actions they took, whether it was to properly segregate their wastes, install a new septic tank or toilet, or just practice better personal hygiene. The 50 trainers that were trained and the various committees that were formed benefitted even more directly by gaining additional employment and responsibilities in their communities.

For the DEWATS portion of this project, the wastewater generated from the domestic use of the 400 households (once all are eventually connected, which is ongoing) is now covered by the DEWATS, thus reducing the potential health and environmental risks of this wastewater to nearby citizens and natural life.

Impacts and Challenges

This project is now underway and is being operated and maintained successfully by the members of the Kim Chang Commune People's Committee as well as the local environmental workers group and the villagers themselves. The variety of IEC activities undertaken in this project lead to a number of positive impacts on the hamlet. For example, a mid-project hygiene survey of a sample of 10 villagers on their perceived changes to several hygiene practices in the community over the previous 5 years (including hand washing with soap, wastewater disposal, and solid waste disposal) showed that the villagers felt the situation had "improved a lot" or had made "some improvements". They did not judge anything to have remained stable or worsened. As well, thanks both to the project and other developments made in the area over the same period, a similar survey done on the village health workers found significant decreases in previously common diseases of poor hygiene, such as skin infections, worms, diarrhea, and dengue, dropping in frequency anywhere from 20 to 80%.

The project also gained infrastructural results. In a 5 year period, the percentage of hamlet households with access to a shower and hygienic toilet (of composting or pour-flush nature) went from 25 to 60%. With IEC also performed on the unhealthy presence of iron and ammonia in the Lai Xa groundwater, over 80% of the households now use collected rainwater for drinking and cooking, which betters their own health and helps the groundwater aquifer to recover. Those not harvesting rainwater have adopted slow sand filters to lower the levels of iron and ammonia. As well, all new toilets being built in the village are being equipped with properly designed septic tanks (with the help of the village committees), and most households also agreed to improve their wastewater drain with a screen and grid chamber. Households are being continuously connected to the DEWATS, with a targeted connection rate for the hamlet of 70%. These improvements, paid for solely by the villagers and People's Committee (not by the NGO), have been successful not only because the IEC activities increased their passion and willingness to pay for these improvements, but also because many of the villagers had some available cash and were already undertaking home improvements. This was often because the rapid industrialization of the area meant they had recently sold off some of their agricultural fields to developers.

As to the DEWATS itself, the system technology was introduced by a technical consultant from the Hanoi University of Civil Engineering and is operating successfully. There have not been issues with water quality as of yet, since the ABR/AF system itself is able to remove 70-80% of BOD, COD, and TSS, with further reductions occurring in the pond and vegetated filters and irrigation canals. This compliance should continue given proper O&M and indicates that this component was successful in

its objective of treating the wastewater from this commune enough to result in reduced health and environmental issues in the surrounding area. Together with the other liquid and solid waste management IEC activities conducted, this project overall created a good sanitation foundation in Lai Xa, a neglected peri-urban area, that will be able to be expanded both into the Kim Chung commune itself as well as in similar areas across Southeast Asia.

Photos



Figure 2. Community engagement: Photos of the local construction committee supervising the drainage canal installation, as well as the training of trainers activity for IEC on sanitation



Figure 3. The decentralized management scheme used by the NGO in Lai Xa

References

- Beausejour, J. and Nguyen, A. V. (2007). "Decentralized sanitation implementation in Vietnam: A peri-urban case study". *Water Science & Technology*, 56(5): 141-148.
- Beausejour, J. and Nguyen, A. V. (2007). "Decentralized sanitation implementation in Vietnam: A peri-urban case study". Prepared for: *Advanced Sanitation Conference*, 12-13 March, 2007, Aachen, Germany.
- Beausejour, J., Nguyen, D. X., & Nguyen, A. V. (2006). "Public participation and improved households practices in a small sanitation project in Lai Xa, Vietnam". Prepared for: *32nd WEDC International Conference*, Topic Heading: *Sustainable Development of Water Resources, Water Supply and Environmental Sanitation*, 13-17 Nov., 2006, Colombo, Sri Lanka.

Vietnam
Biogas Digesters for Vietnamese
A Multi-Partner National Biodigester Program in Vietnam

Project Owner(s)	<ul style="list-style-type: none"> ▪ Farmers who purchase biodigesters from the program
Project Partner(s)	<ul style="list-style-type: none"> ▪ Funding Agencies: Dutch Directorate General for International Cooperation (DGIS); small amounts of local funding from involved provincial governments ▪ Executing Agencies: Department of Livestock Production (DLP) of the Ministry of Agriculture and Rural Development (MARD) & SNV Vietnam, via an established Biogas Project Division (BPD), with Provincial Biogas Project Divisions (PBPD) staffed by provincial Departments for Agriculture and Rural Development (DARD) and their Agricultural Extension Centers (AEC) ▪ Cooperating Agencies: ETC Foundation (Promotion & marketing support), local governments of the selected program provinces (58 provinces), trained mason groups (as private sector companies), Vietnam Postal Service (for subsidy disbursement)
Primary Contacts	<ul style="list-style-type: none"> ▪ Program Website: www.biogas.org.vn; Program Email: bpovn@biogas.org.vn

Introduction and Background

Water and sanitation are one of the most pressing issues facing people in rural Vietnam. Of particular difficulty for sanitation advocates in Vietnam is the habit of using raw feces to fertilize rice fields, with the result of exposing human excreta to the environment. This leads to water and soil contamination and to widespread disease outbreaks. The UN estimated that, in 2010, only 18% of rural households, 12% of rural schools, and 37% of commune health stations had a hygienic latrine that met Ministry of Health standards, which means the country still has a long way to go to achieving ‘sanitation for all’.

For the many rural Vietnamese who work in agriculture – many of whom have no access to electricity, use collected fuelwood for cooking, and rely on expensive fertilizers or risky raw animal manure to fertilize their fields – all of these disparate challenges can be addressed in a single solution: the biogas digester. The biogas digester is a simple, but powerful, sanitation technology option that can simultaneously: process human & animal feces into safe and free fertilizer; reduce groundwater contamination by processing feces instead of having it be discharged untreated; create biogas for use in cooking and household lighting, thus reducing need for fuelwood and allowing more night-time activities; empower women and families by reducing their time spent on fuelwood gathering and cooking; reduce indoor air pollution by reducing the need for fuelwood burning; and help eliminate the need for fossil fuel-based cooking gas and the CO₂ emissions created during fermentation of openly-discharged sewage, thereby helping to reduce the threat of climate change and potentially creating carbon offset credits for sale to industrialized countries.

Recognizing the power of this technology and its usefulness to rural Vietnamese, the Vietnamese Ministry of Agriculture and Rural Development (MARD), through its Department of Livestock Production (DLP), joined with the Netherlands, through the Dutch Directorate General for International Cooperation (DGIS) and their development agency, SNV, to create a National

Biodigester Program for Vietnam, so as to disseminate biodigester technology – using marketing techniques and grant assistance – to farmers in selected Vietnamese provinces.

Provinces of Focus: *Phase I – 12*

Initial Provinces: Bac Ninh, Hai Duong, Ha Noi, Lang Son, Thai Nguyen, Hoa Binh, Nghe An, Thua Thien Hue, Binh Dinh, Dac Lac, Dong Nai, & Tien Giang

Phase II – Currently 43 Provinces (Goal: 58): An Giang, Ba Ria Vung Tau, Bac Giang, Bac Lieu, Bac Ninh, Ben Tre, Binh Dinh, Can Tho, Dak Lak, Dong Nai, Gia Lai, Ha Nam, Ha Noi, Ha Tinh, Hai Duong, Hai Phong, Hau Giang, Hoa Binh, Hung Yen, Khanh Hoa, Kien Giang, Lam Dong, Lang Son, Lao Cai, Long An, Nam Dinh, Nghe An, Ninh Binh, Phu Tho, Quang Nam, Quang Ngai, Quang Ninh, Son La, Thai Binh, Thai Nguyen, Thanh Hoa, Thua Thien Hue, Tien Giang, Tra Vinh, Tuyen Quang, Vinh Long, Vinh Phuc, Yen Bai



Project Purpose and Objectives

This project had the purpose of establishing a permanent domestic biodigester sector on a commercial, market-oriented basis for the dissemination of biodigesters as an indigenous, sustainable energy source in selected provinces in Vietnam. Its overall objective is to improve the livelihood and quality of life of rural farmers in Vietnam through exploiting the economic and non-economic benefits of domestic biogas, exploiting effectively biogas technology and developing a commercially viable biogas sector in Vietnam. Already in its second phase, the program's current objectives by 2012 are: 1) to increase the number of family-sized, quality biodigesters to 164,000 units in 58 provinces; 2) to reduce workload for women (from fuelwood gathering) by 109 million hours per year (1.8 hours per day); 3) to increase the amount of livestock grown at 67% of the biodigester households; 4) to save between 10-14 Euros per month on reduced fuel/household costs for 65% of the 164,000 purchasing households; 5) to increase crop yields by 5-20% for farming households due to the use of the effluent bio-slurry as a fertilizer and saving on chemical fertilizer costs; 6) establishing 1,200 mason teams of 5-7 people who will act as small businesses to sell and locally construct biodigesters, thereby also creating thousands of man-hours of employment; 7) create 1.5-3 tonnes of CO₂ equivalent per year per digester of tradable emission rights; 8) have at least 75,000 of the units sold include a personal toilet attachment; 9) establish clean farms with no animal dung pollution; and 10) increase health of the families through better hygiene and sanitation from the better treatment of feces.

Partners and Funding Distribution

For this project, the main funding agency is the DGIS, through their Asia Biogas Program, with small amounts of additional funding and in-kind assistance coming from the national government and provincial governments of the project provinces, with funds going towards program establishment and maintenance, IEC activities, and a flat rate subsidy of 1 million VND (~\$50 USD) on the cost of the biodigesters for farmers who purchase and have one constructed through the program. The main executing agencies are the MARD-DLP – as the program owner and coordinating agency – and SNV – as the main technical assistance and planning agency. These groups consolidate in a national Biogas Project Division (BPD), which gives project direction and guidance to Provincial Biogas Project Divisions (PBPD) that are established in each participating province and are staffed by the provincial Departments for Agriculture and Rural Development (DARD) and their Agricultural Extension Centers (AEC). These PBPDs subsequently carry out the ‘on-the-ground’ work of training masons to sell and construct biodigesters, carrying out local IEC activities, channeling the program’s financial subsidy to purchasers upon successful purchase and construction of a biodigester unit, and liaising generally with the rural consumers. The cooperating agencies for this project include: 1) the local commune councils and provincial governments of each selected and participating province; 2) the trained mason groups of the program, called ‘biogas construction teams’ (BCTs) who are selling, constructing, and maintaining the biodigesters on the local level; 3) a Dutch capacity-building NGO called the ETC Foundation, which is assisting with promotion and marketing activities; and 4) the Vietnam Postal Service, which was selected to handle the delivery and disbursement of completed biodigester subsidies, as well as the associated paperwork. Originally the Vietnam Bank for Agriculture and Rural Development was planned for accomplishing this task, but surveys of the rural consumers found that they thought it overly tedious to visit the bank and complete the larger amount of required paperwork, so the option of direct subsidy delivery by the Post Office and lesser paperwork for the consumers was implemented instead.

The total investment in this program is substantial, at approximately 44.8 million Euros. About 6 million Euros of this is cash funding from the ODA grant of the Netherlands DGIS, while about 1 million of it is for the technical assistance from SNV. About 4 million comes from the selected provincial governments, while most of the remainder comes from the sales of the biodigesters by the rural farmers.

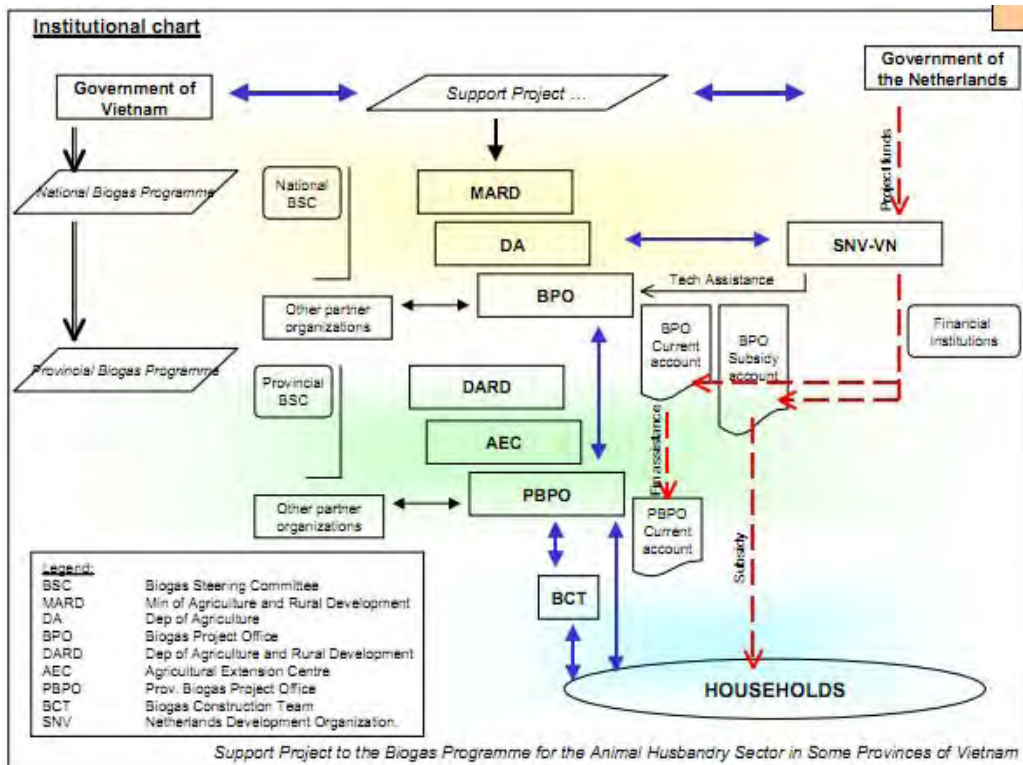

Figure 1. The overall institutional organizational chart for the program. Note that the depicted National and Provincial Biogas Steering Committees were never actually created, management rests simply in the BPD and PBPD (the names of these were originally, as depicted, BPO and PBPO).

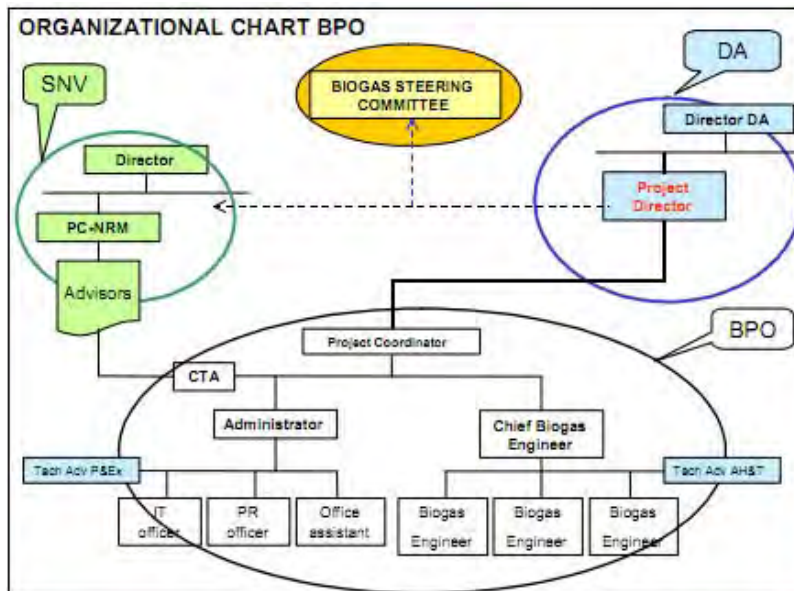

Figure 2. The organizational chart for the BPD (formerly known as BPO). Note again that the depicted Biogas Steering Committee was never created.

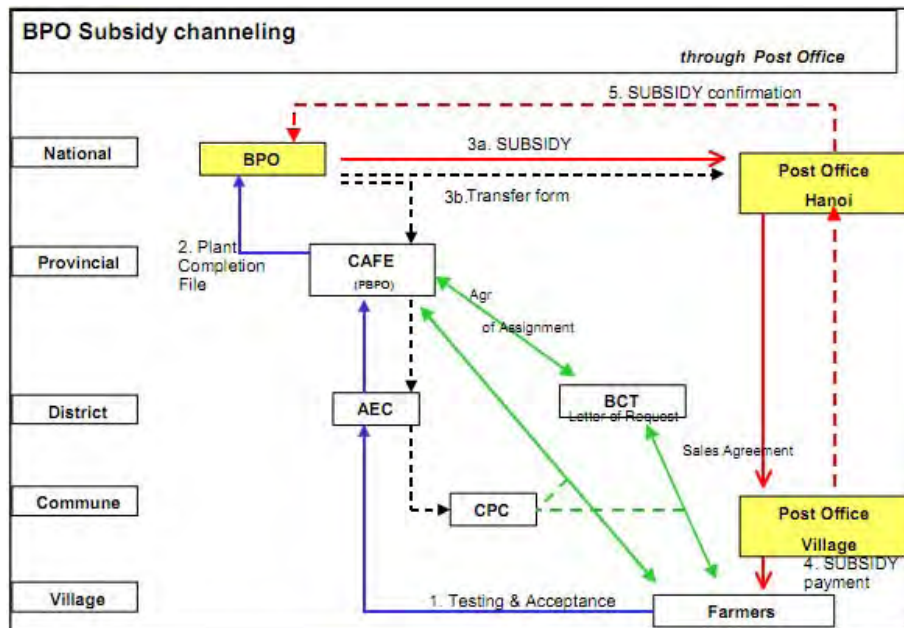

Figure 3. The flow chart depicting the process of subsidy channeling from the BPD to the farmer, upon successful completion of the purchase and construction of a biodigester

Project Activities

This project began in January 2003 and is still ongoing and in its second phase, having been renewed in 2006 and 2007 to last at least until 2012. The project activities, in general fall into one of the following 6 components: 1) trainings and workshops, for capacity building of stakeholders, including government staff, masons, and farmers through technical / user / managerial trainings, through ‘training of trainers’ and subsequent training activities; 2) promotion and marketing, to create awareness and raise interest in farmers to purchase a biodigester through the production and use of various IEC (information, education, communication) materials; 3) quality management, to ensure long-term program success by implementing and following quality control processes for supervisors of construction and offering regular technical assistance to farmers should problems arise with an installation; 4) bio-slurry management and promotion, to promote the use of biodigester effluent as a fertilizer among purchasing farmers, by carrying out field trips and research and creating promotional IEC on proper bio-slurry usage to distribute to farmers; 5) research and development, to continually adapt or improve the biodigester technology being promulgated by the program and improving standardizations, performance, and construction techniques; and 6) institutional support, to create market supply for biodigesters by training local masons and technicians to form biogas construction teams (BCTs), who informally (i.e. they are not registered as professional companies or businesses) carry out sales, construction, and maintenance activities for the program on the local level in each selected province. The majority of the ‘on-the-ground’ work is being done by the PBDs and BCTs groups, which include the promotion and marketing activities, investigation for potential users, sales, registration and assistance to purchasers, quality control, local trainings, and database management and reporting. The BPD is responsible for more of the general IEC activities and marketing, the research and development, the financing activities, and overall reporting on and management of the program.

Sanitation Technology / System

The biogas reactor is an anaerobic, sealed chamber that serves as a primary settling tank, with relatively fast passage of the liquid effluent through the chamber and digestion of much of the

settled sludge by anaerobic bacteria. In this way it is much like a septic tank, except that its sealed nature allows all of the ‘biogas’ – a mixture of methane and carbon dioxide that is released from anaerobic digestion – to be captured and used. Since most of the organic matter is converted to biogas, sludge production is relatively low. The settled sludge usually remains in the unit for several years and, when removed, is relatively pathogen-free, requiring only some post-composting to ensure sterility. As well, biogas units are climate-friendly, since the generated biogas is offsetting the need for additional gas at the project site.

The biogas reactors built for this project are of the ‘fixed dome’ type with two varieties being promoted, the KT.1 model and KT.2 model, both with an inlet mixing chamber, where animal manure can be mixed with water to allow its flow into the unit, the main chamber, where the anaerobic fermentation and biogas production takes place, and the raised outlet area, where the liquid effluent and sludge is gradually discharged through the pressure exerted on the liquid by the accumulating biogas. This outlet can be connected to further treatment processes, such as an anaerobic baffled reactor/anaerobic filter unit, though for this program, effluent sludge, termed “bio-slurry” here, is simply being collected and disposed of or – the preferred option – used as fertilizer in the agricultural practices of the farmers. These models allow for digesters to be constructed in various different volumes (the most popular ranging between 6 – 12m³), and different gasholder:digester volume ratios, which adjust the retention time of the liquid in the unit, depending on the local climate. The main difference between the two models is that KT.2 uses a conical, rather than flat bottom, making the unit more resistant to upward forces of high groundwater tables. This is useful in low elevation / flood-prone areas like the Mekong Delta of southern Vietnam.

It makes sense for farmers to reuse the bio-slurry on their fields. It is odorless and does not attract insects; it in fact repels termites when applied on fields, whereas raw manure attracts them, which can subsequently damage plants. Bio-slurry also helps reduce weed growth by about 50%, whereas raw manure on fields can increase weed growth from the sprouting of the undigested weed seeds in the feces. As well, the overall levels of the fertilizing nutrients Nitrogen, Phosphorus, and Potassium are all present at higher levels than in raw manure and the nitrogen is in a form that is easier for plants to absorb than the form it is in when it is a component of raw manure. Reuse of the slurry also ‘closes the loop’ on the cycle, so that no product of the process is wasted, as in Figure 2. Most importantly, it is free and can both help reduce the need for costly synthetic fertilizers and reduce the sanitation and health risks generated from working with raw manure.

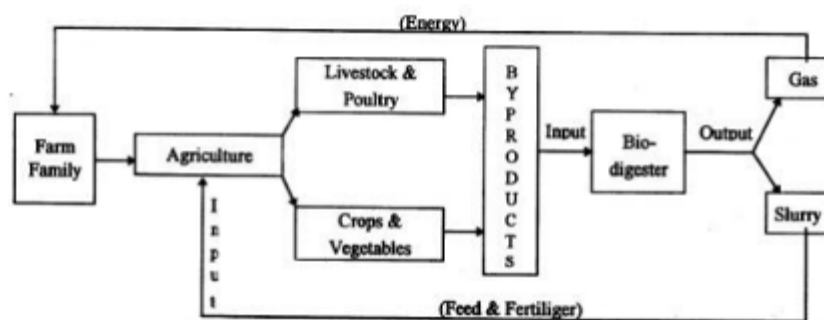

Figure 2. The relationship between a biodigester and agriculture for a farming family

Depending on the size of the biogas reactor, this generated gas can be used either for small scale applications like operating a gas stove or light, or larger scale applications like powering the scalding vats of a slaughterhouse. Some typical sizes of fixed-dome biodigesters and their daily requirements of dung and mixing water input (for optimal biogas generation), and the resulting length of time that the optimal volume of daily generated biogas is able to power a stove or lamp are all illustrated in

Table 1, as is the volume of initial input dung needed before biogas production will reach its optimal level.

Table 1. Typical Fixed Dome Biodigester Characteristics

Biodigester size	Initial Feeding (cattle dung or pig manure)	Daily dung feeding (kg)	Water to mix with dung (litre)	Use of Biogas Stove (hour)	Use of Biogas Lamp (hour)
4	1500	20-40	20-40	3.5 to 4	8-10
6	2300	40-60	40-60	5.5 to 6	12-15
8	3000	60-80	60-80	7.5 to 8	16-20
10	3800	80-100	80-100	9.5 to 10	21-25
15	6000	100-150	100-150	10 to 15	25-32

The biodigester can be appropriately sized by calculating the number of animals the farming family owns, and, if they also connect their personal toilet to the unit (which is encouraged for sanitation purposes), the number of family members using the toilet. For example, the average cow generates 10-15kg of manure per day, while water buffalos generate 15-20kg/day, pigs generate 2-4kg/day, chickens generate 0.02-0.03kg/day, and humans generate 0.18-0.34kg/day.

The total costs of the different sizes of biodigester offered by the program average between 2.5 to 3.5 million VND (~\$150USD), with a 1 million VND (~\$50USD) subsidy provided by the program to each purchaser on the completion of construction. However, it has been observed that many farmers who purchase a biodigester are taking the opportunity to also upgrade their stables/kitchen/latrine, which is often increasing their investment to between 6 to 10 million VND (\$300-500USD).

While these costs sound high for poor rural Vietnamese farmers, the economics of using free biogas instead of fuelwood/charcoal/LPG/kerosene help to provide a fast payback period of less than 2 years, and therefore a strong incentive to buy.

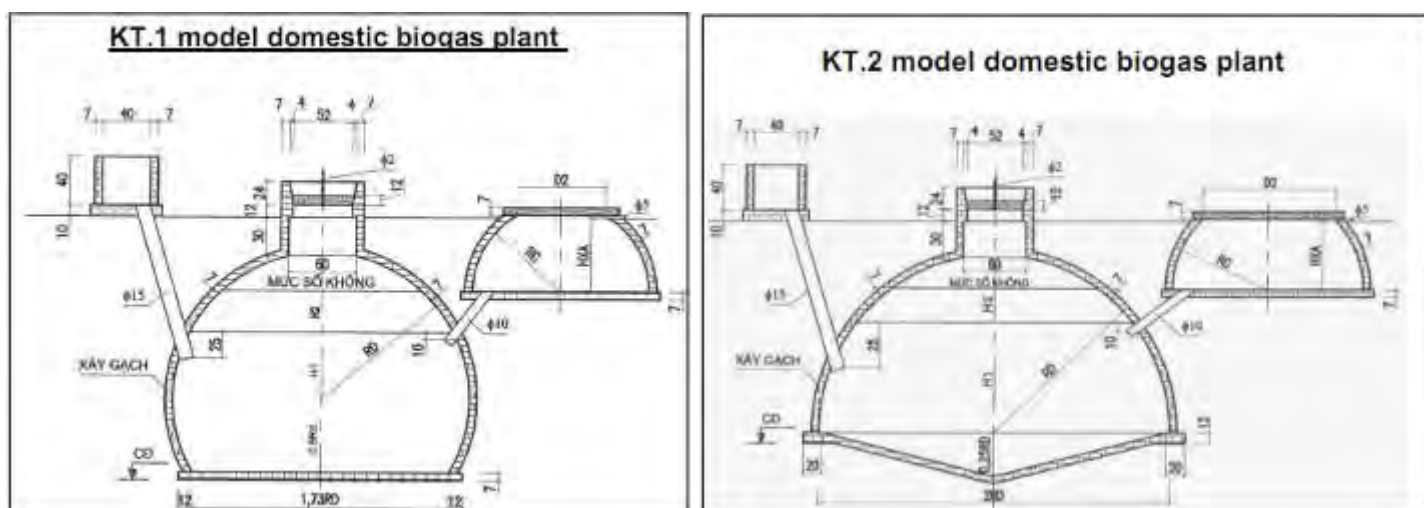

Figure 3. The standard KT.1 and KT.2 models of the fixed-dome biodigesters being implemented by the program, including a mixing tank (for mixing the dung with water), an inlet pipe (or pipes, if the toilet is also connected), the digester and gas generation area, the outlet slurry tank, and the gas pipe out the top.



Figure 4. A biogas digester under construction by one of the program BCTs

Number, Type, and Location of Beneficiaries

This project turns ‘beneficiaries’ into ‘buyers’. Since there is only a partial hardware subsidy on the product, every farmer who decides to purchase one of these biogas digesters is using their own funds, which empowers them and ensures they will take better care of their system than if it was just given to them free of charge. In terms of the number of units sold, and therefore the number of Vietnamese who now are better managing the wastes of their animals – and, to date, in about 48% of cases, themselves as well, through the connection of their personal toilet to the unit – the program has sold, as of January, 2011, 103,000 units across 43 of the targeted 58 provinces.

Since the average Vietnamese family size is 5 persons, this means that approximately 500,000 Vietnamese are already benefitting from these biogas digesters, with up to 800,000 benefitting if the goal of 164,000 sales is reached. As mentioned, since approximately 48% of these biogas digesters have the toilet attached as well, this means that about 250,000 Vietnamese are also benefitting from improved personal sanitation and reduced risk of groundwater contamination or illness. As well, the program has provided training to over 718 biogas digester technicians and 1302 biogas digester masons since 2003, 76% and 84% of who, respectively, are still active in the program, which is providing these locals with stable and prosperous livelihoods.

Impacts and Challenges

While this program is still underway, its results to date have nevertheless been substantial. As mentioned, 103,000 biogas digester units (with the most commonly sold sizes being between 6 – 12m³) have already been sold, benefitting over 500,000 Vietnamese. While this value is still approximately 61,000 units away from the fast-approaching 2012 goal of 164,000 units sold, sales are continually growing as more new masons are trained and more provinces join the program, which should allow monthly sales volumes to continue growing.

Even if the sales fall short of the goal, having sold 103,000+ biogas digesters and established a comprehensive management framework for their sales and maintenance, including businesses, subsidies, marketing and promotions campaigns, trainers, technical designers, researchers, and the various levels of managing administration is an impressive feat that ensures the long-term sustainability of the demand for and supply of biogas digesters in Vietnam, as well as their long-term operation and proper maintenance. Indeed, an important result to date is that, from local monitoring, 99% of all biogas digesters sold are still operational, which shows both the effectiveness

of the quality control measures implemented for construction and also on the availability of the local PBPDs and BCTs to address any maintenance issues that may arise.

As well, about 55% of the units sold (as of 2006) are making use of the bio-slurry produced by the digester for fertilizing the owner's agriculture, which is improving the lives of these farmers by reducing their need for costly synthetic fertilizers and eliminating the health, groundwater, termite, and weed risks to the farmer that were previously brought about by using raw manure as a direct fertilizer. Of equal importance is that 48% of units sold, as of 2011, have a personal toilet attached as well, which is currently exceeding the 2012 target of having about a 45% connection rate (with a goal of 75,000 toilets connected for the 164,000 units sold). This means that the units are improving local sanitation both by treating the feces of the farm animals as well as of the human families raising them in nearly 50,000 of the units already – approximately 250,000 Vietnamese. While both this percentage and the percentage of users of the bio-slurry remain to be improved, impressive progress has already been made.

Indeed, the project's success has not gone unnoticed. Its renewal to its current second phase, with substantial increase in investment, was helped with its winning of the Energy Globe Award in 2006 for its significant contribution to climate change reduction and contribution to socio-economic development in Vietnam. It has also won a 2010 Ashden Award for Sustainable Energy, which recognizes its use of local sustainable energy to address climate change and alleviate poverty. While this case study series focuses on the sanitation benefits of projects like this, these awards show that this project's climate change element is also substantial, given that each biodigester installed will offset between 1.5 to 3 tonnes of CO₂ equivalent per year just through its replacement of alternative fuel sources (like wood and LPG) with carbon-neutral biogas. This figure would increase if emission reductions from proper manure management and the lowered need for synthetic fertilizers (which release more greenhouse gases than organic versions) were also counted. As of 2009, this program was already reducing CO₂ emissions by around 167,000 tonnes per year.

In short, every biogas digester sold by this program is helping to improve overall sanitation in Vietnam, improve the lives of the farming families by utilizing an existing resource (manure of their animals) to give them free biogas for cooking and lighting, improve the agriculture generated by these farmers through their 'closing the loop' use of the output bio-slurry, and improve the governing and marketing institutions of the country by using this multi-partnership program to bring together and utilize the talents of the different government and NGO groups operating in the country. With additional revenue now being generated from the sale of verified carbon offsets from these biogas digesters, the program is also helping to prevent climate change and make money for the program at the same time. It is hoped that this program will continue in earnest beyond 2012 and make Vietnam a model for biodigester marketing and sales.

Photos



Figure 5. A site visit to a biodigester installation by a local documentary film crew (left), the signing ceremony for the initiation of phase II of the Biodigester Program by SNV, DGIS, and MARD (right)



Figure 6. Examples of a locally-produced biogas stove (left) and biogas lamp (right)



Figure 7. A farming family kitchen making use of the biogas stove (left), a farmer applying the bio-slurry output from the biodigester to his crops (right)

References

- Cambodian National Biodigester Program. (2011). <http://www.nbp.org.kh> [Accessed 8 June 2011] (for stock photos and Table 1)
- Biogas Program Division. (2010). *Biogas Program for the Animal Husbandry Sector in Vietnam: Report 2010*. From: <http://210.245.92.22/english/getattachment/34dc641b-24f1-4bfa-b4b1-59b62d3ce1b5/Report-2010.aspx> [Accessed 9 June 2011]
- Biogas Program for the Animal Husbandry Sector in Vietnam. (2011). <http://www.biogas.org.vn> [Accessed 9 June 2011]
- Biogas Project Office. (2006). *Support Project to the Biogas Programme for the Animal Husbandry Sector in Some Provinces of Vietnam: Final Report*. From <http://www.snvworld.org/en/countries/vietnam/ourwork/Documents/Final%20Report%20on%20Biogas%20Programme%20-%20Phase%201.pdf> [Accessed 9 June 2011]
- SNV. (2011). *The Vietnam Domestic Biogas Program*. From: <http://www.snvworld.org/en/countries/vietnam/ourwork/Pages/renewableenergy.aspx> and <http://www.snvworld.org/en/countries/vietnam/ourwork/Pages/Biogas%20Our%20On-going%20and%20Future%20Impact.aspx> [Accessed 9 June 2011]