

**Possibilities for Sustainable Nutrient
Recycling by Faecal Separation Combined
with Urine Diversion**

Björn Vinnerås
*Department of Agricultural Engineering
Uppsala*

Doctoral thesis
Swedish University of Agricultural Sciences
Uppsala 2002

Acta Universitatis Agriculturae Sueciae
Agraria 353

ISSN 1401-6249
ISBN 91-576-6167-7
© 2002 Björn Vinnerås, Uppsala
Tryck: SLU Service/Repro, Uppsala 2002

Abstract

Household wastewater can be divided into three fractions by origin; urine, faeces and greywater. The largest nutrient and smallest heavy metal contents are found in the urine, which is easily collected separately using a urine-diverting toilet. The second most nutrient-containing fraction is the faecal matter. This fraction (faeces and toilet paper) has the smallest mass of the three, approximately 60 kg of wet weight per person and year. The nutrients in the urine and faeces have to be recycled to agriculture for society to be sustainable.

The faecal matter can either be collected dry or, after a short waterborne transport, be separated from the flushwater in a separator that uses a combination of whirlpool effect, gravity and surface tension. Using this type of separation, between 58% and 85% of the faecal nutrients were separated in the measurements performed here. By recycling the urine and the faecal nutrients, much energy can be saved as the load on the wastewater treatment plant decreases and as mineral fertilisers are replaced in agriculture.

To avoid transmission of diseases, the faecal matter has to be sanitised before recycling. If the faecal matter is collected dry, it is possible to perform the sanitation by thermal composting, preferably together with household biodegradable waste. A calculation method for determination of the safety margins for sanitation was developed. In a pilot-scale study, the safety margin for thermal composting of faeces and food waste, with old compost as an amendment, was approximately 37 times total inactivation of Enteroviruses, the most thermo-tolerant organism evaluated.

Another sanitation method investigated was chemical disinfection using urea or peracetic acid. At a dosage between 0.5% and 1.0%, the highly reactive peracetic acid inactivated all investigated organisms within 12 hours of treatment. The high dry matter content (10% DM) meant that high dosages were needed. Lower dry matter content would decrease the dosage required for proper sanitation.

A very promising treatment was the addition of urea. Addition of 30 g urea-nitrogen per kg of wet weight faecal matter resulted in total inactivation of the monitored organisms, *E. coli*, *Salmonella* spp, *Enterococcus* spp, *Salmonella typhimurium* 28B phage and *Ascaris suum* eggs, within 50 days of treatment at 20°C. The spore-forming bacteria *Clostridium* spp in its dormant state was resistant to this treatment. As the urea has to be degraded to ammonia before it functions as a disinfectant, there is some delay in this treatment. Therefore, urea addition followed by 2 months storage is the preferred treatment for disinfection of separated faecal matter. As additional effects, urea increases the fertiliser value of the treated material and there is no risk of microbial regrowth.

Changing to urine-diversion combined with faecal separation and disinfection by urea seems to be an interesting way to decrease the resource usage and possibly improve the hygienic standard of wastewater systems.

Key words: Faecal separation, urine-diversion, nutrient recycling, wastewater composition, wastewater reuse, disinfection safety margins, sanitation, disinfection, thermal composting, chemical disinfection, urea, peracetic acid

Sammanfattning

Hushållsavloppsvattnet kan utifrån dess källor delas upp i tre fraktioner: urinen, fekalier och BDT vatten (bad-, disk-, tvättvatten). Urinen innehåller den största delen växtnäring samtidigt som den innehåller de lägsta halterna tungmetallföreningar. Urinen samlas lätt upp separat i en urinsorterande toalett. Fekalierna är den fraktion som innehåller näst mest växtnäring. Fekaliefractionen (fekalier och toalettpapper) är mycket liten, ungefär 60 kg per person och år kan samlas.

Fekalierna kan antingen samlas torrt eller separeras från spolvattnet efter en kortare vattentransport i en separator. Denna utnyttjar centrifugalkraften, gravitationen och ytspänningen för att separera partiklarna från vattnet. Med denna typ av separation är det möjligt att separera mellan 58% och 85% av fekaliernas växtnäring. Genom att återföra växtnäringen från urinen och fekalierna minskar energianvändningen dels i avloppsreningsverket och dels genom att mineralgödsel ersätts. Vaxtnäringen från urin och fekalier måste återföras till lantbruket för att samhället skall kunna bli uthålligt.

För att recirkuleringen skall kunna anses vara säker avseende överföring av smitta måste fekalierna hygieniseras innan användning. Om fekalierna samlas torrt är det möjligt att hygienisera dem genom termofil kompostering. Bäst effekt fås om fekalierna komposteras tillsammans med köksavfall. En beräkningsmetod för att uppskatta de hygieniska säkerhetsmarginalerna utvecklades. Säkerhetsmarginalen för hygienisering av fekalier tillsammans med köksavfall och gammal kompost som strömedel var 37 gånger total inaktivering av enterovirus, den mest temperaturtåliga organismen av de som utvärderades.

En annan metod för hygienisering av fekalier som undersöktes var kemisk hygienisering med urea och med perättiksyra. Den mycket reaktiva perättiksyran inaktiverade undersökta organismer inom 12 timmars behandling vid en dosering mellan 0,5% och 1,0%. Den höga andelen torrs substans (10%) i materialet ökade kemikaliebehovet. Lägre torrs substanshalt skulle signifikant minska doseringen för att uppnå önskad hygienisering.

Hygieniseringen genom ureatillsats visade sig vara en lovande behandling. Genom tillsats av 30 g ureakväve per kg material inaktiverades de undersökta organismerna *E. coli*, *Salmonella* spp, *Enterococcus* spp, *Salmonella typhimurium* 28B fag och *Ascaris suum* ägg inom 50 dagars behandling. Sporformande *Clostridium* spp var resistenta mot denna behandling. Genom att urean måste brytas ned till ammoniak efter tillsats kommer behandlingen att ha en initial fördröjning. Genom 2 månaders lagring av materialet, efter ureatillsats, erhålls ett hygieniskt säkert gödselmedel. Dessutom ökar det tillsatta kvävet materialets gödselvärde.

Ett urinsorterande och fekalieseparerande avloppssystem med hygienisering genom ureabehandling verkar vara en intressant väg för att minska resursförbrukningen och möjligen öka avloppssystemets hygieniska standard.

Den mätta dagen, den är aldrig störst.
Den bästa dagen är en dag av törst.

Karin Boye

List of papers

This thesis is based upon the following papers, referred to in the text by their Roman numerals. Published papers are appended and reproduced with kind permission of the publishers.

- I. Vinnerås, B., Palmquist, H., Balmér, P., Weglin, J. Jensen, A., Andersson, Å. & Jönsson, H. The characteristics of household wastewater and biodegradable solid waste – a proposal for new Swedish norms. Submitted to *Urban Water*.
- II. Vinnerås, B. & Jönsson, H. (2002). Faecal separation for nutrient management – evaluation of different separation techniques. *Urban Water* in press.
- III. Vinnerås, B. & Jönsson, H. (2002). The potential of faecal separation and urine diversion to recycle plant nutrients in household wastewater. *Bioresource Technology* 84:3, 275-282
- IV. Vinnerås, B. Björklund, A. & Jönsson, H. (2002). Thermal composting of faecal matter as treatment and possible disinfection method – Laboratory-scale and Pilot-scale studies. *Bioresource Technology* in press.
- V. Vinnerås, B. Holmqvist, A. Bagge, E. Albiñ, A. & Jönsson, H. Potential of disinfection of separated faecal matter by Urea and by PAA for hygienic nutrient recycling. (Submitted to *Bioresource Technology*)

Notes on the authorship of the papers:

In Paper I, the investigation at Ekoporten was performed by Vinnerås and Weglin, the calculation of the greywater composition by Balmér and the investigation at Gebers by Andersson, Jensen, Jönsson and Palmquist. The proposed new designing values was developed by Vinnerås, Palmquist, Jönsson and Balmér.

In Paper II, the planning of the investigation was performed by Vinnerås and Jönsson. Vinnerås performed the investigation, the interpretation and analysis of the results and the writing, with revisions by Jönsson.

In Paper III, the planning of the investigation was performed by Vinnerås and Jönsson, and the sampling by Vinnerås and Weglin, Vinnerås carried out the interpretation and analysis of the results and the writing, with revisions by Jönsson.

In Paper IV, the planning of the investigation was performed by Vinnerås, Björklund and Jönsson. Björklund and Vinnerås performed the investigation. Vinnerås carried out the interpretation and analysis of the results and the writing, with revisions by Jönsson.

In Paper V, the planning of the investigation was performed by Vinnerås, Jönsson and Albiñ; Vinnerås and Holmqvist performed the investigation. The interpretation of the results and the writing were carried out by Vinnerås, with revisions by the other co-authors.

Contents

Introduction	13
Objectives	13
Background	14
Sewage treatment	19
<i>Conventional large-scale central sewage treatment in Sweden</i>	19
<i>Conventional small-scale sewage treatment in Sweden</i>	20
Recycling sewage systems	20
<i>Urine-Diversion</i>	20
<i>Faecal separation</i>	22
<i>Blackwater diversion</i>	23
Disinfection of sewage products	23
<i>Storage</i>	24
<i>Thermal treatment</i>	25
<i>Chemical treatments</i>	30
Environmental effects from sewage treatment	34
Composition of urine, faeces and greywater (Paper I)	35
Urine	36
Faeces	38
Greywater	40
Proposed new designing values for the Swedish wastewater fractions	42
Faecal Separation (Paper II, III)	42
Laboratory-scale evaluation of different separation techniques (Paper II)	45
Controlled pilot-scale separation of faeces and toilet paper by using whirlpool, surface tension separation	46
Full-scale separation of faeces in the Ekoporten block of flats (Paper III)	50
Important issues when using faecal separation	51
Disinfection of faeces (Papers IV, V)	53
Thermal composting of separated faecal matter (Paper IV)	53
<i>Disinfection of faeces</i>	58
Chemical treatment of separated faecal matter (Paper V)	60
<i>Treatment with peracetic acid (PAA)</i>	60
<i>Treatment with Urea</i>	62
Risk of regrowth after disinfection treatments	63
Comparison of sewage treatment strategies	64
Comparison of different primary treatments	65
<i>Nutrient recycling</i>	66
<i>Quality of the recycled products</i>	67
<i>Water emissions</i>	68
<i>Energy usage</i>	68
Comparison of secondary treatments to attaining high hygiene standards	70
Concluding summary	73
Further research needed	77
References	78
Acknowledgements	87

Introduction

The 90 naturally occurring elements have been present in some form since the earth was formed, either in their ground state or combined in molecules. During the evolution of life, biological systems have concentrated some of the elements while others have been rejected, as a natural selection of the elements. Today, approximately eleven elements contribute 99.9% of the total biomass. In the human body, four elements contribute 99% of the total wet mass (H=62.8%, O=25.4%, C=9.4% and N=1.4%). The other 0.9% are Na, K, Ca, Mg, P, S and Cl. Seventeen other elements have been identified as being used by biological life (Fraústo da Silva & Williams, 1997; Williams & Fraústo da Silva, 2000).

The remainder of the elements in the periodic table are in most cases used in some type of commercial process in the current industrialised world. Therefore, they will be found in the products of society. Apart from the elements, approximately 30 000 compounds are used as everyday chemicals and will probably be found in the wastewater (Palmquist, 2001). However, in this thesis the emphasis is on the elements, especially those essential to biological life.

The ideal situation in waste management would be that the bio-useful elements would end up in one place for recycling into food, while the rest of the elements and substances would be recycled elsewhere. However this is far from being the case today, especially in the wastewater systems, where a lot of these elements and substances are mixed. Both essential and lethal substances plus pathogenic organisms from households and from industries are collected together and treated in some way so as to minimize their immediate influence on society.

The main proportion of the nutrients in household wastewater is excreted in the urine and the faeces, while only small amounts of toxic heavy metals and organic pollutants are found in these fractions. The main pollutants are generally found in the greywater from households (Paper I; NV, 1995) and in wastewater from industries (Balmér, 2001). By collecting the urine and the faeces separately, it is possible to collect a large portion of the nutrients in two relatively unpolluted low-volume fractions.

The diverted urine is easily disinfected by storage (Höglund, 2001) while the faeces, which contain the main proportion of the potential pathogens, have to be actively disinfected. Today no simple, reliable, cost-effective and scale-independent sanitation method is available for treatment of faecal matter.

Objectives

The main objective of this thesis was to find a hygienic and environmental friendly way to recover the nutrients from household wastewater and safely recycle them back to arable land.

To achieve this, the composition of biodegradable waste and wastewater had to be determined (Paper I).

Urine has been investigated in detail earlier and shown to be the cleanest and the most nutrient-containing fraction; the methods for recovery of this fraction have also been exhaustively investigated. However, the second most nutrient-containing fraction, the faeces, has been the subject of very little study. Therefore, a sub-objective of this study was to find easy ways to recover faecal nutrients while still using the facility of flush toilets (Paper II, III).

A lot of pathogens can be found in the faecal fraction and before the faecal nutrients can be utilized, they have to be disinfected in some way. Different methods for disinfection were investigated, i.e. thermal composting (Paper IV) and chemical treatment by urea and by peracetic acid (Paper V).

Background

As an effect of the urbanisation and the increase in the population during the 19th century, problems with transmission of diseases between the increasing numbers of humans have occurred. One factor identified in such problems was the handling of human waste. To solve this, water-borne sewage systems were built for the urine, faeces and greywater.

The effect of the introduction of the sewage systems was a decrease in diseases linked to latrines. Instead, new problems were introduced in the receiving waters. Larger particles were accumulated in the area around the outlets, but by using mechanical treatment before discharging the water this problem was removed.

The next problem identified was the discharge of oxygen-consuming organic matter, which led to oxygen deficiency in the recipient waters. The absence of oxygen led to death of fish and production of H₂S and other unpleasant gases. By introducing aeration of the wastewater and developing the technique of active sludge, this problem was also solved.

In Sweden, the next problem identified was a secondary production of oxygen-consuming organic material, mainly caused by phosphorus in the effluent. Within a short period of time, this phosphorus was taken up by algae, allowing them to produce more organic material. One gram of phosphorus corresponds to a consumption of 140 grams of oxygen as the alga degrades after death. By addition of metal ions, such as iron, aluminium and calcium, it was possible to precipitate the phosphorus from the water into a more solid sludge (Tchobanoglous & Burton, 1991).

Nitrogen is another element that has caused problems in recipient waters, both as a biochemical oxygen consumer during nitrification of ammonia to nitrate and, when nitrogen is deficient in the surroundings, causing production of biomass. One gram of nitrogen, as ammonia or nitrate, corresponds to a consumption of approximately 20 grams of oxygen as COD (Nord, 1995). Surplus of oxygen results in nitrification and if followed by anoxic conditions and with organic carbon present, the nitrate is reduced into gaseous dinitrogen, as is present in air (Tchobanoglous & Burton, 1991). These two natural biochemical processes are also used in sewage treatment plants to remove nitrogen.

The initial reason for establishing sewage systems, to improve sanitary standards and decrease the transmission of diseases, had a positive effect towards diseases within the cities. The pathogens were transported out of the cities and diluted in the water recipients, where it sometimes can be found in a wider area both in surface and ground water.

One of the main opponents to the introduction of water-borne sewage systems was the agricultural sector. Farmers feared that they would lose a valuable fertiliser as the latrines disappeared. This opposition weakened with the development of the Haber-Bosch process, making it possible to transform dinitrogen from air into ammonia and thereafter into nitrates by the Ostwald process during the early 20th century. For the two other nutrients in focus, phosphorus and potassium, methods for mining were developed and the need for organic fertilisers such as latrines decreased.

During the second half of the 20th Century, the focus on the use of natural resources increased. The natural resources of fossil fuel (oil and gas) are predicted to last for another 30 to 50 years. This will have a big impact on the production of nitrogen fertilisers, which are heavily dependent on fossil fuel for the reduction of dinitrogen to ammonia (Greenwood & Earnshaw, 1998). The largest single energy requirement in the conventional production of rapeseed in Sweden is the production of the mineral nitrogen fertiliser used (Hovelius & Hansson, 1999).

The major part of nutrients on farms is recirculated within the farm, by circulation of materials such as roots and straw left on the field at harvest and by circulation of manure as fertiliser (Steineck et al., 2000). However, there is still an outflow of nutrients following food produced for human consumption (Figure 1).

Today, this outflow into society is mainly a one-way flow. To have a sustainable society, the nutrients from farms have to be recycled back to the farms from society.

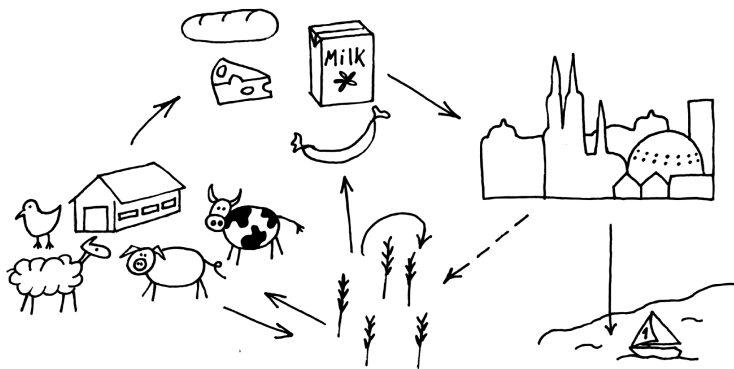

Figure 1 The flow of nutrients on the farm and into society.

In a healthy adult, the amounts of nutrients are in equilibrium within the body. Thus all the plant nutrients consumed are excreted; normally via the urine or via

the faeces (Guyton, 1992), although some metals are also found in the sweat (Schroeder & Nason, 1971).

Due to the origins of urine, faeces and greywater, there are major differences in their composition. Urine is composed of material that is metabolised in the body and extracted from the bloodstream into the urine by the kidneys (Guyton, 1992). The faeces are composed of both material extracted from the bloodstream and material that just passes through the intestine undigested. In the faecal fraction of the wastewater in the Western world, there is also a quantity of toilet paper. The greywater is a waste fraction consisting of water used by the households and some liquid food waste.

The composition of the urine reflects the consumed material, especially the parts that are digested and taken up by the intestines. The main component in urine is water but also excreted in the urine are the main proportion of the household nutrients (Figure 2).

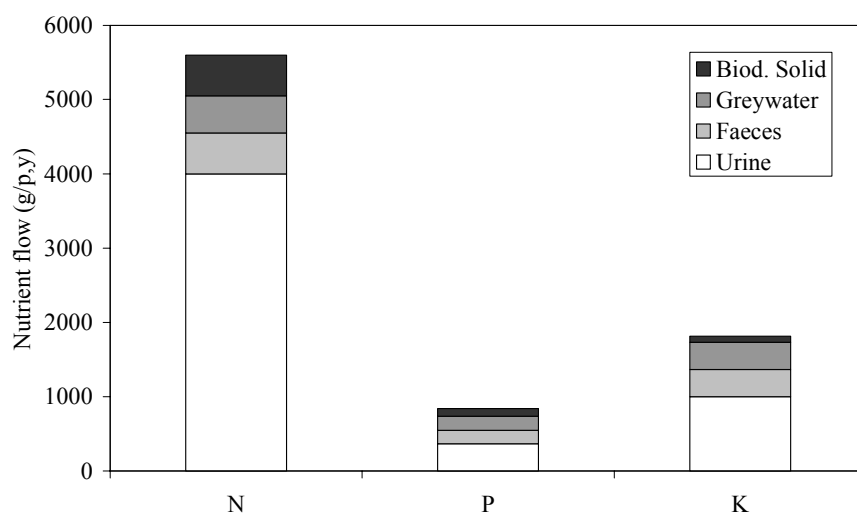

Figure 2. The content of nitrogen (N), phosphorus (P) and potassium (K) in the fractions of biodegradable solid waste and wastewater from households (Paper 1).

The nutrients in urine are in a water-soluble form. Nitrogen is mainly found as urea (80%), ammonia (7%), and creatine (6%), while the remainder is mainly free amino acids or shorter peptides (Johnston & McMillan, 1952; Lentner et al., 1981; Guyton, 1992; Kirchmann & Pettersson, 1995; NV, 1995; Fittschen & Hermann, 1998; Almeida et al., 1999). This, combined with the biochemical activity of urease (Alef & Nannipieri, 1995) transforming the urea into ammonia and carbon dioxide (Vinnerås et al., 1999), indicates that the nutrients in urine are readily plant available.

In the urine, the phosphorus is mainly found as inorganic phosphates (>95%) and the potassium mainly as free ions (Berger, 1960; Lentner et al., 1981; Guyton, 1992).

Approximately 50% of the faecal nitrogen is water-soluble (Trémolières et al., 1961). Of this, 20% is ammonia, biochemically degraded from urea, peptides and amino acids. About 17% of the total nitrogen content is found in living bacteria and the remainder is mainly found as organic nitrogen combined in molecules such as uric acid and enzymes (Lentner et al., 1981).

The main proportion of the phosphorus in the faeces is found as undigested mineral calcium phosphates. Potassium on the other hand is mainly found in its ionic form in equilibrium with the liquids outside the intestine (Berger, 1960; Guyton, 1992; Fraústo da Silva & Williams, 1997).

The low amount of heavy metals (metals with a density over 4.5 g cm^{-3}) in the urine is mainly due to the minor biological usage of heavy metals regulating their uptake and thereby their excretion. However, small amounts of nonessential heavy metals are taken up, in some cases in relatively large amounts. This especially applies to metals similar in size and charge to those used in biochemical reactions. This is the case with the uptake of cadmium for example, which uses iron-pathways. The dose and whether the metals are eaten or inhaled also influences the uptake, where the uptake of inhaled metals is much larger (Kehoe et al., 1940; Joselov et al., 1967; Vahter et al., 1991; WHO, 1991, 1992, 1995; Kim & Fergusson, 1993; Engqvist, 1998).

Due to the low uptake of heavy metals, the majority of the metals consumed just pass through the body and are therefore found in the faeces. However, the contribution of heavy metals to sewage water from both the urine and faeces is considerably lower than the amounts coming from the greywater (Figure 3).

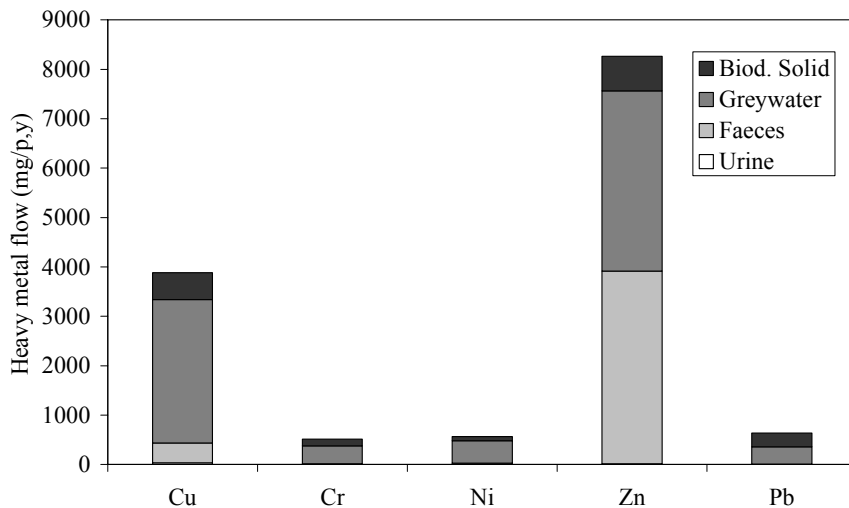

Figure 3. The amounts of the heavy metals Cu, Cr, Zn, Ni and Pb in the fractions of biodegradable solid waste and wastewater.

During the past few decades in Sweden, the focus has been on excluding mercury and cadmium from society, e.g. mercury-containing thermometers have been

collected and exchanged for digital ones, and the flow of these two metals has decreased (Lohm et al., 1997; Balmér, 2001). The use of mercury in dental fillings results in a significant load of mercury to the faeces (Engqvist, 1998) (Figure 4).

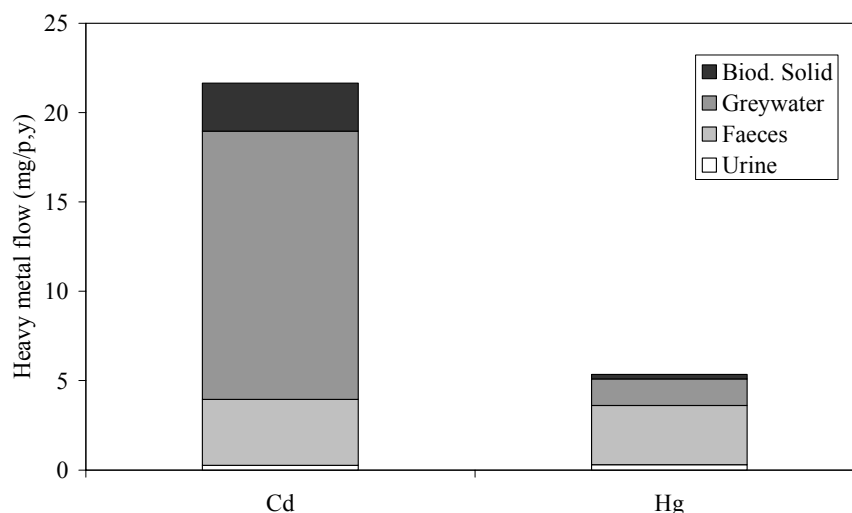

Figure 4 The amounts of the heavy metals Cd and Hg in the fractions of biodegradable solid waste and wastewater.

While the greywater contains the major proportion of the heavy metals (Figure 3; 4) it contains only a minor proportion of the nutrients (Figure 2). The nutrients in the greywater are mainly inorganic and the amounts depend on the amounts used in households. Phosphorus and potassium are used in detergents and their usage is reflected in the amounts of these elements in the greywater.

The heavy metals in the greywater have different origins. One main source is dust, especially small particles impossible to vacuum, which have to be wiped off (Månsson, 1992). This dust content in domestic cleaning water is a major source of heavy metals (Moriyama et al., 1989; Kim & Fergusson, 1993; Comber & Gunn, 1996; Koch & Rotard, 2000).

Some heavy metals can also be found in chemicals used in households, e.g. cadmium in phosphorus-containing detergents and zinc in anti-fungal shampoo (dandruff shampoo). This kind of usage is reflected in the metal content in the wastewater.

The total volume of the fractions also differs greatly. The greywater is a high volume fraction and in Sweden it contributes between 66 and 75% of the total volume of household wastewater. This corresponds to 24 to 65 m³ person⁻¹ (p⁻¹) year⁻¹ (y⁻¹) (Palmquist, 2001). In systems with a flush toilet, the second largest volume consists of flushwater. Today, the volume of water used per flush normally varies from 2 to 6 litres per flush. The total annual volume, if 6 litres are used for each flush, corresponds to 18 m³ p⁻¹ y⁻¹.

The fractions flushed, urine and faeces, are very low volume compared to the water used. The collected urine volume corresponds to 365-550 litres $p^{-1} y^{-1}$ and the faeces, toilet paper included, corresponds to approximately 40 kg wet weight per person and year (Paper I; Lentner et al., 1981; NV, 1995; Hellström & Kärrman, 1996; Hanaeus et al., 1997; Jönsson et al., 1997, 1998, 2000; Höglund et al., 1999; Otterpohl et al., 1999).

As we can see, the nutrients leaking from urban society are mainly found in the fractions of urine, faeces and biodegradable solid waste. If we were able to recycle these three fractions to agriculture, the need for extra inputs of nutrients to farms would decrease and the consumption of fossil resources would also decrease, making it possible to increase the sustainability of society.

Sewage treatment

The sewage treatment of today in Sweden is normally performed either on a large-scale at central treatment plants or on a smaller local-scale even down to detached households using cleaning processes such as soil filters.

In a more global perspective, the most common way is to not treat excrement or wastewater at all. In the absence of toilets, people defecate in fields or in some cases in holes that are dug each time. The greywater produced is either wasted outside the building or used to water plants in the surroundings.

In a lot of places with wastewater systems, the untreated wastewater is just dumped into a recipient water body nearby. This gives problems both with eutrophication and with transmission of pathogens and a valuable nutrient source is also lost as a pollutant, which leads to the possible loss of the water body as a resource for drinking water and for fish production.

Conventional large-scale central sewage treatment in Sweden

The majority of the household wastewater in Sweden today is collected and led to a central sewage treatment plant where it is treated mechanically combined with biological and/or chemical treatment.

Larger particles are mechanically removed when the water passes through sieves on entering the treatment plant. Biological and chemical treatment then removes the majority of the BOD (biological oxygen demand), phosphorus and, in larger plants in Southern Sweden, also nitrogen.

The BOD is mainly removed by biological oxidation of organic compounds, resulting in gaseous carbon dioxide. By having alternating zones with aerobic and anoxic treatment, it is possible to first nitrify the ammonia nitrogen and then denitrify the nitrates. This process needs a lot of space and energy for aeration and the result is a transformation of the plant available nitrogen into gaseous dinitrogen. To make that airborne nitrogen plant available again, a lot of energy, mainly fossil oil or gas, is used in the Haber-Bosch process to produce ammonia from dinitrogen (Greenwood & Earnshaw, 1998).

Phosphorus is in Sweden normally removed from sewage water by chemical precipitation. This can be performed throughout the process and the methods used for precipitation are mainly addition of iron (Fe^{2+} or Fe^{3+}), aluminium (Al^{3+}) or calcium (Ca^{2+}) ions. With the precipitated metal phosphates, some organic matter and often a lot of heavy metals follow from the wastewater into the sludge (Balmér, 2001). Biological methods for phosphorus removal are available today, but they are not common in large-scale systems in Sweden. Other incoming nutrients such as potassium more or less just pass through the treatment plant unaffected (Balmér et al., 2002).

Conventional small-scale sewage treatment in Sweden

About half of the emissions of phosphorus from sewage to recipient waters in Sweden are caused by about one million houses, both permanent and summer houses, not connected to a central treatment plant.

The wastewater from these systems is mainly treated in small local systems consisting of a septic tank and a soil filter or an infiltration unit. The BOD removal of these systems is generally good but the removal of nutrients is often little to medium (Aaltonen & Andersson, 1995). The infiltration systems are also hard to supervise regarding leakage to the groundwater, thus undiscovered contamination both by nutrients and pathogens can occur.

The potential for recycling the nutrients is small, since the only possible fraction is the sludge from the septic tank. However, its nutrient content is low and its heavy metal content high (Almedal, 1998; Svensson & Mattson, 1999).

Recycling sewage systems

To decrease the discharge of eutrophying substances to recipient waters and to decrease the need for fossil resources in agriculture, the two most nutrient containing fractions, the urine and the faeces, can be collected separately and recycled to agricultural production.

The collection of the toilet fractions can either be performed separately, where the urine is diverted and the faeces are collected dry or separated from the flushwater after a short transport, or by blackwater collection, where both the urine and faeces are collected as one fraction.

The greywater still has to be treated, but this treatment can then be more adapted to the special conditions required by the greywater. However, in this thesis the treatment of greywater is not considered.

Urine-Diversion

One of the major disadvantages with the current sewage system in Sweden is the problem of efficiently recycling the nutrients, in an uncontaminated way.

By collecting the urine and the faecal fractions separately from the rest of the sewage water, the majority of the nutrients (Figure 2) are contained in a small fraction relatively unpolluted by heavy metals (Figure 3; 4).

By using urine-diverting toilets (Figure 5), it is possible to collect the most nutrient-containing fraction in a concentrated way. This kind of toilet has two separate bowls where the smaller front bowl collects the urine, which in some cases is flushed with a small amount of flushwater. In the rear bowl the faeces and used toilet paper are collected. The rear bowl can either be flushing or non-flushing.



Figure 5. Two double flush urine-diverting toilets, Dubbletten and Gustafsberg, and one single flush toilet where the faeces are collected dry, Wost Man Ekology ES.

If the urine is collected separately, the main proportion of the nutrients from the household is collected in a small fraction with a low heavy metal content. Due to the rapid degradation of urea into ammonia and carbon dioxide, the pH of the urine mixture rises from approximately 7 (Lentner et al., 1981) to above 8.5 (Vinnerås et al., 1999; Jönsson et al., 2000; Höglund et al., 2000).

The high ammonia content of the collected urine mixture makes it very corrosive towards metals and it also increases the ageing of PVC (Greenwood & Earnshaw, 1998). The corrosion of metals means that if metal pipes are used, metals pollute the initially low heavy metal-containing urine. This was identified as a problem in households that had urine-diverting toilets with half a metre of copper pipe connecting the urine bowl and the soil pipes, which increased the copper content of the urine mixture by more than 50 times (Jönsson et al., 1997, 1998, 2000; Vinnerås et al., 1999).

If the ammonia content is over 1 mg l^{-1} , the pH is over 8.8 and no fresh urine is added, storage of the urine mixture for one to six months, depending on the temperature, inactivates any non spore-forming pathogens present, so the urine can then be recycled as a fertiliser to agriculture with negligible hygienic risks (Jönsson et al., 1997, 2000; Höglund et al., 1998; Höglund, 2001).

If the urine is collected and uncontaminated by heavy metals, an unpolluted and potent organic fertilizer that contains mineral nutrients is obtained. Field trials and pot experiments have shown that diverted human urine is comparable to mineral

fertilisers. For nitrogen, the fertilising effect is comparable to, or just a little bit poorer than, mineral fertilisers while for phosphorus, the fertilising effect is comparable to, or a little bit better than, mineral fertilisers (Kirchmann & Pettersson, 1995; Elmqvist et al., 1998; Johansson et al., 2000).

Faecal separation

The second largest contributor of nutrients to wastewater is the faeces (Paper I; Figure 2). This fraction is also the smallest volume fraction in the household wastewater (NV, 1995; Kärman et al. 1999; Paper I). The faeces can either be collected dry beneath the toilet or separated from the flushwater after a short transport (Paper II, III).

If using a single flush toilet (Figure 5) or a non-flush dry toilet or squatting plate (Figure 6), the faecal matter and the toilet paper (if used) are collected in a container or vault directly beneath the toilet. When the urine is diverted, problems with smell and flies are significantly reduced (Fittschen & Niemczynowicz, 1997; Del Porto & Steinfeld, 1999).



Figure 6. A non-flush dry urine-diverting toilet and a urine-diverting squatting plate

Commercially available today for separation of faecal matter from flushwater are two systems, one that has a filter that collects the particles from the flushwater over several months, building up a filter cake (Otterpohl, 2001; Hellström & Johansson, 2001). The other system separates the faecal particles in a whirlpool, surface tension separator, by using a combination of whirlpool effect, gravitation and surface tension (SP, 1992; Del Porto & Steinfeld, 1999; Paper II, III).

By using this kind of wet separating system, the collection of the faecal matter does not have to be performed directly beneath the toilet, but can instead be done at another location, for example in the basement of a multi-storey building. Thus the comfort of having a flush toilet in the house is still possible even when recycling the nutrients from the urine and faeces using a source separating sewage system.

Blackwater diversion

The urine and faeces can be collected together, but separately from the greywater. If this is performed dry, in bucket latrines or pit latrines, there is an impending risk of problems with both smell and flies.

If the blackwater is collected in a flushed system, only small volumes of flushwater can be used, to keep the volume down and the dry matter content up. Normally these systems use low-pressure sewers, using vacuum to transport the material from the toilet to a collection tank (Skjelhaugen, 1999a).

The advantage with this kind of system is that all of the excreted nutrients are collected both from the urine and the faeces, unlike urine-diversion systems, where some of the urine is lost (Jönsson et al., 1997, 1999, 2000; Höglund et al., 1999), and faecal separation, where some of the nutrients are lost by extraction (Paper II, III).

The disadvantage with blackwater diversion is the need for highly developed technology based on a vacuum system to keep the flushwater volumes low. However, too small volumes can lead to blockages in the system, as small water volumes sometimes will not manage to transport the particles to the collection tank. This system has low robustness and is thereby sensitive to disruption and if the system goes down, e.g. through blockage or leakage, the toilets do not work.

Disinfection of sewage products

Handling human waste has been a sanitary problem for a long time. This problem is so old and large in scale that behaviour concerning excretion is regulated in some religions and beliefs.

As mentioned previously, hygiene was one of the major reasons for introducing wastewater systems into cities, but all hygiene problems were not solved by the introduction of the water-borne system. The pathogens can in the water recipient be transported and cause diseases somewhere else. Also the rest products if aiming for recycling can contain sever amounts of pathogens.

When considering the recycling of sewage products to arable land, transmission of diseases is one of the major issues. The Swedish farmers' association (LRF) has as one of the conditions for recycling sewage sludge set a restriction of no viable *Salmonella* bacteria in the sludge. In a study performed by Albiñ et al. (2001) more than 70% of the sludges analysed contained *Salmonella*, even sludge after mesophilic (30-45°C) anaerobic digestion.

Pathogens are also found in products from source-separating systems. Therefore, all products from the wastewater system have to be disinfected before they can be considered for use as fertilisers. Treatment methods discussed in this thesis are storage, thermal treatment and chemical treatment.

Storage

Storage is a low impact alternative for attaining improved hygiene status of the material intended to be recycled. The disinfection effects of storage depend on the stored material. As a function of time, some inactivation of pathogens occurs during storage (Brock et al., 1994). However, storage is not a reliable method, and some of the pathogenic microorganisms have a dormant state in which their tolerance towards the surrounding environment is higher than in their vegetative state.

The efficiency of storage on pathogen control is higher at higher temperatures (Feachem et al., 1983; Mitscherlich & Marth, 1984). In the Swedish climate where the temperature is around and below zero for most of the winter, the storage has to be performed partly during the warmer half of the year.

Storage of organic waste products can also produce other problems, especially towards the surrounding environment through emissions, both of eutrophying, acidifying and greenhouse gases (Flodman, 2002).

Storage of human urine

Due to the degradation of the urea in urine to ammonia and carbon dioxide, as early as in the soil pipes (Höglund et al., 1999; Vinnerås et al., 1999; Jönsson et al., 2000), the environment in the urine mixture becomes toxic towards most of the microorganisms present.

Höglund et al. (1998) have investigated the survival of bacteria in human urine at different water-diluted urine mixtures, i.e. undiluted, 1:1 and 1:9 urine to water. *Aeromonas hydrophila*, *Escherichia coli*, *Pseudomonas aeruginosa*, two *Salmonella* sub-species and faecal Streptococci were studied and all of them had a D value (decimal reduction value, i.e. 90%) of <35 days in the 1:9 diluted urine at a storage temperature of 4°C. As expected, significantly shorter D values were detected for more concentrated urine mixtures and at higher storage temperature (20°C) (Höglund, 2001).

Clostridium perfringens and the *Salmonella typhimurium* 28B phage did not show any reduction in viability compared to the control (Höglund et al., 1998). A more recent study of the *Salmonella* phage and of *Rhesus* Rotavirus showed no significant reduction at 5°C but at 20°C the D values were 71 and 35 days, respectively (Höglund et al., 2002). *Ascaris suum* ova were also stored in the different urine mixtures and a reduction in viable organisms of 15-20% was achieved during 21 days of storage at 20°C (Höglund et al., 1998).

A longer study of the survival during storage of *Cryptosporidium parvum* in urine has also been performed (Höglund & Stenström, 1999). In that study, the survival was monitored during 133 days at pH 5, 7, and 9 of the urine mixture. At pH 9 the D value was 29 days and at pH 7 the D value was 207 days, which was 50% longer than in one of the controls.

These studies (Höglund et al., 1998; Höglund & Stenström, 1999) indicate that the main effect on inactivation of microorganisms from storage of human urine is a combination of temperature, ammonia concentration and pH, similar to the results from ammonia treatment of other sewage products (Burge et al., 1983; Cramer et al., 1983; Werkerle & Albrecht, 1983; Allievi et al., 1994; Gaspard et al., 1995; Gantzer et al., 2001).

A recommendation for urine storage to attain acceptable safety limits has been developed for Swedish conditions and use of the urine as a fertiliser after storage at different temperatures, to different crops and different uses of the crop produced (Jönsson et al., 2000; Höglund, 2001). These recommendations vary from shorter storage times (1 month) at 4°C where the urine can be used on crops that are processed before being used as fodder or food, to longer storage times (6 months) at 20°C where the urine can be used on all kinds of crops, even those that are consumed raw by humans.

Storage of other wastewater products

The inactivation rate of microorganisms during storage of faeces and sludge rich in organic matter and poor in free ammonia is lower compared to that in materials that have higher amounts of ammonia.

The mechanisms dominating the reduction of pathogens during storage of wastewater products are mainly competition from other organisms and starvation. Due to this non-specific effect that differs according to local circumstances, the effects of storage are difficult to predict and to specify.

Tests on the survival of different *Salmonella* sub-species during storage of faeces and sewage sludge have shown that the materials still contain viable organisms after 100 days of storage (Mitscherlich & Marth, 1984).

When storing sludge with high water contents, fermentation of the sludge occurs and produces fatty acids that lower the pH (Haug, 1993; Skjelhaugen, 1999a). This drop in pH can result in a higher inactivation rate of pathogens (Mitscherlich & Marth, 1984; Brock et al., 1994). However, the anaerobic degradation of the sludge also produces gases such as methane and nitrous oxide (Flodman, 2002), which both are very potent greenhouse gases.

Thermal treatment

Sensitivity towards heat varies between organisms. Some organisms can stand a higher temperature for a longer time than others, while some other organisms can stand a lower temperature for a longer time. This is exemplified by the Enteroviruses, which are more resistant to high temperatures than *Ascaris*, but the latter are more resistant at lower temperatures (Figure 7).

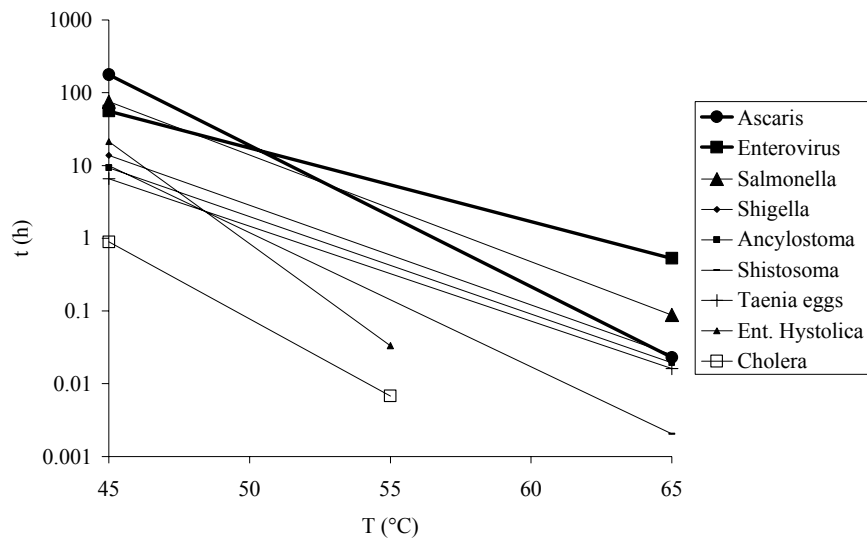

Figure 7. The time for total inactivation of nine pathogens at temperatures between 45°C and 65°C. The equations for the deactivation times are taken from Feachem et al. (1983) (Paper IV).

It is also possible to present the deactivation time for these organisms as a function of the temperature (Table 1). For *Ascaris* the inactivation can only be guaranteed above 45°C and for some other organisms the function of inactivation is changed at temperatures below 45°C (Feachem et al., 1983). Therefore, these equations are only functional above that temperature.

Table 1. Equations derived from Feachem et al. (1983) for the time in hours (*t*) required to attain no viable organisms of different pathogens at different temperatures (*T*) in Celsius (Paper IV)

Organism	Type	Equation (Ed)
Enteroviruses	Virus	$t=55.9 \times 10^{-0.101(T-45)}$
<i>Cholera</i>	Bacteria	$t=0.89 \times 10^{-0.2117(T-45)}$
<i>Salmonella</i>	Bacteria	$t=75.4 \times 10^{-0.1466(T-45)}$
<i>Shigella</i>	Bacteria	$t=13.8 \times 10^{-0.1369(T-45)}$
<i>Enteric Hystolica</i>	Protozoa	$t=21.3 \times 10^{-0.2806(T-45)}$
<i>Ancylostoma</i>	Helminth	$t=9.31 \times 10^{-0.1340(T-45)}$
<i>Ascaris</i>	Helminth	$t=177 \times 10^{-0.1944(T-45)}$
<i>Schistosoma</i>	Helminth	$t=10.0 \times 10^{-0.1844(T-45)}$
<i>Taenia</i>	Helminth	$t=6.6 \times 10^{-0.1306(T-45)}$

The inactivation of the pathogens is logarithmic and even if the time interval is shorter than that needed to achieve no viable organisms, a partial inactivation is obtained, which can be seen as a number of logarithms of the total inactivation (Stanbury et al., 1995). The sum of these partial inactivations shows the number of times we could expect to achieve the state of no viable organisms. From that value, we have a quantified safety margin of how many times the inactivation was obtained during the time of treatment.

$$\Sigma X = \frac{t_1}{E_{d1}(T_1)} + \frac{t_2}{E_{d2}(T_2)} + \frac{t_3}{E_{d3}(T_3)} + \dots + \frac{t_i}{E_{di}(T_i)} \dots + \frac{t_n}{E_{dn}(T_n)} \quad (1)$$

ΣX = number of times total die-off is achieved;

E_d = the time for total die-off at the average temperature T during the time interval

t. Calculated from equations in Table 1.

t= time interval (h) for the temperature T

The safety margin (Table 1) was initially set by Feachem et al. (1983), and these margins are based on several different measurements of survival as a function of time and temperature. All of the compiled inactivation at different temperatures, most of the time when no viable organisms were detected, was plotted in a time-temperature diagram. From that plot, a safety margin was set for treatment time at different temperatures where no viable organisms should be possible to detect, in most of the cases the line was set well above the determined time and temperature for no viable organisms in the laboratory studies (Feachem et al., 1983). To specify a state of total die-off, the Parental drug association determined 12 log₁₀ reduction of organisms as a level of sterility (Enzinger & Motola, 1981), which was assumed to be equal to the level of total die-off according to Feachem et al. (1983).

A plot of the safety margins at different temperatures for several pathogens set by Feachem et al. (1983) is presented in Figure 7. If this safety margin is reached, no viable organisms should be detectable within the treated material. Using Equation 1 to calculate the theoretical number of times the state of no viable organisms is achieved will give a relative estimation of how safe this kind of treatment can be.

Some bacteria can form spores, which are a dormant state where the bacteria are very resistant to external stress, such as heat (Brock et al., 1994). Other pathogens such as prions are also very stable towards heat. The moisture content of the material affects the efficiency of the thermal inactivation (Stanbury et al., 1995; Turner, 2002), as the heat transfer to the organisms and thus the inactivation is more efficient when moisture is present.

To monitor the effects of temperature, indicator organisms can be used. Alternatives here are either to use pathogenic microorganisms such as *Salmonella*, *Ascaris* and Enteroviruses, or to use microorganisms with known deactivation times at certain temperatures. For sterilisation of substrates, *Bacillus Stearothermophilus* is one of the most thermo-resistant spores known and it is normally used as an indicator of the efficiency of the sterilisation process (Stanbury et al., 1995).

For safety reasons it would be preferable if all pathogens were killed. However, it is not possible to secure total die-off, but only determine a state where no viable organisms can be determined. If the conditions are changed, there is a risk for regrowth of pathogenic bacteria, even if only one single bacterium survives.

Generating the heat for thermal treatment is mainly done in two different ways, either an external source for heat, e.g. electricity or oil, or the organic matter in the material, e.g. incineration or thermal composting. A combination of the two can also occur, i.e. burning of biogas produced by anaerobic digestion of organic matter.

Using an external heat source is expensive but the advantage is the possibility to have a fully controlled process. In cases of further treatments not generating high temperatures, e.g. mesophilic anaerobic digestion, or materials not containing enough organic material for heat production, e.g. diverted urine, external heating has to be used to achieve good hygiene standards by pasteurisation.

Another alternative for generating heat is to use the organic matter in the material to produce the heat. One major advantage of this is that when the material is degraded it is stabilised and the risk for regrowth then decreases (Sidhu et al., 2001). The two most common treatment alternatives are incineration and thermal composting.

If the material contains enough dry matter, incineration can be an alternative. By this treatment, the material is stabilised, pathogens are inactivated and heat is produced. However, before incineration the raw untreated matter has to be transported to a treatment plant and to avoid negative environmental effects from the incineration, the gases produced have to be cleaned. Some valuable nutrients, namely nitrogen, are lost during the process.

Under aerobic conditions, microbiological digestion produces an excess of heat energy. If that heat is captured by insulating the process, either with specialized insulation material or a thick layer of organic matter, the temperature of the material increases up to 80°C (Haug, 1993; Epstein, 1997). The composting can either be dry; approximately 35-55% dry matter content, or liquid, 2-10% dry matter content.

In liquid composting, the treatment has to be performed in a reactor with an active oxygen supply. To get aerobic conditions, the aeration has to be performed in the bottom part of the reactor, thereby requiring a lot of energy. The two most energy using parts of the process are the aeration/mixing and the foam cutting (Skjelhaugen, 1999b). Normally, aeration is also used for mixing or the mixer is used to finely distribute the air in the reactor (Stanbury et al., 1995).

In a study by Skjelhaugen (1999b), two commercial aerobic reactors were investigated (17 m³ and 32 m³). The small reactor consumed approximately 30 kWh m⁻³ and the larger approximately 20 kWh m⁻³ based on a 7 day retention time. When finely distributed bubbles were blown into slurry, foam was produced. To damper this, a foam cutter was used, thereby stopping foam from overflowing the reactor. The foam cutter used about 5-6 kWh m⁻³ (Skjelhaugen, 1999b).

The advantage of liquid composting is the use of a completely mixed reactor that allows full control of the process and process temperature to assure thermal disinfection. The outgoing air is also controlled since it passes a heat exchanger that condenses outgoing moisture and ammonia, which are then refluxed into the reactor, thereby capturing 50% of the ammonia during summer and 75% during

the rest of the year (Skjelhaugen, 1999b). The air is then led through a bio-filter where most of the organic substances and other odour-producing substances are captured and decayed, thereby avoiding problems with odours in the surroundings.

The high water content (91-98%) and the low degradation of the organic matter (10-20%) (Skjelhaugen, 1999b) give large volumes to handle and distribute on farms. The low degradation of the organic matter indicates a risk for anaerobic activity during storage before use, which will have large negative impacts on the environment from production of methane, a potent greenhouse gas.

An alternative to the technique of the intense reactor in liquid composting is dry composting, where the preferable dry matter content is approximately 35% or higher. By using amendments with very high structure, it is possible to have somewhat lower dry matter content and still maintain an aerobic process (Haug, 1993; Epstein, 1997).

To estimate whether the energy in the material for composting is high enough for thermal composting, Haug (1993) developed two rules of thumb. The highest energy usage in dry composting is the evaporation of water. Therefore, it is easy to use the ratio of mass of water to mass of biological volatile matter (W) to determine if the energy is sufficient to evaporate the water. If W (Equation 2) is below 8, the energy in the organic matter is enough to produce elevated temperatures in the compost. If W is greater than 10, the energy is not enough to evaporate the water in the material and therefore less drying of the material occurs during the process (Haug, 1993) and no especially high temperatures are reached.

$$W = \frac{m_{H_2O}}{m_{BVS}} \quad (2)$$

m_{H_2O} = mass of water

m_{BVS} = mass of the biological volatile substance

When using Equation 2, the assumption is that all of the organic matter has the same energy content per unit mass. This is not true in practice and if the energy content in the composting material is known, Equation 3 gives more detailed information on whether the heat production of the material is high enough for thermal composting. If the ratio of the heat released to the weight of water (E) is about 2.9 MJ g⁻¹ H₂O, the energy content is sufficient for composting and for evaporating the water (Haug, 1993).

$$E = \frac{H_r}{m_{H_2O}} \quad (3)$$

H_r = heat released

m_{H_2O} = mass of water

To attain temperatures high enough for thermal inactivation of pathogens, the heat has to be kept within the material. Some parts of the material still hold a lower

temperature, i.e. the surface of an open heap and the area around the incoming ventilation air. Thus the material does not have a homogeneous temperature and not all of the material is thermally disinfected, giving less inactivation of pathogens in the material. To get all material treated at elevated temperatures, it has to be turned so the parts that are in low temperature zones are moved into high temperature zones. To estimate the amount of surviving microorganisms if there is total inactivation in the high temperature zones and no inactivation in the low temperature zones, Equation 4 can be used (Haug, 1993).

$$n_t = n_0 (f_1)^{N+1} \quad (4)$$

n_t = number of surviving organisms

n_0 = number of organisms initially present

N = number of pile turnings

f_1 = fraction of compost material in low temperature zones

Equation 4 can only be used if there is no regrowth of microorganisms in the material within the low temperature zones. Helminths and viruses cannot grow within the compost, but bacteria can. However, the equation will still give good information about the safety margins achieved from the treatment used.

Chemical treatments

Addition of chemicals to sewage products can be used for disinfection. Traditionally this has been done by addition of ash to latrines (Del Porto & Steinfeld, 1999). Different chemicals used have different effects; the main effects are those from use of acids (phosphoric acid), bases (ammonia) and oxidising agents (chlorine). The effects of these chemicals are mainly inactivation of protein (surface or cellular) or inactivation of the DNA/RNA strand (Burge et al., 1983).

When choosing chemicals for use as disinfectants for sewage products, an additional effect to take advantage of is the agronomic value of the substances in the disinfectants, e.g. use of $\text{Ca}(\text{OH})_2$, NH_3 , KOH and PO_4^{3-} (Allievi et al., 1994). By using chemicals having an agronomic value for the disinfection, the treatment is not merely an expense but also a way to increase the fertilising value of the product.

Chemical treatment with bases

When comparing the disinfection efficiency of ammonium hydroxide (NH_4OH) and potassium hydroxide (KOH) added in similar concentrations as base equivalents, Allievi et al. (1994) found a much higher inactivation of bacteria by the ammonia-based compound. This was probably due to the higher content of free ammonia for the samples where ammonium was added.

To observe the effects of ammonia on viruses at different pH values, Cramer et al. (1983) tested polioviruses and the bacteriophage F2 with a constant ammonia

concentration at different pH (7.1-8.6), thereby varying the concentration of uncharged ammonia (NH₃). At pH below 8 the inactivation was slow, D (the Decimal reduction value) >70h for polioviruses and >200h for F2 viruses. Above pH 8, the inactivation was more rapid but the F2 virus was found to be 4.5 times more resistant towards ammonia than the poliovirus. Therefore, the bacteriophage F2 was proposed for use as a deactivation indicator of Enteroviruses in sewage effluents disinfected by ammonia (Cramer et al., 1983).

The amount of free ammonia depends on the temperature, the pH and the ammonium concentration (Svensson, 1993). For deactivation using ammonia, different pH and temperatures have been tested and for bacteria a pH over 10 has proved to be sufficient for non-detection of viable organisms. According to Allevi et al. (1994) temperatures above 10°C are sufficient for having good effects and at temperatures below 5°C no effect from the ammonia will be detected. This is similar to the results Höglund (2001) found in urine that was stored at different temperatures, where no inactivation of *Salmonella typhimurium* 28b phage and rotavirus occurred during 6 months of treatment at 5°C. However at a temperature of 20°C, the D value for the same phage was 71 days, which was more than double the time for the D value of Rotaviruses treated in the same way, D=35 days (Höglund et al., 2002).

The inactivation mechanisms of viruses by ammonia have been investigated (Burge et al., 1983; Turner & Burton, 1997), and for single strand RNA viruses such as the poliovirus, the inactivation is caused by RNA rupture for temperatures below 50°C. For double strand viruses of both RNA and DNA, which are more stable, the deactivation is mainly caused by denaturation of the surface coating proteins (Burge et al., 1983; Turner & Burton, 1997).

For inactivation of *Ascaris* eggs in sewage sludge, a treatment of 2 months with an initial pH of 12.5 is required (Gaspard et al., 1995). In the same study, amounts of added lime giving a lower pH combined with a shorter incubation time resulted in a reduction of 66%. This is comparable to the results found by Carlander & Westrell (1999) for addition of ash to faecal matter, where the inactivation after nine weeks of storage was found to be between 50% and 100%.

Gantzer et al. (2001) investigated liming of sewage sludge reaching a pH of 12.4 for approximately 24h, without achieving a significant reduction in nematode eggs. They identified the application of lime to the sludge as the probable reason for the bad performance. This emphasises the problems with the application of chemical disinfectants and the fact that one must ensure that the chemicals are homogeneously mixed into the material. *Ascaris* eggs seem to be resistant to high pH for short periods, at least when the pH is increased by addition of non-ammonia containing bases (Gaspard et al., 1995; Carlander & Westrell, 1999; Gantzer et al., 2001).

The advantage of ash or lime addition to fresh latrine waste is a decrease in both smell and flies. One major disadvantage with the use of ash is the difference in alkalinity depending on the wood used. Therefore, no firm recommendations can be made regarding the use of ash in general.

One main effect from increasing the pH is the amount of free non-ionised ammonia. To get free ammonia the pH has to exceed 8 (Turner & Burton, 1997). Thus, when the pH is regulated by ammonia it does not have to be especially high, as in diverted human urine the average pH is between 8.5 and 9 (Höglund et al., 1998; Höglund & Stenström, 1999; Höglund, 2001) and addition of ammonia-containing chemicals to sewage sludge to produce a pH of 10 is enough (Allievi et al., 1994).

Also when using other bases to increase the pH, one main effect is from free ammonia (Herniman et al., 1973; Burge et al., 1983; Allievi et al., 1994). When using other bases the ammonia concentration is lower, and to reach a concentration of free ammonia high enough for deactivation of pathogens the pH has to be higher. For example, for addition of lime to sludge the pH has to be over 12.5 to have effects similar to ammonia addition to a pH of 10 (Burge et al., 1983; Werkerle & Albrecht, 1983; Allievi et al., 1994). At a pH over 11 will almost all of the ammonia be found in the uncharged state and at pH of 12.5 will probably the high pH itself also have effects towards the viability of the organisms.

The main reason for the disinfection effect by ammonia is that at high pH and temperature, the ammonia is found in its uncharged state, i.e. NH_3 (Ward, 1978; Cramer et al., 1983; Burge et al., 1983). Ammonia is in equilibrium between the uncharged state and the +I state (Equation 5).

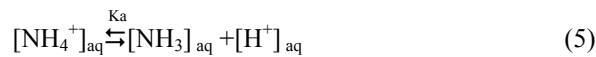

The equilibrium constant (K_a) in Equation 5 is determined by Equation 6. The equilibrium constant K_a has been determined empirically (Svensson, 1993) (Equation 7).

$$K_a = \frac{[\text{NH}_3]_{\text{aq}} \times [\text{H}^+]_{\text{aq}}}{[\text{NH}_4^+]_{\text{aq}}} \quad (6)$$

$$K_a = 10^{-\left(\frac{2729,92}{T} + 0,09018\right)} \quad (7)$$

T=temperature in Kelvin.

On measurement of the ammonia content, both charged and uncharged ammonia are detected $[\text{NH}_4]_{\text{tot}} = [\text{NH}_4^+] + [\text{NH}_3]$. Using the measured concentration of ammonia combined with Equation 6, it is possible to calculate the amount of uncharged ammonia in the solution (Equation 8) (Svensson, 1993).

$$[\text{NH}_3]_g = \frac{K_a [\text{NH}_4]_{\text{tot}}}{H(10^{-\text{pH}} + K_a)} \quad (8)$$

Thereby is it possible to determine the concentration of uncharged ammonia by measuring the pH, the temperature and the total ammonia content (Equation 8).

Using peracetic acid (PAA) for disinfection

Peracetic acid (PAA) is an unstable organic peracid that can explode at high concentrations and its decomposition is catalysed by contact with metals. PAA normally occurs as an aqueous quaternary mixture in equilibrium with acetic acid, hydrogen peroxide and water (Equation 9) (Arturo-Schaan et al., 1996; Liberti et al., 1999).

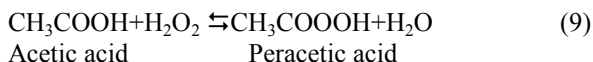

The biocidal action of peracetic acid is much stronger than the effects of hydrogen peroxide or acetic acid, from which it is derived and to which it ultimately decomposes (Equation 9; 10) (Liberti et al., 1999).

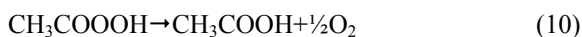

The biocidal effect of a PAA-H₂O₂ mixture is stronger than the effect of the substances by themselves, which indicates a synergistic effect (Alasari et al., 1992). The effects of PAA on microorganisms are reported to be disruption of the sulphhydryl (-SH) and sulphur (-S-S) bonds within enzymes and cell walls, dislocating the chemo-osmotic function of membrane transport (Lefevre et al., 1992). In nematodes and helminths, the disinfection is ascribed to denaturation of proteins (Baldry et al., 1991).

PAA has lately been introduced as an alternative to chlorination of outgoing wastewater (Baldry & French, 1989; Baldry et al., 1991; Arturo-Schaan et al., 1996; Liberti et al., 1999) and of materials and surfaces in hospitals (Thamlikitkul et al., 2001), and it has been shown to have good effects towards microorganisms even at very low concentrations, 0.15 ppm (Collignarelli et al., 2000), but the efficiency against both bacteria and viruses is lower compared to chlorination (Baldry & French, 1989; Baldry et al., 1991; Collignarelli et al., 2000). The efficiency against viruses and some parasites is lower than it is towards bacteria (Liberti et al., 2000).

The concentration of PAA has to be increased when increasing the organic matter content in the treated material to attain efficient inactivation of microorganisms (Baldry & French, 1989; Collignarelli et al., 2000). This is due to a combination of reactions between the peracetic acid and the organic matter and incorporation of the microorganisms and the organic matter.

When using this kind of oxidising agent on organic matter, a risk for production of foam occurs (JV, 1997; Turner & Burton, 1997). If not all bacteria are inactivated the risk for regrowth is high, especially when considering that the waste product,

acetic acid, can be used as a substrate by the bacteria (Liberti et al., 2000). Thus, the treatment of wastewater products should be performed as close in time as possible to the application as fertiliser.

Due to the high reactivity of PAA and its relatively harmless waste products (Equation 10), no or very small negative effects concerning mutagenicity or toxicity in plants have been identified from material directly applied after disinfection (Monarca et al., 2000). Thus, PAA is best used as a disinfectant just before application of the sludge to land.

Environmental effects from sewage treatment

The environmental effects differ when different sewage treatment options are compared. The treatment alternatives chosen for comparison are urine-diversion combined with faecal separation and a large-scale sewage treatment plant.

To be able to compare different systems for wastewater treatment the environmental effects have to be evaluated and compared to each other. Kärman & Jönsson (1999) presented a standard for choosing effects to compare the different systems by normalising them according to the effects from the sewage system compared to the total effects in Sweden. From this normalisation, it was possible to divide the fractions into priority groups. Priority Group 1 comprised the factors contributing >10% to the total Swedish environmental impact of resource usage/environmental effect per person, and Priority Group 2 the factors contributing 0.1%-10%.

Priority Group 1 (>10%)

- Discharges of N to recipient waters
- Discharges of Cd, Hg and Pb to recipient waters
- Recycling of P and N
- Flows of Cd, Cu, Hg and Pb to arable land

Priority Group 2 (0.1%-10%)

- Discharges of P to recipient waters
- Discharges of Cu to recipient waters
- Acidification
- Energy use
- Photo-oxidants
- Cd to landfill
- Global warming

By using the factors in the priority groups, there is little risk for pseudo optimisation of the system by optimising factors that are insignificant on a global scale. It should be borne in mind that local factors can have a great influence on the environmental analysis. Even if some effects are insignificant on a global scale, they can have significant effects towards the local habitat such as poisoning of a local recipient water body or increasing the local transport to an unacceptable

level. Therefore, even if using the priority set by Kärman & Jönsson (1999), the local habitat has to be borne in mind when deciding on comparison factors.

Composition of urine, faeces and greywater (Paper I)

Household wastewater consists of three separate fractions; urine, faeces and greywater. In conventional treatment of the wastewater, where all the fractions are treated as one, one important consideration is the composition of the mixed fraction ending up in the sewage treatment plant. However when aiming to recycle the nutrient content in the wastewater, the composition of the fractions differs widely and thus also the treatment needed and the possible use of the fractions.

To be able to decide how to use the fractions, their composition has to be known. During the 20th Century, the composition of the urine and faecal fractions was determined in medicine and, as mentioned above, the fractions reflect the food consumption of individuals so the expected amounts in the fractions are set as an average of what to expect from an average person. During the late 1990s in Sweden, the increased interest for recycling of household nutrients resulted in a new interest in the composition of the fractions and led to some measurements being performed, first on urine (Jönsson et al., 1997, 2000; Höglund et al., 1999; Vinnerås et al., 1999; Vinnerås, 2001; Papers I, III) followed by an interest in the composition of the different wastewater fractions (Papers I, III).

During the second half of the 20th Century, there was some focus on the greywater as a result of effects caused by the content of this fraction. Eutrophication of recipient waters by phosphorus discharges originating from detergents was one of the first noted effects of the composition of the greywater. During the late 1990s, the heavy metal content in greywater, which contaminates sewage sludge, has also come into focus (Moriyama et al., 1989; Koch & Rotard, 2000; Enskog Broman, 2000).

More analytical data, new ways to collect the material and more sensitive analytical methods for detecting elements even at low concentrations have made it possible to scrutinise the old designing values (NV, 1995) and propose new designing values for the composition of the fractions in household wastewater (Paper I).

The old designing values for the different fractions was derived in different ways, the composition of the urine and faeces were set by using several studies of the composition of the fractions combined with data on actual Swedish food consumption during the early 1990s (NV, 1995). In that study, 10% of food purchased was estimated to end up in the fraction of biodegradable solid waste, which was confirmed in the Ekoporten study (Vinnerås, 2001; Paper I). This makes these values solid and in the measurements performed in Paper I some values differed significantly. This was due to unexpectedly high amounts of some of the heavy metals analysed as a result of the influence of local collection strategy on contamination levels, e.g. copper pipes contaminated the urine mixture in

Ekoporten and zinc coating of the faecal pipes in Gebers contaminated the faeces (Paper I).

In the field studies in the two housing areas, some significant differences were detected, both compared to each other and to the designing values (NV, 1995), in the heavy metal content in the urine and the faeces. The higher amounts could not be excluded from being contamination from the collection strategies used and thereby did it not affect cutinisation present designing values.

The present designing values for the greywater is based on one short measurement in an ecological village, corresponding to approximately 400 person days, combined with flow analysis in a few other separated wastewater systems. The results from the measurements presented in Paper I, corresponding to 3050 person days, combined with the calculation of the composition of the sewage sludge produced in large Swedish cities generated reliable results of high validity, making it possible to scrutinise and propose changes to the present designing values.

Urine

When the urine volumes collected in the studies both in Ekoporten and in Gebers were recalculated to the urine production per person and year, significantly higher volumes of urine were collected compared to the old designing values. In Ekoporten 554 kg p⁻¹ y⁻¹ of urine was collected and in Gebers 510 kg p⁻¹ y⁻¹. In several other studies the amount of collected urine has corresponded to approximately 550 kg p⁻¹ y⁻¹ (Hellström & Kärrman, 1996; Jönsson et al., 1997, 1998, 2000; Vinnerås, 1998). Therefore a change in the present designing values from 365 kg p⁻¹ y⁻¹ to 550 kg p⁻¹ y⁻¹ was proposed.

Due to some methodological problems when collecting the urine, both in Ekoporten and Gebers, some misleading results were obtained. In Ekoporten some of the nitrogen was probably lost as ammonia emissions during handling of the samples (Paper III), while in Gebers approximately 32% of the phosphorus was probably lost due to deposition in the system and the sampling equipment (Andersson & Jensen, 2002) as noted earlier in studies by Vinnerås (1998).

In the double flush urine-diverting toilet system, some urine is impossible to collect, as it is misdiverted. Flooding of the urine bowl and misuse of the toilet mainly cause this. This has been identified as a major source of losses in several studies of the urine-diverting system (Paper III; Jönsson et al., 1997; Jönsson, Burström & Svensson, 1998; Vinnerås, 1998; Jönsson et al., 2000). After compensation for misdiverted urine and nutrients lost in the sampling equipment, the amounts of nitrogen and phosphorus collected corresponded well to the present designing values.

Table 2. The collected amounts of urine concerning wet mass, dry mass, BOD₇, COD, nitrogen, phosphorus, potassium, copper, chromium, nickel, zinc, lead, cadmium and mercury in the studies in Ekoporten and Gebers both measured (MD) and corrected for misplaced urine (CD) per person and year compared to the Swedish designing values (NV, 1995)

Parameter	Unit	Ekoporten		Gebers	Swedish designing values	Proposed new designing values
		MD	CD			
Wet mass	kg	376	554	510	365	550
Dry mass	kg	7	10	7.0	21	21
BOD ₇	g	-	-	1829		
COD	g	-	-	3723		
N	g	2500	3700	3830	4000	4000
P	g	230	340	250	365	365
K	g	800	1190	820	910	1000
Cu	mg	1490		17.2	37	37
Cr	mg	10.3		0.16	3.7	3.7
Ni	mg	32.7		3.65	2.6	2.6
Zn	mg	150		102	16.4	16.4
Pb	mg	15.3		4.2	0.73	0.73
Cd	mg	0.48		0.08	0.37	0.25
Hg	mg	0.30		0.16	1.1	0.30

The amount of potassium in the Ekoporten urine mixture was considerably higher than the expected amount according to the designing value (Table 2). In the study in Ekoporten the potassium content in the urine was 30% above the designing value and the content in the faecal water was almost 50% above the designing value, but in the study in Gebers the collected amounts were somewhat lower than the present designing value, both in urine and faeces. Several other studies of the composition of human urine performed during the late 1990s also showed high amounts of potassium compared to the other nutrients analysed and compared with the Swedish designing values (Jönsson et al., 1997, 1998, 1999, 2000; Vinnerås, 1998, 2001). The main reason for the higher amounts of potassium is probably a larger consumption of potassium, e.g. increased use of potassium-supplemented salt. Therefore a proposal is made for an increase in the designing value for potassium in urine to 1000 g p⁻¹ y⁻¹ (Table 2) This change also changes the ratio between the potassium in the urine and the faeces to a level more reflecting the expected physiological distribution of >70% in the urine and <30% in the faeces (Berger, 1960).

The essential heavy metals; Cu, Cr, Ni and Zn, are present in the diet and are also available in mineral supplements and are therefore influenced by the diet. These metals also have a high presence in materials used in society. In Ekoporten, the amounts of the essential heavy metals collected were higher than expected, while the amounts in Gebers were about as expected. The high amounts in Ekoporten were probably due to misplaced domestic cleaning water and corrosion of pipe material (Paper I; III).

The present designing value is based on the average Swedish diet (NV, 1995) but the amount of the investigated non-essential heavy metals (Pb, Cd and Hg) in Swedish society has decreased during recent years (Lohm et al., 1997; Balmér,

2001) and this has probably also affected the dietary intake of these heavy metals. However, the detected level of lead in the urine in Ekoporten was considerably higher than the designing value but the levels of lead in all of the analysed fractions in Ekoporten were high. The probable reason for the high levels was deposition of lead from propeller plane fuel used at the local airfield.

The amount of cadmium collected in the urine in Gebers was only one fifth of the Swedish designing value, while the amount collected in Ekoporten was comparable to the designing value. For mercury, both of the analyses gave levels considerably lower than the designing value, confirming the decreased flow of mercury in the society. Due to the significantly lower amounts of cadmium detected in Gebers and the low amounts of mercury detected in both analyses and the fact that the given designing value for mercury was a detection limit, it was proposed that the designing value for these two metals be lowered. The proposed new level for cadmium was $0.25 \text{ mg p}^{-1} \text{ y}^{-1}$ and for mercury $0.30 \text{ mg p}^{-1} \text{ y}^{-1}$ (Paper I).

Faeces

The dry matter of faeces and toilet paper collected in Ekoporten, $12.5 \text{ kg p}^{-1} \text{ y}^{-1}$ was considerably lower than the designing value, $12.7 \text{ kg p}^{-1} \text{ y}^{-1}$ for faeces and $8.5 \text{ kg p}^{-1} \text{ y}^{-1}$ for toilet paper (Table 3). In Gebers a somewhat higher amount of faecal dry matter, compared to Ekoporten, was collected, 10.0 kg , together with 8.5 kg of toilet paper used. This indicates a lower excretion of faecal dry mass than the designing value, which therefore is proposed to be somewhat decreased to 11.0 kg per person and year (Table 3; Paper I).

The amount of toilet paper used in Sweden ($8.5 \text{ kg DM p}^{-1} \text{ y}^{-1}$) (Anonymous, 1994) corresponds well to the amount used in Gebers, which can therefore be seen as a confirmation of the Swedish consumption (Paper I).

The wet mass of faecal matter at Gebers ($72 \text{ kg p}^{-1} \text{ y}^{-1}$) was twice the present designing value, which corresponds to a water content of 88% at Gebers and 63% in the designing value. Faeces collected from 20 adults had a water content of 77% (Lentner et al., 1981). The present designing value for wet mass is probably underestimated, so an adjustment is proposed to $51 \text{ kg p}^{-1} \text{ y}^{-1}$ (Table 3).

The nutrients collected in Ekoporten and Gebers differ somewhat compared to the present designing value. However apart from potassium, the values were not significantly different from the expected amounts. The differences are probably due to differences in the diet compared to the average Swedish diet.

Table 3. The collected amounts of faeces concerning wet mass (WM), dry mass (DM), nitrogen, phosphorus, potassium, copper, chromium, nickel, zinc, lead, cadmium and mercury in the studies in Ekoporten (En) both measured (MD) and corrected for misdiverted material (CD); and Gebers where the amount of toilet paper used (TP) is reported separately per person and year compared to the Swedish designing values for faeces (NV, 1995) flushwater and toilet paper (Anonymous, 1994)

	Unit	Ekoporten	Gebers		Swedish Value	Flush water	Toilet paper	Proposed new value
		CD	CD	TP				
WM	kg	18700 ^a	72 ^b	8.9	36.5	18300	8.9	51
DM	kg	12.6	10.0 ^b	8.5	12.8		8.5	11
BOD ₇	g	-	1223 ^c					
COD	g	-	1668 ^c					
N	g	630	710		550			550
P	g	126	250		183			183
K	g	540	280		365			365
Cu	mg	1060	628		400			400
Cr	mg	68	47		7.3			7.3
Ni	mg	110	81		27			27
Zn	mg	4860	16900		3900			3900
Pb	mg	460	13		7.3			7.3
Cd	mg	6.4	5.7		3.7			3.7
Hg	mg	2.8	3.2		23			3.3

^a flushwater included

^b faeces only, toilet paper (TP) excluded

^c including TP

The amounts of essential heavy metals collected in Ekoporten were somewhat above the expected amount but this could not be excluded as contamination from external sources such as domestic cleaning water poured into the toilet. In Gebers, the essential heavy metals in the collected material were fairly similar to the designing value except for the amounts of zinc, which were probably due to contamination from the zinc-galvanised pipes leading down to the collection bins. Therefore no changes are proposed in the designing values for the essential heavy metals.

In both of the investigated areas, the amounts of lead were significantly above the values in the designing value. The reason for these high levels is not known but the levels are too high to be related to the faeces itself. The high amounts are probably caused by some kind of contamination. However, the levels of heavy metals should be monitored more thoroughly to find their source and to see if the consumption is as high as indicated by the measurements (Paper I).

The levels of mercury in both areas were significantly below the present designing value, which was based on measurements from 10 people (Skare & Engqvist, 1992). A change in the designing value for mercury in the faeces to 3.3 mg p⁻¹ y⁻¹ is proposed (Table 3).

Greywater

The flow of greywater at the three investigated sites was $38 \text{ m}^3 \text{ p}^{-1} \text{ y}^{-1}$ in Ekoporten, $40 \text{ m}^3 \text{ p}^{-1} \text{ y}^{-1}$ in Gebers and $24 \text{ m}^3 \text{ p}^{-1} \text{ y}^{-1}$ in Vibyåsen (Table 4). These flows were all considerably lower than the present Swedish designing value of $55 \text{ m}^3 \text{ p}^{-1} \text{ y}^{-1}$ (NV, 1995). In a study performed by the Swedish EPA (NV, 1995), greywater from an ecological village was investigated and the magnitude of the greywater flow was in the same range as in our studies. One reason for the diminishing water consumption is the use of water-conserving equipment. The proposed new designing value for the greywater flow was $36.5 \text{ m}^3 \text{ p}^{-1} \text{ y}^{-1}$ (Table 4).

Potassium in the greywater at the three sites was also increased compared to the Swedish designing value (Table 4). The reason for this was probably an increased use of potassium, for example in liquid detergents and as a mineral supplement in table salt. An increase in the designing value for potassium to 365 g per person and year was proposed.

The major proportion of the heavy metal load to household wastewater was found in the greywater fraction. Yet all the new data on heavy metals in greywater were significantly lower than the present Swedish designing value, except for the copper (Paper I). The present Swedish designing values for greywater were mainly based upon measurements over seven days at sixteen apartments at the eco village Tuggelite in Sweden (NV, 1995), corresponding to approximately 400 person days. Data presented on greywater characteristics in this thesis correspond to approximately 3050 person days, plus calculations on the sludge from 605000 people connected to the Ryaverket wastewater treatment plant in Gothenburg, Sweden, over a 10-year period. Since discrepancies were revealed between the present designing values and the new greywater data for all of the metals studied, changes in the designing values for metals were proposed according to the following (Table 4).

Copper is the only metal for which the designing value is proposed to be increased. The concentration of Cu in the greywater is very sensitive to local conditions such as corrosion of the water distribution pipes and service pipes. Data from our studies in Paper I show chromium, nickel and zinc levels significantly below present designing values. The new proposed designing values for Cr, Ni and Zn were 365, 450 and $3650 \text{ mg p}^{-1} \text{ y}^{-1}$, respectively (Table 4).

The levels of lead were in all cases except for Ekoporten considerably lower than the present designing value. A probable reason for the high levels of Pb in the wastewater at Ekoporten was the nearby propeller plane airfield, where leaded fuel still is used. The new proposed designing value for lead was $365 \text{ mg p}^{-1} \text{ y}^{-1}$. The levels of cadmium (Cd) and mercury (Hg) in all the new greywater data were significantly below the present designing value. For Cd the proposed new designing value was $15 \text{ mg p}^{-1} \text{ y}^{-1}$ and for Hg $1.5 \text{ mg p}^{-1} \text{ y}^{-1}$.

Table 4. The collected amounts of greywater concerning wet mass (WM), dry mass (DM), nitrogen, phosphorus, potassium, copper, chromium, nickel, zinc, lead, cadmium and mercury in the studies in Ekoporten both given as measured value (MD) and any misplaced domestic cleaning water (CD), Gebers, Vibyåsen and Gothenburg per person and year compared to the Swedish designing values (NV, 1995)

	Ekoporten		Gebers	Vibyåsen	Göteborg	Swedish designing value	Proposed new designing value
	MD	CD					
WM	Kg	38000	40150	24236	-	55000	36500
DM	Kg	21.6	14.6	15.1	-	29.2	20
BOD ₇	g	-	7700	10100	-	10220	9500
COD	g	-	17500	14250	-	26280	19000
N	g	613	510	230	-	365	500
P	g	162	220	180	-	110	190
K	g	1450	350	200	-	180	365
Cu	mg	3010	2365	1497	2740	<2190	2900
Cr	mg	360	149	91.3	400	<1830	365
Ni	mg	300	87	266	590	<1100	450
Zn	mg	4800	2252	1570	3290	<18250	3650
Pb	mg	515	87	62.1	390	<1095	365
Cd	mg	11.3	5.1	2.19	17.2	<219	15
Hg	mg	3.8	1.1	0.37	<0.1	<21.9	1.5

Proposed new designing values for the Swedish wastewater fractions

Based upon the measurements in Ekoporten, Gebers and Vibyåsen, combined with the calculations on the sewage sludge in the Ryaverket wastewater treatment plant in Gothenburg, it was possible to scrutinise the present designing value for the composition of the wastewater (Paper I). The designing value for the solid biodegradable waste is also included. As the last of the organic fractions from households worth recycling, this fraction is also constantly under discussion for introduction as a fraction in the wastewater by the use of waste disposal units in the kitchen (Kärrman et al., 2001). The proposed changes to the designing value are printed in bold (Table 5), the old designing values for the different fractions can be found in Tables 2-4.

Table 5, The proposed designing value for composition of the different fractions of household wastewater and biodegradable solid waste per person and year, proposed changes are given in bold (Paper I)

		Urine	Faeces	Toilet paper	Greywater	Biodegradable waste
WM	Kg	550	51.5	8.9	36500	80.3
DM	Kg	21	11	8.5	20	27.5
BOD ₇	g	-	-	-	9500	-
COD	g	-	-	-	19000	-
N	g	4000	550		500	550
P	g	365	183		190	104
K	g	1000	365		365	82
Cu	mg	37	400		2900	549
Cr	mg	3.7	7.3		365	137
Ni	mg	2.6	27		450	82.3
Zn	mg	16.4	3900		3650	700
Pb	mg	0.73	7.3		350	275
Cd	mg	0.25	3.7		15	2.7
Hg	mg	0.30	3.3		1.5	0.25

Faecal Separation (Paper II, III)

As detailed above, the major proportion of the nutrients is found in the urine, which is a clean fraction with regard to heavy metal contamination. The next fraction that contains a lot of relatively clean nutrients is the faeces (Figure 2; 3; 4). Compared to the urine, which has water-soluble nutrients, the faeces contain both water-soluble nutrients and nutrients that are combined in larger particles not soluble in water. Still, about 50% of the nitrogen and the majority of the potassium in faeces are soluble in water (Berger, 1960; Trémolières et al., 1961; Guyton, 1992; Fraústo da Silva & Williams, 1997). Phosphorus is mainly found as calcium phosphate particles, insoluble in water (Fraústo da Silva & Williams, 1997).

By using urine-diverting toilets, the majority of household nutrients can be collected into the urine fraction (Jönsson et al., 1997, 1999, 2000; Höglund et al., 1999). With no urine mixed with the flushwater, only small amounts of nutrients

will be found dissolved in the water. Therefore it is possible to use water to transport the faeces to a unit that separates the water and a small volume, relatively dry, faecal fraction. This can be collected before secondary treatment and reuse as a fertiliser, while still making it possible to have the advantage of a flush toilet.

To determine possible length of the faecal transport before successful separation and whether it was possible to have a slow dewatering of the faeces, the biochemical activity was monitored by measuring the reduction and oxidation potential in a faeces:water mixture at different availability of oxygen (Paper II). The distribution of the nutrients between the solid and the liquid phase was also analysed to see how the nutrients were lost to the liquid fraction upon separation, over a filter with a pore size of 70 μ m.

When the faeces were immersed into the water, the redox potential was constantly reduced even when air was bubbled through the solution (Paper II). The largest drop in potential occurred when no oxygen was present. The speed of the change in redox potential of the mixture implies high enzymatic activity degrading the organic matter of the faeces, as observed also in the separated sludge in septic tanks (Philip et al., 1993). The high biochemical activity was also noticed by the increasing total concentration of ammonia, indicating a degradation of amino-containing organic matter (Figure 8).

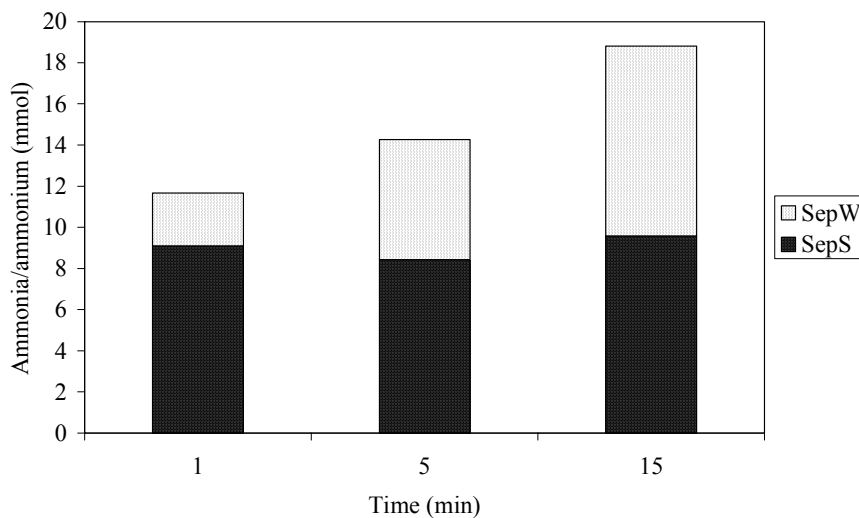

Figure 8. The distribution and the sum of ammonia over time in the two separated fractions separated water (SepW) and separated faeces (SepS) given as an average for all three treatments.

Even if no significant difference was found between the amounts of nutrients lost to the separated water fraction, there was a small tendency for higher losses at higher levels of available oxygen and thus a higher redox potential. This was expected due to the much higher levels of energy released when using oxygen as an electron acceptor compared to other compounds used under anoxic and

anaerobic conditions. The high energy content in the chemical reactions when oxygen is present gives more rapid reactions and thereby increased losses of the elements studied due to degradation of the material.

The increased amount of ammonia found in SepW indicated an increased loss of nutrients as a function of the time before separation. A lot of the nitrogen in faeces occurs as organic nitrogen, which forms ammonia upon degradation (Trémolières et al., 1961).

However, it was potassium that had the highest extraction rate of the elements analysed (Figure 9). This is due to the form in which potassium occurs in the faeces, i.e. mainly as free potassium ions (Berger, 1960; Guyton, 1992).

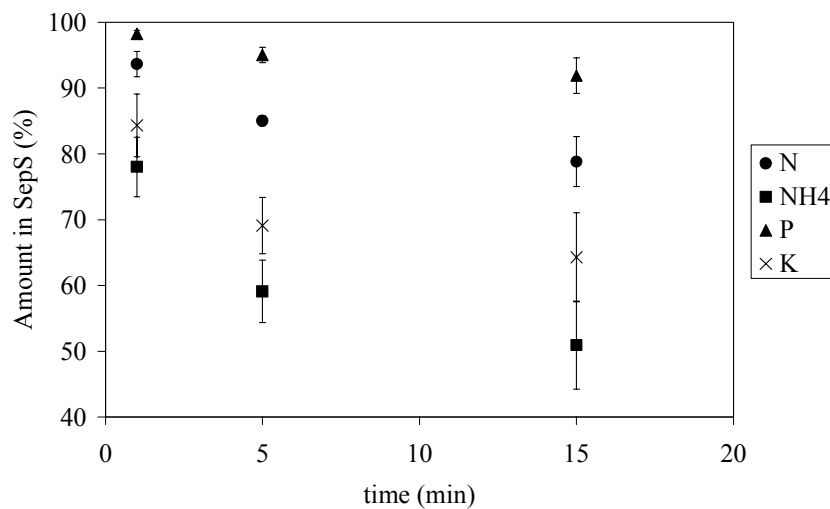

Figure 9. The average and the standard deviation of N, NH₄, P and K remaining in separated solids (SepS) after immersing the faeces in water for different periods of time.

Some increase in the loss of phosphorus was also observed but not as much as for the two other elements. In faeces, phosphorus is mainly found as granular calcium phosphate that seems to be captured in the 70µm filter used for the separation. Some smaller particles and some organically bound phosphorus released by the degradation of organic matter cause losses of nutrients in SepW.

This high biochemical activity results in losses both of elements released by degradation of organic matter and by extraction when the contact surfaces and contact time increase and a lot of the initially captured nutrients are eventually dissolved into the water as in septic tanks (Philip et al., 1993). Thus, if the aim of the separation is to recover faecal plant nutrients, it is important that the faeces and the water are separated as soon as possible, since nutrient recovery decreases rapidly with time.

Laboratory-scale evaluation of different separation techniques (Paper II)

Four different separation techniques were evaluated during these tests, namely flotation; sedimentation; filtration; and whirlpool, surface tension separation (Paper II). Separation by flotation and sedimentation was only tested in small initial tests. From those tests, it was apparent that for these methods the delay until two separate fractions were achievable was too long, when compared to the tests where the faeces were merged into water. These showed increasing rates of nutrient losses with longer contact time between the faeces and the water. Therefore, treatment by sedimentation and flotation were not considered as possible alternatives (Paper II).

The separation with filtration and whirlpool, surface tension separation in an Aquatron separator (Figure 10) was performed after a 1-metre vertical transport and a 1-metre horizontal transport, connected by a sharp 90° bend. Faeces were first applied to the pipe with a small amount of water and then the rest of the water was applied to simulate an ordinary flush (Paper II). This procedure resulted in a very turbulent transport in the pipe that broke down some of the structure of the faecal particles and gave them a larger contact surface, thus increasing the losses, from the separated faeces, of particles and nutrients during the separation.

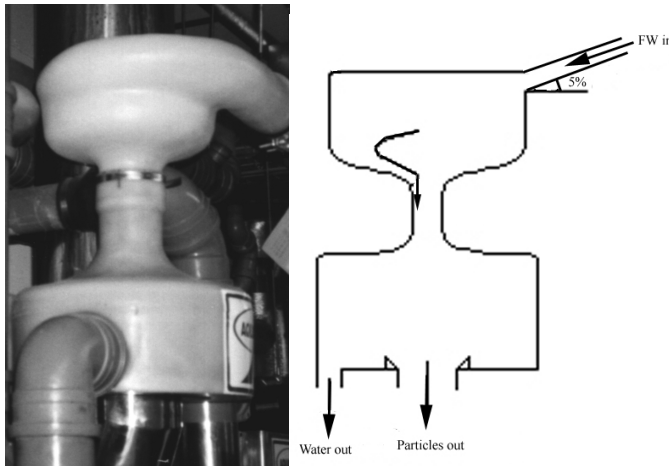

Figure 10. The whirlpool, surface tension separator Aquatron and a technical description of the function, FW=incoming Faecal Water.

The two separation techniques fully investigated gave similar separation of the analysed elements, approximately 70%, with some differences in the distribution between the elements (Figure 11). The difference in distribution of the elements was probably due to differences in their forms and an effect of the separation process.

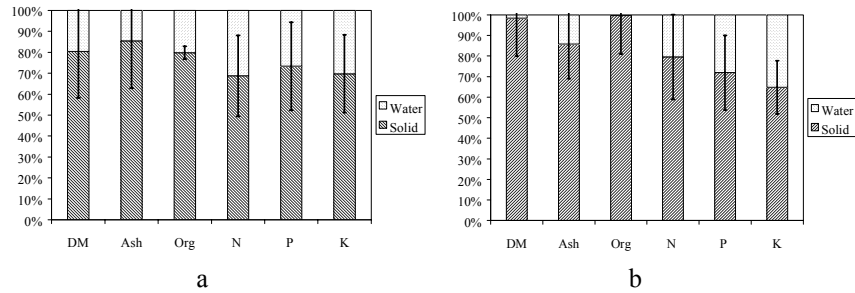

Figure 11. The distribution of DM, Ash, Organic matter, N, P, K between the liquid and the solid fraction when using (a) whirlpool, surface tension separation and (b) filtration.

The whirlpool, surface tension separation process separates the particles that are unable to follow the walls of the separator, while particles that are suspended in the water follow the separator walls to the separated water fraction. The material lost mainly consists of suspended particles and, as can be seen in Figure 11a, the percentage losses of all parameters were similar.

In the filtration, more of the potassium and less of the nitrogen was lost (Figure 11b). The probable reason was the increased contact time between the particles and the water, compared to the whirlpool, surface tension separation. No visible larger particles were detected in the separated water after the filtration (Paper III) and the losses of dry matter and organics were negligible (Figure 11b). The lost nutrients can therefore be assumed to be nutrients extracted from the particles during transport and filtration.

During filtration, the filter cake functions as a supplement to the filter, but the first material captured is washed by water passing through the filter. This effect, together with the fast degradation and high activity in the faeces that were merged into water, indicates the need for a rapid removal of the filter cake to avoid losses of nutrients due to degradation and extraction.

Controlled pilot-scale separation of faeces and toilet paper by using whirlpool, surface tension separation

The promising results from the laboratory-scale studies of the faecal separation, using whirlpool, surface tension separation indicated that this method could be a promising alternative for collecting the faecal nutrients in a small and dry fraction and still using a flush urine-diverting toilet (Paper II). Therefore, a pilot-scale system was built to investigate the potential of whirlpool, surface tension separation with a toilet and 5-metre vertical drop, corresponding to a two-story building, before the separation (Figure 12).

The system consisted of a toilet placed above a 5-metre vertical pipe connected to two 45° bends, giving a gradual 90° bend. This was connected to a 1-metre horizontal pipe with a 4% gradient linked to the whirlpool, surface tension separator (Figure 12). The gradual 90° bend was chosen as a result of observations

in the laboratory-scale study (Paper II), where the sharp bend resulted in disintegration of the faecal particles.

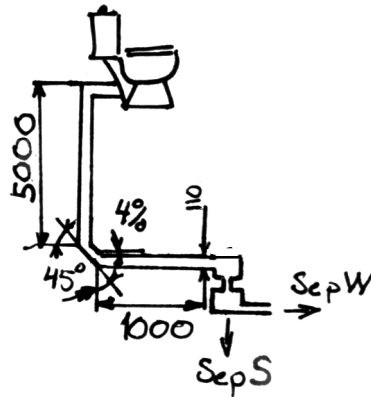

Figure 12. The pilot-scale whirlpool, surface tension separation system used for investigating the effects on separation of water volume and toilet paper use.

Four different combinations of separated material and flushwater volume were tested in the system:

1. Faeces flushed with four litres of flushwater.
2. Toilet paper flushed with four litres of flushwater.
3. Faeces and toilet paper flushed with four litres of flushwater.
4. Faeces and toilet paper flushed with six litres of flushwater.

On average, 50 ± 5 g of faeces and 27 ± 3 g of toilet paper were applied to the toilet before flushing. In cases where both faeces and toilet paper were flushed, the faeces were added first, followed by the toilet paper. Ten seconds after addition of the material to the bowl, the toilet was flushed. Four series of five flushes were performed for each material combination, giving a total of 20 flushes per separation strategy. The separated mass was noted and weigh-proportional samples were taken from every series. The samples were analysed for their dry matter (105°C for >24 h), ash ($>550^\circ\text{C}$ for >4 h), nitrogen (Kjeldahl), phosphorus (ICP-AES), potassium (ICP-AES) and sulphur (ICP-AES) content.

The amounts of flushwater used in separation strategy number 3 varied a lot ($\pm 10\%$) (Table 6) due to the use of an extra flush to remove a blockage caused by toilet paper in the pipe. Some tests were also performed where only 2 litres of flushwater were used to flush 3×9 g of toilet paper. In these tests, only every second flush managed to flush the paper all the way to the separator, in the other cases the paper became stuck in the initial bend in the toilet and needed another flush to be transported to the separator.

Table 6. Amounts of material separated and collected matter for the different material combinations per series of 5 flushes

Mtrl Comb.	Mtrl in kg	H ₂ O in L	Mass SepS kg	Mass SepW Kg	DM SepS kg	DM SepW kg
1	0.27±2.4%	19.1±2.0%	0.60±12%	19.0±2.4%	0.055±17%	0.008±93%
2	0.044±4.2%	20±1.6%	1.7±5.8%	18±2.7%	0.046±5.1%	0.0022±41%
3	0.29±3.5%	20±10%	2.0±7.5%	19±12%	0.10±21%	0.006±21%
4	0.31±3.2%	29±0.9%	2.7±12%	27±2.0%	0.11±5.4%	0.009±28%

The flushwater used was also analysed for its content of nitrogen, potassium and sulphur. Therefore, the distribution of the nutrients between the two fractions is given both according to the analysis results (m) and calculated results (c) in which the nutrients in the water used for flushing were deducted (Table 7; 8).

The concentrations of the elements collected in the separated water differed greatly, giving a high standard deviation. However, in the separated faeces the collected amounts were more stable, both within each material combination and between the different material combinations (Table 7). The concentration of the elements nitrogen and potassium in the water used for flushing corresponded to approximately 10% of the total amounts, while for sulphur approximately 30% came from the water used. These initial concentrations are important to bear in mind when evaluating separation systems by analysing the two separated fractions.

There were two main effects of including toilet paper in the separation in addition to faeces, namely an increase in the total mass and the amount of dry matter collected in SepS (Table 6; 8). The effect of the collected mass was that when no paper was used, the amount of material collected in SepS was only 3% of the total mass. When toilet paper was included, the mass was between 8.5% and 9.6% due to absorption of water by the paper. Thus, the effect of collected volume was highly influenced by the toilet paper, mainly due to its water absorption capacity. Therefore, the number of flushes with toilet paper should be kept to a minimum. Paper used on occasions other than defecation should either be collected in a bin beside the toilet or in the rear bowl of the toilet and only flushed away when needed.

The amounts of collected and analysed elements in the SepS fraction after correction for the content in the flushwater were higher when smaller amounts of flushwater were used (Table 8). The probable reason for this is an increased disintegration of the faecal particles due to the larger water volume, but it still seems to be possible to collect approximately 85% of the faecal nutrients in this kind of system.

Table 7. Amounts of nitrogen, phosphorus, potassium and sulphur in the two fractions of separated water (SepW) and separated faeces (SepS), per series of 5 flushes, with both the measured value (m) and the calculated value (c), in which the initial content of the element in the flushwater was deducted

Material comb.	N SepS mg	N SepW mg	P SepS mg	P SepW mg	K SepS mg	K SepW mg	S SepS mg	S SepW Mg
2m	3500±16%	760±46%	1200±11%	215±44%	1000±13%	520±16%	330±8.9%	290±10%
2c	3500±17%	310±110%	-	-	1000±13%	330±25%	320±9.0%	76±36%
3m	3300±22%	710±38%	1100±19%	180±18%	900±22%	470±11%	320±23%	260±8.5%
3c	3300±22%	270±81%	-	-	880±22%	280±13%	300±24%	69±3.2%
4m	3200±11%	1350±44%	1300±17%	240±9.4%	880±5.5%	610±7.3%	300±12%	380±1.8%
4c	3100±11%	710±83%	-	-	850±5.9%	340±15%	270±14%	88±13%

Table 8. Fractions (%) of the flushed matter and elements recovered in the fraction of separated faeces depending on separation strategy used. For the elements nitrogen, potassium and sulphur, both the value measured (m) and a calculated value (c), in which the initial influence of the flushwater was deducted are shown

Mtrl. comb	Mass	DM	N (m)	N (c)	P	K (m)	K (c)	S (m)	S (c)
1	8.5%	95%	-	-	-	-	-	-	-
2	3.0%	87%	82%	92%	85%	66%	75%	53%	81%
3	9.6%	94%	82%	92%	86%	66%	76%	55%	81%
4	9.1%	92%	70%	81%	84%	59%	72%	45%	76%

The difference in separation between the elements analysed, and how the separation was influenced by the flushwater volume used, is probably due to the different forms of the elements in the faeces, e.g. nitrogen is mainly bound in organic matter (Trémolières et al., 1961), phosphorus is mainly bound as granular $\text{Ca}(\text{PO}_4)$ and potassium occurs mainly as free ions (Fraústo da Silva & Williams, 1997). The tendencies for N, P and K were the same as in the laboratory-scale studies in Paper II. However, more nutrients were collected in SepS in these studies (85%) compared to the laboratory-scale studies (70%) (Paper II). The main reasons for the difference are probably that in the laboratory-studies no correction was made for content of the elements in the flushwater and higher disintegration occurred due to the sharp 90° bend in that study. It seems more important to have a gradual bend than to keep the height of the vertical drop very small.

If the system is built correctly, it appears possible to use whirlpool, surface tension separation in buildings with several floors keeping the separation equipment on the ground floor or in the basement. Larger systems mean longer transport and higher disintegration of the particles, which leads to increased loss of nutrients. However, it seems possible to collect the main proportion of the nutrients in the drier fraction of separated faeces also in correctly built fairly large systems.

Full-scale separation of faeces in the Ekoporten block of flats (Paper III)

In the Ekoporten block of flats, all 18 apartments are equipped with urine-diverting toilets and the faecal bowl of the toilets is connected to two parallel whirlpool, surface tension separators (Figure 10) in the basement. The separated solids are led to a continuous composting reactor, where they are treated together with the biodegradable household waste using pelletised sawdust as an amendment (Paper III).

The initial analysis of the collected material showed poor recovery of the nutrients from the faecal fraction. However, after correction for misdiverted urine according to the weight of the fraction, the separation of the faeces appeared fairly good. In the fraction of separated solids (SepS), 13% of the total mass, 37% of the dry matter, 59-73% of the nitrogen, 58% of the phosphorus and 45% of the potassium were recovered (Figure 13). The range in nitrogen recovery depended on the correction for lost nitrogen from the urine mixture during handling of the samples before analysis.

Comparing the laboratory-, pilot- and full-scale studies reveals that much more nutrients were captured in the two small-scale studies than in the full-scale one. On average 55-60% of the nutrients were collected in the full-scale study (Figure 13; Paper III), 70% in the laboratory-scale separation studies (Figure 11; Paper II) and 80-85% in the pilot-scale separation studies (Table 8).

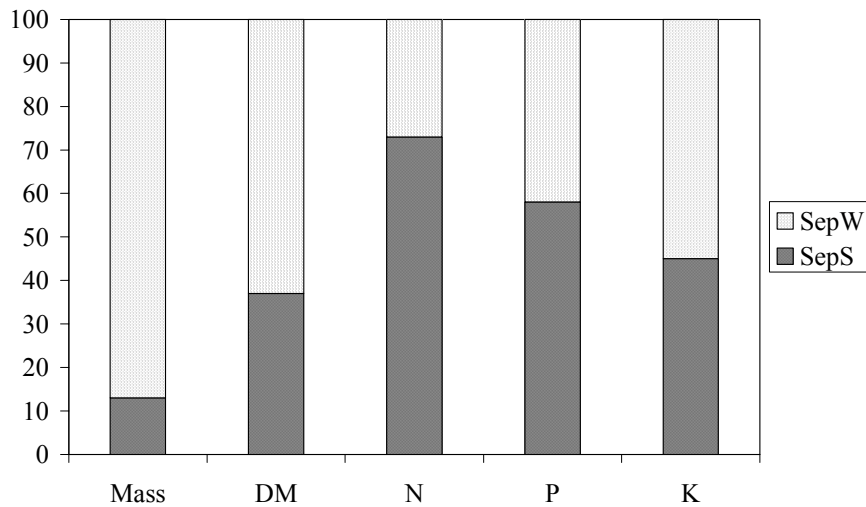

Figure 13. The distribution of mass, dry matter, nitrogen, phosphorus and potassium between the two separated fractions separated solids (SepS) and separated water (SepW) in the Ekoporten block of flats after correction for the misdiverted urine mixture and the nitrogen loss during handling.

The reason for these large differences between the different studies can be related to several circumstances. In the collection in Ekoporten (Paper III), a lot of urine was collected (32%) in the faecal fraction and the correction for this gave uncertain values, especially for nitrogen. At first, the difference was linked to the size of the system and the large drop in Ekoporten (4 stories) compared to the 1-metre drop in the laboratory (Paper II). However after the pilot-scale study (above), where the separation was performed after a 5-metre vertical drop where the collection of the nutrients into SepS was higher compared to the laboratory-scale experiments, it seemed as though other factors had a larger impact on the efficiency of separation than the vertical drop.

According to the producer of the whirlpool, surface tension separation system Aquatron, the system in Ekoporten is not optimal for the separation due to the incorrect gradient of the pipes connected to the separator (Åkesson, 2002). However, one factor that seems to have a large influence is the bend connecting the vertical and the horizontal pipes. In the laboratory and the full-scale studies, the bend was a sharp 90° angle but in the pilot-scale study two 45° bends were used to give a more gradual bend, which decreased the impact and reduced the disintegration of particles and the loss of nutrients to the separated water.

Important issues when using faecal separation

The pilot-scale tests (above) showed during the adjustments of the flushwater volume that it was possible to reduce the amount of water collected in SepS to as

little as 0.2% when only water was flushed. The investigation in Ekoporten showed that the majority of the heavy metals from domestic cleaning water poured into the toilet ended up in SepW. However, it is still important not to pour the domestic cleaning water into the toilet in this type of system (Paper III). The high concentration of heavy metals in the cleaning water and the high density of metal particles, which increases their separation, combined with the comparatively low heavy metal content in the faeces indicates that domestic cleaning water should be disposed of somewhere else if the solids collected in the toilet are to be recycled.

The whirlpool, surface tension faecal separation system is fairly insensitive towards domestic cleaning water, as the majority is found in SepW (Paper III). Other systems where all material from the toilet is collected unseparated, i.e. both vacuum and low flush blackwater systems are much more affected by misplaced contaminated water.

The effect on volume collected in SepS of the number of flushes depended on whether any other material also was flushed. If toilet paper was flushed, about 8-10% of the water became separated into the separated solids fraction (SepS), but if only water was flushed, the effect was not noticeable. Therefore, toilet paper used on occasions other than defecation should if possible be disposed elsewhere, either collected in the rear bowl and flushed at need or collected in a bin beside the toilet. The effect of this is considerably less water to handle in the SepS fraction.

The effect of the flushwater volume used is relatively small (see above). When the volume of the flushwater used increased by 50%, the increase in SepS was just a few percent (Table 8). Of greater importance here is the risk for blockages when insufficient volumes of flushwater are used. However, somewhat larger nutrient losses occur when the flushwater volume is increased, probably due to higher disintegration of the faecal particles and thereby higher extraction rate and a larger amount of small non-separable particles.

For optimal function of faecal separation as regards nutrient capture, the urine has to be diverted. The faecal separation depends on larger particles and the nutrient content in the urine is soluble in the water and is therefore not possible to separate to SepS. By using a urine-diverting toilet, the major proportion of the nutrients from the urine can be captured in a separate liquid low volume fraction (Jönsson et al., 1997, 1999, 2000; Vinnerås, 2001).

One alternative to faecal separation that guarantees that all nutrients are collected separately without any water addition is to use dry urine-diverting toilets (Figure 6). In the Western world of today, where people are used to water closets, it would be hard to reintroduce dry toilets. In large parts of the world, however, any kind of toilet would be an improvement, compared to open field defecation. Using urine-diversion combined with faecal separation makes it possible to recover the major proportion of the nutrients from households in unpolluted fractions and still use the advantage of a water closet.

If filtration is used instead of whirlpool, surface tension separation, the filters should have a short detention time. Filters with long detention times lead to large losses of nutrients due to degradation of the material combined with the washing of the filter cake by the following separations (Paper III).

Disinfection of faeces (Papers IV, V)

To ensure safe recycling of plant nutrients from sewage products, potential pathogens have to be inactivated. Otherwise there is a large risk for transmission of diseases when recycling wastewater products.

Disinfection of human urine is possible by storage. This is mainly due to a combination of low content of organic matter, high amount of free ammonia and high pH. After six months of storage at 20°C, the urine can be used as a fertiliser even for foods consumed raw by humans (Jönsson et al., 2000; Höglund, 2001).

For other wastewater products, such as faeces and sewage sludge, storage is not an efficient disinfection alternative. The differences in these materials compared to the urine are lower pH and less ammonia. Thus, the amount of free ammonia is not high enough to have satisfactory antibiotic effect towards the microorganisms (Werkerle & Albrecht, 1983; Allievi et al., 1994; Gantzer et al., 2001). The large content of organic material also affects the inactivation of pathogens negatively by providing both physical protection and as energy for the organism metabolism.

When there is a high water content of the materials anaerobic degradation occurs. This degradation, without oxygen as oxidising agent, will result in rest products that have negative effects to the environment (Flodman, 2002).

Two high-tech alternatives for disinfection of sewage products such as faeces and sludge with dry matter contents between 1% and 10% dry matter are liquid composting and thermophilic anaerobic digestion. These systems have to be used on a large scale to be economically feasible alternatives, and in a lot of cases when the systems are used for toilet waste, additional organic matter, such as solid waste and manure, has to be added. The energy requirement of these systems is also high, e.g. for wet composting, the aeration is the single most energy-demanding part of the sewage system (Kärman et al., 1999; Skjelhaugen, 1999a-b).

Alternative systems to those available today have to be developed for disinfection of biodegradable waste products from society, to make it possible to recycle them in a safe way. The alternatives investigated in this thesis were dry thermal composting and chemical disinfection using ammonia and a peracetic acid/hydrogen peroxide mixture. One main advantage with these methods is their scale independence, which makes them viable alternatives both for treatment of waste products from single households and treatment of the sewage sludge from large treatment plants.

Thermal composting of separated faecal matter (Paper IV)

Investigations into the disinfection of faeces by composting have been performed both in Ethiopia (Karlsson & Larsson, 2000) and in Mexico (Björklund, 2002b). These did not show any significant rise in temperature apart from an approximately 10°C increase above the surrounding temperature during the first days of treatment. Different reasons for this small rise in the temperature were

identified, such as insufficient insulation and low energy content due to addition of ash during collection of the faeces.

To see if it was possible to get high temperatures (>50°C) by dry composting of faeces, a laboratory-scale study and a pilot-scale study was carried out with different mixes of faeces, urine and food waste combined with amendment (Paper IV). The laboratory studies were performed in 1-litre Dewar vessels (Figure 14), and the temperature and the degradation of organic matter were monitored (Paper IV).



Figure 14. One of the Dewar vessels used for laboratory-scale experiments on thermal composting.

Four different mixtures were tested (Table 9) and amendment (chopped straw) was added to all of the mixtures. The amount of amendment used strongly depended on the water content in the rest of the material. Amendment (straw) was added to reach an initial dry matter content of approximately 35%.

Table 9. The composition of the material composted in the different vessels during the laboratory study (% of wet weight and % of dry matter) F=faecal matter, FF=faecal matter + food waste, FFU=faecal matter + food waste + urine & FU=faecal matter + urine

Vessel	Amendment		Faeces		Artificial food waste		Urine	
	ww	dm	ww	dm	ww	dm	ww	dm
F	15%	41%	85%	59%	-	-	-	-
FF	10%	20%	65%	33%	25%	47%	-	-
FFU	15%	38%	6%	4%	24%	58%	55%	1%
FU	28%	93%	7%	6%	-	-	65%	1%

Pelleted dog food was used as artificial food waste. The advantage of using pelleted dog food as artificial food waste in this kind of test is the assurance of getting a homogeneous mixture in all of the test vessels. In these tests, the dog food was left as pellets to compensate for the lack of cellular structure present in regular food waste, which results in a lower direct availability of energy and nutrients in the material. Other researchers have also used dog food as artificial food waste (Nagasaki et al., 1996).

The composition of the dog food was similar to that of the standardized food waste mix used by Eklind & Kirchmann (2000), which was a mix of ground potatoes (65% of dry matter), carrots (15%), meat meal (13%) and bone meal (7%). The

major difference between the dog food used here and the waste used by Eklind & Kirchmann (2000) was the ash content, which was 5.9% and 19% respectively. It is 13-37% in regular biodegradable household waste (Sonesson & Jönsson, 1996; Eklind et al., 1997). On the other hand, the ash content of the kitchen waste collected at the site of the pilot-scale testing was lower (2%) than that of the dog food used here (Paper IV).

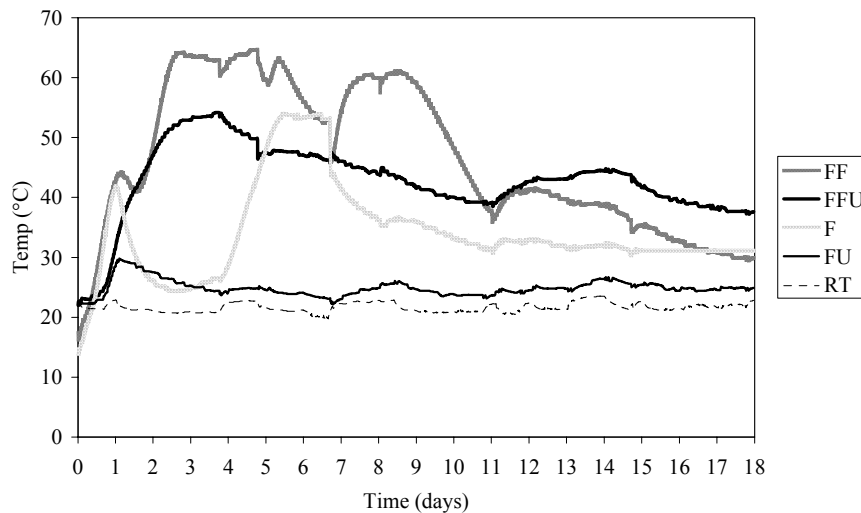

Figure 15. The temperatures during composting of the different mixtures in the laboratory-scale study, amendment was added to all mixtures (Table 9), FF (Faeces, Food waste), FFU (Faeces, Food waste, Urine), F (Faeces), FU (Faeces, Urine) and, RT (Room temperature).

In the vessel with faeces, urine and straw amendment (FU), the increase in temperature was only 10°C during the first days (Figure 15), as in the tests in Ethiopia (Karlsson & Larsson, 2000) and Mexico (Björklund, 2002b). The high water content in the latrine (urine + faeces) resulted in high amounts of amendment needed (28% of wet weight and 93% of the dry matter content) to reach an initial dry matter content in the mixture of 35%.

According to Equation 2, the energy in the material should be sufficient to reach elevated temperatures if we assume a biological degradation of faeces and urine comparable to that of pig manure (58%), and of straw 55% (Haug, 1993). That degradation is for a time span of 120 days and the assumption can be made that the degradation during the 20 days in this investigation was smaller and thus smaller amounts of heat were produced. The measured degradation of the organic matter was 10% and when used in Equation 2, this gave a ratio of water content to biological volatile substance of 23, which indicates that there was insufficient energy present in the mixture to vaporise the water. The small increase in temperature showed that this kind of mixture is not a suitable substrate for thermal disinfection by composting.

The mixture with faeces and straw only (F) had a temperature development comparable to the one with faeces, food waste and straw (FF). After 24 hours, the

activity in the faecal and straw mixture (F) more or less stopped and the temperature decreased from over 40°C down to 25°C, probably due to low water content. After watering and mixing, the temperature rapidly increased at day 4 up to over 50°C (Figure 15), indicating high energy content, and the degradation of the organic matter was 21%. However, the pure faecal matter was very sticky and thus hard to keep structured and aerated.

The mixture of food waste, faeces, and urine (FFU) gave a constant high temperature (Figure 15) and the second highest degradation (39%). One of the major problems when including urine into the composting substrate is the increased water content that has to be compensated for by addition of amendment, resulting in very large volumes to be treated. The urine, with its high nitrogen content, also increases ammonia emissions due to the high temperatures and the high pH.

The mix that gave the highest temperature (>65°C, Figure 15) and the highest degradation of organic matter (53%) was faeces and food waste (FF). The temperature was over 50°C for more than eight days, indicating a high and stable activity. However, the temperature fluctuated a lot during this time (Figure 15). The main fluctuation was probably caused by the small mass that was treated (approximately 400 g wet weight). Thus, it is important to mix the material often and to reset the water content regularly.

The substrate mixture that gave the highest temperatures and degradations was the faeces and food waste mixture (FF) and therefore this mixture was used in the pilot-scale experiment. The only difference was that the amendment was changed from straw to matured compost and the food waste used was regular food waste collected on site (Paper IV).

The pilot-scale composting was performed in a 90-litre bin, insulated with 200 mm of plastic foam on all sides (Björklund, 2002a). The aeration was secured via a ventilation hole in the lower part of one side. The temperature in the compost rapidly increased to approximately 40°C and then remained stable until day 11, when the compost was mixed and the temperature increased to over 60°C (Figure 16).

A temperature gradient from the middle of the compost towards the walls of the bin was identified (Figure 16). This emphasises the importance of using sufficient insulation so the influence of the outdoor temperature is kept as small as possible. The insulation is important even when composting in high temperature climates if thermal composting is desired. Even with the large amount of insulation used here, 200 mm of plastic foam; the material close to the ventilation hole probably did not reach high temperatures.

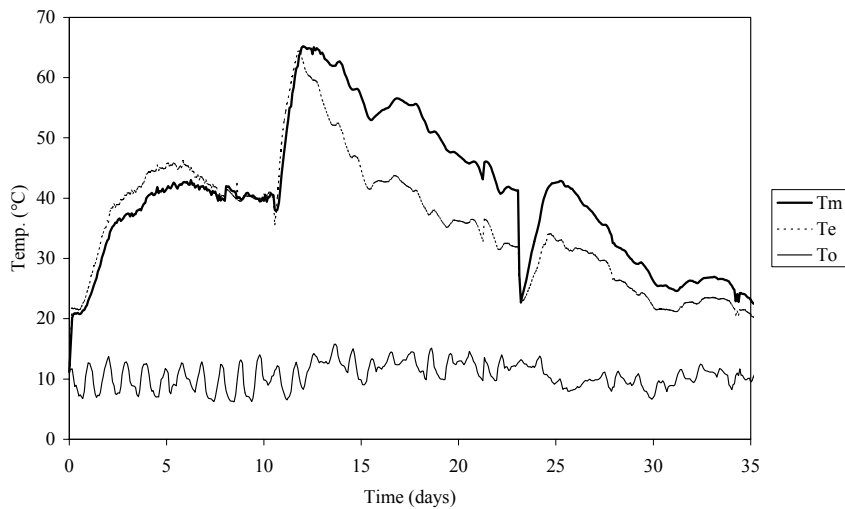

Figure 16. The average temperature every 10 minutes in the middle of the compost (T_m), at one of the walls of the compost (T_e) and in the surroundings (T_o) for the pilot-scale experiments (Paper IV).

The importance of keeping a high temperature throughout the reactor is to ensure that all of the material is thermally disinfected (see below). To avoid these lower temperature zones, the ventilation air has to be preheated somehow. This can be done in a heat exchanger for the outgoing air, which can simultaneously be treated against emissions of odours and ammonia losses by condensing its moisture. In the condensated liquid the majority of odour agents and ammonia will also be captured (Haug, 1993; Skjelhaugen, 1999b).

Another way to preheat incoming air is by placing organic matter with a higher hygiene status, e.g. food waste, closest to the air inlet and using its biological activity to increase the temperature of the incoming air. Upon turning, the material will have to be moved to another cell, which has been similarly prepared with fresh organic matter closest to the ventilation hole, so no un-disinfected material ends up in the low temperature zone and thus escapes thermal disinfection.

Large-scale composting reaches disinfection temperatures fairly easily due to its temperature stability deriving from the large mass. The monitoring does not have to be as intense as in the case of the small-scale composts. However, composting is a biological process and the more closely it is monitored and controlled, the easier it is to get a well functioning process.

The degradation of organic matter in the composts was high. Even though the duration of the treatment was short, 19 days for the laboratory-scale experiments and 35 days for the pilot-scale experiments, the degradation was 53% and 73%, respectively. The general degradability of organic waste and faeces is between 55% and 80% (Haug, 1993), so one can assume that the stability of the material, especially from the pilot-scale study, was high and that the material was well

suited for use as a soil conditioner. In addition, there is unlikely to be any reheating of the material on application to soil.

In many cases, ash is added to the faeces during the collection in the toilet, a practice especially common in developing countries. The ash dries out the material and increases its pH. This prevents smells and flies and gives some inactivation of pathogens, but not a complete disinfection. One other effect from this is that the concentration of organic matter decreases, leaving less energy available to increase the temperature. This is probably one of the reasons why high temperatures were not reached in the tests on composting of faeces in Ethiopia (Karlsson & Larsson, 2000) and in Mexico (Björklund, 2002b). To achieve sufficiently high temperatures, a high-energy amendment has to be added to the material, for example fruit peelings. The compost also has to be well insulated. However, this has to be investigated further to confirm mixtures and functions.

Disinfection of faeces

By using Equation 1 and the equations for the time required for inactivation for different pathogens given in Table 1, it is possible to calculate the safety margins for total die-off of different pathogens, i.e. where no more viable organisms should be found in the laboratory-scale and the pilot-scale composts (Table 10). The lowest safety margin was found to be the margin for the Enteroviruses, where the faecal and food waste mix (FF) in the laboratory-scale experiment had a safety margin of 130 times total inactivation, which can be considered an extremely high margin. The mix of faeces, food waste and urine (FFU) did not reach the same elevated temperatures as FF. The safety margins were therefore much smaller, for Enteroviruses only 8 times and for salmonella and *Ascaris* only 14 and 15 times, respectively. However, this is still a reasonable margin of safety when handling this material.

In the pilot-scale study, the temperature was high during a longer period (Figure 15), even at the wall, compared to the lab-scale experiments (Figure 16). Also in this case, the calculated safety margin for inactivation of pathogens was smallest for Enteroviruses, 37 times. For the other pathogens, for which a limit of inactivation was given by Feachem et al. (1983), the limit was fulfilled more than 100 times, e.g. for *Salmonella*, *Shigella* and *Ascaris*, the calculated safety margin was larger than 100, for *Taenia* eggs and *Schistosoma*, the safety margin was more than 1000 and for *Enteric hystolica* and *Cholera* the safety margin was larger than 100000.

This shows, as Figure 7 indicates, that the organisms least affected by the treatment are Enteroviruses and *Ascaris*. *Salmonella* can also be considered to be quite resistant towards thermal treatment. Therefore, when estimating the safety margins as in Paper IV or when using organisms for thermal deactivation or evaluating existing processes, these three organisms or organism categories, of the above mentioned (Table 1), should if possible be included in the evaluation. Other organisms can be included but as shown in Figure 7, the upper temperature/time limit is set by Enteroviruses from approximately 51°C, and below that temperature

the limit is set by *Ascaris*, but the limit for no viable *Salmonella* is in the same region during the temperature interval of 45-65°C. Of the other organisms mentioned, the inactivation at these temperatures is so high (Table 10) that only if the organisms are of special interest do they need to be studied more closely in thermal composting.

Table 10. The safety margin for disinfection of the faecal compost as the number of times the limit of no viable organisms found was fulfilled in the two most prominent mixes tested in the lab-scale (FF=Faeces+Food waste; FFU=Faeces, Food waste & Urine) and the wall and the middle of the pilot-scale reactor

	FF	FFU	Wall	Middle
Enteroviruses	130	8	37	110
<i>Cholera</i>	700 000	3 000	170 000	720 000
<i>Salmonella</i>	670	14	170	600
<i>Shigella</i>	1 800	50	480	1 600
<i>Enterohystolica</i>	650 000	540	150 000	800 000
<i>Ancylostoma</i>	2 300	70	610	2 100
<i>Ascaris</i>	2 300	15	550	2 200
<i>Schistosoma</i>	24 000	200	5 900	23 000
<i>Taenia</i>	4 100	120	1 100	3 600

This experiment showed that by mixing faeces, food waste and amendment, it is possible to reach high temperatures, thus securing the disinfection of pathogens in the material. Spores of bacteria will probably not be affected by these temperatures, although the fluctuation in temperature arising from mixing and adding water is reminiscent of a tyndalisation process that will affect the number of surviving spores (Stanbury et al., 1995). However, there is still a risk for regrowth of pathogenic bacteria if any survive the treatment or re-contaminate the material.

Unfortunately the temperature of the compost material directly at the air inlet was not recorded. The temperature here was probably lower than in the rest of the compost. By using Equation 4 it is possible to calculate the number of times the material has to be mixed to attain a certain level of disinfection (Haug, 1993). The equation assumes that you have total inactivation in the high temperature areas, that the material is completely mixed in turning and that no inactivation or regrowth occurs in the low temperature areas.

When low temperature zones are present, the pathogens will not be deactivated within all material and there will therefore be an increased risk for regrowth of pathogenic bacteria in the low temperature zones after thermal composting that has to be considered. However, the risk for regrowth in composted material is smaller compared to undegraded material (Sidhu et al., 2001) so composting will decrease the risk even if some bacteria survive in the low temperature areas.

The high safety margins show that well functioning thermal composting is an easy method for disinfection of material that can be used as a fertiliser and soil conditioner with very small risks for transmission of diseases, provided that all the material is disinfected and that the handling of the raw material is done with care.

Regardless of the efficiency of the composting process, one major risk for transmission of disease is contact with the raw material when starting the compost and with not fully disinfected material upon turning it. Management of this risk requires good working practices, worker information and possibly some degree of automation. Since one of the major causes of *Ascaris* transmission is contact with raw faeces, this is an important factor to consider when planning this kind of system. Precautionary measures have to be taken by informing the users of this system and those who handle the matter, to avoid transmission of diseases.

The use of a closed compost reactor where the turnings are mechanised can decrease the risk for transmission of pathogens. One extra advantage with a closed reactor is the possibility to capture the energy of the outgoing air by heat exchange and condensing the water. In the condensed liquid, up to 85% of the ammonia emissions can be captured together with smelly organic matter (Beck-Friis et al., 2001). Thus, both the captured heat energy can be used and the effects of ammonia emissions and odour agents on the surroundings can be reduced.

After treatment, the material will be at risk for re-infection by pathogens. To avoid this, the equipment used to move the disinfected material and the place where the matter is stored should be free from pathogens. Otherwise, there will be a risk for regrowth of pathogenic bacteria.

Chemical treatment of separated faecal matter (Paper V)

The characteristics of the two chemical disinfection methods tested were completely different. The peracetic acid is a rapid disinfectant that has its main effect within one hour after addition, while urea addition has a slower, and delayed, effect since the added urea has to be degraded to ammonia before disinfection starts.

Treatment with peracetic acid (PAA)

The main characteristic of PAA is its high oxidative activity. This high activity results in reactions with all kinds of organic matter decreases. Thus the content of organic matter can be a damper on the inactivation of organisms. Content of organic matter can also result in production of foam. During these treatments, the volume of the material was doubled due to foam production.

The effect of PAA on microorganisms is that surface proteins are denaturated, mainly by destroyed sulphur- and sulphonic-bonds. As PAA is an oxidising agent, upon reaction it is reduced to acetic acid (Equation 10) and the hydrogen peroxide to plain water (Equation 11). As the chemicals are reduced, the sanitation ability is consumed as can be seen in Figure 17, where there was no significant difference in numbers of organisms for the *Salmonella* phage between one hour and five days. For *E. coli* and *Enterococcus* spp the numbers of organisms increased by regrowth, to a level higher than the initial concentration, as the active substances were degraded. Also, the otherwise resistant clostridia spores were reduced by the treatment (Figure 17).

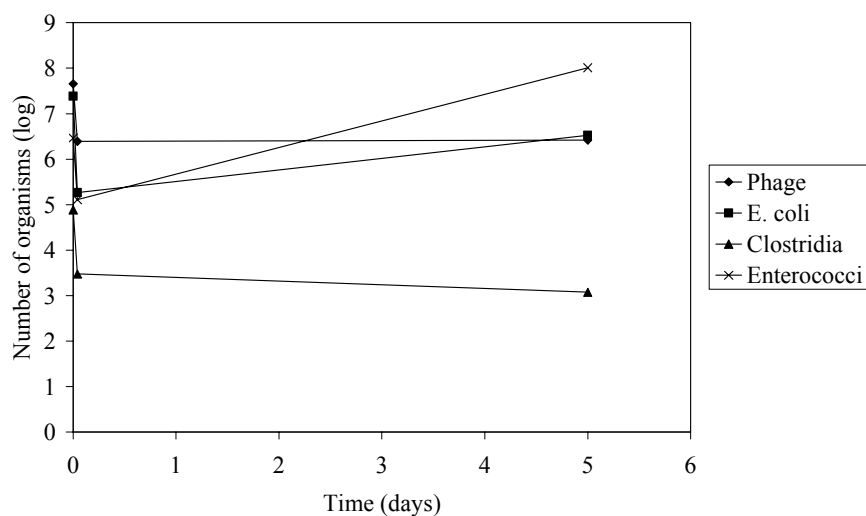

Figure 17. Reduction in viable organisms 1h and 5 days after treatment of faecal matter with 0.15% peracetic acid.

Due to the short period of active disinfection of the faecal matter, another test was performed by increasing the concentration of PAA to 0.5%, 1.0% and 1.5% of active substance in the final mixture. The only time of treatment monitored for these concentrations was 0.5 days (12 hours). A significant increase in disinfection of the monitored organisms was recorded as the concentration of the active substance was increased. At 0.5% PAA it was still possible to determine viable organisms, while at the higher concentrations no living organisms were detected at all.

Table 11. Reduction compared to the initial concentration in \log_{10} of microorganisms on addition of PAA to levels of 0.5%, 1.0% and 1.5% of active substance, > is when no viable organisms were found and thereby the reduction is larger than the detection limit

Organism	Initial conc.	PAA _{0.5%}	PAA _{1.0%}	PAA _{1.5%}
<i>S. Typh.</i> 28B	7.97	3.82	>5.97	>4.97
Clostridia	4.53	2.4	>3.53	>3.53
Enterococcus	6.06	3.87	>4.06	>4.06
<i>E. coli</i>	Detected ~6-7	Detected	Not detected	Not detected

At these high concentrations of added PAA, it can be considered very safe to recycle the treated faecal matter. The recommendation from the Swedish Board of Agriculture for treatment of manure in farms with Epizootic diseases is that an application of 4.5-6.4% of PAA (JV, 1997) seems to be the required dosage to achieve a sufficient reduction in viable pathogenic organisms for safe recycling.

An additional effect from the PAA treatment is a significant smell reduction, even at the lowest added concentration. It appears that PAA is an alternative for this kind of material with such high organic matter content when the need for disinfection is high, i.e. when there is a large risk for epidemics, e.g. in refugee

campylobacters. However, it seems to be more efficient as a disinfectant for liquids and should therefore preferably be used for material with a low organic matter content.

Treatment with Urea

Compared to PAA, urea treatment is a slow method of sanitation. The urea itself is not toxic and is actually found in many body lotions and toothpastes, but when it is degraded to ammonia and carbon dioxide by the enzyme urease it becomes antibiotic. Due to the need for degradation of the urea, this treatment requires about one hour of incubation before it is actually active as a disinfectant.

If the pH is buffered at a neutral value (~7) the sanitary effect from the ammonia produced will be negligible as the main effect is from uncharged ammonia (NH₃), which only occurs in low concentrations at that pH.

When the pH increases, the ammonia produced has an effect. In the tests performed in Paper V, where 30 g of ammonia nitrogen equivalents as urea were added, the pH increased to above 9.2 within one hour. The disinfection effect towards *E. coli* and *Salmonella* was rapid, and the D-value (decimal reduction value) for inactivation of *E. coli*, when including the time for degradation of the urea, was >0.6 days as no viable organisms were detected (<1 log₁₀) within 5 days of treatment (Figure 18; Paper V).

The Enterococcus spp were more resistant towards the ammonia with a D-value of 3 days and no viable organisms were detected within 21 days of treatment (<2 log₁₀) (Figure 18). The last bacteria group analysed was spore-forming clostridia, which did not show any significant reduction by the treatment.

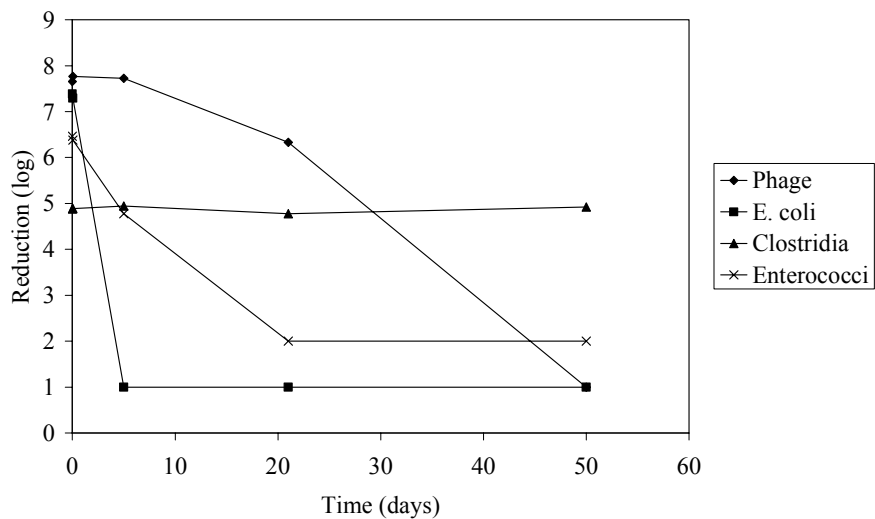

Figure 18. Reduction in viable organisms 1h, 5 days, 20 days, and 50 days after treatment of faecal matter with 3% of urea nitrogen.

The very ammonia-resistant bacteriophage *Salmonella typhimurium* 28B phage was used as a model organism for viruses. The D-value for the phage was <7.5 days (Figure 18; Paper V). As this phage has been shown to have double the resistance of Rotaviruses and 20 times the resistance of poliovirus, the main proportion of the pathogenic viruses should be inactivated within two months of treatment.

Ascaris suum eggs were used as an indicator for parasites and a reduction in the viability of the nematodes was detected. Within five days of treatment, the viability had decreased by 15% compared to the controls. After 50 days of urea treatment no viable *A. suum* were detected. The faecal matter itself also seems to be enough for significant inactivation of the *A. suum* viability as only 0.2% of the cysts were viable. These lethal conditions were reduced by the PAA treatment as no significant difference in the viability was detected between day five and day 50 at 0.15% of added PAA.

The treatment of separated and collected faecal matter with urea seems to be an efficient and safe way of achieving hygienically safe material within 2 months of treatment at room temperature. At the same time, the fertiliser value of the faecal matter will increase as the added urea nitrogen is still available as a plant nutrient after the treatment, together with the original content of nutrients in the faecal matter.

Risk of regrowth after disinfection treatments

One of the major risks after disinfection is the risk for regrowth of bacteria. Even if no organisms are detected, it is possible, if any organism survives, that regrowth of bacteria will occur as an effect of changes in the environment in the material. Another potential risk is the post-treatment handling of the material before application. If the treatment effect diminishes, there will be a risk for seeding of pathogens by contact with untreated matter in the post treatment handling.

When thermal treatment such as pasteurisation is used, the stability of the material is unaffected or decreased. Thus, there is a large risk for regrowth of pathogenic bacteria if present due to the presence of available organic matter and the absence of competing organisms. If the thermal treatment is performed by composting instead, the risk for regrowth is smaller, but still present (Sidhu et al., 2001). The risk for regrowth is reduced both by competing, non-pathogenic organisms, and a reduction in readily available organic matter (Paper IV).

When PAA is used for disinfection of faecal matter, the treatment of the material have to be performed within a few days before application to avoid problems with regrowth of bacteria. In the treatment with 1500 ppm PAA, *E. Coli* had regrowth to one log₁₀ more than the initial concentration within five days after the application of PAA (Paper V).

When using disinfection systems in which the disinfection agent is removed (e.g. heat) or consumed during the treatment (e.g. PAA), it is therefore important that the material be applied to arable land as soon as possible after the treatment.

Another approach to the disinfection is to use a disinfection agent that is not consumed during the treatment. One example of this is the use of high pH, e.g. by applying ammonia to the material.

The risk for regrowth after the ammonia treatment is small, as the effect of ammonia does not decrease during the treatment provided that there is no change in pH and temperature and no ammonia loss by air emissions. After urea application, the enzyme urease degrades the urea to ammonia and carbon dioxide. The ammonia produced increases the pH and under these conditions it has a high antibiotic effect. If the treatment is performed in a closed container (no ammonia loss), there is no risk for regrowth of bacteria (Paper V).

If pathogens are added to the material during the handling, the environment will be as lethal as for pathogens present in the material from the start. In all cases of disinfection treatment, there is a risk for surviving pathogens if the material is non-homogeneous or if the treatment is non-homogeneous so that untreated volumes of the material remain where organisms can survive. However, if the effective factor remains in the material until application there is no risk of regrowth within the treated part of the material and if a chemical treatment is used, the risk for untreated parts occurring decreases with time as the chemicals strive for equilibrium within the material.

Comparison of sewage treatment strategies

A comparison was performed for two parts of the system, the primary treatment of toilet water and the secondary treatment of the wastewater products intended to be recycled to agriculture.

For the primary treatments, the effects of handling the urine and the faeces were compared, i.e. urine-diversion and faecal separation were compared to treatment at a large wastewater treatment plant (WWTP). When evaluating the quality of the fractions other, in the wastewater treatment plant, co-treated materials were considered as contaminants, i.e. greywater and industrial wastewater. As the phosphorus in the greywater also is recycled in the sludge from the wastewater treatment plant it was included as a recyclable nutrient. The different systems were compared according to Priority Group 1 (Kärman & Jönsson, 2000) the amount of N, P and K it was possible to recycle to the arable land, the amount of heavy metals contaminating the recycled fertilisers, water emissions and according to Priority Group 2 (Kärman & Jönsson, 2000) the total energy usage for the systems. Other factors in Priority Group 2 (Kärman & Jönsson, 2000) were not included in the comparison.

For the secondary treatments, the comparison was performed regarding disinfection efficiency; risk for regrowth; and energy usage. The different treatment scenarios compared were storage; liquid composting; dry composting; pasteurisation; and chemical treatment by urea and peracetic acid (PAA).

Comparison of different primary treatments

The comparison between the different systems was expanded so the benefits from the systems according to fertiliser recovery were equal (Figure 19). When differences in production of nutrients between the systems investigated were identified, the most favourable system was set as the standard and the other systems were charged with the environmental effects from external production of nutrients to arable land (Figure 19). No compensation for differences in heat or biogas production was included in the comparison. One of the main heat sources was the treated wastewater itself, from which the heat could be recovered by a heat exchanger, but as no change in the water consumption was taken into account, no differences in this heat recovery were noted between the different treatment systems. The change in biogas production could not easily be foreseen in the different treatment scenarios, and therefore the biogas production in the sewage treatment plant was not included in the comparison.

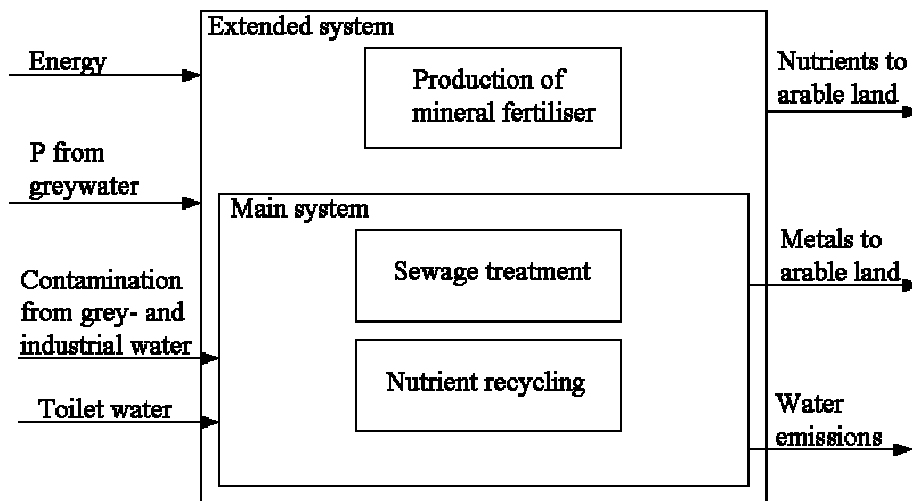

Figure 19. The main system and the extended system in the comparison for the different wastewater treatment systems. In the evaluation the toilet water treated and the amount of nutrients (N, P and K) to arable land are kept equal for the different systems.

As the greywater has to be treated in all of the systems discussed, it was not included as an energy consumer during the treatment, except for the extra energy needed when calculating the production of the extra phosphorus fertilisers to equal the large wastewater treatment plant system as the phosphorus in the greywater is included in the recycled sludge. One alternative for treatment of the wastewater, especially as an alternative for single households, is to use a septic tank combined with a soil filter. The energy usage in such a system is minimal but so is the nutrient recovery and, as the production of the nutrients is the main energy consumer and none of the nutrient resources are recovered, this kind of system was not included in the comparison.

Nutrient recycling

Depending on collection strategy for faeces and urine, different amounts of nutrients can be collected. If a blackwater (BW) system is used, all of the nutrients from the urine and the faeces can be collected. This corresponds to approximately 90% of the N, 74% of the P and 79% of the K in household sewage water (Figure 20). However, these systems usually have problems with too large amounts of water diluting the collected fraction, both large amounts of flushwater and other water added to the toilet, such as domestic cleaning water. When the toilet waste was collected separately, no sludge from the sewage treatment plant was assumed to be recirculated to agricultural land, nor was the handling of this sludge included in the evaluation of these systems.

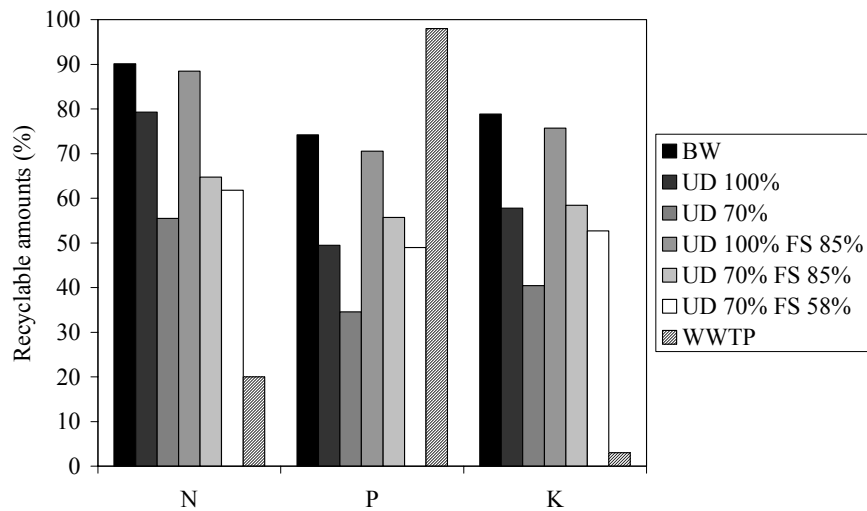

Figure 20. Amounts of nutrients from the household wastewater collected and available for recycling to arable land depending on collection strategy or treatment method, BW=Blackwater UD=Urine-diversion FS=Faecal separation, WWTP=sludge from a large wastewater treatment plant, the following percentage figure gives the amount of the fraction collected.

When only the urine is collected, by using urine-diverting toilets, and all of the urine is collected (UD 100%) 79%, 49% and 58% of the N, P and K, respectively are collected. When, as in Ekoporten (Paper III), 70% of the urine was collected (UD 70%) the collected amounts were 55% N, 35% P and 40% K (Figure 20). A combination of well motivated users and well functioning urine-diverting systems could increase the collection of the urine to closer to 100% diverted than the 70% measured in Ekoporten (Paper III).

When urine-diversion is combined with faecal separation (FS) more nutrients are collected. The optimal system would be if all the urine was collected and, as in the pilot-scale study, 85% of the faecal nutrients were separated. Then 88% of the N,

71% of the P and 76% of the K would be collected in a low volume easy recyclable fraction (Figure 20). If the system were more like the one in Ekoporten, where 70% of the urine was diverted and on average 58% of the faecal nutrients were separated, 62% N, 49% P and 53% K would still be separated to a low volume and easily recyclable fraction (Figure 20)

Quality of the recycled products

When comparing the collectable and recyclable amounts of the nutrients from the wastewater to the possibilities for nutrient recycling via the sewage sludge from wastewater treatment plants, urine-diversion and faecal separation recycle less P, as the greywater contributes 26% of the P in the wastewater, and significantly more N and K are recycled (Figure 20). An additional effect of separate collection of the toilet waste is the avoidance of heavy metals and other contaminants from greywater and other sources (Paper I). These normally pollute the sewage water and finally end up in the sludge (Table 12). So when aiming for recycling of unpolluted nutrients from households, a large proportion of this can be achieved by recycling the separated toilet fractions.

Table 12. Amounts of heavy metals in mg per person and year that accompany the recyclable nutrients in Figure 20 BW=Blackwater UD=Urine-diversion FS=Faecal separation (Paper I), WWTP=Sewage from a large-scale wastewater treatment plant (Balmér, 2001)

	Cu	Cr	Ni	Zn	Pb	Cd	Hg
BW	440	11	30	3900	8.0	4.0	3.6
UD 100%	37	3.7	2.6	16	0.73	0.25	0.3
UD 100% FS 85%	380	9.9	26	3300	6.9	3.4	3.1
UD 70% FS 58%	260	6.8	17	2300	4.7	2.3	2.1
WWTP	12000	1400	2100	22000	1600	56	36

If the urine and the faeces are removed from the sewage water, only the greywater is left. This is a large volume fraction with a relatively high total amount of contaminants, both heavy metals and organic pollutants, which have to be treated. Most sewage treatment systems of today are not constructed for the composition of the greywater, and in some cases industrial water and stormwater, but rather for mixed household wastewater. The focus for sewage treatment during the past century has been the large environmental effects such as polluting particles and eutrophication by phosphorus discharge. Therefore, treatment plants are currently adapted to the functions of removing these fractions from the wastewater. If the main proportion of the nutrients is to be removed, the purpose of the sewage treatment plant will have to be rethought, in particular regarding how their function may have to be adapted to remove the pollutants such as heavy metals and organic substances to prevent them from entering the environment. Thus the focus will have to be kept more on protecting recipient waters and less on how to make the sewage sludge as clean as possible. Effects of the organic pollutants in effluent have already been identified, e.g. changes in the sex of male fish caused by organic hormone mimicking substances in wastewater (Tilton et al., 2002).

Water emissions

If the remaining wastewater after some or all of the toilet water is removed are treated in a large wastewater treatment plant the emissions of phosphorus will not be affected as the emissions are regulated as concentrations in the effluent. However, the need for treatment and precipitation chemicals will decrease as will also the energy usage for nitrogen removal. The major effect will be for the emissions of potassium, as the regular treatment only removes a few percent of the potassium, and for nitrogen in systems where the nitrogen not is removed.

If the same system of sewage treatment is used after the majority of the nutrients have been removed by urine-diversion and faecal separation (Figure 20), the need for chemical precipitation of phosphorus will decrease and if no changes are made to the treatment system.

Energy usage

Looking at the total energy usage of water production and wastewater treatment, water production uses approximately 40% of the energy (Kärrman et al., 1999; Kärrman, 2000). The amount of energy used in water production is mainly correlated to the volume produced. Therefore, differences in water consumption of different toilet options have a significant impact on total energy usage. However, this was not taken into account, as water consumption is hard to predict for the different toilet systems. When used correctly, the water-saving potential of urine-diverting toilets is high, especially for those where the faeces are collected dry, e.g. in Gebers only approximately 0.5 m³ of flushwater was used per person and year (Andersson & Jensen, 2002) compared to the Swedish design values of over 18 m³ p⁻¹ y⁻¹.

The energy usage for treatment of the toilet water in the wastewater treatment plant was calculated according to the flow and the composition of the incoming wastewater. Used energy for the treated water volume was calculated as the energy for pumping, in the sewers (0.1 MJ m⁻¹) and in the wastewater treatment plant (2.7 MJ m⁻¹) in Gothenburg (Balmér et al., 2002). For the removal of BOD₇ and nitrogen the aeration energy were according to Balmér et al. (2002) 3.6 MJ kg⁻¹ and 10.3 MJ kg⁻¹, respectively (Table 13). The energy for producing chemicals for phosphorus removal (Frodhagen, 1997) was included in the energy usage of the wastewater treatment plant in Table 14. Approximately 20 kg of PIX 111 was assumed to be used per kilogram of removed phosphorus (Tidåker, 2002), which corresponded to an energy usage of 55 MJ kg P⁻¹ (Table 13), and the amount of phosphorus removed corresponded to the average percentage removed in the sewage treatment plant Henriksdal in Stockholm (98%) (SVAB, 2002). These values were then used for calculating the energy needed for treatment of the water in a large-scale wastewater treatment plant.

Table 13. Energy usage for treatment of wastewater in a regular wastewater treatment plant (Balmér et al., 2002) and for production of PIX 111 for phosphorus removal (Frodhagen, 1997)

Variable	Unit	Energy usage
Flow	MJ m ⁻³	0.37
Biological oxygen consumption	MJ kg ⁻¹ BOD ₇	3.6
Nitrogen	MJ kg ⁻¹ N	10.3
Production of PIX 111 for P removal	MJ kg ⁻¹ P	55

In the large wastewater treatment plant only the energy usage for treating the toilet water was estimated, but due to the uncertain water usage by the different systems, the same amount of treatable flushwater was used for the different systems evaluated except for the blackwater, as no water enters the sewer in this system (Table 14).

Table 14. The energy usage of electricity, steam and, oil (MJ p⁻¹ y⁻¹) in the different steps of wastewater treatment in the systems evaluated and the corresponding transport length (km, one way) possible using an ordinary truck (Sonesson, 1998), and with the same total energy usage in all systems. The systems compared were: blackwater collection (BW); urine-diversion (UD) with different diversion efficiency (in percent); and in some cases combined with faecal separation (FS) with different separation efficiency (in percent); and finally a large sewage treatment plant (WWTP)

Alternative Sort	WWTP MJ p ⁻¹ y ⁻¹	Nutrients MJ p ⁻¹ y ⁻¹	Spreading MJ p ⁻¹ y ⁻¹	Total MJ p ⁻¹ y ⁻¹	Transport Km
BW	0	5.4	13	18	117
UD 100%	27	42	12	81	106
UD 70%	47	109	8.7	165	91
UD 100% FS 85%	9.7	11	13	34	113
UD 70% FS 85%	30	79	9.5	118	103
UD 70% FS 58%	36	88	9.2	133	100
WWTP	95	192	5	292	0

The energy usage for production of supplementary nutrients, which was needed to equalize the amounts of nutrients in all systems. The amounts of recycled household wastewater nutrients were set to be: 90% of the nitrogen as in the blackwater, 98% of phosphorus as in the WWTP scenario and 79% of potassium as in the blackwater (Figure 20). The energy values for production of supplementary nutrients were taken from Davis and Haglund (1999), and urea (47% N) (52 MJ kg N⁻¹) was used as the mineral nitrogen fertiliser due to its similar plant availability compared to the nitrogen recirculated from the toilet fractions, P₂O₅ (21% P) (31 MJ kg P⁻¹) was used as the phosphorus fertiliser and mined KCl (52% K) (5.7 MJ kg K⁻¹) was used as the potassium fertiliser. The energy usage for the fertiliser production is displayed in Table 14 as the sum of the total energy usage from electricity, steam and, oil.

The energy usage for the recycling of the plant nutrients was calculated based on spreading of the liquid material with a hose spreader at a dosage of 80 kg plant available nitrogen per ha. The mass spread per person in the blackwater system was assumed to be 550 kg of urine plus 550 kg of flushwater and 195 kg of

separated faecal matter (19.5 kg of dry matter with a dry matter content of 10%), and the separated mass was assumed to correspond to the amount of separated nutrients. Approximately 9-13 MJ was used per person and year for spreading the urine and the faeces in the separating systems. In the other sorting systems (urine-diversion and faecal separation) the percentage not collected were deducted from the mass and the nutrient content of the material spread. The sewage sludge was assumed to have a dry matter content of 20% and therefore be spread as dry matter using approximately 5 MJ p⁻¹ y⁻¹, the dry matter mass collected was set to 60 g per person and day (Balmér, 2001) in the WWTP system.

The main energy usage was for the supplementary production of nutrients to bring the same amount of plant available nutrients to arable land in all cases (Table 14). Summing up all the energy used, the conventional wastewater treatment (WWTP) used the most energy (Table 14). In the other cases, the energy saved was used to calculate the possible distance for transporting the material by an ordinary truck (Sonesson, 1998) without exceeding the energy usage by the WWTP system.

For a system like Ekoporten, where 70% of the urine was diverted and 58% of the faecal nutrients were separated, the maximum distance for transporting the material was 97 km, while the blackwater system permitted up to 116 km of transport without using extra energy (Table 14). The most favourable system combining both urine-diversion (100%) and faecal separation (85%) allowed a transport of the material up to 111 km, with an ordinary truck (Sonesson, 1998), before spreading.

Comparison of secondary treatments to attaining high hygiene standards

Comparing the different methods available for secondary treatment of the wastewater products before recycling, many different indicators can be used to evaluate the efficiency. However the most important of these is the reduction of pathogens to produce a hygienically safe material.

The treatment methods compared here were: storage; pasteurisation; liquid composting; dry composting; urea treatment; and treatment by peracetic acid (PAA). The emphasis of the comparison was whether the treatment could assure a safe waste product; the scale; and the energy usage.

The simplest secondary treatment is **storage**. However, storage cannot guarantee a product considered to be safe according to hygiene standards unless several external conditions such as temperature, time and composition of the material, especially the ammonia content, are kept at predetermined levels. These factors affect the final product and changes in them mean that storage does not inactivate all organisms, especially those that have some kind of dormant state that can provide them with protection for several years. In the chemical treatment of faecal matter, water was added as the control (Paper V). In that study the amount of *E. coli* and faecal *Streptococci* spp decreased during the treatment. No *E. coli* was detected after 50 days, which corresponds to a reduction of >6 log₁₀. *Salmonella* that was added to approximately the same initial concentration was still detectable

after 50 days of treatment. An initial increase of *Enterococcus* spp was determined in the control (Paper V), but after 50 days the presence of *Enterococcus* spp had decreased to approximately 10% of the initial amount. No significant difference was detected for the number of *Salmonella typhimurium* 28B phage. However, the *Ascaris suum* eggs added to the material showed a significant reduction in viability after 50 days of storage of faecal matter, approximately 0.2% viability compared to 90% in the control (Paper V). Storage can however also give large environmental effects. The organic matter is degraded and in some cases results in waste products with negative environmental effects, such as methane from anaerobic conditions and nitrous oxide from incomplete nitrification or denitrification. Both gases are potent greenhouse gases. If all the sewage sludge produced in Sweden were to be stored, the total national emissions of methane would increase by 0.2% and the nitrous oxide would increase by 5% (Flodman, 2002). The advantage with storage is that it can be performed in whatever scale needed and the extra need for energy is minimal. Still this is not a preferable method for treatment of sewage products, except urine, which has an additional disinfection effect sufficient for inactivation of pathogens from the urea content, similarly to chemical disinfection by added urea (Höglund, 2001). The collected urine mixture also contains only small amounts of organic matter that can be degraded. No hydrogen sulphide has been detected in urine storage tanks indicating low or no anaerobic activity in urine mixture.

Composting of sewage products can either be performed at a dry matter content of 2-10%, liquid composting, or at approximately 35% dry matter, dry composting. **Liquid composting** is a complex technique as it is performed in a reactor where air is forced into the liquid. Therefore it is also quite energy demanding; approximately 140 MJ per person and year are needed to treat blackwater (1295 kg p⁻¹ y⁻¹) in a 17.5 m³ reactor (Skjelhaugen, 1999b). If only the separated faecal water (195 kg p⁻¹ y⁻¹) is treated, the energy demand corresponds to 18 MJ p⁻¹ y⁻¹ (Skjelhaugen, 1999b). The material in the compost reactor is liquid and the process is fully mixed, so disinfection is achieved in all of the material. The reactor facilitates monitoring of both incoming and outgoing air, which makes it possible to preheat the incoming air to avoid low temperature areas and to condense the outgoing air. Condensing the outgoing gas makes it possible to collect a major part of the components in the gas and then percolate them back into the reactor. Further treatment of the air can be done in a bio-filter (Haug, 1993). It is also possible to collect the energy in the outgoing air, as the compost reaction is exothermic and an energy surplus is produced. The main use for this energy is to preheat the incoming air. The reactor also makes it possible to monitor the disinfection, as all of the material attains the same temperature and the equation in Table 10 can be used to determine the required time of treatment according to the required safety margin. A disadvantage of liquid composting is that the highly technical reactor needs to be large to be an economically viable alternative and that it uses large quantities of electrical energy.

Dry composting uses the same biological mechanisms as liquid composting but the higher dry matter content makes natural ventilation possible as the thermal movement in the material gives enough oxygen if the structure is porous. Dry composting can either be performed in reactors or in open windrows. The

treatment is not as scale-dependent as liquid composting since small-scale local composts can be used, although the smaller the scale, the better the insulation has to be. In small-scale systems it is often impractical to have pre-heating of the incoming air and treatment of the outgoing air. Therefore cooled zones will occur around the air inlet and the outgoing air can have effects on the environment such as smell and ammonia emissions. However, a lot of the emissions will probably condense on the lid of the composting reactor and percolate back into the material. The cool zones can be handled by having material with a better hygiene standard close to the air inlet, e.g. food waste, which can be used as a pre-heater. One major disadvantage with the composting of sewage products is that it requires handling of the raw untreated matter when starting and turning the compost. The environmental effects from the treatment are small if the outgoing air is condensed. There is also a risk for recontamination of the material after the treatment.

Pasteurisation is an efficient treatment method for disinfection. The duration of treatment and treatment temperature can vary according to the equations in Table 10 depending on the safety margins used. The system for thermal treatment is energy demanding and highly technical, and is therefore only an alternative for large-scale treatment. The energy needed to get temperatures as high as those in the composts (65°C), on average increasing the temperature by 55°C, would be 39 MJ p⁻¹ y⁻¹ for treatment of the separated faecal matter, while to treat the blackwater (1295 kg p⁻¹ y⁻¹) would require 300 MJ. By using a heat exchanger recovering the energy of the treated matter, it would probably be possible to reuse half of the energy to approximately the amount used by liquid composting. The treated matter is hygienically safe but the risk for recontamination is large as all organic matter is more or less unaffected and the initial competition from other organisms is small as most of them are killed during the treatment.

The treatment with **urea** only requires that the treatment is performed in a closed container where air exchange is low, as this prevents the ammonia produced from being lost. The energy usage for production of the urea added according to the dosage in Paper V (30 g of urea nitrogen per kg of material to treat) for treatment of separated faecal matter (195 kg p⁻¹ y⁻¹) with a dry matter content of 10% corresponds to 150 MJ p⁻¹ y⁻¹. However, if the disinfected material is recycled to agriculture the energy usage for production of this urea can be fully allocated to the fertiliser, as all of the urea used acts as a fertiliser upon application to land. The increased nitrogen content somewhat increases the energy usage as the driving distance for spreading the material increases. However, the total energy usage for spreading is relatively small compared to the energy used in the production of fertilisers and can therefore be disregarded. Furthermore, the dosage can probably be decreased significantly, which will be tested in future studies. As long as the ammonia is still in the treated matter there will be no risk for recontamination. As the only requirement is that the air is not ventilated, emitting the ammonia, there is no limitation on the size of the treatment. The only proven efficient treatment temperature so far is at 20°C. According to Allevi et al. (1994) and a temperature of at least 10°C is needed for inactivation by ammonia. Therefore urea treatment should be performed at temperatures above 10°C until tests have shown satisfactory effects at lower temperatures.

The PAA treatment, like the urea treatment, is not restricted in size. However, proper mixing of the material is necessary, as the rapid treatment requires a totally mixed material. Given this condition, the main treatment effect can be achieved within less than 12 hours of treatment. As the chemicals are strongly oxidising, a higher organic matter content in the material requires an increased dosage of chemicals. The energy for producing the chemicals for disinfection of the faecal matter (195 kg p⁻¹ y⁻¹) is approximately 20 MJ, if the urine were included; the need for chemicals would probably not increase particularly. As the reaction is fast and the active substance is consumed during treatment, the treated matter has to be applied to land soon after treatment, otherwise there is a large risk for re-infection (Paper V).

Concluding summary

As regards the general composition of household wastewater, the urine mixture contains the major proportion of the nutrients and only a small fraction of the heavy metals (Paper I). Compared to the average composition of the wastewater, the faecal matter is also a relatively clean fraction. The faecal fraction contains smaller amounts of nutrients and larger amounts of heavy metals compared to the urine but it has only one tenth of the mass of the urine. These two wastewater fractions are most interesting for recycling due to their nutrient content, their quality of the nutrients and their relatively small volumes (Paper I).

Due to the origin of these fractions, they are initially easy to collect without requiring large amounts of energy. To get the same amount of unpolluted nutrients from mixed wastewater requires a lot of energy and highly technical systems. If the urine is collected separately in a urine-diverting toilet system, there is only an increase in energy usage for transporting the urine to the farms and spreading it. The faecal matter can either be collected dry in a dry urine-diverting toilet or separated from the flushwater of a double flush urine-diverting toilet, after a short pipe transport, in an whirlpool, surface tension separator as the faecal nutrients are particle-bound (Paper II, III).

In investigations of different urine-diverting sewage systems, between 55% and 90% of the urine-derived nutrients have been recovered (Jönsson et al., 1997, 1998, 1999, 2000; Vinnerås, 1998; Lindgren, 1999; Johansson et al., 2000; Andersson & Jensen, 2002). A larger proportion of the urine nutrients is probably collected in more recently built systems, as toilet design has developed and the knowledge of why the system is used and how it functions has increased. If the urine is collected and recycled, the energy saved compared to treating it in a large sewage treatment plant and producing the corresponding amount of mineral fertilisers would correspond to a truck-driven transport of the urine mixture of approximately 104 km one way.

One way to collect both the urine and the faecal matter is by using low flush, mainly vacuum, toilets. An alternative for recovering the faecal fraction while still having a flush toilet is to separate the faecal matter from the flushwater after a short pipe transport. To work, this requires that the faecal nutrients remain in the

faecal particles (Paper II) and a urine-diverting toilet has to be used. As the faecal particles are rapidly degraded in the water the separation has to be performed within a short period of time after the flush (Paper II). By using a whirlpool, surface tension separator, it was possible to collect up to 85% of the faecal nutrients, and the dry matter content of the collected matter was approximately 10% when toilet paper was included.

In a well functioning whirlpool, surface tension separation system, misplaced wastewater such as the domestic cleaning water in Ekoporten (Paper III) only has small effects on the content of non-faecal matter, such as heavy metals, in the separated solids. Thus this kind of system seems to be robust even if the toilet is misused to a small extent as the water soluble and suspended substances are not separated into the separated solids fraction.

In the final comparison of the primary wastewater treatment the wastewater treatment plant was set as the normative system (Table 15). When comparing with the other systems, if the system was more than 50% better or worse than the reference it was given as + or -. If the difference were less than 50% it was given as 0.

Table 15. Comparison between different primary treatment systems for treatment of household wastewater. The compared systems were: blackwater collection (BW); urine-diversion (UD) combined with faecal separation (FS) with different separation efficiency (in percent) and finally a large sewage treatment plant (WWTP)

	BW	UD 100% FS 85%	UD 70% FS 58%	WWTP
N, P & K to land	+	+	+	0
Heavy metals to land	+	+	+	0
N, P & K to water	+	+	+	0
Metals to water	0	0	0	0
Energy usage	+	+	+	0
Local transport	-	-	-	0

* the treatment of the collected blackwater was not included in the energy usage

The systems where the toilet water was collected separately were significantly better regarding the recycling of unpolluted nutrients, nutrient losses to the recipient waters and decreasing the energy usage compared to the conventional sewage treatment in a large sewage treatment plant (Table 15). As the content of heavy metals in the toilet water was significantly lower than the total flow to the sewage treatment plant the amounts of heavy metals to land will be lower in the systems where the toilet fractions is recycled separately.

When comparing the different systems where the urine and faeces are collected separately the blackwater system will show the best results according to its energy usage and environmental effects. However, today there is no reliable and well-functioning toilet system available where the blackwater is collected with a high dry matter content >4%. One of the main problems is the large water volume that dilutes the fraction and increases the volume to be handled. One method to keep the water volume low is by use of vacuum toilets especially urine diverted ones. These systems are technical and sensitive towards malfunction and if the vacuum

goes down no toilet will be possible to flush. Also material poured into the toilet, e.g. domestic cleaning water, will be collected together with the blackwater increasing the volume and maybe also pollute the otherwise relatively unpolluted urine and faeces. The second best system according to the compared factors (Table 15) is the collection of the urine and the faeces via urine-diversion and faecal separation. However, it is not possible to collect the same large amounts of nutrients and thereby not possible to have as large positive environmental effects. But if the urine-diversion is done correctly most of the urine should be possible to collect, and the faecal nutrient seems to be possible to collect up to 85% and maybe even more by further development of the system. One other major advantage with the urine-diversion and faecal separation system is its robustness due to the absence of moving parts and the small effects of misuse on the function, except for the loss of nutrients. The system with faecal separation will also be possible to use in areas where water instead of paper is used for anal cleansing as almost no water will be found in the fraction of separated solids when no particles are flushed.

The separation of the faeces can be performed in several ways. One very important factor for the separation is that the separated particles are removed from the water directly after the separation. Otherwise the nutrients will be dissolved into the water and lost from the recycling fraction (Paper II).

With the introduction of these source-separating sewage systems, with local collection in tanks, the need for local transport with trucks increases (Table 15). However if source-separating systems were introduced on a larger scale, it would be possible to centralise the collection of the diverted fractions and keep the local transports unaffected.

It is possible to sanitise the collected urine mixture by storage, as the high pH and the ammonia content reduce many non-spore forming pathogens. The faecal matter on the other hand has to be treated actively to attain hygienically safe conditions. By addition of peracetic acid (PAA), the faeces can be disinfected within hours but PAA is energy demanding to produce and is reactive and therefore dangerous if handled wrong. Due to the high organic matter content in the separated solids, approximately 10%, a lot of the active substance is consumed by the organic matter, increasing of the dosage is needed. Approximately 0.5-1.0% of PAA was needed for achieving no viable pathogens in the faecal matter after 12 hours of treatment. PAA is rapid and efficient, even towards spore-forming bacteria (Paper V).

Treatment with urea was an efficient method for all of the investigated organisms except for the spore-forming bacteria. The other analysed bacteria, viruses and helminths were inactivated within 50 days of treatment when 30 grams of urea nitrogen were used per kg of faecal matter (Paper V). The method is size independent and the chemical added is safe to handle. After treatment, the disinfectant is used as a fertiliser, as the ammonia produced is a readily plant available nitrogen fertiliser. Even the extremely ammonia resistant *Salmonella typhimurium* 28B phage was significantly reduced by the treatment, the determined D value corresponded to <7.5 days (Paper V). As the biocidal ammonia is not degraded during the disinfection treatment, there is no risk for

regrowth of pathogens. A point to observe, however, is the initial delay from the urea treatment, as the urea has to be biochemically degraded into ammonia to have any biocidal effects. This is also one of the advantages with the urea, that it is easy to handle, as until the urea is degraded it is not harmful to the surroundings and the degradation starts on addition, since the enzyme urease occurs naturally in sewage products.

If the faeces are collected dry in a urine-diverting toilet, one alternative treatment of the faecal matter is dry composting. By adding food waste and amendment it is possible, in a well insulated box, to reach temperatures over 60°C for several days, thereby getting a material with a high hygiene standard (Paper IV). It is important to have sufficient insulation of the material to assure high temperature in all of the material. By using the equations for the thermal inactivation of pathogens (Feachem et al., 1983; Paper IV), it is possible to determine safety margins for the inactivation of the pathogens. If insufficient insulation is used, zones with lower temperatures will occur, especially around the air inlet and close to the outer walls, and there will be a risk of areas with lower or no deactivation. By turning the compost until completely mixed, only part of the material with insufficient heat will remain in the cool zone (Equation 4). By preheating the incoming air, this problem can be avoided. There are two alternatives for doing this in a larger reactor: The outgoing air can be used to heat the incoming air, or organic matter of a higher hygiene standard, e.g. food waste, can be used closest to the incoming air and its composting process will preheat the air reaching the faecal matter. One major disadvantage with the composting treatment is the handling of the raw untreated matter and the handling throughout the treatment, especially as the major route of transmission of *Ascaris* is by contact with raw untreated faecal matter (Feachem et al., 1983). By increasing the mechanisation of the handling, this risk would decrease significantly.

To compare the different alternatives for secondary treatment storage was set as the reference treatment to which the other treatments were compared (Table 16). When comparing with the other systems, if the system was more than 50% better or worse than the reference or, in cases of non numerical comparisons, if there were significant difference between the system compared to the reference system it was given as + or - If the difference were less than 50% it was given as 0.

Table 16. Comparison between different systems for disinfection of wastewater products

	Storage	Composting		Pasteurisation	Urea	PAA
		Liq	Dry			
Scale	0	-	-	-	0	0
Disinfection efficiency	0	+	+	+	+	+
Risk for re-infection	0	+	+	-	+	-
Energy usage	0	-	0	-	0	-
Handling	0	+	0	+	+	-
Fertilising value	0	0	0	0	+	0
Time for treatment	0	+	0	+	0	+

The urea treatment seems to be the most favourable alternative for secondary treatment, since it produces a safe waste product, is easy to handle before addition,

has no risk for recontamination, is scale independent and, increases the fertiliser value of the treated matter (Table 16). One other advantage with the urea treatment is that no technological systems or technological knowledge is necessary for performing of the disinfection. The liquid compost and the pasteurisation will need both sophisticated technologies and technical knowledge for maintaining the process. The treatment with PAA needs some knowledge to handle the reactive chemicals. Therefore, the urea treatment will be the most favourable of the compared ones both concerning its efficiency and environmental effects and concerning the need for technology to use.

According to these studies the preferable treatment alternative for toilet water, according to energy usage, water emissions, nutrient recycling and hygiene safety would consist of;

- Double flush urine-diverting toilets where the diverted urine is collected separately and sanitised by storage before use as fertiliser.
- Separation of the faeces from the flushwater in a whirlpool, surface tension separator. The separated faecal matter can then be sanitised by urea treatment before use as fertiliser.

In this way, the majority of the nutrient contribution from the household to wastewater would be directly recycled in two low volume, hygienically safe fractions unpolluted by heavy metal and a lot of resources such as energy and plant nutrients will be saved.

Further research needed

These studies have revealed several new questions and research topics for further studies and some of them are given below.

More studies of the composition of urine and faeces need to be performed according to the volume, mass and distribution of hormones and elements, especially heavy metals. The performed studies in Paper I could not determine if the high levels of heavy metals came from the material or was contaminants from the collection system of miss-usage of the system.

The design of the systems for urine-diversion and faecal separation needs to be further developed for implementation in different types of housing, from single households up to larger systems with several blocks of flats.

As one of the major concerns about usage of wastewater products for fertilising are the spreading of hormone mimicking substances the effect of these substances in different environments such as aquatic and terrestrial systems needs to be further investigated.

As the method for calculation of the thermal inactivation of pathogens in composts are developed from an amalgamation of several different thermal disinfection studies, not necessary thermal composting, this method ought to be validated according to its accuracy to determine that total disinfection of the indicator organisms has occurred by thermal composting.

The necessary dosage of urea for disinfection of separated faecal matter has been determined as 30 g of urea nitrogen during 2 months storage. Probably would a much lower dosage suffice to achieve the disinfection. The relationship between time, temperature, urea dosage and disinfection efficiency has to be determined by further laboratory analysis. Thereafter, proper recommendations for time of treatment, temperature and dosage for chemical disinfection by urea addition should be developed. Thereby making it possible to use the method during different circumstances.

As the amount of free ammonia will increase due to increasing pH, different combinations of bases, i.e. urea addition combined with addition of ash, $\text{Ca}(\text{OH})_2$ or KOH, could be interesting for maximising the disinfection effect while keeping the needed dosage as low as possible.

The function of chemical disinfection for other composition of household wastewater fraction than separated faeces needs to be investigated. Materials of interest are different mixes of urine, faeces and food waste. Of special interest to investigate is if the urea content of the urine is enough for or can supplement the disinfection of both the faeces and the food waste.

Investigations of the possibilities for usage of urea as disinfectant for manure are needed. One usage could be treatment of manure infected by epizootic diseases, e.g. foot and mouth disease, as ammonia shown to be efficient towards viruses this could be an easy and cost efficient treatment.

As the peracetic acid is a strong oxidiser that oxidise both proteins in organisms and other organic material the possibilities to use oxidative treatment of outgoing wastewater, for removal of pathogens as well as organic substances with hormone mimicking functions, needs to be investigated.

As one of the major risks of transmission of diseases is contact with the raw untreated matter, would it be of interest to investigate the need of mixing the material upon chemical treatment. Preferable would be if the natural strive for levelling out the chemical concentrations would be enough and thereby making mixing unnecessary.

Research needs to be performed about how these recycling sewage systems are accepted by the users, e.g. to see what kind of toilets that should be used; how the produced fertilisers should be handled and used local or central; interest in food that is fertilised with wastewater products.

References

- Aaltonen J. & Andersson P. (1995). *Långsiktig reningskapasitet hos markbäddar och infiltrationsanläggningar*. Rapport Avdelningen flr mark- och vattenresurser, KTH. Stockholm: KTH
- Anonymous. (1994). *Per capita consumption of paper*. European Tissue Symposium Henkilö 1993. Henkilö

- Alasari A., Roques C. & Michel G. (1992). Bactericidal properties of peracetic acid and hydrogen peroxide, alone and in combination, and chlorine and formaldehyde against bacterial water strains. *Canadian Journal of Microbiology* 32, pp. 635-642.
- Albihn A., Sahlström L., Bagge E., Aspan A., Engvall A. & Gunnarsson A. (2001). *Hygienstudie på slam i svenska reningsverk - finns en risk för smittspridning i lantbruket?* SJV rapport. Jönköping: SJV
- Alef K. & Nannipieri P. (1995). Urease Activity. In: Alef K. & Nannipieri P.(eds) *Methods in Applied Soil Microbiology and Biochemistry*. London: Academic Press Ink.
- Allievi L., Colombi A., Calcaterra E. & Ferrari A. (1994). Inactivation of faecal bacteria in sewage sludge by alkaline treatment. *Bioresource Technology* 49, pp. 25-30.
- Almedal C. (1998). *Lokal hantering av slam från enskilda avlopp i Svalövs kommun*. Institutionsmeddelande 98:4. Uppsala: SLU, Department of Agricultural Engineering
- Almeida M.C., Butler D. & Friedler E. (1999). At source wastewater quality. *Urban Water* 1, pp. 49-55.
- Andersson Å. & Jensen A. (2002). *Flöden och sammansättning på BDT-vatten, urin, fekalier och fast organiskt avfall i Gebers*. Institutionsmeddelande 02:05. Uppsala: SLU, Department of Agricultural Engineering
- Arturo-Schaan M., Sauvager F., Mamez C., Gougeon A. & Cormier M. (1996). Use of peracetic acid as a disinfectant in a water-treatment plant: Effect on the plasmid contents of *Edcherichia Coli* strains. *Current Microbiology* 32, pp. 43-47.
- Baldry M.G.C. & French M.S. (1989). Desinfection of sewage effluent with peracetic acid. *Water Science and Technology* 21, pp. 203-206.
- Baldry M.G.C., French M.S. & Slater D. (1991). The activity of peracetic acid on sewage indicator bacteria and viruse. *Water Science and Technology* 24, pp. 353-357.
- Balmér P. (2001). Possibilities to improve wastewater sludges. *Water Science and Technology* 40, pp. 19-26.
- Balmér P., Book K., Hultman B., Jönsson H., Kärrman E., Levin E., Palm O., Schönning C., Seger A., Stark K., Söderberg H., Tideström H. & Åberg h (2002). System för återanvändning av fosfor ur avlopp. NV report in Press. Stockholm: Naturvårdsverket (Swedish EPA)
- Beck-Friis B., Smårs S., Jönsson H. & Kirchmann H. (2001). Gasous emission of carbon dioxide, ammonia and nitrous oxide from organic household waste in a compost reactor under different temperature regimes. *Journal of agricultural Engineering Research* 78, pp. 423-430.

- Berger E.Y. (1960). Intestinal absorption and excretion. In: Comar C.L. and Bronner F.(eds) *Mineral Metabolism*. New York: Academic press pp 249-286.
- Björklund A. (2002a). *Latrin och matavfall i kretslopp i Stockholms skärgård*. Institutionsmeddelande 2002:02. Uppsala: SLU Department of Agricultural Engineering
- Björklund A. (2002b). *The Portential for Disinfection of Faecal Matter by Thermal Composting or Storage*. Minor Field Studies No. 200. Stockholm: Sida
- Brock T.D., Madigan M.T., Martinko J.M. & Parker J. (1994). *Biology of Microorganisms, 7ed*. International ed: Prentice Hall
- Burge W.D., Cramer W.N. & Kawata K. (1983). Effect of heat on virus inactivation by ammonia. *Applied and Environmental Microbiology* 46, pp. 446-451.
- Carlander A. & Westrell T. (1999). *A Microbiological and Sociological Evaluation of Urine-Diverting Doublevault Latrines in Cam Duc, Vietnam*. Minor Field Studies No. 91. Uppsala: SLU
- Collignarelli C., Bertanza G. & Pedrazzani R. (2000). A comparison among different wastewater disinfection systems: experimental results. *Environmental Technology* 21, pp. 1-16.
- Comber S.D.W. & Gunn A.M. (1996). Heavy metals entering sewage - treatment works from domestic sources. *Journal of the Chartered Institution of Water and Environmental Management* 10, pp. 137-142.
- Cramer W.N., Burge W.D. & Kawata K. (1983). Kinetics of virus inactivation by ammonia. *Applied and Environmental Microbiology* 45, pp. 760-765.
- Davis J. & Haglund C. (1999). *Life Cycle Inventort (LCI) of Fertiliser Production - Fertiliser Products Used in Sweden and Western Europe*, SIK-Report No 654 1999. Göteborg: SIK
- Del Porto D. & Steinfeld C. (1999). *The composting System Book - A Practical Guide to Choosing, Planning and Mantaining Composting Toilet systems, an Alternative to Sewer and Septic System*. Concord, USA: The Center For Ecological Pollution Prevention.
- Eklind Y., Beck-Friis B., Bengtsson S., Ejlertsson J., Kirchmann H., Mathisen B., Nordkvist E., Sonesson U., Svensson B.H. & Torstensson L. (1997). Chemical Characterisation of Source-Separated Organic Household Wastes. *Swedish Journal of Agricultural Research* 27, pp. 167-178.
- Eklind Y. & Kirchmann H. (2000). Composting and Storage of Organic Household Waste with Different Litter Amendments. I: Carbon Turnover. *Bioresource Technology* 74, pp. 115-124.
- Elmqvist H., Rodhe L., Blomberg M. & Liden B. (1998). Human Urine and Effluents from Digestion of Food Refuce as a Fertiliser to Barly - Crop

- Yields, Ammonia Emission and Nitrate Leacage. In: Martinez J. & Maudet M.-N.(eds) Ramiran 98 poster presentations. 8th International Conference on Management Strategies for Organic Waste Use in Agriculture. Rennes 26-28 May 1998. Rennes: Cemagref pp 285-293.
- Engqvist A. (1998). *Mercury Exposure From Amalgam Fillings - Analysis of Mercury in Different Biological Matrixes and Speciation in the Feces. Arbete och hälsa - Vetenskaplig skriftserie*. Institutionen för analytisk kemi. Stockholms universitet. Stockholm: Arbetslivsinstitutet
- Enskog Broman L. (2000). *Kadmium - miljö- och hälsoaspekter vid slamspridning*. Rapport. Stockholm: Stockholm vatten AB
- Enzinger R.M. & Motola S. (1981). *Technical Report No. 3 Validation of Dry Heat Processes Used for Sterilisation and Depyrogenation*. . Parental Drug Association Inc.
- Epstein E. (1997). *The Science of Composting*. Lancaster, USA: Technomic Publishing Co. Inc.
- Feachem R.D., Bradley D.J., Garelick H. & Mara D.D. (1983). *Sanitation and Disease Health Aspects of Excreta and Wastewater Management. World Bank Studies in Water Supply and Sanitation 3*. Washington: The World Bank
- Fittschen I. & Hermann H.H. (1998). Characterization of the municipal wastewaterpart human urine and a preliminary comparison with liquid cattle excretion. *Water Science and Technology* 38, pp. 9-16.
- Fittschen I. & Niemczynowicz J. (1997). Experiences with dry sanitation and greywater treatment in the ecovillage Toarp, Sweden. *Water Science and Technology* 35, pp. 161-170.
- Flodman M. (2002). *Emissioner av metan, lustgas och ammoniak vid lagring av rötslam*. Istitutionsmeddelande 02:4. Uppsala: SLU, Department of Agricultural Engineering
- Fraústo da Silva J.J.R. & Williams R.J.P. (1997). *The Biological Chemistry of the Elements - The Inorganic Chemistry of Life*. Oxford: Oxford
- Frodhagen J. (1997). *Livscykelanalys på tre järnbaserade fällningskemikalier*. Rapport 1997:10. Göteborg: Teknisk miljöplanering, CTH
- Gantzer C., Gaspard P., Galvez L., Huyard A., Dumouthier N. & Schwartzbrod J. (2001). Monitoring of bacterial and parasitological contamination during various treatment of sludge. *Water Research* 1635, pp. 3763-3770.
- Gaspard P.G., Wiart J. & Schwartzbrod J. (1995). Urban sludge reuse in agriculture: Waste treatment and parasitological risk. *Bioresource Technology* 52, pp. 37-40.
- Greenwood N.N. & Earnshaw A. (1998). *Chemistry of the Elements Second Edition*. Oxford: Butterworth Heinman

- Guyton A.C. (1992). *Human Physiology and Mechanisms of Disease*. Philadelphia: W.B.Saunders Company
- Hanaeus J., Hellström D. & Jonsson E. (1997). A study of a urine separation system in an ecological village in northern of Sweden. *Water Science and Technology* 35, pp. 153-160.
- Haug R.T. (1993). *The Practical Handbook of Compost Engineering*. Boca Raton, Florida, USA: LEWIS
- Hellström D. & Johansson L. (2001). *Bra Små Avlopp - Delrapport 1* Utvärdering av reningseffekt med avseende på syreförbrukande och eutrofierande ämnen.. Stockholm: Stockholm Vatten AB
- Hellström D. & Kärrman E. (1996). Nitrogen and phosphorus in fresh and stored urine. Proceedings from the 2nd International Conference on Ecological Engineering for Wastewater Treatment, September 18-22 1995. Waedenswil: Environmental Research Forum pp 221-226.
- Herniman K.A.J., Medhurst P.M., Wilson J.N. & Sellers R.F. (1973). The action of heat, chemicals and disinfectants on swine vesicular disease virus. *Veterinary Record* 93, pp. 620-624.
- Hovelius K. & Hansson P.-A. (1999). Energy- and exergy analysis of rape seed oil methyl ester (RME) production under Swedish conditions. *Biomass and Bioenergy* 17, pp. 279-290.
- Höglund C. (2001). *Evaluation of Microbial Health Risks Associated with the Reuse of Source-Separated Human Urine*. PhD thesis. Stockholm: KTH
- Höglund C., Ashbolt N., Stenström T.A. & Svensson L. (2002). Viral persistence in source-separated human urine. *Canadian Journal of Microbiology in press*
- Höglund C. & Stenström T.A. (1999). Survival of *Cryptosporidium parvum* oocysts in source separated human urine. *Canadian Journal of Microbiology* 45, pp. 740-746.
- Höglund C., Stenström T.A., Jönsson H. & Sundin A. (1998). Evaluation of Faecal Contamination & Microbial Die-off in Urine Separating Systems. *Water Science and Technology* 38, pp. 17-25.
- Höglund C., Vinnerås B., Jönsson H. & Stenström T.A. (1999). Chemical and Microbial Composition of Source Separated Human Urine. *Proceedings "Civil and Environmental Engineering – New Frontiers and Challenges"* November 8-12, 1999, Bangkok, Thailand. Bangkok: AIT
- Höglund C., Vinnerås B., Stenström T.A. & Jönsson H. (2000). Variation of chemical and microbial parameters in collection and storage tanks for source separated human urine. *Journal of Environmental Science and Health Part A: Environmental Science and Engineering* 35, pp. 1463-1475.
- Johansson M., Jönsson H., Höglund C., Richert-Stintzin A. & Rodhe L. (2000). *Urine Separation - Closing the Nutrient Cycle. Final Report on The R&D*

Project Source-Separated Human Urine - a Future Source of Fertilizer for Agriculture in the Stockholm Region? Stockholm: Stockholm Vatten

- Johnston F.A. & McMillan T.J. (1952). The amount of nitrogen retained by 6 young women on an intake of approximately 70 gm of protein a day. *Journal of Nutrition* 35, pp. 425-433.
- Joselov M.M., Goldwater L.J. & Weinberg S.B. (1967). Absorption and Excretion of Mercury in Man. *Archives of Environmental Health* 15, pp. 64-66.
- JV (1997). *Råd och anvisningar för smittrening och användande av desinfektionsmedel vid utbrott av epizootiska sjukdommar. Epizootihandboken*. Jordbruksverket (Swedish Board of Agriculture) Jönköping: Jordbruksverket
- Jönsson H., Burström A. & Svensson J. (1998). *Mätning på två urinsorterande avloppssystem - urinlösning, toalettanvändning och hemvaro i en ekoby och ett hyreshusområde*. Rapport 228. Uppsala: SLU Department of Agricultural Engineering
- Jönsson H., Stenström T.A., Svensson J. & Sundin A. (1997). Source separated urine-nutrient and heavy metal content, water saving and faecal contamination. *Water Science and Technology* 35, pp. 145-152.
- Jönsson H., Vinnerås B., Höglund C. & Stenström T.A. (1999). Source separation of urine – an added function to the sewage system aiming at sustainability. *Wasser & Boden* 51, pp. 21-25.
- Jönsson H., Vinnerås B., Höglund C., Stenström T.A., Dalhammar G. and Kirchmann H. (2000). *Källsorterad humanurin i kretslopp*. VA-FORSK RAPPORT 1. Stockholm: VAV
- Karlsson J. & Larsson M. (2000). *Composting of Latrine Products in Addis Ababa, Ethiopia. Minor Field Studies No. 32*. Luleå: Luleå University of Technology
- Kehoe R.A., Cholak J. & Story R.V. (1940). A spectrochemical study of the normal ranges of concentration of certain trace metals in biological materials. *Journal of Nutrition* 19, pp. 579-592.
- Kim N. & Fergusson J. (1993). Concentrations and Sources of Cadmium, Copper, Lead and Zinc in Dust in Christchurch, New Zealand. *Science of the Total Environment* 138, pp. 1-21.
- Kirchmann H. & Pettersson S. (1995). Human urine - chemical composition and fertilizer use efficiency. *Fertilising Research* 40, pp. 149-154.
- Koch M. & Rotard W. (2000). On the Contribution of Background Sources to the Heavy Metals Content of Municipal Sewage Sludge. 1st World Water Congress of the International Water Association - Conference preprint Book 1 - Industrial Wastewater Treatment. Paris: IWA pp 367-374.
- Kärman E. (2000). *Environmental System Analysis of Wastewater Management*. PhD thesis. Göteborg: Chalmers

- Kärman E. & Jönsson H. (2000). Normalising impacts in an environmental systems analysis of wastewater systems. pp 276-283 In: Conference Preprint Book 5 Water Resources and Waste Management, 1st World Water Congress of the International Water Association. Paris: IWA
- Kärman E., Jönsson H., Gruvberger C., Dalemo M., Sonesson U. & Stenström T.A. (1999). *Miljösystemanalys av hushållens avlopp och organiska avfall - syntes av hanteringssystem undersökta inom FoU-programmet "Organiskt avfall som växtnäringsresurs"*. VA-FORSK RAPPORT 15. Stockholm: VAV
- Kärman E., Olofsson M., Persson B., Sander A. & Åberg H. (2001). *Köksavfallskvarnar en teknik för uthållig resursanvändning? En förstudie i Göteborg*. VA-Forsk rapport 2001:2. Stockholm: VAV
- Lefevre F., Audic J.M. & Ferrand F. (1992). Peracetic acid disinfection of secondary effluents discharged off coastal seawater. *Water Science and Technology* 25, pp. 155-164.
- Lentner C., Lentner C. & Wink A. (1981). *Units of Measurement, Body Fluids, Composition of the Body, Nutrition. Geigy Scientific tables*. Basle: Ciba-Geigy
- Liberti A., Lopez A. & Notarnicola M. (1999). Disinfection with peracetic acid for domestic sewage re-use in agriculture. *Journal of the Chartered Institution of Water and Environmental Management* 13, pp. 262-269.
- Liberti L., Lopez A., Notarnicola M., Barnea N., Pedahzur R. & Fattal B. (2000). Comparison of advanced disinfecting methods for municipal wastewater reuse in agriculture. *Water Science and Technology* 42, pp. 215-220.
- Lindgren M. (1999). *Urinsorterande toaletter - rensning av stopp, uppsamlade volymer och attityder*. Institutionsmeddelande 5. Uppsala: SLU
- Lohm U., Bergbäck B., Hedbrant J., Jonson A., Sviden J., Sörne L. & Östlund C. (1997). *Databasen Stockhome - Flöden och ackumulation av metaller i Stockholms teknosfär. Tema V Rapport 25*. Linköping: Linköpings universitet
- Mitscherlich E. & Marth E.H. (1984). *Microbial Survival in the Environment*. Berlin: Springer-Verlag
- Monarca S., Feretti D., Collivignarelli C., Guzzella L., Zerbini I., Bertanza G. & Pedrazzani R. (2000). The influence of different disinfectants on mutagenicity and toxicity of urban wastewater. *Water Research* 34, pp. 4261-4269.
- Moriyama K., Mori T., Arayashiki H., Saito H. & Chino M. (1989). The Amount of Heavy Metals Derived from Domestic Wastewater. *Water Science and Technology* 21, pp. 1913-1916.
- Månsson L. (1992). *Högteknologins osynliga fiende - En berättelse om renlighetsteknik och rena rum - R³-TEKNIK*. Malmö: Timab Tvätt

- Nagasaki K., Uehara N., Kataoka M. & Kubota H. (1996). The Use of *Bacillus Licheniformis* HA1 To Accelerate Composting of Organic Wastes. *Compost Science & Utilization* 4, pp. 47-51.
- Nord (1995). *Nordic Guidelines on Life-Cycle Assessment*. Köpenhamn: The Nordic Council of Ministers
- NV (1995). *Vad innehåller avlopp från hushåll? : näring och metaller i urin och fekalier samt i disk-, tvätt-, bad- & duschvatten*. NV rapport 4425. Stockholm: NV (Swedish EPA)
- Otterpohl R. (2001) Design of highly efficient source control sanitation and practical experiences. In: Lens P., Zeeman G. & Lettinga G.(eds) *Decentralised Sanitation and Reuse: Concepts, Systems and Implementation*. London: IWA Publishing pp 164-179.
- Otterpohl R., Albold A. & Oldenburg M. (1999). Source control in urban sanitation and waste management: ten systems with reuse of resources. *Water Science and Technology* 39, pp. 153-160.
- Palmquist H. (2001). *Hazardous Substances in Wastewater Systems. Licentiate Thesis 2001:65*. Luleå: Luleå University of Technology
- Philip H., Maunoir S., Rambaud A. & Philippi L.S. (1993). Septic tank sludges: accumulation rate and biochemical characteristics. *Water Science and Technology* 28, pp. 57-64.
- Schroeder H.A. & Nason A.P. (1971). Trace Element Analysis in Clinical Chemistry. *Clinical Chemistry* 17, pp. 436-474.
- Sidhu J., Gibbs R.A., Ho G.E. & Unkovich I. (2001). The role of indigenous microorganisms in suppression of *Salmonella* Regrowth in composted biosolids. *Water Research* 35, pp. 913-920.
- Skare I. & Engqvist A. (1992). Amalgamfyllningar en beaktansvärd källa till tungmetall exponering. *Läkartidningen* 89,
- Skjelhaugen O.J. (1999a). Closed system for local reuse of blackwater and food waste, integrated with agriculture. *Water Science and Technology* 39, pp. 161-168.
- Skjelhaugen O.J. (1999b). Thermophilic aerobic reactor for processing organic liquid wastes. *Water Research* 33, pp. 1593-1602.
- Sonesson U. (1998). *System Analysis of Waste Management - The ORWARE Model, Transport and Compost Sub-Models*. Agraria 130, Doctoral thesis. Uppsala: SLU
- Sonesson U. & Jönsson H. (1996). *Urban Biodegradable Waste Amount and Composition - Case study Uppsala. Report 201*. Uppsala: Department of Agricultural Engineering
- SP (1992). *Provning av separator/vätskeavskiljare. Rapport från Statens provningsanstalt*. Borås: Statens provningsanstalt (Swedish National Testing and Research Institute)

- Stanbury P.F., Whitacer A. & Hall S.J. (1995). *Principles of Fermentation Technology - Second Edition*. Oxford: Pergamon
- Steineck S. Gustafsson A., Richert Stinzing A., Salmomon E., Myrbeck Å., Albihn A. & Sundberg M. (2000). *Växtnäring i kretslopp*. Uppsala: SLU
- SVAB (2002). Miljöredovisning och årsredovisning 2001. Stockholm: Stockholm Vatten AB
- Svensson S.E. & Mattson J.E. (1999). Quality of Sludge From Private Septic Tanks. In: Clöve B., Etnier C., Jenssen P. & Maelum T.(eds) Proceedings of the 4th International Conference – Managing the Wastewater Resource Ecological Engineering for Wastewater Treatment. Norway. June 7-11. 1999. Ås, Norway: IEES
- Svensson L. (1993). *Ammonia Volatilization from Land-Spread Lifestock Manure - Effects of Factors Relating to Meteorology, Soil/Manure and Application Technique*. PhD Dissertation. Uppsala: SLU
- Tchobanoglous G. & Burton F.L. (1991). *Wastewater Engineering Treatment, Disposal and Reuse. 3ed. Civil Engineering Series*. International edition: McGraw-Hill
- Thamlikitkul V., Trakulsomboon S., Louisirirochanakul S., Chaiprasert A., Foongladda S., Thipsuvan K., Arjratanakool W., Kunyok R., Wasi C., Santiprasikul S. & Danchaivijitr S. (2001). Microbial Killing Activity of Peracetic Acid. *Journal of the Medical Association of Thailand* 84, pp. 1375-1382.
- Tidåker P. (2002) *LCA Methodology Used for Assessment of Grain Production Fertiliser with Source-Separated Human Urine*. Report in press. Uppsala: SLU, Department of Agricultural Engineering
- Tilton F., Benson H. & Schlenk D. (2002). Evaluation of estrogenic activity from a municipal wastewater treatment plant with predominantly domestic input. *Aquatic Toxicology* in press.
- Trémolières J., Bonfilis S., Carré L. & Sautier C. (1961). Une méthode d'étude de la digestibilité chez l'homme, le fécalogramme. *Nutritio et Dieta; European Review of Nutrition and Dietetics* 3, pp. 281-289.
- Turner C. (2002). The thermal inactivation of *E. coli* in straw and pig manure. *Bioresource Technology* 84, pp. 57-61.
- Turner C. & Burton C.H. (1997). The inactivation of viruses in pig slurries: a review. *Bioresource Technology* 61, pp. 9-20.
- Vahter M., Berglund M., Lind B., Jorhem L., Slorach S. & Friberg L. (1991). Personal monitoring of lead and cadmium exposure - a Swedish study with special reference to methodological aspects. *Scandinavian Journal of Work, Environment and Health* 17, pp. 65-74.

- Vinnerås B. (1998). *Källsorterad Humanurin - Skiktning och Sedimentering samt Uppsamlad Mängd och Sammansättning*. Institutionsmeddelande 5. Uppsala: SLU, Department of Agricultural Engineering
- Vinnerås B. (2001). *Faecal Separation and Urine Diversion for Nutrient Management of Household Biodegradable Waste and Wastewater*. Department of Agricultural Engineering, Report 245. Uppsala: SLU, Department of Agricultural Engineering
- Vinnerås B., Höglund C., Jönsson H. & Stenström T.A. (1999). Characterisation of sludge in urine separating sewerage systems. In: Klöve B., Etniner C., Jenssen P. & Maehlum T.(eds) Proceedings of the 4th International Conference – Managing the Wastewater Resource Ecological Engineering for Wastewater Treatment. Norway. June 7-11. 1999. .
- Ward R.L. (1978). Mechanism of Poliovirus inactivation by ammonia. *Journal of Virology* 26, pp. 299-305.
- Werkerle J. & Albrecht H. (1983). Inactivation of vaccina virus and a bovine enterovirus in areated pig slurry with special regard to pH, temperature and free ammonia modification during aeration. *Agricultural Wastes* 7, pp. 39-50.
- WHO (1991). *Inorganic Mercury. Environmental Health Criteria 118*. New York: WHO
- WHO (1992). *Cadmium. Environmental Health Criteria 134*. Vammala: WHO
- WHO (1995). *Inorganic Lead. Environmental Health Criteria 165*. Vammala: WHO
- Williams R.J.P. & Fraústo da Silva J.J.R. (2000). The distribution of elements in cells. *Coordination Chemistry Reviews* 200-202, pp. 247-348.
- Åkesson T. (2002). Personal comment. Aquatron International AB. 2002-02-04 torsten@aquatron.se

Acknowledgements

The work performed within this thesis were financed by, Mistra (Foundation for Strategic Environmental Research, in Sweden), the Mistra program Urban Water, VA-Forsk and, Lip kansliet i Stockholm.

I am very grateful to my supervisor Håkan Jönsson who introduced me into the fascinating world of nutrient recycling and for his never-ending enthusiasm in the area of nutrient recovery and environmental science. I will also thank Ann Albihn for her competent advise in the jungle of microorganisms.

Two more persons that meant a lot are during this time are Johanna Weglin and Anders Björklund when completing their master studies.

I would also like to thank;

Helena Palmquist for good cooperation and for the opportunity to look at things using your wastewater spectacles instead of my old environmental ones.

other co-authors and co-workers, especially Annika Holmqvist, Annika Jensen, Elisabet Bagge, Peter Balmer and Åsa Andersson for your contributions to this thesis.

the “Ecological Alternatives in Sanitation” group, Caroline Schönning, Håkan Jönsson, Jan Olof Drangert and Thor Axel Stenström for all interesting discussions and the possibility to look at sanitation in an interdisciplinary perspective.

the “Växtnäring och Miljö” group Cecilia Sundberg, Dick Gustafsson, Håkan Jönsson, Pernilla Tidåker and Sven Smårs for creating a good research environment.

all that have supported my work somehow, S1 (The Upplands Signal Regiment), Ekoporten, Aquatron and Gebers.

our Schnauzer girls Lisa, Astrid, Olivia and Stina for forcing me out in all weathers during mornings, lunchtime and evenings, making me take in some fresh air and giving me the opportunity to think and reflect about what I really am doing.

Finally I would like to thank the most important person in my life, Henrietta, it's been some wonderful years and I am very grateful for all the support and helping hands you have given me during this time.