

**SCIENTIFIC AND MANAGEMENT SUPPORT FOR  
VENTILATED IMPROVED PIT LATRINES (VIP)  
SLUDGE CONTENT**

**Babatunde Femi Bakare**

**MScEng (UKZN)**

Submitted in fulfilment of the academic requirements for the **degree of Doctor of  
Philosophy** in the School of Chemical Engineering University Of KwaZulu-Natal,  
Durban

**MARCH 2014**

Supervisors: Dr KM Foxon and Prof CA Buckley

**DEDICATION**

---

---

*For*

*Mercy, Daniel and David*

## DECLARATIONS

---

---

I, **Babatunde Femi Bakare**, declare that

- (i) This research reported in this thesis except where otherwise indicated is my own original work.
- (ii) This thesis has not been submitted for any degree or examination at any other University or academic institution.
- (iii) This thesis does not contain other persons' data, pictures, graphs or other information, unless specifically acknowledged as being sourced from other persons.
- (iv) This thesis does not contain other persons' writing, unless specifically acknowledged as being sourced from other researchers. Where other written sources have been quoted, then:
  - a) their words have been re-written but the general information attributed to them has been referenced;
  - b) where their exact words have been used, their writing has been placed inside quotation marks, and referenced.
- (v) Where I have reproduced a publication of which I am an author, co-author or editor, I have indicated in detail which part of the publication was actually written by myself alone and have fully referenced such publications.
- (vi) This thesis does not contain text, graphics or tables copied and pasted from the Internet, unless specifically acknowledged, and the source being detailed in the thesis and in the References sections

**Signed:** .....

**As the candidate's Supervisors we have approved this thesis for submission**

Dr KM Foxon

.....

Prof. CA Buckley

.....

## ACKNOWLEDGEMENTS

---

---

“When the LORD brought back the captivity of Zion, we were like those who dreamed, my mouth is filled with songs of joy and the LORD has done great things for me and am indeed grateful”. (Psalm 126:1-3). To God be the glory, the almighty father who saw me through this experience and made it possible for the completion of this research work. I will forever love him.

My sincere gratitude goes to Dr K.M Foxon without whom this research would never have been possible. Kitty, your dedication to your students and how you have supported me throughout the course of this research work, your commitment as well as your valuable comments has aided my proper understanding of the study and rightfully directed me towards achieving the set research objectives of this study. I will also like to acknowledge Prof. Chris Buckley for giving me the opportunity and providing me with all necessary financial assistance throughout the duration of the study. I really appreciate your leadership role and support. My profound gratitude also goes to Mr. Chris Brouckaert for his immeasurable contribution towards the completion of this research work, your constant willingness and speedy response to the call for assistance throughout the course of the study is really appreciated.

The research work presented in this thesis is part of two Projects funded by Water Research Commission which are entitled; **K5/1745 *Understanding sludge accumulation in VIPs, Urine diversion toilets and other onsite sanitation systems, and strategies to manage desludging in the future when pits are full*** and **K5/1829 *Investigating the potential of deep row entrenchment of pit latrine and water treatment works sludge for agroforestry and land rehabilitation purposes***. The financing of these projects by the Water Research Commission and the contribution of the members of the Steering Committee is sincerely appreciated. Also the assistance rendered throughout this study by eThekweni water and sanitation service, Funkamela pit emptier and Partners in Development (PID) is gratefully acknowledged. Many thanks to the technical staff and all postgraduate students at the Pollution Research Group, School of Chemical Engineering University of KwaZulu-Natal for their

assistance and contribution towards the success of this research work. You guys really made it fun.

I will also like to thank my parent and siblings for their prayers and moral support throughout the duration of this study. My heartfelt gratitude goes to my wife, Mercy, for her prayers, support and encouragement which kept me going and to my sons, Daniel and David; you both have been my source of inspiration, I love you both. And to all my friends that I could not mention all your names, you have been so wonderful.

## ABSTRACT

---

---

Providing adequate sanitation to all in the form of VIP latrines as proposed by the South African Government Strategic Framework for Water Services does not end with building toilets. All municipalities need to plan for maintenance during the operation and when these toilets reach their capacity. An understanding of the processes occurring in pit latrines will facilitate better management during their lifespan and identifying suitable options for dealing with the accumulated sludge when they eventually reach their capacity. This research aims at providing scientific support for decision making in management of accumulated sludge in ventilated improved pit latrines during their life span and when they reach their capacity under South African conditions. The approach to this research work was divided into two main thrusts: The first was to provide an understanding of the processes in VIP latrines and mechanism of sludge stabilization in pit latrines. The second approach was to provide management and disposal options for pit latrine sludge before and once it has been exhumed in the context of the eThekweni pit latrine emptying programme. Two options were used as case studies, namely: (i) deep row entrenchment of exhumed pit sludge for agroforestry and, (ii) in situ treatment of pit sludge using additives.

Three hypotheses were proposed: that (i) significant biological stabilization occurs in a pit latrine with time, such that the disposal/treatment options depend on the inherent ability of the chosen option to accept the load of solids and organic material in the VIP sludge, the residual biodegradability of the VIP sludge, and the health risks, (ii) VIP latrine sludge can be used in deep row entrenchment for agroforestry since the sludge contains nutrients that are available to plants, and that the sludge is sufficiently stable not to cause a negative environmental impact, and (iii) that In situ treatment of VIP latrine sludge using pit additives had no significant effect on the rate of mass loss or volume loss of pit latrines contents.

The methodological approach to this research was aimed at addressing the proposed research hypotheses. Thus to test the first hypothesis, two studies were conducted; the first study investigated sludge accumulation rate in pit latrines and the role of digestion

processes on sludge accumulation rate in pit latrines. Direct measurement of sludge accumulation rate from selected pit latrines within a community in eThekweni municipality was performed and a laboratory investigation into the effect of moisture content and aerobic/anaerobic conditions on sludge accumulation rate was conducted. The second study investigated the chemical and biological characteristics of pit sludge at different depths within a pit latrine. Research into deep row entrenchment of VIP latrine sludge for agroforestry was conducted to test the second hypothesis. The effect of deep row entrenchment on sludge characteristics and surrounding groundwater at the site was investigated by monitoring changes in sludge characteristics and groundwater quality at the entrenchment site over time. An investigation into the effect of pit latrine additives on pit sludge was conducted to test the third hypothesis. Two sets of trials were conducted; the first was a laboratory trial conducted to investigate the effect of pit latrines additives on collected sludge samples from pit latrine in laboratory scale test units. The rate of mass loss that could arise from the effect of addition of pit additives to sludge in the test unit was determined. The second was a field trial in which pit additives were added to randomly selected pit latrines within a community in Durban and changes in amount of the sludge in the pit was investigated using a laser tape measure and a stereographic imaging technique.

The main findings of this research were:

- The sludge volume accumulation rate in pit latrines investigated was between 120 ℓ/year and 550 ℓ/year regardless of the number of pit users. The overall average sludge accumulation rate was  $282 \pm 46$  ℓ/year. This converts to a per capita sludge accumulation rate of 56 ℓ/person·year for an average of 5 number of pit users obtained in this study. Statistical analysis performed indicated that sludge accumulation rate on a per capita basis does not decrease with an increase in number of pit users.
- In the laboratory batch experiments, it was observed that by increasing the moisture content the rate of degradation of sludge samples decreases. Over a period of 230 days, mass loss was inversely proportional to total moisture content, and it was found that the mass of solids have been reduced to

somewhere between 17 and 64 % of the original sludge mass. This effect was attributed to the exposure of sludge samples in the test units to oxygen, since sludge samples with higher total moisture content in the test units appeared as increased depth of free liquid between sludge sample and air. The calculated mass loss rates observed is expected to be higher than that which will be observed in a pit because the laboratory test had continuous air exposure but pit contents are usually covered over by new materials added to the pit.

- Natural stabilization of sludge within the pit does occur if the pit is managed and maintained properly thus providing a long service life for the pit. It was found that the volume of materials have been reduced to between 50 and 75 % of the volume of material added over the 3 years since the pits investigated were last emptied, based on the observed per capita sludge accumulation rate and an estimate of the material added to the pit per person/year. Thus, by comparing the calculated mass reduction in the batch laboratory experiment with the volume reduction in the field investigation of sludge accumulation rate, it can be inferred that sludge densification/compaction could play an important role on the stabilization processes in a pit.
- The nature of sludge in pit latrines varied significantly within the pit and between different pits. It was observed that below the surface layer in a pit, additional stabilization of sludge does occur and the degree of stabilization within a pit increases with increasing depth from the surface down to the bottom layer of the pit. Sludge samples from the bottom of the pit were well stabilized.
- It was also observed from the investigation into deep row entrenchment of pit sludge for agroforestry that further stabilization of pit sludge does occur and as a result of that, nutrients (nitrogen, phosphorus and potassium) locked up in the buried sludge are released as fertilizers. Trees planted near buried VIP sludge showed better growth rate compared to those buried only on soil without VIP latrine sludge and no profound effect on groundwater was observed for the duration in which monitoring was carried out. Further research is needed to



develop models for implementing this method cost effectively across a range of conditions.

- Neither laboratory trials nor field trials provided any evidence that the use of pit additives have any beneficial effect on VIP latrine sludge. There were no systematic and statistically significant changes in the rate of mass loss on sludge samples in the laboratory test units as well as changes in sludge content of the pit latrines used for the field trials as a result of pit latrine additives. Although, it was observed that there was significant reduction in sludge height in pit latrines in which only water was added compared to those in which additives were added and those in which nothing was added (control) using the infrared distance measure, this effect can probably not be explained completely to be as a result of increasing biodegradation rate caused by higher moisture content, since this explanation would have been observed in the laboratory trials as well as in measurement taking using the stereographic imaging techniques. Instead, flattening of the surface of sludge content in the pit by the addition of water onto the highest part of the pile may play a part in the apparent reduction of sludge height observed.

It is therefore concluded from the investigation conducted in this research, that sludge content in pit latrines has naturally undergone significant degradation and that the options for disposal of pit latrine sludge would be limited by the characteristics of the sludge. Therefore disposal options involving biological treatment such as disposal into wastewater treatment plants and anaerobic digestion are not appropriate because the residual biodegradability of VIP latrine sludge obtained was very low (about 30 %) and as such would only result in accumulation of undigested solid; of the options considered in this research, deep row entrenchment of VIP latrine sludge for agroforestry seems to be an appropriate option for the disposal of VIP latrine sludge. There was no evidence to suggest that pit latrine additives have any effect in reducing sludge content in pit latrines.

# TABLE OF CONTENTS

---

---

<b>DEDICATION .....</b>	<b>i</b>
<b>DECLARATIONS .....</b>	<b>ii</b>
<b>ACKNOWLEDGEMENTS .....</b>	<b>iii</b>
<b>ABSTRACT.....</b>	<b>v</b>
<b>TABLE OF CONTENTS .....</b>	<b>ix</b>
<b>LIST OF TABLES .....</b>	<b>xiii</b>
<b>LIST OF FIGURES .....</b>	<b>xiv</b>
<b>LIST OF ABBREVIATIONS.....</b>	<b>xviii</b>
<b>1 INTRODUCTION .....</b>	<b>1</b>
1.1 DELIMITATION.....	3
1.2 THESIS STRUCTURE.....	4
<b>2 LITERATURE REVIEW .....</b>	<b>6</b>
2.1 THE VIP LATRINE .....	6
2.1.1 Problems associated with VIP latrines.....	8
2.1.2 Pit emptying techniques.....	10
2.2 PROCESSES OCCURRING IN VIP LATRINES.....	15
2.2.1 Non-Biological Processes/Physical Processes in Pit Latrines .....	15
2.2.1.1 Sludge Accumulation rates .....	15
2.2.1.2 Moisture content and movement of moisture within the pit.....	19
2.2.2 Biological Processes in Pit latrines.....	20
2.2.2.1 Aerobic Digestion .....	21
2.2.2.2 Anaerobic Digestion .....	22
2.2.3 Factors Affecting Anaerobic Digestion Processes.....	24
2.2.3.1 Temperature .....	24
2.2.3.2 Moisture Content .....	25

2.2.3.3	pH.....	25
2.2.3.4	Nutrients.....	26
2.2.3.5	Toxic Compounds.....	26
2.3	COMPOSITION AND DISPOSAL OF VIP LATRINE SLUDGE.....	26
2.3.1	Disposal of pit sludge into wastewater treatment works .....	34
2.3.2	Onsite burial of pit latrine sludge .....	35
2.3.3	Transport to landfill sites .....	35
2.3.4	Deep row entrenchment of sludge for Agroforestry.....	36
2.3.5	Further dewatering and treatment/ processing to produce agricultural fertilizers .....	37
2.4	PIT LATRINE ADDITIVES .....	38
2.5	GAP ANALYSIS.....	40
<b>3</b>	<b>RESEARCH METHODOLOGICAL APPROACH .....</b>	<b>46</b>
3.1	DESCRIPTION OF STUDY AREA .....	47
3.2	RESEARCH METHODS .....	48
3.2.1	Methodological approach for hypothesis 1.....	49
3.2.2	Methodological approach for hypothesis 2.....	51
3.2.3	Methodological approach for hypothesis 3.....	56
3.3	LABORATORY CHARACTERIZATION TECHNIQUES.....	60
3.3.1	Moisture Content Analysis .....	61
3.3.2	Solids Characterizations .....	61
3.3.3	Chemical Oxygen Demand.....	62
3.3.4	Aerobic Biodegradability.....	62
3.3.5	Nitrogen and Phosphorus.....	62
<b>4</b>	<b>SLUDGE ACCUMULATION RATE IN VIP LATRINES .....</b>	<b>64</b>
4.1	OBSERVED SLUDGE ACCUMULATION RATE.....	65
4.2	ROLE OF DIGESTION PROCESSES ON ACCUMULATION RATE.....	74
4.3	DISCUSSION OF RESULTS .....	79

<b>5</b>	<b>CHARACTERIZATION OF SLUDGE CONTENTS IN A VIP LATRINE..</b>	<b>82</b>
5.1	RESULTS OF CHARACTERIZATION OF PIT SLUDGE CONTENT .....	84
5.1.1	Moisture content characterization results .....	85
5.1.2	Volatile solid characterization results .....	86
5.1.3	Chemical oxygen demand characterization results.....	88
5.1.4	Aerobic biodegradability characterization results .....	90
5.2	DISCUSSION OF RESULTS .....	92
<b>6</b>	<b>ENTRENCHMENT OF VIP LATRINES SLUDGE FOR AGROFORESTRY</b>	<b>96</b>
6.1	SITE DESCRIPTION .....	96
6.2	SLUDGE CHARACTERIZATION RESULTS .....	99
6.3	Groundwater Quality Results at the Entrenchment Site .....	106
6.3.1	Challenges.....	106
6.3.2	Results of Laboratory Analysis of Groundwater Samples.....	107
6.4	DISCUSSION OF RESULTS .....	110
<b>7</b>	<b>EFFECTS OF PIT ADDITIVES ON SLUDGE CONTENT IN VIP</b>	<b>114</b>
<b>LATRINES.....</b>	<b>114</b>	
7.1	PIT LATRINE ADDITIVE DESCRIPTION .....	115
7.2	RESULTS OF LABORATORY TRIALS FOR TESTING PIT ADDITIVES	116
7.3	RESULTS OF FIELD TRIALS FOR TESTING PIT ADDITIVES .....	121
7.3.1	Field trial results using the infrared laser distance measure .....	122
7.3.2	Field trial results using stereographic imaging technique .....	125
7.3.2.1	Principle of the stereographic imaging technique.....	126
7.3.2.2	Obtained Results .....	130
7.4	DISCUSSION OF RESULTS .....	132
<b>8</b>	<b>DISCUSSION AND IMPLICATION OF FINDINGS .....</b>	<b>136</b>
8.1	SLUDGE BUILD UP IN VIP PIT LATRINES .....	137

8.2	CHARACTERISTICS OF PIT LATRINES SLUDGE CONTENT .....	140
8.3	DEEP ROW ENTRENCHMENT FOR AGROFORESTRY .....	143
8.4	EEFICACY OF PIT LATRINE ADDITIVES .....	149
<b>9</b>	<b>CONCLUSIONS AND RECOMMENDATIONS.....</b>	<b>151</b>
9.1	CONCLUSIONS .....	152
9.2	RECOMMENDATIONS .....	156
9.3	RECOMMENDATION FOR FUTURE RESEARCH WORK.....	156
	<b>REFERENCES.....</b>	<b>158</b>
<b>APPENDIX A</b>	<b>SAMPLE QUESTIONNAIRE/ETHICAL CLEARANCE ....</b>	<b>166</b>
<b>APPENDIX B</b>	<b>ANALYTICAL AND STATISTICAL METHODS .....</b>	<b>168</b>
<b>APPENDIX C</b>	<b>GROUNDWATER SAMPLING AND DATA .....</b>	<b>179</b>
<b>APPENDIX D</b>	<b>EFFECT OF VIP SLUDGE ON TREE GROWTH .....</b>	<b>196</b>
<b>APPENDIX E</b>	<b>PUBLICATIONS.....</b>	<b>200</b>

## LIST OF TABLES

---

---

Table 2.1:	Pit latrine filling rates (Still, 2002).....	17
Table 2.2:	Proposed maximum sludge accumulation rates for VIP latrine design (Franceys <i>et al</i> , 1992).....	18
Table 2.3:	Summary of reported Characteristics of faeces.....	27
Table 2.4:	Characteristics of VIP latrines sludge contents (Buckley <i>et al</i> , 2008)....	29
Table 2.5:	Pathogen survival periods in faecal sludge (according to IWMI & SANDEC, 2002).....	30
Table 2.6:	Classification System for Sludge in South Africa (Snyman and Herselman, 2006).....	32
Table 5.1:	Summary of VIP Sludge contents at different layer within the pit.....	94
Table 6.1:	Soil Analysis from Umlazi E-Pond (Still <i>et al</i> , 2012).....	97
Table 6.2:	Summary of results obtained from groundwater monitoring programme compared with SABS specification for drinking water.....	108
Table 6.3:	Summary of fresh VIP sludge contents and trench samples.....	111
Table 7.1:	Pit latrine dosing schedule for the field trials as recommended by the manufacturers (Bakare <i>et al</i> , 2010).....	121
Table 7.2:	Allocation of treatments to 30 experimental pit latrines (Bakare <i>et al</i> 2010).....	122
Table 7.3:	Overall sludge height reduction results for the field trials.....	125

## LIST OF FIGURES

---

---

Figure 1.1:	Schematic layout of the Thesis.....	5
Figure 2.1:	Basic structure of a VIP (Buckley <i>et al</i> , 2008).....	8
Figure 2.2:	The MAPET system (Source: Sugden, 2005).....	11
Figure 2.3:	The Gulper (Source: Sugden, 2005).....	12
Figure 2.4:	The Vacutug (Source: Sugden, 2005).....	13
Figure 2.5:	Typical scene in Durban South Africa (Source: PRG, 2008).....	14
Figure 2.6:	Observed sludge accumulation rates with reported number of users (Still <i>et al</i> , 2012).....	19
Figure 2.7:	Diagram showing the different theoretical layers within a pit latrine. (Buckley <i>et al</i> 2008). Numbers refer to each layer within a pit.....	20
Figure 2.8:	Schematic Representation of Anaerobic processes indicating which Microorganism facilitates each conversion process (Speece, 1996).....	23
Figure 2.9:	Growth rate of psychrophilic, mesophilic and thermophilic Methanogens (Van <i>et al</i> , 1997).....	24
Figure 2.10:	Typical content of pit latrines from two pits in different communities in eThekweni Municipality (Photo taken during field work, 2007).....	28
Figure 2.11:	Transportation of manually evacuated VIP sludge and screening of the sludge during the pilot trial conducted for the disposal of pit latrine sludge into treatment works at Tongaat Central Treatment Works (Bakare <i>et al</i> 2008).....	35
Figure 2.12:	Dehydrated and Pasteurized Pit sludge for Agricultural fertilizer (Source: Wilson and Harrison, 2012).....	37
Figure 3.1:	Excavation and Sludge burial in Trenches at the Umlazi Site.....	53
Figure 3.2:	Location of boreholes at the umlazi E-pond entrenchment site.....	54
Figure 3.3:	Groundwater monitoring borehole detail.....	54
Figure 4.1:	Amalgamated sludge accumulation rate data in $\ell$ /year as a function of number of pit users fitted with a linear model.....	66

Figure 4.2:	Schematic diagram of pit latrine construction for the 30 pits investigated in the accumulation rate study. The location of the points used for measuring the pit sludge height is shown as P1, P2 and P3.....	69
Figure 4.3:	Scatter plot for observed sludge accumulation rate with number of users. ....	70
Figure 4.4:	Sludge accumulation rate data in $\ell$ /year as a function of number of pit users fitted with a linear model.....	71
Figure 4.5:	Degradation of pit latrine sludge content with time showing aerobic conversion and anaerobic conversion process. Values shown are purely illustrative.....	75
Figure 4.6:	Cumulative mass loss of pit latrine sludge jar test at different moisture content over the entire duration of the experiment.....	76
Figure 4.7:	Normalized cumulative mass loss rate to show the significant effect of increasing moisture content on mass loss rate of pit latrine sludge content. Error bars represent standard deviation on the mean.....	77
Figure 5.1:	Expected trend for the decrease of the residual biodegradable solid as a fraction of total solids from the surface layer of the pit down to the bottom of the pit.....	83
Figure 5.2:	Material found in a pit during emptying.....	84
Figure 5.3:	Moisture content characterization results (a) for each of the 16 pits from different layers within each pit (b) average moisture content at each layer for the 16 pits. Error bars represent 95 % confidence on the mean value of each layer.....	85
Figure 5.4:	Volatile solid characterization results (a) for each of the 16 pits from different layers within each pit (b) average volatile solids at each layer for the 16 pits. Error bars represent 95% confidence interval on the mean value of each layer.....	87
Figure 5.5:	Total COD characterization results (a) for each of the 16 pits from different layers within each pit (b) average COD at each layer for the 16 pits. Error bars represent 95% confidence interval on the mean value of each layer.....	89
Figure 5.6:	Aerobic Biodegradability results (a) for each of the 16 pits from different layers within each pit (b) average Biodegradability at each layer for the 16 pit Error bars represent 95% confidence on the mean value of each layer.....	91
Figure 6.1:	General layout and details of the Umlazi VIP latrine sludge entrenchment site.....	98



Figure 6.2:	Moisture content results for both fresh VIP latrine and trench samples. Error bars represent 95% confidence interval on the mean of the replicate measurements.....	99
Figure 6.3:	Volatile solid results for both fresh VIP latrine and trench samples. Error bars represent 95% confidence interval on the mean of the replicate measurements.....	100
Figure 6.4:	COD results for fresh VIP latrine and trench samples. Error bars represent 95% confidence interval on the mean of replicate measurements.....	102
Figure 6.5:	Biodegradability results for fresh VIP latrine and trench samples. Error bars represent 95% confidence interval on the mean of the replicate measurements.....	103
Figure 6.6:	Results obtained from the analysis of nitrogen and phosphorus content in VIP latrine sludge before the burial of the sludge and after significant periods of entrenchment of the sludge associated with trees planting. Error bars represent 95% confidence interval on the mean on the replicate measurements.....	105
Figure 7.1:	Rate of Mass loss with time for each replicate after 30 days of incubation.....	117
Figure 7.2:	Box and Whisker plot showing rate of mass loss from honey jar containing pit latrine sludge samples subject to different treatments. The box for each data set represents the range of the 95 % confidence interval on the mean, while the whisker shows maxima and minima from within each data set.....	118
Figure 7.3:	Cumulative Rate of Mass loss for Product A and Product B over 30 days of incubation period (a) Product A and (b) Product B. Each graph shows data from between 3 and 5 replicates of each treatment.....	119
Figure 7.4:	Preparation of Pit latrine additives for application to Pit Latrine (Bakare <i>et al</i> , 2010).....	122
Figure 7.5:	Change in pit latrine sludge height for all the treatments for the field trials using the Laser tape measure.....	123
Figure 7.6:	Box and Whisker plot showing change in height of pit latrine contents over a period of 6 months for the field trials using the infrared laser distance measure. The box for each data set represents the range of the 95 % confidence interval on the mean, while the whisker shows maxima and minima from within each data set.....	124
Figure 7.7:	Supporting System for the Photographic Equipment.....	126
Figure 7.8:	Camera Supporting System.....	127

Figure 7.9:	Single images of the pit surface (Clockwise from the top left: Back; left side, forwards, right side of pit).....	128
Figure 7.10:	Stereographic images of a pit surface showing the points selected for triangulation calculations.....	129
Figure 7.11:	Surface Map generated by Triangulation of selected points on the images.....	129
Figure 7.12:	Net sludge reduction for all the treatments for the field trials using the Stereographic method.....	131
Figure 7.13:	Box and Whisker plot showing Net sludge reduction pit latrine contents over a period of 6 months for the field trials using the Stereographic methods. The box for each data set represents the range of the 95 % confidence interval on the mean, while the whisker shows maxima and minima from within each data set.....	132
Figure B.1:	Aerobic Biodegradability Set up.....	171
Figure B.2:	Histogram for the standard deviations recorded for various parameter analysis performed for sludge samples collected directly from the pits at different layers.....	176
Figure B.3:	Histogram for the standard deviations recorded for various parameter analysis performed for fresh VIP sludge samples before burial in trenches and sludge samples exhumed from trenches.....	177
Figure D.1:	Measurement of plant height and stem diameter (Eucalyptus and Acacia mearnsii) in plant columns containing pit latrine sludge compared to plant columns without pit latrine sludge (control). (Reproduced with permission from Taylor, 2011).....	198
Figure D.2:	Light and CO <sub>2</sub> Response Curve for flooded gum tree and black wattle trees, where plot (a) and (b) represent the light response curve for flooded gum and black wattle trees respectively. Plot (c) and (d) represents the CO <sub>2</sub> response curve for flooded gum and black wattle trees respectively. (Reproduced with permission from Taylor, 2011). 199	199

## LIST OF ABBREVIATIONS

---

---

ANOVA	Analysis of Variance
BH	Borehole
COD	Chemical oxygen demand
DWAF	Department of Water Affairs and Forestry
EWS	eThekweni Municipality Water and Sanitation
FSA	Free and Saline Ammonia
TKN	Total kjeldahl nitrogen
TLB	Tractor Loader Backhoe
TS	Total Solids
TSS	Total Suspended Solids
VIP	Ventilated Improved Pit latrine
VS	Volatile Solids
WHO	World Health Organization
WRC	Water Research Commission
WWTP	Wastewater treatment plant

# 1 INTRODUCTION

---

---

Providing adequate and appropriate sanitation facilities in most of the developing countries still remains a major challenge. Today, inadequate sanitation facilities contribute to a large extent to major environmental health problems facing many developing countries which have adverse effect on both human and economic developments. In South Africa, the provision of adequate, appropriate, effective and sustainable sanitation facilities for all is a necessity as well as a fundamental human right (DWAF, 2003). Ventilated improved pit (VIP) latrines have been designated as the minimum acceptable level of sanitation that supports the rights of all South Africans to a decent sanitation. This on-site sanitation system has been implemented widely across the country.

Despite the approval of ventilated improved pit latrines as the minimum acceptable level of sanitation, these on-site sanitation systems eventually reach their full capacity and if a long term plan for their maintenance is not in place, they will become unusable and households will be effectively without basic sanitation again. Although some Municipalities/Water Service Authorities in South Africa are actively putting in place programmes to manage the accumulated sludge, many are only focussed on providing this sanitation system to address the current backlogs without any serious thought on operation and maintenance (Still *et al*, 2012). Many of the VIP latrines that have been built over the last decades are currently full and overflowing and require urgent emptying. The goal of this research is to provide scientific support for decision making in management of accumulated sludge in ventilated improved pit latrines during their life span and when they reach their capacity under South African conditions. In order to achieve this, two important factors needs to be taken into consideration; (i) how would the accumulated sludge be managed during the operation and when the pit reaches the end of their design life; and (ii) how to turn sludge accumulated in pits from a problematic waste to a beneficial resource without causing any environmental impacts.

There is very little knowledge on the processes occurring within a pit; neither is there adequate understanding of what the condition of the material in pits will be when the pits become full. An understanding of the processes occurring within the pit during their life span and the nature of material that is dug out of pits will facilitate better management of the pit sludge and provide the required information needed in identifying suitable disposal routes for the accumulated sludge upon emptying. Several factors determine the characteristics of the material found in VIP latrines. It has been widely reported in the available literature that apart from the use of pit latrines for the accumulation of faecal material (faeces and urine), many households discard a large variety of other objects and waste which are not biodegradable into the pit latrines (Mara, 1984; Franceys et al., 1992; Cotton et al., 1995; Still, 2002). The large amounts of non-degradable material such as plastics, metal and rubber which are often found in the pits could result in the blockages of pit emptying equipment and also interfere with the processes of natural stabilization within the pit. Thus any technology development for emptying, treatment and disposal of pit latrine sludge would benefit from an in depth understanding of the characteristics of sludge found in pit latrines.

In many developing countries accumulated sludge from on-site sanitation systems such as pit latrines and septic tanks are frequently disposed of untreated into inland water, estuaries, and seas or used in agriculture or aquaculture causing serious health risks and pollution (Ingallinella *et al*, 2002). In eThekweni municipality, various options for the disposal of accumulated VIP latrines sludge have been proposed: These include; transporting pit sludge and discharging into wastewater treatment works, burial onsite, disposal at landfill site, and deep row entrenchment of sludge for agroforestry and dewatering and processing to produce agricultural fertilizers (Still *et al*, 2012). These proposed options by the municipality were all on the basis that pit contents that are dug out of the pit are not very different to the materials that are added to the pit and therefore the appropriate disposal/treatment options for the accumulated sludge would be similar to treatment options used for fresh sanitation waste. However, previous research (Buckley *et al*, 2008 Cotton *et al*, 1995; Franceys *et al*, 1992; Mara, 1984 and Nwaneri, 2009) suggests that biological degradation of sludge does occur within the pit, however the extent to which this takes place and how, is not clear. Apart from the

options proposed by the eThekweni municipality for the disposal of accumulated pit sludge when the pit becomes full, there are a number of pit latrine additives on the market in South Africa that claim to prevent pits from filling up, to reduce the rate at which pits fill up, or to reduce odour or fly problems. However independent scientific evidence to support these claims is not readily available.

The current research work is therefore focused on how to manage sludge in pit latrines and when the sludge is been removed from the pit latrines. Two studies were conducted (i) Investigation into deep row entrenchment of pit sludge for agroforestry, and (ii) investigation into the efficacy of pit latrine additives. However as a background and in order to understand what is happening in these studies, an idea of sludge accumulation rates in pit latrines (for providing an indication of the extent of sludge stabilization in pit latrines and comparison with additive treated pit accumulation rates) and processes/characteristics of pit sludge (for understanding the starting material for pit additive trial and deep row entrenchment studies) is required. Thus, the approach to this research was divided into two main thrusts; the first was to provide an understanding of the processes in VIP latrines and mechanism of sludge stabilization in pit latrines while the second was to provide management and disposal options for pit latrine sludge before and once it has been exhumed in a South Africa context.

## **1.1 DELIMITATION**

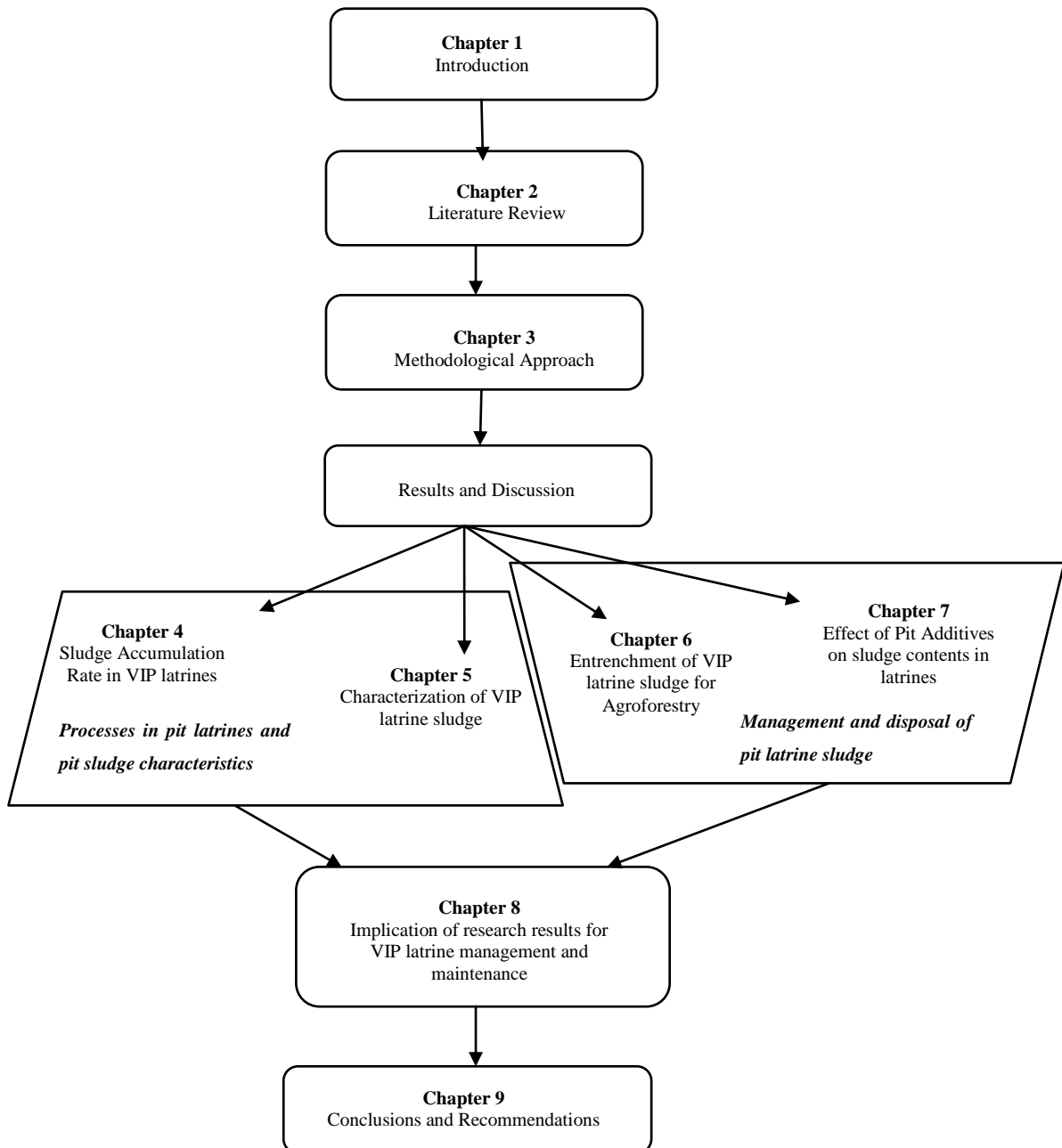
It is generally acknowledged (Ingallinella *et al*, 2002; Eales, 2005; Eawag, 2006, Bakare *et al*, 2008) that the two major challenges faced when pit latrines become full are; (i) digging out the sludge from the pit and (ii) disposing the exhumed sludge. The process of and equipment required for digging out pit sludge is more mechanical and civil engineering than chemical engineering, and therefore, while an understanding of the process and the associated challenges is important to this study, this research work did not undertake any research into pit emptying processes and devices, but rather focused on the science and engineering required to understand the nature of the pit contents, and the significance of this in terms of managing sludge disposal once the pit sludge has been exhumed. However, the findings of this study may be helpful to researchers investigating mechanical emptying of pit latrines since the characteristics of

the pit sludge will be of importance in the design of pit emptying devices. This study only considers two of the options for managing pit latrine sludge in detail i.e. deep row entrenchment of pit sludge and *In situ* treatment of pit latrine sludge using additives. It should also be noted that the study on the deep row entrenchment of pit sludge for agroforestry is only concerned with processes and analyses that are related to pit sludge characteristics. While it is important to be aware of other categories of issues that relate to pit sludge management (e.g. groundwater, soil science, tree growth, social issues etc.), these are outside the scope of the study.

## 1.2 THESIS STRUCTURE

The research and findings are covered in the following 8 chapters of this thesis. **Chapter 2** is the literature review of the key aspects related to the design of VIP latrines, problems associated with the design and description of pit emptying methods, sludge build up in pit latrines, characteristics of pit sludge and degradation of sludge within the pit. Chapter 2 also covers aspects related to sludge disposal and handling guidelines, description of the different disposal options available for pit latrines sludge and review of available literature related to the efficacy of pit latrine additives on sludge build up and biodegradation processes taking place within the pit. **Chapter 3** focuses on the methodological approaches followed in this study which is built up to detailed hypotheses of the thesis informed by the literature reviewed in Chapter 2. The results of the research findings are presented and discussed in **Chapter 4, Chapter 5, Chapter 6 and Chapter 7**. There are two distinct parts to this research work. In the first part **Chapter 4 and 5** deals with understanding the processes in pit latrines starting from the net observed sludge accumulation rate from a field study on randomly selected VIP latrines within the boundaries of eThekweni municipality as presented in **Chapter 4**. **Chapter 5** considers the characteristics of sludge in pit latrines towards understanding what processes are expected to have occurred during the residence time of the sludge in the pit. The second part of the results, **Chapter 6 and 7**, separately considered two options for (i) disposing of sludge accumulated in the pit latrine via deep row entrenchment as presented in **Chapter 6** and (ii) treating the sludge *In situ* with commercially available pit latrine additives (**Chapter 7**). These two options may be

considered test cases of pit sludge management options that both start from the pit sludge characteristics and mechanisms within the pit latrine. **Chapter 8** describes and discusses the broad impact of the results presented in the previous chapters. The final conclusions and recommendations are presented in **Chapter 9** where the thesis objectives and proposed hypotheses are addressed and the results of the research are evaluated. The schematic representation of the thesis is provided in **Figure 1**.



**Figure 1.1:** Schematic layout of the Thesis



## 2 LITERATURE REVIEW

---

---

This chapter defines the context of the problem through a review of literature related to this study. The literature review is presented in four main sections: in the first section, key aspects related to VIP latrine design, problems associated with design, operation and maintenance of VIP latrines and a brief description of the available pit emptying methods are discussed. The second section focuses on literature related to the type and characteristics of materials found in pit latrines, and processes occurring in pit latrines (sludge build up and degradation processes occurring within the pit). The third section deals with a review of available literature on handling and disposal options for accumulated sludge upon emptying of the pit. The fourth section of the literature review deals with aspects related to the use of pit latrine additives and findings on the efficacy of pit additives on sludge content in the pit. Finally a summary section is presented which describes the gaps in the available knowledge related to this research, the need for this research, and the specific objectives of this research as informed by the literature reviewed.

### 2.1 THE VIP LATRINE

**Figure 2.1** is a typical structure of a basic ventilated improved pit latrine. Ventilated Improved Pit latrines are used as an accumulation system for stabilizing faecal matter, urine and other materials added to the pit depending on household habits (Chaggu, 2004). They are designed primarily for the storage of faecal matter deposited in the pit (Mara, 1996). Typical ventilated improved pit latrines structure as shown in **Figure 2.1** differ from traditional pit latrines in that they are equipped with a tall vertical vent pipe which has a fly screen fitted to the top. This vent pipe serves as a medium by which odours and flies are controlled by drawing airflow into the pit via the pedestal and out of the vent pipe above head height (Mara, 1984). According to Cairncross and Feachem (1996), the screened ventilation pipe must be 500 mm above the roof of the superstructure in order to permit enough wind-induced air circulation for odour control.

The screen apertures must not be greater than  $1.2 \times 1.5$  mm, this would prevent flies and mosquitoes from passing through (Mara, 1984). Wind passing across the top of the screened ventilation pipe causes a pressure drop across the top of the vent pipe by a venturi effect (Cairncross and Feachem, 1996; Mara, 1984). This results in a net pressure drop between the pit and the top of the pipe and causes air to rise up the vent pipe. This continual circulation of air effectively eliminates the odours emanating from the faecal material in the pit (Bester and Austen 2000). According to Mara (1984), flies are attracted to the top of the screened ventilation pipe by odours emanating from faecal material in the pit and are prevented from getting inside the pit by the screening material attached to the ventilation pipe. Nevertheless, some flies may eventually manage to enter into the pit through the superstructure or the pedestal; they will instinctively fly towards the direction of light penetrating from the screened ventilation pipe where they will be trapped by the screening material attached to the ventilation pipe and will eventually fall down and die in the pit (Cairncross and Feachem, 1996; Mara, 1984; DWAF, 2003).

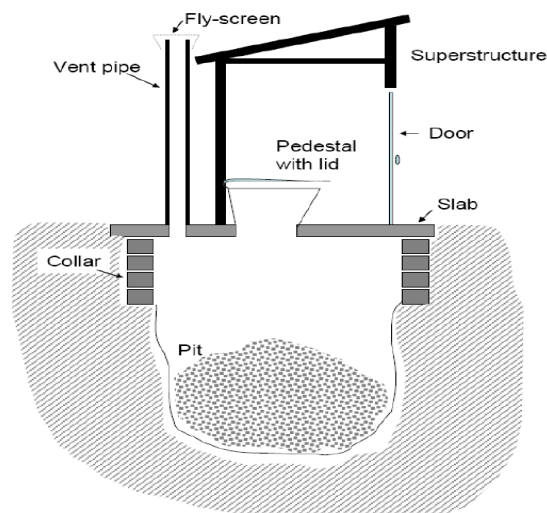
The superstructure is usually built with bricks and it is best to build the superstructure in the same general style as the house (Mara, 1984). According to Buckley *et al*, (2008) the superstructure provides privacy to the users, protects the pit from rain and sun, and provides shadow over the pedestal. The superstructure is also important for preventing flies that are newly formed from leaving the pit itself and also for channelling air through the pedestal to the vent pipe thereby controlling faecal odours (Mara, 1984). The cover slab is normally built using reinforced concrete which covers the pit. The cover slab has two holes; one for the pedestal and the other for the vent pipe (Cairncross and Feachem 1996; Mara, 1984). The cover slab provides support for the superstructure as well as the vent pipe and also prevents the exposure of faeces to the atmosphere and odours and flies from escaping to the surrounding environment (Cairncross and Feachem 1996). Human excreta are deposited in the pit. The pit is usually a single pit or alternating twin pits. The pit may be either unlined or lined in open-joint brickwork or block work (Mara, 1984). This lining helps prevent the soil from collapsing during emptying operations or during heavy rains (Mara, 1984), while the open vertical joints allow liquid (including urine) to drain into the soil (Mara, 1984). The pit is usually

circular or rectangular and may be built slightly above the surrounding ground to provide sufficient depth (Bester and Austen, 2000). The main function of the pit is to allow for the collection and storage of faeces (Mara, 1984).

According to Mara (1984), the effective pit working volume ( $V_s$ ) is calculated as:

$$V_s = \text{Sludge accumulation rate (R)} \times \text{number of users (n)} \times \text{design life (y)} \quad [2.1]$$

It is always necessary that an empty volume of  $0.5 \text{ m}^3$  is added to the calculated effective pit volume when sizing the pit. This would prevent the pit from reaching its capacity at the end of the expected design life (Mara, 1984).



**Figure 2.1: Basic structure of a VIP (Buckley *et al*, 2008)**

### **2.1.1 Problems associated with VIP latrines**

There are several problems encountered during the construction and operation of pit latrines. Depending on the location of the pit, difficulties may be encountered during the construction of the pit latrines. In rocky ground, construction of pit latrines becomes extremely difficult and expensive and digging deep pits is often not feasible (Cairncross & Feachem, 1996). Conversely, pit latrines constructed in loose and unconsolidated soils such as running sand or alluvium are liable to collapse (Cairncross & Feachem, 1996). Thus, during excavation there is need for support and the pit must be lined down to the bottom without preventing the seepage of faecal liquors out of the pit into the

surrounding soils (Cairncross & Feachem, 1996). In areas of high water table, construction of pits also becomes very difficult and excavation is best carried out during the dry season because pits tend to collapse in the wet season (Cairncross & Feachem, 1996).

The main problems encountered during the operation of pit latrines are often related to the number of users and their habits. The type of maintenance routine practiced by householders and the type of materials deposited in the pit apart from human wastes (faeces and urine) could have a significant effect on the sludge contents and processes occurring within the pit (Buckley *et al*, 2008; Still *et al*, 2010; Cairncross & Feachem, 1996). Householders may have different cleaning practices but the more common are the use of water, detergent or disinfectants (Buckley *et al* 2008). The use of water could significantly influence the total moisture present in the pit, which may result in the solubilisation of dissolvable constituents, allowing for the movement of soluble components relative to stationary solid components within the pit (Buckley *et al* 2008). Disinfectants are prone to have detrimental effects on the biological processes occurring within the pit because of their biocidal components which might have inhibitory effects on the microbial activity (Cairncross & Feachem, 1996). The disposal of kitchen refuse or addition of soil to the pit by householders may significantly contribute to the load and diversity of microorganisms in the pit (Still, 2002). This would assist in the establishment of a natural microbial population provided that conditions within the pit are favourable (Buckley *et al*, 2008). The disposal of non- biodegradable materials such as glass, plastic, metals etc into the pit will result in an accelerated filling up of the pit (Still, 2002).

When pit latrines become full, it is often necessary to empty the pit or the pit is covered up and a new one has to be dug. An emerging challenge that results from the use of VIP latrines is what to do when the pits are full (Ingallinella *et al*, 2002). A draft guideline of options for dealing with full pit latrines has been developed by the South Africa Department of Water Affairs and Forestry (DWAFF, 2007). In the guideline, the options that can be considered for dealing with full pit latrines were categorised into four; (i) abandon old latrine and build a new one, (ii) use methods to extend the life of the pit(including: adding water to the pit every day, mixing pit contents every six months,

adding biological agent etc) before emptying, (iii) use methods to render pit contents safe to empty manually, and (iv) ensure that accumulated sludge is periodically removed from the pit and appropriately treated or disposed of (DWAF, 2007). The decision on which option to adopt for a particular situation depends on a number of factors; most of which are related to local circumstances (DWAF, 2007).

### **2.1.2 Pit emptying techniques**

The removal of sludge accumulated over the years in pit latrines (i.e. conventional pit latrines and VIP latrines) becomes necessary when these pits are full unless the full pit can be covered and a new VIP latrine built to replace the full pit. Ventilated improved pit latrines and conventional pit latrines can be emptied either manually or mechanically. Manual pit emptying involves people digging out the content in a pit latrine by making use of long shovels, spades, forks, buckets, skips and other hand tools.

In 2004, the eThekweni Water and Sanitation service conducted, an exhaustive study on the available pit emptying techniques and concluded that at that time, manual pit emptying was the most viable and cost effective technique for the excavation of pit latrine sludge content (EWS, 2004). According to the study conducted manual pit emptying was found to be the preferred option based on the following reasons:

- Virtually any type of pit latrine can be emptied using this method.
- This method, among other methods of pit emptying has the least risk of mechanical failure.
- The method maximizes the use of labour thereby offering significant job creation in a context of high unemployment rate.
- The method was found to be the most cost effective method for evacuating sludge content in pit latrines.

The main disadvantage identified in the study conducted was that manually emptying a VIP latrine exposes pit emptying workers to health risks and the process is time consuming. In Uganda the application of a certain substance named ‘Verpona’ is usually added to the pit twenty minutes before the pit is emptied (Kiggundu, 1995).

This is said to destroy any viable pathogens present in the sludge. According to Scott and Reed (2006), making use of a safety harness and rope when the emptier enters the pit is necessary to provide adequate safety from fumes and also should the pit collapse. In South Africa, it is recommended that pit emptiers wear protective clothing and have access to an adequate supply of water for washing (DWAF, 2005).

Over the years mechanical devices for pit emptying have been developed aimed at reducing the disadvantages encountered from manual pit emptying. These mechanical devices are either semi-mechanized or fully mechanized. One such device is the MAPET system (**Figure 2.2**) which is a fully hand operated machine requiring manpower to build up the vacuum. The system was first developed by the Dutch NGO WASTE to solve the problems associated with the pure manual exhaustion of pit latrine sludge contents in Dar es Salaam, Tanzania (Muller and Rijnsburger, 1994). The MAPET system is comprised of a 200 litre vacuum tank and a hand pump mounted on a push cart (Muller and Rijnsburger, 1994). A 20 mm air hose is use to connect the pump to the 200 litre vacuum tank and a 100 mm pipe is used to drain the sludge from the pit (Muller and Rijnsburger, 1994). The sludge drained from the pit is usually buried on site. It normally takes up to twenty minutes to fill up the 200 ℓ vacuum tank and a team of three operators empties one pit per day on average (Kirango and Muller, 1997).



**Figure 2.2: The MAPET system (Source: Sugden, 2005).**

The MAPET develops a maximum pumping head of 3 m of liquid sludge and the width of the equipment which is usually 800 mm allows the equipment to be manoeuvred between houses (Muller and Rijnsburger, 1994). The major challenge with the use of this system is that with the amount of extraneous material that can be found in pit latrines and the thickness of the sludge in pit latrines, it will be necessary to add significant amounts of water into the pit. Adequate mixing of the sludge in the pit with the added water may be required and probably removal of debris from the pit before the equipment could be used.

Consequently, the Gulper as shown in **Figure 2.3** was developed to bridge the technology gap between manual exhaustion of pit latrine sludge content and the MAPET system by the London School of Hygiene and Tropical Medicine in the course of a study conducted in Dar es Salaam, Tanzania (Sugden, 2005). Sludge from pit latrines is usually drained out by the action of a flap valve which is fitted to a 200 mm drainpipe and the sludge is emptied into a 20 ℓ drum for disposal. The Gulper is locally manufactured and can be operated by one person; it empties to a depth of 1 m below the top of the pit (Sugden, 2005).



**Figure 2.3: The Gulper (Source: Sugden, 2005)**

In Kibera, Kenya, the United Nation Habitat developed the Vacutug which is a pedestrian controlled mechanical pit emptying device (Wegelin-Schuringa and Coffey, 1998). It consists of 500 litre vacuum tank and a motor which serves the dual purpose of propelling the unit at a speed of 5 km/h as well as creating the required vacuum in the tank so as to drain the pit latrine contents. The Vacutug is capable of evacuating dense sludge (BPD, 2001). The width of the equipment which is usually 1 350 mm allows the equipment to be manoeuvred between houses. The Vacutug is shown in **Figure 2.4**. Another mechanical method of pit emptying which has been used is the Micravac which is a small type of vacuum tanker able to reach pit latrines which larger tankers are not able to reach (EWS, 2004). The Micravac has a capacity of 2000 ℓ and able to dispose and transport the sludge to about 8 km from pit latrine site. However, larger vacuum tankers have capacities of between 5 000 to 10 000 ℓ which could be used for either direct evacuation of sludge from pit latrine, or serve as transfer vehicles where smaller or slower vehicles have been used to empty the pit latrine (Strauss and Montangero, 2002).



**Figure 2.4: The Vacutug (Source: Sugden, 2005)**

Regardless of which pit emptying technique is used, factors such as the nature of the pit contents, the accessibility to the pit as well as costs of emptying should be taking into consideration. Extraneous material added to pit latrines (rags, clothes, broken bottles,



plastics, papers, glass etc) make pit emptying a very difficult task to perform and sludge contents in pit latrines usually tends to be in a partially compacted or solidified form (Still, 2002). It has been documented that mechanical pit emptying equipment are prone to failure, since when a pit comprises mostly extraneous material, the suction pipes and valve can become blocked which could damage the equipment and in such cases the most viable pit emptying technique is to manually dig out the pit content (EWS, 2004; Eales, 2005; Kirango and Muller, 1997; Sugden, 2005). Accessibility to the pit latrine is another major factor that influences the choice of technique to be used in emptying a pit (EWS, 2004). The use of vacuum tankers usually make pit emptying easy and fast, they are usually faced with problems relating to access to the pit. Accessibility to pit location using vacuum tankers is often restricted and regularly impossible (**Figure 2.5**) because of bad roads, steep terrain and densely settled areas (EWS, 2004).

The cost of pit emptying, depending on the removal method, disposal location, accessibility of pit, and terrain, ranges between ZAR 600 and ZAR 1 000 per pit (WIN-SA 2006 values). Manual pit emptying has shown to be the most cost effective option since it does not require initial capital cost for acquiring machinery and also maintenance cost for the machinery (Eales, 2005). Although manual pit emptying might be labour intensive, in situations where local community members are employed, it can be a source of income and help in the creation of job opportunities within the local community (EWS, 2004).



**Figure 2.5:** Typical scene in Durban South Africa (Source: PRG, 2008)

## **2.2 PROCESSES OCCURRING IN VIP LATRINES**

Several processes occur within a VIP latrine which impact on the rate at which sludge build up and the degradation processes. These could be categorized into two main processes i.e. non-biological processes and biological processes (Buckley *et al*, 2008). The non-biological processes within the pit (also referred to as physical processes) involve the accumulation of sludge within the pit, transport of solubilised materials and moisture within and out of the pit and the compaction of materials in the pit, while biological processes taking place within the pit involve the microbial degradation of the organic material resulting in the production of gases which are liberated via the vent pipe into the atmosphere and soluble components that infiltrate with the liquid contents of the pit into the surrounding soil (Franceys *et al*, 1992; Mara, 1984).

### **2.2.1 Non-Biological Processes/Physical Processes in Pit Latrines**

According to Buckley *et al*, (2008), the physical processes taking place in a pit are categorized into two which are: (i) accumulation of sludge in the pit; and (ii) hydraulic flow patterns of soluble components into and out of the pits via the walls and the base of the pit. However compaction of materials at the bottom of the pit as a result of faeces or new material added to the pit could also be described as a physical process taking place in the pit (Buckley *et al*, 2008). This may result in moisture being squeezed out of the pit sludge, breakdown of intact cells with time, and reduction in sludge volume within the pit latrine (Buckley *et al*, 2008; Cotton *et al*, 1995).

#### **2.2.1.1 Sludge Accumulation rates**

Ventilated improved pit latrines are meant to contain human faeces, urine and the type of anal cleansing material used by the households. According to Vinnerås (2002), an individual produces between 0.12–0.40 ℓ of fresh faeces and 0.6 -1.5 ℓ of urine per day. Averaged over a year, this amounts to 110 ℓ of faeces and 440 ℓ of urine per person per year: a total volume of 550 ℓ of excreta per person per year. It is expected that natural bacteria present in faeces and urine degrade the available organic material found in the materials deposited in the pit (Buckley *et al*, 2008).

Franceys *et al*, (1992) explained that the degradation of material deposited in the pit gradually reduces the volume and/or mass of the materials present in the pit, however, the number of people using the pit, the use of biocidal or oxidative chemicals to overcome odour liberated from the pits, and the deposition of rough papers, plastics, bottles and other non-biodegradable household refuse, can cause the rapid accumulation of solids in a pit. Still (2002), also reported that the disposal of household refuse into pit latrines contributed significantly to the rate of sludge accumulation, by as much as 10 to 20 % increase in the rate at which sludge accumulates in pit latrines.

According to WHO (2004), sludge accumulation rates in pit latrines do not only depend on these factors; climatic and socio-economic factors may also play a major role in the rate at which sludge accumulates in pit latrines and these differ from one country to another and even within the same country. Climatic conditions and also individual diet have a direct influence on the quantity and composition of faeces and urine produced. The type of diet of an individual affects the chemical and biological oxygen demand present in the faeces deposited into the pit latrine (WHO, 2004). The proportion of proteins and carbohydrates in each individual's diet might result in different degradation rates and thus affect the accumulation of sludge in a pit (WHO, 2004).

Thus, the rate at which sludge accumulates in a pit is influenced by the interaction of a number of factors. In addition to the factors mentioned above, the design of the pit and character of the biological processes within the pit affect the rate at which sludge will accumulate in the pit (Still, 2002). The findings on the determination of sludge accumulation rates in pit latrines from local and international experience is presented in **Table 2.1**.

**Table 2.1: Pit latrine filling rates (Still, 2002)**

Location	Age of Latrines	Number of Sites	Number of Visits	Avg. Pit Volume m <sup>3</sup>	Range of Filling Rates ℓ/ca/annum	Mean Filling Rate ℓ/ca/annum
Soshanguve	3 years	11	14 over 28 months	1.96	13.1 to 34.0	24.1
Bester's Camp	4 years	159	2 or 3 over 25 months	3.16	18.3 to 120.5	69.4
Mbila	5 years	11	1	2.83	10.0 to 33.2	18.5
Gabarone, Dar es Salaam	not stated	not stated	not stated	not stated	25 to 30	27.5 (implied)

Mara (1984) quotes values for the solid accumulation rate in pit latrines to be between 20 and 60 ℓ per person per year depending on the location of the water table. For dry pits (i.e. those above the water table), values of sludge accumulation rates quoted from Mara (1984) are typically between 30 and 60 ℓ per person per year and for wet pits (i.e. those penetrating the water table) values of solid accumulation rates are typically between 20 and 40 ℓ per person per year.

Franceys *et al*, (1992), recommended that it is necessary to determine pit latrine sludge accumulation rates for a particular location before designing new pit latrines and in situations where there is no available data for that location, the values presented in **Table 2.2** can be used as maximum values for designing a new pit latrine. These values were based on whether the pit sludge content was above or below the water table and the type of anal cleaning material used (either degradable or non degradable material).

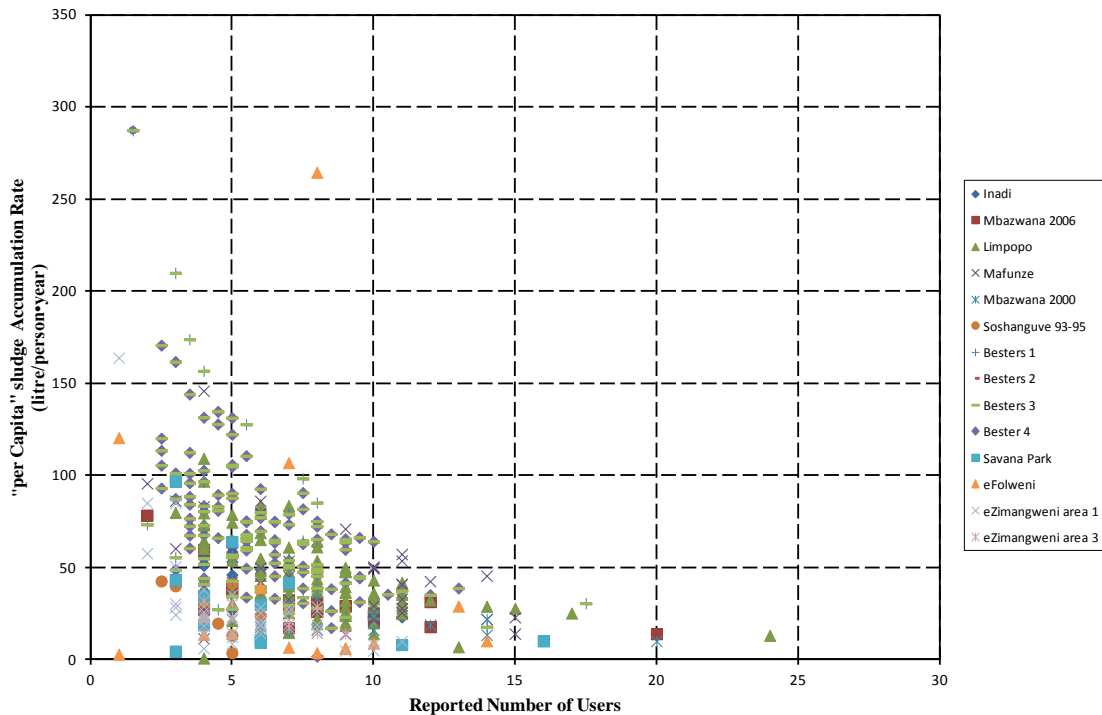
**Table 2.2: Proposed maximum sludge accumulation rates for VIP latrine design (Franceys *et al*, 1992)**

Conditions in the pit	Sludge Accumulation Rate (ℓ/person-year)
Wastes retained in water where degradable anal cleaning materials are used	40
Wastes retained in water where non- degradable anal cleaning materials are used	60
Wastes retained in dry conditions where degradable anal cleaning materials are used	60
Wastes retained in dry conditions where non- degradable anal cleaning materials are used	90

According to Norris (2000), the design criteria used in the determination of sludge build up in various on-site sanitation systems in South Africa were generally inappropriate because they were based largely on experience in other countries. The main objective of the study conducted by Norris (2000) was to establish the rate at which sludge builds up in various on-site sanitation systems under South African conditions. In this study, sludge levels in VIP latrines was measured by lowering a steel measuring tape which was attached to a steel weight into the pit and the vertical distance between the pedestal and sludge surface was measured. The change in the vertical distance was taken to be the change in sludge volume for each pit investigated. The findings of this study recommended that sludge accumulation rate of 25 ℓ/person-year can be used for VIP latrine design purposes in South Africa.

Still *et al* (2012) further explains that the prediction of pit emptying interval needs to take into consideration estimated sludge accumulation rates in pits and this could only be achieved if adequate knowledge of pit latrine age and pit volumes are known. **Figure 2.6** presents the amalgamated sludge accumulation rate data by Still *et al* 2012. The method in which the sludge accumulation rate data was obtained was not presented. However it appeared that sludge accumulation rates in pit latrines decrease with an increase in the number of users for the two studies. These authors suggested that this

result may have been influenced by householders possibly exaggerating the number of people in the house thinking that they might be provided with a second pit latrine or else that numbers of people using a particular pit latrine given by householders did not uniformly represent regular visitors..



**Figure 2.6: Observed sludge accumulation rates with reported number of users (Still *et al*, 2012).**

It was proposed that, for a pit emptying programme where the VIP latrine is to be emptied before the pit becomes unusable, an accumulation rate of 60  $\ell$ /person-year should be considered for planning the emptying programme. This is significantly higher than the value proposed by Norris (2000).

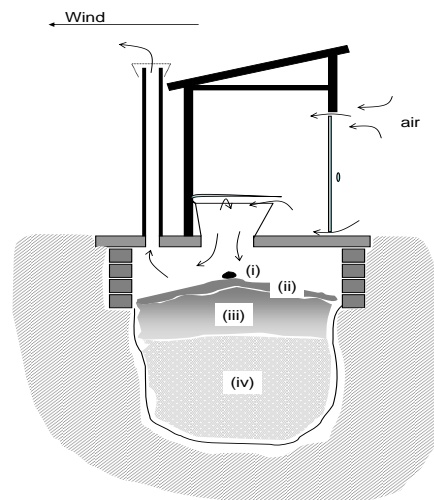
#### 2.2.1.2 Moisture content and movement of moisture within the pit

The decomposition of faeces, urine, anal cleansing material, latrine floor/pan cleaning and sometimes sullage tipped into the latrine contribute significantly to the amount of moisture found in pit latrines (Cotton *et al*, 1995). Buckley *et al*. (2008) also indicated that the addition of water by users of the pits or from rain caused as a result of damaged or poorly constructed superstructure may also contribute significantly to the moisture

present in the pit. For unsealed pits, the permeability of the soil and the location of the water table beneath the pit contribute to the inflow and outflow of liquids in the pit. Therefore movement of liquids in and out of the pit through the walls and beneath the pit depend on the construction of the pit and the hydrogeology of the pit location (Cotton *et al*, 1995; Franceys *et al*, 1992).

### 2.2.2 Biological Processes in Pit latrines

A survey of available literature suggests that anaerobic digestion is the predominant biological process taking place in pit latrines, although aerobic conditions might occur at the topmost layer of the heap in the pit latrine; the extent to which it takes place within the pit is not understood (Chaggu, 2004; Mara, 1984). According to the theory proposed by Buckley *et al* (2008), the faecal sludge portion within any pit latrine comprises of four theoretical categories as shown in **Figure 2.7**.



**Figure 2.7:** Diagram showing the different theoretical layers within a pit latrine. (Buckley *et al* 2008). Numbers refer to each layer within a pit.

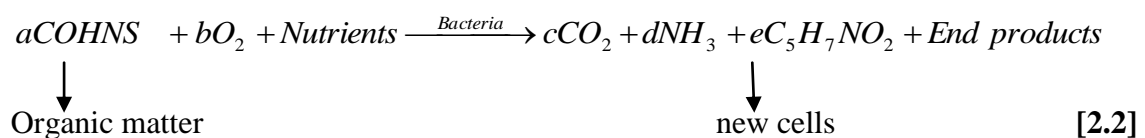
The first category (i) is the layer containing fresh faecal sludge in which readily biodegradable components are still present and in which rapid aerobic degradation is taking place, the second category (ii) is the layer in which aerobic degradation of hydrolysable organic material takes place at a rate limited by aerobic hydrolysis of complex organic molecules to simpler compounds; the third category (iii) is suggested

to be an anaerobic layer due to the occlusion of oxygen by covering material. Anaerobic degradation in this layer is controlled by the rate of anaerobic hydrolysis of complex organic molecules to simpler molecules; and finally the fourth category (iv) is the lowest and bottom layer of the pit, here the sludge component has attained a significant degree of stabilization and no further stabilization of organic material occurs within the remaining life span of the pit. According to this theory, much of the degradation process taking place within the pit is likely to be aerobic because the surface layer of the pit content is exposed to surrounding air. However, below the surface layer it is expected that anaerobic conditions would be established and become predominant because diffusion of air into the pit content and to the bottom of the pit is likely to be restricted (Buckley *et al*, 2008). The two digestion processes are further discussed in the following section.

#### 2.2.2.1 Aerobic Digestion

Previous studies conducted on VIP latrine sludge found roaches, insects, and maggots suggesting that there is adequate amount of oxygen for their survival (Buckley *et al*, 2008). Thus, at the air interface (top surface) of the pit, aerobic digestion and other processes might take place. However, the extent to which aerobic digestion occurs within the pit is not clearly understood. Aerobic digestion processes involve the biochemical breakdown of biodegradable organic material by microbes in the presence of sufficient oxygen resulting in an increase in temperature and production of carbon dioxide, water and cellular protoplasm (Gray *et al*, 1971). This process is carried out by wide range of microorganisms that are naturally occurring and the digestion process is far more rapid than anaerobic digestion processes (Henze *et al*, 1997). Metcalf and Eddy (2003) describe the aerobic conversion of organic matter by microorganisms in accordance with the stoichiometric equations shown below;

#### Oxidation and Synthesis

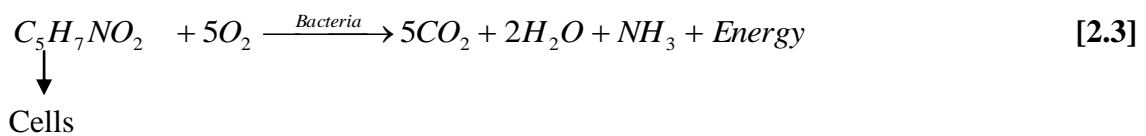




(Note that equation 2.2 is not stoichiometrically balanced as specific chemical composition of the organic substrate has not been specified)

Cellular matter (both that present in the organic matter and that arising from growth of new cells) eventually undergoes lysis and release of protoplasm and other degradable and non-degradable material, which may be used by other microorganisms for growth. This is often modelled as endogenous respiration, i.e. where cell matter is degraded with an associated consumption of oxygen (Metcalf and Eddy, 2003).

#### Endogenous Respiration

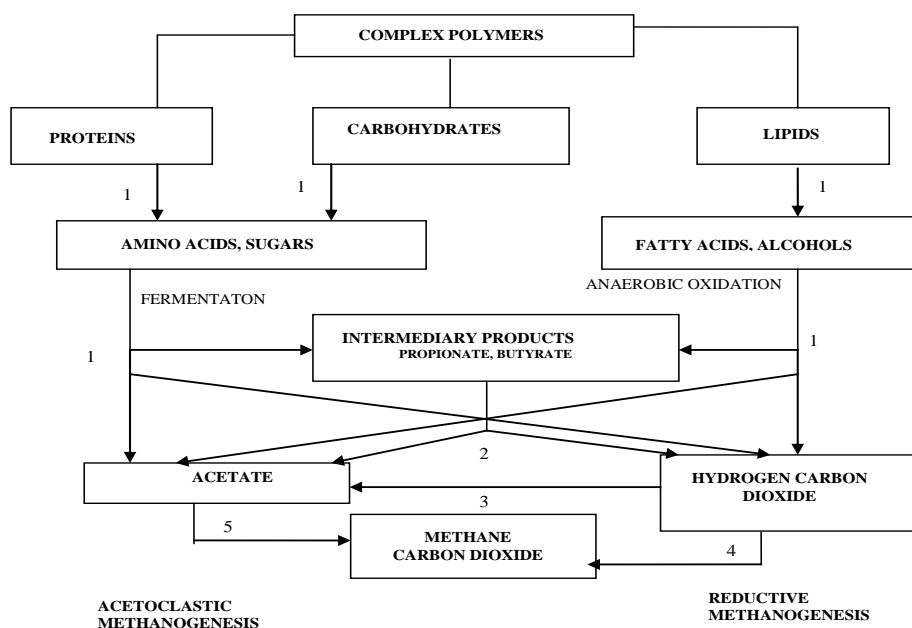


#### 2.2.2.2 Anaerobic Digestion

Anaerobic digestion involves the conversion or breakdown of organic matter by microbes in a molecular oxygen free environment. In pit latrines, faecal sludge is converted under anaerobic condition to produce carbon dioxide, methane and hydrogen sulphide gases which are released through the ventilation pipe, and soluble components which drain away with the moisture content of the pit latrine (Franceys *et al*, 1992; Mara, 1984). Anaerobic digestion of organic material is mediated by different groups of microbes which follow a series of stages. During anaerobic digestion processes, available and readily biodegradable organic materials are converted to gases and only a small fraction (typically 10%) is converted to new cell mass as a result of microbial growth (Speece, 1996). **Figure 2.8** shows how complex substrates are converted into simpler substrates and the type of microorganisms that facilitate each process.

The series of stages involved for complete anaerobic digestion of organic material can be grouped into four main steps (Seghezzi *et al*, 1998). The first step in the anaerobic digestion process is hydrolysis which involves the conversion of complex particulate matter into soluble substrates (Adrianus *et al*, 1994). It is a combination of extracellular, enzymatic processes in which a specific group of microorganisms produces enzymes used for hydrolysing complex particulate matter to produce smaller soluble substrates

that can be further degraded (Batstone *et al*, 2002). The second step, Acidogenesis involves fermentation of the soluble compounds produced during the hydrolysis stage which results in the production of simple organic compounds such as volatile fatty acids, alcohols, lactic acid, carbon dioxide, hydrogen, ammonia, and hydrogen sulphide gas (Adrianus *et al*, 1994; Anderson and Uyanik, 2003, McCarty, 1991). During this stage, organic compounds produced dissociate releasing H<sup>+</sup> ions into the liquid phase which result in an increase in the acidity of the process (Anderson and Uyanik 2003). This fermentation process is carried out by a diverse group of bacteria most of which are obligate anaerobes (Min *et al* 2005; Adrianus *et al*, 1994). The third step, Acetogenesis is the conversion of volatile fatty acid produced from the Acidogenesis stage into the final products (acetate, carbon dioxide, and hydrogen) for methane production (Adrianus *et al*, 1994; McInerney and Bryant, 1981). In the final step, Methanogenesis, methane is produced from acetate or from the reduction of carbon dioxide by hydrogen using the acetotrophic and hydrogenotrophic microbes respectively (Vom, 2010; Anderson and Uyanik, 2003; Adrianus *et al*, 1994).



- 1: Fermentative Bacteria
- 2: Hydrogen- Producing Acetogenic Bacteria
- 3: Hydrogen- Consuming Acetogenic Bacteria
- 4: Carbon Dioxide- Reducing Methanogens
- 5: Acetoclastic Bacteria

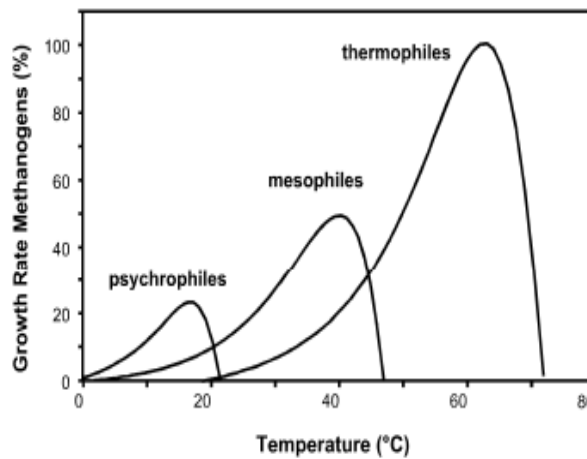
**Figure 2.8: Schematic Representation of Anaerobic processes indicating which Microorganism facilitates each conversion process (Speece, 1996).**

### 2.2.3 Factors Affecting Anaerobic Digestion Processes

There are various factors which can affect the growth and survival of microorganisms during the process of anaerobic digestion of organic materials. These factors can also slow down or speed up the rate at which anaerobic degradation take place. The main factors affecting anaerobic digestion processes are; Temperature, pH, presence of essential nutrients and absence of excessive concentrations of toxic compounds (O'Flaherty, 2006). **Section 2.2.3.1 to 2.2.3.5** describes these main factors.

#### 2.2.3.1 Temperature

According to Adrianus *et al*, 1994 and Speece, 1996, anaerobic digestion of organic waste depends to a great extent on temperature. The major temperature ranges that are normally defined in anaerobic digestion processes are psychrophilic (0 to 25°C), mesophilic (20 to 40°C) and thermophilic (45 to 75°C). This temperature range relative to the growth rate of methanogens is as shown in **Figure 2.9**. Maximum growth rates for mesophilic microbes are between 35°C and 40°C while thermophilic microbes operate at about 55°C during anaerobic digestion processes.



**Figure 2.9: Growth rate of psychrophilic, mesophilic and thermophilic Methanogens (Van *et al*, 1997)**

Henze *et al* (1997) stated that during anaerobic digestion processes, the conversion rate decreases by about 11% for every degree Celsius temperature decrease if anaerobic digestion processes take place below 30°C. This change in conversion rates during

anaerobic digestion processes with temperature can be described by a modified Arrhenius exponential equation expressed below:

$$\mu_{\max}(T) = \mu_{\max}(20^{\circ}\text{C})e^{\kappa(T-20)} \quad [2.4]$$

Each sub-process will have a different temperature coefficient ( $\kappa$ ).

Temperatures in pit latrines will vary between 15 and 30°C in most cases in South Africa depending on the ambient temperatures resulting in considerable differences in the rate of stabilization (Foxon *et al*, 2006).

#### 2.2.3.2 Moisture Content

The presence of moisture during anaerobic degradation processes has an influence on microbial activity. According to Williams (1998) in landfill degradation processes, moisture content below a minimum of 40% will reduce biological activity of microbes significantly. Methane production during anaerobic degradation processes in landfills is said to increase with increasing moisture (Buivid, 1980; Rees, 1980). Active methane production requires moisture content of 50 to 100 % of the dry weight of the waste body or 30 to 50 % of the wet weight of the waste body (Ham, 1979). In a study conducted by Lay *et al*, 1997 to investigate the influence of moisture content on the methanogenic activity in the anaerobic digestion of wastewater treatment plant sludge cake, it was documented that methanogenic activity dropped from 100 % at a moisture content of 96 % to 53 % of the maximum activity when the moisture content was reduced to 90 %. The main effect of moisture on anaerobic degradation process is that it facilitates the exchange of substrate nutrients, buffer, and dilution of the inhibitors, spreading of microorganisms in niche areas and also limiting oxygen transport from the atmosphere (Christensen *et al*, 1989).

#### 2.2.3.3 pH

During anaerobic digestion processes the value and stability of pH throughout the digestion process is an important factor to be considered especially during methanogenic activity, since methanogenic activity requires the pH to be maintained at

neutral values in order for the digestion process to proceed at an optimum rate (Adrianus *et al*, 1994). According to Batstone *et al*, 2002 and Henze *et al*, 1997 a pH value between 6.5 and 8 is generally considered suitable during the methanogenic stage of anaerobic digestion process.

#### 2.2.3.4 Nutrients

Nitrogen, phosphorus, sulphur, iron and other micro-nutrients which are required for microbial growth are the essential nutrients for anaerobic digestion processes. If the required nutrients are not sufficient or are not available during anaerobic digestion processes, this could inhibit the production of methane during the methanogenic stage (Schanbacher *et al*, 2005). These nutrients should be readily available in sufficient quantity in faecal material in order to supply the anaerobic microbial requirements for complete digestion of the faecal material (Buckley *et al*, 2008).

#### 2.2.3.5 Toxic Compounds

Several compounds apart from hydrogen ion concentration affect the rate of anaerobic digestion processes even at very low concentrations, such as heavy metals and chloro-organic compounds (Adrianus *et al*, 1994). The methane producing microbes are very sensitive to their environments. High concentrations of some compounds such as nitrogen, sodium, potassium may have inhibitory effects on the production of methane during the digestion process (Fricke *et al*, 2007). Any inhibitory effect experienced by methanogens during anaerobic digestion in conventional anaerobic digesters results in the accumulation of acid and failure of the digestion process (Henze *et al*, 1997).

### 2.3 COMPOSITION AND DISPOSAL OF VIP LATRINE SLUDGE

When VIP latrines become full, sludge content must be emptied or a new pit must be built. A number of issues need to be considered when planning to empty and dispose of VIP latrine sludge. Issues related to pit emptying have been discussed in section 2.1.2. Issues that need to be considered when planning for the disposal of exhumed pit latrine sludge include the composition of the pit sludge, the regulation that governs the

disposal of sludge and where the sludge can be disposed of and are discussed in this section.

The options available for the disposal of VIP latrine sludge are limited by their composition. The major sources of the sludge in any particular pit latrine, if appropriately used for its purpose should be only faeces, urine and anal cleansing materials. **Table 2.3** presents characteristics of faeces extracted from various publications.

**Table 2.3: Summary of reported Characteristics of faeces**

Parameter	Units	Palmquist (2003)	Chaggu (2004)	Lopez (2002)	Almeida (1999)	Nwaneri (2009)
Moisture	% of wet mass	86	66-85	81.8	79.2	78
Volatile solid	% gVS/gTS	-	-	84.4	-	84
Total COD	mg COD/g dry mass	364	253	1 450	1 380	1 130
Biodegradability	% mgCOD/mgCOD	-	-	80	-	74

It should be noted that not all these studies looked at fresh human faeces. This could be seen especially by the difference in the COD values between the first two and the last three references. The data by Palmquist and Jönsson (2003) was obtained from measured accumulated material in a urine diversion toilet system while Chaggu (2004) presents data compiled from a variety of sources. The last three references used fresh faeces in their analyses.

It has been observed in many of the VIP latrines investigated previously within and around the boundaries of eThekweni municipality that a large variety of materials in

addition to faeces such as newspaper, magazines, broken glass, bottles, rags, plastic bags, and a range of other household waste materials are found in the pit (Buckley *et al*, 2008; Still, 2002). It is therefore impossible to predict the material composition of any particular pit without physically observing what is in the pit or digging out the contents of the pit since many households make use of the pit for different purposes; either for their basic sanitation needs or for both their sanitation needs and discarding of solid refuse (Buckley *et al*, 2008; Still, 2002; Cotton *et al*, 1995; Franceys *et al*, 1992; Mara, 1984). **Figure 2.10** shows two pit latrines with different sludge composition based on different user habits.



(a) Q section Umlazi



(b) Mariannhill

**Figure 2.10: Typical content of pit latrines from two pits in different communities in eThekwin Municipality (Photo taken during field work, 2007)**

Typical characteristics of sludge exhumed from VIP latrines are presented in **Table 2.4**

**Table 2.4: Characteristics of VIP latrines sludge contents (Buckley *et al*, 2008)**

	Parameters	Units	Average	Min	Max	n	C of V
<b>Total</b>	COD	mg/g wet weight	105	46	199	21	45
		mg/g dry sample	445	71	987	17	58
	Moisture	% of wet sample	76	29	81	13	6
	Total Solids	% of wet sample	33	19	71	17	54
	Organic Solids	% of solids	36	6	62	17	48
	Inorganic Solids	% of solids	64	38	94	17	26
	Biodegradability	% Biodegradable	50	47	56	5	8
<b>Soluble</b>	COD	% of total COD	31	7	91	7	97
	Nitrate	mgN/g wet sample	0.028			<b>1</b>	

Based on the fact that a wide range of material can be found in a pit latrine and also the surrounding environmental conditions, it would be expected that there will be a considerable variation in the organic content, moisture content, non-biodegradable content and micro-organism population of different pits (Buckley *et al*, 2008). This could be observed by the significant variations in the values presented for all determinants as presented in **Table 2.4**.

Studies have shown that faecal sludge can contain high concentrations of excreted pathogens which include viruses, bacteria, protozoa and helminths (Jiménez 2009). In a study conducted by the Pollution Research Group University of KwaZulu-Natal in 2008 which investigated prevalence of helminths and protozoa in VIP latrine sludge, sludge samples from VIP latrines were collected from 120 households. It was found that out of the 120 households investigated:



- 10 % of samples had neither helminths, nor protozoa
- 60% had *Ascaris*
- 55% had *Giardia*
- 50% had *Trichuris*
- 21% had *Cryptosporidium*
- 11% had *Taenia*; and
- 60% had either *Cryptosporidium* or *Giardia*

In 2002, IWMI and SANDEC calculated the rates of pathogen die off in faecal sludge. It was found that the rates at which various pathogens die off are influenced by the ambient temperature, with more rapid die off in warmer climates. The rate for pathogen die off in faecal sludge is presented in **Table 2.5**.

**Table 2.5: Pathogen survival periods in faecal sludge (according to IWMI & SANDEC, 2002)**

Organism	Average survival time in wet faecal sludge at ambient temperature (days)	
	Temperate climate (10-15°C)	Tropical climate (20-30°C)
<b>VIRUSES</b>	<100 days	<20 days
<b>BACTERIA:</b>		
salmonellae	<100 days	<30 days
cholera	<30 days	<5 days
faecal coliforms	<150 days	<50 days
<b>PROTOZOA:</b>		
Amoebic cysts	<30 days	<15 days
<b>HELMINTHS:</b>		
Ascaris eggs	2-3 years	10-12 months
Tapeworm eggs	12 months	6 months

Thus, stringent regulations and control should be in place to guide any disposal options adopted for sludge exhumed from pit latrine. In South Africa, the disposal of exhumed sludge from pit latrines is subject to regulation and control by the South African

Department of Water Affairs in terms of the National Water Act (Act 36 of 1998) (DWAF, 1999) and the Environment Conservation Act (Act 73 of 1989). These acts and other acts or legislation as presented in the Guidelines for the Utilisation and Disposal of Wastewater Sludge Vol. 1, 2006 by Snyman and Herselman, is as shown in the box.

The use and disposal of sludge are influenced by, amongst others, the following Acts and guidelines:

- The National Water Act (Act 36 of 1998) (NWA)
- The Water Act (Act 54 of 1956) (WA)
- The Environment Conservation Act (Act 73 of 1989) (ECA)
- The Fertilisers, Farm Feeds, Agricultural Remedies and Stock Remedies Act (Act 36 of 1947)
- The Conservation of Agricultural Resources Act (Act 43 of 1983) (CARA)
- The National Health Act (Act 61 of 2003) (HA)
- The Water Services Act (Act 108 of 1997) (WSA)
- The National Environmental Management Act (Act 107 of 1998) (NEMA)
- Minimum Requirements: (Second Edition) 1998

This refers to the Waste Management Series published by Department of Water Affairs and Forestry, which establishes a reference framework of standards for waste management in South Africa in terms of Section 20 of the ECA. This trilogy consists of:

- Minimum Requirements for the Handling, Classification and Disposal of Hazardous Waste
- Minimum Requirements for Waste Disposal by Landfill
- Minimum Requirements for Water Monitoring at Waste Management Facilities
- Water Use Authorisation and Registration Management System (WARMS). This is a registration system used by DWAF for water uses

Source: Guidelines for the Utilisation and Disposal of Wastewater Sludge Vol. 1, 2006

The Department of Water Affairs and Forestry has previously classified sewage sludge based on its potential to cause odour nuisances, fly breeding and also the potential to transmit pathogenic organisms to man and his environment (Murphy, 1997). Sewage

sludge was classified into Type A,B, C and D. Sewage sludge which is unstable with high odour, fly nuisance potential as well as high content of pathogenic organisms was classified as Type A sludge and was followed in increasing order of stability by Type B, C, and D sludge. In this classification, sludge content from pit latrines was not specified but based on the unstable nature, high odour and fly nuisance as well as high content of pathogenic organisms, pit latrine sludge content could be said to fall under the classification of sludge Type A. This would have subjected sludge from pit latrines to very high restrictions in terms of use and disposal. The new classification system of sludge (Snyman and Herselman, 2006) has taken into account three aspects of the sludge; these are:

- Physical characteristics – pH, total solids, volatile solids.
- Chemical quality – nutrients, metals, organic pollutants.
- Microbiological quality – faecal coliforms, helminths ova.

This new system of classification of sludge is aligned to international trends and has resulted in a classification system with three classes for each of the three aspects of the sludge as presented in **Table 2.6**.

**Table 2.6: Classification System for Sludge in South Africa (Snyman and Herselman, 2006)**

<b>Microbiological class</b>	<b>A:Unrestricted use</b>	<b>B:General use</b>	<b>C:Limited use</b>
<b>Stability class</b>	<b>1:Stable</b>	<b>2:Partially stable</b>	<b>3:Unstable</b>
<b>Pollutant class</b>	<b>a:Minimal restriction</b>	<b>b:Moderate restriction</b>	<b>c:High restriction</b>

If a particular sludge is classified as A1a, this means that the sludge has low content of pathogenic organisms, is relatively stable and has low pollutant contamination and therefore has the least restrictions applied to its usage. A sludge which is heavily

contaminated with pathogens, unstable, and heavily contaminated with pollutants would be classified as C3c.

The utilization/ disposal option available for pit latrine sludge content is limited because of the fact that the sludge is highly contaminated with faecal coliforms and helminth ova as well as the unstable nature of the sludge. The options available for the disposal of pit latrine sludge are limited by the characteristics of the sludge found in pits. In many cases sludge from pit latrines usually exhibits lower moisture content than sewerage or septage. Thus available sludge treatment options for sewerage or septage (such as stabilization ponds, anaerobic digesters, and drying beds) are not suitable for the treatment of exhumed pit latrine sludge because of the high solids content (Heinss *et al*, 1998; Strauss *et al*, 2000). In South Africa the disposal of pit latrine sludge has become a massive problem for many municipalities, the existing options that have been proposed by the eThekweni Water and Sanitation Services (EWS) for pit latrines sludge disposal (DWAF, 2007) include:

- The discharge of sludge into main sewers
- The discharge of sludge into sea outfall
- Disposal into waste water treatment works
- Burial on site
- Transport to landfill site
- Deep row entrenchment of sludge for agroforestry
- Further dewatering and treatment/ processing to produce agricultural fertilizers

In the following sections, a further description of the proposed options for the disposal of VIP latrine sludge is discussed.

### 2.3.1 Disposal of pit sludge into wastewater treatment works

The disposal of pit latrine sludge into wastewater treatment works was one of the options proposed by eThekweni municipality for treatment of pit sludge. The eThekweni Municipality initially believed that sludge evacuated from pit latrines could either be discharged into main sewers or transported straight to wastewater treatment works without having significant impact on the treatment works since the volume of sludge evacuated from pit latrines is relatively small when compared with wastewater flows. However, in a pilot trial conducted in 2007, the operation of two wastewater treatment works in the municipality area was seriously affected by the addition of sludge emptied from 8 pits per day in which the volume of the contents of each pits was estimated to be at  $1.5\text{m}^3$  (Bakare *et al* 2008). **Figure 2.11** shows photographs of VIP sludge transportation and screening at the wastewater treatment works during this trial.

The result of adding pit sludge to the treatment works was solids overload that took several months to recover from, affecting the waste sludge capacity of the works and failure of the nitrifying ability of the treatment works which only recovered after the solids load had returned to normal. The study indicated that the disposal of one  $1.5\text{m}^3$  pit latrine into a wastewater treatment works is equivalent to the daily contribution of between 600 and 1 200 families and that the disposal of pit sludge into wastewater treatment works dramatically increases the load of slowly degradable chemical oxygen demand, solids and nitrogen to the treatment plant (Bakare *et al*, 2008). The pilot study concluded that, depending on the particular constraints at a given wastewater treatment plant, the impact of receiving VIP sludge will be equivalent to between 0.5 and 1 Ml of normal sewage per emptied pit.



(a) Transportation of sludge from Pit location to treatment works



(b) screening of sludge content at treatment works.

**Figure 2.11: Transportation of manually evacuated VIP sludge and screening of the sludge during the pilot trial conducted for the disposal of pit latrine sludge into treatment works at Tongaat Central Treatment Works (Bakare *et al* 2008)**

### 2.3.2 Onsite burial of pit latrine sludge

Burial of pit latrine sludge on the same site as the pit latrine has been proposed by eThekweni Municipality as a possible means of disposal; however, there was a concern that pathogens present in the sludge might have direct contact with the earth and could eventually find their way into surrounding water sources (EWS, 2004). The eThekweni municipality's Health Unit was not in full support of this option because there could be associated risks of this option to public health (DWAF, 2007).

### 2.3.3 Transport to landfill sites

Another option proposed by the eThekweni water and sanitation is the transportation of pit latrines sludge to landfill site. However, there are issues related to transportation of sludge to landfill sites, these issues include: cost, health risks and also the willingness of landfill operators to accept sludge evacuated from pit latrines (EWS, 2004). There is also a need to stabilize the sludge with lime according to the sludge disposal guidelines before disposal to landfill (EWS, 2004).

#### **2.3.4 Deep row entrenchment of sludge for Agroforestry**

No specific work has been carried out previously to investigate the benefit of direct deep row entrenchment of pit latrine sludge content. However, researchers at the University of Maryland pioneered the deep row entrenchment of wastewater treatment plant secondary sludge in the early 1980s as a result of an increase in the production of sludge estimated to exceed 1.2 million wet tons per annum, increasing cost of sludge disposal and reduced option for the disposal of sludge (Sikora *et al* 1982).

The deep row entrenchment technique for sludge disposal involves manual or Tractor Loader Backhoe (TLB) excavation of a trench. According to Kays *et al* (1999) in deep row entrenchment of secondary sludge from treatment works in Maryland trenches were dug to 200 m long, 600 mm wide and 1.2 to 1.5 m deep with row spacing of 2.4 to 3 m between centres. The depth of the trench varied depending on the sludge application rate proposed. They were filled with sludge to within 300 mm of the surface and then backfilled with the overburden heaped after which trees or other vegetation were usually planted in rows parallel to or on top of the trench. Kays *et al* (2007) reported that the variables to be considered for deep row entrenchment of sludge include trench dimensions, spacing, and method of filling (layered with soil or co-composted with vegetable matter), plant species, composition and density of vegetation and end purpose. There were usually no adverse effects on the surrounding groundwater reported by these studies but recycling of nutrients was reported as a benefit of entrenching wastewater treatment plant sludge and planting trees for commercial harvest. Additional benefits included erosion control and creation of wildlife habitat (Buswell, 2006). In 1995, 72 000 m<sup>3</sup> of composted wastewater treatment sludge was used to landscape the Sydney airport (Kelly, 2006).

This technique has also been used in North America and Australia therefore the application of wastewater treatment plant sludge in the plantation forest industries can be considered to be a well-known practice. Surface application of sludge in a study conducted in Australia contributed to 30 % increase in the growth rates of existing pine plantations, while incorporating into the soil prior to planting improved the height of the trees by almost 50 % after 5 years and also the diameter of the tree increased by 85 %

without affecting the density of the wood produced (Kelly, 2006). Surface application of sludge is usually associated with unpleasant odours, potential run off into streams and sudden increases in the amount of human and animal pathogens in surface water but studies have shown that deep row entrenchment of wastewater treatment plant sludge for agroforestry prevents the issues related to surface application of sludge (Sikora et al, 1982; Toffey *et al*, 2005).

### **2.3.5 Further dewatering and treatment/ processing to produce agricultural fertilizers**

In 2011, the latrine dehydration and pasteurization machine that enables sludge from pit latrines to be converted to nutrient rich soil conditioner was developed by the eThekweni Water and Sanitation department. According to Wilson and Harrison (2012) the machine allows for the separation of pit sludge from detritus contained in the sludge by forcing the mix through a screw compactor with lateral ports through which the sludge is extruded while the detritus is ejected at the end of the screw. The extruded sludge falls onto a continuous porous steel belt in a thin layer of open textured material. The steel belt conveys the material into the Parsep dryer where it is dried and pasteurized. **Figure 2.10** is product from the latrine dehydration and pasteurization machine.



**Figure 2.12: Dehydrated and Pasteurized Pit sludge for Agricultural fertilizer (Source: Wilson and Harrison, 2012)**



## 2.4 PIT LATRINE ADDITIVES

One of the options proposed for management of pit latrine sludge during pit operation is addition of pit latrine additives. Pit latrine additives may be chemical, microbial or enzymatic in nature. Manufacturers of various additives have indicated that the use of additives has the ability to reduce the volume of pit contents, flies and odour but fail to adequately describe the mechanisms in which these additives accomplish this said function.

The literature contains very little information on the efficacy of pit latrine additives. A study conducted for WRC by Taljaard *et al* (2003) attempted to evaluate the ability of different commercial microbial or microbial derived products to treat organic waste in pit latrines. The study involved both laboratory scale experiments and field trials. The laboratory scale trial involved comparing the different microbial or microbial derived products by their ability to digest organic material in small scale laboratory trials. The results obtained indicated that some of the products are able to significantly increase the rate of COD removal and TSS removal over those which naturally occur at the applied dosage.

Two of the products that showed effective COD and TSS removal in the laboratory scale experiment were used for the field trials which involved the treatment of pit latrine sludge content. The selected pits were treated with the products over 3 months and also the control pits were treated with same amount of water but without addition of the product. It was reported that there was a significant reduction of odour and flies especially from the treated pits.

The study concluded that the use of these microbial derived products for the degradation of organic waste in pit latrine is feasible (Taljaard *et al*, 2003). However Foxon *et al* 2009 proposed that the Taljaard study used application rates many times higher than prescribed application rates and therefore challenged the interpretation of the results.

In another study, Sugden (2006) investigated “*the potential of bio-additives to prolong the life of pit latrines and septic tanks in emergency situations*”, the study involved

investigating the efficacy of five bio-additives designed to reduce sludge volumes in pit latrines and septic tanks by enhancing the anaerobic digestion process taking place. Fresh pig faeces were used as a test material. Twenty five litre buckets were used to simulate pit latrine condition and also to facilitate measurement during the study. Holes were drilled at the base of the buckets and the bottom of each bucket was filled with 3 litres of alpine grit, to allow liquid to exit the buckets simulating the natural percolation of water through the soil. Each bucket was then placed in a 60 litre bucket to collect effluent and protect the inner buckets. Each 60 litre bucket was covered with a lid to minimise intrusion. Each of the 25 litre buckets was then filled with 10 litres of fresh pig faeces. Bio-additives were added according to manufacturers instruction with quantity adjusted to correspond with the small size experimental pits compared to the real pits.

Temperature, pH, sludge and effluent volume were monitored over 31 days subsequent to dosing with bio-additives. The volume of gas produced was estimated from the difference between volume decrease and effluent. Gas production was used as a proxy-indicator for the occurrence of methanogenesis, the final stage of anaerobic digestion.

The study concluded that all the four stages of anaerobic digestion took place in all the buckets but there was no evidence to show that the use of any of the bio-additives either enhanced or inhibited the anaerobic digestion process.

Buckley *et al* (2008) conducted a study to investigate the efficacy of commercial pit latrine additives on VIP latrine sludge content. The study undertook to perform reproducible laboratory scale experiments that would quantify the effect of commercial pit latrine additive products. The laboratory scale experiment involved collecting samples from the surface of the pit just beneath the pedestal. The dosing rate was scaled to the mass (or volume) of additive per surface area of the pit. The test was performed in 3 or 5 replicates. Two sets of controls were included; one to which there was no water or additive addition and the other to which only water was added.

The mass of samples was measured, immediately after filling and at intervals of approximately 3 days for between 27 and 46 days after the commencement of the trials. The COD, moisture content and total solids were determined for each sample at the

beginning and at the end of the experiment. The rate of mass loss, extent of moisture loss and extent of COD reduction was calculated.

The study found that:

- Pit latrine additives when used to treat the sludge contents in pits had no statistically significant effect on the rate of mass loss of pit sludge contents under either aerobic or anaerobic conditions.
- There was no obvious difference in the final moisture content and final COD in the surface of test units between treatments and controls in either of the trials although differences were recorded between the test units.

The study concluded that the use of commercial pit latrine additives to treat pit latrine sludge content was unable to accelerate biodegradation rate and mass loss in the test units.

In a preliminary field trial into the effect of pit latrine additives conducted as part of a wider study into processes in pit latrines (Buckley et al, 2008), inconclusive results were obtained due to the difficulty of obtaining representative measurements of any condition or property within the pit and the lack of control of the test site. The field study concluded that the use of simple height measurements does not provide accuracy in the measurement of the sludge volume reduction in a pit latrine. It was proposed that photographs of the shape of the pile could be used to determine the shape and depth of the pit surface using image analysis software.

## **2.5 GAP ANALYSIS**

A review of key aspects related to the design and operation of VIP latrines, problems associated with VIP latrines, processes occurring in pit latrines, disposal options available and/or proposed for full pits and pit latrine additives was undertaken. Two main issues related to the provision of pit latrines as accepted sanitation system were identified in the literature reviewed as; (i) the difficulty of getting accumulated sludge out of the pit, and (ii) the problem associated with suitable disposal routes once sludge

from pits are exhumed. Most of the available literature deals with issues related to the civil and mechanical construction of the pit latrine and superstructure.

In this section, an analysis of the literature reviewed is presented and a synthesis of existing information is used to identify the technological gaps/problems highlighted in the literature towards achieving the ultimate goal of this current study.

### ***Physical processes in pit latrines***

The physical processes occurring in pit latrine as reviewed are said to be accumulation of sludge in pit latrines, hydraulic flow of liquid containing soluble components within the pit and compaction of material in the pit. In general the rate at which sludge accumulates in a pit latrine as a function of local conditions is not well known. However the literature states clearly that it is necessary to determine sludge accumulation rates because planning and putting necessary strategies in place for proper management of pits requires the ability to determine how quickly the pits fill up and the how often the pit will require emptying. The literature reviewed also stated that it is necessary to determine pit latrine sludge accumulation rates for a particular location, since factors such as climatic and geographic conditions which affect the rate of sludge accumulation differs from place to place and individual diet also differs from person to person. The literature reviewed showed a wide range of per capita sludge accumulation rate data from as low as 10 ℓ per person per year to as high as 120 ℓ per person per year, however it was observed that the method of measuring sludge accumulation rate in pit latrines differed between individual studies presented in the literature. This suggests that apart from other factors that can influence the rate of sludge accumulation in pits, the method used for measuring pit fill rates could have an influence on the reported data.

From the literature reviewed, it is obvious that there is an understanding that in pit latrines, sludge reduction processes do occur but studies only report on the obtained sludge accumulation rates. There is a suggestion as presented in **Table 2.2** that sludge accumulation rate appears to be lower in wet pits than in dry pits. Hence if wet pits have apparently lower rates of sludge accumulation than dry pits, the mechanism of sludge reduction cannot be attributed to sludge compaction and densification through moisture

loss, since the wet pit is likely to have higher average moisture content than the freshly deposited faeces. This suggests that the mechanisms of biological sludge stabilization could also have an effect on the rate at which sludge accumulates in pit latrines. A concept identified by Still *et al* (2010) was that there is an apparent decrease in sludge accumulation rate with number of users. However, the reason was unclear and only attributed to householders exaggerating the number of people using a particular pit latrine. Thus based on the literature review conducted on aspects related to sludge accumulation rate, there are unclear issues related to what are the reliable ways of measuring sludge accumulation rate in pit latrines, why is there an apparent decrease in sludge accumulation rate with number of users, and what the role of stabilization processes on the accumulation rate is. This present study aims to fill the highlighted gaps by investigating methods for measuring pit filling rate, their influence on reported sludge accumulation rates and a mass balance approach to infer the role of stabilization processes on sludge accumulation rates.

### ***Mechanisms of sludge stabilization in pit latrines***

The mechanism of sludge stabilization in pit latrines has not been given much consideration in the literature reviewed. The few available literature reviewed have indicated that below the surface of the pit sludge, the predominant mechanism of biological process taking place if indeed any occurs is anaerobic (Mara, 1984; Still, 2002; Chaggu, 2004) although aerobic degradation processes may occur at the sludge surface in the pit. However the extent to which this process occurs and how it affects the stabilization of pit sludge is not well understood. The Buckley *et al* (2008) theory on the processes occurring in a pit attempts to provide an understanding of the mechanism of stabilization in pit latrines, however this has not been systemically verified but has been suggested from results obtained in various studies conducted on the nature of sludge in pit latrines. Thus based on the literature reviewed, there are no definite answers as to how the mechanism of sludge stabilization affects the nature of sludge in pit latrines. Therefore in order to provide better understanding of the mechanism of sludge stabilization processes in pit latrines, this present study investigates the characteristics of pit latrine sludge from various location within the pit. This would provide a better understanding of the nature of sludge in pit latrine and what happens to

the sludge within the pit over time. This directly would provide an insight as to what the mechanism of sludge stabilization in pit latrine would be and what the nature of sludge dug out of a pit will be.

### ***Pit latrine sludge disposal***

In the literature reviewed, the disposal of pit sludge into wastewater treatment works, onsite burial of pit latrine sludge, transport of exhumed pit latrine sludge to landfill sites for disposal, deep row entrenchment of pit latrine sludge for agroforestry and further dewatering and treatment/ processing to produce agricultural fertilizers were the possible options proposed for the disposal of exhumed pit latrine sludge. It was reported in the literature reviewed that the disposal of pit latrine sludge into wastewater treatment works can rapidly lead to the overloading of the treatment works capacity. The critical constraints on the wastewater treatment works was not the volume of sludge added but the solid loads and nitrogen loads, but most specifically, much of the solids added are not degradable therefore, there is no benefit from a treatment perspective. Essentially a concentrated solid waste is converted to a dilute solid problem with increased difficulty in solids removal and a significantly negative impact on the wastewater treatment plant's ability to fulfil its normal function. Similar problems will also be encountered if pit sludge is disposed in sewer and can also lead to the blockage of the sewer. The literature also reported that there are perceived concerns that pathogens present in pit latrine sludge might have direct contact with the earth and could eventually find their way into surrounding water sources when pit latrine sludge is buried onsite. Also there are various perceptions that exhumed pit latrine sludge from pit latrines are not stabilized and if pit sludge were to be transported and disposed of to landfill, the sludge would have to be stabilized with lime before disposal at landfill sites.

South Africa's new Guidelines for the Utilisation and Disposal of Wastewater Sludge (Snyman and Herselman, 2006) encourage sludge management options that include recovering energy, recycling the nutrients or synthesising commercial products from the sludge. Disposal without beneficiation is to be considered the last resort. Thus from the options proposed for the disposal of exhumed pit latrine sludge, deep row entrenchment

of pit sludge and further dewatering and treatment/ processing to produce agricultural fertilizers are the two options in line with the new sludge guidelines. However from the literature reviewed there is only information on the applicability of deep row entrenchment of wastewater treatment sludge. It is not known whether deep row entrenchment of pit sludge would be an applicable disposal option because the difference between wastewater treatment sludge and pit latrine sludge is not known and the nutrient dynamics for pit sludge is also not known. Thus as a case study, the present study assesses the feasibility of deep row entrenchment of pit latrine sludge for agroforestry as an option for the disposal of pit sludge. It is evident from the literature reviewed that any disposal/treatment option for pit latrine sludge should depend on the inherent ability of the disposal/treatment option to accept the load of solids and organic material in the VIP sludge, the residual biodegradability of the VIP sludge, and the health risks associated with handling the sludge.

#### ***Pit latrine additives***

The literature reviewed on the efficacy of pit latrine additives reports contradictory results in terms of whether pit latrine additives have any effect on the pit sludge. The Buckley *et al* (2008) theory of the general processes occurring in pit latrine suggests that the mechanism of degradation that occurs in a pit is as a result of natural microbes already present in the pit that aerobically degrade a significant portion of biodegradable material while it resides on the surface of the pit. According to Buckley *et al* (2008) when the surface material is covered over with new materials deposited into the pit, the rate of degradation drops due to a reduction in the availability of oxygen to micro-organisms. Thereafter, a slow process of anaerobic digestion results in further degradation of remaining biodegradable material. After a certain residence time in the pit, it is expected that virtually all biodegradable material has been converted to biogas or non-degradable solids, and what remains in the lower levels of the pit contents is biologically inert solids. Thus the addition of pit latrine additives to pit content would be similar to that of a naturally occurring micro-organism. This is because once new material is added to the pit after the addition of the pit additives, limitation of oxygen supply would result in the activity of the micro-organisms present in the added pit additives to drop dramatically. Despite the findings of the study conducted by Buckley

*et al* (2008) which systematically demonstrated no significant difference in pit sludge volumes and the proposed Buckley *et al* (2008) theory of processes in pit latrine that explains what happens in pits and therefore why pit latrine additives are unlikely to have any significant effect on pit sludge, there are still claims being made that the addition of pit additives do result in reduced sludge accumulation rates. A conclusion was drawn from the pit latrine additive field study conducted by Buckley *et al* (2008) that the method in which sludge reduction in pits is measured using single distance measurement does not accurately quantify the measurement of sludge volume in pit latrines.

Faced with these controversies and lack of adequate knowledge, this suggests that there is a need for a field study where the influence of measurement technique on the measured sludge reduction is investigated. Thus, the present study investigates the efficacy of pit additives on sludge content in pit latrines through a laboratory and a field trial. In the present study the field trial was conducted taking into consideration the influence of the measurement technique on the measured sludge accumulation rate and/or sludge volumes.



### 3 RESEARCH METHODOLOGICAL APPROACH

---

---

The purpose of this research was to provide scientific support for decision making for proper management of sludge accumulated in ventilated improved pit latrines before and when they become full under typical South African conditions. A critical analysis of the available literature presented in **Chapter 2** has provided information towards the gaps in knowledge and the need for the present research. The information obtained has lead to the identification of the research objectives. Thus the objectives of this research are:

- To investigate sludge accumulation rates in pit latrines and a mass balance approach to infer the role of stabilization processes on sludge accumulation rates.
- To investigate the mechanism of sludge stabilization in pit latrines and how these mechanisms affect the nature of sludge in pit latrines.
- To determine whether deep row entrenchment of pit latrine sludge for agroforestry has any significant benefits and does not have adverse effects on the environment.
- To investigate the efficacy of pit latrine additives through laboratory and field trials and determine the influence of measurement techniques on measured sludge accumulation rates and/ sludge volumes.

Thus, in order to fulfil the research goal and objectives, the following hypotheses are proposed:

- Significant biological stabilization occurs in a pit latrine with time, such that the disposal/treatment options for material removed from the pit depends on the inherent ability of the chosen option to accept the load of solids and organic

material in the VIP sludge, the residual biodegradability of the VIP sludge, and the health risks.

- VIP latrine sludge can be used in deep row entrenchment for agroforestry since the sludge contains nutrients that are available to plants, and that the sludge is sufficiently stable that it does not cause a negative environmental impact, and
- That in situ treatment of VIP latrine sludge using pit additives had no significant effect on the rate of mass loss or volume loss of pit latrine sludge content.

This chapter therefore defines and justifies the methodological approach adopted for the realization and assessment of the research objectives and hypotheses. **Chapter 3** is divided into three sections. The first section is essentially a description of the study area. The second section deals with the different research methods adopted and the third section describes the laboratory techniques used for pit sludge analysis. The detailed laboratory analytical methods are presented in **Appendix B**.

### **3.1 DESCRIPTION OF STUDY AREA**

The research work was conducted within the boundaries of eThekweni Municipality which is situated in the province of KwaZulu-Natal in South Africa. eThekweni Municipality is the local authority for the city of Durban. It is the third largest municipality in the country and is located on the eastern seaboard of the country incorporating Umkomaas in the south, Tongaat in the north and ends at Cato Ridge in the west. The population of eThekweni Municipality is estimated at about 3 million people and covers an area of approximately 2 297 square kilometres. The climate is subtropical with mild to cool winters, and warm summers with elevated humidity, but without frost. eThekweni Municipality has an annual rainfall of approximately 1,000 millimetres and the average annual temperature is 21°C.

eThekweni Water and Sanitation are responsible for the provision of sanitation services in Durban. In eThekweni Municipality alone, a total number of over 100,000 pit latrines can be found within the municipality's boundaries however only about 60 000 of this number are actually ventilated improved pit latrines (EWS, 2011). The ventilated

improved pit latrines found in eThekweni Municipality are lined single-pits and include the four necessities of a VIP: a pit 1.5 m deep (or deeper), a foundation and cover slab, a superstructure and a vent pipe with a fly screen (Mara 1984). eThekweni Municipality provided an excellent base to conduct the research work presented in this thesis. This is because at the commencement of the research work quite a number of VIP latrines found within the vicinity of the municipality had reached or was reaching the end of their service life, in that they were completely full and the municipality were actively involved in the process of emptying the pit. Thus collection of sludge samples from the investigated pits was relatively easy. The communities in which sludge samples were collected were very similar; however the main difference between communities visited appeared to be proximity to the coast. Communities closer to the coast consist of mostly sandy soils which were well drained while inland communities had a higher proportion of clay in the soil which has the ability of retaining more water. These communities are mainly in the Northern area of eThekweni Municipality.

### **3.2 RESEARCH METHODS**

The methodological approach adopted in this research is aimed at providing an understanding of the mechanisms of sludge stabilization and the nature of sludge in pit latrines that will facilitates proper management of pit latrines during their operation and when the pit becomes full. Three hypotheses have been proposed which are aimed at providing the required information towards the realization of the overall goal of the research presented in this thesis. The first hypothesis proposed is concerned with providing information on mechanism of sludge stabilization and nature of sludge in pit latrines while the second and third hypotheses are test cases which are concerned with providing information on managements of pit sludge before and once exhumed from the pit.

Thus, the following section defines and justifies the methodological approach adopted for the realization and assessments of each of the proposed hypotheses.

### 3.2.1 Methodological approach for hypothesis 1

The first hypothesis proposed was that “*significant biological stabilization occurs in a pit latrine with time, such that the disposal/treatment options depends on the inherent ability of the chosen option to accept the load of solids and organic material in the VIP sludge, the residual biodegradability of the VIP sludge, and the health risks*”.

Thus in order to test this hypothesis, two different approaches was used. The first approach involved conducting a study on the rate at which sludge accumulates in VIP latrines and the role of stabilization processes on the measured sludge accumulation rate. Through the determination of sludge accumulation rate in pit latrines, the extent of biological degradation of materials in the pit can be estimated from the estimated amount of material added (faeces, urine and other added materials) to the pit as presented in **Chapter 2 (Section 2.3.1.1)** and the obtained sludge accumulation rate.

Sludge accumulation rate from randomly selected VIP latrines from a community within eThekweni Municipality was investigated. The determination of sludge accumulation rate in pit latrines requires an adequate knowledge of the number of people using the pit from when the pit was built or when the pit was last emptied, the number of years in which the pit has been in use since construction or last emptying and adequate measurement of the volume of sludge in the pit latrine. In order to obtain data on the number of users, a questionnaire was developed and administered to each household of the selected VIP latrines. The questionnaire used is presented in **Appendix A**. The survey was conducted anonymously and all participants were allowed to check the completed questionnaire answer sheet for anonymity. Measurement of sludge volume in each of the selected VIP latrines was estimated by subtracting the amount of headspace above the pit contents from the total pit volume. The headspace volume measurements were obtained using Infrared Laser distance measurements from the pedestal to the pit contents. All ethical issues were strictly adhered to and an ethical clearance was obtained from the Humanities and Social Science Research Ethics Committee to conduct the study. A copy of the Ethical clearance certificate is presented in **Appendix A**.

The role of stabilization processes on sludge accumulation rate in pit latrines was also investigated through a laboratory scale experiment which assesses the long term effect of aerobic and anaerobic conditions on sludge degradation. The laboratory experiment was designed to quantify the cumulative mass loss for a series of pit sludge jar tests at different moisture content over a long time. Sludge samples from the surface layer of a pit latrine were collected and the moisture content was determined. A representative aliquot of known mass from the collected pit latrine sludge sample was placed in twenty honey jars. The honey jars were 300 ml in size with screw tops. These jars were separated into four groups which had the moisture content raised from 78 % to 91 % by adding a calculated amount of water using **Equation 3.1**.

$$\% = \frac{gH_2O_{initial} + mH_2O_{added}}{gSample + mH_2O_{added}} \quad [3.1]$$

$$gH_2O_{initial} = \text{Initial moisture content of pit sludge} \times g \text{ Sample}$$

For each moisture level, five replicates were prepared and the twenty jars were kept in a slightly humidified fume cupboard and incubated for 230 days. Additional five honey jars was filled with known amount of water to serve as the controls, this was done in order to be able to quantify any moisture loss which might be due to evaporation from each of the test unit. The initial mass of all jars containing the sludge samples at different moisture level was recorded after which the mass of each jar was measured on a weekly basis throughout the duration of the experiment. It was expected that the rate of mass loss would decrease with increasing moisture content because in sludge samples with higher moisture content a free liquid surface existed and therefore the predominant digestion taking place was anaerobic digestion which is a slower process compared to aerobic digestion process. However if anaerobic digestion has a lower residual net biomass production than aerobic digestion, then the net effect of more anaerobic conditions should be a smaller residual mass after an extended stabilisation period than for aerobic digestion; thus it was proposed that the final cumulative mass loss from high moisture level samples should be greater than for lower moisture level samples. The findings of these investigations are presented in **Chapter 4**.

The second approach involved characterization of pit latrines sludge. Sludge samples were collected from randomly selected pit latrines at four different depths and the samples subjected to a series of analyses. This was done to establish better understanding of sludge composition in pit latrines and what happens to sludge within the pit over time in terms of biological stabilization. Samples were taken at different depths of the sludge pile during the pit emptying, collected in plastic bags, which were individually packed into sealable plastic containers, which were then placed in a large refuse bag to maintain three levels of containment of the sample and to limit sample exposure to air. The samples were transported to the laboratory and stored in the cold room at 4°C before laboratory characterization was undertaken. The time between sampling and placing in the cold room was less than 3 hours and analyses were performed within 2 days of sampling. All pits sampled were full and still in use.

The samples were analyzed for moisture content, total and volatile solids, chemical oxygen demand, and aerobic biodegradability according to Standard methods (APHA, 1998) where applicable and where no appropriate method was published, adaptations of existing methods were used or entirely new methods were developed. A brief description of each method presenting the significance of the method is given in **Section 3.3**. A detailed description of the analytical methods for each parameter analyzed is presented in **Appendix B**. **Chapter 5** presents the findings of this study.

### **3.2.2 Methodological approach for hypothesis 2**

The second hypothesis proposed was that *“VIP latrine sludge can be used in deep row entrenchment for agroforestry since the sludge contains nutrients that are available to plants, and that the sludge is sufficiently stable that it does not cause a negative environmental impact”*. Two different approaches were used to test this hypothesis. The first approach dealt with investigating changes in the characteristics of VIP latrine sludge buried in trenches. Sludge exhumed from pit latrines as part of the eThekwini Water and Sanitation Services (EWS) pit emptying programme was delivered to the entrenchment site in bins and buried in trenches. The procedure for the entrenchment of VIP latrine sludge involved both manual and TLB (Tractor-Loader-Backhoe) excavation of trenches 200 m long, 600 mm wide and 1.2 to 1.5 m deep, with rows

spaced 3 m between centres. The trenches were filled with VIP latrine sludge to within 300 mm of the surface and then backfilled with the overburden heaped on top of the trench. Trees were then planted in rows parallel to the trenches. Excavation of trenches and burial of sludge in trenches commenced in October 2008 until January 2010. **Figure 3.1** shows images taken during excavation and sludge burial in trenches.

Monitoring of VIP latrine sludge buried in trenches has two components. Firstly, fresh VIP latrine sludge samples were collected during the delivery of sludge to the burial site so as to give initial characteristics of the sludge before entrenchment. During the emptying of sludge content from the VIP latrines, it is expected that there would be substantial mixing of pit contents, both from different locations in the pit and from different pits and thus the material that arrives at the entrenchment site is expected to exhibit characteristics that are similar to the global averages for pit sludge, and with a lower variance than at source because of this mixing. Thirty samples were collected over a period of six weeks in order to assess the variability in the VIP latrine sludge that arrived at the entrenchment site.

The second component involved exhuming sludge from the trenches and performing laboratory characterization of the exhumed sludge in order to determine the sludge characteristics. Sampling and analysis was performed at specified intervals of time (1 year and 1.5 years) after the entrenchment of the VIP latrine sludge. Sludge samples from the trenches were exhumed using a soil auger. For each of the time intervals, twenty five sludge samples were collected at identified point across the trenches. This was done in order to ascertain that the sludge samples collected at different time intervals were approximately from the same point across the trenches. The purpose of this part of the study was therefore to identify whether there was a significant change in average sludge characteristics of exhumed sludge from the trenches with time and also if further stabilization of the sludge occurs in the trenches than at the bottom layer of a pit latrine. Thus by monitoring changes in sludge characteristics, the benefits and suitability of deep row entrenchment of pit sludge as a disposal option can be identified. The benefits on the growth of trees planted near the entrenched pit sludge were investigated as a parallel study by Taylor (2012).

The techniques used for the characterization of samples of freshly delivered and exhumed sludge involved a number of biological/physical/chemical analyses which include moisture content, solids (total and volatile solids), chemical oxygen demand (COD), aerobic biodegradability, Total Kjeldahl Nitrogen (TKN) and phosphorus. Standard Methods (APHA, 1998) were used to analyse the collected sludge samples where applicable and where no appropriate method was published, adaptations of existing methods were used or entirely new methods were developed.



**Figure 3.1: Excavation and Sludge burial in Trenches at the Umlazi Site**

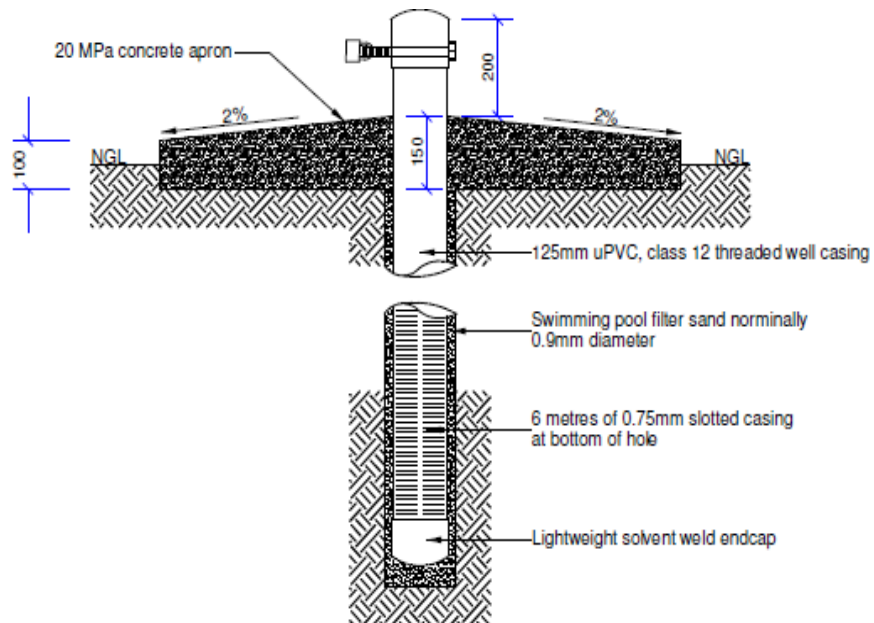
The second approach used in testing this hypothesis involved monitoring the effect of VIP latrine sludge entrenchment on the surrounding groundwater. Five evenly spaced groundwater monitoring boreholes were dug (by eThekweni Municipality Water and Sanitation) at the entrenchment site in the direction of the hydraulic gradient to monitor any potential migration of pollutant and pathogens into the groundwater. Their respective location is shown in **Figure 3.2**.





**Figure 3.2: Location of boreholes at the umlazi E-pond entrenchment site**

The boreholes were dug between the trench where VIP latrine sludge was buried and a river. The distance from the trenches to the boreholes was 55 metres while the distance from the trenches to river flowing behind the boreholes was 129 metres. The monitoring boreholes were drilled to 15 metre depth using a 165 mm bit. The cross section of the monitoring borehole design is presented in **Figure 3.3**.



**Figure 3.3: Groundwater monitoring borehole detail**

On a regular basis groundwater samples were collected from each of the five monitoring boreholes and laboratory analysis were performed on collected water samples in order to identify and quantify any migration of pollutants or changes in the surrounding groundwater as a result of the sludge entrenchment activities. The collection of groundwater samples from the monitoring boreholes at the entrenchment site followed four steps; field sampling equipment preparation, measuring of water level in boreholes, purging the boreholes and collecting and delivering the water samples to the eThekweni Municipality central laboratory for analysis. These four steps follow the Standard Groundwater sampling procedures described by Weaver *et al*, 2007. A detailed description of the groundwater sampling techniques is presented in **Appendix C**.

The identified parameters of concern in groundwater as a result of VIP latrine sludge burial in trenches are pathogens, nitrates, sodium, chloride and phosphate. These are the standard parameters of interest for assessing groundwater contamination because they are potentially transportable with groundwater movement. Analysis of water samples from the monitoring boreholes were performed from November 2008 to February 2011 and samples were analysed for chloride, COD, conductivity, sodium, ammonia, nitrate and nitrite, dissolved oxygen, pH and orthophosphate as well as *T. coli*, *E. coli* and total organisms. The details of the parameters chosen are presented in **Appendix C** of this thesis. All analyses on the groundwater samples were performed at the eThekweni Water and Sanitation service laboratory according to standard methods (APHA, 1998).

Monitoring changes in the characteristics of sludge buried in trenches with time and changes in the surrounding groundwater provides information that could be used to assess whether there is any evidence of environmental pollution as a result of deep row entrenchment of pit latrine sludge associated with agroforestry. The findings of this study are discussed in **Chapter 6**.

### 3.2.3 Methodological approach for hypothesis 3

The third hypothesis proposed was that “*That in situ treatment of VIP latrine sludge using pit additives had no significant effect on the rate of mass loss or volume loss of pit latrine contents*”. Sludge accumulation rate in pit latrines have two components; mass accumulation rate, and any possible change in volume accumulation rate. It is therefore important to investigate the influence of pit additives on mass accumulation rate as well as on volume accumulation rate. Thus two sets of trials was conducted; in the first, a laboratory trial was conducted to investigate the effect of pit additive on rate of mass loss from batch tests of freshly collected pit sludge samples using the Foxon *et al* (2009) methodological approach. Sludge samples for the laboratory trials were collected from the surface layer of the pit since pit additives are usually added or only have contact with sludge at the surface of the pit. In the second trial conducted, the same set of additives was added directly to the sludge in randomly selected pit latrines within a community. The volume accumulation rate was measured using simple height measurement and stereographic imaging for more accurate volume calculation.

It is expected that the outcome of these two trials would demonstrate whether the addition of additives to pit sludge have any effect on the rate at which sludge accumulates in pit latrines, thereby allowing the proposed hypothesis to be supported or refuted. However, if the application of pit latrine additives does influence stabilisation or accumulation rates in pit latrines, it is expected that the magnitude of the influence will differ between different pits, even if the measurement technique is accurate. This is due to the fact that a number of factors (such as number of users, presence of macro-invertebrates, rubbish deposited, temperature, availability of oxygen within the pit, moisture content etc) which influence the biological activity within the pit differ from pit to pit.

Commercially available pit latrine additives which have been used in various studies were listed and suppliers were contacted. Four out of the numerous suppliers contacted responded and supplied additives for the trials. Two products were selected because only these two suppliers are willing to participate and provide the quantity of additives required to conduct the study. For the laboratory trials representative samples of sludge

content from a pit latrine were collected from the surface of the pit beneath the pit pedestal through the back plate using a long shovel and hand fork. Samples were collected in plastic bags and placed in buckets which were tightly sealed to limit the exposure of collected sludge samples to air. This was done in order to limit the biological oxidation of collected sludge samples and also to ensure that sludge samples collected from the pit latrines do not substantially differ from the sludge in the pit. Often when the samples were transported to the laboratory, the trials commenced immediately but if the trials were not commencing immediately, collected sludge samples were stored in the cold room at 4°C. Sludge samples collected from the surface of the pit latrine were thoroughly mixed in order to obtain homogeneity of sludge content in each treatment and replicates. After thoroughly mixing the sludge sample, it was then divided into sub-samples of known mass (approximately 300 g each) and then placed in 300 ml screw-top honey jars. The mass of the honey jar was measured before and after being filled with the mixed pit latrine sludge to quantify the mass. The experiment was divided into 4 different treatments. Two treatments each, used a different commercial additive product; one reference treatment added water only to each sample of sludge, while the remaining reference treatment had no water or additive addition.

For the additive treatments, pit additive treatment rate was determined as mass (or volume) of additive per surface area of the pit [ $\text{g}/\text{m}^2$ ] based on the manufacturers recommended dosage, and the same dosing rate was applied to the smaller surface area of the honey jars according to **Equation 3.3**.

$$dose[g] = \frac{\text{recommended dose}[g] \times \text{surface area of honey jar } [m^2]}{\text{surface area of pit latrine } [m^2]} \quad [3.4]$$

It should be noted that the surface area of a pit varies with pit design. Thus an average value of 1.2  $\text{m}^2$  was used in this calculation. The calculated recommended dosage for each additive was then added to the prepared sludge samples for the additive treatment placed in the honey jars. For additive A, each honey jar containing a known mass of mixed VIP latrine sludge was dosed with 0.4 g of additive mixed with 10 ml of water. The second treatment consisted of another set of honey jar containing a known mass of

representative VIP latrine sludge that was dose with 0.02 g of additive B mixed with 10 ml of water. For each set of additive trials, five replicates were performed.

The reference treatment in which neither water nor additive was added to the sludge content in the honey jars served as a control in order to be able to quantify the uncontrolled effect of natural degradation and dehydration of pit latrine sludge. Five replicates were also performed. For water referenced jars, the same amount of water was used in the water reference units as for diluting the additives in the test units. The water reference units were included as part of the reference treatment to be able to quantify the effects of dilution and water transport on the laboratory trials in the absence of additives, that is to separate the effect of adding water from the effect of adding additives, i.e. 10 ml/jar. The weight of all the honey jars used for the treatments were carefully measured before being placed into storage boxes under a fume hood. All the lids of the storage boxes were closed with lids to reduce the heat and mass transfer coefficients associated with rapid air movement over the surface of the test units but 10 mm holes were drilled to the sides of the boxes so that diffusion of oxygen to the surface of the test units was not hindered. In each of the storage boxes, two or more open honey jars containing water were also added to maintain the humidity in the storage box, thereby reducing the effect of dehydration on the mass of each test treatment.

The honey jars were incubated for 30 days at approximately constant temperature in a fume cupboard and the mass of each jar was recorded over time. These data were used to determine the rate of mass loss from each jar as a result of biological activity in the jar. Mass loss due to dehydration may also have occurred, but was limited by maintaining a high relative humidity in the fume cupboard and thus reducing the driving force for evaporation. The mass loss data was used to determine the rate of mass loss from each sample for each measurement period. The rate of mass loss was calculated as the change in mass of honey jar content over defined periods of time for each honey jar and expressed in terms of g mass loss per day per jar.

The argument that is usually presented by many of the manufacturers and suppliers of pit latrine additives is that laboratory trials do not really represent the true conditions

that could be found in pit latrines, specifically because fresh material is constantly added to pit latrine while the laboratory trials has a batch sample that is only added once. This point is arguable because of the fact that any observed mass loss rate in the laboratory trials is not a direct representation of the overall mass loss rate in a pit but rather of a sample collected from the pit, whereas the field trials takes into account the net effect of the additives on the overall sludge volume or mass in a pit. However, by conducting both laboratory and field trials, it would be possible to identify whether there is any acceleration of mass or volume stabilization as a result of additive addition, and whether the effect is on the amount of sludge (i.e. biodegradation) or on the sludge density (e.g. compaction).

Thirty pit latrines which were still in use were selected from a community within eThekweni municipality. The major challenge faced was that majority of the available pit latrines within the community and around eThekweni municipality were completely full or recently emptied. Of those that had not been recently emptied (within the previous 6 months), the sludge level in the pits were still very low. Therefore there were a limited number of pits available within a manageable radius that could be effectively used in this study. From the 30 pits selected for this study, two sets of 8 pits were treated with Additive A and B respectively and two sets of 7 pits were used as water reference and control sets respectively. Owners of the pit latrines used for this study were only informed that the University and the municipality were embarking on a project to investigate how the accumulated sludge in their pit can be reduced without emptying the pit through the addition of pit additives. However, the product name and the method were not given to the any of the residents.

According to the two additive suppliers, the sludge content in the pit latrine should be adequately wet and if it is known that any chemical or substances has been added to the sludge in the pits, significant amounts of water need to be added before the treatment commences. Therefore, the 16 pits that were to be treated with Additive A and B were flushed with 20 litres of water so as to neutralize the effect of whatever substances/chemicals that may have been added previously to the sludge content in any of the pits. The water addition also served to flatten the pit contents at the start of the trial.

The remaining fourteen pit latrines out of the selected thirty pit latrines were used as the reference and control experiments. Since the additive suppliers indicated that the additives should be added with water to the sludge contents in the pit latrines, the selected pits use for the reference experiment (i.e. only water added to sludge content in the selected pit latrines) aimed to isolate the effect of adding water to sludge contents in pit latrines on the accumulation rates of sludge within the pit latrine. Ten litres of water was added to each of the selected seven reference pit latrines on a weekly basis while the remaining seven pit latrines (the control) were not subjected to any additive or water addition. All these four types of treatment were randomly allocated to the selected 30 pit latrines on a geographical basis to reduce the probability that any differences could be attributed to geographical differences. The field trials were carried out over a period of six months and measurements of the sludge present in all the pits were taken initially before the commencement of the treatment after initial flushing with 20 litres of water and repeated after 3 months and at the end of the 6 months field trials in order to be able to determine any significant changes that might have occurred.

Two measurement techniques were used; the first approach measured the distance between the pedestal and the pit surface at three different locations within an area of approximately 0.06 m<sup>2</sup> using an infrared laser distance measure. These measurements were averaged so as to give an indication of the distance between the top of the sludge heap and the pedestal. The difference in sludge heap height was calculated as an indication of the rate of reduction of sludge content in the various VIP latrines. The second approach used in taking measurement during the field trials involved the use of a stereographic imaging technique to map the surface of the pit latrine sludge contents to provide a basis for the calculation of the rate of volume change in pit latrines. The findings into the investigation of the efficacy of pit latrine additives on pit sludge are discussed in **Chapter 7**.

### **3.3 LABORATORY CHARACTERIZATION TECHNIQUES**

The laboratory characterization performed on the collected samples involved a number of chemical and biological analyses which include:

- Moisture content
- Solids characterization (Total and Volatile)
- Chemical oxygen demand (COD) and
- Aerobic biodegradability tests.
- TKN
- Phosphorus

Standard methods (APHA, 1998) were used to analyse the sludge samples where applicable and where no appropriate method was published, adaptations of existing methods were used or entirely new methods were developed. A brief description of each method presenting the significance of each method is given in the following sections. A detailed description of each method is presented in **Appendix B**.

### **3.3.1 Moisture Content Analysis**

The moisture content of all the samples collected was determined by drying to constant weight at 105°C in an oven according to the Standard methods (APHA, 1998). The moisture content is equated to the mass loss on drying for the sample. The analysis for the moisture content in each of the samples was carried out for comparison with the sample biodegradability. Each sample was analyzed in triplicate.

### **3.3.2 Solids Characterizations**

Total solids and Volatile solids measurements were carried out on each sample collected from the pit latrines by drying to constant weight at 105°C and then igniting at 550°C according to the Standard methods (APHA, 1998).

The total solid analysis was carried out as an intermediate step in determining the amount of organic solids (volatile solids) and is the fraction of the original sample that remains after drying at 105°C and is reported as the amount of dry solid per mass of wet sample. It is often useful to present the results of other analyses (e.g. COD) on a dry basis in order to eliminate variation in the COD of the samples caused by the dilution effect of different sample moisture contents. The volatile solids are equated to the



fraction of the total solids lost on ignition at 550 °C and serves as a measure of the organic (oxidizable) solids present in each sample analyzed.

### **3.3.3 Chemical Oxygen Demand**

Chemical Oxygen Demand (COD) is the amount of oxygen required to oxidize the organic matter in a sample. It is measured by the oxidation of the representative sample by potassium dichromate in an acid solution producing carbon dioxide, water and ammonia. The value of chemical oxygen demand is always higher than biochemical oxygen demand because many organic substances can be oxidized chemically but are recalcitrant to biological oxidation. Since COD is a conserved species and the analysis for COD is fairly quick and reproducible, and in the absence of BOD apparatus in the laboratory, COD was preferred for the measurement of the oxidizable organic matter present in the sludge sample. The open reflux method for particulate samples was used to carry out the COD analysis according to standard methods (APHA, 1998).

### **3.3.4 Aerobic Biodegradability**

Aerobic biodegradability tests were carried out in order to obtain estimates of the relative biodegradability (g biodegradable COD/gCOD) of each sample. The method used was developed within the project and was based on an adaptation from existing Standard methods. The principle of the method is that vigorous aeration of sludge samples for an extended period (8 days) will result in biological oxidation of all the organic material in the sludge sample that is inherently biologically oxidizable. Thus the difference in COD content before and after aeration is the biodegradable COD of the sample. The detail of this method is given in **Appendix B**.

### **3.3.5 Nitrogen and Phosphorus**

Total Kjeldahl nitrogen (TKN) is used for many years to determine the concentration of nitrogen in various materials (Scarf, 1988). TKN measurement is widely used to determine organic bound nitrogen compounds. The procedure for TKN involves a simple digestion, distillation and titration method. In the presence of sulphuric acid,

potassium sulphate and a copper catalyst, nitrogen, free ammonia, amino nitrogen and ammonium-nitrogen are converted to ammonium sulphate. Samples were also analyzed for phosphorus using Standard Methods.

## 4 SLUDGE ACCUMULATION RATE IN VIP LATRINES

---

---

This chapter discusses the findings on the investigation conducted to determine the sludge accumulation rate in VIP latrines and the role of digestion processes (aerobic and anaerobic) on sludge accumulation rate in VIP latrines.

Several factors affecting the rate at which sludge accumulates in a pit latrine have been identified in **Chapter 2**. There are also several difficulties with the determination of sludge accumulation rate in pit latrines, which are usually reported in units of volume accumulating per person per year, since these depend on accurate measurements of changes in volume of pit sludge and number of users with time. Accurate measurement to quantify the volume of sludge in the pit latrine is often very difficult. This is because the sludge surface in pit latrines usually has an irregular shape, is not level and does not maintain the same shape over time.

In instances where the accumulation rate is determined during an emptying exercise, it is very difficult to accurately determine the volume of sludge removed from the pit by counting the number of bins of sludge removed because they are not generally filled to the same level. If the pit had been previously emptied, there is no way of determining whether some sludge remained and therefore how much of the sludge removed at a subsequent pit emptying had accumulated in the intervening period. Also from a health and safety perspective, the measuring techniques adopted might be potentially hazardous. It is also necessary to have reliable information on the number of pit users. This number cannot be easily defined because this information depends on the numbers provided by the household which may not give a true picture of the people using the pit latrine. However, the number of people using a pit latrine is likely to be a major factor that affects the rate at which sludge accumulates in a pit. This also contributes to the type of biological process that would predominate in the pit because if there are a large number of people using a particular pit latrine compared to a pit where fewer numbers of people make use of the pit, materials at the surface of the pit would be covered much more quickly. Thus the residence time in which fresh materials deposited in the pit

comes in contact with atmospheric air is reduced. This could favour the rapid establishment of anaerobic conditions within a pit. Apart from this, the amount of moisture present or ingress of ground water into the pit could also influence the type of biological process taking place and thus influence the rate at which sludge accumulates in pit latrines (**Table 2.4**). Adequate knowledge of how long the pit has been in use since it was built or previously emptied also affects accurate measurement of sludge accumulation rate in pit latrines.

Despite all these difficulties, an understanding of the rate at which sludge accumulates in pit latrine is important in the context of this study, because, the obtained sludge accumulation rate can be used to estimate the extent of sludge stabilization in the pit by comparison between the obtained sludge accumulation rate data and estimated amount of material that is deposited in the pit per person.

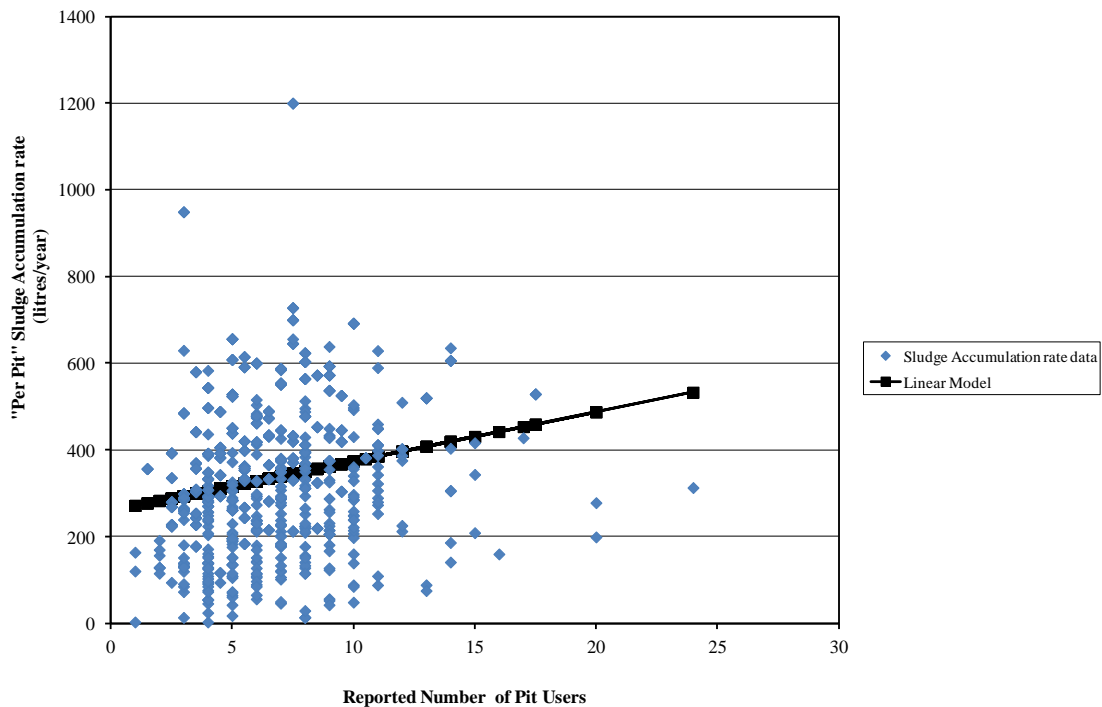
The rationale and methodology for the sludge accumulation rate study is presented in **Section 3.2.1** and consists of;

- Direct observation of sludge accumulation rates in the field; and
- Laboratory investigation into the effect of moisture content and aerobic/anaerobic conditions on pit sludge stabilization rates

#### **4.1 OBSERVED SLUDGE ACCUMULATION RATE**

In **Section 2.2.1.1**, Sludge accumulation rate data presented by Still *et al*, (2012) suggested that the per capita sludge accumulation rate ( $\ell$ / person.year) in pit latrines decreases with increasing number of pit users. If this observation is correct, this may have an impact on the design of pit latrines. An understanding of the mechanism that could lead to the cause of this observation may provide ways in which it could be manipulated to design pit latrines that take longer to fill or where pit sludge stabilize at a faster rate. However, the amalgamated sludge accumulation rate data by Still *et al*, (2012) were a data set that has been constructed from many historical studies. In many cases, the details of the data collection are not known, including how the sludge accumulation rate in pit latrines was measured and how the information on number of

pit users was collected. Therefore it is not known whether different data subsets are comparable, and whether the data is reliable. Thus in order to test if there is any validity to the observation presented by the amalgamated data (Still *et al*, 2012); a linear model was fitted to the amalgamated sludge accumulation rate data on a per pit basis ( $\ell/\text{year}$ ). **Figure 4.1** presents the amalgamated sludge accumulation rate data in  $\ell/\text{year}$  as a function of number of pit users fitted with a linear model.



**Figure 4.1:** Amalgamated sludge accumulation rate data in  $\ell/\text{year}$  as a function of number of pit users fitted with a linear model.

An examination of the data shows that some of the points are clearly not accurate. It is very unlikely that a pit latrine with few users would exhibit a filling rate of over 1000  $\ell/\text{year}$ . In **Figure 4.1** it is observed that the data exist in a cloud around the linear model fitted to the data, suggesting that the correlation between the sludge accumulation rate data and the number of pit users is extremely weak. A Pearson correlation test performed indicated that the Pearson correlation coefficient has a value of 0.203, this value is not significant at the  $p = 0.05$  level. This implies that the sludge accumulation data and the number of pit users are not correlated. Thus there is no

evidence that the per pit sludge accumulation rate is dependent on the number of pit users.

Therefore the fact that the data does not show a strong correlation suggests that either the relationship between the number of users and sludge accumulation rate is not strong, or that the data are not reliable. There must be a relationship between per pit sludge accumulation rate and the number of pit users; sludge accumulation rate should increase with number of pit users. This suggests that there is a strong possibility that the data are not reliable as an entire set. Therefore, there is some value in conducting a very controlled study to measure sludge accumulation rate where the data is defensible.

In this study, sludge accumulation rates were calculated from the estimated volume of sludge in a pit, the time period since construction or the last emptying and the reported number of users of the pit in the intervening period. Measurement of sludge volume in each VIP latrines investigated was estimated by subtracting the amount of head space above the pit contents from the total pit volume. The head space volume measurements were obtained using infrared laser measurements from the pedestal to the pit contents. Three out of the thirty pits selected were emptied completely. This was done in order to accurately measure the pit dimensions. The obtained pit dimension was used to determine the volume of a full pit. Since all three pits emptied had approximately the same dimensions and from the information gathered from the administered questionnaire (that all VIP latrines within the community were constructed in the same year, 1992 and by the same contractor) it was assumed that the remaining 27 pits that were not emptied would be of the same dimensions. It was observed that the three emptied pit consists of a cylindrical pit with a rectangular section between the foundation bricks and the slab, however sludge did not fill the rectangular section. The construction of the pits may be seen in **Figure 4.2**.

The infrared laser distance measuring device was used to measure the vertical distance from the pedestal top down to the sludge surface in the pits. Three measurements (P1, P2&P3) were taken as shown in **Figure 4.2**. The reading for each of the three measurements was corrected to exclude the distance from the pedestal down to the surface of the cylindrical rings in order to obtain the actual sludge height in each pit

investigated. After corrections have been made, the three measurements were averaged and recorded to be the corrected vertical distance  $h_s$  measured from the pedestal to the sludge surface in each pit investigated. The average value of these three measurements gives as good an approximation of the height of sludge in the pit as any other possible construction; however the error associated with this assumption would depend on the shape of the pit contents surface.

The height of sludge in the pit was therefore the difference between the measured total pit depth  $h_f$  when emptied and the corrected average vertical distance  $h_s$  measured from the pedestal to the sludge surface using an infrared laser distance measure. Thus, the volume of sludge in the VIP latrine at the time in which measurement was taken was calculated using **Equation 4.1**.

$$V_s = (h_f - h_s) \cdot A \quad [4.1]$$

Where,

$h_f$  Is the measured total pit depth

$h_s$  Is the corrected average vertical distance measured from the pedestal to the sludge surface in the pit at the time of measurement and

$A$  is the cross sectional (surface) area of the pit.

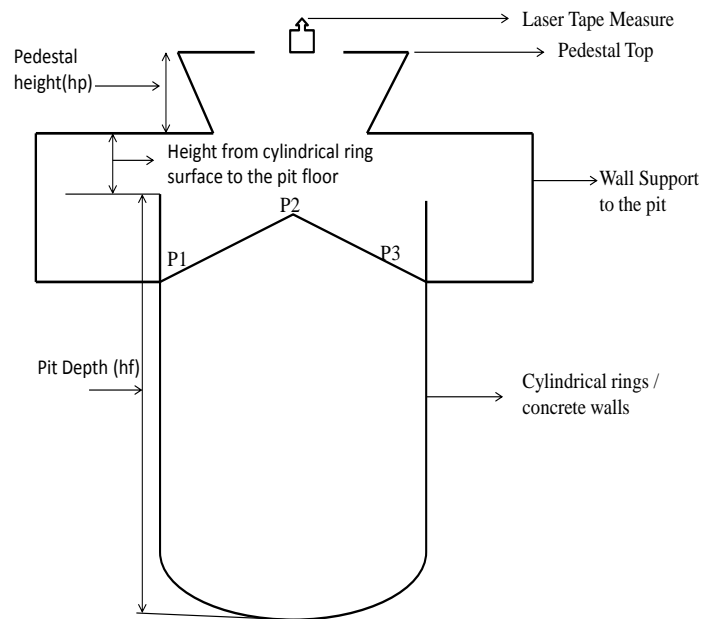
The sludge accumulation rate in each pit investigated was then calculated from **Equation 2.1** presented in **Chapter 2**.

This calculation implies that the sludge volume in the pit was equal to the volume of sludge if the surface was completely levelled that would fill the pit to a height equal to the average of the three measured points. This does not take into account the actual shape of the heap of sludge and so there is an inherent error in the calculation. The amount of error is a function of the pit shape which could not be recorded by this method. Therefore, the error in the measurement must be less than half of the empty pit volume between the lowest and highest measurement recorded by the infrared laser distance measure as presented in **Equation 4.2**.

$$\frac{1}{2} \times A((Max(P1, P2, P3) - Min(P1, P2, P3))) \quad [4.2]$$

Where

A is the cross sectional (surface) area of the pit



**Figure 4.2: Schematic diagram of pit latrine construction for the 30 pits investigated in the accumulation rate study. The location of the points used for measuring the pit sludge height is shown as P1, P2 and P3.**

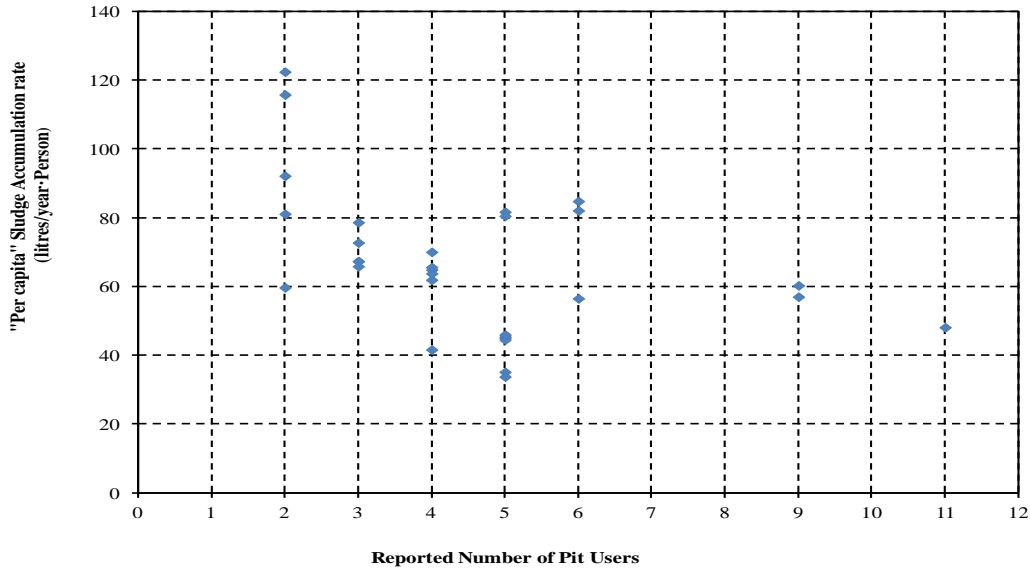
The questionnaire survey showed that the average number of pit users within the community was 5 and all the VIP latrines investigated were last emptied 3 years ago.

All the pits investigated were all similar and sludge accumulation in them was measured the same way. The number of pits investigated, 30, provides a sufficiently large number of data points to test if (i) the per pit sludge accumulation rate does increase with number of pit users, (ii) the per capita sludge accumulation rate does decrease with the number of pit users or, (iii) if there is a relationship between per pit sludge accumulation rate and the number of users.

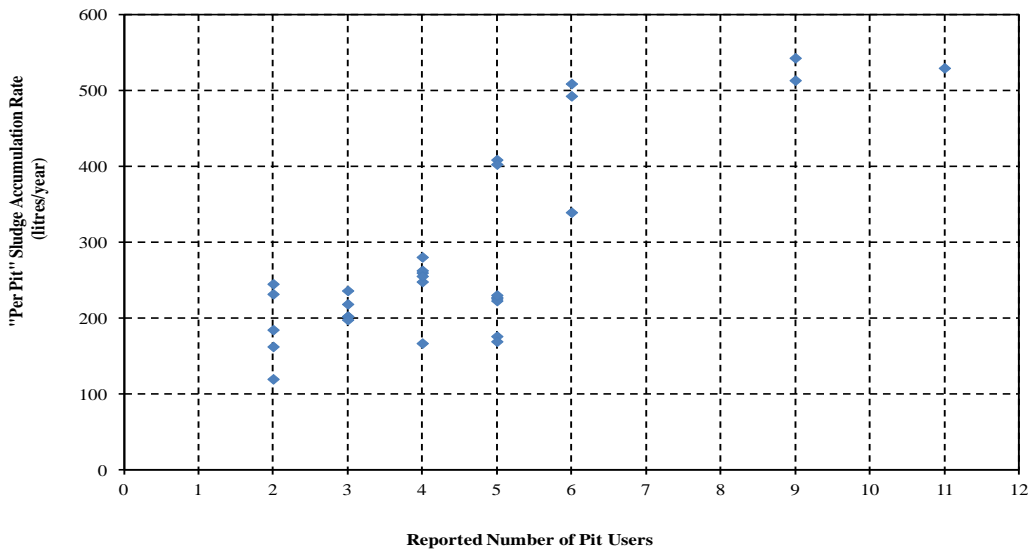
The sludge accumulation rate data obtained in this study are presented in **Figure 4.3**. The results are plotted as sludge accumulation rate  $\ell$ / person.year (per capita) as a



function of number of users and sludge accumulation rate  $\ell$ /year (per pit) as a function of number of users. This method of presenting the data shows the apparent effect of the number of pit latrine users on sludge accumulation rate in pit latrines.



(a)

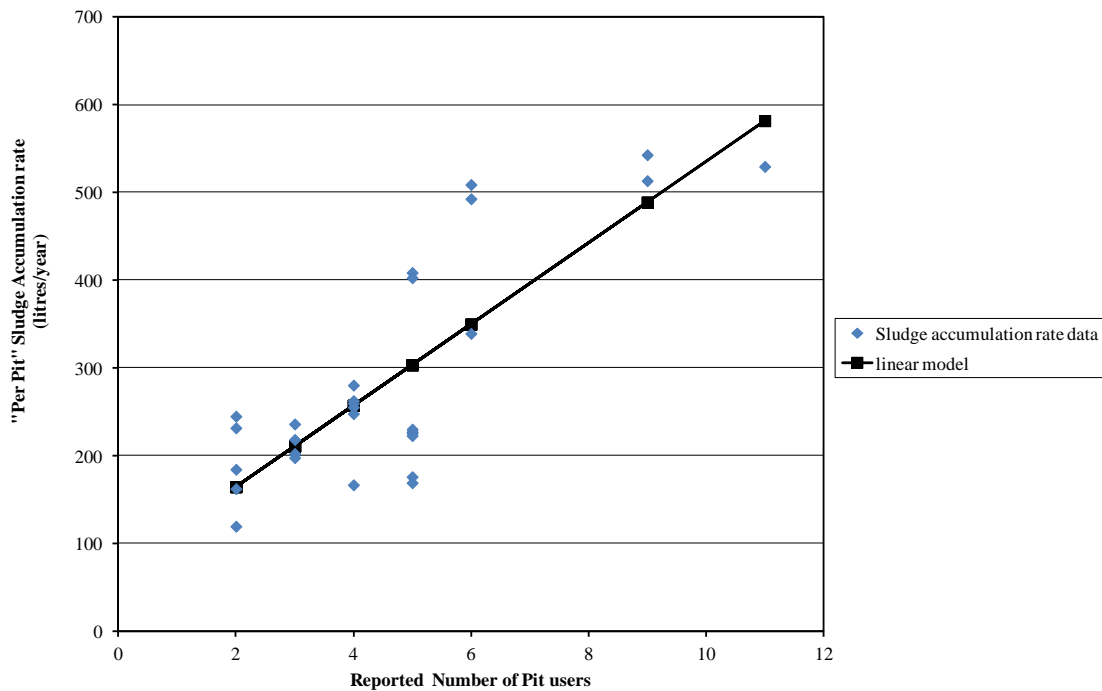


(b)

**Figure 4.3: Scatter plot for observed sludge accumulation rate with number of users.**

In **Figure 4.3 (a)** sludge accumulation rate data in  $\ell$ /person·year are presented. It was observed that sludge accumulation rate in VIP latrines (on a per person per year basis) decreases with an increase in the reported number of pit users, a result similar to the study conducted by Still *et al* (2012). This suggests that there is statistically significant

relationship between sludge accumulation rates in pit latrines and reported number of pit users. However, in order to test the validity of this observation, sludge accumulation rate data on a per pit basis as a function of number of pit users was fitted with a linear model. **Figure 4.4** presents the plot of the linear model fitted to sludge accumulation rate data on a per pit basis as a function of number of pit users.



**Figure 4.4: Sludge accumulation rate data in  $\ell$ /year as a function of number of pit users fitted with a linear model.**

It is evident in **Figure 4.4**, that there is a strong relationship between the linear model and the sludge accumulation rate data. A Pearson correlation test performed indicated that the Pearson correlation coefficient has a value of 0.808 suggesting a strong relationship between per pit sludge accumulation rate and the number of users. Although this data set is smaller compared to the Still *et al*, 2012 data set, the consistency of the data is probably higher since it was collected at one time using one set of data gathering methods. It is however limited by containing only data from one type of pit construction in one community. Sludge accumulation rate data obtained in this study supports the statements that per pit sludge accumulation rate does increase with number of pit users and also that there is a relationship between per pit sludge

accumulation rate and the number of users. Therefore to verify whether per capita sludge accumulation rate data decreases with number of pit users, a Pearson correlation test was performed on the per capita sludge accumulation rate data presented in **Figure 4.3(a)**. The Pearson correlation test performed indicated that the Pearson correlation coefficient has a value of -0.437 suggesting that there is a moderate, but not strong correlation. However, if 3 extreme points are excluded, (all with only 2 reported users, an unlikely sludge accumulation rate value) the correlation coefficient drops to -0.251 which is unreliably weak. However, this analysis does not really prove or disprove anything, but suggests that there is no strong statistical evidence (at  $p=0.05$ ) that the per capita filling rate decreases significantly with reported number of pit users.

Thus by comparing the analysis performed for both the sludge accumulation rate data obtained in this study with the amalgamated sludge accumulation rate data collated from the Still *et al*, (2012), there is an indication that suggests that the apparent decrease in per capita sludge accumulation rate with increasing reported number of pit users is such that when per pit filling rate (approximately constant property) is divided by reported number of users (increasing property), the result is a decreasing number or that reported number of pit users does not reflect the average use patterns of pit users. Therefore on the basis of this analysis, the influence of number of pit users on a per capita sludge accumulation rate is not something that should be considered in future designs of pit latrines. This is because it is difficult to predict what average number of users a pit will have, thus sludge accumulation rate on a per pit basis would be a more design factor in that when new pits are to be constructed, an estimate of the number of users can easily be made from available historical data of existing pit users. Irrespective of the number of pit users, Sludge accumulation rate data obtained in this study were between 120  $\ell$ /year and 550  $\ell$ /year with an average of  $282 \pm 46$   $\ell$ /year for the thirty pits investigated. This was calculated as average sludge accumulation rate in  $\ell$ /year  $\pm$  95 % confidence interval on the mean. For the purposes of comparison with published literature values, for an average of 5 reported users in the household investigated, this converts to a per capita sludge accumulation rate of 56  $\ell$ /person·year which is within the range presented in **Table 2.1**.

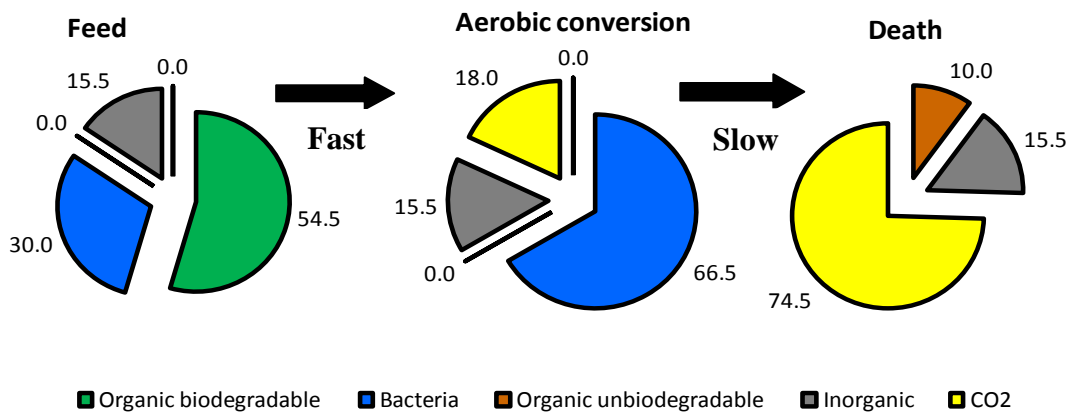
Irrespective of the influence of number of pit users on per capita sludge accumulation rate, for design purposes where the exact number of users for a particular pit cannot be accurately determined in advance, a good approach would be to use the 80<sup>th</sup> percentile value of the obtained sludge accumulation rate on a per pit basis (ℓ/year). This approach ensures that the majority of pits will be designed to not fill beyond capacity within the expected design life of the pit, but is not overly influenced by extreme values in the data set. The 80<sup>th</sup> percentile value for sludge accumulation rate obtained in this study was 400 ℓ/year. For comparison with literature, if an average of 5 people per household investigated is assumed, this will correspond to a per capita sludge accumulation rate of approximately 80 ℓ/person·year.

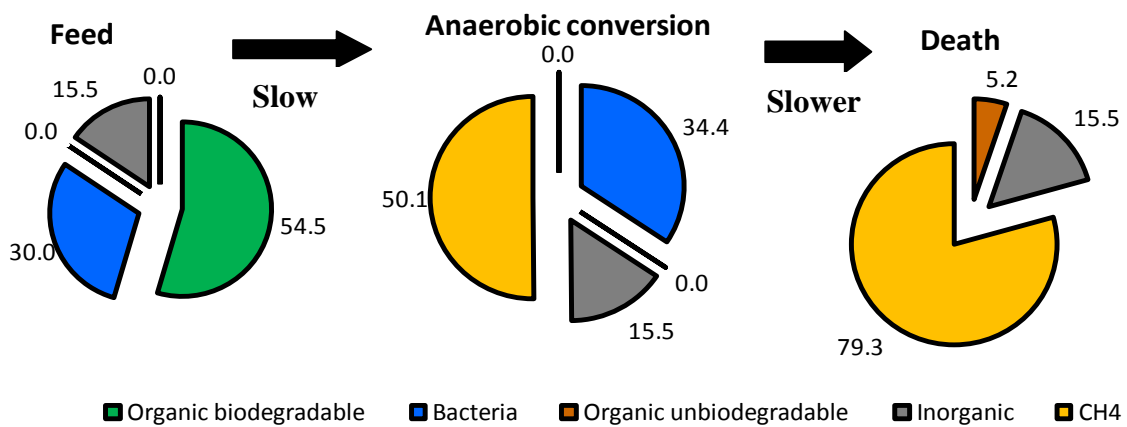
Based on the average sludge accumulation rate of 56 ℓ/person·year, the amount of materials added to the pit by an individual (Faeces and Urine) which is approximately 550 ℓ/person·year (110 ℓ faeces/person·year and 440 ℓ urine/person·year) informed by the literature as presented in **Section 2.3.1.1** and if it is assumed that the amount of other solid material (other household refuse such as papers, glass, tins, etc which are commonly found in pits within eThekweni municipality) added to pits ranges between 0 to 100 % of the amount of faeces added to the pit by an individual, then this study indicates that between 25 to 50 % of the solid materials added to the pit by an individual per year had eventually accumulate as sludge. This calculation is based on the ratio of the obtained sludge accumulate rate in this study to the assumed volume of faeces deposited per person into the pit per year informed by the literature with no solid material added other than faeces and if the volume of solid material added is equivalent to the volume of faeces deposited into the pit as a worst case scenario. Thus, based on this study the range of volume reduction within the pits investigated is between 50 to 75 % of the added solid materials over the three years in which all the pit investigated had been in use after emptying. This clearly indicates that significant biological stabilization must have occurred in the pit latrines investigated despite the fact that the pits investigated have only been in use for 3 years.

## 4.2 ROLE OF DIGESTION PROCESSES ON ACCUMULATION RATE

Aerobic and anaerobic digestion processes have been identified as processes that do occur within a pit latrine. A brief description of these two digestion processes has been presented in **Chapter 2**. Buckley *et al* (2008) indicated that about 80 % of organic material in faeces that is deposited in a pit latrine is biodegradable and that 30 % of the dry mass of faeces is made up of bacteria while between 75 % and 80 % of the mass of faeces is moisture. The biodegradable organics in the pit degrade with time; certain dissolved components are leached out of the pit while non biodegradable components such as rubbish deposited in the pit remain unchanged. Pit latrine sludge degrades mainly in the absence of oxygen (anaerobic degradation), however near the surface of the pit there is a small layer where aerobic activity occurs.

During aerobic digestion which is in the presence of oxygen the biomass yield is relatively higher as compared to anaerobic digestion that occurs in the absence of oxygen. About 50 to 70 % of the organics consumed during aerobic digestion are converted to biomass whereas in anaerobic digestion only a small portion of the organics, about 5 to 10 % are converted to biomass (Speece, 1996; Henze *et al*, 1997; Buckley *et al*, 2008). **Figure 4.5** presents a visualization of how the different biological process occurring within the pit might influence sludge accumulation rate. It should be noted that, the values are purely for illustrative purpose. The percentages are assumed values of the composition of the material (faeces) added to the pit as informed by the literature and the assumption behind the figure is based on typical path way or digestion process of biodegradable organics presented in literature.





**Figure 4.5: Degradation of pit latrine sludge content with time showing aerobic conversion and anaerobic conversion process. Values shown are purely illustrative.**

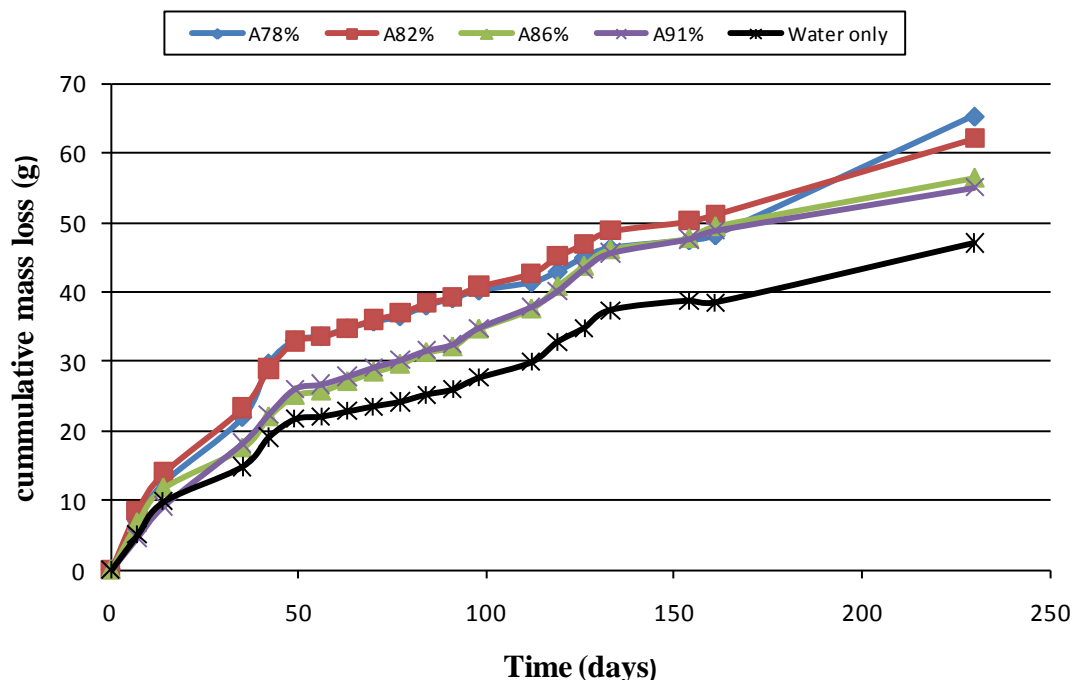
In order to illustrate the concept presented in **Figure 4.5**, it was assumed that the composition of the material added to the pit is comprised mainly of organic biodegradable material, organic unbiodegradable material, inorganic material and naturally occurring faecal micro-organisms. Thus, during aerobic digestion of the material in the pit latrine, the available organic biodegradable material is consumed by bacteria and other micro-organisms present in the pit resulting in the production of more biomass and carbon dioxide.

However during anaerobic digestion, available organic biodegradable material is also consumed by bacteria in the pits resulting also in the production of biomass but methane gas instead of carbon dioxide. Therefore, if it is assumed that there is no loss of inorganic material and organic unbiodegradable material out of the pit by leaching, then as shown in **Figure 4.5**, the amount of solid material that would remain in the pit (water free basis) when all biodegradable material is broken down is about 26 % for aerobic digestion and about 21 % for anaerobic degradation (using the assumed feed and degradation ratios).

However, aerobic digestion is a much faster process, and results in more biomass yield and as such the accumulation of sludge may be greater compared to anaerobic digestion. However, only a portion of the pit sludge will undergo aerobic digestion.

Therefore a pit latrine must be described by a combination of these two effects with a net accumulation value somewhere between the two values presented. This suggests that different ratios of aerobic and/or anaerobic process will result in accumulation values that are indistinguishable from one another given the large uncertainty associated with measurement of this kind in non-homogeneous systems like a pit latrine. Also the amount of non-degradable material (e.g. ash, sand and household refuse) could have an influence on the biological activity taking place within the pit as well as the amount of solid material that would remain in the pit and the rate at which sludge would build up within the pit. Thus a laboratory batch experiment was conducted as described in **Section 3.2.1** to quantify the role of stabilization process on mass loss rates.

The plot of the cumulative mass loss for the pit sludge jar test at different moisture content is presented in **Figure 4.6**.

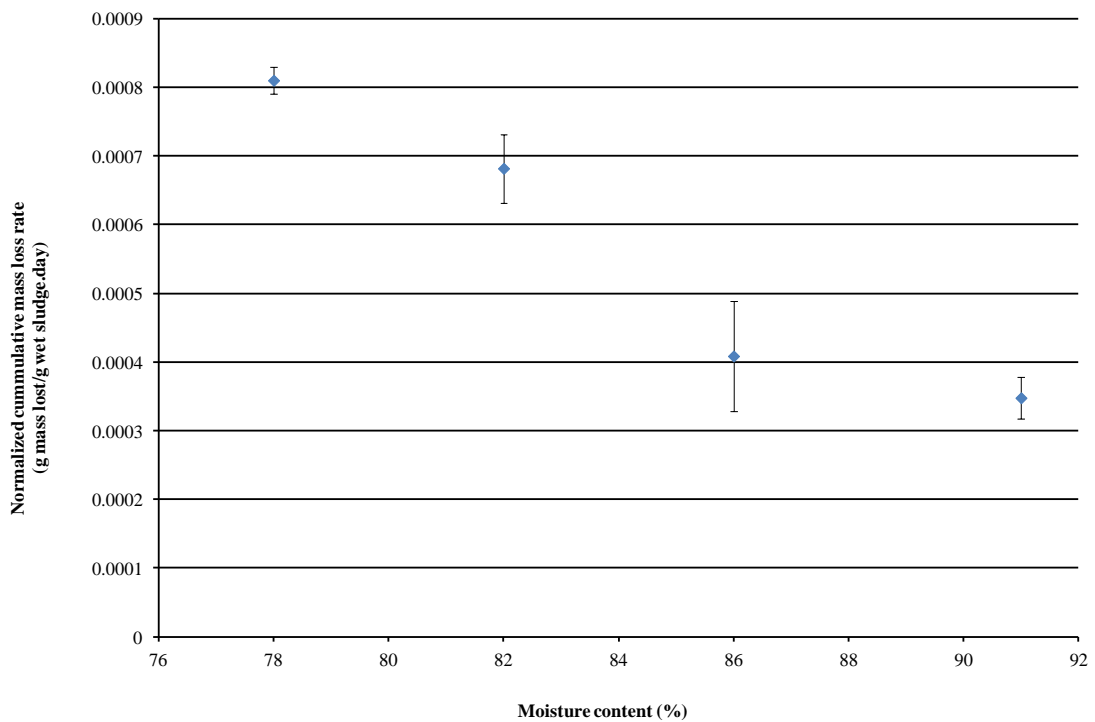


**Figure 4.6:** Cumulative mass loss of pit latrine sludge jar test at different moisture content over the entire duration of the experiment.

As presented in **Figure 4.6**, the concept presented is not supported because at this stage the final mass loss from lower moisture level samples is found to be greater compared

to higher moisture level samples. However it was observed that there was a rapid degradation that took place initially which was followed by a slower degradation process. This could be attributed to the rapid degradation of readily available biodegradable components present in the sludge placed in the honey jars. However, for comparison of the effect of each moisture level on mass loss rate it is important to normalize the cumulative mass loss for the mass of sludge and water added to each honey jars. The normalized cumulative mass loss per day for the entire duration of the experiment was calculated using **Equation 4.3** for each honey jar (five for each moisture level) where the “final cumulative mass loss” is the value obtained after 230 days. The average across 5 replicates was calculated and plotted with respect to the different moisture levels.

$$\text{Normalized Cum. mass loss} = \frac{(\text{final cum. mass loss} - \text{average moisture loss})}{\text{starting mass of sludge} \times \text{no of days}} \quad [4.3]$$



**Figure 4.7:** Normalized cumulative mass loss rate to show the significant effect of increasing moisture content on mass loss rate of pit latrine sludge content. Error bars represent standard deviation on the mean.



If it is assumed that the moisture loss from all the honey jars was the same, and equal to that of the water only test units, then **Figure 4.7** indicates that by increasing the moisture content the rate of degradation of sludge samples decreases. This could be because the sludge settles with a layer of liquid above it for test units with higher moisture content thereby limiting the transfer of oxygen to the sludge. There was a systematic and linear decrease in mass loss with increasing moisture content suggesting that the decrease in degradation was directly a function of the moisture content. However it is not possible to make any conclusion regarding this effect because of the fact that the final mass loss from high moisture level samples is expected to be greater than that of the lower moisture level samples, but this was not observed at the end of the experiment as shown in **Figure 4.6**.

Thus, from these results, there is no evidence that increased moisture content alone results in lower sludge accumulation rates in a pit latrine; however there may be other effects that influence a pit under wet conditions that do have this effect but cannot be replicated in a laboratory batch test. It is also not possible to conclude whether more rapid covering over a pit contents by higher number of users influences the sludge accumulation rate from this experiment. However, it can be proposed that it is not the type of biological process taking place within a pit that predominantly reduces accumulation rate but that at higher number of pit users compared to smaller number of pit users the amount of microorganisms deposited into the pit is greater, therefore more microbial activity would be observed in pit with higher number of users.

Although little can be concluded about the role of moisture content on sludge accumulation rates in the field from this study, it is possible to report approximate mass loss for sample of pit sludge in the batch laboratory experiment. The mass loss obtained in this study ranged from 0.36 to 0.83 g sludge/ g dry sludge. If it is assumed that the mass loss other than that due to moisture loss was effectively dry sludge mass loss, then the mass of solids have been reduced to somewhere between 17 and 64 % of the original sludge mass.

### 4.3 DISCUSSION OF RESULTS

In this chapter, the findings on the study conducted to determine sludge accumulation rate in thirty Ventilated Improved pit latrines from a low cost housing development within Durban and the role of digestion processes on sludge accumulation rate in pit latrines are presented. This study show a range of sludge accumulation rate from as low as 120 ℓ/year to as high as 550 ℓ/year regardless of the number of pit users for the 30 pit latrines investigated. The range of sludge accumulaton rate observed in this study are similar to the amalgamated data of Still *et al* (2012). The overall average sludge accumulation rate obtained for all the 30 pits investigated was  $282 \pm 46$  ℓ/year.

Amalgamated data sets from Still *et al* (2012) was collated and statistical analysis was performed. The amalgamated data set was plotted as sludge accumulation rate on a per pit basis as a function of reported number of users and a linear model was fitted to the data to test if there is any statistical relationship between the per pit sludge accumulation rate and the number of pit users. it was evident from **Figure 4.1** that there was no linear relationship between the sludge accumulation rate data and the reported number of users. This is an indication that either the relationship between the number of users and sludge accumulation rate is not strong, or that the data are not reliable, since per pit sludge accumulation rate should increase with number of pit users. However, sludge accumulation rate data collected in this study indicated a strong linear correlation between per pit sludge accumulation rate and the reported number of users. As expected the per pit sludge accumulation rate increases with an increase in the number of users. The consistency of the data could be attributed to the fact that the data was collected at one time using one set of data gathering methods in one community.

It is shown from the statistical analysis performed that the observed apparent decrease in per capita sludge accumulation rate with increasing reported number of pit users is not a realistic observation. This was attributed to the fact that reported number of pit users does not reflect the average use patterns of pit users and that when an approximately constant property (per pit sludge accumulaton rate) is divided by an increasing property, the result is a decreasing property. Thus, the findings from this

investigation suggests that, per pit sludge accumulation rate should be considered as a more useful design factor when sizing new pit latrines.

Regardless of the influence of number of pit users on per capita sludge accumulation rate, for design purposes where the exact number of users for a particular pit cannot be accurately determined in advance, a good approach would be to use the 80<sup>th</sup> percentile value of the obtained sludge accumulation rate on a per pit basis ( $\ell/\text{year}$ ). Thus based on this approach, it could be suggested that sludge accumulation rate of 400  $\ell/\text{year}$  could be used for pit sizing purpose. This corresponds to a per capita sludge accumulation rate of approximately 80  $\ell/\text{person}\cdot\text{year}$  for an average number of 5 people per household which was the average size of households investigated in this study.

A simple mass balance approach was used to estimate the volume reduction in a pit latrine due to natural processes taking place. The estimation based on obtained sludge accumulation rate in this study and the amount of solid material that is added to the pit based on value quoted from literature. It was assumed that in the pit latrines investigated the amount of solid added (110  $\ell/\text{person}\cdot\text{year}$ ) were the same as that presented in literature. Thus based on the average sludge accumulation rate obtained in this study (56  $\ell/\text{person}\cdot\text{year}$ ) and that the effect of adding other materials which was assumed to range from 0 to 100 % of the solid material added to the pit, it was found that between 25 to 50 % of the material added to the pit had accumulated over a 3 year period in which the pit has been used from when it was last emptied. This implies that over the 3 years in which the pit had been used, there has been about 50 to 70 % reduction of the volume of solid materials added to the pit.

A laboratory scale batch experiment was also conducted to assess the mass loss at different amounts of total moisture content. It was observed that by increasing the moisture content the rate of degradation of sludge samples decreases. Over the 230 days batch laboratory experiment, mass loss was inversely proportional to total moisture content. The mass loss obtained in this study ranged from 0.36 to 0.83 g sludge/ g dry sludge. If it is assumed that the mass loss other than that due to moisture loss was effectively dry sludge mass loss, then the mass of solids have been reduced to somewhere between 17 and 64 % of the original sludge mass. This observation is

attributed to the exposure of sludge samples in the test units to oxygen. The mass loss rates calculated is expected to be higher than that which will be observed in a pit because the batch laboratory test had continuous air exposure but pit contents are usually covered over by new materials added to the pit. It is not possible to make any conclusion from the experiment related to the effect of moisture because of the fact that, the rate of mass loss should remain unchanged in the test units and the final mass of samples with high moisture level is expected to be lower after an extended period of time, but this was not observe at end the experiment and could mean that the experiment should go on for an extended period of time.

This did not prove that increasing the moisture content alone can results in lower sludge accumulation rates in a pit latrine; there may be other effects that influence a pit under wet conditions that do have this effect but cannot be replicate in a laboratory batch test. However, by comparing the caluclated mass loss in the batch laboratory experiment with the volume reduction in the field investigation of sludge accumulation rate (**Section 4.1**), it can be infered that sludge densification/compaction could play an important role on the rate at which pit fills up. However this cannot be prove since one set of measurements where insitu field measurements and the other were artificial lab based batch test.

## 5 CHARACTERIZATION OF SLUDGE CONTENTS IN A VIP LATRINE

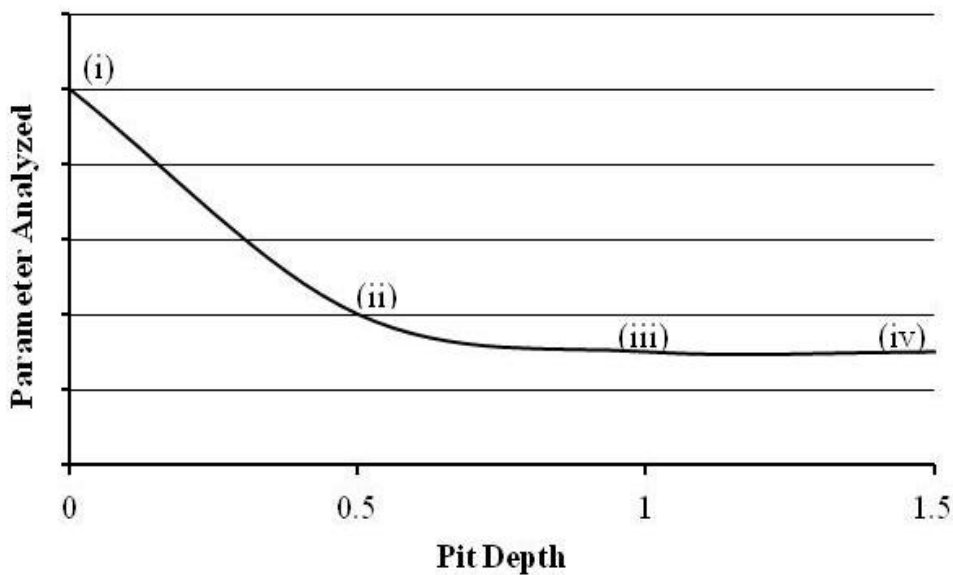
---

---

In **Chapter 4**, it was found that the volume accumulation rate of sludge in a pit latrine was less than the volume addition rate, suggesting that materials added into the pit undergo certain transformations. It is expected that an understanding of the physical, biological and chemical characteristics of the sludge in a pit will provide relevant information as to which disposal option is applicable and the health and environmental risks associated with handling and disposal of the sludge. Ventilated improved pit latrine sludge is heterogeneous in nature because of the wide range of material that could be found in the pit as described in **Chapter 2 (section 2.3)**. Thus obtaining a representative sample to describe the sludge content in a pit is usually very difficult. The type of material found in a pit depends largely on what is added by the householders and therefore the characteristics of the sludge in one pit cannot be taken to be the same as in another pit.

Based on the theory proposed by Buckley *et al* (2008) which was presented in **Chapter 2 (section 2.2.2)**, it is expected that the material (mainly faeces and urine) added to pit latrines should undergo rapid degradation under aerobic conditions until it is covered over. Thereafter anaerobic degradation occurs until all biodegradable material in the pit is stabilized. The implication of the proposed theory by Buckley *et al* (2008) is that when sludge samples are collected from these four different layers within any pit latrine, the residual biodegradable solid as a fraction of total solids should decrease for samples collected from the surface layer (i) through to layer (iii) as presented in **Figure 5.1** and should remain fairly constant in layer (iv). This would result in decreases in chemical oxygen demand (COD), volatile solids (VS) and biodegradability of pit latrine sludge content as a function of total solids as one digs from the surface layer down to the bottom layer of the pit. The general expected trend for the decrease of the residual biodegradable solid as a fraction of total solids is as shown in **Figure 5.1**.

It should also be noted that depending on the household habits and local environmental conditions, and the history of these factors, the sludge content within a pit will vary considerably in its moisture content, organic content, non-biodegradable content and microbial population with time within a pit and when compared with another pit. This theory applies when there is relatively little movement of material in the pit after original addition, such that the age of the material in the pit (amount of time since it was deposited) increases with increasing depth and is therefore probably limited to relatively dry pits (no free liquid surface).



**Figure 5.1:** Expected trend for the decrease of the residual biodegradable solid as a fraction of total solids from the surface layer of the pit down to the bottom of the pit.

In this study, the location from which sludge samples were collected within each pit is specified as follows:

- Top level sample: the sludge was collected from the surface of the pit beneath the pedestal
- 0.5 m depth sample: the sludge was collected after the top 0.5 m of the pit content had been emptied by the pit emptying contractors.

- 1 m depth sample: the sludge was collected after 1 m of the pit sludge had been emptied.
- Bottom level sample: the sludge was collected at the very bottom of the pit from the last bucket removed from the pit.

### 5.1 RESULTS OF CHARACTERIZATION OF PIT SLUDGE CONTENT

A general observation during the emptying exercise was that a wide range of materials other than faecal and anal cleansing material were found in the pit. This is an indication that households make use of the pit for the disposal of solid material. When owners of the pit were questioned as to why they dispose solid waste into the pit, the general response was that the pit serves as the only practical and safe place to dispose hazardous materials such as disposable nappies, broken glass or sharp metals, sanitary pads, or materials which could not be easily burned. **Figure 5.2** presents the rubbish removed from a pit during emptying after the rest of the sludge content had been washed through a screen into the sewer.

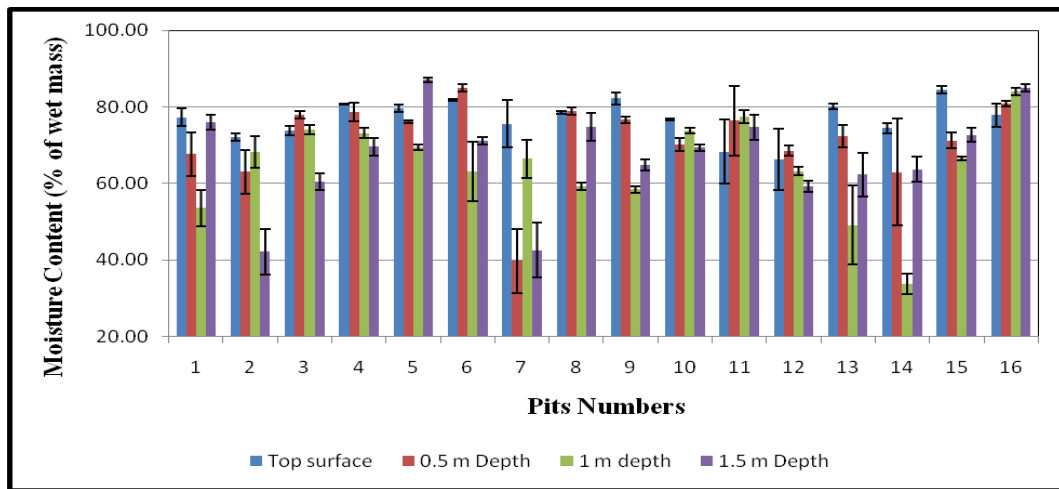


**Figure 5.2: Material found in a pit during emptying.**

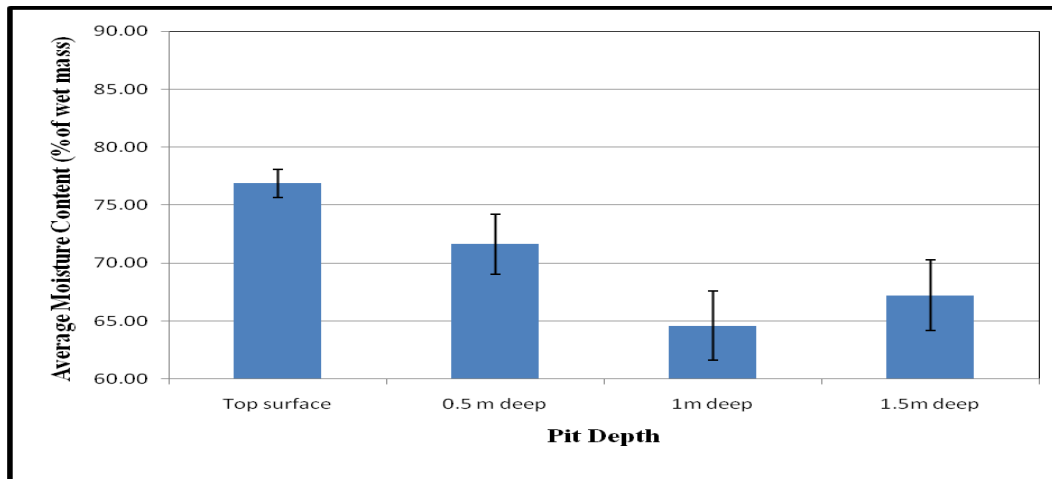
The result obtained from the laboratory characterization of pit latrine sludge content collected at different depth for each pit latrines investigated is presented in the following section. The overall averages are presented in **Table 5.1**.

### 5.1.1 Moisture content characterization results

The moisture content characterization results are presented in **Figure 5.3**. In most of the pit latrines, the moisture content showed a general decrease with increasing depth **Figure 5.3(a)**. This suggests that most of the pit latrines investigated were located in areas where most of the pit volume was above the level where free ground water can be found at the time that the pit were sampled. This implies that there was a net movement of water out of the pit.



(a)



(b)

**Figure 5.3:** Moisture content characterization results (a) for each of the 16 pits from different layers within each pit (b) average moisture content at each layer for the 16 pits. Error bars represent 95 % confidence on the mean value of each layer.



A Pearson correlation test was performed which confirms that there was a significant decrease in moisture content with increasing depth ( $P < 0.05$ ). The average total moisture content within each pit analyzed was about 60%, this falls within the range reported in literatures (50 – 60 % of the total weight) to be adequate for microbial activity (Peavy *et al*, 1985; EPA, 1995). Hence, biological activity in most of the pits would not have ceased due to low moisture content.

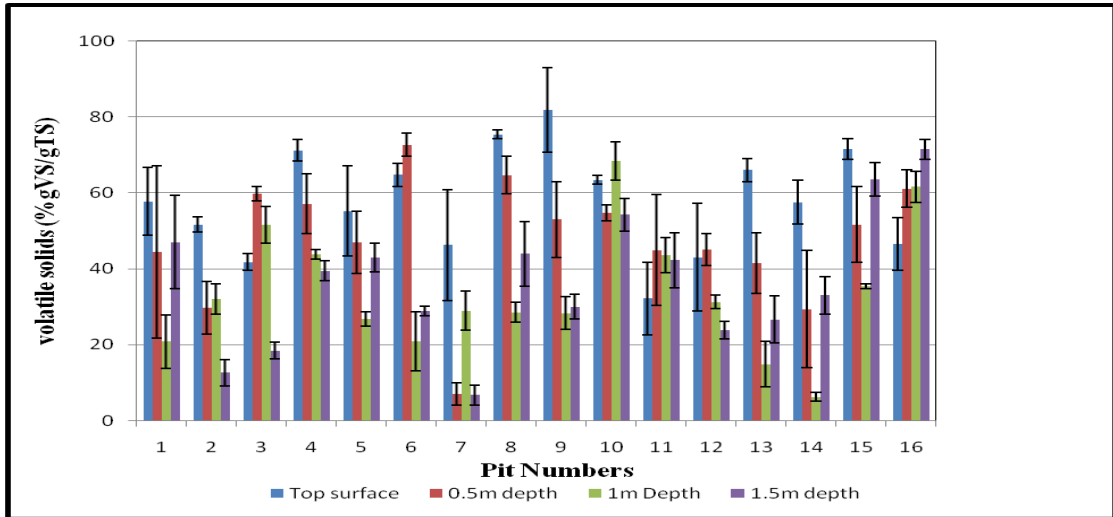
The general trend in the moisture content results for all pits was a decrease from the surface to 1m depth and little to no further change from 1 m to 1.5 m. An atypical result was observed for pit 16 where there was a gradual increase in the moisture content of the material in the pit from the surface of the pit to the bottom of the pit. This suggests that there might be water ingress from somewhere else, which may be from ground water or a leaking tap nearby. On average the mean moisture content at the surface layer of the pit was found to be 77 % and at the bottom layer it was found to be 67 % as shown in **Figure 5.3(b)**. In eight of the pit latrines investigated, the moisture content at the bottom layer was substantially higher than the moisture content of the 1 m depth sludge samples. These pit latrines may have been located such that the water table was higher than the bottom of the pit. A reduction in moisture content can also be due to the effect of compaction of sludge with time which could potentially result in the displacement of moisture from the pit.

### 5.1.2 Volatile solid characterization results

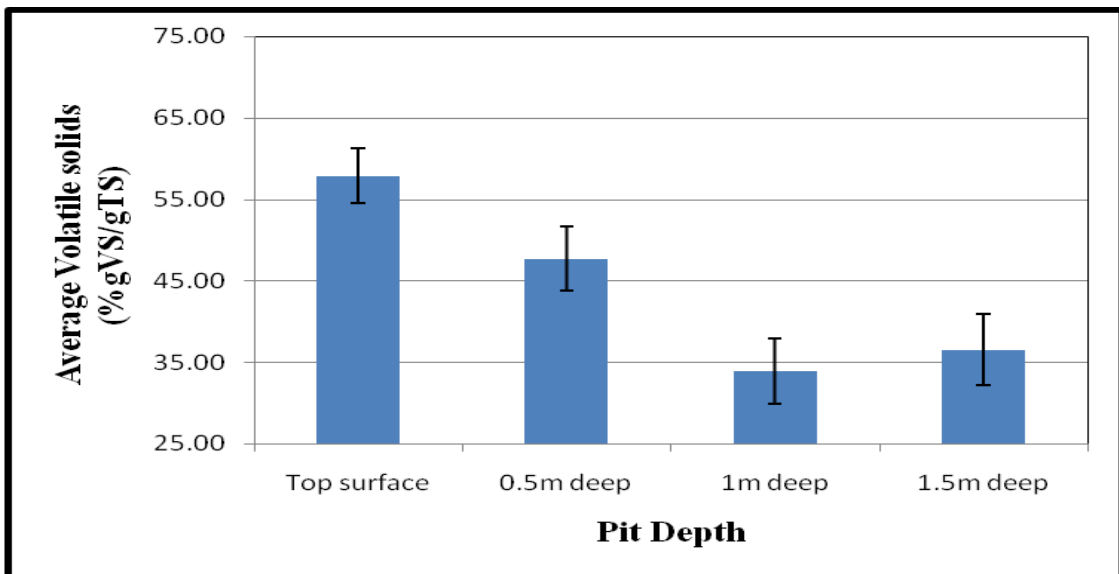
The results obtained for the volatile solid characterization is presented in **Figure 5.4**. The most important feature observed is that, for each of the 16 pits investigated the volatile solid as proportion of total solids decreases although not in a regular manner with increasing depth down the pit.

This trend is reversed in pit 16, although this apparent upward trend in volatile solid fraction is not statistically significant. **Figure 5.4 (b)** shows a decreasing trend in the average volatile solid as proportion of total solids of the 16 pits top surface to the bottom layer of the pit. If the volatile solid fraction is correlated to the organic content of the sludge, these results suggest that the degree of stabilization in the pit increases

from the top surface to the bottom layer of the pit leaving mostly non- volatile (ash-like) components.



(a)



(b)

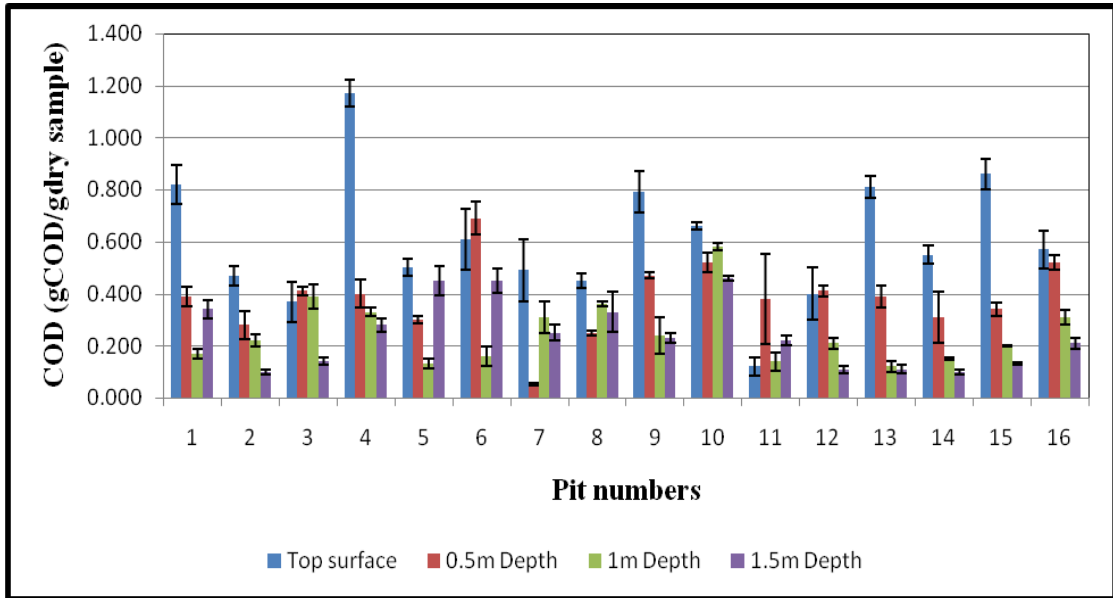
**Figure 5.4:** Volatile solid characterization results (a) for each of the 16 pits from different layers within each pit (b) average volatile solids at each layer for the 16 pits. Error bars represent 95% confidence interval on the mean value of each layer.

A Pearson correlation test was performed to quantify the relationship between volatile solids as a proportion of total solids and different layer from which samples were collected within the pit. The test confirms that there was a significant decrease in the volatile solids with increasing depth ( $P= 0.05$ ). Univariate analysis of variance was also performed using SPSS15 with a post-hoc Scheffe test to compare mean values of volatile solids of the different samples collected at different depth. It was found that there was significant difference between the top layer, 0.5 m depth and 1 m depth in volatile solids between all samples collected from this different depth, but for 1m depth and the bottom layer there was no significant difference. The Volatile solid result obtained in this study supports the Buckley *et al* (2008) proposed theory as the trend observed in **Figure 5.4(b)** is very similar to that presented in **Figure 5.1**.

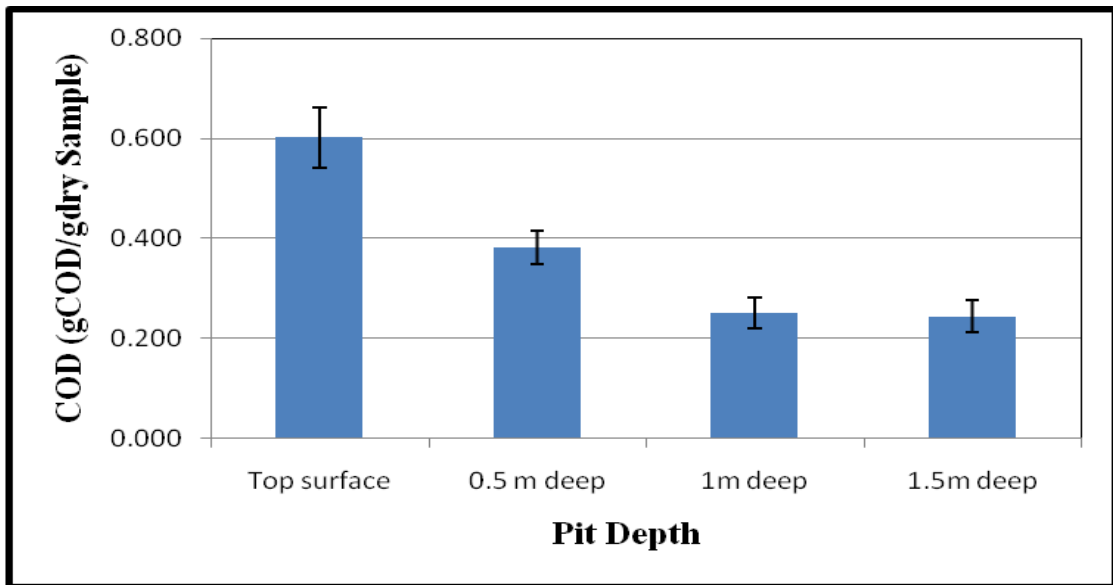
### 5.1.3 Chemical oxygen demand characterization results

**Figure 5.5** presents the chemical oxygen demand characterization result obtained for the sixteen VIP latrines sludge collected. Chemical Oxygen Demand is a measure of the oxidizable organic matter present in samples. Comparatively, COD analyses can be used as an indication of the degree of degradation which materials present in the pit have undergone.

As shown in **Figure 5.5(a)**, it is observed that the COD concentration (on a dry basis) at the surface of all the pits analyzed is significantly higher when compared to the bottom layer of the pits (except for pit 5 and 11 which have almost the same bottom sample value for pit 5 and greater value for pit 11). **Figure 5.5(b)** presents average COD value per layer for the 16 pits. It is observed that the COD concentration on a dry basis (gCOD/g dry sample) follows a decreasing trend from the surface layer of the pit down to the bottom layer of the pit. This implies that below the surface layer in a pit some additional degradation/stabilization does occur.



(a)



(b)

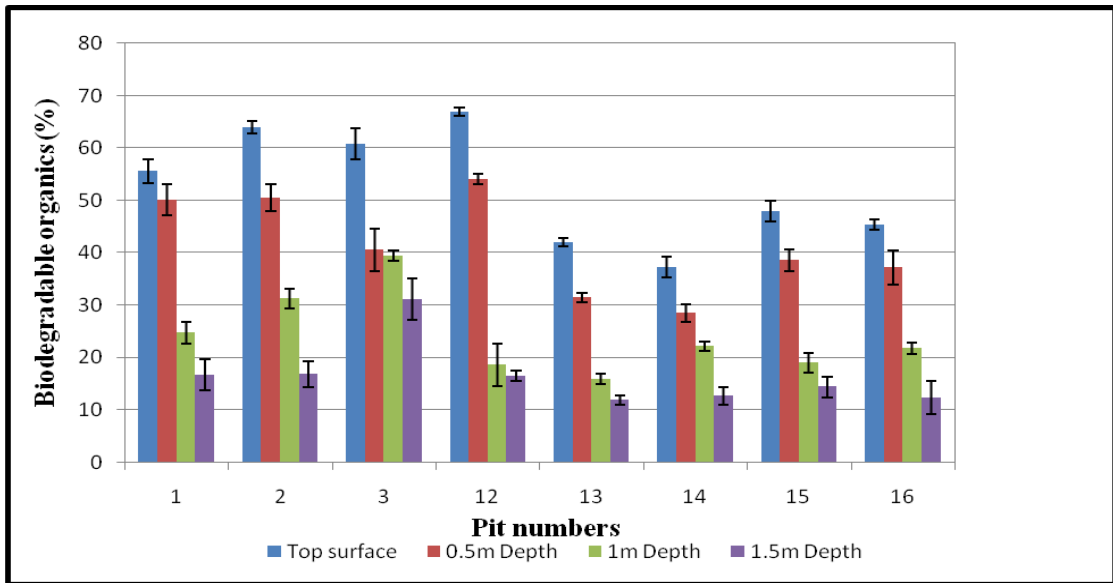
**Figure 5.5: Total COD characterization results (a) for each of the 16 pits from different layers within each pit (b) average COD at each layer for the 16 pits. Error bars represent 95% confidence interval on the mean value of each layer.**

A Pearson correlation test was performed to quantify the relationship between COD concentrations of samples and the different depth from which samples were collected within the pit. It was confirmed by the test that the COD concentrations decreases significantly with increasing depth within each of the pit latrines investigated ( $P= 0.05$ ). Also, Univariate analysis of variance was performed using SPSS15 with a post-hoc Scheffe test to compare mean values of COD of the different samples collected at different depths. It was found that there was a significant difference ( $p<0.05$ ) in COD between all samples collected from different depths but for 1m depth and the bottom layer (1.5m depth) there was no significant difference. These COD results are exactly what the Buckley *et al* (2008) theory proposed.

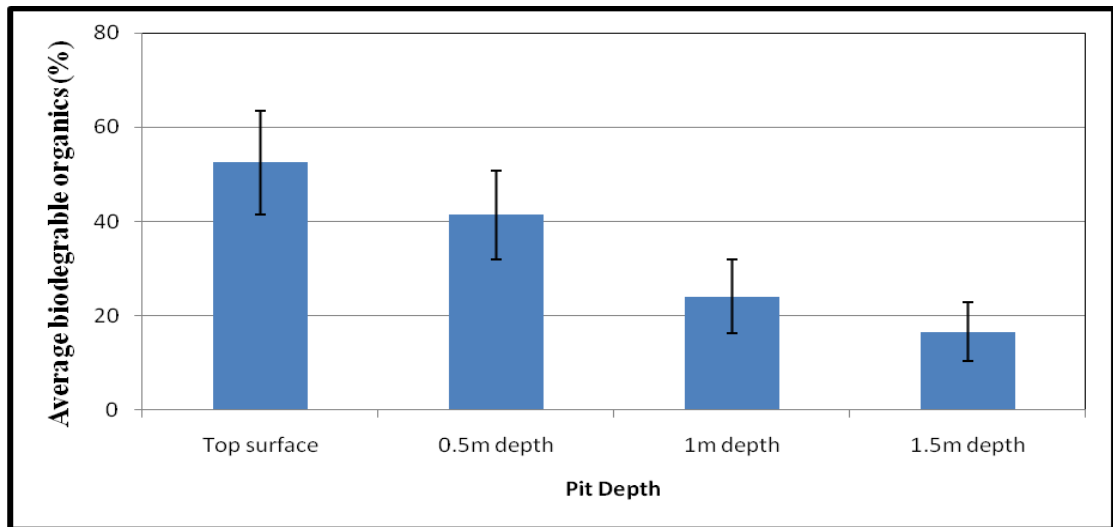
#### 5.1.4 Aerobic biodegradability characterization results

The Aerobic biodegradability test gives an estimate of the amount of biodegradable material present in each sample collected. **Figure 5.6** presents the aerobic biodegradability characterization results obtained. A low value indicates that the samples contain little biodegradable material and therefore have undergone a significant degree of stabilization. Only half of the total sample collected could be analysed since analysis of a sample takes approximately eight days to complete. Thus only 8 of the 16 pits were analyzed because the delay between sampling and analysis would have been too great for the results to be valid especially since samples are exposed to air during sampling and storage and the effect of this on samples is not known.

The biodegradability results for all the 8 pits follow the same trend. In **Figure 5.6(a)**, the biodegradability (in %) at different depths for each of the 8 pits analyzed is presented. The results showed a decreasing trend from surface layer to the bottom layer of each pit. This suggests that for each of the pits analyzed the degree of stabilization increases from the surface layer to the bottom layer of the pit. The average biodegradability for each layer for the 8 pits analyzed as shown in **Figure 5.4(b)** also shows a decreasing trend from surface layer to the bottom layer. This supports the motivating hypothesis that the degree of stabilization within the pit increases with increasing depth within the pit.



(a)



(b)

**Figure 5.6 Aerobic Biodegradability results (a) for each of the 16 pits from different layers within each pit (b) average Biodegradability at each layer for the 16 pit Error bars represent 95% confidence on the mean value of each layer.**

A Pearson correlation was performed to quantify the relationship that exists between the biodegradability of samples and the different depth from which samples were collected

within the pit. The test indicated that biodegradability of sludge samples collected decreases significantly with increasing depth within a pit ( $P= 0.05$ ). Univariate analysis of variance was also performed using SPSS15 with a post-hoc Scheffe test to compare mean values of biodegradability of the different samples collected at different depth. It was found that there was significant difference ( $p<0.05$ ) in biodegradability between all samples collected from different depth but for 1 m depth and the bottom layer (1.5 m depth) there was no significant difference. This also supports the theory proposed by Buckley *et al* (2008).

## 5.2 DISCUSSION OF RESULTS

This investigation was conducted in eThekweni Municipality where pit conditions are predominantly fairly dry, i.e. there is usually no free liquid surface on the top of pit latrine contents. Thus, the degree of stratification in the pit (and therefore limited mixing between layers) may not necessarily be found under different conditions, especially under wet conditions. With that stipulation in mind, it was found that all analytes correlated with biodegradable material, i.e. COD, volatile solids fraction and biodegradable COD decreased significantly between the surface sample and the third sample, taken from approximately 1 m below the surface. However, the difference between the 1m sample and the bottom sample was not statistically significant. These results support the Buckley *et al* (2008) theory that biological stabilisation, otherwise described as the degradation of biodegradable components, occurs in a section of the pit contents that extends from the surface down to a point corresponding with material deposited some years previously, but below this section, the material has reached a composition that does not degrade further to any substantial degree with time.

Apart from the investigation supporting the Buckley *et al* (2008) theory, an explanation of the effect observed could be that the age of the pit might have an influence on the characteristics of the material in the pit. If the pits investigated have been in use for a very long time, sludge samples from the bottom of the would be well stabilized because of long residence time the material have spent in the pit and as the material is covered with new material the characteristics of the new material deposited would be different from the bottom material. Also, if the pit were still in use at the point of sampling, the

stability of the material at the surface would be lower compared to the material beneath the surface. All the pits investigated had been in use for more than 10 years. All households except for pit 6 had been operating without the addition of additives or other substances and all pit investigated except for pit 7 were full (level with the slab). This is an indication that sludge samples that would be obtained from the bottom layer of the pit would have undergone significant stabilization because of the time the material initially deposited has spent in the pit. Since the pit investigated were still in use up until the time samples were collected, sludge samples from the surface is expected to be relatively fresh as confirmed by this study.

From these results, a picture of the life cycle of the pit can be developed; that is, when a pit is first commissioned, or emptied, the material added to the pit is fairly fresh, and to begin with, the pit material has undergone little stabilisation. It is all similar to layer 2 of the Buckley theory. After a period of time, as material undergoes degradation and gets covered over with fresh material, the bottom layers become anaerobic and partially degraded (layer 3 of the Buckley theory) while the new top layer is the Buckley layer 2. After a considerable amount of time (years) the bottom layers have undergone degradation to an extent that they cannot degrade further under pit conditions, and may be said to be fully stabilised (layer 4). Immediately the 4<sup>th</sup> layer is established, and if it is assumed that the material that is deposited into the pit by pit users is of the same composition and at a constant rate, then the rate at which the pit latrine contents accumulate would be at the same rate at which layer 4 increases since the layers above will move upward steadily. Thus the rate at which the pit fills up would be approximately at the same rate at which material that will eventually become unbiodegradable residue is added to the pit. However, this is would be at a much lower rate than the volume addition rate of fresh pit materials.

The important corollary of these findings is that the only way to reduce pit accumulation rate would be to reduce the amount of material that will eventually become unbiodegradable residue. Therefore by Increasing the rate of degradation within a pit will only result in the thickness of the combined Buckley layers 2 and 3 being smaller, which would extend the life of the pit slightly by reducing the average accumulation rate, but if it were possible to degrade layer 4 contents further than occurs



naturally (i.e. changing the yield of non-degradable residue from pit feed material), the amount of material that will eventually become unbiodegradable residue will be a smaller proportion of what was originally added and will have the same net effect. To date, there is no documented method of achieving either of these options.

**Table 5.1** presents a summary of all the characteristics of VIP samples measured. The measurement did not take into consideration general household waste found in the pit latrines sampled, it only considered the faecal sludge component of the pit since this is the fraction that is expected to degrade in predictable way. The measurement of sludge samples collected at different layers for all the pits were averaged for each of the layers. The characterization results have provided information on the variability of VIP latrine sludge content from one pit to another and at different layers within a pit. A significant variation within a pit and between pits was observed despite the fact that all VIPs used in this study were located within similar geological/ environmental conditions. Changes in sludge characteristics at different depths within the same pit suggest that biodegradable material present in faecal sludge found in pit latrines decreases with time.

**Table 5.1: Summary of VIP Sludge contents at different layer within the pit. Data are presented as mean value  $\pm$  95% conf. Interval, [min, max]**

Parameters	Units	Surface Layer	0.5 m depth	1m depth	1.5m depth
Moisture	%	76.84 $\pm$ 1.68 [57.58, 85.71]	71.63 $\pm$ 3.32 [30.06, 86.06]	64.94 $\pm$ 3.59 [30.72, 84.83]	67.08 $\pm$ 3.72 [34.71, 87.48]
COD	g/gdrysample	0.60 $\pm$ 0.07 [0.10, 1.23]	0.38 $\pm$ 0.04 [0.05,0.76]	0.25 $\pm$ 0.036 [0.10, 0.59]	0.24 $\pm$ 0.039 [0.09,0.49]
VS	%gVS/gTS	57.68 $\pm$ 4.41 [ 23.60,94.64]	47.26 $\pm$ 5.10 [3.67,75.62]	34.37 $\pm$ 4.83 [4.89, 73.57]	36.54 $\pm$ 5.29 [3.94, 74.46]
Biodegrad.	%	52.46 $\pm$ 10.92 [35, 68]	41.35 $\pm$ 9.38 [27, 56]	24.08 $\pm$ 7.73 [7, 44]	16.55 $\pm$ 6.25 [8, 35]

The average COD obtained for faecal material at the surface of the pit was found to be 0.603 gCOD/gdrysample which is significantly lower than the value of 1.13 gCOD/g drysample obtained for fresh faeces by Nwaneri (2009) and other literature values presented in **Table 2.1**. Also there was a significant difference in the amount of volatile solid (58 %gVS/gTS) at the surface of the pit compared to that of fresh faeces (84 % gVS/gTS) and the average biodegradability obtained for the surface layer (52 %) of the pit was also found to be significantly lower (80 %) than that of fresh faeces presented in **Table 2.1**. It should be noted that the values of COD, VS and biodegradability reported in **Table 2.1** may not be the same as in the fresh faeces of users of the pit latrines investigated. However, these values provide a basis for comparing the expected characteristics of fresh faeces added to the pit.

The findings of the characterization of sludge from VIP latrines implies that materials present at the surface layer in the pits when the samples were collected had undergone a degree of stabilization when compared to the fresh faeces and also that, immediately after faeces had been deposited in the pit degradation of readily biodegradable components of the faeces takes place rapidly.

## **6 ENTRENCHMENT OF VIP LATRINES SLUDGE FOR AGROFORESTRY**

---

---

Safe disposal of VIP latrine sludge is essential for public health protection. The unsafe disposal of VIP latrine sludge is not only a menace to public health but could also be a roadblock to sustainable development and a huge strain on financial resources. Thus, any chosen disposal option should be appropriately designed, sited and adequately managed to avoid both public health and environmental risk. This is because VIP latrine sludge contains highly infectious pathogenic organisms and organic pollutants (**Chapter 2**). **Chapter 3 and 4** provided information on the mechanism of sludge stabilization and the characteristics of sludge in VIP latrines. Deep row entrenchment of VIP latrine sludge for agroforestry was investigated as a disposal option for the management of pit once removed from the pit. This chapter presents findings of part of a broader study conducted on the applicability of deep row entrenchment of VIP latrine sludge content in eThekweni municipality. The broader study considers the effect of sludge entrenchment on growth characteristics of trees, on soil characteristics, changes in the characteristics of sludge buried in trenches and on the surrounding groundwater. In this chapter the findings of the investigations conducted to determine the changes in the characteristics of pit latrine sludge buried in trenches over time and the effect of the entrenched pit latrine sludge over time on surrounding ground water are presented. This chapter is divided into three sections. The first section is a brief description of the entrenchment site in which the study was conducted. The second section presents the experimental results of the changes in the characteristics of pit latrine sludge buried in trenches and the third section presents the findings on the investigation conducted to determine the effect of entrenched pit latrine sludge on surrounding ground water.

### **6.1 SITE DESCRIPTION**

The site selected for the entrenchment trials was in Umlazi E-Section on land owned by eThekweni Municipality that was formerly used as wastewater stabilization ponds. The former Umlazi Oxidation Pond Treatment Works was comprised of three oxidation

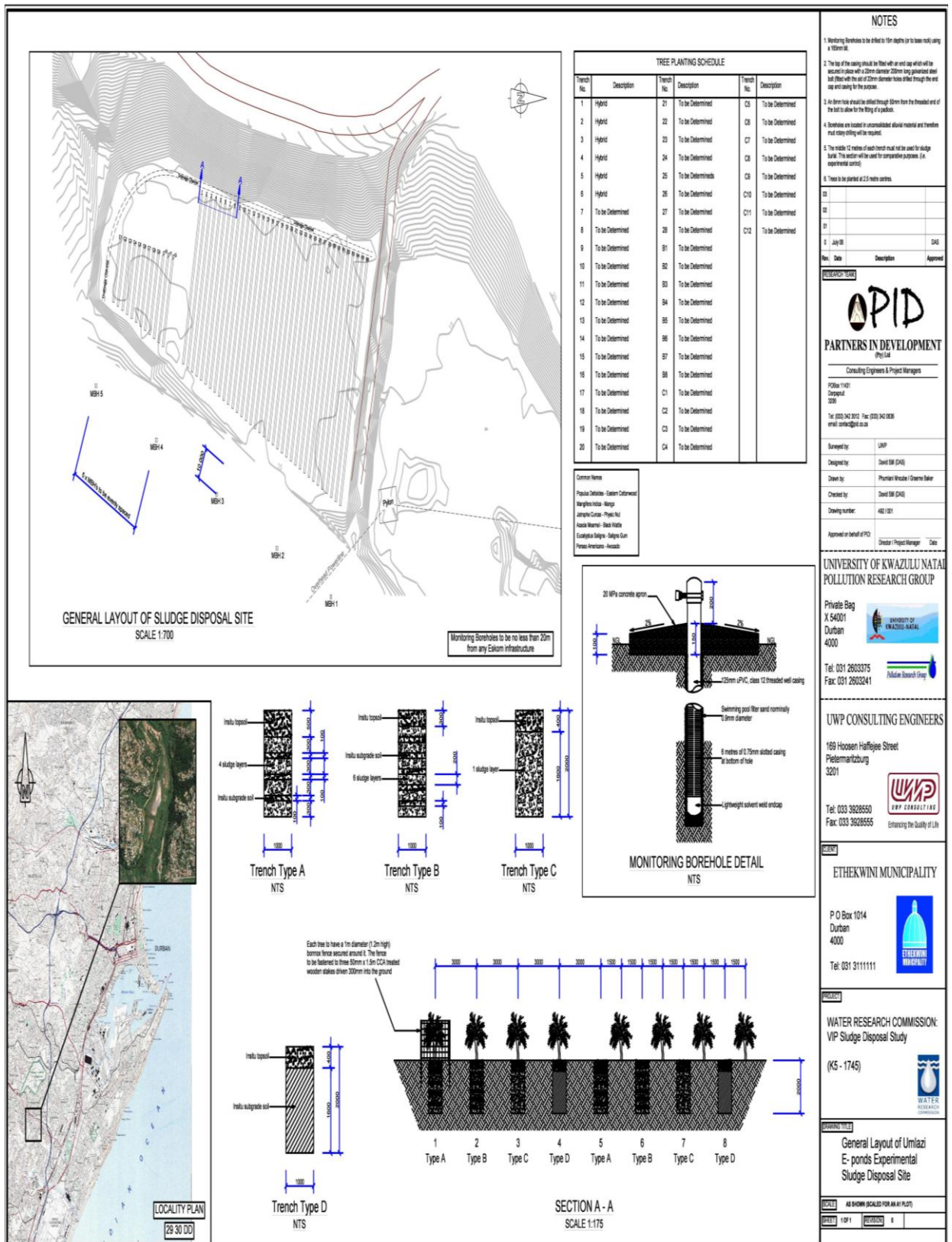
ponds and was operated until 1999 when it was decommissioned after a heavy flood which resulted in the damage of the oxidation ponds. The entrenchment site has several advantages;

- The site is close to a number of VIP latrines which were being emptied at the time of this study.
- The site was previously used for sewage processing; hence there is precedent in terms of land usage.
- The site is situated below the 1:50 year flood line, therefore the land has no value for other purposes.

The results of a soil characterization performed by the School of Bioresource Engineering and Environmental Hydrology at the University of KwaZulu- Natal, is presented in **Table 6.1**. The data indicated that the soil at the burial site appears to be of poor quality, predominantly composed of sand. This suggests that the soil has almost no agricultural value. Therefore it was proposed that the burial of VIP latrine sludge on this site could improve the condition of the soil by increasing the organic materials and nutrients. The layout and details of the Umlazi VIP latrine sludge entrenchment site are shown in **Figure 6.1**.

**Table 6.1: Soil Analysis from Umlazi E-Pond (Still *et al*, 2012)**

Sample ID	Particle Size Analysis				pH	EC (electrical conductivity) dS/m
	%Sand	%Silt	%Clay	Textural class		
South East (1.3 m)	93.2	2.9	3.8	Sand	5.1	0.079
South West (2 m)	94.3	2.6	3.1	Sand	5.9	0.061
North East (1.5 m)	97.1	0.7	2.1	Sand	5.3	0.033
North West (2 m)	97.2	0.7	2.1	Sand	5.0	0.06

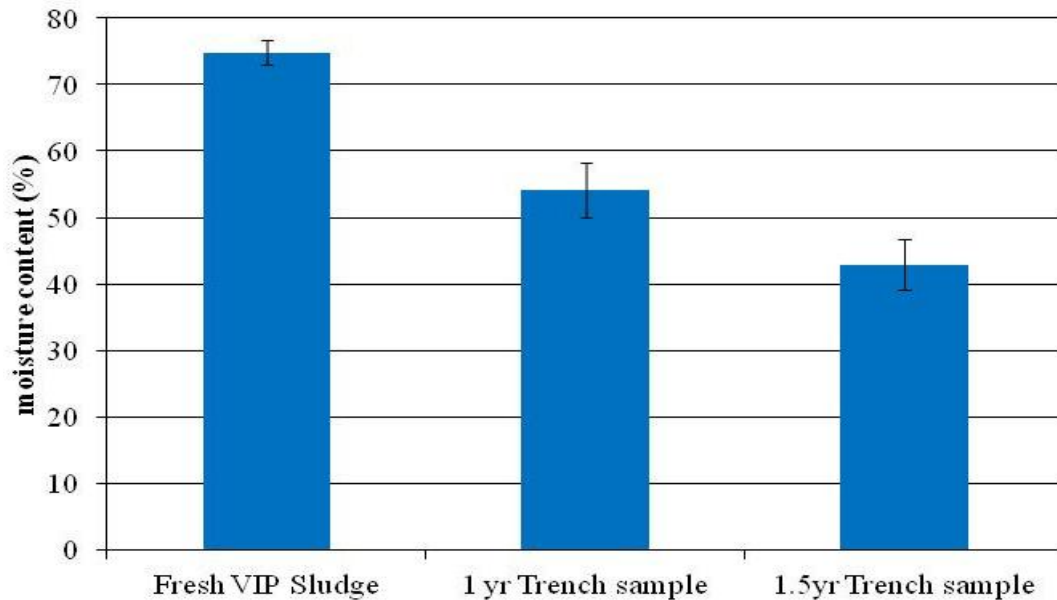


**Figure 6.1: General layout and details of the Umlazi VIP latrine sludge entrenchment site.**

## 6.2 SLUDGE CHARACTERIZATION RESULTS

Changes in the characteristics of VIP latrine sludge buried in trenches were investigated to determine the effect of entrenchment on the buried sludge. **Figure 6.2 to Figure 6.6** presents the results obtained from the characterization of VIP latrine sludge that arrived at the entrenchment site before burial and sludge exhumed from the trenches at different time intervals. Fresh VIP latrine sludge refers to the material that arrives at the entrenchment i.e. just before burial.

**Figure 6.2** presents the moisture content characterization results obtained for both the fresh VIP latrine samples and the sludge exhumed from the trenches at different time intervals.

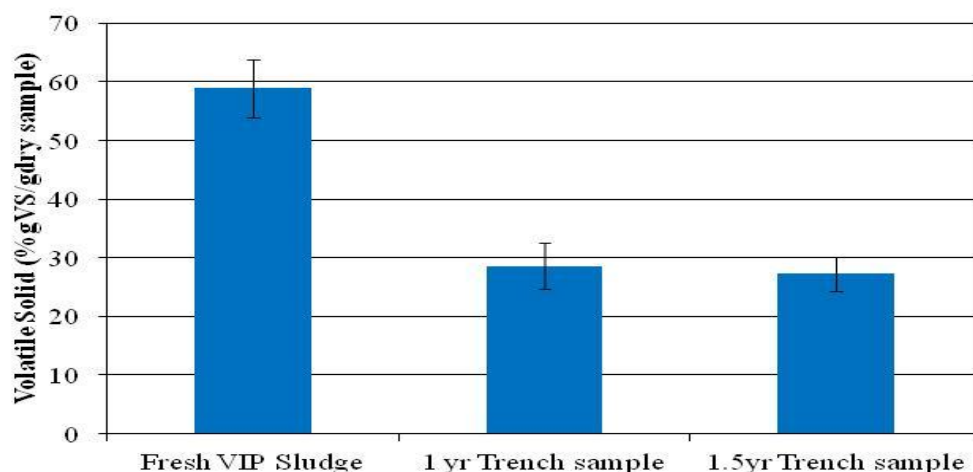


**Figure 6.2: Moisture content results for both fresh VIP latrine and trench samples. Error bars represent 95% confidence interval on the mean of the replicate measurements.**

The average moisture content obtained for the fresh VIP latrine samples was approximately 75%. This corresponds to the average value obtained for pit latrine sludge presented in **Chapter 5** of this thesis (78 %) and the value of 76% obtained from a previous study conducted by Buckley *et al* 2008. The average moisture content obtained from the sludge samples exhumed across the trenches at the Umlazi entrenchment site after a year was 58% and after 1.5 years was 43%. Univariate

analysis of variance conducted using SPSS 15 with a post-hoc Scheffe test to values of the moisture content for both the fresh VIP samples and trench samples showed that there was significant difference ( $p < 0.05$ ) between the moisture content of fresh VIP sample and trench samples (1 and 1.5 year old trench sample). This implies that the moisture content of the fresh VIP sludge samples reduces with time when buried in trenches. Comparing these moisture results with the values measured in the pit latrines at different depths in **Chapter 5** suggests that further reduction in the moisture content of VIP latrine sludge does occur over time when the sludge is buried in trenches with trees planted alongside. It has been documented (Cotton *et al*, 1995; Franceys *et al*, 1992), that liquid can leach into or out of pit latrine contents as a result of rain or groundwater ingress; thus it is conceivable that the moisture content in the entrenched sludge could show significant fluctuations due to seasonal changes. The soil at the burial site had good drainage properties, and the water table was found to be below the level at which sludge was buried. Thus, it is conceivable that moisture loss may have accompanied biological degradation and that the rate of reduction in moisture content is a function of biodegradation rate (contrary to the situation within pit latrines). However this cannot be proven from the given data

**Figure 6.3** presents the Volatile Solid results for both the fresh VIP latrine samples and sludge samples exhumed from the trenches at different time interval.



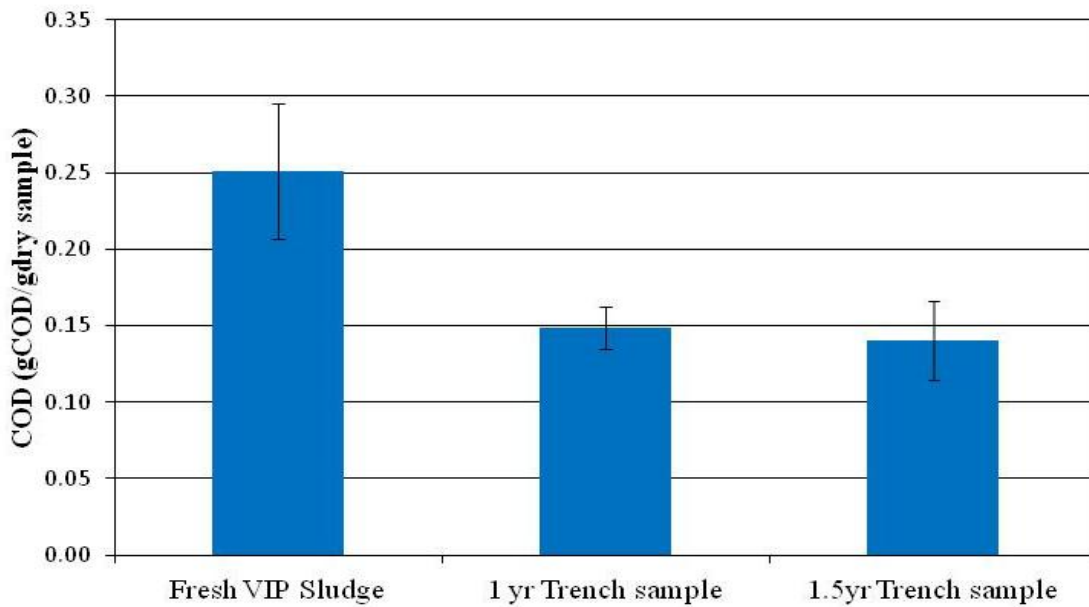
**Figure 6.3:** Volatile solid results for both fresh VIP latrine and trench samples. Error bars represent 95% confidence interval on the mean of the replicate measurements.

The average volatile solid (%gVS/g dry sample) result obtained for the fresh VIP samples analyzed was approximately 59% gVS/g dry sample while that of the trench samples exhumed after 1 year was approximately 29% g VS/ g dry sample and that of the exhumed trench sample after 1.5 years was approximately 27% gVS/g dry sample. Univariate analysis of variance carried out using SPSS 15 with a post-hoc Scheffe test to compare the volatile solid content for both the fresh VIP samples and trench samples showed that there was significant difference ( $p < 0.05$ ) between the fresh and trench samples but there was no significant difference ( $p > 0.05$ ) between the 1 year and 1.5 year exhumed sludge samples from the trenches.

The most important feature observed from the results presented in **Figure 6.3**, is that the average volatile solid measurement decreases between the fresh VIP sample and the buried sludge samples in trenches indicating a reduction in organic matter during entrenchment. This reduction in volatile solids indicates that significant stabilization of the sludge has taken place when sludge is buried in trenches. The results also indicate that rapid stabilization of the sludge takes place within one year of burial but after one year little or no further stabilization takes place. Thus, by comparing the volatile solid value of approximately 27 % gVS/gTS obtained after 1.5 years of entrenchment of VIP latrine sludge with the average value of approximately 37 % gVS/gTS obtained for VIP latrine sludge collected from the bottom layer of the pit which is said to have undergone significant degree of stabilization (**Figure 5.4 in Chapter 5**) suggests that further degradation of sludge may have occurred in the trenches compared to pit latrines.

**Figure 6.4** presents the COD results for both the fresh VIP latrine samples and sludge samples exhumed from the trenches at different time intervals.





**Figure 6.4: COD results for fresh VIP latrine and trench samples. Error bars represent 95% confidence interval on the mean of replicate measurements**

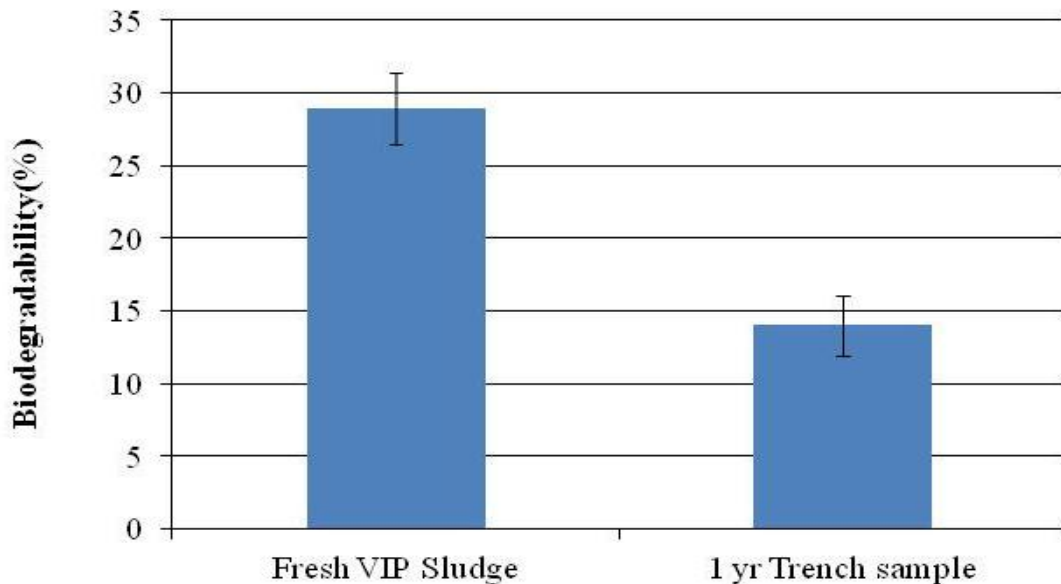
COD is a measure of the oxidizable matter present in samples and is used as an indication of the amount of chemically oxidizable material in a sample. While the measurement does not directly indicate the amount of biologically oxidizable material, the advantage of the measurement over direct measures of biodegradable matter is that it is relatively quick to perform and the results are reproducible. Furthermore, if samples are exposed to conditions in which biological activity will dominate changes, then changes in COD can be equated to changes in organic matter. In this case, changes in COD can be used as an indication of the degree of degradation that materials present in the trenches have undergone.

The average COD value obtained for the fresh VIP samples analyzed was approximately 0.25 g COD /g dry sample while that of the trench samples exhumed after one year of burial was approximately 0.15 g COD/ g dry sample and the trench sample exhumed after 1.5 years was approximately 0.14 g COD/g dry sample. Univariate analysis of variance carried out using SPSS 15 with a post-hoc Scheffe test to compare mean values of the COD for both the fresh VIP samples and trench samples showed that there was significant difference ( $p < 0.05$ ) between the fresh VIP samples

and trench samples but there was no significant difference ( $p>0.05$ ) between the trench sample exhumed after one year and that exhumed after 1.5 years. This result is similar to the volatile solids results.

It was observed that the average value of 0.25 g COD /g dry sample obtained from the characterization of VIP latrine sludge samples that arrived at the entrenchment site was lower than the global average value of 0.37 g COD /g dry sample obtained from the characterization of pit latrine sludge presented in **Chapter 5**. However, by comparing the COD value of approximately 0.14 g COD/g dry sample obtained after 1.5 years of entrenchment of VIP latrine sludge with the average value of approximately 0.24 g COD/g dry sample obtained for VIP latrine sludge collected from the bottom layer of the pit as presented in **Figure 5.5**. It appears that further degradation of sludge may have occurred in the trenches compared to that observed in a pit latrine.

**Figure 6.5** below presents the Biodegradability results for both the fresh VIP latrine samples and sludge samples exhumed from the trenches at different time interval.



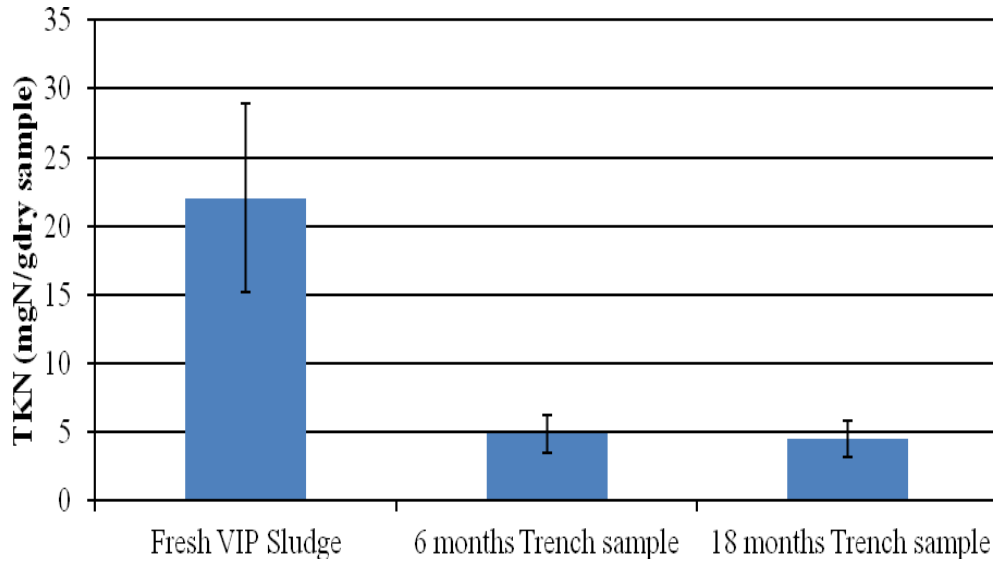
**Figure 6.5:** Biodegradability results for fresh VIP latrine and trench samples. Error bars represent 95% confidence interval on the mean of the replicate measurements.

The aerobic biodegradability test gives an estimate of the amount of biodegradable material present in the sample collected. The average biodegradability result obtained for the fresh VIP samples analyzed was approximately 29% while that of the trench samples analyzed was approximately 15%. Univariate analysis of variance carried out using SPSS 15 with a post-hoc Scheffe test to compare mean values of the biodegradable COD for both the fresh VIP samples and trench samples showed that there was significant difference between the fresh and trench sample. As shown in **Figure 6.5** the relative biodegradability of the fresh VIP samples is higher than that of the trench sample indicating that the fresh sample that was buried has further been stabilized in the trenches. Comparing these results with that obtained from the characterization of sludge at bottom layer of the pit presented in **Chapter 5** indicated that biodegradability of sludge from the trench is slightly lower than that of the bottom layer of the pit but not significantly different.

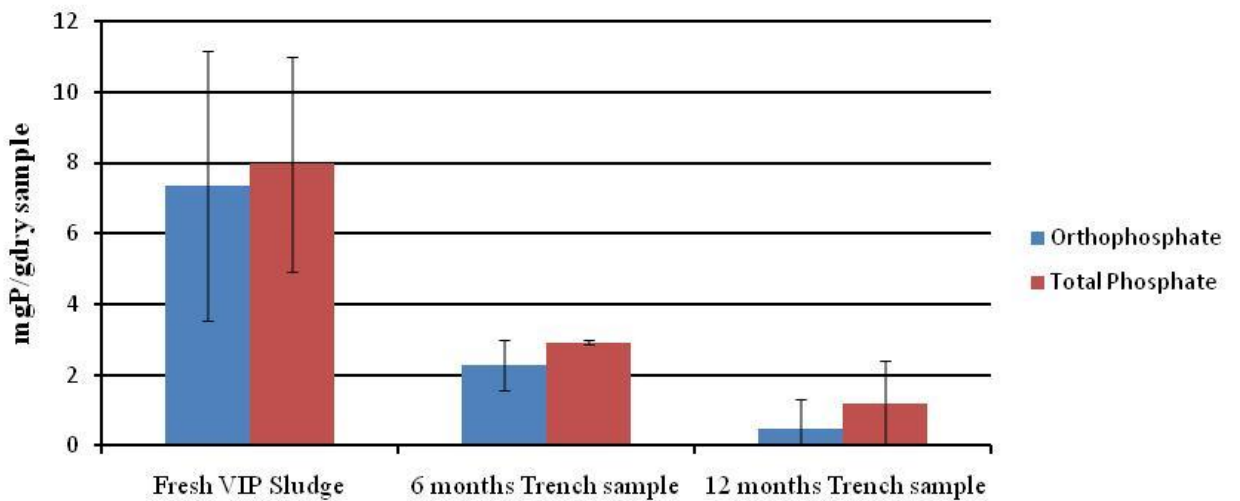
Nitrogen and phosphorus are essential nutrients for plant growth; the potential value of entrenching sludge for agroforestry is that nitrogen and possibly phosphorus present in the sludge may be a slow-release fertiliser for plant growth. **Figure 6.6** presents the plot of the results obtained from the analysis of nitrogen and phosphorus content in VIP latrine sludge before the burial of the sludge and after significant periods of entrenchment of the sludge associated with tree planting. It was found that the amount of nitrogen and phosphorus in the VIP latrine sludge before burial reduces when compared to that obtained from the exhumed sludge in the trenches. The amount of TKN released by the sludge is calculated from the difference in TKN on a wet basis between the initial TKN in sludge and the TKN remaining after 18 months. Thus, 17.5 mg N/g wet sample are lost over a period of 18 months. This corresponds to approximately 4.4 kg N/ton wet sludge.

These results are consistent with the findings of Taylor (2012) who in a parallel project measured tree growth characteristics of the trees planted at the Umlazi entrenchment site studied in this research. Taylor (2012) found that trees showed dramatically improved growth characteristics compared to a negative control, suggesting that some attribute of being planted near buried pit sludge was beneficial to tree growth. It has been proposed that the nitrogen and other nutrients released from the entrenched sludge

may be biologically available as a fertiliser. A summary of the study conducted by Taylor (2012) is presented in **Appendix D**.



(a)



(b)

**Figure 6.6: Results obtained from the analysis of nitrogen and phosphorus content in VIP latrine sludge before the burial of the sludge and after significant periods of entrenchment of the sludge associated with trees planting. Error bars represent 95% confidence interval on the mean on the replicate measurements.**

### **6.3 Groundwater Quality Results at the Entrenchment Site**

Monitoring of groundwater at the entrenchment site is important in order to assess the environmental viability of this disposal option for pit latrine sludge. The impact of this disposal option on the environment is also relatively important to be considered if deep row entrenchment of pit sludge in association with agroforestry is to be considered a viable means of disposing of pit sludge. However, environmental impact assessment was not part of the scope of this study. The emphasis was on changes in the entrenched sludge characteristics (this study) and the effect on tree growth (Taylor, 2012).

However, monitoring of groundwater around the entrenchment site was important to assess if there were any large impacts that would suggest if it would be necessary for a more detailed study to be conducted. This section is divided into two. The first section discusses the challenges faced during the monitoring and sampling of ground water from the boreholes during the course of the investigation. The second section presents the experimental results obtained through the laboratory characterization of ground water samples collected over a three year period.

#### **6.3.1 Challenges**

Sampling of groundwater from the five monitoring boreholes commenced from November 2008 to February 2011 when the writing up of this thesis started. Initially sampling of groundwater from the five monitoring boreholes was meant to be on monthly basis, however due to the hostile community where the entrenchment site was located, it was impossible for consistent sampling on a monthly basis.

In April 2009 sampling of groundwater from the five monitoring boreholes was not performed as a result of various protests that sprung up within the community because this was the month in which the South African Presidential election was conducted. However, it was possible to conduct the sampling run from all boreholes in May 2009 but between the months of June 2009 up until May 2010 it was not possible to carryout sampling from borehole 1. This was because the lock on borehole 1 was damaged. Three nails were hammered into the key opening of the lock by someone in the

community. These locks were special locks supplied by the eThekweni Municipality and the lock had to be blasted to open the locks.

Also in the month of July 2010 the sampling could not be performed on all five boreholes, as this was the month in which the local community were hijacking and attacking workers at the entrenchment site and as such it was decided to stay away from the entrenchment site until issues have been resolved.

Sampling from all boreholes was only possible in the month of August 2010 but there was a major fire disaster in the month of September 2010 at the eThekweni Water and Sanitation Laboratory where analysis of collected water samples were conducted. The laboratory sustained significant fire damage; rebuilding and refurbishment of the laboratory took several months and was only completed in February 2011. Thus, all these issues had resulted in the gaps in the analytical groundwater data presented.

### **6.3.2 Results of Laboratory Analysis of Groundwater Samples**

The suitability of a given groundwater quality for a particular purpose depends on the criteria or standards of acceptable quality for that use. Thus the results obtained from the laboratory analysis of the water samples collected from each of the monitoring boreholes has been compared with the South African Bureau of Standards No 241 specification where possible and DWAF (1999) discharge limits was also used. The result of the laboratory analysis of each determinant in the water samples collected from each of the monitoring boreholes suggests that there is no immediate obvious negative impact on the groundwater, however this does not prove that there will be no negative environmental impact of the activity at the entrenchment. **Table 6.2** presents a summary of the results obtained from groundwater monitoring programme compared with SABS specification for drinking water. The detailed data set is presented in **Appendix C**.

**Table 6.2: Summary of results obtained from groundwater monitoring programme compared with SABS specification for drinking water. Data are presented as [min, max]**

Parameters	Units	BH 1	BH 2	BH 3	BH 4	BH 5	SABS Limits
pH		[6.60,7.14]	[6.70,7.1]	[6.50,7.10]	[6.50,7.20]	[6.5,7.5]	6-9
Conductivity	mS/m	[63, 95]	[48,85]	[44,58]	[45,61]	[53,70]	300
DO	mg/L	[1.03,3.20]	[1.10,3.05]	[0.35,3.10]	[0.30,3.20]	[0.2,3.4]	
Sodium	mgNa/L	[67,84]	[46,108]	[48,58]	[48,57]	[55,64]	400
Chloride	mgCL/L	[75,86]	[58,160]	[58,76]	[63,73]	[68,93]	60
Nitrates	mgN/L	[<0.1,0.96]	[<0.1, 1.3]	[<0.1,0.79]	[<0.1,0.78]	[<0.1,6.9]	10
Ammonium	mgN/L	[<0.5,0.14]	[2.3, 10]	[2.30,8.80]	[1.7,6.5]	[1.4,6.6]	15
Orthophosphate	mgP/L	[0.07,0.35]	[0.05,0.30]	[0.09,0.58]	[0.09,0.40]	[0.08,0.34]	10
E-coli	Cfu/100 ml	0	0	0	0	0	0
COD	mg/l	[<30,91]	[<30,91]	[<30,99]	[<30,91]	[<30,91]	65

The pH value and the conductivity measurements for each of the monitoring boreholes were measured right at the borehole-head. The pH of the water samples collected from each of the boreholes has remained consistent between slightly acidic pH (6.5) and neutral pH (7.5) since the commencement of the sampling process. This range of pH values obtained falls within the recommended maximum limit of pH value of 6 - 9 specified by the SABS specification for drinking water. The conductivity results from the boreholes were also below the maximum allowable limit of 300 mS/m specified by the SABS specification for drinking water. Conductivity is a robust and sensitive measurement and thus changes with changes in nitrate, ammonia, chloride, sodium and phosphate. Therefore the conductivity measurement should be a reliable indicator of plumes in any ionic contaminants. From the conductivity data obtained, there is no

evidence suggesting that there has been a plume of ionic contaminants during the monitoring period.

It was observed that the concentration of sodium and chloride ions follow similar trends except for borehole number 2 in which there was a peak in the chloride and sodium ions measured as indicated by the red rings (**Appendix C**). It is believed that the peaks observed might be as a result of analytical error or that these values were incorrectly recorded as these peaks do not correspond to the equivalent sodium or chloride measurements for the same sample. However, the values obtained for sodium concentration for each of the boreholes since the commencement of the sampling process were below the maximum allowable limits of 400 mg/l specified by the SABS specification for drinking water. The values obtained for the chloride concentration for all samples also fall below the maximum allowable limit of 600 mg/l specified by the SABS specification for drinking water. Overall there was no significant increasing trend observed in either the sodium or chloride concentrations for any of the boreholes.

Since the commencement of the sampling procedure the COD of the water samples has been within the maximum allowable effluent discharge target as presented in DWAF (1999). There was a spike in the measured COD in all boreholes between December 2008 and February 2009 (4 to 6 months after trenching of sludge commenced) which might indicate a plume of organic pollutants. However no corresponding increase in ionic components was observed in this period.

Nitrate and ammonium concentration usually serve as the determinant of pollutant in most groundwater monitoring programmes. A slight elevation in nitrate was observed in all boreholes between December 2008 and March 2009 but the increase was not significant, however the nitrate concentrations returned to the base line. The results obtained from the analysis of water samples collected from each of the five boreholes at the VIP latrine entrenchment site were consistently low and within the maximum allowable limits of 10 mg N/L for nitrate and 15 mg N/L for ammonium as specified by the SABS specification for drinking water. Also throughout the monitoring campaign orthophosphate in the water samples collected on a monthly basis never exceeded the



recommended maximum limit of 10 mgP/L specified by SABS specification for drinking water.

The bacteriological analysis involved analysis of *E. coli*, total coliforms and also total organisms in the water samples collected from the five monitoring boreholes from the commencement of the sampling programme. Interestingly, it was found that since the commencement of the sampling programme at the entrenchment site the *E. coli* count from the water samples was zero and the other bacteriological tests were below the detection limits for these tests. The results indicate that no microbial contamination of groundwater has occurred during the monitoring period.

#### **6.4 DISCUSSION OF RESULTS**

This chapter of the thesis investigated the possible benefits of deep row entrenchment and beneficially reusing pit latrine sludge for agroforestry. The primary objective was to (i) to monitor the changes in the characteristics of VIP latrine sludge with time in trenches and (ii) to monitor the characteristics of the surrounding groundwater so as to determine the effect of entrenchment on the sludge content as well as the surrounding groundwater.

**Table 6.3** presents a summary of the results obtained from the characterization of freshly exhumed VIP sludge that arrived at the entrenchment site before being buried in trenches as well as the changes in the characteristics of this sludge with time. These values were compared to similar measurements performed on samples taken from the bottom of 16 pit latrines presented in **Chapter 5** after they had been emptied. It was found that, for all of the analytes presented, sludge that have been entrenched for certain period of time (1.5yrs) were lower than the equivalent concentrations measured in samples taken from the bottom of a pit latrine although not significantly in some cases. These results suggest that biodegradation and dewatering occur in pit latrine sludge after it has been buried in trenches, although it is not clear how much of the change noted was a function of dilution by sand.

Generally, the data show high variance, but the decreasing trends are clear. It appears that an initial rapid degradation and moisture loss occurs: this is probably as a result of

the most recently deposited and therefore unstabilised pit latrine contents degrading. Thereafter, a slow decrease in volatile solids, COD and moisture is observed; until final values are reached that appear to be lower than the lowest values obtained in pit latrine bottoms sludge samples presented in **Chapter 5**.

**Table 6.3: Summary of fresh VIP sludge contents and trench samples. Data are presented as mean value  $\pm$  95% conf. Interval, [min, max]**

Parameters	Units	Freshly exhumed VIP	1yr Trench sample	1.5yr Trench sample
Moisture	%	74.86 $\pm$ 1.92 [62.54,89.44]	54.08 $\pm$ 4.09 [25.40, 67.55]	42.91 $\pm$ 3.83 [59.81,24.49]
Volatile solids	%gVS/gTS	58.90 $\pm$ 4.98 [18.11,86.25]	28.63 $\pm$ 3.87 [11.53,50.71]	27.24 $\pm$ 2.87 [1.55,51.01]
COD	gCOD/gdry samples	0.25 $\pm$ 0.04 [0.12,0.44]	0.15 $\pm$ 0.01 [0.11,0.20]	0.14 $\pm$ 0.03 [0.09,0.19]
Biodegradability	% g/g samples	28.90 $\pm$ 4.21 [22,36]	14 $\pm$ 1.87 [12,19]	

The findings of the entrenchment of pit sludge were similar in terms of tree growth for wastewater treatment sludge, although actual results on what happen to the sludge were not presented in the study in which wastewater sludge were buried in trenches **Chapter 2 (Section 2.3.4)**.

The boreholes were sunk parallel to the trenches and it was expected that should there be a significant release of nutrients; the direction of the contamination plume would be in a generally eastern direction from the trenches towards the river. Therefore it is expected that potential contamination from the trenches would first be observed in borehole 3 and probably in borehole 2. As presented in **Table 6.1**, the soil at the entrenchment site is predominantly composed of sand (approximately 97 %). It is expected that of all soil types, entrenchment in sandy soil would result in the biggest risks of groundwater contamination by leachate generated from the sludge in the

trenches (Sikora et al, 1978). This is based on the fact that hydraulic conductivity is usually very high in sandy soils and therefore the movement of leachate would be relatively fast (Morris and Johnson, 1967; Todd, 1976 and Sikora et al, 1978). It is expected that high levels of  $NO_3^-$  and  $NH_4^+$  would be produced in sandy soils (Sikora et al, 1978). Typical groundwater plume velocity in sandy soil ranges between 2 m/day to 2 m/year and the flows could be accelerated by mechanisms such as wells and drains if found around the entrenchment site (Todd, 1976). Thus if it is assumed that the groundwater plume velocity for the entrenchment site is approximately the same or within the range presented by Todd (1976) then it would be expected that significant levels of nutrient contaminant would be observed in the monitoring boreholes at the entrenchment site between 28 days – 28 years. The analysis of water sample collected from the five monitoring boreholes at the Umlazi entrenchment site has indicated that the burial of sludge in trenches did not have a profound effect on groundwater for the duration in which monitoring was carried out.

Nevertheless, caution is advised in drawing conclusions from these results presented because it is possible that plumes may not have reached the boreholes during the monitoring period. Possibly a range of different distances from the trenches might have helped to better observe any pollution peak that might have occurred especially if it was a fast moving, once-off release.

It should also be noted that the results presented are for approximately 3 years of monitoring. This may not have been a long enough period to either support or refute the fact that there would be low or negligible impact of entrenching VIP latrine sludge on the surrounding groundwater. It is also not possible to conclude whether nutrients released by biodegradation were taken up by trees, although the evidence of improved growth characteristic of trees planted on VIP sludge suggests this may be the case. An overall nutrient balance of the site would be required. In summary, it is not possible to conclude that no groundwater contamination will occur on the basis of this study, but given the relatively high loading rates, poor soil quality, the length of the monitoring period and the improved growth of trees, it seems unlikely that groundwater contamination will be a major concern in this option of pit latrine sludge disposal.

Thus, the entrenchment of VIP latrine sludge for agroforestry could offer several benefits such as:

- There is evidence that nutrients released from the sludge are agriculturally available, and there has been no evidence of significant groundwater contamination due to their release. This may be an option for replacing chemical fertilizers with known ground and surface water pollution characteristics.
- It reduces contact between human and pathogens in the sludge, thereby offering the potential of reduced health risk exposure.
- There is less reliance on synthetic fertilizer which makes use of increasingly scarce phosphorus which as it grows increasingly expensive, increases food prices.

## 7 EFFECTS OF PIT ADDITIVES ON SLUDGE CONTENT IN VIP LATRINES

---

---

It was established in **Chapter 5** that significant amount of stabilization takes place under the surface of the pit sludge, where there is likely to be very little, if any free oxygen and consequently anaerobic degradative processes are believed to be responsible for a significant amount of the stabilization that occurs in a pit latrine; however it is believed that aerobic digestion could also take place at the surface of the pit and sometimes on the side of the pit if the pit is not lined and if there is contact with unsaturated soil. The process of anaerobic digestion of pit latrine sludge content is relatively slow, resulting in build up of organic waste, odour production and fly nuisance which could pose significant risks to public health and the environment. Various suppliers and manufacturers of commercial pit latrine additives claim to provide solutions to the sludge, odour and fly problems including reducing the rate at which sludge builds up in pits and even reducing the volume of sludge content within pit latrines as well decomposing the pit latrine sludge to compost, and thereby reducing odours and flies. These claims have led to considerable interest in the use of these products for controlling sludge accumulation rates in pit latrines by households and authorities around the country.

However from the available literature reviewed in **Chapter 2** on the efficacy of pit latrine additives, there was no basis for pronouncing whether any of the additives have any reliable benefits, or what the scientific explanation for any of the alleged benefits could be. A summary of the main conclusions of the studies presented in the literature are:

- The Taljaard study concluded that the use of pit latrine additives might be beneficial; however the interpretation of the result obtained in this study was challenged by Foxon *et al* (2009) who stated that the Taljaard study used application rates many times higher than the prescribed application rates.

- In the study conducted by Sugden (2006), it was concluded that all the four stages of anaerobic digestion took place in all the trials but there was no evidence to show that the use of any of the bio-additive either enhanced or inhibited the anaerobic digestion process.
- Foxon *et al* (2009) concluded that the use of commercial pit latrine additives to treat pit latrine sludge content was unable to accelerate biodegradation rate and mass loss in laboratory test units.
- In the field trial to test efficacy of pit latrine additives presented in Buckley *et al*, (2008) it was also concluded that the addition of pit latrine additives to sludge content in the pit did not have any significant effect on sludge accumulation rates or sludge volume reduction in the pit. However it was indicated in that study that the use of simple height measurement do not provide accuracy in the measurement of volume reduction in pit latrines. It was proposed that a stereographic measurement technique using a number of photographs of the pile of pit contents could be used to determine the shape and depth of the pit surface using image recognition software.

In this chapter the findings of both laboratory and field trials conducted to determine the efficacy of pit latrine additives are presented.

## **7.1 PIT LATRINE ADDITIVE DESCRIPTION**

The two additives selected for this investigation are identified as Product A and Product B. According to the description provided by the supplier of Product A, the additive is a concentrated powder containing freeze dried bacteria with a total bacterial count of about 5 billion cfu/g. The product is said to be used as a waste digestant in septic systems, ventilated improved pit latrines, grease traps, drain lines, food processing plants and for similar waste and odour control problems. Product A has a characteristic yeast like odour, is a free flowing powder, has a neutral pH and is reported to be most effective within pH of 5.5 - 10.5 and temperature range of between 7- 60°C.

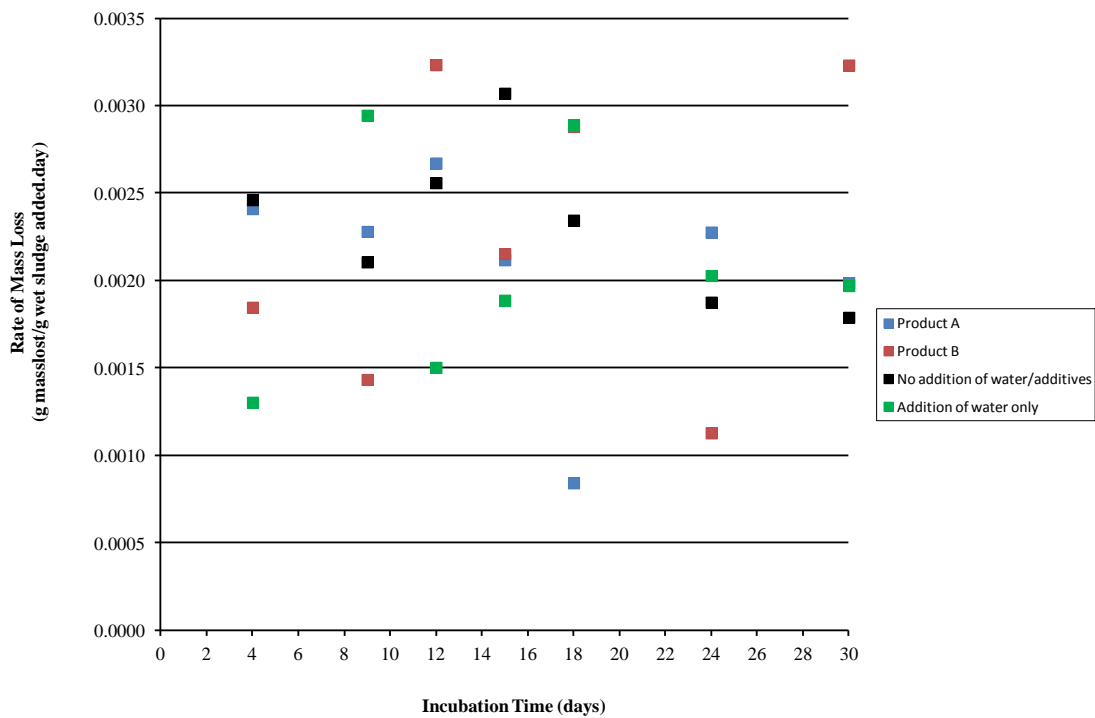
Product B was a brownish powder and described by the suppliers as being effective in:

- Elimination of bad odours at pit toilets
- Removal of flies and insects
- Stopping the spread of diseases from the sewage
- Reducing solids level
- Decomposing sewage to compost

## **7.2 RESULTS OF LABORATORY TRIALS FOR TESTING PIT ADDITIVES**

The laboratory trials aimed at testing the efficacy of pit additives on sludge collected from a number of pit latrines within eThekweni municipality. The methodology for these trials is presented in **Section 3.2.3**. There were five replicates set up for each treatment and for each replicate within a treatment; two to five pseudo-replicate measurements of mass loss rate were obtained.

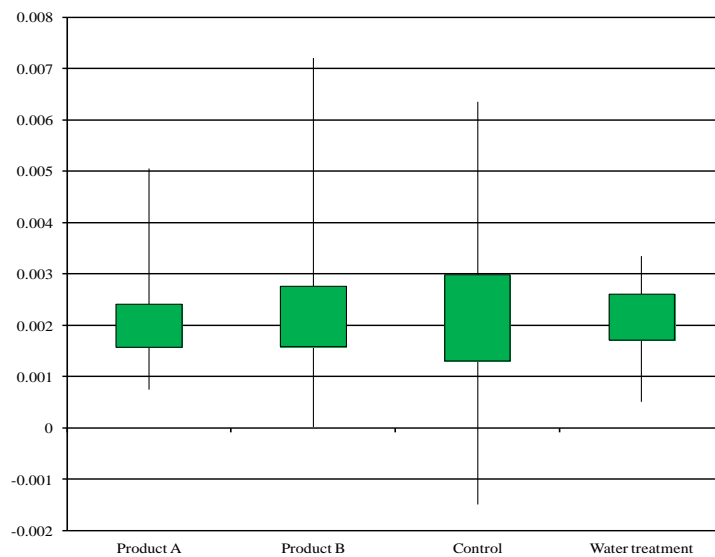
**Figure 7.1** presents a plot of the rate of mass loss with time for each replicate over the entire period of the laboratory trials for all treatments. It was found that there was no systematic change in the rate of mass loss with time over the entire duration of the laboratory trials for all the treatments. The average rate of mass loss in honey jars in which Product A was applied was found to be  $0.0021 \pm 0.0003$  g mass loss/g wet sludge added  $\cdot$  day and that of Product B was found to be  $0.0023 \pm 0.0005$  g mass loss/ g wet sludge added  $\cdot$  day. The average rate of mass loss in honey jars in which there was no addition of additives or water was found to be  $0.0023 \pm 0.0007$  g mass loss/ g wet sludge added  $\cdot$  day and that of the reference treatment in which only water added to sludge content in the test units was found to be  $0.0021 \pm 0.0004$  g mass loss/ g wet sludge added  $\cdot$  day.



**Figure 7.1: Rate of Mass loss with time for all treatments after 30 days of incubation.**

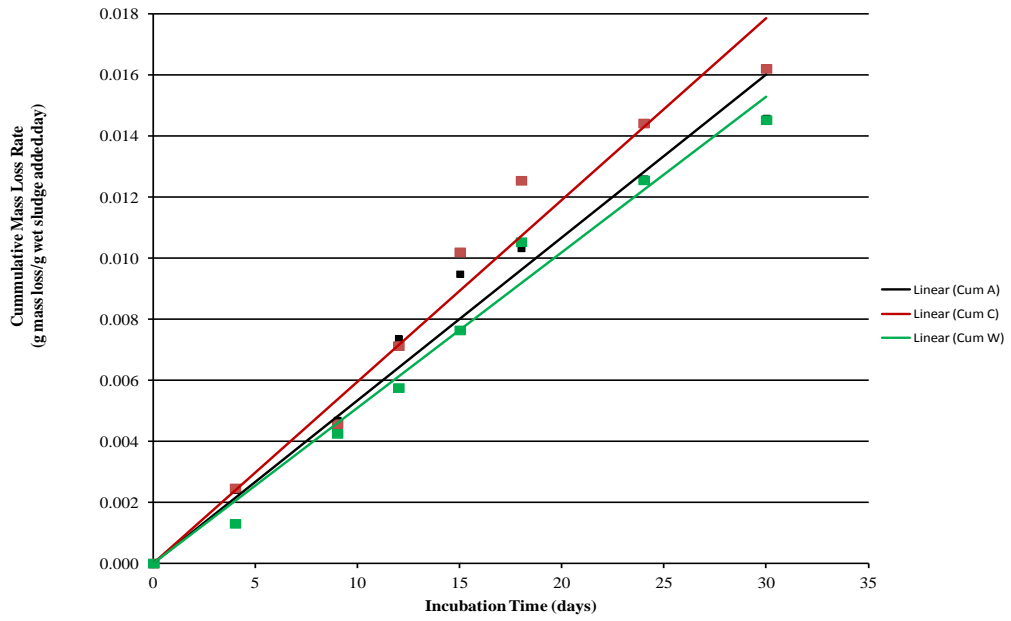
A Student T-test was performed to determine if there exists significant differences between the rates of mass loss with time in pit latrine sludge samples in which Product A and Product B was added showed that there was no significant difference statistically ( $p > 0.05$ ) between the effect of Product A and Product B on the rate of mass loss with time on pit latrine sludge samples over the entire duration of the laboratory trials. The rate of mass loss for each additive treatment and the reference treatments was then averaged and the 95% confidence intervals on the mean were calculated. The results are presented graphically as shown in **Figure 7.2**.



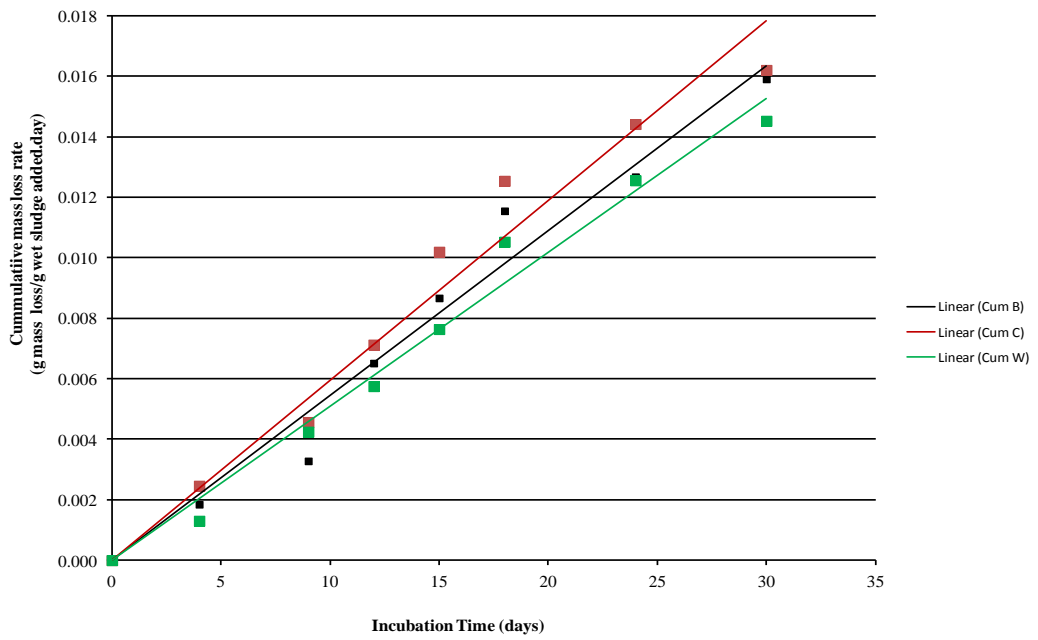


**Figure 7.2:** Box and Whisker plot showing rate of mass loss from honey jar containing pit latrine sludge samples subject to different treatments. The box for each data set represents the range of the 95 % confidence interval on the mean, while the whisker shows maxima and minima from within each data set.

The box and whisker plot as shown in **Figure 7.2** suggests that significant variation does exist in the measured mass loss rate for each treatment in the laboratory trials within and between treatments. However, differences between the rates of mass loss for each of the four treatments were not significant. In order to present the relationships between the four treatments in more detail, the cumulative rate of mass loss for each additive treatment is compared to the equivalent rate of mass loss obtained from the water reference and the control treatment and each data set is fitted with a straight line using linear regression as shown in **Figure 7.3**. There is clearly no increase in mass loss rate as a result of treating with additives. It has been proposed by Foxon *et al* (2009) that the amount of active micro-organisms added in a dose of commercial pit latrine additive is insignificant when compared to the amount of naturally occurring micro-organisms present in pit latrine sludge. Thus the enhancement of biological activity within a pit due to the addition of commercial pit latrine additives would be insignificant relative to natural degradation processes occurring within the pit as result of the presence on natural occurring bacteria. The result of this study is in support of this hypothesis.



(a)



(b)

**Figure 7.3: Cumulative Rate of Mass loss for Product A and Product B over 30 days of incubation period (a) Product A and (b) Product B. Each graph shows data from between 3 and 5 replicates of each treatment.**

Thus, the laboratory trials conducted have shown that the use of commercial pit latrine additive for the treatment of pit latrine sludge content under laboratory conditions had no statistically significant effect on the rate of mass loss of pit latrine sludge content under the conditions tested. Therefore the hypothesis that that In situ treatment of VIP latrine sludge using pit additives had no significant effect on the rate of mass loss or volume loss of pit latrines contents is supported. This finding supports the conclusions of Foxon *et al* (2009), Buckley *et al* (2008) and Sugden (2006). However the findings of this study refute the conclusions drawn from the study conducted by Taljaard *et al* (2003) which indicated that commercial pit latrine additive could be of beneficial use in reducing sludge accumulation rate in pit latrines by enhancing the biological activity within the pits.

Foxon *et al* (2009) challenged these findings and a parallel study was conducted by Montessuit (2010) to demonstrate the effect of high dosage rate of commercial pit latrines on pit latrine sludge content under laboratory conditions. In this study the recommended dosage provided by the manufacturer of the additives was used and this dosage was increased up until the dosage used was 100 times the recommended dosage supplied by the manufacturer of the additives.

It was observed in this study that although a dosage rate per unit area 100 times greater than the recommended dosage rate appeared to result in a bigger mass loss rate but the difference was statistically insignificant. The study concluded that this difference cannot be attributed to the effect of additives alone because the amount of water used in diluting the additive was 5 times more than that required for the recommended dosage. Thus the differences in the amount of water use in diluting the additive could also contribute to the differences observed. Even if this study had shown that using a dosage of 100 times more than the recommended dosage by the manufacturer would be beneficial towards the reduction of sludge accumulation rates in pit latrines and sludge volumes in pits, this would not be an economical viable practice because of the cost of the additives as well as the required amount of water needed for diluting the additives.

### 7.3 RESULTS OF FIELD TRIALS FOR TESTING PIT ADDITIVES

The laboratory trials conducted to test the efficacy of pit latrine additives indicated that the use of pit latrine additive on collected sludge samples from various pit latrines do not have any significant effect on the rate of mass loss in laboratory test units. It is speculated that laboratory trials might not really represent the true conditions that could be found in pit latrines, specifically because fresh material is constantly added to pit latrine while the laboratory trials has a batch sample that is only added once. This section is divided into two (based on the method of measurement of sludge accumulation rate) and presents the findings of the field trials conducted to test the effect of direct application of pit additive on sludge content in pit latrines. The first section discussed the findings of the field trials for testing the efficacy of pit latrine additives using the infrared laser distance measure while the second section discussed the findings based on the use stereographic imaging technique.

**Table 7.1** presents the pit latrine additive dosing schedule for the field trials. For easy comparison between the laboratory trials and the field trials, the additives were identified as Product A and Product B as for the laboratory trials. Product A was tested on eight pit latrines selected randomly from the community and Product B was also tested on eight pit latrine selected randomly from within the community, making a total of sixteen pit latrines which had additive treatment. All pit latrines were dosed according to the recommended dosage given by the manufacturers. **Table 7.2** presents a summary of the different treatments allocated to the thirty experimental pit latrines. The method for addition of pit additives and measurement of the volume change is presented in **Section 3.2.3**.

**Table 7.1: Pit latrine dosing schedule for the field trials as recommended by the manufacturers (Bakare *et al*, 2010)**

Additive	Recommended dosage
A	Pour 10 litre of water into the pit before adding the additive 200g every second month
B	2 table spoon into 10 litre bucket of water and add on a weekly basis

**Table 7.2: Allocation of treatments to 30 experimental pit latrines (Bakare *et al* 2010)**

Pit Number	Treatment
1-8	Product A
9-16	Product B
17-23	Water Reference
24-30	Control

**Figure 7.4** shows the preparation of the additives before application to the pit.

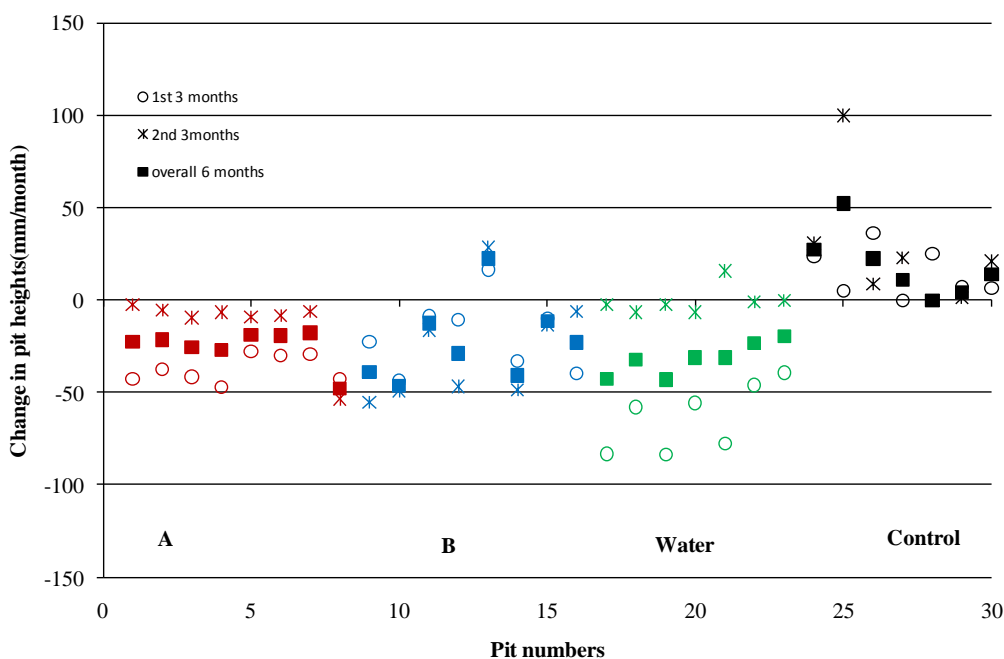


**Figure 7.4: Preparation of Pit latrine additives for application to Pit Latrine (Bakare *et al*, 2010).**

### **7.3.1 Field trial results using the infrared laser distance measure**

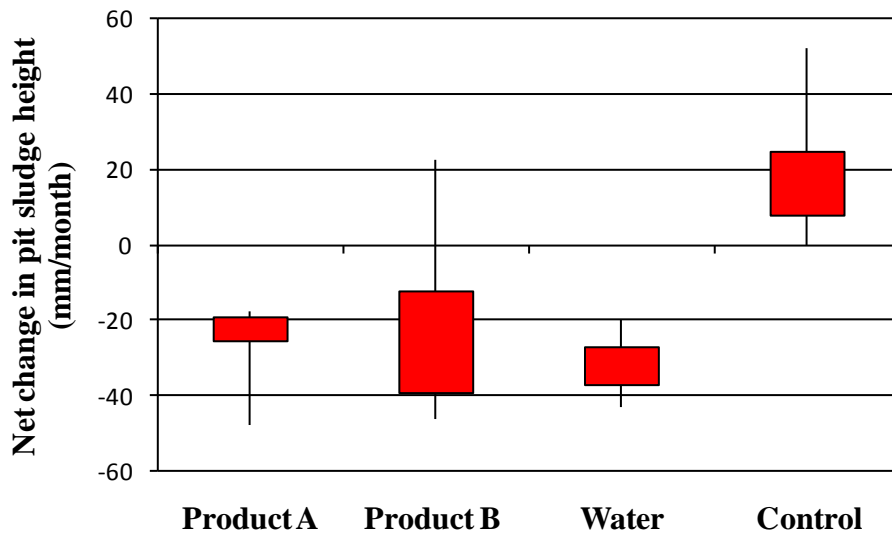
The sludge reduction results for each of the treatments of the field trials using the infrared laser distance measure are presented in **Figure 7.5**. The first three months showed a net

decrease in height across all treatments except for the control which showed a net increase in height. The consistent increase in height shown by the control pits was expected because these pits were in use and no additives or water had been added to them. However, it was observed that there was no significant decrease in height across all treatments after the first three month till the end of the field trials and that for the control pits; the increment in height was not significant across all pits for the entire duration of the field trials. There was no significant difference between the height changes ( $p>0.05$ ) for the pit in which additives was added and water reference pits, indicating that the additives did not significantly influence the height change.



**Figure 7.5: Change in pit latrine sludge height for all the treatments for the field trials using the Laser tape measure**

Thus, for proper comparison between the additive treatments, water treatment as well as the control, the measured change in height for each of the treatments were averaged and the 95 % confidence interval on the mean were calculated. The results are presented graphically in **Figure 7.6**.



**Figure 7.6:** Box and Whisker plot showing change in height of pit latrine contents over a period of 6 months for the field trials using the infrared laser distance measure. The box for each data set represents the range of the 95 % confidence interval on the mean, while the whisker shows maxima and minima from within each data set.

For the duration of the field trials as shown in **Figure 7.6**, a net decrease in pit contents height was observed although the changes observed were small and close to the tolerance of the laser distance measure under field conditions. It is interesting to observe that the reference treatment where only water was added to the sludge content of the pit latrines showed significant differences statistically when compared to the other three treatment using ANOVA. This field trial results suggest that the use of pit latrine additives do not bring about a reduction in pit sludge contents. However, pit latrines in which water was added showed a reduction in the height measured for pit sludge content. The field trial results did not show whether the apparent reduction in pit latrine contents volume was due to flattening of the pit contents through water addition such that the overall reduction in volume was negligible or through enhanced biological degradation rates as a results of the water added. What the field trial results do show is that no apparent reduction in the rate or volume of pit latrine sludge was observed due to the treatment with pit additives. A

summary of the average overall sludge height reduction results for each of the treatments of the field trials using the laser distance measure are presented in **Table 7.3**.

**Table 7.3: Overall sludge height reduction results for the field trials.**

<b>Treatments</b>	<b>Time Interval</b>	<b>Measurements from the pedestal down to sludge surface</b>
Product A	Start	1300 mm
	Finish	1450 mm
	Loss	150 mm over the entire duration of the field trials
	Rate	25 mm/month
Product B	Start	1500 mm
	Finish	1630 mm
	Loss	130 mm over the entire duration of the field trials
	Rate	21.7 mm/month
Water Reference	Start	1540 mm
	Finish	1730 mm
	Loss	190 mm over the entire duration of the field trials
	Rate	31.7 mm/month
Control	Start	1500 mm
	Finish	1350 mm
	Gain	150 mm over the entire duration of the field trials
	Rate	25 mm/month

### **7.3.2 Field trial results using stereographic imaging technique**

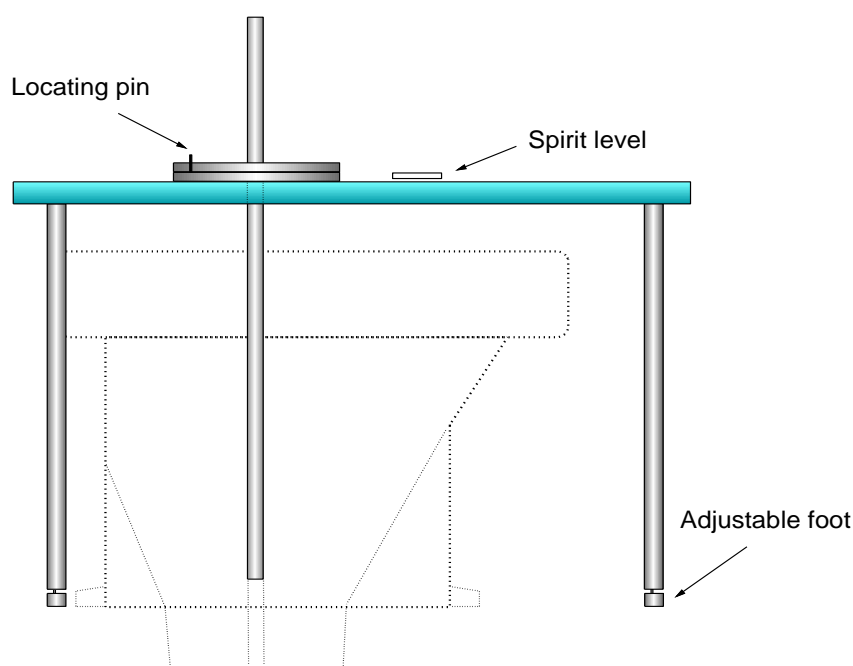
The use of the stereographic imaging techniques involved mapping the surface of the pit latrine sludge contents to provide a basis for the calculation of the rate of volume change in pit latrines. It was proposed by Buckley *et al* (2008) that a stereographic imaging technique for measuring the sludge level in pit latrines is a more accurate method for determining sludge accumulation rate than previously reported methods such as measuring with a string and stone or lowering a long metal rod down the pit. This is



because the sludge content in pit latrines are not level but often have an irregular pyramidal shape; thus measuring the sludge level at one or two points using either the laser distance measure, a string and stone or a long metal rod might not give a clear indication of the volume of the sludge content in the pit latrine.

### 7.3.2.1 Principle of the stereographic imaging technique

The stereographic imaging technique uses a pair of stereoscopic digital photographs to measure the spatial coordinates of any number of points on the surface of the sludge in the pit latrine. These points are then used to map out the shape of the surface of the pit content in three dimensions. Normally, there is no need to open the pit; the digital camera may be lowered on a supporting boom through the toilet pedestal. The boom is supported by a structure which can locate the camera precisely and reproducibly in the same position on subsequent visits to the same latrine. **Figure 7.8** shows the supporting system for the photographic equipment.

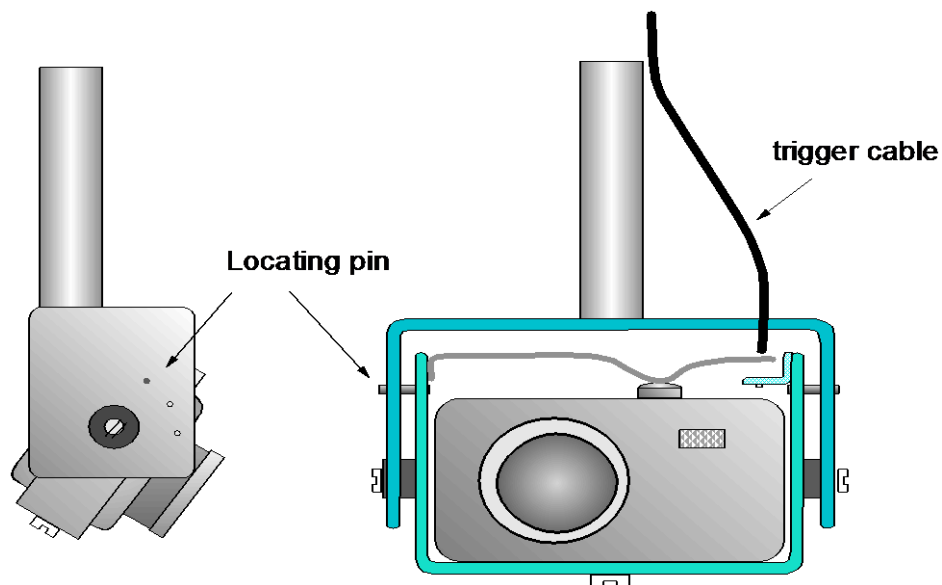


**Figure 7.7: Supporting System for the Photographic Equipment.**

The camera boom is supported by a table with three legs which can be accurately levelled. The camera boom can be rotated to several positions which have been preset and can be locked by a locating pin. On every visit the floor was marked with a dot of paint at each

foot of the supporting table to ensure that for subsequent visits the supporting table is placed at the same position. The camera is supported at the end of the boom as shown in **Figure 7.8**. The camera support system allows the camera to be tilted at a few preset angles to allow imaging for different levels in the pit. A trigger cable allows the photograph to be initiated from outside the pit. 8 images were recorded for each pit; two photographs are taken on each of 4 sides (forwards, backwards and to either side) and the two images are horizontally displaced at a known distance.

The pictures taken were downloaded to a computer which were analysed using a program developed in Matlab. Analysis of the images was performed by selecting a series of matching points on each pair of stereographic images. A triangulation algorithm was implemented to determine the distance of each of the identified points from a reference position (at the same height as the camera). The whole procedure is calibrated beforehand by images of a surface where the positions of the points are precisely known (e.g. graph paper attached to a flat surface). Preliminary calibrations indicated that points on a surface 300 mm from the camera are located within a tolerance of about 0.7 mm when the displacement of the camera between images is 10 mm.



**Figure 7.8: Camera Supporting System.**

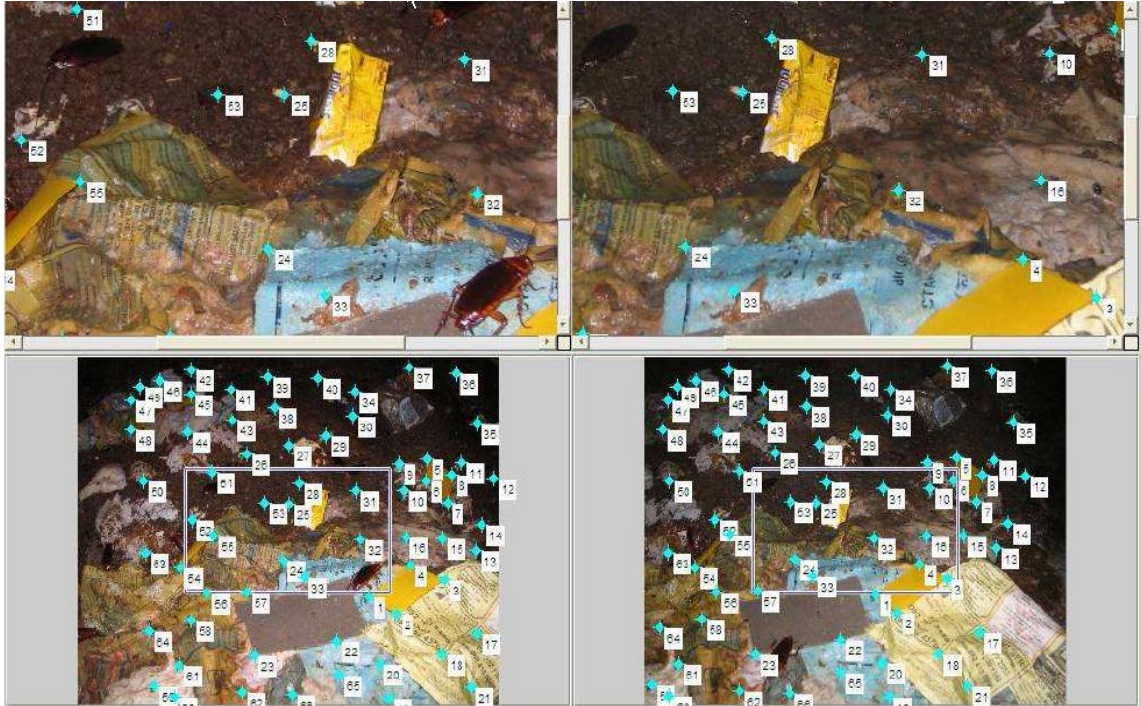
The triangulation calculation projects a line from the camera position to the selected point for each of the two stereographic images. Theoretically, the physical location of the object can be determined by calculating where the two projected lines intersect i.e.

at what distance from the camera and in what direction. The lines from each camera to any target point must in reality intersect at the target point, but due to measurement errors the projected lines may not intersect. Thus the triangulation calculation finds the point of closest approach between the two lines projected from the camera positions to the target. To do this, one determines the equations of the lines from the angles of the target point from the camera axes, the positions of the cameras and the orientations of the camera axes. From these equations one derives an expression for the distance between any two points on the two lines, and solves for the pair of points for which the distance is minimal. The best estimate of the position of the target point is midway between these two points, and the length of the line joining the closest approach points gives an estimate of the error in determining the position.

The camera positions are  $[x_1, y_1, z_1]$  and  $[x_2, y_2, z_2]$ . The directions in which they point are each defined by 3 angular coordinates  $[\alpha_1, \beta_1, \gamma_1]$  and  $[\alpha_2, \beta_2, \gamma_2]$  which describe the rotations of the camera axis about the X, Y and Z axes (in that order). The unrotated camera axis (i.e.  $[\alpha, \beta, \gamma] = [0, 0, 0]$ ) is in the direction  $[0, 1, 0]$ . **Figure 7.9** shows a single image of the surface of a pit latrine indicating the back side, left side, front side and the right side in the pit latrine. When the pictures are taken and downloaded on the computer, points are selected in order to perform the triangulation calculations, an example of stereographic images of a pit surface showing how the points are selected for triangulation calculations is presented in **Figure 7.10**.

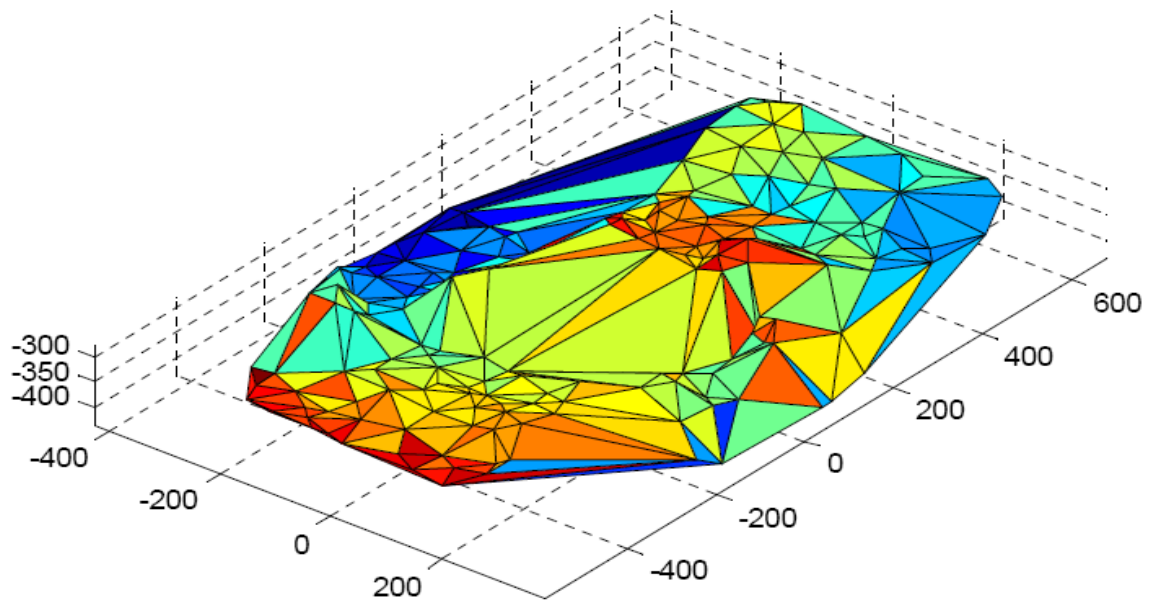


**Figure 7.9:** Single images of the pit surface (Clockwise from the top left: Back; left side, forwards, right side of pit).



**Figure 7.10: Stereographic images of a pit surface showing the points selected for triangulation calculations**

After the points had been selected, the map of the sludge surface is then generated as shown in **Figure 7.11**.



**Figure 7.11: Surface Map generated by Triangulation of selected points on the images.**

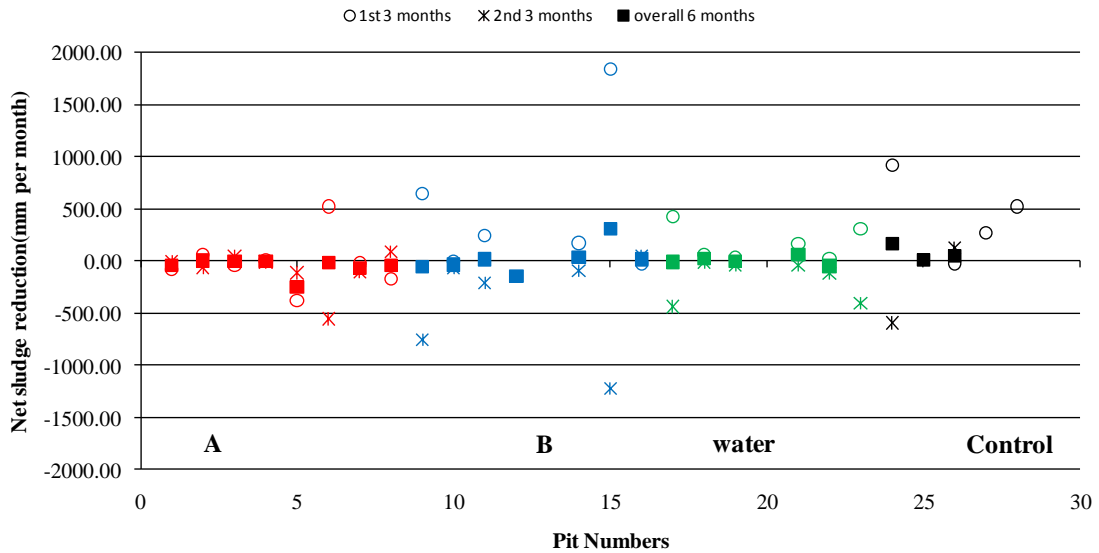
However, the camera measurement techniques used in the pit additive study showed some difficulties in that it was very difficult to shift the camera between the two positions reproducibly with sufficient accuracy. Although the movement at the platform from which the camera is suspended is accurate, because of the length of the suspending pole, very slight changes in angle are magnified in their effect on the camera position and orientation. Also, the levelling mechanism for the platform does not have a sufficient range of adjustment to cope with the very uneven floors that are often encountered. It is usually not possible to determine from a pair of pictures whether the relative alignment of the camera was correct because this can only be done when the pictures are being analyzed back at the university.

It was also discovered after the generation of the images similar to that presented in **Figure 7.11** that the camera was unable to see all points in the pit latrines investigated and as such some sections of the surface were not mapped especially at the highest point of the pile and in the corners. This may significantly affect the accurate calculation of the volume of sludge pile in the pit latrines indicated. However this observation does not refute the initial hypothesis that a detailed surface map of the pit contents is required to accurately quantify the amount of sludge within a pit at various time intervals. What this has shown is that apart from the intensive labour required, the stereographic methods have various limitations. A more sophisticated method of scanning the surface of the pit contents is required and an improvement would be the use of a scanning device. A project investigating the use of such a device has been initiated. For these reasons the average depth generated from the matlab program developed is as good a measure of change in pit contents height as compared to a detailed volume calculation.

#### 7.3.2.2 Obtained Results

The result of the net sludge reduction per month in all the pits using the stereographic imaging is presented in **Figure 7.12**. Statistical analysis (ANOVA) was performed to determine if net sludge reduction occurred in any of the pits during the trials. The results showed that there was no significant difference between all four treatments ( $p > 0.05$ ) throughout the entire duration of the field trials. For the selected pits which

served as the control in which no additive or water was added to the sludge content, it was observed that there was an increment in sludge content in the selected pits but the increments observed were statistically insignificant.

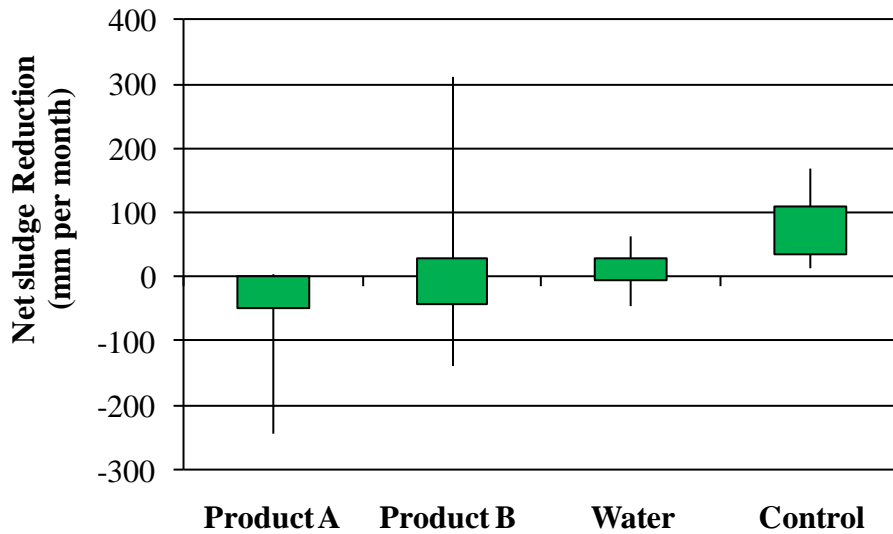


It should be noted that some data points are missing in the above plot since:

1. During the course of the trials some pit latrine became so full that the camera could not be lowered
2. There was a case in which the owner of the pit died and pit was locked up

**Figure 7.12: Net sludge reduction for all the treatments for the field trials using the Stereographic method**

The net sludge reduction obtained for each additive treatment and the reference treatment (water addition and Control) was also averaged and the confidence intervals on the mean were calculated. The results are presented graphically in the Box and Whisker plot in **Figure 7.13**. These data indicated that there was no significant difference in the net sludge reduction in all treatments using the stereographic method. This contradicts the result obtained using the infrared laser distance measure where it was observed that there was significant reduction in sludge height in pit latrines in which only water was added compared to the pit latrines in which additives were added and those in which nothing was added (control). Thus, it could be concluded that the reduction in height observed in the field trial based on 3 distance measurement is an indication of pyramid flattening of the surface of sludge content in the pit by the addition of water onto the highest part of the pile since the stereographic method did not indicate a similar change.



**Figure 7.13:** Box and Whisker plot showing Net sludge reduction pit latrine contents over a period of 6 months for the field trials using the Stereographic methods. The box for each data set represents the range of the 95 % confidence interval on the mean, while the whisker shows maxima and minima from within each data set.

#### 7.4 DISCUSSION OF RESULTS

The purpose of this chapter was to investigate the efficacy of pit additives on pit latrine sludge content. Two trials were conducted to investigate the efficacy of pit additives for controlling sludge accumulation rates and/or reduction of sludge volume in VIP latrines on a laboratory scale and in the field. Because of the heterogeneous nature of sludge samples from VIP latrines, the results obtained from the laboratory trials showed a wide distribution in the rate of mass loss for all the four treatments. However, there was no systematic and statistically significant change in the rate of mass loss on sludge samples in which both additives were applied. Thus the results obtained from the laboratory trials showed no evidence that the use of pit additives had any effect on the rate of mass loss in pit latrine sludge.

The field trials involved two different method of measurement to quantify the effect of pit additives on sludge content in the pit. The first type of measurement was based on the use of infrared laser distance measure to measure the changes in height in VIP latrine sludge content over the entire duration of the field trials while the second

measurement was based on the use of stereographic images to map the surface of the sludge content in VIP latrines in order to be able to properly quantify any change in the volume of the map surface over the entire duration of the field trials.

The results obtained from the use of infrared laser distance measure showed considerable variation from pit to pit. This might have been due to the variation in the design of the pit, age of the pit, number of users, volume of sludge in the pit and the ambient conditions of each VIP latrine. However, the data obtained indicated that there was no statistically significant reduction in sludge accumulation rate due to the treatment with pit latrine additives. What the data suggests was that lowering in height or in the rate of height increase in a VIP latrine could be achieved by the addition of water either by washing away soluble components or by improving conditions for sludge degradation by increasing the moisture content of the sludge in the pit. However similar results were not obtained in the laboratory trials. This implies that the decrease in the height of VIP latrine sludge content in the field trials due to the addition of water can probably not be explained completely as a result of increasing sludge degradation rates since this explanation would have resulted in higher mass loss rates in the laboratory trials. Thus, pyramid flattening of the surface of sludge content in the pit by the addition of water onto the highest part of the pile and an increase in leaching of soluble components from the pit might be the cause in the apparent reduction of sludge accumulation rate in the VIP latrines.

The results obtained from the stereographic method used to take measurement during the field trials showed that there was no significant difference statistically in the volume accumulation rate of pit sludge due to the use of pit additives for treatment of pit sludge content as compared to the reference treatment (water and control), however caution need to be applied in interpreting this result because of the reported limitations of the measuring technique.

Thus the pit additives tested in these trials supported the findings of previous studies (Sugden *et al*, 2006; Buckley *et al* 2008) that pit latrine additives do not assist in reducing pit filling rates and sludge volumes. However, the findings do not indicate that all pit additives are not effective only that those tested in this study did not reduce



sludge accumulation rate. The development of pit additives is based on the assumption that degradation of sludge in pit latrines is not already taking place effectively within the pit. The following explanation suggests the possible reasons why pit additives tested in these trials might not have shown any significant effect on pit sludge:

- The characteristics of VIP latrine sludge presented in **Chapter 5** indicated that less than 30 % on average of the sludge content in a pit latrine is biodegradable and that only the surface layer of the pit contains a significant proportion of the biodegradable material while the materials buried well below the surface layer of the pit are comprised largely of the non-biodegradable components of the sludge in a pit. Hence, the residual biodegradability of material beneath the surface layer of the pit content is significantly lower when compared to the material at the surface layer of the pit. Thus, the addition of pit latrine additives to pit sludge content would not have any significant effect in reducing the mass or volume of the bulk of the buried material through biological degradation.
- The failure of the pit latrine additives to accelerate the degradation of pit latrine sludge content might be as a result of the fact that the amount of micro-organisms added in a single dose of pit additive was insignificant compared to the amount of micro-organisms naturally present in the sludge.
- It was observed both during the sampling of sludge for the laboratory trials and during the field trials that a significant amount of solid waste was found in VIP latrines. The presence of non-degradable solid waste in VIP latrines is a very significant problem because biological activity has no influence on the volume of this fraction. Thus, the addition of pit latrine additives to such a pit will similarly be unable to degrade this fraction.
- If assumed that pit latrine additives actually reduce sludge accumulation rates or amount of material in the pit (although this present study and previous studies conducted by Buckley *et al*, 2008 confirms they do not) , addition of pit latrine additive can only slow the rate at which the pit latrine fills up and not stop the pit from getting full. Financially, the use of pit latrine additives to either enhance biological degradation, reduce mass or volume of pit latrine sludge is

not economically viable. A typical additive treatment for a pit costs ZAR 20 per month (which can even be much more depending the product) and over five years this will come to a total cost of ZAR 1200 without interest or ZAR 1500 including interest. However, a pit latrine can be completely emptied and the sludge content disposed using manual or mechanical methods for approximately R 1500 (200 USD) (WRC 2012). This calculation does not take into consideration the large volume of water required to mix the additive product before pouring into the pit as prescribed by majority of the manufacturers of pit latrine additives.

## 8 DISCUSSION AND IMPLICATION OF FINDINGS

---

---

The main focus of this research was to provide scientific support for decision making in management of accumulated sludge in ventilated improved pit latrines during their life span and when they reach their capacity under South African conditions. More precisely, the research presented in this thesis aimed to provide information about what approaches could be used to manage accumulated sludge during the operation of the pit and when the pit latrines become full. The two main issues related to the provision of pit latrines as identified by the literature reviewed were; (i) the difficulty of getting accumulated sludge out of the pit, and (ii) the problem associated with suitable disposal routes once sludge from pits are exhumed. Most of the available literature deals with issues related to the civil and mechanical construction of the pit latrine and superstructure. There is very little knowledge on the processes occurring within a pit; neither is there adequate understanding of what the condition of the material in pits will be when the pits become full. An understanding of the processes occurring within the pit during their life span and the nature of material that is dug out of pits will facilitate better management of the pit sludge and provide the required information needed in identifying suitable disposal routes for the accumulated sludge upon emptying. This study was limited to two approaches: (i) deep row entrenchment of pit sludge for agroforestry and (ii) use of pit additives to enhance sludge accumulation rate in pit latrines. However as a background and in order to understand what is happening in these studies and the nature of pit sludge, an idea of sludge accumulation rates in pit latrines (for providing an indication of the extent of sludge stabilization in pit latrines and comparison with additive treated pit accumulation rates) and characteristics of pit sludge (for understanding the starting material for pit additive trial and deep row entrenchment studies) was required.

Thus in this chapter, the implications of the field and experimental results are discussed to provide new insights gained from the research conducted. This chapter is therefore divided into four sections. The first section discussed the implication of the findings on the study conducted on sludge build up in pit latrines. Aspects of processes in pit

latrines/pit latrine sludge characteristics are dealt with in the second section. The third and fourth sections discussed the implication of the findings on the study conducted on deep row entrenchment of pit latrine sludge for agroforestry and efficacy of pit latrine additives respectively.

### **8.1 SLUDGE BUILD UP IN VIP PIT LATRINES**

Sludge build up in VIP latrines is determined by the amount of material entering the pit, the rate and extent to which this materials degrades and the conditions in and around the pit. A review of the available literature showed that sludge accumulation rate in VIP latrines ranges from 10 ℓ/person·year up to 120 ℓ/person·year or more. Norris (2000) estimated the accumulation of sludge in pit latrines at 25 ℓ/person·year in a study which was conducted in Soshanguve, Gauteng. At this rate a family of 6 would accumulate 150 ℓ/year, and hence a 2.5m<sup>3</sup> pit would last approximately 17 years. However from the literature on sludge accumulation rates, there is quite a wide range of data on sludge accumulation rate but the details of the data collection are not known, including how the sludge accumulation rate in pit latrines was measured and how the information on number of pit users was collected.

Therefore it is not known whether different data subsets are comparable, and whether the data is reliable. Therefore, in this present study it was found that there is some value in conducting a very controlled study to measure sludge accumulation rate where the data is defensible and compare the results with values presented in literatures. The sludge accumulation rate data obtained in this study was between 120 and 550 ℓ/ year with an average of  $282 \pm 46$  ℓ/year for the thirty pits investigated. Therefore for an average of 5 people per household obtained in this investigation, this corresponds to a per capita sludge accumulation rate of approximately 56 ℓ/person·year. At this rate, a family of 5 and an average pit volume of 2.5m<sup>3</sup> pit investigated in this study would last for approximately 9 years.

Based on the 80<sup>th</sup> percentile value of obtained sludge accumulation rate on a per pit basis in this study it could be proposed that when sizing new pit latrines sludge accumulation rate of 400 ℓ/year could be an appropriate value for use. This value

corresponds to a per capita sludge accumulation rate of 80 ℓ/person·year for an average value of 5 people per household obtained in this investigation. This value corresponds well with the 80<sup>th</sup> of the amalgamated data presented by Still *et al* (2012) in which the 80<sup>th</sup> percentile value is 453 ℓ/year. Based on the statistical analysis performed it was found that there is no correlation between per capita sludge accumulation rate and the reported number of users for both the amalgamated data of Still *et al* (2012) and the data obtain in this study. This was attributed to the fact that reported number of pit users does not reflect the average use patterns of pit users and that when an approximately constant property (per pit sludge accumualation rate) is divided by an increasing property, the result is a decreasing property.

Apart from generally presenting and interpreting the data describing the rate at which sludge accumulates in VIP latrines, this investigation conducted has in particular provided an understanding of what happens to the materials which are added to the pit and what the likely characteristics of the material in the pit will be when emptied. It has been widely documented that the number of users plays a key role in the rate at which sludge accumulates in a pit. As presented in the literature (**Section 2.2.1.1**), an individual produces a total volume of around 550 litres of excreta per person per year. Added to this volume is anal cleansing material (toilet paper, news paper or other materials) and if a reliable solid waste collection is not available, the VIP latrine is also likely to be used for the disposal of other household solid wastes. It is expected that liquids containing soluble materials may leach out from the pit and biodegradable materials within the pit would degrade.

Thus, based on the obtained sludge accumulation rate (56 ℓ/person·year) and on the assumption that the volume of solid materials added to the VIP latrine is the same as presented in the literature (110 ℓ/person·year), suggests that depending on the volume of other materials added to the pit, between 25 to 50 % of the volume solid materials added to the pit by an individual per year eventually accumulated as sludge despite the fact that the pit had only been in use for 3 years from when last emptied. This clearly indicates that certain processes which naturally occur within pits result in sludge volume reduction. These processes have been categorized in **Chapter 2** to be physical and biological processes. Thus it is evident from this investigation that the mechanism

of sludge stabilization and/or reduction within a pit could be mainly attributed to biological processes which do occur naturally in the pit because the findings of the laboratory batch experiment presented in **Chapter 4** indicated that about 17 to 64 % of the original mass of pit sludge used in the experiment was reduced over 230 days in which the experiment was conducted and this was attributed to biological stabilization of the sludge taking place.

In the case where VIP latrines are to be designed by government, municipalities or NGOs where households will not be responsible for emptying of their VIP latrines, it is recommended that the pit latrine should be designed around the emptying cycle. It should also be noted that larger pits are always very difficult to build, require specialized equipment and professional pit emptiers who are then subject to a high risk of helminth infection since pit emptiers often have to climb right into the pit to empty the lower part of the pit. Hence, if there is no capacity for an organized pit emptying program, building of shallow pits should be considered because this will enable the householder to be able to empty their own pit. If there is adequate capacity for an organized pit emptying program the pit size should be determined based on the frequency with which the pit would be emptied. However depending on the time-frame set up for each pit emptying cycle, that would determine how often pit emptiers would be exposed to pit sludge and this could give rise to high risk of exposure to pathogenic organisms if the time-frame is not long enough. Even if the time interval between subsequent emptying is long enough, each time a pit is emptied there is an extremely high risk of helminth infection for pit emptiers and householders.

Thus the selection of pit size should depend on what factor is considered to be most important. Thus it is recommended that;

- If reducing the risk of exposure to pathogenic organisms is considered to be the most important factor, larger pits should be considered because this reduces frequent emptying of the pit and lowers the average time of exposure to pathogenic organisms.
- If ease of emptying is considered to be the determining factor during pit sizing, then building of shallow pits could be considered.

In the laboratory batch experiments, it was observed that by increasing the moisture content the rate of degradation of sludge samples decreases. Over the 230 days batch laboratory experiment, mass loss was inversely proportional to total moisture content, it was found that the mass of solids was reduced to somewhere between 17 and 64 % of the original sludge mass. The calculated mass loss rates observed is expected to be higher than that which will be observed in a pit because the batch laboratory test had continuous air exposure but pit contents are usually covered over by new materials added to the pit. Thus the finding from this batch laboratory experiment suggests that the rate of degradation decreases with increasing moisture content. This could be attributed to the settling of sludge samples with a layer of liquid above it, thereby creating anaerobic conditions as results of reduce oxygen contact with the sludge. If this is the case, then it is expected that when the sludge is fully stabilized under this condition, sludge samples with high moisture content would stabilize at a slower rate with lower residue solids compared to samples with lower moisture content. However, this was not observed when the experiment was terminated and could mean that the experiment should have gone on for an extended period of time.

Thus it could be concluded from this study that:

- Natural stabilization of sludge in pit latrine does occur and,
- Both the sludge accumulation rate study and the laboratory batch experiment did not provide evidence that it is possible to achieve a lower residual solids volume or mass at a faster covering rate or high moisture. Therefore, there is no evidence to suggest that designing a pit to adjust conditions of the digestion will have a significant effect on the accumulation rate.

## **8.2 CHARACTERISTICS OF PIT LATRINES SLUDGE CONTENT**

Approximately 80 % of the organic material in faeces deposited in a pit is said to be biodegradable and of this 30 % is bacteria (Buckley *et al*, 2008). The characteristics of the materials deposited in the pit will have significant effects on the type and extent of the biological activity taking place within a pit and the type and extent of the biological activity taking place within the pit will have significant effect on the characteristics of

the sludge contents within a pit. How efficiently and rapidly these biological processes happen depend on factors such as temperature, pH, moisture and oxygen. Fungal organisms and other biota such as maggots, roaches and worms in the pit also play a role in making the organic material more amenable to bacterial break down (Kele, 2005). It was hypothesised that significant biological stabilization occurs within a pit with time, such that further biological treatment of sludge dug out of pits is not appropriate. This is supported by previous research conducted that suggests that significant degradation does occur within the pit (Buckley *et al*, 2008; Nwaneri, 2009).

In this present study it was found that biological stabilisation, otherwise described as the degradation of biodegradable components, occurs in a section of the pit contents that extends from the surface down to a point corresponding with material deposited some years previously, but below this section, the material has reached a composition that does not degrade with time. Physico-chemical analyses of pit latrine contents at different depths in the pit produce profiles for COD concentration, fraction of volatile solids and biodegradable COD that correspond well with the Buckley *et al* (2008) theory of processes in pit latrines and therefore may be regarded as evidence in support of this theory.

From the results of the characterization of pit latrine sludge content, the following understanding of the nature of sludge in pit latrines is presented:

- The result indicated that significant stabilization of material added to the pit does occur and the longer the sludge residence time in the pit the more stabilized the sludge within the pit becomes.
- Characteristics of pit sludge content vary from pit to pit and within a pit, significant variations exist at different depths within the pit. This depends on several factors, however the extent of the degradative process taking place and the residence time of the material in pit are the main determining factors. Sludge content at the surface layer usually contained a significant portion of the biodegradable material and below this layer the amount of biodegradable material decreases as one digs down the pit.



- When a full pit is emptied, the sludge would consist of oldest and most fully stabilized material at the bottom of the pit and newest, least stabilized material at the top of the pit. Thus the mixed pit contents have a mixture of well-degraded and poorly degraded material.
- The degree of stabilization of pit latrine sludge samples analyzed in this study indicates that several of the proposed disposal options for pit latrine sludge content are not appropriate.

Based on the findings of this study as well as a parallel study conducted by the Pollution Research Group UKZN (2011) in WRC (2012) to determine the health risks associated with VIP latrine sludge, sludge content from VIP latrines which is still in use can be classified based on the new system of classification of sludge presented in **Table 2.4** as follows:

- Microbiological class C – potentially contaminated with faecal coliforms and helminth ova.
- Stability class 2 – fairly stabilised or with considerable vector attraction reduction.
- Pollutant class a – no potentially toxic metals and elements.

It was also observed during the emptying of pit latrines used for this study that many households dispose their refuse into the pit latrine especially if there is no available service for refuse collection. This increases sludge accumulation rates as refuse is often not degradable within the pit. However, the most serious consequences of this are difficulties encountered during the emptying of such pit latrines. It is therefore recommended that households are properly informed and educated about the consequences that could result from disposing of solid waste in their pits and also appropriate educational programmes should be made available when toilets are first installed or when they are emptied for the first time.

Thus based on the findings on the characteristics of pit latrine sludge obtained in this study, the feasibility of any treatment and/or disposal options for pit latrine sludge

would largely depend on the inherent ability of the chosen option to accept the load of solids and organic material in VIP sludge, the residual biodegradability of the VIP sludge and associated health risks.

### **8.3 DEEP ROW ENTRENCHMENT FOR AGROFORESTRY**

Options that require the removal of sludge from the pit and transported to where it is meant to be disposed of are limited by the characteristics of the VIP latrine sludge and must be managed in a hygienic and environmentally safe way. Also due to the high pathogen content of VIP latrine sludge, human contact with the sludge must be strictly limited. In a study conducted by Bwapwa (2011) on anaerobic digestion of VIP latrine sludge in an anaerobic baffled reactor, an accumulation of inert solids was observed in the reactor and the methane yield was negligible. The study involved the digestion of VIP latrine sludge in a laboratory scale anaerobic baffled reactor of 100 ℓ/d capacity. The reactor was supplied with synthetic wastewater made up of VIP latrine sludge and tap water. The findings from this study were similar to the same problems encountered as in the case of the disposal of VIP latrine sludge in wastewater treatment plant, that is, there was little biological treatment of the VIP sludge, and both options resulted in a dilute solids problem. Thus it could also be concluded that this treatment options which is basically meant for the treatment of unstabilised human waste have no benefit from a treatment perspective, and implies that a concentrated contaminated solid is turned into diluted contaminated slurry which is a bad sludge management practice.

Other options for the treatment and/or disposal of pit latrine sludge have been identified and the main issues related to these options have been discussed in **Chapter 2**. Of all the options identified for the treatment and/or disposal of pit latrine sludge, deep row entrenchment of pit latrine sludge for agroforestry seems to be a promising idea. However, there is only information of how this process applies to sewage sludge. It was not clear whether the same results will be obtained for pit sludges, because the difference in nature between pit sludge and sewage sludge is not clear.

Thus the applicability of deep row entrenchment of VIP latrine sludge for agroforestry was investigated. The overall aim was to determine whether deep row entrenchment of

VIP latrine sludge was a feasible option for sludge disposal or reuse since it did not depend on significant stabilization occurring in the ground but rather depended on the fact that the sludge was already fairly well degraded. The specific objectives were to observe changes in the characteristics of entrenched sludge over time as well as to investigate if there is any migration of pollutant from the sludge into surrounding ground water. It was expected that if significant stabilisation of the sludge in a pit does occur within the pit, then the pit contents dug out of the pit for entrenchment should be relatively stable but contain certain amounts of nitrogen and phosphorus which might be available as plant nutrients without causing a negative environmental impact.

According to Jönsson *et al* (2004), burial of sludge increases the organic content of the soil, which enhances the moisture retention characteristics, ion-buffering capacity and generally increasing the fertility of the soil. It has been documented that in plantations the trees planted draw the available water within the surroundings into the plantation area to supply the water requirements of the trees (Dons, 1987 and Duncan, 1993), therefore planting of trees near the entrenched VIP latrine sludge may have an added advantage, in that the presence of the trees will result in a net movement of water into the burial site to supply the water requirements of the trees. Thus planting trees next to the buried sludge should result in a lower risk of contamination of ground and surface water in the vicinity caused by nutrient and pathogen release from the buried sludge.

In addition, entrenchment of VIP latrine sludge in soil might result in a greater degree of stabilization than can be achieved in the pit latrine. The logic behind this proposition was that field studies of pit latrines indicated that stabilization of sludge in pit latrines that are no longer in use apparently occurs from the soil/sludge interface inwards (Morgan, 2004). This could be attributed to the action of soil fungi. In soils, soil fungi contribute significantly to the biodegradation of organic material. Various studies have demonstrated that the presence of organic matter in soils or organic fertilization of soil has a positive influence on the soil fungi population (Abbott and Murphy, 2003). This is because the soil contains air-filled voids which are essentially different to sediments; bacteria motility in soils is restricted due to the inability of the unicellular body form of bacteria to bridge these air-filled voids (de Boer *et al*, 2005). The hyphal/mycelial growth form of soil fungi makes it possible for soil fungi to bridge these air-filled voids

and as such motility of fungi in soils are not restricted (Griffin, 1985). Fungi hyphae also have a greater ability than bacteria to translocate nutrients within the soil (Jennings, 1987). Interestingly, the hyphal growth form has also been developed by certain soil bacteria known as the actinomycetes however heterotrophic processes and the degradation of recalcitrant organic compounds taking place in the soil are dominated by fungi (de Boer *et al*, 2005; Griffin, 1985; Taylor and Osborne, 1996). According to de Boer *et al* (2005), the two important processes which are the formation of mycorrhiza and the decomposition of lignocelluloses within the terrestrial ecosystem are dominated by fungi and therefore, the functioning of the terrestrial ecosystem relies significantly on fungi.

Soil fungi are microscopic plant-like organisms which are the most important and diverse class of soil organisms (Abbott and Murphy, 2003). Soil fungi have the ability to decompose virtually all organic matter, recycle nutrients, make use of the hyphal mantle spread over the surface of the roots to provide protection against the pathogenic entry into plant roots, and the hyphal network in soil surroundings roots enhances water uptake from the soil (Abbott and Murphy, 2003; Smith and Read, 1997). Soil fungi grow best in moist but well aerated soil conditions with pH near neutral (Abbott, 2003). Conditions within a pit latrine (mostly anaerobic with fluctuations in sludge pH, significant moisture, little or no air and possibly the presence of biocidal chemicals and other materials added to the pit) makes it impossible for fungi to survive in the pit latrine. It is proposed that lignocellulosic cell components that can only be broken down by certain species of fungi cannot be degraded in a pit latrine, but might be biodegradable in the presence of soil fungi.

From the investigation conducted on the applicability of deep row entrenchment for agroforestry it was found that:

- There was a statistically significant difference in the characteristics of the sludge that arrived at the site before burial and sludge exhumed from trenches at varying time interval. Significant reduction in measurements of moisture, volatile solids, chemical oxygen demand, and aerobic biodegradability of VIP latrine sludge samples were observed for samples of sludge that had been buried

in trenches over time. It was observed that the COD value (0.14 g COD/g dry sample) obtained after 1.5 years of entrenchment was significantly lower compared to the COD value (0.24 g COD/g dry sample) of sludge samples obtained from the bottom layer of a pit latrine as presented in **Chapter 5**. Also it was observed that the volatile solid of 27 % gVS/gTS obtained after 1.5 years of entrenchment of VIP latrine sludge with the average value of approximately 37 % gVS/gTS obtained for VIP latrine sludge collected from the bottom layer of the pit which is said to have undergone significant degree of stabilization. This is an indication that a further biological degradation of pit sludge occurred with time in the trenches.

- Over the three years of groundwater sampling from the boreholes at the entrenchment site, there was no profound effect of sludge entrenchment on the groundwater for the duration in which monitoring was carried out. It was concluded that monitoring of groundwater quality at the entrenchment site would have to be for a significant number of years to be sure that there will be no occurrence of pollution plume. However no pollution plumes was observed in the three years of monitoring and there was no indication that this will occur.
- In a parallel study conducted to investigate the impact of deep row entrenchment on tree growth (Taylor, 2012; WRC, 2012), it was found that in all trials, trees grown above or next to entrenched VIP latrine sludge showed improved growth characteristics compared to a negative control. Thus the enhanced growth of trees observed in this study could be attributed to a variety of possible mechanisms including nitrogen and other nutrients released from the entrenched sludge being biologically available as fertilizer and improved soil water retention characteristics.
- In a parallel study conducted to investigate fate of pathogenic microorganisms during sludge entrenchment (WRC, 2012), it was clear that the exhumed sludge from the VIP latrines contained high loads of infective *Ascaris* ova as well as quantities of *Taenia* and *Trichuris* ova, and the sludge was regarded as extremely hazardous to health. However, after sludge had been buried in

trenches and trees planted many of the helminth ova were still present in the sludge but a significant reduction in the fraction of those ova that are potentially infective was observed. The investigation indicated that significant reduction in potentially viable helminths egg counts occurred as a result of entrenchment of pit sludge and it was concluded that buried sludge would constitute a minimal risk of helminths infection after 3 years of burial.

Thus, one interpretation of the results obtained is that biological stabilization of the sludge occurs in the trenches resulting in a net decrease in COD, VS and biodegradability values with a corresponding reduction in sludge moisture content. Three possible explanations can be given for the reduction in the measured characteristics of the trench samples as compared to the fresh VIP latrine sludge:

- Freshly exhumed sludge from the pit latrine can be said to have much of its organic material as well as its moisture content contained in dead or inactive bacteria and yeast cells. Cell walls and cell membrane are known to be difficult to degrade but certain fungal species found in soils are often capable of degrading these cell walls and cell membranes (Boer *et al*, 2004). Thus, when sludge from VIP latrines is buried in trenches, the sludge might be exposed to conditions which accelerate the breakdown of the recalcitrant cell material due to contact with soil, thereby releasing moisture and biodegradable cell component which may then be easily degraded. Hence, an increase in the degree of stabilization of the sludge is observed with time which results in reduction of the measured characteristics of trench samples as compared to the freshly exhumed VIP latrine sludge.
- A further explanation of the reduction of the characteristics of the trench samples as compared to the freshly exhumed VIP latrine sludge could be related to the fact that when a pit latrine is emptied, a portion of the sludge originates from the surface material of the pit, which is relatively poorly degraded since the residence time of this portion of sludge is less than that of the rest of the pit contents. This portion is mixed with the bulk of the pit sludge, thus despite the long residence time of much of the sludge in the VIP latrine before exhumation, there will be a

portion of relatively fresh faecal sludge in the exhumed material which will then have to be degraded. Thus the reduction in organic content and moisture during entrenchment may be partially attributed to the degradation of this portion of relatively fresh faecal sludge in the trenches.

- The amount of sand that is entrapped in samples taken from entrenchments dilutes the measured concentration of volatile solids and COD. The reduction in biodegradability relative to that measured in the bottom of a pit latrine could not be accounted for by dilution with sand, since addition of sand would dilute both total and biodegradable COD. However, the variance in the method for measurement of biodegradability in pit latrine samples is inherently large, and the measured value (16%) is not much larger than the corresponding value of entrenched sludge after 12 months (15%). Differences for COD, volatile solids fraction and moisture content are significantly lower than the equivalent bottom-of-pit samples but these may be influenced by mixing with sand. Therefore, these results indicate that it is possible that the action of soil fungi can break down pit latrine content further than is achievable in a pit latrine, but the data is not sufficiently precise to prove the action of soil fungi.

It could therefore be concluded that unlike the other proposed disposal options for VIP latrine sludge, deep row entrenchment of VIP latrine sludge for agroforestry was a feasible and potentially beneficial disposal and/or reuse option for VIP latrine sludge. There are a number of advantages that VIP latrine sludge entrenchment for agroforestry has over other methods proposed for VIP latrine sludge disposal, these include;

- Entrenchment of VIP latrine sludge can be handled in batches of varying load making it possible for sludge to be disposed at the same rate at which it is generated by pit emptying. Thus there is no need for storage of sludge and scheduling issues thereby reducing costs and risks of contamination.
- In terms of the stability, entrenchment of VIP latrine sludge eliminate issues of odour and places the sludge out of reach of vectors which allows for vector reduction compared to other methods.

- In terms of microbial risks, entrenchment of VIP latrine sludge dramatically reduces the risks of contact with pathogen. Findings of a parallel study conducted into pathogen survival after entrenchment of VIP latrine sludge for 3 years indicated that significant die off of pathogens had occurred, suggesting that when workers disturb the site at harvest after 7 years, there will not be a risk of infection.
- A final consideration is the presence of rubbish which is typical of pit sludge in South Africa and has proven highly problematic in both the removal of sludge from pits and its disposal. While the presence of rubbish in sludge requires a separation step for disposal to wastewater treatment facilities, with deep row entrenchment it can simply be buried without being extracted from the sludge with no harm to trees planted.

#### **8.4 EFFICACY OF PIT LATRINE ADDITIVES**

There are a number of factors which contribute to how quickly a pit fills up; these factors have been highlighted in **Chapter 2**. However there are many pit additives on the market of South Africa claiming the ability to prevent pits from filling up or reducing the rate at which the pit will fill up. **Chapter 7** dealt with the investigation conducted on the efficacy of pit additives through laboratory and field trials. It was found that neither the laboratory trials nor the field trials provided evidence that the use of commercial pit latrine additives have the ability to significantly reduce either the mass or volume of pit latrine sludge or the rate at which sludge accumulates in a pit. A number of reasons as to why the pit additives used in the study proved ineffective were identified. Apart from the reasons identified, the main reason why to date no pit additives have shown any effectiveness in reducing sludge accumulation rate and/or sludge volumes in pit latrines can attributed to the fact that the amount of microbes introduced to the pit by a single dose of pit additive is insignificant compared to the amount naturally present in the faecal sludge (Foxon *et al*, 2009). However the findings of the laboratory and field trials presented in **Chapter 7** do not claim that all additives are ineffective but stated that the pit additives tested in both the laboratory and field trials conducted did not show any significant difference compared to the controls in



which no additives were added using the specific methods by which the trials was conducted. These findings are in line with other studies that have been conducted to test the efficacy of pit additives (Taljaard *et al*, 2003; Sugden *et al* 2006; Buckley *et al*, 2008).

In any pit additive study, the major findings of such study is to show whether the use of pit additives reduces the volume of pit sludge. It is important to emphasize that the measurement techniques adopted have a strong influence on how the results are interpreted. This is because the surface of pit contents is usually not flattened and it is very critical that the measurement technique be able to accurately determine the change in volume of pit sludge. In this study two measurement technique were used, it was observed that there was significant reduction in sludge height in pit latrines in which only water was added compared to the pit latrines in which additives were added and those in which nothing was added (control) using the infrared distance measure, however, this effect was not seen using stereographic imaging techniques and in the laboratory trial conducted. This could imply that the decrease in sludge level observed using the infrared distance measure due water addition can probably not be explained completely by the effect of increasing biodegradation rate at higher moisture content since the same effect should have been observed with the stereographic imaging technique used in the same pits and also resulted in higher mass loss rates in the laboratory trial conducted. Instead, flattening of the surface of sludge content in the pit by the addition of water onto the highest part of the pile may play a part in the apparent reduction of sludge height observed.

## 9 CONCLUSIONS AND RECOMMENDATIONS

---

---

The outcome of this research has provided information on the processes occurring within a pit and/or nature of pit latrine sludge, the applicability of entrenchment of VIP latrine sludge for agroforestry and the efficacy of pit latrine additives on sludge contents within the pit. The findings of this research can also provide a technical framework for a scientific based approach for the management of ventilated improved pit latrine sludge before and when the pit becomes full in a context, such as South Africa or other developing countries, where there is need to plan for a number of issues related to VIP latrines before these pit latrines reach their capacity.

Research into management of VIP latrines and their sludge contents was undertaken to achieve the following objectives laid out in **Chapter 3**, namely:

- To investigate sludge accumulation rates in pit latrines and a mass balance approach to infer the role of stabilization processes on sludge accumulation rates.
- To identify the mechanism of sludge stabilization in pit latrines and how these mechanisms affects the nature of sludge in pit latrines.
- To determine whether deep row entrenchment of pit latrine sludge for agroforestry has any significant benefits and do not have adverse effects on the environment.
- To investigate the efficacy of pit latrine additives through laboratory and field trials and determine the influence of measurement techniques on measured sludge accumulation rates and/ sludge volumes.

It was hypothesised that (i) significant biological stabilization occurs in a pit latrine with time, such that the disposal/treatment options depends on the inherent ability of the chosen option to accept the load of solids and organic material in the VIP sludge, the residual biodegradability of the VIP sludge, and the health risks (ii) VIP latrine sludge

can be used in deep row entrenchment for agroforestry since the sludge contains nutrients that are available to plants, and that the sludge is sufficiently stable not to cause a negative environmental impact, and (iii) that In situ treatment of VIP latrine sludge using pit additives had no significant effect on the rate of mass loss or volume loss of pit latrines contents.

This chapter presents conclusions and recommendations that have arisen from this research work.

## **9.1 CONCLUSIONS**

This section specifically addresses the project objectives and hypotheses.

### ***Determination of sludge accumulation rates in pit latrines***

The first objective of this research work was to investigate sludge accumulation rates in pit latrines and a mass balance approach to infer the role of stabilization processes on sludge accumulation rates. The sludge accumulation rate data obtained were within the range of sludge accumulation rate data presented in the literature. It was also observed that sludge accumulation rate appeared to decrease with an increase in the number of users, results similar to the findings of the study conducted by Still *et al*, (2012). This result gave rise to an opinion formed on the basis of incomplete information on the nature of biological processes occurring and the number of pit users. However statistical analysis was conducted on the amalgamated sludge accumulation rate data presented by Still *et al*, (2012) and data obtained from this research to verify this observation, there was no indication that sludge accumulation rate decreases with an increase in number of pit users.

Therefore the following conclusion can be made from the study conducted that:

- When designing pit latrines, the capacity of the pit should depend on the frequency of pit emptying cycle and the per pit sludge accumulation rate should be considered for use as a design factor rather than the per capita sludge accumulation rate because, it is difficult to define the actual number of people

that would use a pit. Therefore it is better to design using a conservative value from all available data.

- Natural stabilization of sludge within the pit does occur if the pit is managed and maintained properly thus providing a long service life for the pit. It was found that the volume of materials have been reduced to between 50 and 75 % of the volume of material added over the 3 years since the pits investigated were last emptied, based on the observed per capita sludge accumulation rate and an estimate of the material added to the pit per person/year. Thus, by comparing the calculated mass reduction in the batch laboratory experiment with the volume reduction in the field investigation of sludge accumulation rate, it can be inferred that sludge densification/compaction could play an important role on the stabilization processes in a pit.

#### ***Mechanism of pit sludge stabilization and Nature of pit sludge***

The results obtained from the characterization of sludge samples collected from various VIP latrines within a community and when comparing with different communities indicated that the characteristics of sludge varied significantly within a pit and between different pits. The results suggest that below the surface layer in a pit additional stabilization of sludge content does occur and the degree of stabilization within a pit increases from the surface layer of the pit down through the bottom layer of the pit. It was also found that the material buried well below the pit surface, to be specific sludge samples from the bottom of the pit are well stabilized. Thus the results of this study supported the theory proposed by Buckley *et al* (2008).

Thus, the findings of this investigation support the hypothesis that significant biological stabilization occurs in a pit latrine with time; however sludge removed from the pit still contains some unbiodegraded material, the overall amount of biodegradable material in terms of COD was less than 30 % for exhumed sludge that arrived at the entrenchment site presented in **Chapter 6** compared to values of 74 % and 80 % for fresh faeces presented in **Table 2.1**. This suggests that processes designed specifically for reducing biodegradable organic content (such as WWTP and anaerobic digestion) are not appropriate treatment options for VIP latrine sludge.

Therefore, in conclusion the results obtained supports the findings of that natural stabilization does occur within a pit and also provide a holistic view of the nature of the materials present in a pit and as a result provide a background to assess the feasibility of different management options for filling pits and different disposal possibilities for VIP latrine sludge contents.

***To determine whether deep row entrenchment of pit latrine sludge for agroforestry has any significant benefits and do not have adverse effects on the environment***

The characteristics of VIP latrine sludge obtained in this study suggests that disposal of pit sludge would depend on the inherent ability of the disposal option to accept the load of solids and organic material in the sludge, the residual biodegradability of the VIP sludge and the health risks associated with the sludge. Typical characteristics of VIP latrine sludge obtained in this study and other studies conducted by other team members within the research project indicated that VIP latrine sludge is potentially contaminated with faecal coliforms and helminths ova, fairly stabilized with considerable vector attraction reduction and no potentially toxic metals or elements. Thus human contact with the sludge must be strictly limited mainly because of associated health risks. Therefore in terms of safety, while sludge applied by other disposal methods will be restricted based on the stability and microbial risks of VIP latrine sludge, entrenchment of VIP latrine sludge as found in this research seems to be an appropriate disposal option.

The results obtained from the characterization of fresh pit sludge that arrived at the burial site and sludge exhumed at different time intervals after burial in trenches indicated that there were changes in the composition of the sludge with time. This suggest that sludge stabilization occurred with time in the trenches. Since nitrogen, phosphorus and potassium are locked into the VIP sludge, it may be inferred that the further stabilization of sludge during entrenchment may cause the slow release of these components as fertilizer for agro-forestry applications. These results are consistent with the findings of Taylor (2012) that tree growth associated with buried sludge showed dramatically improved growth characteristics compared to a negative control,

suggesting that the nitrogen and other nutrients released from the entrenched sludge may be biologically available as a fertiliser.

It was also observed that the changes in the characteristics of the sludge buried in trenches did not have significant effect on the groundwater based on the analysis performed of water samples collected from time to time from the monitoring boreholes over the three years monitoring period.

Thus the finding of this study opens up a range of possibilities for the disposal of pit latrine sludge and even wastewater treatment secondary sludge. However further studies are required to evaluate the role of soil fungi in the degradation of sludge and the impact of sludge entrenchment on pathogens and the time frame in which total deactivation can be achieved.

#### ***Effect of pit latrine additives on pit sludge***

Finally, the effect of commercial pit latrine additives on VIP latrine sludge content was investigated both on a laboratory scale and field trials. It was hypothesised that In situ treatment of VIP latrine sludge using pit additives had no significant effect on the rate of mass loss or volume loss of pit latrines contents.

The results obtained from both the laboratory trials and the field trials provided scientific evidence to support this hypothesis. It is concluded that:

- The use of commercial pit latrine additives to enhance the rate of biological degradation and/or to reduce the mass or volume of pit latrine sludge in a pit does not have any beneficial effect on pit latrine sludge content.
- The measurement technique adopted in the study provided a clear approach of reliable way of measuring the sludge volume in a pit and means of quantifying and isolating biological effects from the effects of the additives.

## **9.2 RECOMMENDATIONS**

The research work presented in this thesis came up with various findings on the nature of VIP latrine sludge contents and how this sludge could be managed within the pit or when exhumed. These findings are presented in **Chapter 9** of this thesis.

The study identified that management of VIP latrine sludge should not be viewed as a one-dimensional issue; rather the management of VIP latrine should consider a wide range of different approaches that are dependent on the nature of the sludge contents. This section of the thesis makes recommendations based on the research undertaken.

The thesis thus recommends:

- That proper and effective user education should be in place for all households about the importance and purpose of the pit latrines in order to ensure that VIP latrines are able to fulfil the requirements of improved sanitation facilities. Specifically, reducing the addition rate of non-biodegradable material is a major factor that can reduce sludge accumulation rate in pits.
- An infrared Laser scanner which is used in various applications such robotics should be investigated for scanning and mapping out the surface layer of the pit. This is based on the difficulties encountered in obtaining properly positioned images using the stereographic imaging techniques, combined with the labour intensive method involved in analysing the images.
- Finally, the work presented and findings of this thesis are restricted to eThekweni municipality in Durban South Africa. Thus this thesis recommends that where possible, similar investigation should be carried out in other municipalities across the country and even in other countries such as Tanzania where there are a quite number of VIP latrines for comparison purposes.

## **9.3 RECOMMENDATION FOR FUTURE RESEARCH WORK**

This section of the thesis presents specific recommendation for future research work. A summarized list of recommendations for future research is as follows;

- Microbial analysis of pit latrine sludge and pit latrine additives need to be performed so as to be able to make comparison between the microbial load of pit latrine sludge and that found in pit latrine additives.
- An empirical model to predict sludge accumulation rates in VIP latrines needs to be developed. This aspect is in completion by an MSc student Kirsten Wood.
- An empirical model to determine and/or predict how long it will take for the migration of pollutant from the buried VIP latrine sludge into the surrounding groundwater at the entrenchment site. This aspect is under development in the School Bioresource Engineering and Environmental Hydrology University of KwaZulu-Natal.



## REFERENCES

---

---

- Abbott L. and Murphy D (2003). *Soil biological fertility: A key to sustainable land use in agriculture*
- Adrianus C., Haandel V. and Lettinga G. (1994). *Anaerobic sewage treatment- A practical guide for regions with a hot climate*. John Wiley and Sons England.
- Almeida M. C., Butler D. and Friedler E. (1999). At-source domestic wastewater quality. *Urban Water* **1** 49-55.
- Anderson K. S. P. and Uyanik S. (2003). *Anaerobic Treatment Processes*, in *The Handbook of Water and Wastewater Microbiology*. Edited by Elsevier.
- APHA (1998). *Standard methods for the examination of water and wastewater*. 20<sup>th</sup> Edition.
- Bakare B. F., Foxon K. M., Brouckaert C.J., Salisbury R., Still D. A. and Buckley C. A. (2008). Management of VIP latrines in the eThekweni Municipality. *Proceedings: WISA Biennial Conference and Exhibitions, Sun City South Africa* (18 -22 May 2008).
- Bakare B. F., Nwaneri C. F., Foxon K.M., Brouckaert C.J., Still D.A. and Buckley C.A. (2010). Pit latrine Additives: Laboratory and Field Trials. *Proceedings: WISA Biennial Conference and Exhibitions, ICC Durban South African* (18 -22 April 2010).
- Batstone D. J., Keller J., Angelidaki R. I., Kalyuzhnyi S. V., Pavlostathis S. G., Rozzi A., Sanders W. T. M., Siegrist H. and Vavilin V. A. (2002). *Anaerobic Digestion Model No.1. Scientific and Technical Report No.13 IWA Task Group for Mathematical Modeling of Anaerobic Wastewater* IWA publishing London.
- Bester J. W. and Austin L. M. (2000). *Design, construction, operation and maintenance of ventilated improved pit toilets in South Africa*. Water Research Commission. Report No. 709/1/00.
- Business Partners for Development (2001a). *Sanitation provision in low-income areas of Pietermaritzburg – A Report for Msunduzi local authority*.
- Buckley C. A., Foxon K. M., Brouckaert C. J., Rodda N., Nwaneri C., Balboni E., Couderc A. and Magagna D. (2008). *Scientific Support for the Design and Operation of Ventilated Improved Pit Latrines (VIPs) and the Efficacy of Pit Latrine Additives*. Water Research Commission. Report No. TT357/08.
- Buivid M. G. (1980). *Laboratory simulation of fuel gas production enhancement from municipal solid waste landfills*. Dynatech R& D Co. Cambridge, MA.
- Buswell C. (2006). *Fate and Transport of Nitrogen at a Deep Row Biosolids Application Hybrid Poplar Tree Farm*. Masters Thesis. University of Maryland. United State of America.

- Bwapwa J.K (2011). *Analysis of an anaerobic baffled reactor treating complex particulate wastewater in an ABR- membrane bioreactor unit*. MSc. Engineering dissertation. School of Chemical Engineering University of Kwazulu-Natal South Africa.
- Cairncross S. and Feachem R. (1996). *Environmental Health Engineering in the Tropics- An Introductory Text, 2<sup>nd</sup> edition*, Published by John Wiley & Sons New York.
- Chaggu E. J. (2004). *Sustainable Environmental Protection Using Modified Pit-Latrines*. PhD. Thesis. Wageningen University. The Netherlands.
- Cofie O. and Kone D. (2008). “Co-composting of faecal sludge and solid waste for urban agriculture” Sustainable Sanitation Alliance.
- Coffey M. (2006b). *Off-Site Disposal of Latrine Wastes*. 1st International Symposium and Workshop on Faecal Sludge Management (FSM) Policy.
- Cotton A., Franceys R., Pickford J. and Saywell D. (1995). *On-plot sanitation in low-income urban communities; A review of literature*. Water Engineering and Development Centre Loughborough University of Technology, ISBN Paperback 0 906055 44X.
- Couderc A. (2007). *Study into effect of moisture content and alkalinity on gas production rate from pit latrine contents*. Master of Science Dissertation. Engineering. Universite Paul Cezanne. France.
- Couderc A.A-L., Buckley C.A., Foxon K., Nwaneri C.F., Bakare B.F., Gounden T. and Battimelli, A. (2008). The effect of moisture content and alkalinity on the anaerobic biodegradation of VIP contents. *Water Science & Technology*, **58** (2), 473-477.
- Christensen T.H. and Kjeldsen P (1989), Basic Biotechnical Processes in Landfills. In *Sanitary Landfill: Process, Technology and Environmental Impact*. Edited by T.H. Christensen, R. Cossu and R. Stegmann. Academic Press.
- de Boer W., Folman L.B., Summerbell R.C. and Boddy L. (2005). Living in a fungal world: impact of fungi on soil bacterial niche development. *Federation of European Microbiological Societies*. **29** (2005) 795-811
- Del Giorgio P.A. and Cole J.J (1998). Bacteria growth efficiency in natural aquatic systems. *Annual Review of Ecological system*. **29** 503-541
- DWAF (1994). White Paper: Water Supply and Sanitation Policy. *Cape Town South Africa*
- DWAF (1998). *Minimum Requirements for Waste Disposal by Landfills. Waste Management Series*. 2<sup>nd</sup> edition. Department of Water Affairs and Forestry, South Africa.
- DWAF (1999). General Authorisations in terms of section 39 of the National Water Act, 1998(Act no. 36 of 1998). *Government Gazette no. 20526*.

- DWAF (2001). Draft guidelines for the removal and disposal of faecal waste from pit latrines and septic tanks.
- DWAF (2003). Strategic Framework for Water Services. Available online: [www.dwaf.gov.za/Documents/](http://www.dwaf.gov.za/Documents/)
- DWAF (2005). Guidelines for pit emptying as a Municipal Service.
- DWAF (2007). Options for Dealing with Full Pits. (Draft Guideline- emptying of pit latrines).
- Diamantopoulos A. and Schlegelmilch B.B. (1997). *Taking the Fear Out of Data Analysis*. The Dryden Press London
- Dons A. (1987). Hydrology and sediment regime of a pasture, native forest, and pine forest catchment in the central North Island, New Zealand. *NZ Journal of Forestry Science* **17** (2/3): 161-78
- Duncan M.J. (1993). Does planting pines reduce recharge? New Zealand hydrological annual symposium. NIWA Freshwater, Christchurch, New Zealand
- Eales K. (2005). Bringing pit emptying out of the darkness: A comparison of approaches in Durban, South Africa, and Kibera, Kenya. *Sanitation Partnerships Series*: p 5-6
- Eckhard L., Werner A. S. and Markus A. (2001). ‘Lognormal Distributions across the Sciences: Key and Clues’, *BioScience*, **51** (5)
- Ennos, R. (2002). *Statistical and Data Handling Skills in Biology*. Prentice Hall England.
- EPA (1995). Decision Maker’s Guide to Solid Waste Management, *Volume 2: US Environmental Protection Agency*. USA.
- Evans M., Hastings N. and Peacock B. (1993). *Statistical Distributions*. 2<sup>nd</sup> Edition. John Wiley and Sons Inc, New York.
- eThekweni Municipality Water and Sanitation Unit (EWS) and UWP Consulting Unit (2004). Pit latrine evacuation study report.
- eThekweni Municipality Water and Sanitation Unit (2011). *Draft Water Services Development Plan Version 19*
- Foxon K. M., Brouckaert C. J., Harrison J., Pfaff W., Remigi E., Rodda N. and Buckley C.A. (2006) Can VIP additives make a difference? *Proceedings: WISA Biennial Conference and Exhibitions 2006, ICC Durban South African*.
- Foxon K. M., Mkhize S., Reddy M., Brouckaert C. J. and Buckley C. A. (2009). Laboratory protocols for testing the efficacy of commercial pit latrine additives. *Water Science & Technology* **35**(2) 228-235

- Franceys R., Pickford J. and Reed R. (1992). A guide to the development of onsite sanitation. *World Health Organisation: Geneva*.
- Fricke K., Santen H., Wallmann R., Axel H. t. and Norbert D. (2007). Operating problems in anaerobic digestion plants resulting from nitrogen in MSW. *Waste Management* **27** 30–43
- Gray K. R., Sherman K. and Biddlestone A. J. (1971). A Review of Composting- *Part 1 Process Biochemistry*. **6**(6) 32-36, 41
- Griffin D.M. (1985). A comparison of the roles of bacterial and fungi In: Bacterial in Nature (leadbetter E.R. and Poindexerter J.S Eds), Bacterial Activities in Perspective, vol. 1, pp.221-255. Academic Press London.
- Ham R. K, (1979). Predicting Gas Generation from Landfills. *Waste Age, November 1979*.
- Heinss U., Larmie S. A. and Strauss M. (1998). Solids separation and pond systems for the treatment of septage and public toilet sludges in the Tropics - Lessons learnt and recommendations for preliminary design. *EAWAG/SANDEC Report No. 05/98*
- Henze M., Harremoës P., Jansen J. and Arvin E. (1997). *Biological and chemical processes in wastewater treatment*. Springer Verlag Berlin, Germany.
- Jennings D.H. (1987). Translocation of solutes in fungi. *Biological Review*. **62** 215-243
- Jönsson H., Richert S.A., Vineras B. And Salomon E. (2004). Guidelines on the use of Urine and Faeces in Crop Production. EcosanRes Publication Series. Stockholm Environment Institute. Stockholm.
- Kays J. S., Felton G. K. and Flamino E. J (199). *Deep – Row Application of Biosolids to Grow Forest Crops on Mine Spoils: Potential Utilization for the Baltimore, MD- Washington, D.C. Metro Area* University of Maryland Cooperative Extension
- Kays J. S., Felton G. K., Buswell C. U. and Flamino E. J. (2007). Deep Rows Incorporation of Biosolids to Grow Hybrid Poplar Trees on Sand and Gravel Mine Spoils in Southern Maryland. *Water Practice, Vol. 1, No. 1*. **15** 1-15
- Kele B.M. (2005). *On-site wastewater treatment and reuse using recirculatory evapotranspiration channels in regional Queensland*. MSc thesis, Central Queensland University.
- Kelly G. (2006). *Recycled Organics in Mine Site Rehabilitation: A review of the scientific literature* Department of Environment and Conservation NSW. Available online: [www.environment.nsw.gov.au](http://www.environment.nsw.gov.au).
- Kiggundu B.M. (1995). Physical-chemical emptying of latrines for sustainability. *Proceedings: 21st WEDC Conference on Sustainability of Water and Sanitation Systems*.

- Kirango J. and Muller M. S. (1997). MAPET: A Service for the Collection of Latrine Sludge from Households in Dar es Salaam, Tanzania. *Urban Waste Series Vol. 6*.
- Lay, J.-J., Li, Y.-Y., and Noike, T. (1997). "Influences of pH and moisture content on the methane production in high-solids sludge digestion." *Water Research*, 31(6), 1518-1524.
- Lee T. E. and Wang J. W. (2003). *Statistical Methods for survival data analysis. 3<sup>rd</sup> edition*. John Wiley & Sons New Jersey.
- Lopez Zavala M. A., Funamizu N. and Takakuwa T. (2002). Characterization of faeces for describing the aerobic biodegradation of faeces. *Journal of Environmental Systems and Engineering, JSCE*, 720/VII-25 99-105
- Magagna (2006). *Modelling waste stabilisation processes in ventilated improved pit latrines*. MSc Dissertation. University of KwaZulu-Natal. South Africa.
- Mara D. D. (1984). *The design of VIP, TAG Technical Note*. Report World Bank Washington DC.
- Mara D.D. (1996). *Low-Cost Urban Sanitation*. John Wiley & Sons England
- Metcalf and Eddy (2003). *Wastewater Engineering: Treatment and Reuse. 4<sup>th</sup> Edition*. McGraw Hill New York.
- McCarty P. L. and Mosey F. E. (1991). Modelling of anaerobic digestion processes (a discussion of concepts). *Water Science & Technology*, **24**(8) 17-33
- Min K.S., Khan A.R., Kwon M.K., Jung Y.J. and Yun Z., Kiso .Y. (2005). Acidogenic fermentation of blended food waste in combination with primary sludge for the production of volatile fatty acids. *Journal of Chemical Technology & Biotechnology*, **80** 909-915
- McInerney M. J. and Bryant M. P. (1981). *Basic Principles of Bioconversions in Anaerobic Digestion & Methanogenesis*. Plenum Press New York.
- Montessuit C. (2010). *Laboratory protocols for testing the efficacy of commercial pit latrine additives and water as an additive*. Internship Report submitted to IUP GSI Grenoble France.
- Morgan, P. (2004). "The answer lies in the soil." In: An ecological approach to sanitation in Africa – a compilation of experiences, EcosanRes, SEI, Stockholm.
- Morris D.A. and Johnson A.I (1967). Summary of hydrologic and physical properties of rock and soil materials as analyzed by hydrology laboratory of the US Geological Survey. US Geological Survey water supply paper 1839 pp 42
- Muller S. & Rijnsburger J. (1994). MAPET, *A Neighbourhood-Based Pit Emptying Service with Locally Manufactured Handpump Equipment in Dar es Salaam, Tanzania*. Manual Pit-Latrine Emptying Technology Project Final Report. WASTE Consultants, the Netherlands.

Murphy K. O. H. (1997). *Permissible utilization and disposal of sewage sludge*. Water Research Commission. Report No. TT 85/97

National Water Act (Act 36 of 1998). Available online: [www.info.gov.za/gazette/acts/1998/a36-98.pdf](http://www.info.gov.za/gazette/acts/1998/a36-98.pdf).

Norris J.A. (2000). *Sludge Build-Up in Septic Tanks, Biological Digesters and Pit Latrines in South Africa*. Water Research Commission. Report No. 544/1/00

Nwaneri C. F (2009). *Physico-Chemical characteristics and biodegradability of contents of Ventilated Improved Pit latrines in eThekweni Municipality*. Master of Science dissertation. School of Biological and Conservation Science. University of Kwazulu-Natal. South Africa.

O'Flaherty V. (2006). The microbiology and Biochemistry of Anaerobic Bioreactors with Relevance to Domestic Sewage Treatment. *Reviews in Environmental Science and Biotechnology*.

Palmquist H. and Jönsson H. (2003). Urine, faeces, greywater and biodegradable solid waste as potential fertilizers. *2nd International Symposium on Ecological Sanitation*. Lübeck, Germany.

Peavy H.S., Rowe D.R. and Tchobanoglous G. (1985). *Environmental Engineering*. McGraw Hill Singapore.

Press W.H., Flannery B.P., Teukolsky S.A. and Vetterling W.T. (1992). Kolmogorov-Smirnov Test. In *Numerical Recipes in FORTRAN: The Art of Scientific Computing*, 2<sup>nd</sup> edition. Cambridge University Press England pp.617-620

Rees J.F. (1980). Optimization of Methane Production and Refuse Decomposition in Landfills by Temperature Control. *Journal of Chemical Technology and Biotechnology*. **30** 458-465

Scott R. and Reed B. (2006). Emptying pit latrines. *Well Factsheet Loughborough University, United Kingdom*.

Schanbacher F. L., Willett I. B., Borger D. C., Neiswander R. L. and Gratz M. (2005). Bioprocesses associated with anaerobic digestion of manures and food Wastes for the Production of biogas Animal Waste Management Symposium.

Seghezzo L., Zeeman G., Lier J. B. v., Hamelers H. V. M. and Lettinga G. (1998). A review: The anaerobic treatment of sewage in UASB and EGSB reactors. *Bioresource Technology*, **65** 175-190

Sikora L.J., Burge W.D. and Jones J.E. (1982). Monitoring of a Municipal Sludge Entrenchment site. *Journal of Environmental Quality*, **11**(2) 321-326

Skoog D.A., West D.M. and Holler F.J. (1991). *Fundamentals of Analytical Chemistry*. 7<sup>th</sup> edition. Saunders College Publishing USA.

Smith S.E. and Read D.J (1987). *Mycorrhizal Symbiosis*. Academic Press London

- Snyman H.G. and Herselman J.E. (2006). Guidelines for the utilisation and disposal of wastewater sludge Volume 1: Selection of management options *Water Research Commission*. Report No. TT261/06
- Speece R. E. (1996). *Anaerobic biotechnology for Industrial Wastewaters*. Archae Nashville, TN.
- Steiner M. (2006). Promotion of On-Site Sanitation and Faecal Sludge Management (FSM) in Dakar. *Symposium on Faecal Sludge Management*. Dakar 9-12 May 2006
- Still D. A. (2002). After the pit latrine is full....What then? Effective options for pit latrine management. *Proceedings: WISA Biennial conference, ICC Durban, South Africa*.
- Still D.A., Salisbury R.H., Foxon K.M., Buckley C.A. and Bhagwan J.N. (2010). The challenges of dealing with full ventilated improved pit latrines. *Proceedings: WISA Biennial Conference and Exhibitions, ICC Durban South African* (18 -22 April 2010).
- Still D.A. and Foxon K.M (2012). *Tackling the challenges of full pit latrines. vol. 2* Water Research Commission. Report No: 1745/2/12
- Still D.A., Louton B., Bakare B.F., Taylor C., Foxon K.M. and Lorentz S. (2012). Water Research Commission. Report No: K5/1829
- Strauss M. and Montangero A. (2002). Faecal Sludge Management – Review of Practices, Problems and Initiatives. *EAWAG 2002*.
- Sugden S. (2005). *Excreta management in unplanned areas*. London School of Hygiene and Tropical Medicine. Available online: <http://siteresources.worldbank.org>.
- Sugden S. (2006). *Investigating the potential of bio-additives to prolong the life of pit latrines and septic tanks in emergency situations*. London School of Hygiene and Tropical Medicine.
- Taljaard L., Venter A. and Gorton D. (2003). *Evaluation of different commercial microbial or microbially derived products for the treatment of organic waste in pit latrines*. Water Research Commission. Report No. 1377/1/05.
- Taylor C. (2011). *An investigation into potential of faecal sludge for plant production*. Master of Science dissertation. School of Biological and Conservation Science. University of Kwazulu-Natal. South Africa. (in completion)
- Thom H.C. (1958). A Note on the Gamma Distribution. *Monthly Weather Review*, Vol. 86, pp.117-122.
- Todd D.K. (1976). *Groundwater hydrology*. 2<sup>nd</sup> edition John wiley

- Toffey W., Flamino E., Pepperman R., Grous A., Drumheller A. and Garvey D. (2005). *Demonstrating deep row placement of bio-solids in coal mine land reclamation*. Available online: <http://www.clu-in.org/conf/tio/ecoresources3/resources>.
- Van L.J.B., Rebac S. and Lettinga G. (1997). High-rate anaerobic wastewater treatment under psychrophilic and thermophilic conditions. *Water Science Technology* **35**, 199-206
- Vinnerås, B. 2002. *Possibilities for sustainable nutrient recycling by faecal separation combined with urine diversion*. Agraria 353, Acta Universitatis Agriculturae Sueciae, Swedish University of Agricultural Sciences. Uppsala, Sweden.
- Vom Promotionsausschuss der (2010). *Further Treatment of Digested Blackwater for Extraction of valuable components*. PhD Thesis. Technischen Universität Hamburg-Harburg.
- Walack C. (2007). *Hand-book on Statistical Distributions for Experimentalists*. Internal Report SUF-PFY/96-01. University of Stockholm.
- Weaver J.M.C., Cave L. and Talma S. (2007). *Groundwater Sampling. A comprehensive Guide for sampling methods*. Water Research Commission. Report No. TT303/07.
- Walpole R.E. and Myers R.H. (1978). Probability and statistics for engineers and scientists. *Collier Macmillan International Editions*.
- Water Services Act (Act108 of 1997). Available online: [www.wrc.org.za/downloads/legislature/WSA108-97.pdf](http://www.wrc.org.za/downloads/legislature/WSA108-97.pdf)
- Wegelin-Schuringa M. and Coffey M. (1998). *Small pit emptying machine an appropriate solution in Nairobi slum*. IRC international water and sanitation centre.
- WHO (2004). Guidelines for drinking water quality, *WHO Geneva*, (2004) Winblad U. and Simpson-Hébert M. (2004). Ecological Sanitation - revised and enlarged edition. SEI, Stockholm, Sweden.
- WHO and UNICEF (2010). Progress on Sanitation and Drinking-Water: 2010 Update. *Joint Monitoring Programme for Water Supply and Sanitation*.
- Williams P.T. (1998). *Waste Treatment and Disposal*. John Wiley and Sons Chichester.
- Wong R.K.W. (1977). Weibull Distribution, Iterative Likelihood Techniques and Hydrometeorological Data. *Journal of Applied Meteorology*, Vol. 16, pp.1360-1364
- Woods K. (in completion). *Biological Degradation in VIPs: An Unsteady State Mass Balance Approach*. Master of Science dissertation. School of Chemical Engineering University of KwaZulu-Natal. South Africa



## APPENDIX A

---

---

### SAMPLE QUESTIONNAIRE AND ETHICAL CLEARANCE

#### User Related Questions

- 1) How many people on average are using the pit?
- 2) How long has the pit been in operation?
- 3) Have any chemicals been added to the pit? If yes,
- 4) What type and for what reason?
- 5) Has the pit been ever emptied? If yes,
- 8) How many times and what was the last time?
- 8) Has any substances/liquid other than laundry water poured into the pit?
- 9) Is there any collection centre for household waste or is household waste also disposed into the pit?
- 10) What type of anal cleansing materials is used by households?
- 11) By visual inspection what can be said about the sludge content; is it extremely wet or dry?

#### Construction/Environmental conditions related questions

- 12) Is it built in a convenient and accessible place?
- 13) Does it have a fly screen?
- 14) Does the toilet have a door or is the door broken?
- 15) Is there a water inlet from the sides of the pit?
- 16) Do rain or storm water enter the pit? If yes, through where.
- 17) Do the pit have a cover?

#### House Address

.....  
GPS coordinate .....

How full is the pit? .....

How deep when emptied .....

Area of pit .....

What quantity of sludge was evacuated in terms of number of wheel bins?

#### **Observers comment**

24 October 2012

Mr Babatunde Femi Bakare 206502332  
School of Chemical Engineering  
Howard College Campus

Dear Mr Bakare

Protocol reference number: HSS/1096/012D  
Project title: Scientific and Management Support for Ventilated Improved Pit latrine Sludge Content

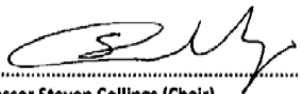
**Expedited Approval**

I wish to inform you that your application has been granted Full Approval through an expedited review process.

Any alteration/s to the approved research protocol i.e. Questionnaire/Interview Schedule, Informed Consent Form, Title of the Project, Location of the Study, Research Approach and Methods must be reviewed and approved through the amendment/modification prior to its implementation. In case you have further queries, please quote the above reference number. Please note: Research data should be securely stored in the school/department for a period of 5 years.

I take this opportunity of wishing you everything of the best with your study.

Yours faithfully



Professor Steven Collings (Chair)

/px

cc Supervisor Dr KM Foxon  
cc Professor CA Buckley  
cc Academic leader Professor D Jaganyi  
cc School Admin. Mrs Kim Henry

**Professor S Collings (Chair)**  
**Humanities & Social Sc Research Ethics Committee**  
**Westville Campus, Govan Mbeki Building**  
Postal Address: Private Bag X54001, Durban, 4000, South Africa  
Telephone: +27 (0)31 260 3587/8350 Facsimile: +27 (0)31 260 4609 Email: ximbap@ukzn.ac.za / snymanm@ukzn.ac.za  
founding Campuses: ■ Edgewood ■ Howard College ■ Medical School ■ Pietermaritzburg ■ Westville



## APPENDIX B

---

---

### VIP SLUDGE ANALYTICAL METHODS AND STATISTICAL METHODS

Appendix A1 presents the details of all analytical methods use for the characterization of VIP latrine sludge collected directly from the pit as well as those exhumed from the trenches at various time intervals. All statistical method use to analyze the data obtained from the characterization of VIP latrine sludge is also presented.

#### Analytical Methods

All analytical method, where possible, was carried out according to the standard methods (APHA, 1998) and where no appropriate method was published, adaptations of existing methods were used or entirely new methods were developed. A number of physical, chemical and biological analyses were carried out which appropriately describe the composition of VIP latrine sludge. These analytical methods are further explained as follows;

#### Moisture Content

On every sludge samples collected from the various pit latrine and exhumed sludge from trenches at the burial site, the moisture content was performed by taking a known mass of the representative sample from each materials collected from the either the pit or trenches. This representative sample was then place in a beaker and oven dried at a temperature of 105°C for 24hrs, thereafter the mass of the dried sludge sample was measured and recorded. The moisture content of that particular sludge sample was then calculated as follows:

$$W(\%) = \frac{M_w - M_d}{W_w} \times 100 \quad \text{[B.1]}$$

Where:

$W(\%)$  = Moisture content of the VIP latrine sludge or exhumed trench sludge

$M_w$  = The initial mass of collected sludge samples before drying in the oven

$M_d$  = The mass of sludge samples after drying in the oven at 105°C for 24hrs

### Solid Characterizations

Solid characterization of collected VIP sludge samples and exhumed trench samples was carried out to determine total and volatile solids. Total solids was measured by evaporating sludge sample to dryness in crucibles in an oven at 103-105°C and weighing the residue. The weight of the residue is the total solids present in the sludge sample. On ignition of the residue in the crucible in a muffle furnace at 550°C and allowing the samples to cool in a dessicator, the weight loss on ignition is the volatile solids. These two parameters indicate approximately the amount of organic matter present in the solid fraction of the sludge samples collected. The total solid and volatile solid are calculated as follows;

$$\text{Total Solid (g / gsample)} = \frac{M_{105^{\circ}\text{C}}}{M_s} \quad [\text{B.2}]$$

$$\text{Volatile Solid (g / gsample)} = \frac{M_{105^{\circ}\text{C}} - M_{550^{\circ}\text{C}}}{M_s} \quad [\text{B.3}]$$

Where;

$M_s$  = Initial mass of sample used

$M_{105^{\circ}\text{C}}$  = Mass of sample after oven dried at 105°C

$M_{550^{\circ}\text{C}}$  = Mass of sample after ignition in the furnace at 550°C

### Chemical Oxygen Demand (COD)

Total COD of VIP latrine sludge samples or exhumed trench sludge sample was determined using the open reflux method for particulate samples. Sludge samples of known mass were diluted with known amount of distilled water before been oxidized with a known excess amount of potassium dichromate ( $\text{K}_2\text{Cr}_2\text{O}_7$ ). After oxidation the sample was then titrated with ferrous ammonium sulphate (FAS) to determine the amount of  $\text{K}_2\text{Cr}_2\text{O}_7$  consumed which was then expressed in terms of its oxygen equivalence. A blank sample of the reagent was also tested and this was considered as a

control for each COD tests performed. The COD is thus calculated as follows after which this value is corrected using the dilution factor.

$$COD \left[ \frac{mgO_2}{l} \right] = \frac{[Blank(ml) - Titration(ml)] \times 8000 \times M_{FAS} (mol/l)}{Sample\ volume(ml)} \quad [B.4]$$

8000 is the mill equivalent weight of oxygen  $\times 1000$  ml/l

$M_{FAS}$  is the molarity of the ferrous ammonium sulphate used as a standard value which is always recalculated for each set of analysis.

### Aerobic Biodegradability Test

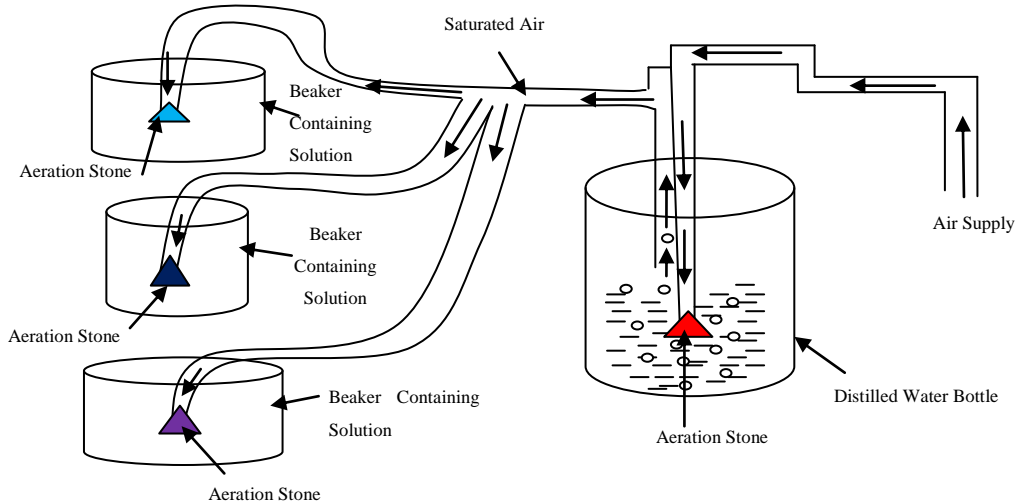
Aerobic Biodegradability Tests were performed on sludge samples collected from VIP latrines and sludge exhumed from trenches at the burial site. These tests are simple batch tests designed to quantify the amount of biodegradable material present in the sludge samples. In order to characterize the amount of biodegradable material present during the aerobic biodegradability test, there is a need to have a gross indicator of the amount of biodegradable content present. Two gross indicator can be considered to be applicable, these are; Biological Oxygen Demand (BOD) or Chemical Oxygen Demand (COD). The major problem associated with BOD is that the test runs for 5 days and also only a small portion of the organic compounds are decomposed during the BOD test. Chemical Oxygen Demand was considered to be the most applicable gross indicator in that it is ideally a quick measurability test and nearly all the organic compound presents are oxidized during the test.

The aerobic biodegradability tests involve suspending 50g of well mixed sample in a litre of tap water in a large Erlenmeyer flask; the mass of the suspension was recorded. The suspension was then analyzed for total COD and aerated with saturated air for 5 days and the mass of the suspension was recorded after which samples were taken and analyzed for total COD. The biodegradable COD content of the sample was calculated as the ratio of the amount of COD reduced by the aeration process to the original COD content of the suspension and corrections were made for moisture loss through evaporation. This calculated value gives an indication of the biodegradability of the sample. Each analysis was carried out in triplicate on each of the samples collected and

the averages of each analysis were computed for the final results. The Percentage Biodegradability of each sample is calculated using the equation given below;

$$\% \text{ Bio deg radability} = 1 - \frac{\text{Final COD} \times \text{Final Volume}}{\text{Initial COD} \times \text{Initial Volume}} \quad [\text{B.5}]$$

The general experimental set up as shown below;



**Figure B.1: Aerobic Biodegradability Set up**

### Statistical Methods

The analytical result obtained from the laboratory characterization of VIP latrine sludge samples and exhumed trench samples are incomplete without an estimate of their reliability. It is very important to provide some measure of the uncertainties associated with result obtained from the analytical results if the data are to have any value. This section presents a summary of the statistical methods used in this research work. All statistical analysis carried out in this research work were performed using Microsoft excel as well as SPSS 15. Each analysis was carried out in triplicate or more and in order to understand the significance of the analytical data obtained in the course of this research work, one or combination of the following described statistical theory presented as follows were used. Most of these statistical theories were drawn from

Diamantopoulos A. and Schlegelmilch B.B (1997), Ennos R. (2002) and Skoog D.A *et al* (1991).

### Mean/Average value

The average value of each sludge samples analyzed was calculated by dividing the sum of replicate measurements by the number of measurements carried out in a set of analysis:

$$\text{Average} = \frac{\sum_{i=1}^N x_i}{N} \quad \text{[B.6]}$$

Where;

$x_i$  = Individual values of each replicate measurements

N = the number of replicate measurements

### Standard deviations

The standard deviation of the analytical results obtained for each sample was calculated in order to be able to describe the closeness of each analytical result that have been obtained in exactly the same way. This was calculated as follows:

$$\text{standard deviation} = \sqrt{\frac{1}{N-1} \sum_{i=1}^N (x_i - x)^2} \quad \text{[B.7]}$$

Where;

$x_i$  = Individual values of each replicate measurements

N = the number of replicate measurements

$x$  = the average value

### Confidence interval on the mean

In all the VIP sludge sample analysis carried out in the course of this research work, there is a need to have a particular value that describe the characteristics of the sludge

samples for each parameters determined. The average value of that particular analytical result cannot appropriately be used to describe the characteristics of the sludge samples because statistically the determination of the exact average value of a set of analytical results requires that an infinite number of measurements be made. However, the confidence interval on the mean allows limits to be set around an experimentally determined mean value within which the population mean value lies with a given degree of probability. In this research work, the 95 % confidence interval on the mean was determined for each set of analytical result obtained. This found to be reasonably acceptable. The 95 % confidence on the mean value suggests that if analysis is carried out from another sample from the same population or analysis is carried out on the actual population, there would be a 95 % chance that the respective means would fall within the 95 % confidence limit range or clearer sentence, there would only be a 5 % chance that the respective mean value lies outside the 95 % confidence limit range. There are two ways in which the confidence limits on the mean can be calculated;

- Calculation based on large samples (> 30)

To calculate the 95 % confidence on the mean for large data sets, the standard error which gives a measure of confidence that the sample mean is within a certain range of the true population mean is multiplied by the standardized normal deviate value of 1.96.

- Calculation based on small samples (<30)

For smaller samples, the statistic *t* value read directly from the probability table of *t* is used in calculating the 95 % confidence on the mean value. This computed as follows;

$$\text{Mean value} \pm t \times \text{standard error} \quad \text{[B.8]}$$

The standard error is thus calculated as follows;

$$\text{Standard error} = \frac{\text{standard deviation}}{\sqrt{N}} \quad \text{[B.9]}$$

Where;

N = the number of replicate measurements



### Statistical tests for differences

Two types of statistical tests for differences were employed in the course of this research work. The t-test was used to determine whether the means of two groups are statistically different from each other. This test is used to compare the means of two treatments, i.e. fresh VIP sample and trench sample of a year old. The t-test compares the actual difference between two means in relation to the variation in the data, expressed as the standard deviation of the difference between the means.

On the other hand, the analysis of variance (ANOVA) was used in comparing means of three or more analytical data. This test was used for comparing means of three or more samples, in order to avoid the error inherent in performing multiple t-tests (Walpole *et al*, 1978). If three set of measurements for three variables have to be compared, the test can only be used to compare two variables at a time. if more than three set have to be compared, it would be time-consuming and, more important, it would be inherently flawed, since in each t-test a 5% chance of the conclusion being wrong is acceptable (for  $p = 0.05$ ). Analysis Of Variance (ANOVA) overcomes this problem since it allows detecting significant differences between the treatments as a whole (Walpole *et al*, 1978).

### Sensitivity and Error Analysis

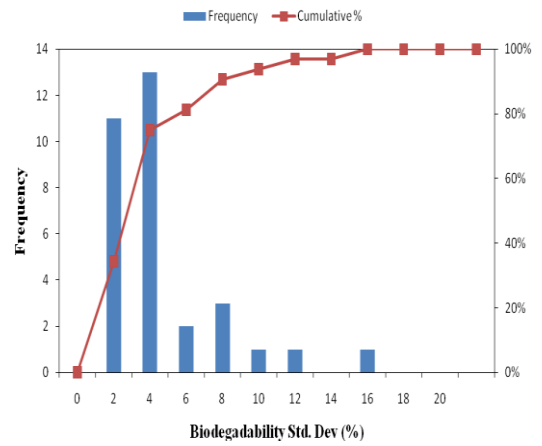
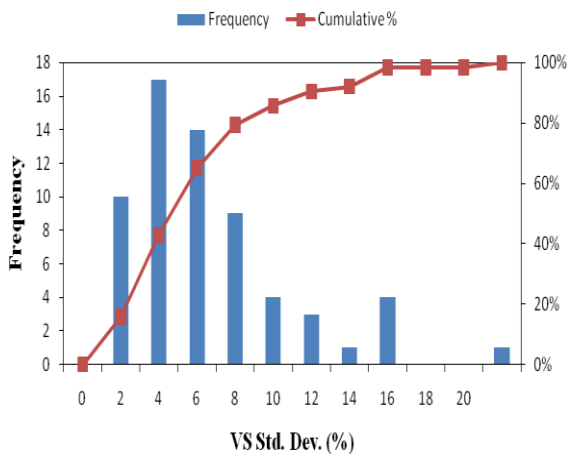
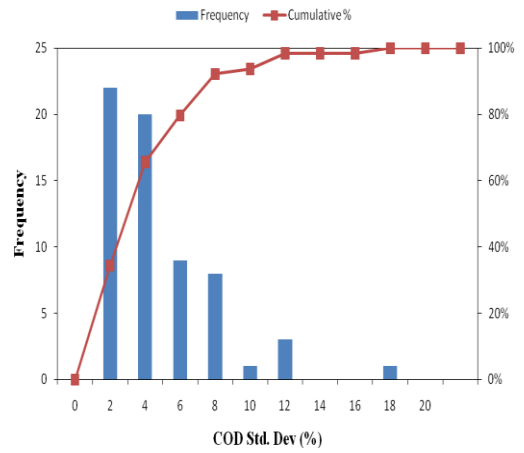
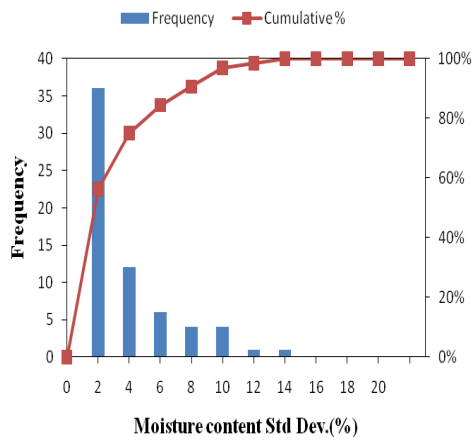
When performing chemical analysis, it is inevitable for the results obtained to be absolutely free from errors and uncertainties. The estimation of acceptable level of accuracy is necessary for the viability of result obtained from any analysis. This section presents the accuracy and repeatability of the results obtained in the course of this research. Every measurement is influenced by many uncertainties (Skoog *et al* 1991), however, the uncertainties in the analytical results presented in this thesis might be from two basic sources: limitation in the equipment/instrument used and/or variations due to human error and heterogeneous nature of VIP latrine sludge samples. The following section considered these two basic aspects separately and explained how this uncertainties where evaluated where possible.

### Limitation on Testing Apparatus, Equipment and/or Instrument

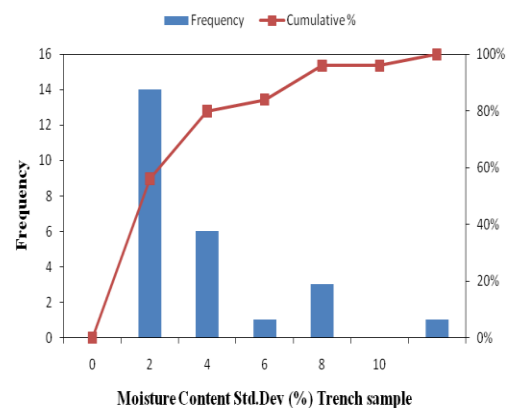
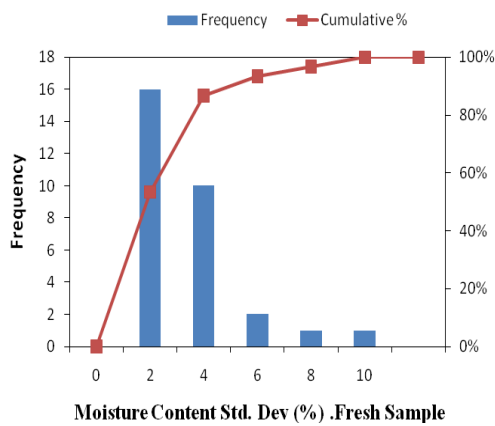
All analysis performed in the course of this study made use of several laboratory apparatus, equipment and/or instruments (such as pipette, measuring cylinders, mass balances etc). This apparatus, equipment and/or instruments might have a limitation on the overall result of the analysis performed. This limitation that arises from testing apparatus, equipment and/or instrument can never be completely eliminated, however, during the analytical component of this research several precautionary measures were adhere to as presented in the standard method for a particular analysis. Where necessary, calibration of equipment before use was also performed in order to reduce errors that might arise and also enhance the quality of the analytical data. In some cases if errors are detected, these errors are adequately corrected before the continuation of the analysis. Finally a number of statistical test are performed on all analytical data obtained to access the reliability and quality of all analytical measurements made.

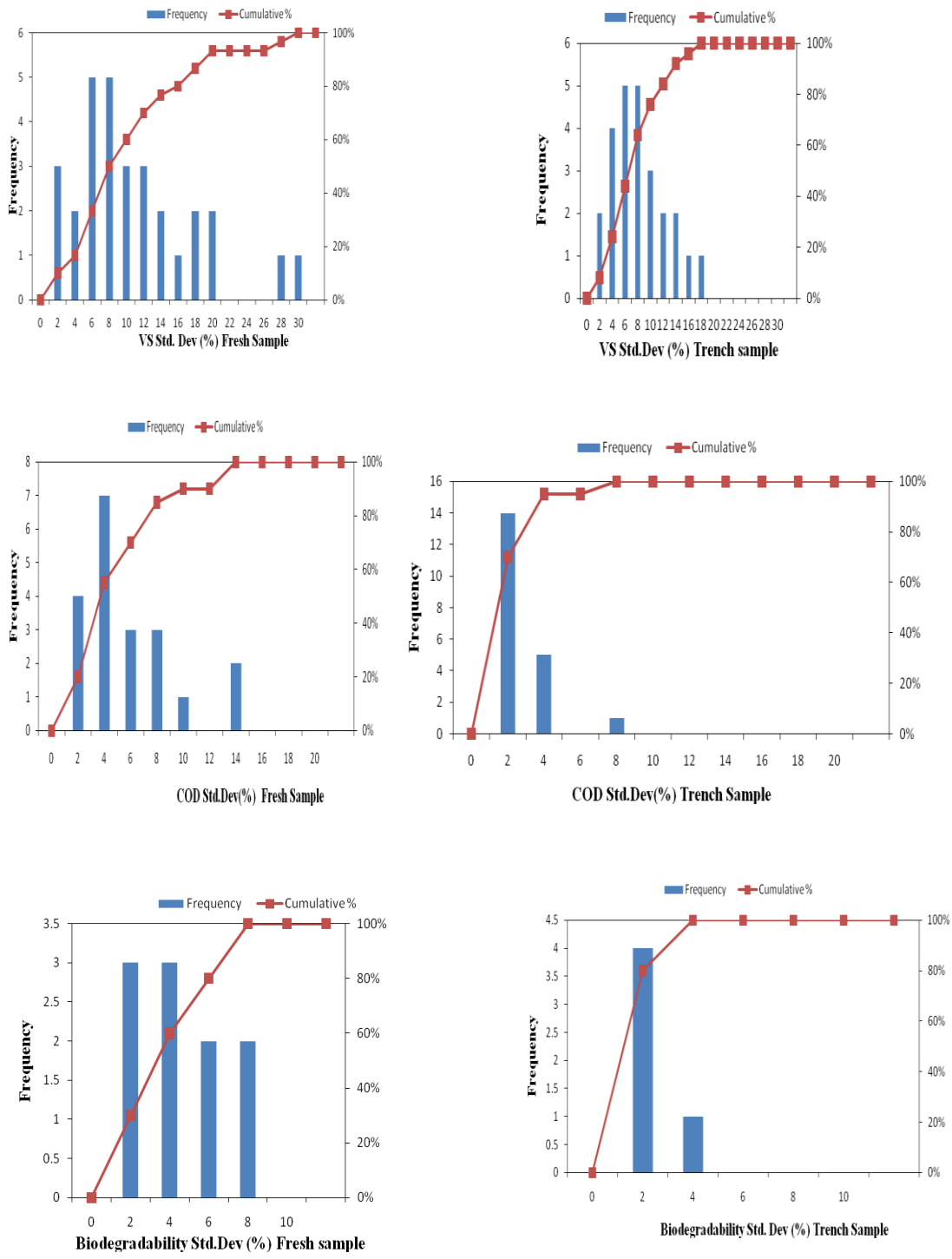
### Variation due to human error and VIP sample heterogeneity

The other aspects that might bring about uncertainties in the analytical data presented in this thesis might be due to human error and sample variations. The heterogeneous nature of VIP latrine sludge could result in a significant degree of variation in the analytical data sets. Also, variation due to human error is inevitable because of the fact that many analytical measurements require personal judgements. Examples includes measuring of liquid levels with respect to a graduation line as in the case of pipette or measuring cylinder and changes in colour of a solution during titrations. Each sample collected either directly from the pit or exhumed from the trenches, atleast three replicate analyses are carried out and the average value and standard deviation are then computed. In order to access the reliability of the analytical data obtained from the various analysis performed on the collected sludge samples, the standard deviation for each sample analysis is compiled in a histogram to access the general trend. The charts for each analysis performed are presented in the following charts.



**Figure B.2: Histogram for the standard deviations recorded for various parameter analysis performed for sludge samples collected directly from the pits at different layers.**





**Figure B.3: Histogram for the standard deviations recorded for various parameter analysis performed for fresh VIP sludge samples before burial in trenches and sludge samples exhumed from trenches .**

As presented in the histograms above, it is clearly shown that the results are closely grouped about their average value and most of the data indicates a standard deviation of less than 10%. Thus, through the assessment of the standard deviation of the analytical results as presented in the histogram, all laboratory analysis performed on the sludge samples could be said to be of acceptable accuracy. Hence, based on the analysis of the histograms, the following standard deviations can be assumed:

Analysis Performed on sludge samples collected from different layer within a pit;

Moisture content:	12 %	COD:	14 %
VS:	16 %	Biodegradability:	14 %

Analysis Performed on sludge before burial and exhumed sludge

Fresh sample

Moisture content:	10 %	COD:	14 %
VS:	20 %	Biodegradability:	8 %

Trench sample

Moisture content:	8 %	COD:	5 %
VS:	18 %	Biodegradability:	3 %

## APPENDIX C

---

---

### **GROUNDWATER SAMPLING TECHNIQUES AND DATA**

The four steps for the Standard Groundwater sampling procedures described by Weaver *et al*, 2007 which was adopted for the groundwater study presented in this Thesis are briefly described as follows:

#### **Field Sampling Equipment Preparations**

Water samples were collected from the monitoring boreholes at the Umlazi sludge entrenchment site on a monthly basis where possible. Before the collection of water samples, it was always necessary to clean the field sampling equipment to eliminate contamination of the water samples. The sampling equipments were also calibrated before use. The field sampling equipment include a bailing pumping equipment, an electrical conductance measurement based water level meter, probes and instruments used for measuring temperature, pH, conductivity, dissolved oxygen; sampling bottles/containers/buckets, preserving containers (this includes cooler box and ice).

#### **Measurement of Water Level in Boreholes**

The measurement of water level in each of the five boreholes was the first exercise performed on getting to the site on each visit. This was an important exercise because it provided an estimate of the volume of water that should be purged and can be used in calculating groundwater flow directions and seasonal changes of the aquifer layer (Weaver *et al*, 2007). A dip meter was used in measuring the water level in each of the five boreholes. The dip meter was made up of a twin core cable and an ohm meter. The end of each cable was bared to avoid contact of the two ends. When the two bared end of the cable were immersed in the water, a signal was recorded by the ohm-meter. Therefore the bare cable ends were lowered into the borehole and when a deflection was observed on the ohm meter, it was concluded that the water level had been reached. The depth of the water level could be calculated from the length of the cable lowered into the borehole. This measurement gave the static depth to the water level in the

borehole. The standing/stagnant volume of water in the borehole could then be calculated using the following equation;

$$V = \frac{\Pi \times d^2 \times h}{4000} \quad [3.2]$$

Where;

V = Volume of standing/stagnant water in Litres

d = Diameter of borehole in millimetres

h = Height of water column in meters

The height of water column is calculated as;

$$\text{Borehole depth} - \text{static depth to water level} \quad [3.3]$$

### **Purging the Boreholes**

Purging of boreholes was an important exercise that was carried out before groundwater samples could be collected. This was done in order to remove any stagnant water in the borehole casings and ensure that groundwater samples collected originated from the aquifer layer. In practice, borehole purging generally involves pumping out a sufficient volume of water from a borehole until field parameters such as pH, electrical conductivity, dissolved oxygen, temperature and turbidity stabilize. pH, temperature and electrical conductivity were the three field parameters considered for the purging of the five boreholes at the Umlazi sludge burial site. Readings of the field parameters during the purging exercise were taken and logged at different time intervals and recorded, together with the volume of water pumped and all other field measurements.

### **Sample Collection**

It is necessary that water samples from boreholes be collected within six hours after purging of boreholes has been performed (Weaver *et al*, 2007). Samples from boreholes at the Umlazi sludge burial site were collected immediately after purging. The outlet valve on the pump discharge was usually throttled after purging to reduce the pump discharge rate before samples are taken such that water flowed slowly without aeration.

Sample bottles were properly labelled and samples were normally collected directly from the valve on the pump. Samples were then placed in the cooler box containing ice blocks and then transported to eThekweni water and sanitation laboratory for analysis.

### **Analysis conducted on collected groundwater samples**

#### **pH**

The pH was one of the field parameters used during the purging of the boreholes and the water sample pH was taken immediately after the field parameters became stable right at the well-head when samples are taken.

#### **Conductivity**

Conductivity was also one of the field parameters used during the purging of the boreholes and immediately the field parameter became stabilized, the conductivity for the groundwater samples was taken right at the borehole-head using a conductivity meter. The conductivity of the groundwater sample is an indication of the amount of soluble salts present in the groundwater sample.

#### **Temperature**

Temperature was also used as one of the field parameters to determine the required amount of water to be purge out of the boreholes and it was measured using a digital thermometer.

#### **Dissolved oxygen**

The measurement of dissolved oxygen is very important in monitoring groundwater quality in that, the valence state of many trace metals is been regulated by the presence of dissolved oxygen in the groundwater. It also constrains the bacteriological metabolism of organic compounds in groundwater (Domenico and Schwart, 1998). The dissolved oxygen concentration was measured at the borehole-head during the sampling process using a DO meter.

#### **Chloride and Sodium ions**



Chloride and sodium ions are among the major ions measured in groundwater, as they contribute to a large extent to the salinity in the groundwater and the quality of the water samples, since excessive amounts of these ions might affect the use of the groundwater for many purpose. The chloride and sodium ions were analyzed according to Standard methods (APHA, 1998) at the eThekwini Water and Sanitation Laboratories.

### **Chemical Oxygen Demand**

Chemical oxygen demand is a measure of the amount of oxidizable organic material in the groundwater samples. Chemical oxygen demand of water samples collected from the boreholes was determined using the closed reflux method (APHA, 1998) at the eThekwini Water and Sanitation Laboratories.

### **Ammonium and Nitrate**

Most groundwater monitoring programmes are usually directed towards the determination of ammonium and nitrate in the groundwater because they are usually the products of pollution in groundwater (Weaver *et al*, 2007). This is because in the presence of light and oxygen, high concentrations can lead to eutrophication and high concentration of nitrate in drinking water is toxic. Ammonium and Nitrate were analyzed according to Standard method (APHA, 1998) at the eThekwini Water and Sanitation Laboratories.

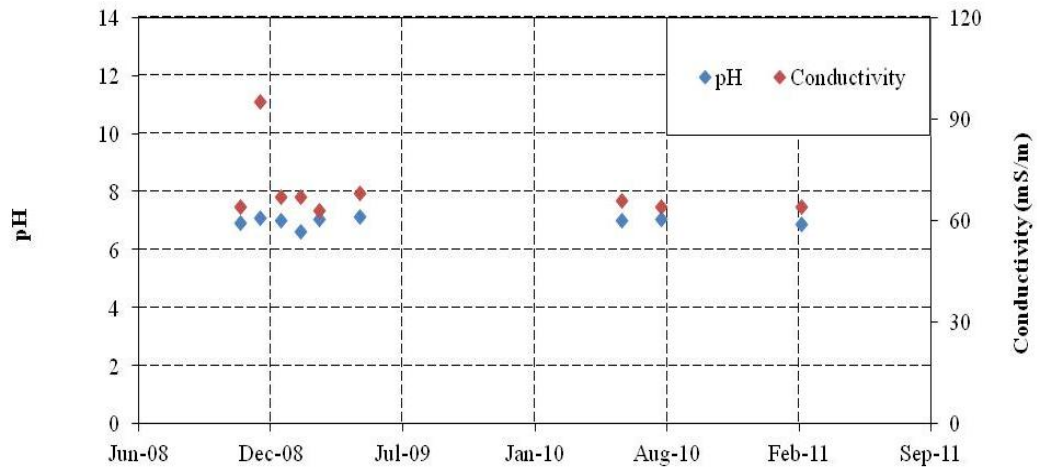
### **Orthophosphate**

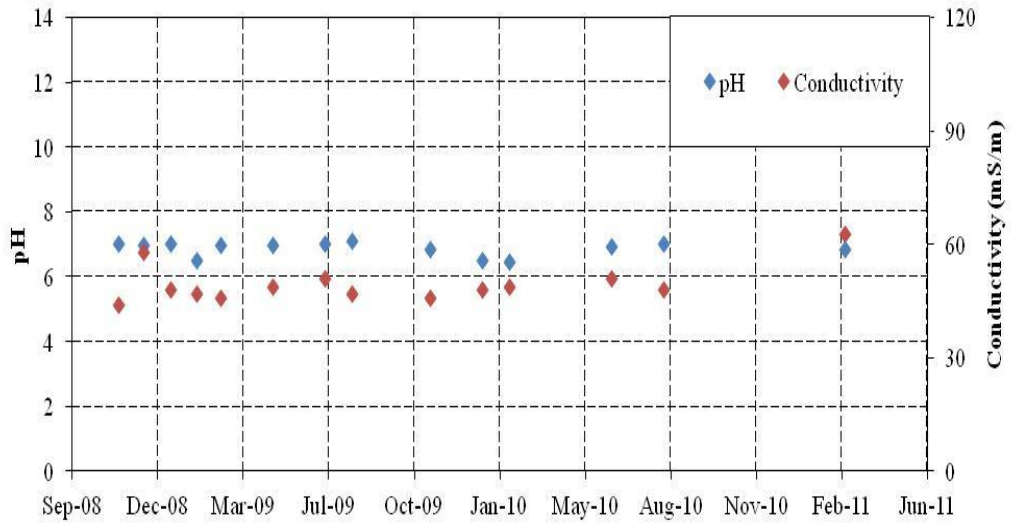
Orthophosphate is usually an important parameter in monitoring surface water but is of less interest in groundwater. However, the determination of orthophosphate was also included as one of the parameters to be used in monitoring changes in the groundwater at the Umlazi entrenchment site because of the likelihood of the presence of phosphate in the VIP latrine sludge buried and therefore changes in orthophosphate would indicate contamination by leachate from buried sludge.

### **E-coli, Total coliforms and Total organisms**

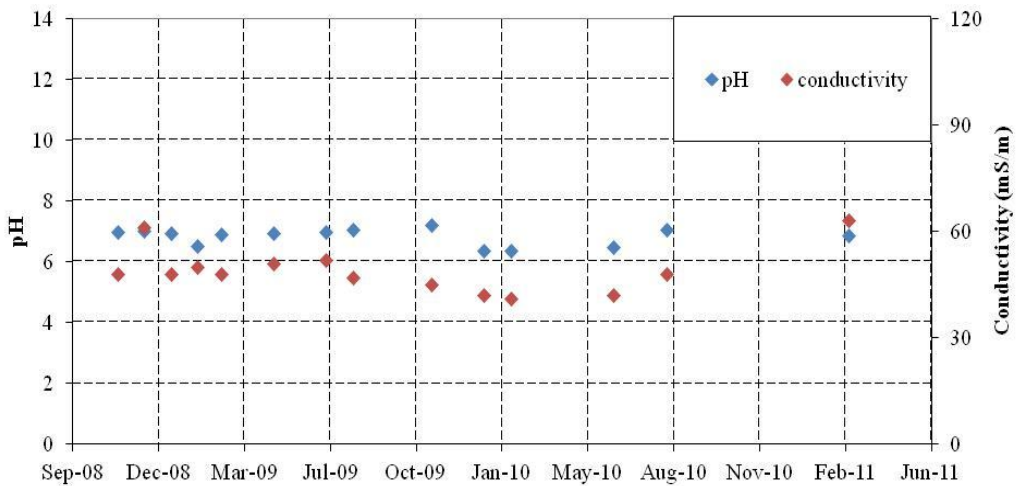
These analyses were performed on the sampled water from the five boreholes in order to determine the general microbiological quality of the water samples and also possible faecal pollution of the groundwater which might be as a result of the VIP latrine sludge buried.

**Plots of data obtained from the laboratory analysis of water samples from the monitoring boreholes**

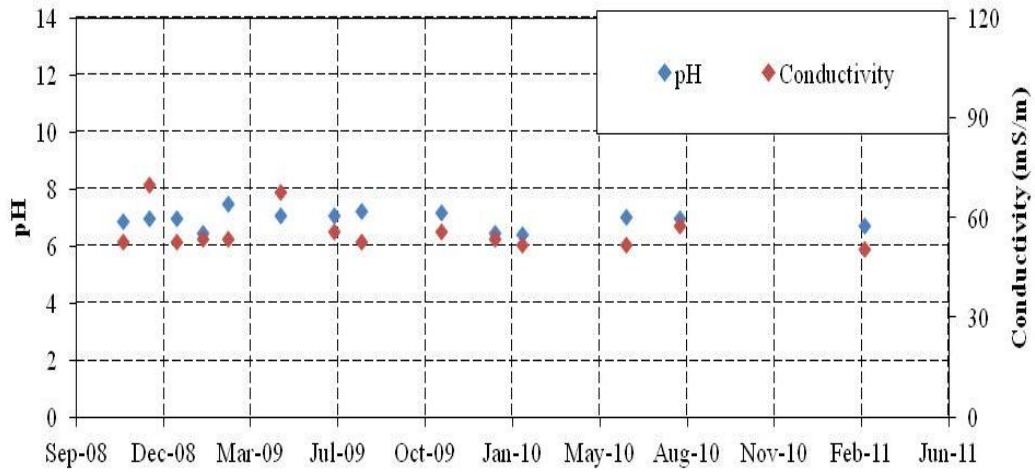




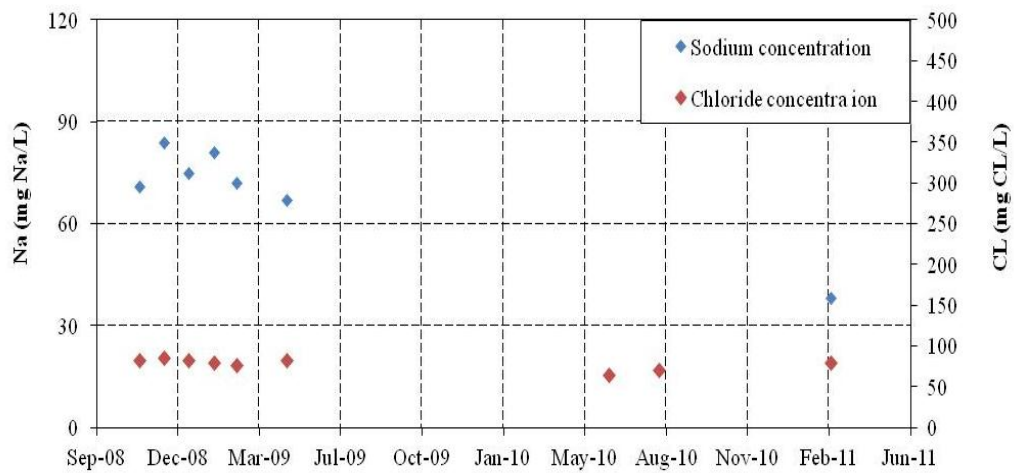
**pH and Conductivity Results for water samples from the monitoring Borehole 3 at the Umlazi VIP latrine sludge entrenchment site**



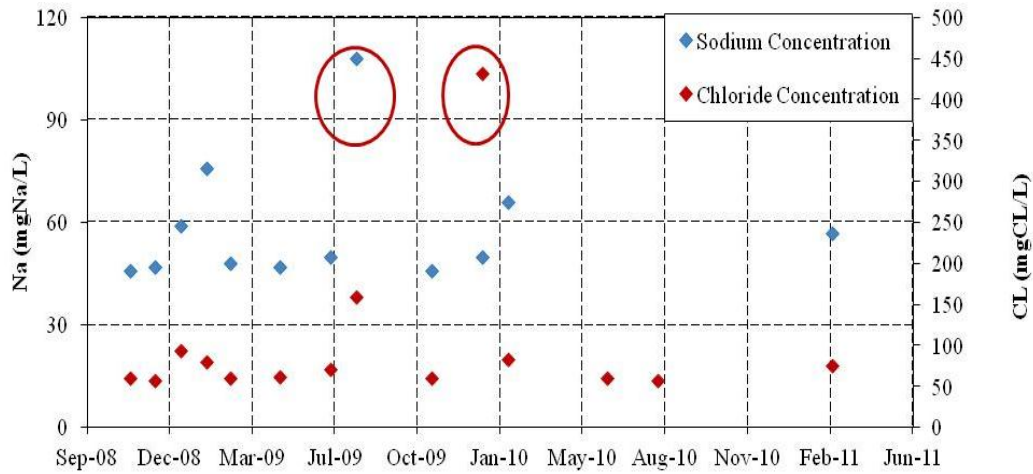
**pH and Conductivity Results for water samples from the monitoring Borehole 4 at the Umlazi VIP latrine sludge entrenchment site**



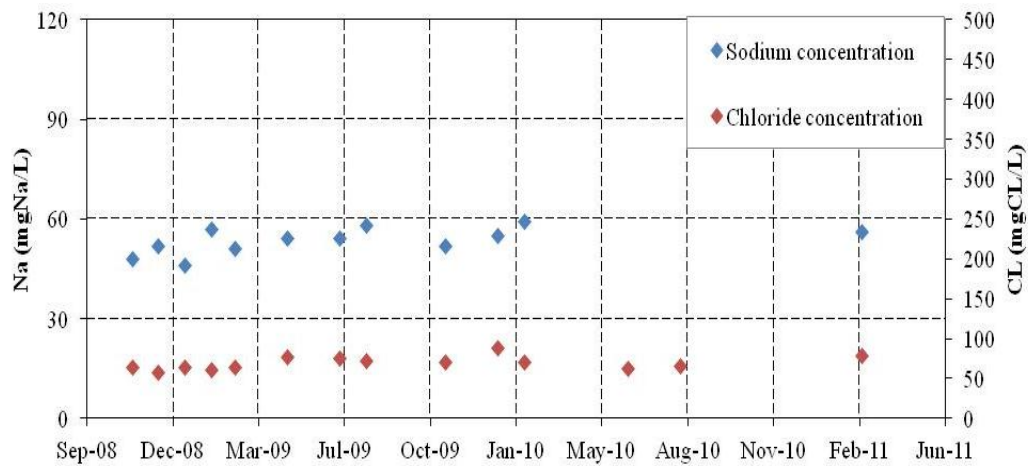
**pH and Conductivity Results for water samples from the monitoring Borehole 5 at the Umlazi VIP latrine sludge entrenchment site**



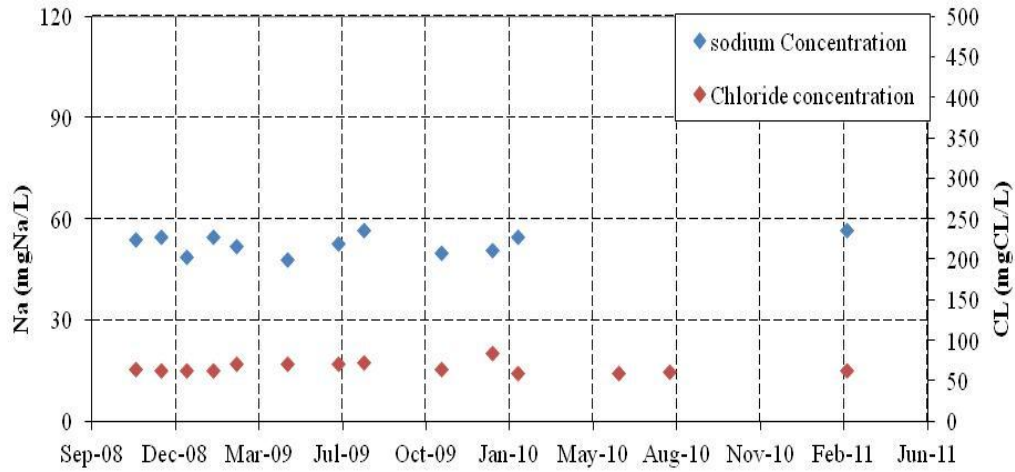
**Sodium (Na<sup>+</sup>) and Chloride (Cl<sup>-</sup>) concentration in water samples from the monitoring borehole 1 at the Umlazi VIP latrine sludge entrenchment site**



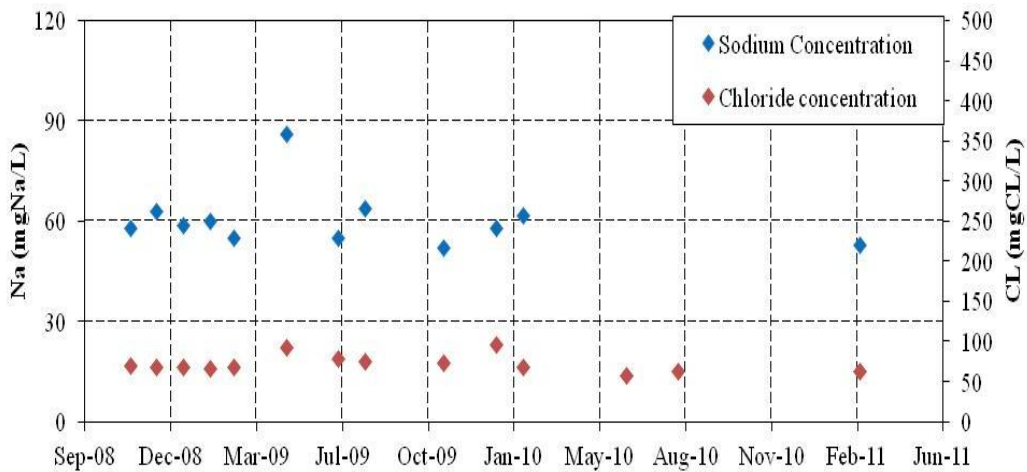
**Sodium ( $\text{Na}^+$ ) and Chloride ( $\text{Cl}^-$ ) concentration in water samples from the monitoring borehole 2 at the Umlazi VIP latrine sludge entrenchment site**



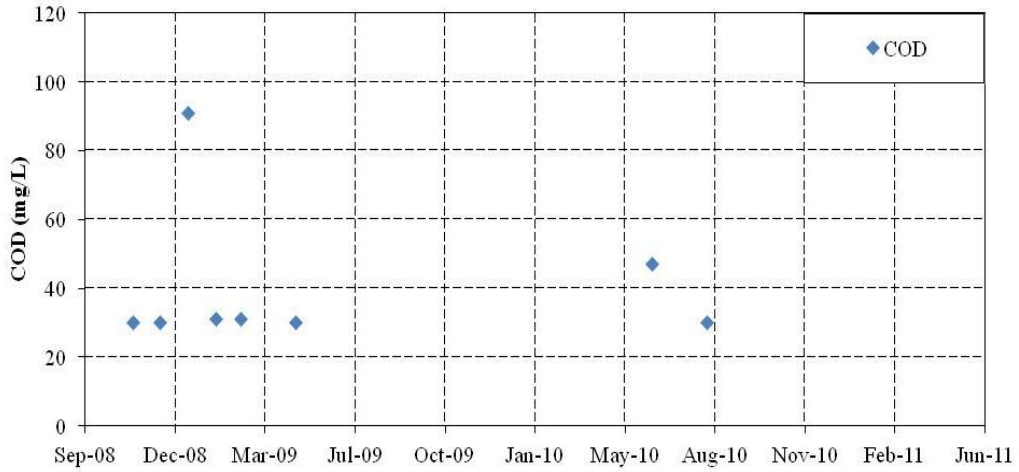
**Sodium ( $\text{Na}^+$ ) and Chloride ( $\text{Cl}^-$ ) concentration in water samples from the monitoring borehole 3 at the Umlazi VIP latrine sludge entrenchment site**



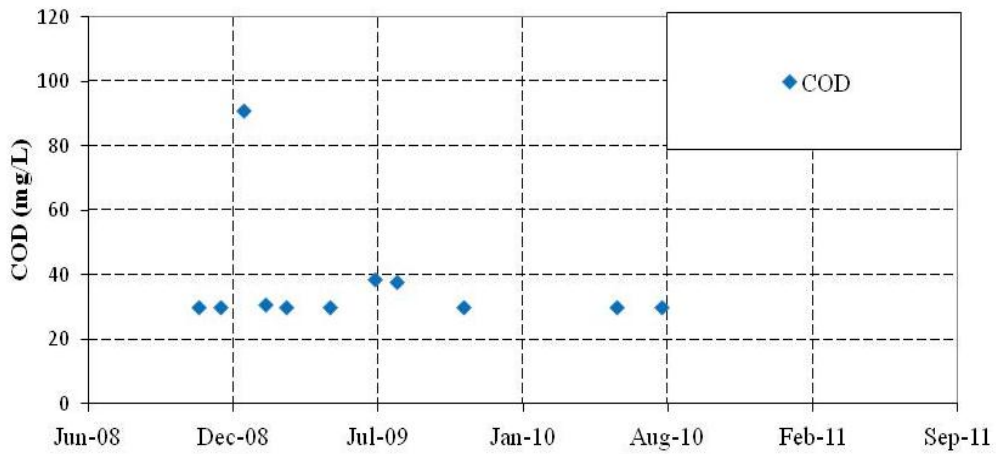
**Sodium (Na<sup>+</sup>) and Chloride (Cl<sup>-</sup>) concentration in water samples from the monitoring borehole 4 at the Umlazi VIP latrine sludge entrenchment site**



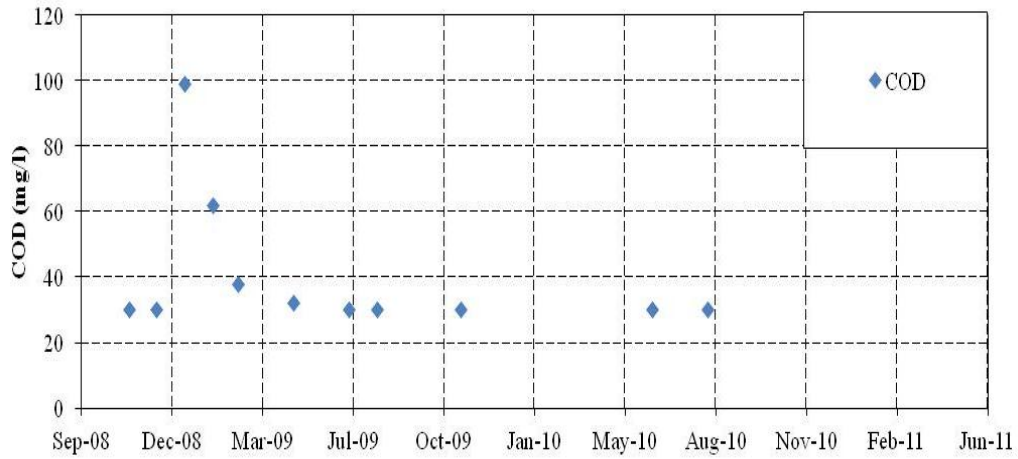
**Sodium (Na<sup>+</sup>) and Chloride (Cl<sup>-</sup>) concentration in water samples from the monitoring borehole 5 at the Umlazi VIP latrine sludge entrenchment site**



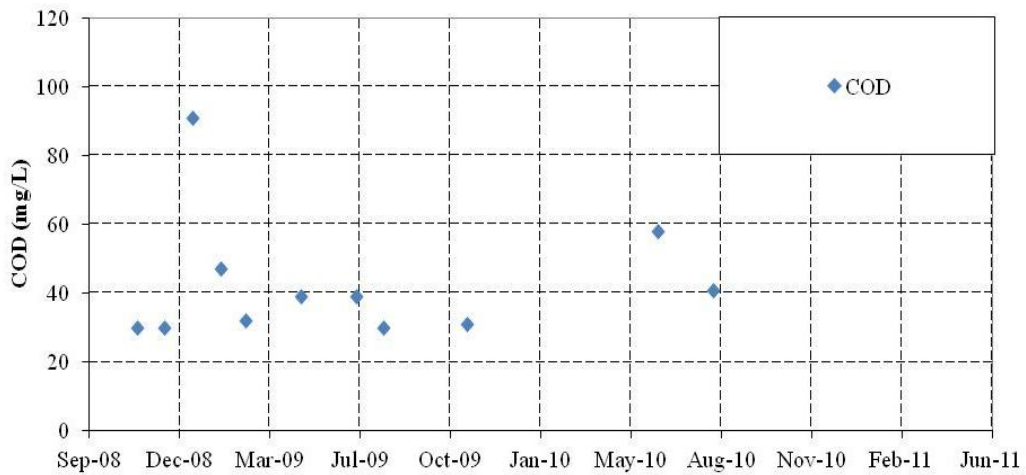
**Chemical Oxygen Demand in water samples from the monitoring borehole 1 at the Umlazi VIP latrine sludge entrenchment site**



**Chemical Oxygen Demand in water samples from the monitoring borehole 2 at the Umlazi VIP latrine sludge entrenchment site**

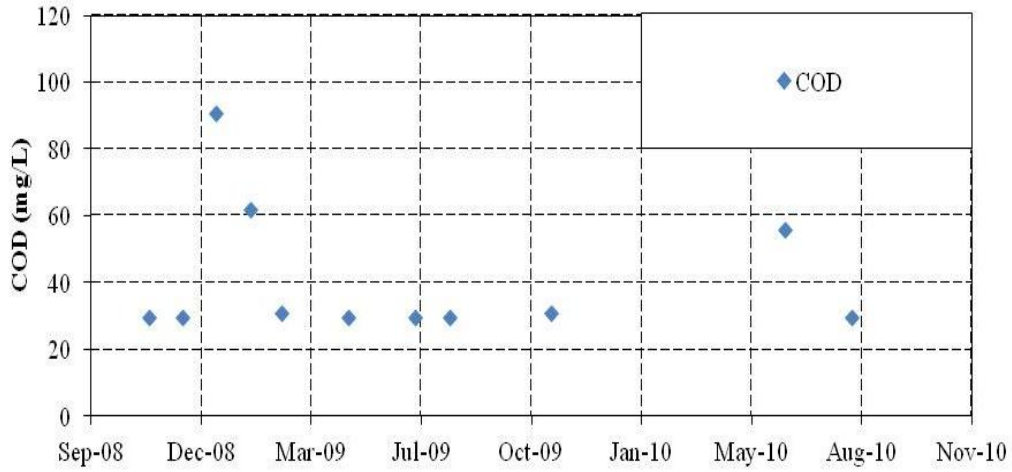


**Chemical Oxygen Demand in water samples from the monitoring borehole 3 at the Umlazi VIP latrine sludge entrenchment site**

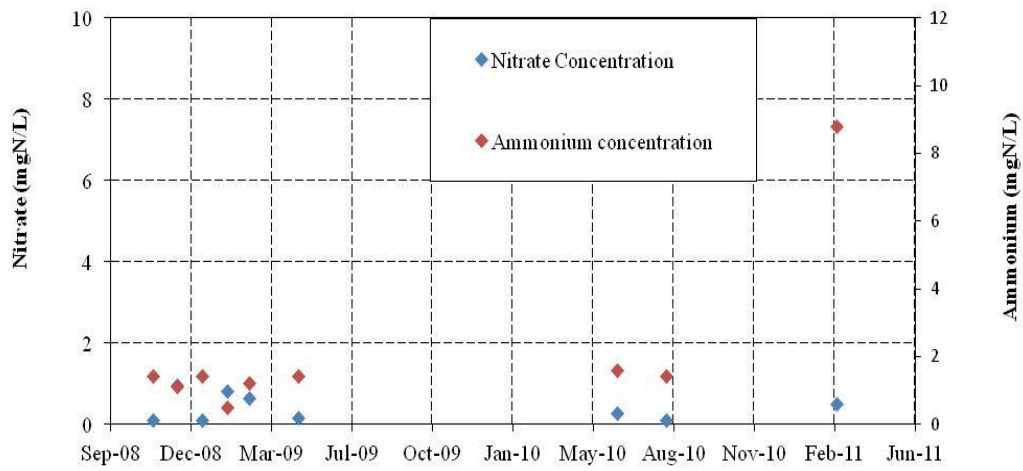


**Chemical Oxygen Demand in water samples from the monitoring borehole 4 at the Umlazi VIP latrine sludge entrenchment site**

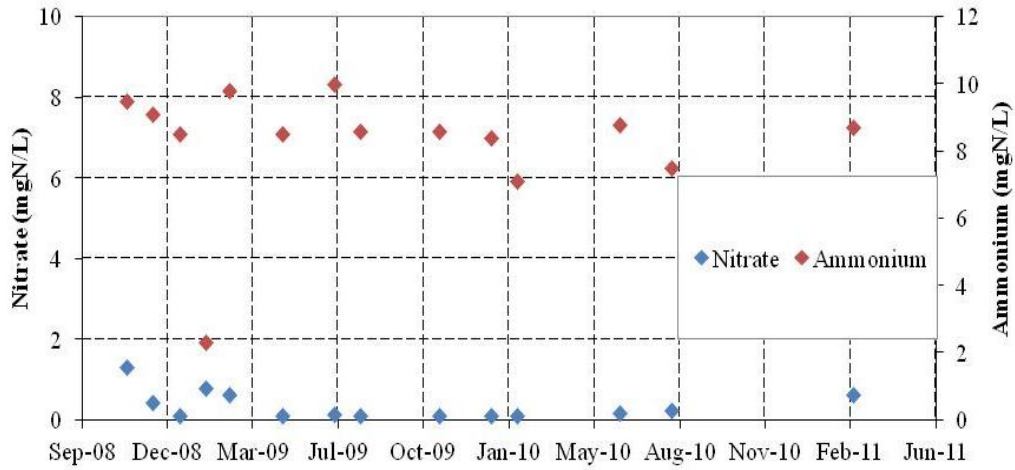




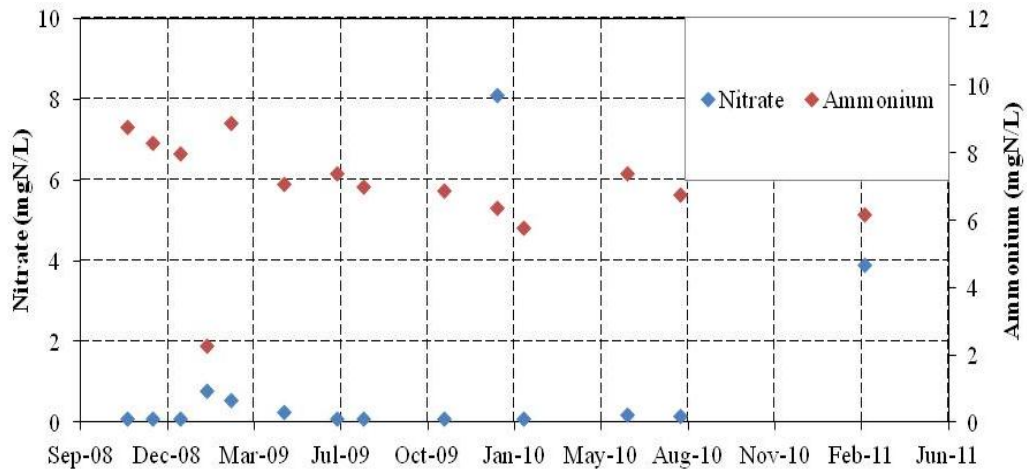
**Chemical Oxygen Demand in water samples from the monitoring borehole 5 at the Umlazi VIP latrine sludge entrenchment site**



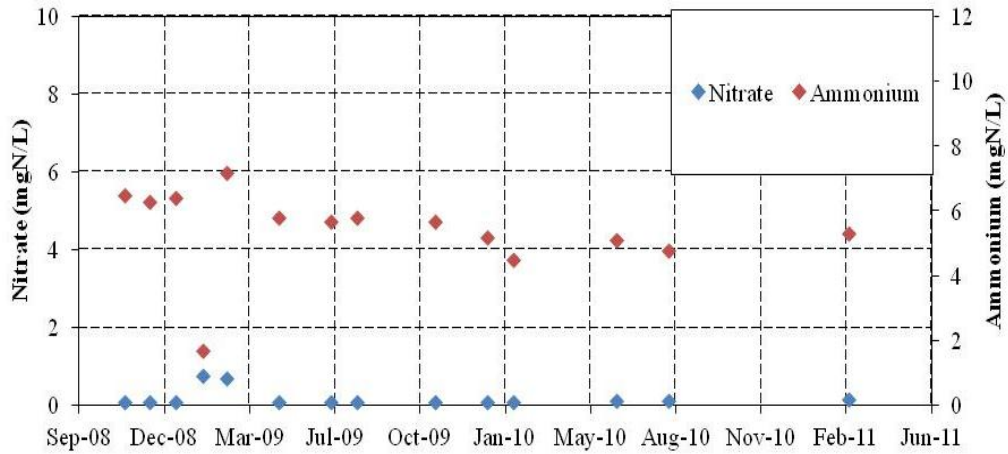
**Nitrate and Ammonium concentration in water samples from the monitoring borehole 1 at the Umlazi VIP latrine sludge entrenchment site**



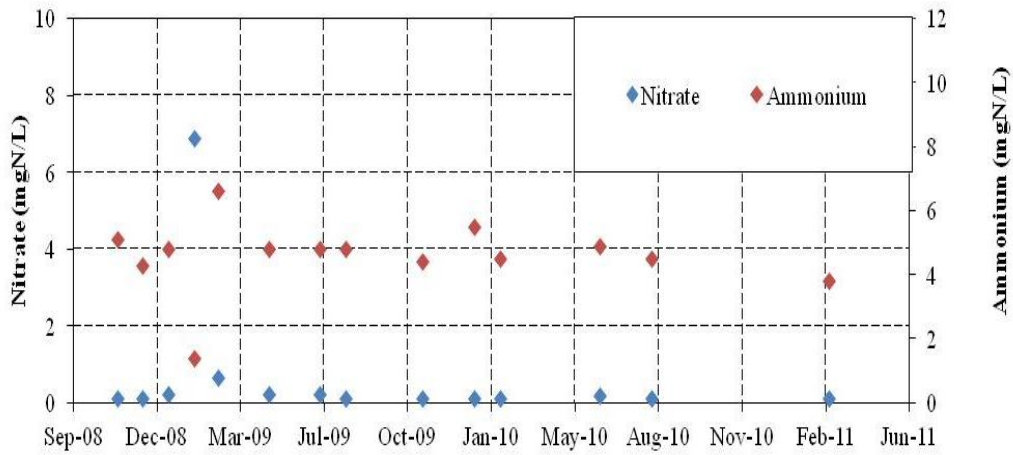
**Nitrate and Ammonium concentration in water samples from the monitoring borehole 2 at the Umlazi VIP latrine sludge entrenchment site**



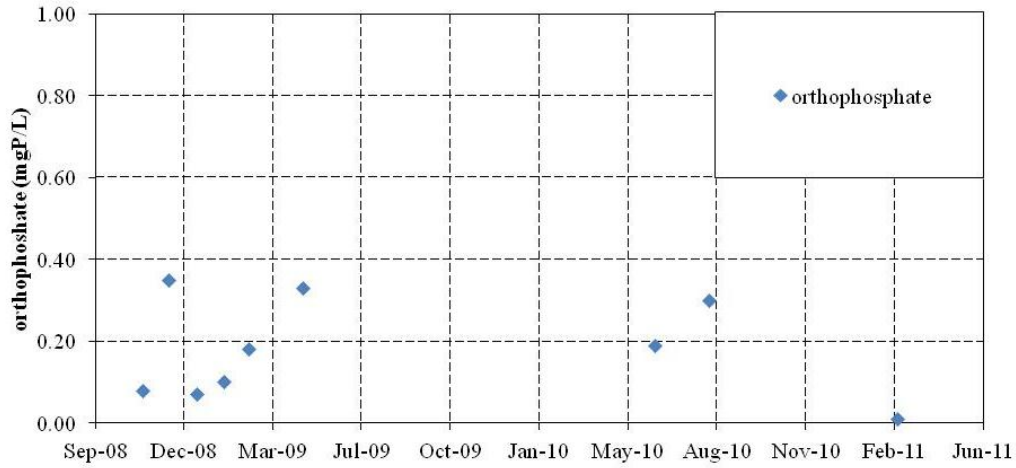
**Nitrate and Ammonium concentration in water samples from the monitoring borehole 3 at the Umlazi VIP latrine sludge entrenchment site**



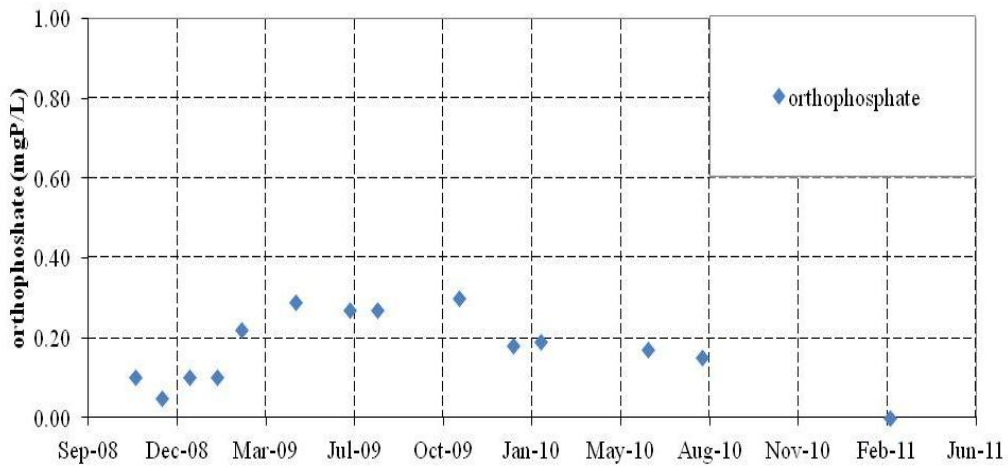
**Nitrate and Ammonium concentration in water samples from the monitoring borehole 4 at the Umlazi VIP latrine sludge entrenchment site**



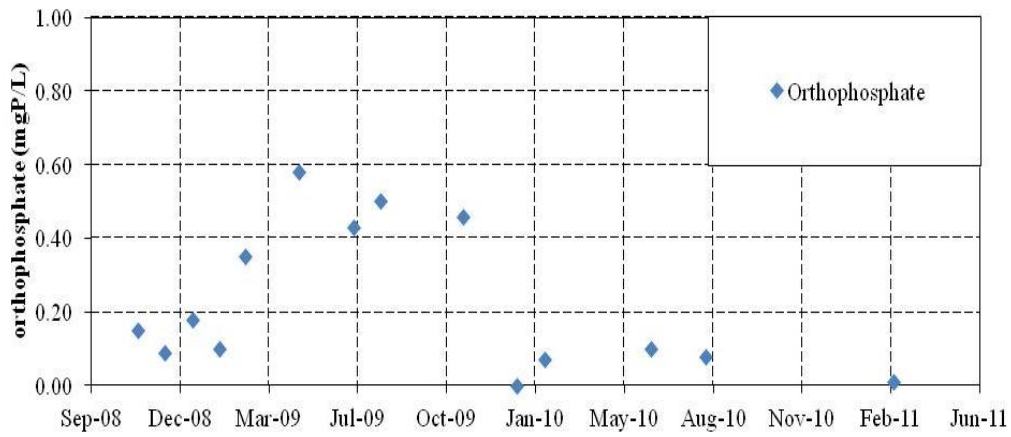
**Nitrate and Ammonium concentration in water samples from the monitoring borehole 5 at the Umlazi VIP latrine sludge entrenchment site**



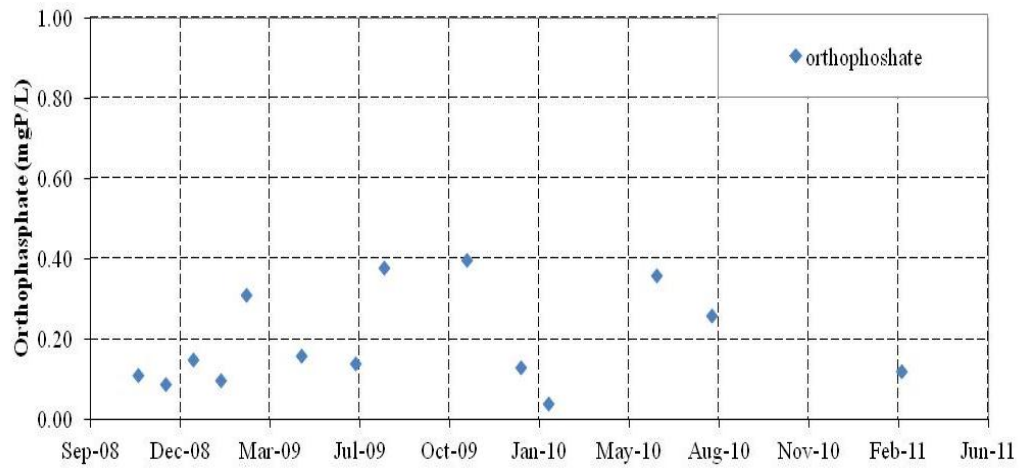
**Orthophosphate in water samples from the monitoring borehole 1 at the Umlazi VIP latrine sludge entrenchment site**



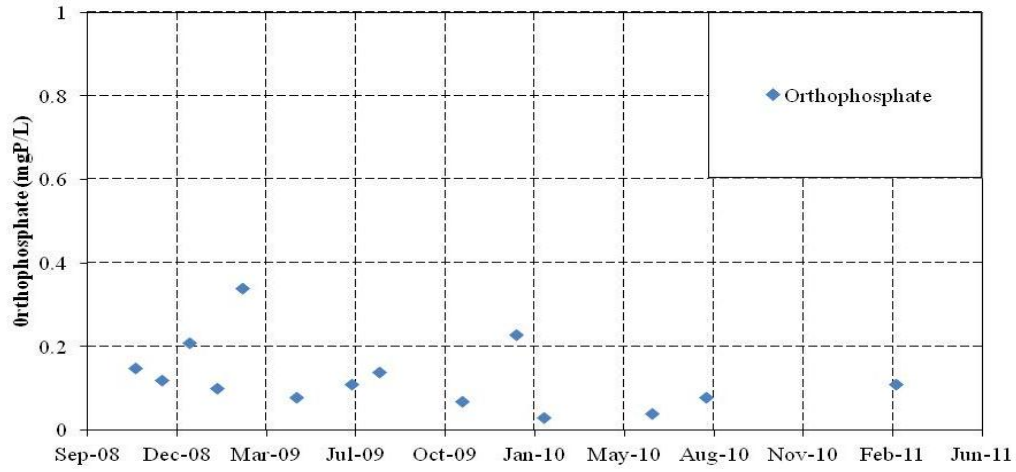
**Orthophosphate in water samples from the monitoring borehole 2 at the Umlazi VIP latrine sludge entrenchment site**



**Orthophosphate in water samples from the monitoring borehole 3 at the Umlazi VIP latrine sludge entrenchment site**



**Orthophosphate in water samples from the monitoring borehole 4 at the Umlazi VIP latrine sludge entrenchment site**



**Orthophosphate in water samples from the monitoring borehole 5 at the Umlazi VIP latrine sludge entrenchment site**

## APPENDIX D

---

---

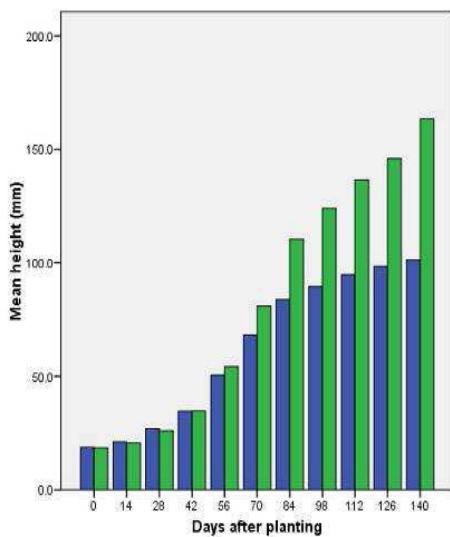
### **Effect of VIP Latrine sludge on tree growth**

#### Summary of MSc Study on tree growth

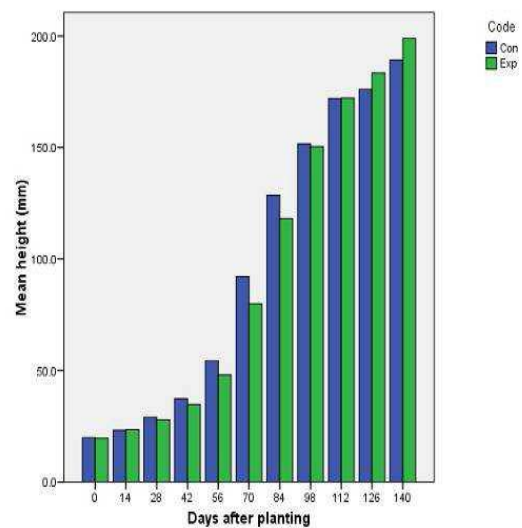
The effect of VIP latrine sludge on tree growth was tested in two ways: Firstly, an MSc project was undertaken by Craig Taylor which investigated the effect of pit latrine sludge on the growth of plant. A brief review of this study is presented in this section. In this study, two plant species were selected for the tree growth trials. These were *Eucalyptus grandis* and *Acacia mearnsii* (Flooded gum and Black wattle), a total of twenty four plant growth columns which was constructed from manhole rings 250 mm in height and 750 mm in diameter were used. The plant columns were constructed such that water could not penetrate through the base of each column. The plant columns were grouped into treatment groups which comprised of twelve columns and the remaining twelve columns served as the control groups for the experimental set up. The treatment groups were filled with pit latrine sludge collected from a local community within eThekweni Municipality and sand collected from the entrenchment site while the control groups were filled with only sand collected from the entrenchment site to the same height as the plant columns in the treatment group. The control groups were treated with fertilizers throughout the experimental duration so as to serve as a positive control experiment. A total of 24 plants were planted one in each column, six seedlings each of *Eucalyptus grandis* and *Acacia mearnsii* were planted into the treatment plant columns. The remaining six seedlings of each species were planted in the control plant columns. For all the plant columns, only healthy seedlings of similar height were selected for use and the same quantity of water was used to irrigate both the treatment and control experimental set up. In order to investigate the effect of pit latrine sludge burial in trenches on plant growth, three different methods were used;

- Measurement of plant height immediately after planting and every second week measurement were carried out thereafter for up to 140 days after planting. The plant height was measured from the base of each plant to the apical bud.
- Vernier callipers were also use to measure the diameter of the stem of each plant on a monthly basis throughout the duration of the experimental set up.
- Photosynthetic measurement in terms of light level and CO<sub>2</sub> concentration were also performed.

As presented in **Figure D.1 and D.2**, it was found that in all measurement performed, the application of pit latrine sludge content in the plant columns provided a valuable nutrients source for the tree planted. This was because measurements of tree height, diameter of tree stem as well as photosynthetic measurements were significantly increased in comparison to the control experiments except for the *A. mearnsii* plant which showed little changes in the height of the trees and stem diameter compared to the control. Thus, this study concluded that burial of pit latrine sludge in association with agroforestry has significant benefits.

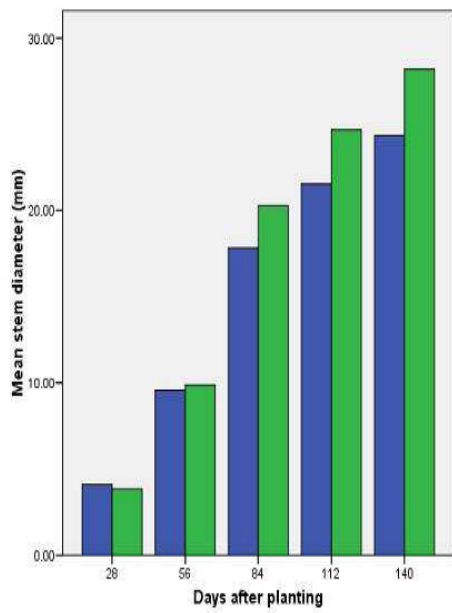


Eucalyptus

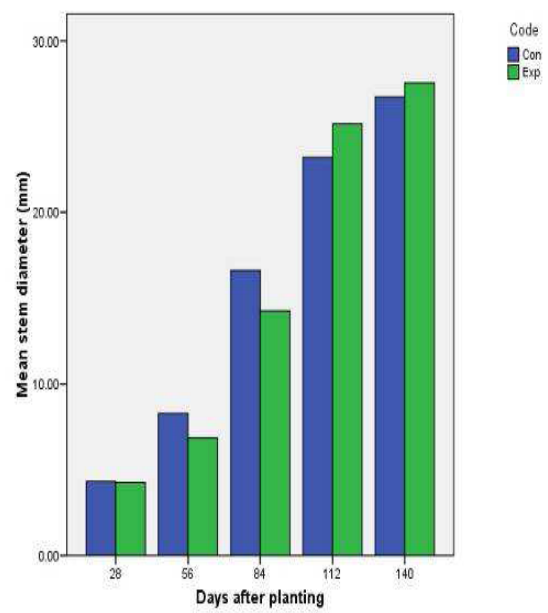


Acacia mearnsii



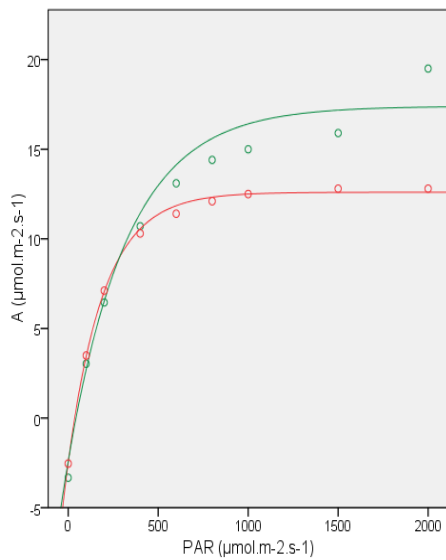


Eucalyptus

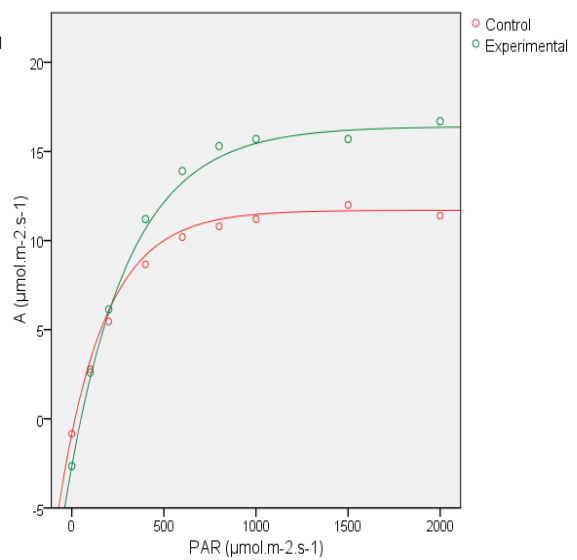


Acacia mearnsii

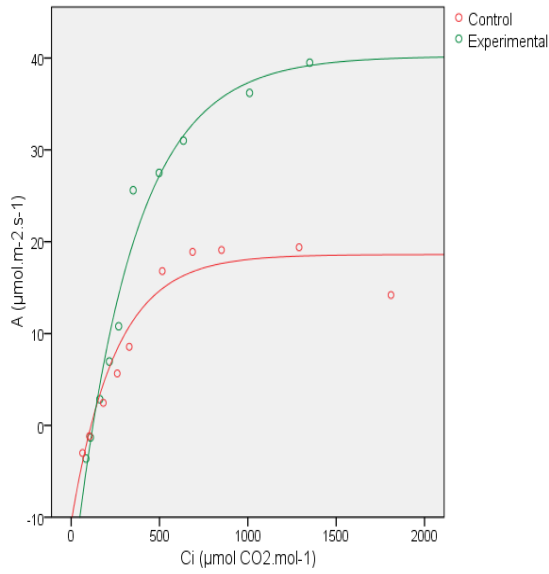
**Figure D.1: Measurement of plant height and stem diameter (Eucalyptus and Acacia mearnsii) in plant columns containing pit latrine sludge compared to plant columns without pit latrine sludge (control). (Reproduced with permission from Taylor, 2011)**



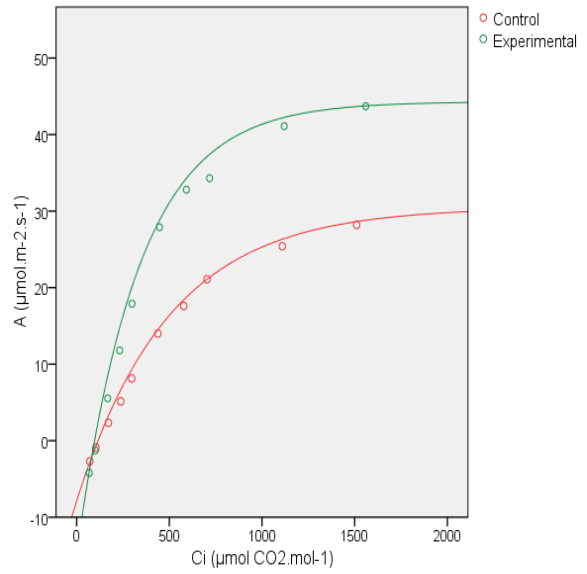
(a)



(b)



(c)



(d)

**Figure D.2: Light and CO<sub>2</sub> Response Curve for flooded gum tree and black wattle trees, where plot (a) and (b) represent the light response curve for flooded gum and black wattle trees respectively. Plot (c) and (d) represents the CO<sub>2</sub> response curve for flooded gum and black wattle trees respectively. (Reproduced with permission from Taylor, 2011).**

## APPENDIX E

---

---

### PUBLICATIONS ARISING FROM THIS PROJECT

This section presents a list of publication emanating from this project.

#### 1. RESEARCH REPORT

Tackling the challenges of full pit latrines; Volume 2: how fast do pit toilets fill up? A scientific understanding of sludge build up and accumulation in pit latrine (Water Research Commission Project No: 1745/2/12)

Investigating the potential of deep row entrenchment of pit latrine and wastewater treatment works sludge for agroforestry and land rehabilitation purposes (Water Research Commission Project K5/1829)

#### 2. JOURNAL ARTICLES

**B.F. Bakare**, K.M. Foxon, C.J Brouckaert and C.A Buckley (2012) Variation in VIP latrine Sludge Contents. *WaterSA* Vol. 38 No.4, pp 479-486

A.A-L. Couderc, C.A. Buckley, K. Foxon, C.F. Nwaneri, **B.F. Bakare**, T. Gounden and A. Battimelli (2008) The effect of moisture content and alkalinity on the anaerobic biodegradation of VIP contents. *Water Sci Technol.* **58** (2), pp. 473-477

#### 3. CONFERENCE PROCEEDINGS

**B.F. Bakare**, K.M. Foxon, R. Salisbury, C.J. Brouckaert, D. Still and C.A. Buckley (2008). Management of VIP latrines in the eThekweni Municipality. *Proceedings. 2008 Water Institute of Southern Africa (WISA) Biennial Conference and Exhibition, Sun City, South Africa, May 18-22, 2008*

C.F. Nwaneri, **B.F. Bakare**, K.M Foxon, and C.A. Buckley (2008). Biological Degradation processes within a Pit latrine. *Proceedings. 2008 Water Institute of Southern Africa (WISA) Biennial Conference and Exhibition, Sun City, South Africa, May 18-22, 2008*

**B.F. Bakare**, C.F. Nwaneri, K.M. Foxon, C.J Brouckaert and C.A Buckley (2010). Pit Latrine Additives: Laboratory and Field Trials. *Proceedings. 2010 Water Institute of Southern Africa (WISA) Biennial Conference and Exhibition, ICC Durban, South Africa, April 18-22, 2010.*

**B.F. Bakare**, C.F. Nwaneri, K.M. Foxon, C.J Brouckaert and C.A Buckley Entrenchment of VIP Sludge: Characteristics of the buried sludge. *Proceedings. 2010 Water Institute of Southern Africa (WISA) Biennial Conference and Exhibition, ICC Durban, South Africa, April 18-22, 2010* (poster).

#### **4. THESES**

Nwaneri C. F. (2009). *Physico-Chemical characteristics and biodegradability of contents of Ventilated Improved Pit latrines in eThekweni Municipality*. Master of Science dissertation. School of Biological and Conservation Science. University of KwaZulu-Natal. South Africa.

Taylor C. (in completion). *An investigation into potential of faecal sludge for plant production*. Master of Science dissertation. School of Biological and Conservation Science. University of KwaZulu-Natal. South Africa.

Woods K. (in completion). *Biological Degradation in VIPs: An Unsteady State Mass Balance Approach*. Master of Science dissertation. School of Chemical Engineering University of KwaZulu-Natal. South Africa

