

# Compendium of Sanitation Technologies in Emergencies

1<sup>st</sup> Edition





# Compendium of Sanitation Technologies in Emergencies

1<sup>st</sup> Edition

**Robert Gensch** (GTO), **Amy Jennings** (BORDA),  
**Samuel Renggli** (Eawag), **Philippe Reymond** (Eawag)

We would like to thank the following individuals  
and their organisations/institutions for  
their invaluable contributions to this publication:

Djilali Abdelghafour, Nienke Andriessen, Leonelha Barreto-Dillon, Andy Bastable, Magdalena Bäuerl, Benjamin Bernardino, Damian Blanc, Franck Bouvet, Patrick Bracken, Chris Buckley, Marc-Andre Bünzli, Chris Canaday, Daniel Clauss, Benjamin Dard, Malcolm Dickson, Paul Donahue, Georg Ecker, Miriam Englund, Marta Fernández Cortés, Suzanne Ferron, Claire Furlong, Sergio Gelli, Feline Gerstenberg, Moritz Gold, Celia González Otálora, Peter Harvey, Oliver Hoffmann, Tineke Hooijmans, Andrews Jacobs, Heidi Johnston, Christopher Kellner, Anthony Kilbride, Sasha Kramer, Jenny Lamb, Günther Langergraber, Anne Lloyd, Andreas Ludwig, Christoph Lüthi, Saskia Machel, Grover Mamani, Adeline Mertenat, Mona Mijthab, Alexander Miller, Patrice Moix, Paolo Monaco, Bella Monse, Hans-Joachim Mosler, Burt Murray, Arne Panesar, Thilo Panzerbieter, Jonathan Parkinson, Dominique Porteaud, Nick Preneta, Torsten Reckerzügl, Bob Reed, Stefan Reuter, Romain Revol, Nina Röttgers, Johannes Rück, Vasco Schelbert, Jan-Christoph Schlenk, Jan-Hendrik Schmidt, Stephanie Schramm, Jan Spit, Haakon Spriewald, Steve Sugden, Annkatrin Tempel, Elisabeth Tilley, Erika Trabucco, Tobias Ulbrich, Lukas Ulrich, Claudio Valsangiacomo, Joel Velimsky, Grégoire Virard, Sophia von Dobschuetz, Barbara Ward, Cornelia Wiekort, Megan Wilson-Jones, Alexander Wriege-Bechthold, Imanol Zabaleta, Fiona Zakaria, Chris Zurbrügg

Our special thanks for hosting the online  
platform of the compendium go to:

The Global WASH Cluster  
The Sustainable Sanitation Alliance and  
its Secretariat hosted by GIZ

We would like to acknowledge  
support from:

The German Federal Foreign Office  
The Swiss Agency for Development and  
Cooperation (SDC)



sustainable  
sanitation  
alliance



# Foreword

Sanitation has the potential to save lives; poorly implemented or managed sanitation does not. Reality has taught us that to safe-guard lives we must look beyond the toilet, considering the full sanitation chain: from the toilet via collection, transport, treatment to the safe disposal or reuse. The complexity of the issue, combined with the wide range of contexts and crisis settings remains a challenge to many organisations – an acknowledged gap in the sector. How can we all ensure a high quality of response with regard to sanitation?

This publication is an essential contribution to the sector – providing an excellent capacity building and decision support tool for sanitation solutions in humanitarian contexts. Thereby it helps to improve the coordination that we as a Cluster strive for, as good coordination can only take place if all actors in the field have the required tools and technical capacity, and speak the same technical language. By producing a humanitarian counterpart publication to the existing Compendium of Sanitation Systems and Technologies, widely used in the development sector, this document also contributes to the complementarity between the humanitarian and development WASH realms.

Together with the Global WASH Cluster partners and under the leadership of German WASH Network, Eawag and the Sustainable Sanitation Alliance, the creation of this publication has been an amazing collaborative effort with contributions from a multitude of international sector experts and organisations – striving to present the whole spectrum of sanitation technologies and systems, being as unbiased to single technical solutions as possible.

In a next step, the Global WASH Cluster is delighted to host the online version of this compendium together with the Sustainable Sanitation Alliance. We are grateful to the partners and donors, who have made this possible through their past and continuous support.

Dominique Porteaud  
Global WASH Cluster Coordinator

# Table of Contents

## Introduction

|   |    |
|---|----|
| Background and Target Audience                      | 8  |
| Structure and Use of the Compendium                 | 8  |
| Compendium Terminology                              | 9  |
| Sanitation System Template and Technology Selection | 12 |
| Disaster and Crisis Scenarios                       | 14 |
| Emergency Phases                                    | 16 |
| Key Decision Criteria                               | 17 |
| Technology Overviews for Different Contexts         | 20 |

## PART 1: Technology Overview

|  |    |
|--|----|
| General Technology Overview (including Cross-Cutting Issues) | 22 |
| Sanitation Technologies in Different Emergency Phases        | 23 |
| Sanitation Technologies for Challenging Ground Conditions    | 24 |
| Water-Based and Dry Sanitation Technologies                  | 25 |

### **U** User Interface **26**

|     |                            |    |
|-----|----------------------------|----|
| U.1 | Dry Toilet                 | 28 |
| U.2 | Urine Diversion Dry Toilet | 30 |
| U.3 | Urinals                    | 32 |
| U.4 | Flush Toilet               | 34 |
| U.5 | Controlled Open Defecation | 36 |
| U.6 | Shallow Trench Latrine     | 38 |
| U.7 | Handwashing Facility       | 40 |

### **S** Collection and Storage/Treatment **42**

|      |  |    |
|------|--|----|
| S.1  | Deep Trench Latrine                                    | 44 |
| S.2  | Borehole Latrine                                       | 46 |
| S.3  | Single Pit Latrine                                     | 48 |
| S.4  | Single Ventilated Improved Pit (VIP)                   | 50 |
| S.5  | Twin Pit Dry System                                    | 52 |
| S.6  | Twin Pit with Pour Flush                               | 54 |
| S.7  | Raised Latrine   | 56 |
| S.8  | Single Vault Urine Diversion Dehydration Toilet (UDDT) | 58 |
| S.9  | Double Vault Urine Diversion Dehydration Toilet (UDDT) | 60 |
| S.10 | Container-Based Toilet                                 | 62 |
| S.11 | Chemical Toilet  | 64 |
| S.12 | Worm-Based Toilet (Emerging Technology)                | 66 |
| S.13 | Septic Tank  | 68 |

|      |  |    |
|------|--|----|
| S.14 | Anaerobic Baffled Reactor (ABR)                                | 70 |
| S.15 | Anaerobic Filter   | 72 |
| S.16 | Biogas Reactor   | 74 |
| S.17 | Hydrated Lime Treatment (Emerging Technology)                  | 76 |
| S.18 | Urea Treatment (Emerging Technology)                           | 78 |
| S.19 | Lactic Acid Fermentation (LAF) Treatment (Emerging Technology) | 80 |
| S.20 | Caustic Soda Treatment (Emerging Technology)                   | 82 |

## **C** Conveyance **84**

|     |                                  |    |
|-----|----------------------------------|----|
| C.1 | Manual Emptying and Transport    | 86 |
| C.2 | Motorised Emptying and Transport | 88 |
| C.3 | Simplified Sewer                 | 90 |
| C.4 | Conventional Gravity Sewer       | 92 |
| C.5 | Stormwater Drainage              | 94 |
| C.6 | Transfer Station and Storage     | 96 |

## **T** (Semi-) Centralised Treatment **98**

|      |   |     |
|------|---|-----|
| PRE  | Pre-Treatment Technologies                                | 100 |
| T.1  | Settler   | 102 |
| T.2  | Anaerobic Baffled Reactor (ABR)                           | 104 |
| T.3  | Anaerobic Filter  | 106 |
| T.4  | Biogas Reactor  | 108 |
| T.5  | Waste Stabilisation Ponds                                 | 110 |
| T.6  | Constructed Wetland                                       | 112 |
| T.7  | Trickling Filter  | 114 |
| T.8  | Sedimentation and Thickening Ponds                        | 116 |
| T.9  | Unplanted Drying Bed                                      | 118 |
| T.10 | Planted Drying Bed  | 120 |
| T.11 | (Co-)Composting   | 122 |
| T.12 | Vermicomposting and Vermifiltration (Emerging Technology) | 124 |
| T.13 | Activated Sludge  | 126 |
| POST | Tertiary Filtration and Disinfection                      | 128 |

## **D** Use and/or Disposal **130**

|      |  |     |
|------|--|-----|
| D.1  | Application of Stored Urine                        | 132 |
| D.2  | Application of Dried Faeces                        | 134 |
| D.3  | Application of Pit Humus and Compost               | 136 |
| D.4  | Application of Sludge                              | 138 |
| D.5  | Fill and Cover: Arborloo and Deep Row Entrenchment | 140 |
| D.6  | Surface Disposal and Sanitary Landfill             | 142 |
| D.7  | Use of Biogas                                      | 144 |
| D.8  | Co-Combustion of Sludge (Emerging Technology)      | 146 |
| D.9  | Leach Field  | 148 |
| D.10 | Soak Pit   | 150 |
| D.11 | Irrigation   | 152 |
| D.12 | Water Disposal and Groundwater Recharge            | 154 |
| D.13 | Fish Ponds   | 156 |

## PART 2: Cross-Cutting Issues

|          |  |            |
|----------|--|------------|
| <b>X</b> | <b>Initial Situation</b>                                       | <b>160</b> |
| X.1      | Assessment of the Initial Situation                            | 160        |
| X.2      | Rehabilitation of Existing Infrastructure                      | 161        |
| X.3      | Soil and Groundwater Assessment                                | 162        |
| X.4      | Institutional and Regulatory Environment                       | 165        |
| <b>X</b> | <b>Conceptual Aspects</b>                                      | <b>166</b> |
| X.5      | Resilience and Preparedness                                    | 166        |
| X.6      | Exit Strategy, Hand-Over and Decommissioning of Infrastructure | 168        |
| X.7      | Urban Settings and Protracted Crisis Scenarios                 | 169        |
| X.8      | Solid Waste Management   | 171        |
| X.9      | Cholera Prevention and Epidemic Management                     | 173        |
| <b>X</b> | <b>Design and Social Considerations</b>                        | <b>176</b> |
| X.10     | Inclusive and Equitable Design                                 | 176        |
| X.11     | Child Excreta Management                                       | 179        |
| X.12     | Hygiene Promotion and Working with Affected Communities        | 179        |
| X.13     | Market-Based Programming                                       | 182        |

## Appendix

|                          |     |
|--------------------------|-----|
| Glossary                 | 186 |
| References               | 190 |
| Bibliographic References | 198 |

# Introduction

## Background and Target Audience

Appropriate and adequate sanitation solutions are crucial for the protection of human and environmental health in emergencies. In recent years there has been an increasing number of sanitation innovations, appropriate for a variety of humanitarian contexts and a stronger sector focus on the entire sanitation service chain (from the toilet via collection and conveyance to the final treatment and safe disposal and/or reuse).

Building on these developments, the Compendium of Sanitation Technologies in Emergencies provides a comprehensive, structured and user-friendly manual and planning guide for sanitation solutions in emergency settings. It serves as a systematic overview of existing and emerging sanitation technologies appropriate for use in humanitarian emergency settings along the entire sanitation service chain.

The target audience includes humanitarian field workers, local first responders, engineers, planners, relevant government representatives, capacity building agencies and WASH professionals involved in humanitarian response.

Although humanitarian WASH interventions primarily focus on immediate life saving measures, the humanitarian community has been increasingly confronted with longer-term protracted crises often situated in urban and camp contexts, with a need to serve refugees and host communities at the same time and to better link relief, rehabilitation and development (LRRD). The publication addresses this reality by covering technologies suitable from acute response to the stabilisation and recovery phase, addressing a broad spectrum of scenarios that humanitarian WASH practitioners may encounter when planning, implementing and operating appropriate sanitation services.

The Compendium of Sanitation Technologies in Emergencies is the humanitarian response counterpart to the existing “Compendium of Sanitation Systems and Technologies” developed by Eawag in collaboration with International Water Association (IWA) and the Sustainable Sanitation Alliance (SuSanA), primarily for the development context. Like the original compendium, it disaggregates sanitation systems into their functional components and clarifies terminology used, the application ranges and the input and output products for emergency sanitation systems.

The Compendium of Sanitation Technologies in Emergencies is primarily a capacity building tool and reference book. In addition, it supports and enables decision

making by providing the necessary framework for designing a sanitation system, by giving concise information on key decision criteria for each technology, facilitating the combination of technologies to come up with full sanitation system solutions and linking it to relevant cross-cutting issues. The publication can be seen as a starting point to access relevant information for the design of suitable sanitation system solutions. The users are also directed to additional information through further references in the publication and through an interactive online version ([www.washcluster.net/emersancompendium](http://www.washcluster.net/emersancompendium)) with additional information and tools (case studies, pictures, video tutorials, a comprehensive library and a forum).

This publication is not a detailed design manual, rather it is a user-friendly toolkit meant to facilitate informed decision-making in designing emergency sanitation systems. As such, the publication is meant to be used in conjunction with other available publications and tools.

## Structure and Use of the Compendium

The compendium consists of three major sections:

### Introduction

The introductory chapter describes the structure of the compendium, defines key terminology and provides a sanitation system template useful in configuring emergency sanitation systems. In addition, the introductory chapter provides background information on different emergency scenarios and phases of emergencies and the implications for sanitation infrastructure. Compendium users are encouraged to review the sections “Compendium Terminology” (**page 9**) and “Emergency Sanitation System Template and Technology Selection” (**page 12**), to ensure familiarity with key terms and the sanitation system thinking. This section also introduces the key selection criteria that users should keep in mind when selecting sanitation technologies and designing a context-appropriate sanitation system. The subsequent individual technology information sheets are based on these key technology selection criteria.

### Part 1: Technology Compilation

This core section of the publication is a comprehensive compilation of relevant sanitation technologies that can potentially be implemented in different emergency settings. The technologies are categorised and ordered according to the functional group to which they belong (**U** User Interface, **S** Collection and Storage, **C** Conveyance, **T** Treatment, **D** Use/Disposal).



The section starts with a general overview of all technologies presented in this publication and three more specific overviews of technologies considering their appropriateness (1) to different phases of an emergency, (2) to areas with challenging ground conditions, and (3) as water-based or dry sanitation systems. It is followed by a compilation of 61 “Technology Information Sheets”; 2-page summaries for each technology providing the compendium user with an overview of the basic working principles and design considerations as well as key information regarding applicability, cost implications, space and materials needed, operation and maintenance (O&M) requirements etc.

## Part 2: Cross-Cutting Issues

This section presents cross-cutting issues and background information that should be considered when making technology and design decisions. It includes requirements for an (1) initial assessment ranging from soil and groundwater assessment, rehabilitation and upgrading of existing infrastructure to information on the existing institutional and regulatory environment), (2) conceptual aspects like resilience and preparedness, exit strategy and handover of infrastructure and specific features of urban settings, and (3) design and social considerations like inclusive and equitable design, child excreta management and hygiene promotion.

## Compendium Terminology

### Sanitation System

A sanitation system is a multi-step process in which sanitation products such as human excreta and wastewater are managed from the point of generation to the point of use or ultimate disposal. It is a context-specific series of technologies and services for the management of these sanitation products, i.e. for their collection, containment, transport, treatment, transformation, use or disposal. A sanitation system comprises functional groups of technologies that can be selected according to context. By selecting technologies from each applicable functional group, considering the incoming and

outgoing products, and the suitability of the technologies in a particular context, a logical, modular sanitation system can be designed. A sanitation system also includes the management and operation and maintenance (O&M) required to ensure that the system functions safely and sustainably.

### Sanitation Technology

Sanitation technologies are defined as the specific infrastructure, methods, or services designed to collect, contain, transform and treat products, or to transport products to another functional group. Each of the 61 technologies included in this compendium is described on a 2-page technology information sheet in the technology compilation section. Only those sanitation technologies that have been sufficiently proven and tested are included, with a few notable exceptions of emerging technologies, which are clearly marked as such. The compendium is primarily concerned with systems and technologies directly related to managing human excreta. It does not specifically address greywater and only partially addresses stormwater management, although it does signal when a specific technology can be used to co-treat stormwater or greywater with excreta. Greywater and stormwater technologies are thus not described in detail, but are still shown as products in the system templates.

### Sanitation Product

Sanitation products can be materials that are generated directly by humans (e.g. urine, faeces and greywater from bathing, cooking and cleaning), that are required for the technologies to function (e.g. flushwater to flush excreta through sewers) or are generated as a function of storage or treatment (e.g. sludge). For the design of a robust sanitation system, it is necessary to identify all of the products that are flowing into (inputs) and out of (outputs) each of the sanitation technologies of the system. The products referenced within this text are described below. Solid waste is not included as a sanitation product as it should not enter the sanitation chain. It will be dealt with separately. Solid waste management is introduced in the cross-cutting issue section (X.8).

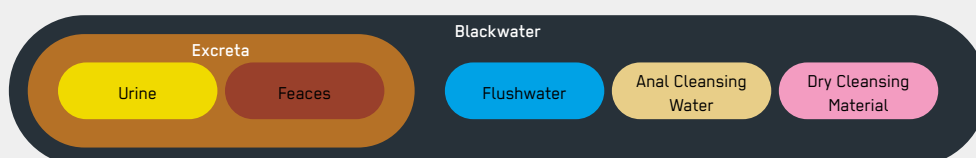

Figure 1:  
Definition of Excreta  
and Blackwater

## Primary (Input) Products

- Urine
- Faeces
- Excreta
- Dry Cleansing Materials
- Anal Cleansing Water
- Flushwater
- Blackwater
- Greywater
- Organics
- Stormwater
- Menstrual Hygiene Products

## Secondary (Output) Products

- Stored Urine
- Dried Faeces
- Compost
- Pit Humus
- Sludge
- Effluent
- Biogas
- Biomass
- Pre-Treatment Products

Figure 2:  
Sanitation Input and  
Output Products

**Anal Cleansing Water** is water used to cleanse the body after defecating and/or urinating; it is generated by those who use water, rather than dry material, for anal cleansing. The volume of water used per cleaning typically ranges from 0.5–3 litres (but can be more in developed urban areas).

**Biogas** is the common name for the mixture of gases released from the anaerobic digestion of organic material. Biogas comprises methane (50 to 75%), carbon dioxide (25 to 50%) and varying quantities of nitrogen, hydrogen sulphide, water vapour and other components, depending on the material being digested. Biogas can be collected and burned for fuel (like propane).

**Biomass** refers to plants or animals grown using the water and/or nutrients flowing through a sanitation system. The term biomass may include fish, insects, vegetables, fruit, forage or other beneficial crops that can be utilised for food, feed, fibre and fuel production.

**Blackwater** is the mixture of urine, faeces and flushwater along with anal cleansing water (if water is used for cleansing) and/or dry cleansing materials (**figure 1**). Blackwater contains the pathogens, nutrients and organic matter of faeces and the nutrients of urine that are diluted in the flushwater.

**Compost** is decomposed organic matter that results from a controlled aerobic degradation process. In this biological process, microorganisms (mainly bacteria and fungi) decompose the biodegradable waste components and produce an earth-like, odourless, brown/black material. Compost has excellent soil-conditioning properties and a variable nutrient content. Because of leaching and volatilisation, some of the nutrients may be lost, but the material remains rich in nutrients and organic matter. Generally, excreta or sludge should be composted long enough (2 to 4 months) under thermophilic conditions (55 to 60 °C) in order to be sanitised sufficiently for safe agricultural use.

**Dried Faeces** are dehydrated until they become a dry, crumbly material. Dehydration takes place by storing faeces in a dry environment with good ventilation, high temperatures and/or the presence of an absorbent material. Very little degradation occurs during dehydration and this means that the dried faeces are still rich in organic matter. Faeces reduce by around 75% in volume during dehydration and most pathogens die off. There is a small risk that some pathogenic organisms (e.g. helminth ova) can be reactivated under the right conditions, particularly, in humid environments.

**Dry Cleansing Materials** are solid materials used to cleanse oneself after defecating and/or urinating (e.g. paper, leaves, corncobs, rags or stones). Depending on the system, dry cleansing materials may be collected and separately disposed of or dealt with alongside the other solid materials in the sanitation system.

**Effluent** is the general term for a liquid that leaves a technology, typically after blackwater or sludge has undergone solids separation or some other type of treatment. Effluent originates at either a collection and storage or a (semi-) centralised treatment technology. Depending on the type of treatment, the effluent may be completely sanitised or may require further treatment before it can be used or disposed of.

**Excreta** consists of urine and faeces that are not mixed with any flushwater. Excreta is relatively small in volume, but concentrated in both nutrients and pathogens. Depending on the characteristics of the faeces and the urine content, it can have a soft or runny consistency.

**Faeces** refers to (semi-solid) excrement that is not mixed with urine or water. Depending on diet, each person produces approximately 50–150 L per year of faecal matter of which about 80% is water and the remaining solid fraction is mostly composed of organic material. Of the total essential plant nutrients excreted by the human body,

faeces contain around 39 % of the phosphorus (P), 26 % of the potassium (K) and 12 % of the nitrogen (N). Faeces also contain the vast majority of the pathogens excreted by the body, as well as energy and carbon rich, fibrous material.

**Flushwater** is the water discharged into the user interface to clean it and transport the contents into the conveying system or to the on-site storage. Freshwater, rainwater, recycled greywater, or any combination of the three can be used as a flushwater source. Many sanitation systems do not require flushwater.

**Greywater** is the total volume of water generated from washing food, clothes and dishware, as well as from bathing, but not from toilets (**see blackwater**). It may also contain traces of excreta (e.g. from washing diapers) and, therefore, some pathogens. Greywater accounts for approximately 65 % of the wastewater produced in households with flush toilets.

**Menstrual Hygiene Products** include sanitary napkins, tampons or other materials used by women and girls to manage menstruation. As they are often disposed alongside dry cleaning materials in a sanitation system, some specific precautionary measures are advisable (e.g. separate bins). Generally, they should be treated along with the generated solid waste (**X.8**).

**Organics** refer to biodegradable plant material (organic waste) that must be added to some technologies in order for them to function properly. Organic degradable material can include, but is not limited to, leaves, grass and food market waste. Although other products in this compendium contain organic matter, the term organics is used to refer to undigested plant material.

**Pit Humus** is the term used to describe the nutrient-rich, hygienically improved, humic material that is generated in double pit technologies (**S.5, S.6**) through dewatering and degradation. The various natural decomposition processes taking place in alternating pits can be both aerobic and anaerobic in nature, depending on the technology and operating conditions. The main difference of pit humus compared to compost is that the degradation processes are passive and are not subjected to a controlled oxygen supply and that the carbon to nitrogen ratio, humidity and temperature may be less favourable. Therefore, the rate of pathogen reduction is generally lower and the quality of the product, including its nutrient and organic matter content, can vary considerably. Pit humus can look very similar to compost and have good soil conditioning properties, although pathogens can still be present.

**Pre-Treatment Products** are materials separated from blackwater, greywater or sludge in preliminary treatment units, such as screens, grease traps or grit chambers (**see PRE**). Substances like fat, oil, grease, and various solids (e.g. sand, fibres and trash), can impair transport and/or treatment efficiency through clogging and wear of pipes. Therefore, early removal of these substances can be crucial for the maintenance of a sanitation system.

**Sludge** is a mixture of solids and liquids, containing mostly excreta and water, in combination with sand, grit, metals, trash and/or various chemical compounds. A distinction can be made between faecal sludge and wastewater sludge. Faecal sludge comes from on-site sanitation technologies, i.e. it has not been transported through a sewer. It can be raw or partially digested, a slurry or semi-solid, and results from the collection and storage/treatment of excreta or blackwater, with or without greywater. Wastewater sludge (also referred to as sewage sludge) originates from sewer-based wastewater collection and (semi-)centralised treatment processes. The sludge composition will determine the type of treatment that is required and the end-use possibilities.

**Stored Urine** has been hydrolysed naturally over time, i.e. the urea has been converted by enzymes into ammonia and bicarbonate. Stored urine in closed containers usually has a pH of 9 or higher. Most pathogens cannot survive at this elevated pH. After 1–6 months of storage, the risk of pathogen transmission is therefore considerably reduced.

**Stormwater** is the general term for rainfall runoff collected from roofs, roads and other surfaces. Very often the term is used to refer to rainwater that enters a sewerage system. It is the portion of rainfall that does not infiltrate into the soil.

**Urine** is the liquid produced by the body to rid itself of nitrogen in the form of urea and other waste products. In this context, the urine product refers to pure urine that is not mixed with faeces or water. Depending on diet, human urine collected from one person during one year (approx. 300 to 550 L) contains 2 to 4 kg of nitrogen. The urine of healthy individuals is sterile when it leaves the body but is often immediately contaminated by coming into contact with faeces.

## Functional Groups

A functional group is a grouping of technologies that have similar functions. The compendium proposes five different functional groups from which technologies can be chosen to build a sanitation system:

- U** User Interface  
(Technologies **U.1–U.7**)
- S** Collection and Storage/Treatment  
(Technologies **S.1–S.20**)
- C** Conveyance  
(Technologies **C.1–C.6**)
- T** (Semi-) Centralised Treatment  
(Technologies **PRE, T.1–T.13, POST**)
- D** Use and/or Disposal (Technologies **D.1–D.13**)

Each functional group has a distinctive colour; technologies within a given functional group share the same colour code so that they are easily identifiable. Also, each technology within a functional group is assigned a reference code with a single letter and number.

**User Interface** **U** describes the type of toilet, pedestal, pan, or urinal that the user comes into contact with; it is the way users access the sanitation system. In many cases, the choice of user interface will depend on the availability of water and user preferences. Additionally, handwashing facilities have been included here with a dedicated technology information sheet as a constant reminder that each sanitation user interface needs to be equipped with handwashing facilities for optimal hygiene outcomes.

**Collection and Storage/Treatment** **S** describes technologies for on-site collection, storage, and sometimes (pre-) treatment of the products generated at the user interface. The treatment provided by these technologies is often a function of storage and is usually passive (i.e. requires no energy input), except a few emerging technologies where additives are needed. Thus, products that are 'treated' by these technologies often require subsequent treatment before use and/or disposal. In the technology overview graphic (**page 22**), this functional group is subdivided into the two subgroups: "Collection/Storage" and "(Pre-)Treatment". This allows a further classification for each of the listed technologies with regard to their function: collection and storage, (pre-) treatment only or both.

**Conveyance** **C** describes the transport of products from one functional group to another. Although products may need to be transferred in various ways between functional groups, the longest, and most important gap is usually between the user interface or collection and

storage/treatment and (semi-) centralised treatment. Therefore, for simplicity, conveyance only describes the technologies used to transport products between these two functional groups. In the technology overview graphic (**page 22**), the conveyance functional group is subdivided into the three subgroups: "Emptying", "Transport" and "Intermediate Storage". This allows for a more detailed classification of each of the listed conveyance technologies.

**(Semi-) Centralised Treatment** **T** refers to treatment technologies that are generally appropriate for larger user groups (i.e. neighbourhood to city scale sanitation systems). The operation, maintenance, and energy requirements of technologies within this functional group are generally higher than for small-scale on-site technologies. Technologies for pre-treatment and post-treatment are also described (technology information sheets **PRE** and **POST**).

**Use and/or Disposal** **D** refers to the methods through which products are returned to the environment, either as useful resources or reduced-risk materials. Some products can also be cycled back into a system (e.g. by using treated greywater for flushing).

## Sanitation System Template and Technology Selection

A sanitation system can be visualised as a matrix of functional groups (columns) and products (rows) that are linked together where potential combinations exist (**figure 3a**). Such a graphical presentation gives an overview of the technology components of a system and of all the products that it manages.

The emergency sanitation technologies and their corresponding functional groups can be allocated to three main categories: "On-site", "Transport" or "Off-site". Products are successively collected, stored, transported and transformed along different compatible technologies from the five functional groups. The output of a technology in one functional group, thereby, becomes the input for the next. It is not always necessary for a product to pass through a technology from each of the five functional groups; however, the ordering of the functional groups should usually be maintained regardless of how many of them are included within the sanitation system.

Figure 3a (left):  
Explanation of the  
different columns of a  
system template

Figure 3b (right):  
Example of how inputs  
enter into functional groups  
and are transformed

The colour-coded columns represent the different functional groups

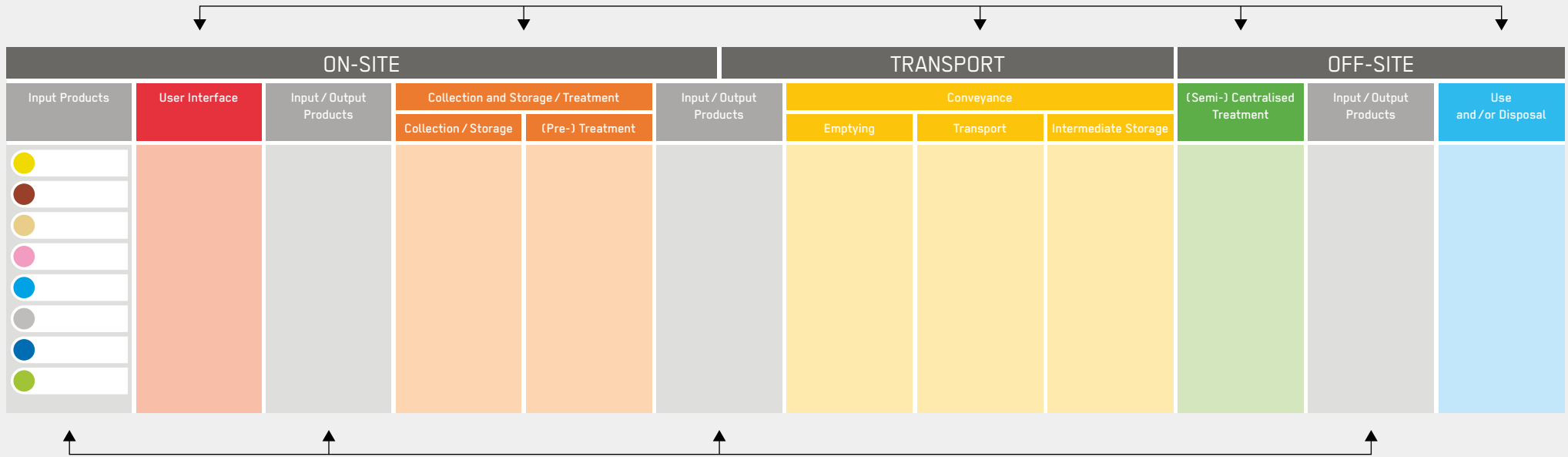

The grey columns show the input/output which enter/exit the functional groups

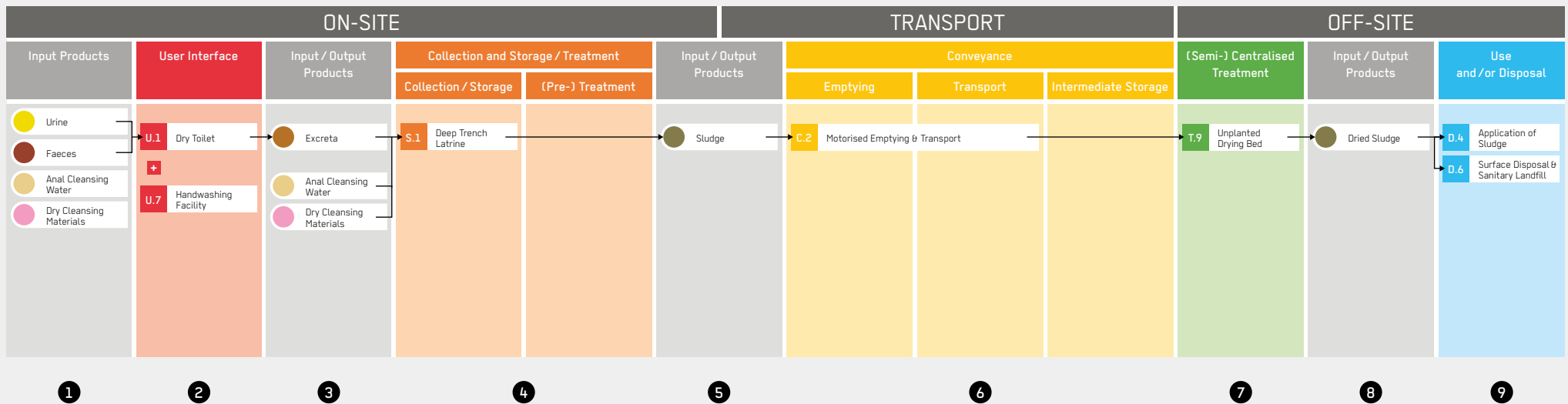

**Figure 3b** is a simplified example of a potential sanitation configuration. It shows how four products (faeces, urine, anal cleansing water and dry cleansing material) enter a system and are managed using different sanitation technologies. The following text describes how the products move from left to right through the sections ①–⑨ of the system template.

① Four inputs (faeces, urine, anal cleansing water and dry cleansing materials) enter ② the “user interface” (in this example a Dry Toilet U.1) with Handwashing Facilities (U.7) close to the toilet/user interface of choice. The generated excreta, plus anal cleansing water and dry cleansing material ③ enters ④ “collection and storage/treatment” (here a Deep Trench Latrine S.1) and is transformed into ⑤ sludge. The sludge enters ⑥ “conveyance” (here Motorised Emptying and Transport C.2) and then enters ⑦ “(semi-) centralised treatment” (here Unplanted Drying Bed T.9). The dried sludge ⑧ is directly transported for ⑨ “use and/or disposal”. In this example two possibilities exist. Depending on the local conditions, needs and preferences, the dried sludge can be applied as a soil conditioner in agriculture (here Application of Sludge D.4) or brought to a temporary storage or final disposal site (here Surface Disposal and Storage D.6).

The following steps can be followed to determine the best sanitation options for specific contexts:

Make an assessment of the initial situation (**see X.1–X.4**) including the identification of WASH practices and preferences of the user groups to be served, the geographical conditions, the existing WASH infrastructure and services in the area and the institutional and regulatory environment.

Identify the products that are generated and/or available (e.g. anal cleansing water, flushwater or organics for composting).

Based on the technology overview (**page 22–25**) and the more detailed descriptions from the Technology Information Sheets (**page 26–157**) identify technologies that are potentially appropriate for each of the functional groups and identify respective input/output products. Parts of a sanitation system may already exist and can be integrated.

For comparison, select several appropriate combinations of technologies for potential sanitation systems. Consider the input/output products at each step in each of the systems.

Compare the systems and iteratively change individual technologies based on, e.g. user priorities, time pressure, operation and maintenance requirements, the demand for specific end-products (e.g. compost), economic constraints, and technical feasibility.

A blank system template can be downloaded from [www.washcluster.net/emersan-compendium](http://www.washcluster.net/emersan-compendium). It can be printed and used to sketch site-specific sanitation systems, for example, when discussing different options with experts or stakeholders in a workshop. A PowerPoint template is also available for download that has pre-defined graphical elements (such as products, technologies and arrows), facilitating the preparation of customised sanitation system drawings.

## Disaster and Crisis Scenarios

The Global WASH Cluster describes disasters as events where important losses and damage are inflicted upon communities and individuals, possibly including loss of life and livelihood assets, leaving the affected communities unable to function normally without outside assistance. Disasters or humanitarian emergencies can take different forms. Each emergency situation, depending on the country context, its scope and causes is unique and has a great impact on people, the environment and infrastructure. Despite this heterogeneity, the following subdivision of various types of crises can be used to provide a rough categorisation:

### Disasters Triggered by Natural or Technological Hazards:

Earthquakes, volcanic eruptions, landslides, floods, storms, droughts and temperature extremes are natural hazards that can cause humanitarian disasters claiming many lives and causing economic losses and environmental and infrastructure damage. However, humanitarian disasters only occur if a hazard strikes where populations are vulnerable to the specific hazard. Due to climate change and its far-reaching impact, humanitarian assistance has to increasingly deal with extreme weather events and their consequences. The growing world population, continuing global urbanisation and changes in land use, further increase the vulnerability to natural and technological hazards such as dam breaks, chemical or nuclear contamination. Such disasters often result in a deterioration of environmental health conditions, particularly in terms of access to basic sanitation

services. Infrastructure such as schools, roads, hospitals, as well as sanitary facilities and washroom facilities are often directly affected, resulting in access to sanitation and the practice of relevant hygiene behaviour like handwashing no longer being assured. Thus, the risk of water and sanitation related diseases increases.

**Conflicts:** This includes societally-caused emergency situations such as political conflicts, armed confrontations and civil wars. Many displaced people (internally displaced people and/or refugees) have to be housed in camps, temporary shelters or host communities, where access to adequate sanitation and hygiene items needs to be guaranteed at very short notice and often must be maintained over longer periods. Most displaced persons are usually absorbed by host communities. This can overburden the existing sanitation infrastructure making it difficult to identify and quantify actual needs. Because of conflict dynamics, it is often difficult to plan how long shelters and corresponding sanitation infrastructure must remain in place. This can vary from a few weeks or months to several years or even decades. In addition, refugee camps are often constructed in places with an already tense sanitation situation. In refugee situations, where a displaced population is initially housed in temporary shelters or in a camp it is usually not politically desired that any move towards permanent settlement is made. Local decision makers might oppose activities that are seen to make the settlement more permanent or better developed for fear of not being able to move the refugee population back to where they initially came from. This is further complicated if the conditions in the camp prove to become better than those in local settlements. Tensions can arise between the local and refugee populations. Such cases should be seen as opportunities to improve sanitation services for both host and refugee communities.

**Fragile States and Protracted Crises:** A phenomenon that is increasingly common is the issue of fragile states and countries in protracted crises. States can be considered fragile if the state is unwilling or unable to meet its basic functions. For the affected population, their safety may be at risk as basic social services are not, or are only poorly, provided. Weak government structures or lack of government responsibility for ensuring basic services can lead to increased poverty, inequality, social distrust and can potentially develop into a humanitarian emergency. Protracted crisis situations are characterised by recurrent disasters and/or conflicts, prolonged food crises, deterioration of the health status of people, breakdown of livelihoods and insufficient institutional capacity to react to crises. In these environments, a significant proportion of the population is acutely vulnerable to mortality, morbidity and disruption of livelihoods over a prolonged

period of time. The provision of basic sanitation services is often neglected and external support using conventional government channels can lead to highly unsatisfactory experiences. Under these conditions, it may be necessary to explore complementary and alternative means of service provision, basing it mainly on non- and sub-state actors at a relatively decentralised level.

**(High-) Risk Countries Continuously Affected by Disasters and Climate Change:** Climate change and the increased likelihood of associated natural hazards is an enormous challenge for many countries. The risk that natural events become a disaster is largely determined by the vulnerability of the society, the susceptibility of its ecological or socio-economic systems and by the impact of climate change both on occasional extreme events (e.g. heavy rains causing floods or landslides) and on gradual climatic changes (e.g. temporal shift of the rainy seasons). Climate change also exacerbates problematic situations in high-risk countries that are already suffering from disasters. Existing sanitation infrastructure may need adaptations or the introduction of more appropriate and robust sanitation systems to increase resilience and help communities cope with climate-induced recurrent extreme weather events (e.g. raised sanitation solutions for flood-prone areas). In addition, sanitation systems may need to be prepared to serve climate change refugees.

## Emergency Phases

The prevailing categories used to distinguish between the different emergency phases are: (1) acute response, (2) stabilisation, and (3) recovery. The identification of these broad phases is helpful when planning assistance, however the division should be viewed as theoretical and simplified, modelled after singular disaster events. Real life is seldom so clearly defined.

**Acute Response Phase:** This refers to humanitarian relief interventions that are implemented immediately following natural disasters, conflicts, protracted crises or epidemics. It usually covers the first hours and days up to the first few weeks, where effective short-term measures are applied to alleviate the emergency situation quickly until more permanent solutions can be found. People affected by disasters are generally much more vulnerable to diseases, which to a large extent are related to inadequate sanitation and an inability to maintain good hygiene. The purpose of interventions in the acute response phase is to ensure the survival of the affected population, guided by the principles of humanity, neutrality, impartiality and independence. Essential sanitation-related services needed at this stage include establishing instant and safe excreta management options (particularly excreta containment measures) as they are critical determinants for survival in the initial stages of a disaster. Ensuring a safe environment and avoiding contamination of water sources is also critical. If applicable, this may also include the quick rehabilitation of existing WASH infrastructure, the establishment of appropriate drainage solutions and the provision of tools and equipment to ensure basic operation and maintenance services.

**Stabilisation Phase:** The stabilisation or transition phase usually starts after the first weeks of an emergency and can last several months to half a year or longer. The main sanitation focus, apart from increasing coverage of sanitation services, is the incremental upgrade and improvement of the temporary emergency structures that would have been installed during the acute phase, or the replacement of temporary sanitation technologies with more robust longer-term solutions. This phase includes the establishment of community-supported structures with a stronger focus on the entire sanitation service chain. This phase often sees a shift from communal sanitation to household-level solutions. Sanitation hardware solutions should be based on appropriate technologies and designs, ideally using locally available materials. A detailed assessment is required in order to be able to respond adequately within a given local context and to increase the long-term acceptance of the envisioned sanitation interventions. Particular emphasis should be

given to socio-cultural aspects such as potentially sensitive issues regarding sanitation (including use, operation and maintenance), menstrual hygiene management, vulnerability to sexual and other forms of violence as well as hygiene-related issues that imply certain levels of behaviour change. The equitable participation of women and men, children, marginalised and vulnerable groups in planning, decision-making and local management is key to ensuring that the entire affected population has safe and adequate access to sanitation services, and that services are appropriate.

**Recovery Phase:** The recovery phase, sometimes referred to as the rehabilitation phase, usually starts after or even during relief interventions and aims to recreate or improve on the pre-emergency situation of the affected population by gradually incorporating development principles. It can be seen as a continuation of already executed relief efforts and can prepare the ground for subsequent development interventions and gradual handing over to medium/long-term partners. Depending on local needs the general timeframe for recovery and rehabilitation interventions is usually between six months to three years and in difficult situations up to five years. Recovery and rehabilitation interventions are characterised by an active involvement and participation of local partners and authorities in the planning and decision making in order to build on local capacities and to contribute to the sustainability of the interventions. Sanitation recovery interventions can take diverse forms and depend on local conditions as well as actual needs of the affected population. Beyond the technical implementation of a sanitation system, these interventions include significant efforts to strengthen service structures and promote markets for sanitation services. In long-lasting camp situations that may develop into permanent settlements interventions might include upgrading the existing emergency sanitation infrastructure. Recovery interventions also include longer-term capacity development and training including working with relevant local authorities and development partners. Stronger collaboration with local governments, utilities, civil society, private sector and the handing over of responsibilities are also paramount. This necessitates the increased participation of involved stakeholders in sanitation planning and decision-making early on. Where possible, sanitation recovery interventions should take into consideration that the investments made may provide a foundation for further expansion of water and sanitation facilities and services. In addition, recovery interventions may include relevant resilience and disaster risk reduction measures. Recovery interventions should include a clear transition or exit strategy including hand-over to local governments, communities or service providers to ensure that the service levels created can be maintained.



## Key Decision Criteria

Selecting the most appropriate set of sanitation technologies for a specific context is a challenging task and requires considerable experience. The key decision criteria (see figure 4 below and detailed description on the following pages) aim to give the compendium user general guidance in the technology selection process and in the overall design of a sanitation system. The decision criteria are featured in each of the subsequent technology information sheets.

Figure 4:  
Generic structure of the  
technology information sheet

### Name of the Technology

|  |  |   |  |
|--|--|---|--|
| <b>Phase of Emergency</b> ①<br>* Acute Response<br>** Stabilisation<br>** Recovery | <b>Application Level / Scale</b> ②<br>** Household<br>** Neighbourhood<br>City | <b>Management Level</b> ③<br>** Household<br>** Shared<br>** Public | <b>Objectives / Key Features</b> ④<br>Excreta containment, Solid / liquid separation |
| <b>Space Required</b> ⑤<br>** Medium   | <b>Technical Complexity</b> ⑥<br>* Low   | <b>Inputs</b> ⑦<br>● Blackwater, ● Greywater                        | <b>Outputs</b> ⑦<br>● Effluent, ● Sludge   |

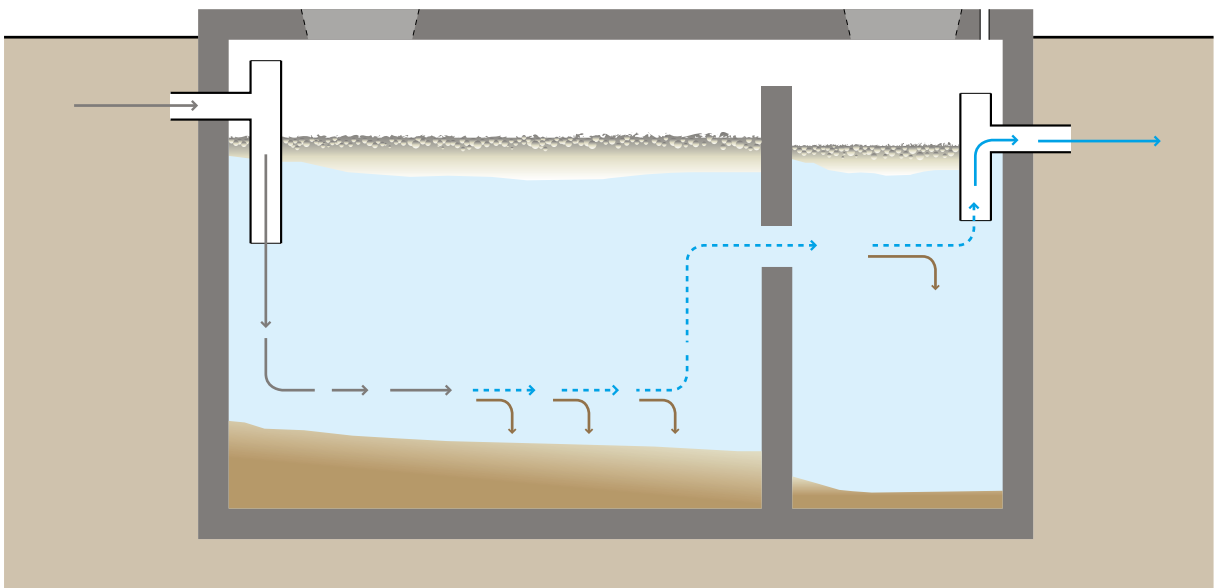

|                             |                                   |
|-----------------------------|-----------------------------------|
| Technology Description      | ⑫ Health and Safety               |
| ⑧ Design Considerations     | ⑬ Costs                           |
| ⑨ Materials                 | ⑭ Social Considerations           |
| ⑩ Applicability             | ⑮ Strengths and Weaknesses        |
| ⑪ Operation and Maintenance | ⑯ References and Further Readings |

## 1 Phase of Emergency

Technologies are either or less appropriate depending on the phase of the emergency. As such, their suitability is characterised for the three emergency phases described on [page 16](#):

- **Acute Response**
- **Stabilisation**
- **Recovery**

An indication of whether or not a technology is suitable in the different emergency phases is given using asterisks (**two asterisks**: suitable, **one asterisk**: less suitable, **no asterisk**: unsuitable). The level of appropriateness is decided on a comparative level between the different technologies, mainly based on applicability, speed of implementation and material requirements. It is up to the compendium user to decide on the emergency phase for the specific situation in which he/she is working.

## 2 Application Level

The application level describes the different spatial levels for which the technology is most appropriate. It is subdivided into the following levels:

- **Household** (one unit serving one up to several individual households)
- **Neighbourhood** (one unit serving a few to several hundred households)
- **City** (one unit serving an entire settlement, camp or district)

An indication of whether a technology is suitable at a specific spatial level is given using asterisks (**two asterisks**: suitable, **one asterisk**: less suitable, **no asterisk**: unsuitable). It is up to the compendium user to decide on the appropriate level for the specific situation in which he/she is working.

## 3 Management Level

The management level describes where the main responsibility for operation and maintenance (O&M) for a specific technology lies:

- **Household** (all O&M related tasks can be managed by the individual household)
- **Shared** (group of users are responsible for O&M by ensuring that a person or a committee is in charge on behalf of all users. Shared facilities refer to a self-defined group of users who decide who is allowed to use the facility and what their responsibilities are)

- **Public** (government, institutional or privately run facilities: all O&M is assumed by the entity operating the facility)

An indication regarding the appropriateness of each management level is given using **zero to two asterisks**, with two asterisks meaning that the technology can be well handled at the respective level.

## 4 Objectives/Key Features

This section gives a concise indication of the main features and functions of specific technologies. It also provides general guidance for the immediate evaluation and classification of technologies and their suitability for an envisioned sanitation system or context.

## 5 Space Required

This section gives a qualitative estimate of the space required for each technology, meaning the area or spatial footprint required by the technology. This can help planning in areas where space is a limiting factor. Asterisks are used to indicate how much space is needed for the given technology (**three asterisks**: much space required, **two asterisks**: medium space required, and **one asterisk**: little space required). The categorisation is based on a comparative approach between the different technologies and not in absolute terms, e.g. a Single Pit Latrine needs little space compared to a Constructed Wetland. The space required is indicated for one typical unit and not per user. The amount of space required for each technology can heavily depend on the number of users connected to this technology and on other design criteria. For this assessment, it does not matter if a technology can be constructed underground and therefore the space above can potentially be used, e.g. an Anaerobic Baffled Reactor requires medium space, but as it can be constructed underground, part of its surface can be used for other purposes.

## 6 Technical Complexity

This section gives an overview of the technical complexity of each technology, meaning the level of technical expertise needed to implement, operate and maintain the given technology. This can help planning where skills and capacities are limited or temporarily unavailable. Asterisks are used to indicate the technical complexity for the given technology (**three asterisks**: high complexity, **two asterisks**: medium complexity, and **one asterisk**: low complexity). Low technical complexity means that no or minimal technical skills are required to implement, operate and maintain a technology. This can be done by

non-professionals and artisans. Medium technical complexity means that certain skills are required for either implementation or O & M. Skilled artisans or engineers are required for the design and O & M of such a technology. High technical complexity means that an experienced expert, such as a trained engineer, is required to implement, operate and maintain a technology in a sustainable manner. The categorisation is based on a comparative approach between the different technologies and not in absolute terms, e.g. Manual Emptying and Transport is less technically complex than a Conventional Gravity Sewer.

## 7 Inputs/Outputs

Different technologies are required for the management of different inputs and the generation of specific outputs. Therefore, when selecting technologies one must consider the input products that have to be dealt with and the desired output products. Through reverse engineering technologies can be selected from the end of the sanitation chain based on a desired output product. For example if the goal of the sanitation chain is to produce compost as an end product, a technology can be selected with compost as an output product. Upstream technology components would support this goal. Keeping in mind the safety and quality of the desired output products at each step of the system helps to internalise the system approach, and supports the selection of a combination of technologies that creates end-products that can be safely used or disposed of into the environment.

**Inputs** refer to the products that flow into the given technology. The products shown without parentheses are the regular inputs that typically go into a technology. Products shown with parentheses represent alternatives or options of which not all are necessary, depending on the design or context. Where a product should be used in conjunction with another product, this is indicated by the plus (+). The product following the plus is mixed with the preceding product(s).

**Outputs** refer to the products that flow out of the given technology. The products shown without parentheses are the regular outputs that typically come out of a technology. Products in parentheses (I) are additional (optional) products that may or may not occur as output products, depending on the design or context. When these products occur mixed with another product, this is indicated by the plus (+). The product following the plus is mixed with the preceding product(s).

## 8 Design Considerations

In this section, general and key design considerations are described, including general sizing, space requirements and other features. This section does not describe the

detailed design parameters to allow the complete construction of a technology, but gives an idea on dimension features to consider, the retention times, as well as the main potential pitfalls to be aware of when designing the technology. This section helps the compendium user understand the technical design and complexity of a given technology.

## 9 Materials

This section lists the different materials and equipment required for the construction, operation and maintenance of a given technology. It indicates whether materials are likely to be locally available or producible, e.g. wood and bricks or whether materials will need to be imported or require special manufacturing, which will considerably delay implementation during an emergency. The materials section also indicates whether a technology can be pre-fabricated as a unit to speed up implementation.

## 10 Applicability

Applicability describes the contexts in which a technology is most appropriate. This section indicates a technology's applicability in terms of type of setting, distinguishing between rural or urban, short-term or a longer-term settlement. The section describes the phases of an emergency in which a technology can be implemented. Other physical considerations of applicability are listed here, including soil conditions required, water availability needed, ground water table considerations, etc. This section also gives information on the potential for replicability, scalability and the speed of implementation.

## 11 Operation and Maintenance

Every technology requires operation and maintenance (O & M), more so if it is used over a prolonged period of time. The O & M implications of each technology must be considered during initial planning. Many technologies fail due to the lack of appropriate O & M. In this section, the main operation tasks that need to be considered and the maintenance that is required to guarantee longer-term operation are listed. This section differentiates between different O & M skills and provides an indication of frequency of O & M tasks and the time required to operate and maintain a technology. A list of potential misuses and pitfalls to be aware of is also provided.

## 12 Health and Safety

All sanitation technologies have health and safety implications. The health implications or risks described in this section should be considered during planning to reduce

health risks in the local community and among sanitation personnel and staff. The health and safety section also describes overall risk management procedures, which can lead to decisions to exclude a technology if safety cannot be guaranteed. Where relevant, the personal protective equipment needed to guarantee personal safety is listed.

### **13 Costs**

Costs are another key decision criteria to consider. Each technology has costs associated with construction, operation, maintenance and management. In addition, each technology has cost implications for other technologies in the sanitation chain. For example, a Septic Tank will require regular desludging and therefore equipment and time is needed for the task of desludging, which is usually not accounted for in the Septic Tank. Costs are geographically dependent and are not absolute. Hence, this section presents the main cost elements associated with a technology, allowing for a first approximation.

### **14 Social Considerations**

Social considerations are a crucial element when deciding on specific sanitation technologies, especially at the user interface level, or an entire sanitation system. There are potential cultural taboos, user preferences and habits as well as local capacities that may be challenging, impossible or inappropriate to change. A sanitation technology needs to be accepted by the users as well as the personnel operating and maintaining it.

### **15 Strengths and Weaknesses**

This section concisely summarises main strengths and weaknesses and thereby supports the decision-making process. The weaknesses of a technology might indicate that an exclusion criterion is fulfilled and a technology is not suitable for a specific context. Both strengths and weaknesses can be effectively used to inform decisions of users and all involved in the planning and implementation of the sanitation system.

### **16 References and Further Readings**

This section refers users to specific pages of a detailed bibliography included in the annex to the publication. The bibliography is a compilation of the most relevant publications sorted by chapter and a short description for each listed publication. Users can use the publication list to find additional relevant information (e.g. design guidelines, research papers, case studies) on specific technologies.

## **Technology Overviews for Different Contexts**

In order to allow for a first approximation and a quick assessment of which technologies are suitable for a specific context, the following pages present overviews of technology for different contexts. These overviews cover three areas, deemed critical in the sanitation planning and decision making process and are designed to facilitate the identification of the most suitable technology options. The categorisation of technologies in each of the overviews should not be seen as fixed and incontrovertible. The categorisation is meant to support rapid informed decision making. As each emergency context is unique with a specific set of framing conditions, the categories presented here may not be fully applicable in each local context.

### **Sanitation Technologies in Different Emergency Phases**

This overview (**page 23**) indicates which technologies are suitable for the acute response phase (first days and weeks) and which technologies are more suited for longer-term stabilisation and recovery interventions. There may be additional technologies applicable in acute scenarios depending on already existing infrastructure that can be rehabilitated fast. **(E) = Emerging Technology**

### **Sanitation Technologies for Challenging Ground Conditions**

This overview (**page 24**) indicates which technologies are suitable for areas with challenging ground conditions (e.g. rocky soils, areas with high groundwater table, soils with low infiltration capacity, flood prone areas) where underground digging may be difficult. It should be noted that these are just indications and not absolute requirements (e.g. underground treatment facilities in rocky undergrounds may still be realised with heavy blasting). **(E) = Emerging Technology**

### **Water-Based and Dry Sanitation Technologies**

This overview (**page 25**) indicates which technologies are suitable for sanitation systems with flush-water as an input product and which are suitable for dry sanitation systems. There are some technologies that can be used both for "wet" and dry sanitation systems (e.g. sludge treatment technologies like Unplanted Drying Beds are indicated to be suitable for both systems, as also wet systems will produce faecal sludge). **(E) = Emerging Technology**

# PART 1:

## Technology Overview

## General Technology Overview (including Cross-Cutting Issues)

| ON-SITE                    |                                |                         |  | TRANSPORT                        |                                    |            | OFF-SITE                       |  |                               |  |                     |
|----------------------------|--------------------------------|-------------------------|--|----------------------------------|------------------------------------|------------|--------------------------------|--|-------------------------------|--|---------------------|
| Input Products             | User Interface                 | Input / Output Products | Collection and Storage / Treatment       |                                  | Input / Output Products            | Conveyance |                                |  | (Semi-) Centralised Treatment | Input / Output Products                  | Use and/or Disposal |
|                            |                                |                         | Collection / Storage                     | (Pre-) Treatment                 |                                    | Emptying   | Transport                      | Intermediate Storage                     |                               |  |                     |
| Urine                      | U.1 Dry Toilet                 |                         | S.1 Deep Trench Latrine                  | S.17 Hydrated Lime Treatment (E) | C.1 Manual Emptying & Transport    |            | C.6 Transfer Station & Storage | PRE PRE-Treatment Technologies           |                               | D.1 Application of Stored Urine          |                     |
| Faeces                     | U.2 Urine Diverting Dry Toilet |                         | S.2 Borehole Latrine                     | S.18 Urea Treatment (E)          | C.2 Motorised Emptying & Transport |            |                                | T.1 Settler                              |                               | D.2 Application of Dried Faeces          |                     |
| Anal Cleansing Water       | U.3 Urinal                     |                         | S.3 Single Pit Latrine                   | S.19 LAF Treatment (E)           | C.3 Simplified Sewer               |            |                                | T.2 Anaerobic Baffled Reactor            |                               | D.3 Application of Pit Humus & Compost   |                     |
| Dry Cleansing Materials    | U.4 Flush Toilet               |                         | S.4 Single Ventilated Improved Pit (VIP) | S.20 Caustic Soda Treatment (E)  | C.4 Conventional Gravity Sewer     |            |                                | T.3 Anaerobic Filter                     |                               | D.4 Application of Sludge                |                     |
| Flushwater                 | U.5 Controlled Open Defecation |                         |  |                                  | C.5 Stormwater Drainage            |            |                                | T.4 Biogas Reactor                       |                               | D.5 Fill & Cover                         |                     |
| Greywater                  | U.6 Shallow Trench Latrine     |                         |  |                                  |                                    |            |                                | T.5 Waste Stabilisation Ponds            |                               | D.6 Surface Disposal & Sanitary Landfill |                     |
| Stormwater                 | U.7 Handwashing Facility       |                         | S.5 Twin Pit Dry System                  |                                  |                                    |            |                                | T.6 Constructed Wetland                  |                               | D.7 Use of Biogas                        |                     |
| Organics                   |                                |                         | S.6 Twin Pit with Pour Flush             |                                  |                                    |            |                                | T.7 Trickling Filter                     |                               | D.8 Co-Combustion of Sludge (E)          |                     |
| Menstrual Hygiene Products |                                |                         | S.7 Raised Latrine                       |                                  |                                    |            |                                | T.8 Sedimentation & Thickening Ponds     |                               | D.9 Leach Field                          |                     |
|                            |                                |                         | S.8 Single Vault UDDT                    |                                  |                                    |            |                                | T.9 Unplanted Drying Bed                 |                               | D.10 Soak Pit                            |                     |
|                            |                                |                         | S.9 Double Vault UDDT                    |                                  |                                    |            |                                | T.10 Planted Drying Bed                  |                               | D.11 Irrigation                          |                     |
|                            |                                |                         | S.10 Container-Based Toilet              |                                  |                                    |            |                                | T.11 Co-Composting                       |                               | D.12 Water Disposal & GW Recharge        |                     |
|                            |                                |                         | S.11 Chemical Toilet                     |                                  |                                    |            |                                | T.12 Vermicomposting (E)                 |                               | D.13 Fish Ponds                          |                     |
|                            |                                |                         | S.12 Worm-Based Toilet (E)               |                                  |                                    |            |                                | T.13 Activated Sludge                    |                               |  |                     |
|                            |                                |                         | S.13 Septic Tank                         |                                  |                                    |            |                                | PO ST Tertiary Filtration & Disinfection |                               |  |                     |
|                            |                                |                         | S.14 Anaerobic Baffled Reactor           |                                  |                                    |            |                                |  |                               |  |                     |
|                            |                                |                         | S.15 Anaerobic Filter                    |                                  |                                    |            |                                |  |                               |  |                     |
|                            |                                |                         | S.16 Biogas Reactor                      |                                  |                                    |            |                                |  |                               |  |                     |

### CROSS - CUTTING ISSUES

| Initial Situation |   | Conceptual Aspects |  | Design & Social Consideration |   |
|-------------------|---|--------------------|--|-------------------------------|---|
| X.1               | Assessment of the Initial Situation       | X.5                | Resilience and Preparedness                                    | X.10                          | Inclusive and Equitable Design                          |
| X.2               | Rehabilitation of Existing Infrastructure | X.6                | Exit Strategy, Hand-Over and Decommissioning of Infrastructure | X.11                          | Child Excreta Management                                |
| X.3               | Soil and Groundwater Assessment           | X.7                | Urban Settings and Protracted Crisis Scenarios                 | X.12                          | Hygiene Promotion and Working with Affected Communities |
| X.4               | Institutional and Regulatory Environment  | X.8                | Solid Waste Management   | X.13                          | Market-Based Programming                                |
|                   |   | X.9                | Cholera Prevention and Epidemic Management                     |                               |   |









# User Interface

This section describes the technologies with which the user interacts, i.e. the type of toilet, pedestal, pan, or urinal. The user interface must guarantee that human excreta is hygienically separated from human contact to prevent exposure to faecal contamination. User interfaces can either be dry technologies that operate without water (U.1, U.2, U.5, U.6), water-based technologies that need a regular supply of water to function properly (U.4, U.7) or technologies that can operate either with or without water (U.3). Different user interface technologies generate different output products. This influences the subsequent type of collection and storage/treatment or conveyance technology. Handwashing Facilities (U.7) need to be provided next to all user interfaces or toilets.

|     |                            |
|-----|----------------------------|
| U.1 | Dry Toilet                 |
| U.2 | Urine Diversion Dry Toilet |
| U.3 | Urinal                     |
| U.4 | Flush Toilet               |
| U.5 | Controlled Open Defecation |
| U.6 | Shallow Trench Latrines    |
| U.7 | Handwashing Facilities     |

The choice of user interface technology is contextual and generally depends on the following factors:

- Availability of water for flushing
- Habits and preferences of the users (sitting or squatting, washing or wiping)
- Needs of different user groups
- Local availability of materials
- Compatibility with the subsequent collection and storage/treatment or conveyance technology

U

# Dry Toilet

| Phase of Emergency                                   | Application Level / Scale                   | Management Level   | Objectives / Key Features  |
|--|---|--|--|
| ** Acute Response<br>** Stabilisation<br>** Recovery | ** Household<br>** Neighbourhood<br>** City | ** Household<br>* Shared<br>* Public   | Barrier between user and excreta,<br>No flushwater needed                  |
| Space Required                                       | Technical Complexity                        | Inputs   | Outputs  |
| * Little   | * Low                                       | ● Faeces, ● Urine,<br>(● Anal Cleansing Water),<br>(● Dry Cleansing Materials) | ● Excreta,<br>(+ ● Anal Cleansing Water),<br>(+ ● Dry Cleansing Materials) |

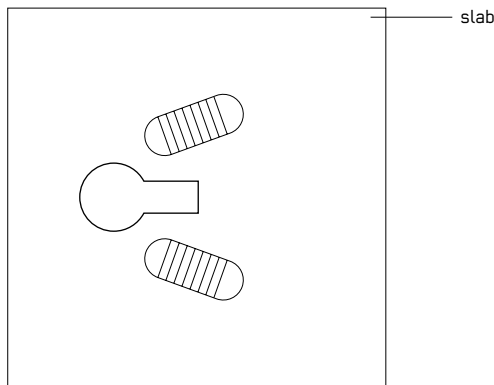

option 1

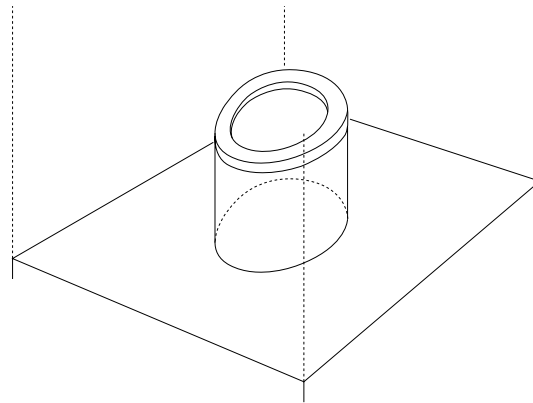

option 2

A Dry Toilet is a toilet that operates without flushwater. The dry toilet may be a raised pedestal on which the user can sit, or a squat pan over which the user squats. In both cases, excreta (both urine and faeces) fall through a drop hole.

In this compendium, a Dry Toilet refers specifically to the device over which the user sits or squats. In other literature, a Dry Toilet may refer to a variety of technologies, or combinations of technologies (especially pits or container-based systems).

**Design Considerations:** The Dry Toilet is usually placed over a pit; if two alternating pits are used (S.5), the pedestal or slab should be designed in such a way that it can be lifted and moved from one pit to the other. The slab or pedestal base should be fitted to the pit so that it is both safe for the user and prevents stormwater from infiltrating the pit (which may cause it to overflow). The hole can be closed with a lid to prevent unwanted intrusion from insects or rodents. This also reduces odours from the pit.

**Materials:** Pedestals and squatting slabs can be made locally with concrete (provided that sand and cement are available). Fibreglass, porcelain, plastic and stainless-steel versions may also be available. Wooden or metal moulds can be used to produce several units quickly and efficiently. Easy-to-clean surfaces are preferable, especially in public toilets.

**Applicability:** A Dry Toilet is easy for almost everyone to use though special consideration may need to be made for elderly or disabled users who may have difficulties using the squatting version (X.10). It is especially suitable where water is scarce or not available, or where nutrient-recovery is foreseen. When Dry Toilets are made locally, they can be specially designed to meet the needs of the target users (e.g. smaller sizes for children). Where there is no need to separate urine and faeces, Dry Toilets are often the simplest and physically most comfortable option.

**Operation and Maintenance:** The sitting or standing surface should be kept clean and dry to prevent pathogen/disease transmission and to limit odours. Cleaning should be done with water and a small amount of detergent. The use of large quantities of chemicals should be avoided as it may affect the functioning of the pit below. There are no mechanical parts; therefore, the dry toilet should not need repairs except in the event that it cracks.

**Health and Safety:** Squatting is a natural position for many people and so a well-kept squatting slab may be the most acceptable option. Since dry toilets do not have a water seal, odours may be a problem depending on the collection and storage/treatment technology connected to them. Anal cleansing material should be provided, and a Handwashing Facility (U.7) has to be in close proximity.

**Costs:** Capital and operating costs are low. However, depending on the storage system and the local conditions, sludge emptying and transport may be an important cost factor.

**Social Considerations:** Although Dry Toilets are a widely accepted solution, it may not be appropriate in each cultural context and needs prior consultation with the users. Behaviour change rarely succeeds. Dry Toilets should

reflect local user preferences (sitter vs. squatter, anal cleansing practices, direction etc.) and should account for the accessibility and safety of all users, including men, women, children, elderly and disabled people (X.10). In Muslim communities, Dry Toilets should be oriented in such a way that users neither face Qiblah (prayer point) nor face directly away from it when using the toilet. There is a frequent problem with users disposing of garbage in the toilet (such as plastic bottles) which should be addressed early on as part of the hygiene promotion activities (X.12) and solid waste management (X.8) as it negatively affects the later desludging of pits.

**Strengths and Weaknesses:**

- ⊕ Does not require a constant source of water
- ⊕ Can be built and repaired with locally available materials
- ⊕ Low capital and operating costs
- ⊕ Adaptable for all types of users (sitters, squatters, washers, wipers)
- ⊕ Will accept a wide range of anal cleaning materials (such as stones, sticks, leaves etc.)
- ⊖ Odours are normally noticeable (even if the vault or pit used to collect excreta is equipped with a vent pipe)
- ⊖ The excreta pile is visible, except where a deep pit is used
- ⊖ Vectors such as flies are hard to control unless fly traps and appropriate covers are used

→ **References and further reading material for this technology can be found on page 190**

# Urine-Diverting Dry Toilet

| Phase of Emergency  | Application Level / Scale   | Management Level   | Objectives / Key Features  |
|---|---|--|--|
| <ul style="list-style-type: none"> <li>* Acute Response</li> <li>** Stabilisation</li> <li>** Recovery</li> </ul> | <ul style="list-style-type: none"> <li>** Household</li> <li>** Neighbourhood</li> <li>** City</li> </ul> | <ul style="list-style-type: none"> <li>** Household</li> <li>* Shared</li> <li>* Public</li> </ul>   | Barrier between user and excreta, Urine / faeces separation, No flush water needed   |
| Space Required  | Technical Complexity  | Inputs   | Outputs  |
| <ul style="list-style-type: none"> <li>* Little</li> </ul>  | <ul style="list-style-type: none"> <li>* Low</li> </ul>   | <ul style="list-style-type: none"> <li>● Faeces, ● Urine,</li> <li>(● Anal Cleansing Water),</li> <li>(● Dry Cleansing Materials)</li> </ul> | <ul style="list-style-type: none"> <li>● Faeces (+ ● Dry Cleansing Materials), ● Urine,</li> <li>(● Anal Cleansing Water)</li> </ul> |

for wipers

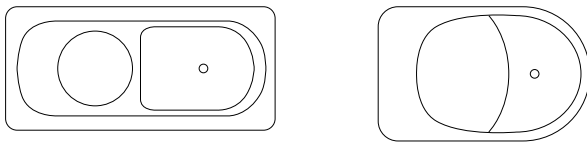

for washers

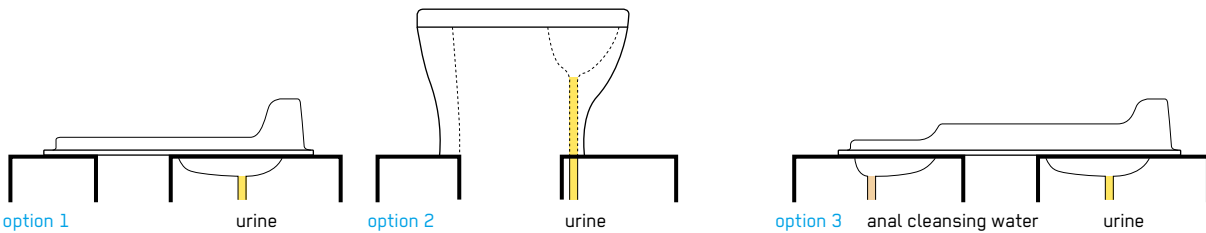
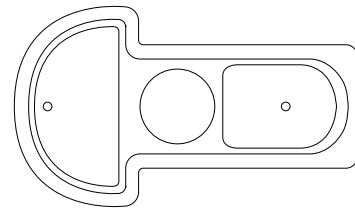

A Urine-Diverting Dry Toilet (UDDT) is a toilet that operates without water and has a divider so that urine does not mix with the faeces. The separation facilitates subsequent treatment processes (such as dehydration of the faeces) and nutrient recovery as well as considerable odour reduction.

The UDDT is built such that urine is collected and drained from the front area of the toilet, while faeces fall through a large chute (hole) in the back. Depending on the collection and storage/treatment technology that follows, drying material such as lime, ash or sawdust may be added into the same hole after defecating (S.8, S.9).

**Design Considerations:** It is important that the two sections of the UDDT are well separated to ensure that a) faeces do not fall into and clog the urine collection area in the front, and that b) urine does not splash into the dry area of the toilet. There are also 3-hole separating toilets

that allow anal cleansing water to go into a third, dedicated basin separate from the urine drain and faeces collection. Both sitting and squatting UDDT designs can be used to separate urine from faeces depending on user preference. To limit scaling, all connections (pipes) to storage tanks should be kept as short as possible; whenever they exist, pipes should be installed with at least a 1% slope, and sharp angles (90°) should be avoided. A pipe diameter of 50 mm is sufficient for steep slopes and where maintenance is easy. Larger diameter pipes (> 75 mm) should be used elsewhere, especially for minimum slopes, and where access is difficult. The pipe should be insulated in cold climates to avoid urine freezing. To prevent odours from coming back up the pipe, an odour seal should be installed at the urine drain.

**Materials:** Urine-diverting pedestals and squatting slabs can be made out of fibreglass, porcelain, concrete or plastic. They are usually not available in local markets.

Wooden or metal moulds can be used to produce several units quickly and efficiently. Urine tends to rust most metals; therefore, metals should be avoided in the construction and piping of the UDDT.

**Applicability:** Applicability of a UDDT depends heavily on local user acceptance and may not be appropriate in every cultural context. The UDDT design can be altered to suit the needs of specific populations (i.e. smaller for children, people who prefer to squat, etc.). It is particularly suitable in areas with challenging ground conditions, or where there is an interest in using urine and dry faeces in agriculture. If there is no interest in using urine as fertiliser, it can be infiltrated, but in all cases faeces need further treatment until they can be safely used or disposed of. UDDT may not be suitable in very cold climates as urine can freeze in the pipe if not properly insulated.

**Operation and Maintenance:** A UDDT is slightly more difficult to keep clean compared to other toilets. Some users may have difficulty separating both streams perfectly, which may result in extra cleaning and maintenance, especially of the separation wall. Faeces can be accidentally deposited in the urine section, causing blockages, cleaning problems and cross-contamination of the urine. All surfaces should be cleaned regularly to prevent odours and minimise formation of stains. Water should not be poured in the toilet for cleaning. Instead, a damp cloth or single use disposable paper wipes may be used to wipe down the seat and inner bowls. When the toilet is cleaned with water, care should be taken to ensure that it does not flow into the faeces compartment. Because urine is collected separately, calcium- and magnesium-based minerals and salts can precipitate and build up in pipes and on surfaces where urine is constantly present. Washing the bowl with a mild acid (e.g. vinegar) and/or hot water can prevent build-up of mineral deposits and scaling. Stronger acid or a caustic soda solution (2 parts water to 1 part soda) can be used for removing blockages. In some cases manual removal may be required. An odour seal also requires occasional maintenance. It is critical to regularly check its functioning.

**Health and Safety:** Anal cleansing material should be provided, and a Handwashing Facility (U.7) has to be in close proximity. Appropriate toilet cleaning equipment, including gloves, should be available.

**Costs:** Capital and operating costs are relatively low, but the slab can be a significant investment for individual households, and is more expensive than a standard single-hole slab. The costs for faeces and urine management, if not done onsite, must also be considered.

**Social Considerations:** The UDDT is not intuitive or immediately obvious to some users. At first, users may be hesitant to use it, and mistakes made (e.g. faeces in the urine bowl) may deter others from accepting this type of toilet. User guidelines inside the toilet and hygiene promotion are essential to achieve good acceptance. For better acceptance and to avoid urine in the faeces collection bowl, the toilet can be combined with a Urinal (U.3), allowing men to stand and urinate. The subsequent management of urine and faeces must be considered (see S.8, S.9). In order to avoid the double hole user interface, some systems currently propose the separation of urine and faeces below the toilet hole with a sloping conveyor belt, which transports the faeces into a separate container, while urine falls through. The UDDT should reflect local user preferences (sitter vs. squatter, anal cleansing practices, direction etc.) and should account for the accessibility and safety of all users, including men, women, children, elderly and disabled people (X.10).

**Strengths and Weaknesses:**

- ⊕ Does not require a constant source of water
- ⊕ No real problems with flies or odours if used and maintained correctly
- ⊕ Low capital and operating costs
- ⊕ Suitable for all types of users (sitters, squatters, washers, wipers)
- ⊖ Prefabricated models not available everywhere
- ⊖ Requires training and acceptance to be used correctly
- ⊖ Is prone to misuse and clogging with faeces
- ⊖ Men usually require a separate Urinal for optimum collection of urine

→ **References and further reading material for this technology can be found on page 190**

# Urinal

| Phase of Emergency                                   | Application Level/ Scale              | Management Level                     | Objectives / Key Features  |
|--|---------------------------------------|--------------------------------------|--|
| ** Acute Response<br>** Stabilisation<br>** Recovery | ** Household<br>Neighbourhood<br>City | ** Household<br>* Shared<br>* Public | Separate urine collection, Take off user pressure from other user interfaces |
| Space Required                                       | Technical Complexity                  | Inputs                               | Outputs  |
| * Little   | * Low                                 | ● Urine, (● Flushwater)              | ● Urine, (● Flushwater)  |

urinal with flush

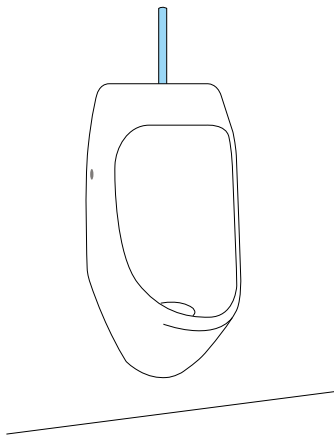

waterless urinal

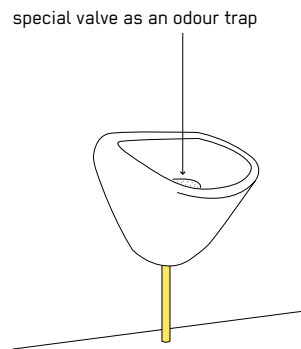

jerrycan urinal

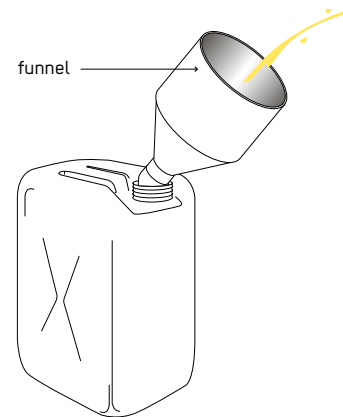

A Urinal is used only for collecting urine. Urinals are usually for men, although models for women have also been developed. Some Urinals use water for flushing, but waterless Urinals are also available.

Urinals for men can be either vertical wall-mounted units, or squat slabs over which the user squats. Urinals for women consist of raised foot-steps and a sloped channel or catchment area that conducts the urine to a collection technology. The Urinal can be used with or without water and the plumbing can be developed accordingly. If water is used, it is mainly used for cleaning and limiting odours (with a water-seal). Urinals need to be equipped with a urine storage container or a disposal system such as a Soak Pit (D.10).

**Design Considerations:** During an acute emergency, a Urinal can be a simple trench or pit filled with gravel or a piece of rainwater guttering against a vertical plastic sheet discharging into a Soak Pit (D.10). Other options include (recycled) containers or jerrycans with a funnel on top or other locally available Urinal options made out of plastic or ceramic. For water-based Urinals, the water use per flush ranges from less than 1 L in current designs to 5–10 L of flush water in older models. Water-saving or waterless technologies should be favoured. Some Urinals come equipped with an odour seal that may have a mechanical closure, a membrane, or a sealing liquid. For male Urinals, adding a small target near the drain can reduce urine splash. Because the Urinal is exclusively for urine it is important to also provide a regular toilet for faeces. To minimise odours and nitrogen loss in simple waterless Urinal designs, the collection pipe should be submerged in the urine tank to provide a basic liquid seal. For planning, a maximum urinal per user ratio of 1:50 is recommended.



**Materials:** Urinals can be constructed using a wide variety of local materials, ranging from very simple (e.g. plastic funnels connected to a jerrycan), to more elaborate and prefabricated designs. In principle, any sealed material can be made into a Urinal and be connected to a storage container or a soakaway or sewer system.

**Applicability:** Urinals are suitable for shared and public facilities. Particularly in the acute response phase Urinals offer a good possibility to reduce the volume entering pit latrines (urine can be considered pathogen free and makes up around 90 % of the excreta load). In some cases, the provision of a Urinal is useful to prevent the misuse of dry systems, as no urine enters the system. Urinals are particularly appropriate for communities that already use Urinals. Urinals can boost efficiency of existing toilets, increase use of sanitation facilities, reduce the amount of wastewater generated and remaining toilets can be reduced in number or used more efficiently. Urinals usually smell in warm climates which should be considered when deciding on an appropriate location.

**Operation and Maintenance:** With Urinals there are often odour issues, especially if the Urinal floor is not sealed. Frequent flushing with water and regular cleaning of the surrounding area (bowl, slab and wall) is necessary. Urinals require maintenance to minimise odour, remove solid waste (e.g. cigarette butts) and to minimise the formation of stains and mineral deposits. Particularly, in waterless Urinals, calcium- and magnesium-based minerals and salts can precipitate and build up in pipes and on surfaces where urine is constantly present. Washing the bowl with a mild acid (e.g. vinegar) and/or hot water can prevent the build-up of mineral deposits and scaling. Stronger acid or a caustic soda solution can be used for removing blockages or manual removal may be required. For waterless Urinals, it is critical to regularly check the functioning of the odour seal. The tank for urine collection needs to be emptied on a regular basis. If a Urinal is used by an average of 50 people per day, each producing around 1 L of urine, a minimum of 350 L of storage is needed if emptied weekly.

**Health and Safety:** As there are low or no pathogens associated with the urine the public health risk is relatively low. A Handwashing Facility (**U.7**) has to be in close proximity.

**Costs:** Urinals can be built economically using local materials. However, any cost consideration needs to reflect the costs related to labour required for the emptying and transportation of the urine collected with daily urine loads of approx. 1–1.5 L per person and day.

**Social Considerations:** A Urinal is a comfortable and widely accepted user interface for men. However, in some cultures the use of Urinals may not be appropriate and prior consultation with users is recommended. Urinals for women are less common and users should be consulted if this can be a potential solution. It should be considered placing the Urinals in areas where open urination is an issue in order to maintain a clean and odourless environment. Handwashing stations need to be placed close to Urinals, as hand hygiene after urination is important.

**Strengths and Weaknesses:**

- ⊕ Waterless Urinals do not require a constant source of water
- ⊕ Can be built and repaired with locally available materials
- ⊕ Low capital and operating costs
- ⊖ Problems with odours may occur if not used and maintained correctly
- ⊖ Models for women are not widely available and may have acceptance issues

→ **References and further reading material for this technology can be found on page 190**

# Flush Toilet

| Phase of Emergency                                   | Application Level / Scale                   | Management Level   | Objectives / Key Features   |
|--|---|--|---|
| ** Acute Response<br>** Stabilisation<br>** Recovery | ** Household<br>** Neighbourhood<br>** City | ** Household<br>* Shared<br>* Public   | Barrier between user and excreta, Flushwater needed, Reduction of odour / flies |
| Space Required                                       | Technical Complexity                        | Inputs   | Outputs   |
| * Little   | * Low                                       | ● Faeces, ● Urine, ● Flushwater,<br>(● Anal Cleansing Water),<br>(● Dry Cleansing Materials) | ● Blackwater  |

pour flush toilet

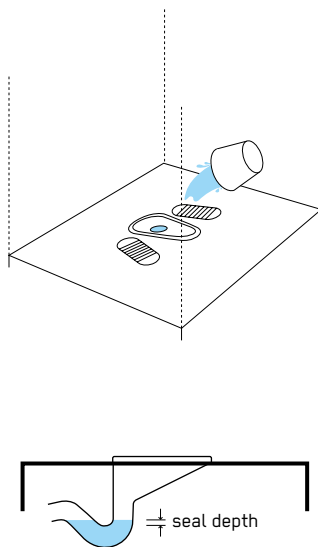

cistern flush toilet

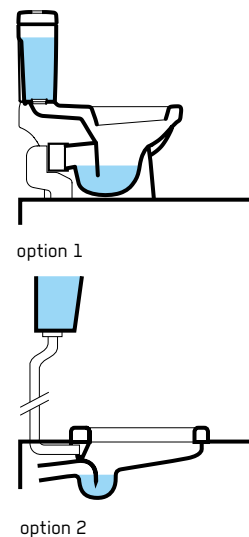

There are two types of Flush Toilets: the pour flush toilet, where water is poured in manually by the user, and the cistern flush toilet, where the water comes from a cistern above the toilet. A cistern flush toilet is directly connected to the water supply network. When the water supply is not continuous, any cistern flush toilet can become a pour flush toilet.

A Flush Toilet has a water seal that prevents odours and flies from coming up the pipe. For pour flush toilets, water is poured into the bowl to flush excreta away; approximately 1 to 3 L is usually sufficient. The quantity of water and the force of the water (pouring from a height often helps) must be sufficient to move excreta up and over the curved water seal. In cistern flush toilets, water is stored in the cistern above the toilet bowl and is released by pushing or pulling a lever. This allows water to run into the bowl, mix with the excreta, and carry it away. Alternatively water can be poured in manually using a bucket (pour flush toilet). Both pedestal and squat toilets can be

used. Due to demand, local manufacturers have become increasingly efficient at mass-producing affordable Flush Toilets.

**Design Considerations:** The U-trap that facilitates the flush toilet water seal should be made out of plastic or ceramic to prevent clogs and to make cleaning easier (concrete may clog more easily if it is rough or textured). The shape of the water seal determines how much water is needed for flushing. The optimal depth of the water seal head is approximately 2 cm to minimise water required to flush the excreta. The trap should be approximately 7 cm in diameter. Modern cistern flush toilets use 6 to 9 L per flush, whereas older models were designed for flush water quantities of up to 20 L. There are different low-volume Flush Toilets currently available that can be used with as little as 1.5 L of water per flush. A plumber is required to install a Flush Toilet to ensure that all valves are connected and sealed properly, therefore, minimising leakage.

**Materials:** Cistern flush toilets are typically made of porcelain and are a mass-produced, factory-made user interface. Squatting slabs can be made locally with concrete (providing that sand and cement are available), fibreglass, porcelain or stainless steel. Wooden or metal moulds can be used to produce several units quickly and efficiently. Prefabricated pedestals and squatting slabs made from plastic are also available, as are water seal devices that can be attached to squatting slabs.

**Applicability:** A Flush Toilet is only appropriate where a constant supply of water is available. The water does not need to be of drinking quality. Greywater can be recycled for flushing. The amount of organics and pathogens should be small, in order to prevent piping from clogging due to the growth of biofilm and to prevent user exposure to pathogens. The Flush Toilet is appropriate for those who sit or squat (pedestal or slab), as well as for those who cleanse with water or toilet tissue. The pour flush toilet requires (much) less water than a cistern flush toilet. However, because a smaller amount of water is used, the pour flush toilet may clog more easily and, thus, require more maintenance. Generally, pour flush is most suitable for pit or offset pit toilets and possibly Septic Tanks (S.13) close to the toilet. A cistern flush toilet should only be considered if all of the connections and hardware accessories are available locally. If water is available, this type of toilet is appropriate for both public and private applications. Flush toilets must be connected to a collection and storage/treatment or conveyance technology to receive the blackwater.

**Operation and Maintenance:** A pour flush toilet has no mechanical parts and is thus robust and rarely requires repair. Despite the fact that it is a water-based toilet, it should be cleaned regularly to maintain hygiene and prevent the build-up of stains. Cistern flush toilets require maintenance for the replacement or repair of some mechanical parts or fittings. Buttons, levers and the mechanisms inside the cistern are especially vulnerable. To reduce water requirements for flushing and to prevent clogging, dry cleansing materials, products used for menstrual hygiene and solid waste in general should not be flushed down the toilet. This may need to be addressed as part of hygiene promotion activities (X.12) and requires a solid waste management (X.8) scheme.

**Health and Safety:** The Flush Toilet is a safe and comfortable solution provided it is kept clean. Anal cleansing material should be provided, and a handwashing station has to be in close proximity to the toilet.

**Costs:** The cost of a Flush Toilet depends very much on the model chosen and additional costs for subsequent collection, conveyance, treatment and disposal technologies should be considered. Operating costs depend on the price of water. Cistern flush toilets are more expensive than pour flush toilets.

**Social Considerations:** The Flush Toilet prevents users from seeing or smelling the excreta of previous users. Thus, it is generally well accepted. Provided that the water seal is working well, there should be almost no odour and the toilet should be clean and comfortable to use. Flush Toilets should reflect local user preferences (sitter vs. squatter, anal cleansing practices, direction etc.) and should account for the accessibility and safety of all users, including men, women, children, elderly and disabled people (X.10).

**Strengths and Weaknesses:**

- ⊕ The water seal effectively prevents odours
- ⊕ The excreta of one user are flushed away before the next user arrives
- ⊕ Suitable for all types of users (sitters, squatters, washers, wipers with toilet tissue)
- ⊕ Low capital costs; operating costs depend on the price of water
- ⊖ Requires a constant source of water (can be recycled water and/or collected rainwater)
- ⊖ Requires materials and skills for production that are not available everywhere
- ⊖ Coarse dry cleansing materials may clog the water seal

→ **References and further reading material for this technology can be found on page 190**

# Controlled Open Defecation

| Phase of Emergency                                | Application Level / Scale               | Management Level   | Objectives / Key Features  |
|---|---|--|--|
| ★ Acute Response<br>★ Stabilisation<br>★ Recovery | Household<br>★★ Neighbourhood<br>★ City | Household<br>Shared<br>★★ Public   | Minimising immediate public health risk, Prevention of random open defecation, Fast implementation |
| Space Required                                    | Technical Complexity                    | Inputs   | Outputs  |
| ★★★ High  | ★ Low                                   | ● Faeces, ● Urine<br>(+ ● Dry Cleansing Materials)<br>(+ ● Anal Cleansing Water) | ● Excreta  |

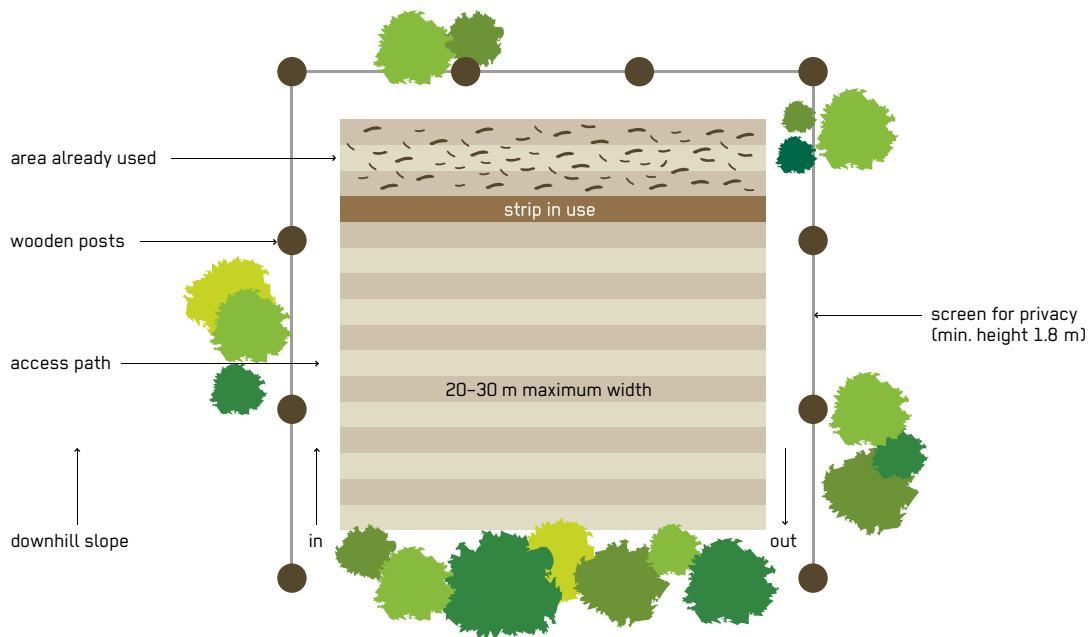

Controlled Open Defecation is an intervention that may be considered in the acute response phase where random open defecation is prevalent and no other sanitation infrastructure has been set up. It includes the provision of designated defecation sites (commonly called Open Defecation Fields) and the clearing of scattered faeces.

Controlled Open Defecation restricts and manages open defecation practises to certain pre-determined areas (defecation fields) and thereby addresses the public health risks associated with uncontrolled open defecation. In addition, areas where open defecation poses a particular public health threat (e.g. close to markets, water sources, hospitals or schools) should be very clearly marked, and open defecation in these areas be strictly controlled.

**Design Considerations:** Defecation fields require a large area of land. The area chosen should be at least 50 m from food production, storage and preparation areas (e.g. kitchens, markets), water sources, water storage and treatment facilities but close enough to ensure safety of and accessibility for users. Defecation fields should be downhill of settlements, camps and water sources to avoid contamination. The area should have proper screening for privacy, segregated sites for men and women and handwashing facilities at the entrance/exit areas. Proper lighting is recommended (including for access paths) in order to improve security at night. The defecation area consists of defecation strips, separated by screening. People should be encouraged to use one strip of land at a time and used areas must be clearly marked. Internal partitions can be used to provide more privacy and encourage greater use. After a strip is filled it is closed and faeces should be treated with lime and removed to a safe disposal site. There should be an attendant at all times,

ensuring proper use and security. To improve open defecation fields, shallow trenches (U.6) can be dug in order to promote the covering of faeces after defecation.

**Materials:** Materials are needed for proper screening and demarcation of the area. This can be done with plastic canvas or materials such as bamboo or fabrics. Wooden or metal posts are required as well as shovels and picks to set up the posts. Staff need to be provided with personal protective equipment (e.g. clothing, masks, gloves, boots), shovels, bags, buckets, wheelbarrows to remove and transport scattered faeces. Lime should be provided for subsequent treatment of faeces.

**Applicability:** Controlled Open Defecation is not considered an improved sanitation technology and should be used only as an extreme short-term measure before other sanitation options are ready to use. Wherever possible Controlled Open Defecation should be avoided and Shallow Trench Latrines (U.6) or if possible more improved sanitation solutions should be considered as a first option instead.

**Operation and Maintenance:** Routine operation and maintenance (O&M) tasks include the provision of water, soap and anal cleansing materials (either water or dry cleansing materials). An attendant should be on site at all times. In order to ensure security, continuous user orientation, proper use and the opening and closing of defecation strips. O&M also includes regular treatment of faeces with lime, their removal and burial or transport to a disposal site. If random open defecation is still prevalent in the area O&M may also include clearing of scattered faeces in the area.

**Health and Safety:** Although an improvement compared to indiscriminate open defecation, Controlled Open Defecation still remains a public health risk and should be avoided wherever possible. Involved staff must be provided with adequate personal protective equipment. Defecation fields have to be equipped with Handwashing Facilities (U.7). Solid waste containers (X.8) at the entrance/exit can further promote public health and can be an important measure for menstrual hygiene management.

Proper handwashing with soap after toilet use needs to be addressed as part of hygiene promotion activities (X.12). Additional illumination at night, security guards for protection and accessibility for all users is required.

**Costs:** The technology itself does not require high investment costs. The materials needed can usually be obtained cheaply and locally. For the operation of the technology, full-time staff members are required to ensure the correct use of the fields. Staff can be volunteer members of the local community. No technical knowledge is needed. Major costs associated with Controlled Open Defecation could arise from renting or acquiring the required land.

**Social Considerations:** A defecation field should be located where it is less likely to be a public health hazard, where costs for acquiring land are relatively low, and where it is accessible enough for people to use it. Gender segregation of facilities is critical. Having separate entrances and exits, not entirely exposed to the public, can help improve privacy. Full time attendants can promote privacy, security and correct use of the facility. Attendants can also train parents on how children should use the facility. In addition, intensive awareness raising and hygiene promotion measures are needed to ensure that defecation fields are used and random open defecation is avoided.

**Strengths and Weaknesses:**

- ⊕ Can be built and repaired with locally available materials
- ⊕ Low (but variable) capital costs depending on land availability
- ⊕ Rapid implementation
- ⊕ Minimises indiscriminate open defecation
- ⊖ Big land area required and costs to rehabilitate land may be significant
- ⊖ Lack of privacy
- ⊖ Difficult to manage

→ **References and further reading material for this technology can be found on page 190**

# Shallow Trench Latrine

| Phase of Emergency                             | Application Level / Scale               | Management Level   | Objectives / Key Features  |
|--|---|--|--|
| ★★ Acute Response<br>Stabilisation<br>Recovery | Household<br>★★ Neighbourhood<br>★ City | Household<br>Shared<br>★★ Public   | Minimising immediate public health risk, Prevention of random open defecation, Fast implementation |
| Space Required                                 | Technical Complexity                    | Inputs   | Outputs  |
| ★★★ High                                       | ★ Low                                   | ● Faeces, ● Excreta<br>(+ ● Dry Cleansing Materials)<br>(+ ● Anal Cleansing Water) | ● Excreta  |

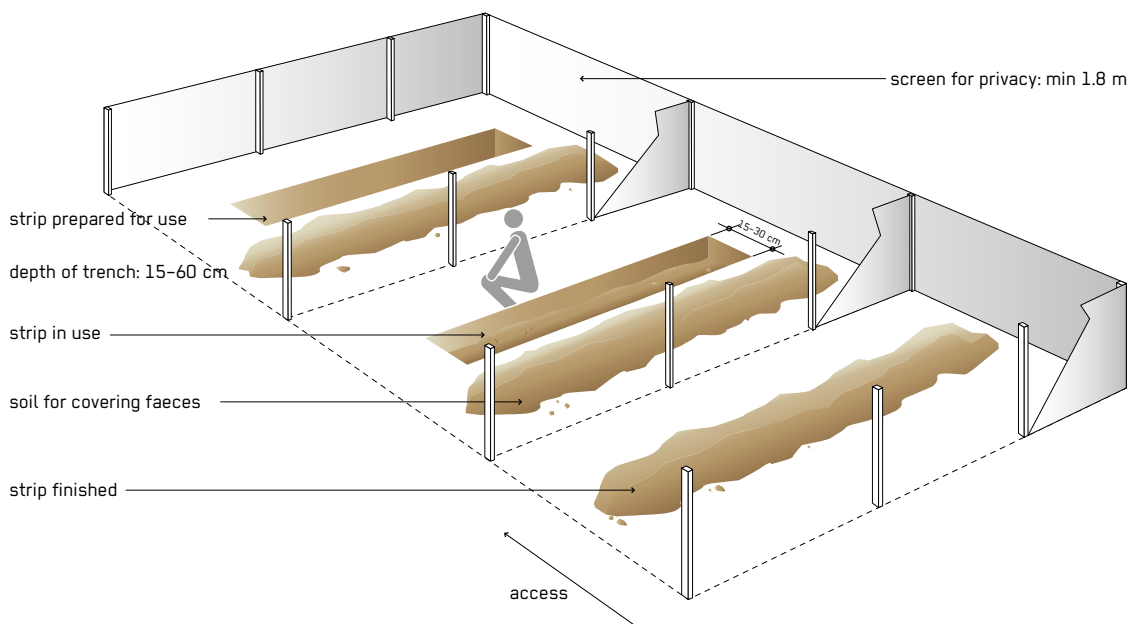

A Shallow Trench Latrine is a simple improvement of a defecation field (U.5). It consists of one or several shallowly dug trenches into which people defecate.

Faeces are covered after each use with the dug-out soil, thereby improving overall hygiene and convenience compared to that of defecation fields. A Shallow Trench Latrine is only recommended for the immediate emergency response.

**Design Considerations:** Shallow trenches should be around 20–30 cm wide and 15 cm deep, and shovels may be provided to allow each user to cover their excreta with soil. If several trenches are foreseen they should be divided into strips of around 1.5 m width with associated access paths. Trenches furthest from the entrance should be used first. When a section of trench has its bottom layer fully covered with excreta it is filled in. Only short lengths of a trench should be opened for use at any

one time to encourage the full utilisation of the trench in a short time. It may be appropriate to have a number of trenches open at the same time. Shallow Trench Latrines are very land use intensive. The area needed is approximately 0.25 m<sup>2</sup>/person/day. For 10,000 people nearly two hectares per week are needed. The area chosen should be at a safe distance from food and water sources, but close enough to population centres to assure the safety and dignity of users. Shallow Trench Latrines should include screening for privacy and should be gender segregated. Where possible, screening should be higher than a standing person (> 2 m) to promote privacy. Furthermore, there should be an attendant at all times, ensuring security and order. The important design difference between a Deep Trench Latrine (S.1) and a Shallow Trench Latrine is that the shallow version is not as deep, and therefore no lining is required.

**Materials:** Simple digging tools are needed for Shallow Trench Latrines, such as shovels and picks. In order to assure privacy screening should be provided. This can be done with plastic canvas or materials such as bamboo, fabrics and others. Shovels for users can be provided to allow each user to cover their excreta with soil.

**Applicability:** A Shallow Trench Latrine is only recommended as temporary solution for the acute emergency response and is not a suitable long-term sanitation solution. It is not considered an improved sanitation technology and should be stopped as soon as other improved emergency sanitation solutions are in place.

**Operation and Maintenance:** After each defecation, faeces should be covered with soil. After one trench section is full, the soil with excreta should be treated with on-site disinfection such as lime treatment or should be taken away to a treatment facility. When closing one defecation trench section, privacy screens and simple slabs (if applicable) need to be moved to the next trench section. In order to ensure security, proper use and the opening and closing of defecation trenches there should be an attendant at all times.

**Health and Safety:** Although a Shallow Trench Latrine minimises indiscriminate open defecation and faeces are covered with soil the technology is not an improved sanitation option. It should only be implemented to bridge the gap in the acute response phase. Shallow Trench Latrine technology requires continuous user orientation and needs to be managed well in order to keep the public health risk low. In addition, the facility needs to be gender segregated, illuminated at night and sufficiently staffed to ensure a minimum level of security. Shallow Trench Latrines have to be equipped with Handwashing Facilities (U7). Solid waste containers (X.8) at the entrance/exit can further promote public health and can be an important measure for menstrual hygiene management.

**Costs:** The technology itself does not require substantial financial investment. The materials needed usually can be obtained locally. For the operation, a full-time staff member is required to ensure correct use of the trenches. Staff can be volunteers; no engineering knowledge is needed. Major costs associated with Shallow Trench Latrines could arise from renting or acquiring the land. If the contaminated soil is treated off-site there will be transport costs and costs for sanitising the land after use.

**Social Considerations:** Shallow Trench Latrines should be located where they are less likely to be public health hazards, where costs for acquiring land are relatively low, and where they are accessible enough for people to use them. Gender segregation of facilities is critical. Having separate entrances and exits, not entirely exposed to the public, can help improve privacy. Full time attendants can promote privacy, security and correct use of the facility. Attendants can also train parents on how children should use the facility. In addition, intensive awareness raising and hygiene promotion measures are needed to ensure that the Shallow Trench Latrines are used and random open defecation is avoided.

**Strengths and Weaknesses:**

- ⊕ Can be built and repaired with locally available materials
- ⊕ Low (but variable) capital costs depending on land availability
- ⊕ Can be built immediately
- ⊖ Flies and odours are noticeable
- ⊖ Limited privacy
- ⊖ Short lifespan
- ⊖ Big land area required and costs to rehabilitate the land may be significant

→ **References and further reading material for this technology can be found on page 190**

# Handwashing Facility

| Phase of Emergency                                   | Application Level / Scale                   | Management Level                       | Objectives / Key Features                                  |
|--|---|--|--|
| ** Acute Response<br>** Stabilisation<br>** Recovery | ** Household<br>** Neighbourhood<br>** City | ** Household<br>** Shared<br>** Public | Reduction of public health risks and pathogen transmission |
| Space Required                                       | Technical Complexity                        | Inputs                                 | Outputs  |
| * Little   | * Low                                       | Water, Soap                            | ● Greywater  |

handwashing station

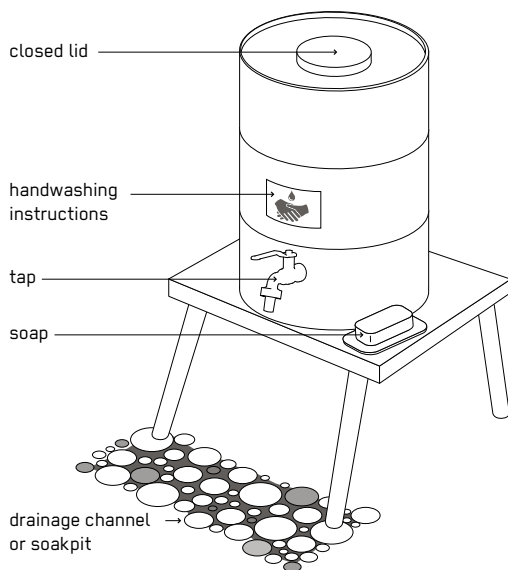

tippy tap

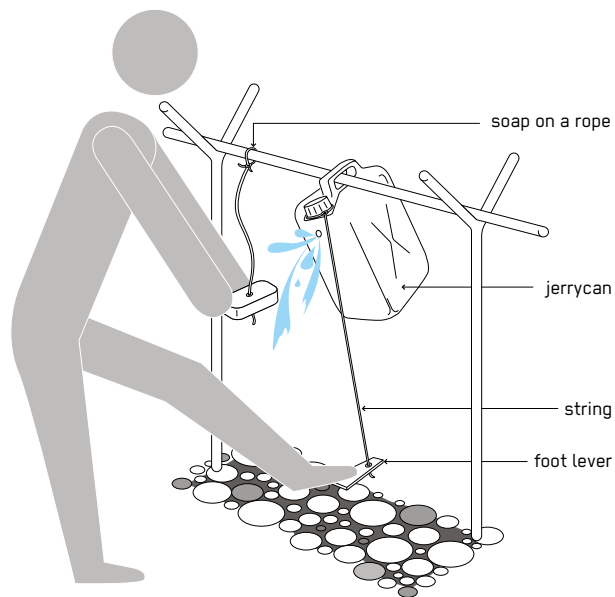

Regular handwashing during an emergency helps prevent the spread of diseases like diarrhoea, cholera and others. Handwashing Facilities need to be provided next to all toilet facilities. If handwashing is not a common practice, it needs to be promoted by tackling the drivers of handwashing behaviour. Handwashing Facilities require a constant supply of water and soap.

Handwashing with soap and water after being in contact with faecal matter, for example when going to the toilet, can lead to a substantial reduction of diarrhoeal diseases. Different studies suggest a 35–45 % reduction of the mortality rate due to diarrhoea and other water-related diseases. The practice of handwashing needs to be strongly promoted in any emergency situation and users should always have the means to wash their hands with soap. Handwashing promotion is especially important if the affected community is not used to regular handwashing or is traumatised. Two critical times for handwashing with

soap should always be promoted: After using the toilet or after cleaning the bottom of a child who has been defecating, and before preparing food and eating. Handwashing stations need to be present within a short radius (max 5 m) of each toilet, regardless if private, shared or public and in all places where food is prepared or eaten, such as markets, kitchens and eateries.

**Design Considerations:** A handwashing station has to include a constant source of water and soap. If water is not available, an alcohol-based hand sanitiser (or ash) may be used as an alternative. Handwashing facilities include taps of different sorts connected to a pipe or a container or simple low-cost solutions like Tippy Taps, which consist of a suspended jerrycan that can be tipped with a foot lever allowing water to flow out. Drainage of effluent is required in order to keep the area around the handwashing station clean and hygienic and not muddy and flooded. Effluent can be captured in a bucket catching the grey-



water, or can be discharged into open drainage channels or into a closed sewer. Where soil conditions permit, grey-water can be disposed of on-site, e.g. in Soak Pits (D.10). Alternatively, treatment and reuse options can be considered. Handwashing stations have to be inclusive (X.10) and children and people with reduced mobility have to be able to reach the handwashing facilities to use them. A very important design consideration is the durability of the tap. The tap needs to be very robust in order to prevent theft or breakage.

**Materials:** Piped water or buckets with fitted taps are required for handwashing water distribution. The standard for handwashing water quantity at public toilets is 1–2 L per user per day. The amount needed increases if the water from these stations is used for other purposes, such as general cleaning of a toilet (2–8 L per cubicle per day), visiting of mosques (5 L per visitor per day) and/or laundry (4–6 L per person per day). The minimum standard for soap for personal hygiene including handwashing is 250 g per person per month. In public facilities, a constant supply of soap has to be ensured and can be good point of distributing soap to the community. If soap is limited it can be protected by drilling a hole through the bar of soap and tying it to the handwashing station (soap on a rope).

**Applicability:** Handwashing needs to be enforced through constant promotion (X.12) in any type of humanitarian emergency and at any stage by using multiple communication channels. Handwashing and handwashing promotion is particularly important in the acute stage of an emergency to prevent a worsening of the public health situation. People who are traumatised may be more prone to neglect their personal hygiene.

**Operation and Maintenance:** Water containers need to be refilled and soap needs to be restocked constantly in public facilities and distributed where handwashing is in private shelters. With piped water, there needs to be a plumber available for minor maintenance work and repairs. Drainage channels (C.5) and Soak Pits (D.10) for effluent disposal need to be checked for clogging on a regular basis. The Handwashing Facilities need to be kept clean. In the acute response phase of an emergency and during active hygiene promotion campaigns one staff member per toilet block, next to handwashing facilities, can remind people to wash their hands and provide guidance on operating the handwashing stations and toilets.

**Costs:** Soap bars and plastic buckets for handwashing stations are usually cheap and locally available. They should be bought in great quantities at the beginning of an emergency. Other costs involve personnel for hygiene promotion and the construction of drainage or Soak Pits.

**Social Considerations:** Promotion of handwashing (X.12) is crucial during an emergency. However the provision of Handwashing Facilities needs to be ensured first, or the promotion efforts will be less effective. Promotion of handwashing does not necessarily require a health-based message. Handwashing promotion messages can include social pressure, emotional or aesthetic appeals. Drivers or barriers for certain behaviours need to be assessed in order to have an effective message for the promotion of handwashing. The involvement of local champions and hygiene promoters is key for a successful campaign. In some cases, behaviour change interventions will be needed. Promotion of handwashing has to address different drivers of the behaviour like health risk perceptions, cost-benefit beliefs, emotions, experienced social pressure, abilities, and action and barrier-reduction planning.

→ **References and further reading material for this technology can be found on page 190**

# Collection and Storage/Treatment

This section describes on-site technologies that collect and store urine, excreta, greywater and blackwater generated at the user interface (U). Some of these technologies provide a preliminary and often a passive treatment. The section also includes technologies designed specifically for on-site treatment (S.17–S.20).

|      |  |
|------|--|
| S.1  | Deep Trench Latrine  |
| S.2  | Borehole Latrine   |
| S.3  | Single Pit Latrine   |
| S.4  | Single Ventilated Improved Pit (VIP)                           |
| S.5  | Twin Pit Dry System  |
| S.6  | Twin Pit for Pour Flush  |
| S.7  | Raised Latrine   |
| S.8  | Single Vault Urine Diversion Dehydration Toilet (UDDT)         |
| S.9  | Double Vault Urine Diversion Dehydration Toilet (UDDT)         |
| S.10 | Container-Based Toilet   |
| S.11 | Chemical Toilet  |
| S.12 | Worm-Based Toilet (Emerging Technology)                        |
| S.13 | Septic Tank  |
| S.14 | Anaerobic Baffled Reactor                                      |
| S.15 | Anaerobic Filter   |
| S.16 | Biogas Reactor   |
| S.17 | Hydrated Lime Treatment (Emerging Technology)                  |
| S.18 | Urea Treatment (Emerging Technology)                           |
| S.19 | Lactic Acid Fermentation (LAF) Treatment (Emerging Technology) |
| S.20 | Caustic Soda Treatment (Emerging Technology)                   |

The choice of collection and storage/treatment technology is contextual and generally depends on the following factors:

- Availability of space
- Soil and groundwater characteristics
- Type and quantity of input products
- Local availability of materials
- Desired output products
- Availability of technologies for subsequent transport
- Financial resources
- Management considerations
- User preferences
- Local capacity

S

# Deep Trench Latrine

| Phase of Emergency                               | Application Level / Scale             | Management Level   | Objectives / Key Features   |
|--|---------------------------------------|--|---|
| ** Acute Response<br>* Stabilisation<br>Recovery | Household<br>** Neighbourhood<br>City | Household<br>* Shared<br>** Public   | Excreta containment, Minimising immediate public health risk, Fast implementation |
| Space Required                                   | Technical Complexity                  | Inputs   | Outputs   |
| ** Medium  | * Low                                 | ● Excreta, ● Faeces, ● Blackwater,<br>(● Anal Cleansing Water),<br>(● Dry Cleansing Materials) | ● Sludge  |

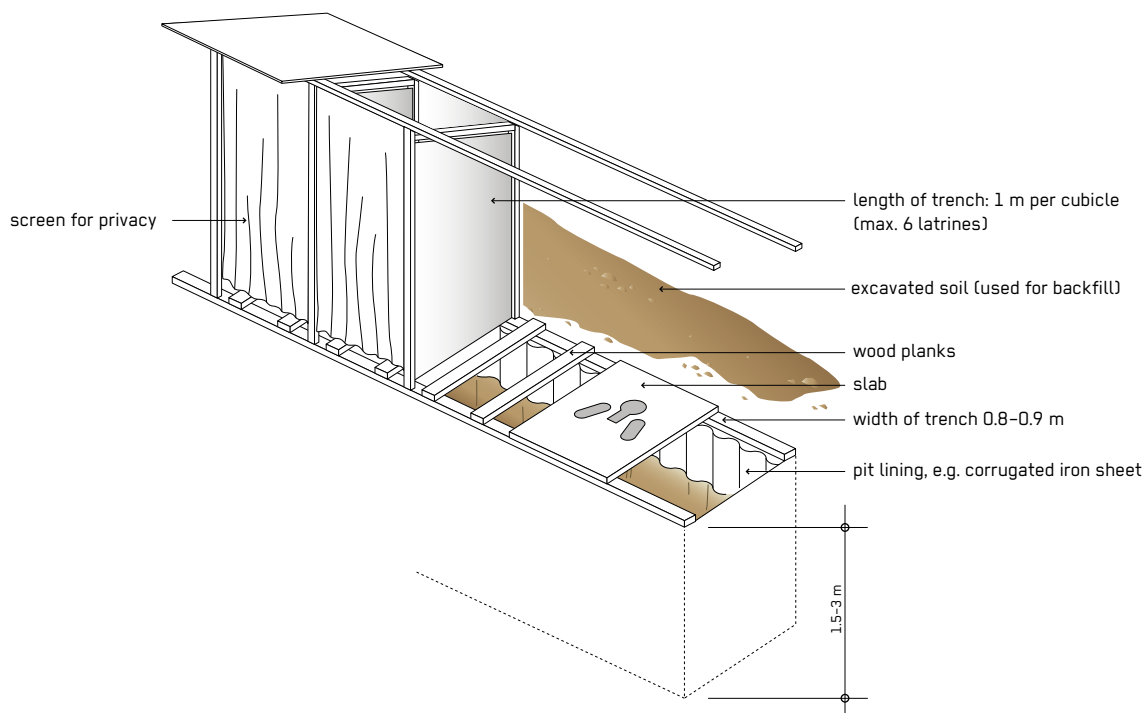

A Deep Trench Latrine is a widely-used communal latrine option for emergencies. It can be quickly implemented (within 1–2 days) and consists of several cubicles aligned up above a single trench. A trench lining can prevent the latrine from collapsing and provide support to the superstructure.

As the trench fills, three processes limit the rate of accumulation whilst providing no significant treatment: leaching, degradation and consolidation. The liquid phase (i.e. urine and water) leaches into the soil through the unlined bottom and walls of the pit, while microbial activity degrades part of the organic fraction and stabilises the pit content. As a result, consolidation occurs.

**Design Considerations:** Trenches should be around 0.8–0.9 m wide with at least the top 0.5 m depth of the pit lined for stability. The depth (usually between 1.5 to 3 m) may vary depending on local soil conditions and required

speed of implementation. A maximum trench length of 6 m is recommended, providing for six cubicles. End cubicles can be extended to make them accessible for disabled people or provide washing spaces, for example for women during menstruation. Proper drainage should be provided for around the trench to ensure runoff and prevent flooding. When the trench is complete, slabs are placed over it. Prefabricated self-supporting plastic slabs can increase the speed of construction, if available. Alternatively, wooden planks can be secured across the trench (leaving out every third or fourth plank for defecation) until wooden or concrete slabs can be produced locally. The slabs can be fitted with pedestal toilets where users do not squat. Separate trench latrines for men and women should be considered. The trench lifespan (the time required to fill it to within half a metre of the top) is a function of the trench volume, divided by the number of users and estimated excreta volume generated per person. On average, solids accumulate at a rate of 3–5 L/person/month and

up to 5–7.5 L/person/month if dry cleansing materials are used. Special attention should be paid to the expected groundwater level and the associated risks of groundwater pollution as well as the topography, ground conditions and soil permeability. Poorly permeable soil will increase the rate at which the pit fills.

**Materials:** If possible, locally available construction materials should be used. The latrine superstructure can be made from local materials, such as bamboo, wood, plastic or metal sheeting (though this often heats up the interior). The trench lining can be made from bricks, timber, sand bags or temporary lining materials such as bamboo poles or matting. Some relief agencies have rapid response kits for slabs and superstructure which can be used where there are few resources locally.

**Applicability:** Deep Trench Latrines can be a viable solution in the acute phase of an emergency provided that the technology is acceptable to the users, the ground conditions allow digging of deep trenches and there are sufficient tools, materials and human resources available. As no water is needed for operation it is also a viable solution for water-scarce areas. Deep Trench Latrines can be replicated fast and implemented at scale given that enough space is available.

**Operation and Maintenance:** Deep Trench Latrines are usually built as communal latrine blocks. The general operation and maintenance (O&M) measures therefore include regular cleaning, routine operational tasks such as checking availability of water, hygiene items, soap and dry cleansing materials, providing advice on proper use, conducting minor repairs and monitoring of trench filling level. O&M also includes daily covering of excreta with a 10 cm layer of soil to minimise odour and prevent fly breeding. As trenches are often misused for solid waste disposal, which can complicate later emptying, awareness raising measures (X.12) should be a part of installation programmes. Accessibility for desludging vehicles (C.2) should be considered. If desludging is not an option the latrines should be decommissioned (X.6) when the trench is filled up to 0.5 m below the top of the trench.

**Health and Safety:** If used and managed well, Deep Trench Latrines can be considered a safe excreta containment technology in the acute response phase. They should be equipped with Handwashing Facilities (U.7) and proper handwashing with soap after toilet use needs to be addressed as part of hygiene promotion activities (X.12). Additional illumination at night, security guards for protection and accessibility for all users is required.

The trench site should be carefully chosen to avoid areas prone to flooding and drainage ensured as part of construction. As with all pit-based systems, groundwater contamination can be an issue and soil properties such as the permeability of the soil and groundwater level should be properly assessed (X.3) to identify the minimum distance to the next water source and limit exposure to microbial contamination. The Sphere minimum standards on excreta management should be consulted for further guidance. Emptying the trench (C.1, C.2) should be carried out in such a way as to minimise the risk of disease transmission including personal protective equipment and hygiene promotion activities (X.12).

**Costs:** Building Deep Trench Latrines is relatively inexpensive. Costs vary depending on availability and costs of local materials or use of prefabricated slabs and cubicles. Cost calculations also need to reflect O&M requirements and follow-up costs such as regular desludging, transport, treatment and disposal/reuse of accumulating sludge.

**Social Considerations:** If time allows, the design of Deep Trench Latrines should be discussed with the community before installation. It should reflect local user preferences (sitter vs. squatter, anal cleansing practices, direction, positioning, screens etc.) and should account for the accessibility and safety of all users, including men, women, children, elderly and disabled people (X.10). As Deep Trench Latrines are usually communal latrines, O&M will require particular attention. Roles and responsibilities for O&M need to be agreed upon early on and closely linked to hygiene promotion activities (X.12). As trenches are often misused for solid waste disposal, which might negatively affect later emptying of the trench, special awareness raising measures should be considered.

**Strengths and Weaknesses:**

- ⊕ Inexpensive and quick to construct
- ⊕ No water needed for operation
- ⊕ Easily understood
- ⊖ Unsuitable for areas with high water-table, unstable soil, rocky ground or prone to flooding
- ⊖ Often odour and fly problems and issues with other vectors
- ⊖ Needs appropriate faecal sludge management concept
- ⊖ Groundwater contamination might be an issue

→ **References and further reading material for this technology can be found on page 190**

# Borehole Latrine

| Phase of Emergency                               | Application Level / Scale                | Management Level   | Objectives / Key Features  |
|--|--|--|--|
| ** Acute Response<br>* Stabilisation<br>Recovery | ** Household<br>** Neighbourhood<br>City | ** Household<br>** Shared<br>* Public  | Safe containment, Minimising<br>immediate public health risk,<br>Fast implementation |
| Space Required                                   | Technical Complexity                     | Inputs   | Outputs  |
| * Little   | * Low                                    | ● Urine, ● Faeces,<br>(● Anal Cleansing Water),<br>(● Dry Cleansing Materials) | (● Sludge)   |

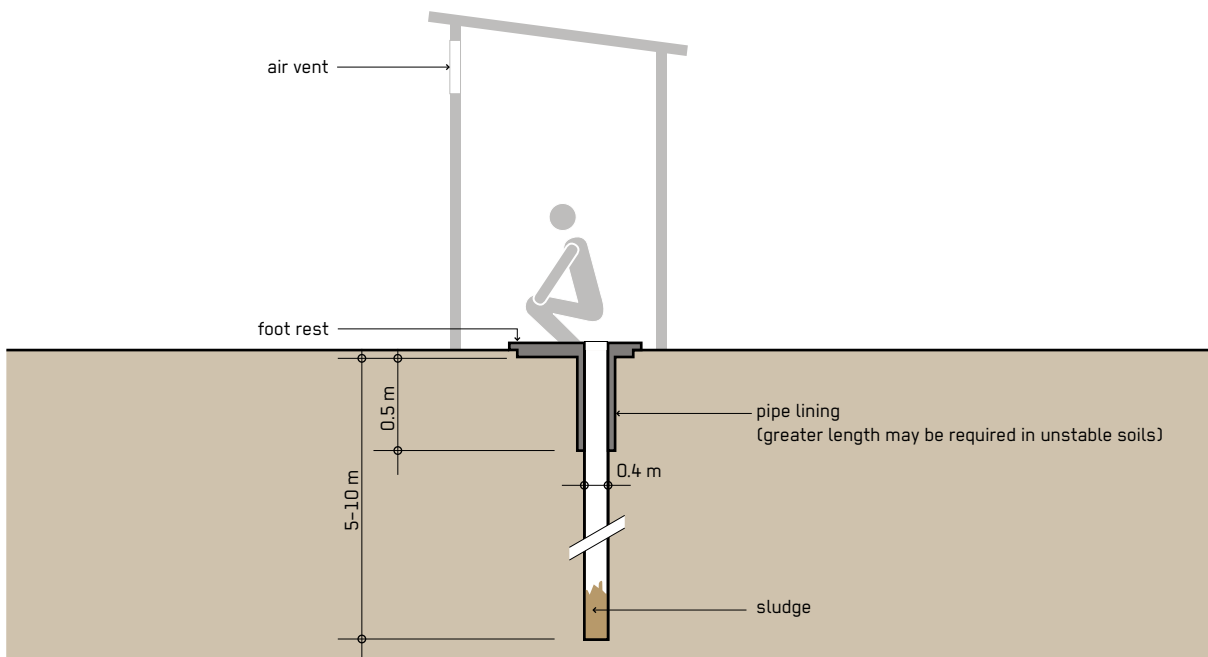

Borehole Latrines are mainly provided in the acute response phase, when a large number of latrines are required quickly and the site conditions do not allow for the excavation of bigger pits. A borehole driller is the main requirement for implementation.

Borehole Latrines are usually temporary solutions but depending on diameter, depths and number of users they can also be considered a longer-term solution with a potential life span of several years. The hole is bored using either a mechanical or manual auger or a drilling machine.

**Design Considerations:** Depending on the soil type and drilling equipment the borehole should be between 5 to 10 m deep with a diameter of usually between 0.3 to 0.5 m. A pipe lining is required at the top 0.5 m and may be greater in length in more unstable soil formations. The superstructure can either be simple screens around the hole (as a temporary solution) or more solid cubicles.

As it is not possible to easily ventilate the borehole, the superstructure should allow for air circulation to reduce potential odour problems. The hole should be covered with a slab or pedestal. The lifespan (the time required to fill the borehole to within half a metre of the top) is a function of the borehole volume, divided by the number of users and estimated excreta volume generated per person. On average, solids accumulate at a rate of 3–5 L/person/month and up to 5–7.5 L/person/month if dry cleansing materials are used. Special attention should be paid to the expected groundwater level and the associated risks of groundwater pollution as well as the topography, ground conditions and soil permeability. Poorly permeable soil will increase the rate at which the borehole fills.

**Materials:** To construct a Borehole Latrine a manual or mechanical auger or a drilling machine is the main requirement. The user interface can be made out of wood, bamboo, concrete or prefabricated plastic. For the su-

perstructure, materials should be used that are readily available and that can be applied rapidly (e.g. bamboo, grass matting, cloth, wood, plastic or metal sheeting). For the borehole lining, a pipe should be used, with a minimum length of 0.5 m and corresponding to the borehole diameter. Some relief agencies have rapid response kits for slabs and superstructure which can be used where there are few resources locally.

**Applicability:** A Borehole Latrine can be implemented quickly and therefore is considered an appropriate solution in the acute response phase provided the technology is acceptable to the users, the ground conditions allow for the drilling of deep holes and there are sufficient tools, materials and human resources available. The soil needs to be stable and free of rock, gravel and boulders.

**Operation and Maintenance:** General operation and maintenance (O&M) measures include routine tasks such as checking the availability of water to ensure personal hygiene, of soap and dry cleansing material and monitoring the condition and fill level of the hole. Particular attention should be paid to the cleanliness of the top of the borehole. This is easily soiled and will quickly begin to smell and harbour flies if not regularly cleaned. As desludging is usually not an option the latrine should be decommissioned **(X.6)** when filled up to the top 0.5 m of the hole.

**Health and Safety:** If used and managed well, Borehole Latrines can be considered a safe excreta containment technology. They need to be equipped with Handwashing Facilities **(U.7)** and proper handwashing with soap after toilet use needs to be addressed as part of hygiene promotion activities **(X.12)**. As with all pit-based systems, groundwater contamination can be an issue and soil properties such as the permeability of the soil and groundwater level should be properly assessed **(X.3)** to

identify the minimum distance to the next water source and limit exposure to microbial contamination. The Sphere minimum standards on excreta management should be consulted for further guidance.

**Costs:** Building Borehole Latrines is relatively inexpensive. Costs vary depending on the availability and costs of an auger or drilling machine and local materials. Cost calculations need to include ongoing O&M requirements.

**Social Considerations:** The design of the Borehole Latrine should ideally be discussed with the community beforehand. It should reflect local user preferences (sitter vs. squatter, anal cleansing practices, direction, positioning, screens etc.) and should account for the accessibility and safety of users, including men, women, children, elderly and disabled people **(X.10)**. The potential handing over to beneficiaries and the roles and responsibilities for O&M need to be agreed upon early on and closely linked to respective hygiene promotion activities **(X.12)** to ensure appropriate use and O&M of the facilities.

**Strengths and Weaknesses:**

- ⊕ Inexpensive
- ⊕ Quick to construct
- ⊕ No water needed for operation
- ⊕ Little space required
- ⊖ Unsuitable for areas with high water-table, unstable soil and rocky ground
- ⊖ Often odour and fly problems
- ⊖ Groundwater contamination might be an issue
- ⊖ Drilling machine is needed
- ⊖ Relatively short lifetime

→ **References and further reading material for this technology can be found on page 190**

# Single Pit Latrine

| Phase of Emergency                                   | Application Level / Scale               | Management Level   | Objectives / Key Features                    |
|--|---|--|--|
| ** Acute Response<br>** Stabilisation<br>** Recovery | ** Household<br>* Neighbourhood<br>City | ** Household<br>** Shared<br>Public  | Excreta containment, Sludge volume reduction |
| Space Required                                       | Technical Complexity                    | Inputs   | Outputs                                      |
| * Little   | * Low                                   | ● Faeces, ● Excreta, ● Blackwater,<br>(+ ● Dry Cleansing Materials),<br>(+ ● Anal Cleansing Water) | ● Sludge                                     |

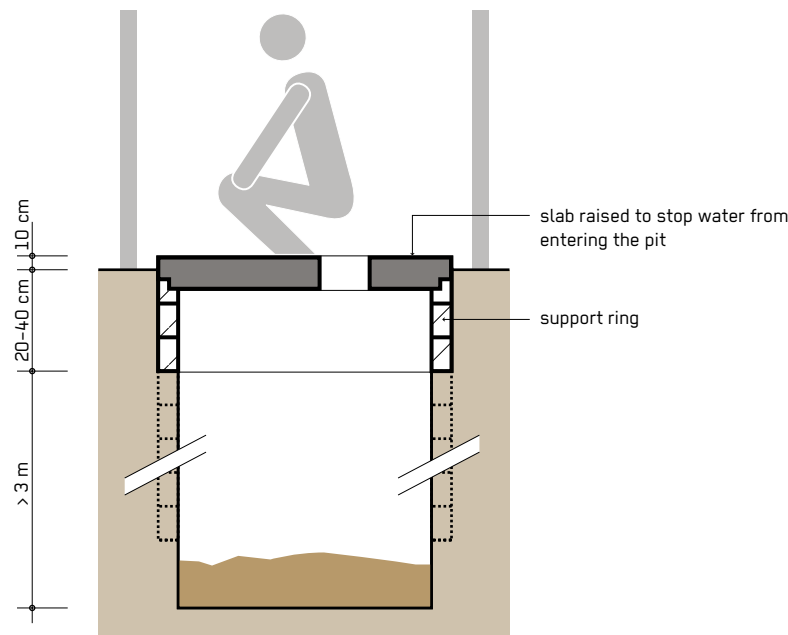

The Single Pit Latrine is one of the most widely used sanitation technologies. Excreta, along with anal cleansing materials (water or solids) are deposited into the pit. Lining the pit prevents it from collapsing and provides support to the superstructure.

As the Single Pit Latrine fills, three processes limit the rate of accumulation: leaching, consolidation and degradation. Urine and water percolate into the soil through the bottom and walls of the pit, while microbial action partially degrades the organic fraction. A smooth, and regularly cleaned platform can promote hygienic conditions by minimising possible human contact with faeces.

**Design Considerations:** Single Pit Latrines vary in size and are typically at least 3 m deep and 1 m in diameter. The top of the pit should be lined to prevent it from collapsing while the bottom of the pit should remain unlined to allow for infiltration. The latrine slab should be at least

10 cm above the surrounding ground to prevent flooding with rainwater runoff. The pit lining should extend at least 40 cm to support the cover, prevent wall collapse and prevent rodents from burrowing into the pit. On average, solids accumulate at a rate of 40–60 L/person/year and up to 90 L/person/year if dry cleansing materials such as leaves or paper are used. The volume of the pit should be designed to contain at least 1,000 L. If 50 people are using one pit of 3 m depth and 1 m diameter and using dry cleansing materials, it will fill after approximately 6 months. The latrine design should include arrangements for emptying. When it is not possible to dig a deep pit or the groundwater level is too high, a Raised Latrine (S.7) can be a suitable alternative. It is worth considering upgrading the pit latrine to a more sophisticated technology like a Single Ventilated Improved Pit (S.4), a twin pit system (S.5, S.6) or a Double Vault Urine Diversion Dehydration Toilet (S.9) at a later stage. This should be considered in the initial design.



**Materials:** The latrine superstructure can be made from local materials, such as bamboo, grass matting, wood, plastic or metal sheeting (though this often heats up the interior). Pit lining materials can include brick, rot-resistant timber, bamboo, concrete, stones, or mortar plastered onto the soil. Some agencies have rapid response kits for slabs and superstructure which can be flown in for immediate use or that can be stockpiled in advance. The slab on top can be fabricated on-site with a mould and cement. In the acute emergency phase, pre-fabricated plastic slabs may be used. However, if produced cheaply, they should be replaced frequently after they become brittle. Other slab materials such as wood or bamboo are also possible, where no other materials are available. Once the pit is full, equipment for emptying or materials for covering the pit are required.

**Applicability:** Single Pit Latrines can be constructed quickly with local materials during the acute phase of an emergency. Single pits are appropriate for rural and peri-urban areas. In densely populated areas, pit emptying can be difficult and there is often insufficient space for infiltration. Single pits are especially appropriate when water is scarce and where there is a low groundwater table. They are not suited for rocky or compacted soils, or for areas that flood frequently. For long-term solutions, they should be upgraded to Ventilated Improved Pits (S.4), to lower the presence of flies and odours.

**Operation and Maintenance:** Daily maintenance associated with a single pit includes regular cleaning, routine operational tasks such as checking availability of water, hygiene items, soap and dry cleansing materials, providing advice on proper use, conducting minor repairs and monitoring of the pit fill level. As pits are often misused for solid waste disposal, which can complicate pit emptying, awareness raising measures (X.12) should be a part of installation programmes. When the pit is full it needs either desludging (including subsequent transport, treatment and safe disposal/reuse options) or if enough space is available the superstructure and squatting plate can be moved to a new pit with the previous pit safely covered and decommissioned (X.6).

**Health and Safety:** If used and managed well, Single Pit Latrines can be considered a safe excreta containment technology. They need to be equipped with Handwashing Facilities (U.7) and proper handwashing with soap after toilet use needs to be addressed as part of hygiene promotion activities (X.12). As with all pit-based systems,

groundwater contamination can be an issue and soil properties such as the permeability of the soil and groundwater level should be properly assessed (X.3) to limit exposure of water sources to microbial contamination. The Sphere minimum standards on excreta management should be consulted for further guidance. Emptying of the pit (C.1, C.2) should be carried out in such a way as to minimise the risk of disease transmission including personal protective equipment and hygiene promotion activities (X.12). If the latrine is for communal use additional illumination at night, security guards for protection and accessibility for all users is required.

**Costs:** A pit latrine with slab is a low-cost technology, as minimal materials and minimal skills for constructions are needed. Costs will depend on local material prices. The costs of emptying and transporting pit latrine sludge or covering the pit and constructing a new pit also need to be considered. When constructing a new pit, the slab of the previous pit can be reused, if still in usable condition.

**Social Considerations:** The design of Single Pit Latrines should be discussed with the community beforehand. It should reflect local user preferences (sitter vs. squatter, anal cleansing practices, direction, positioning, screens etc.) and should account for the accessibility and safety of all users, including men, women, children, elderly and disabled people (X.10). The potential handing over to beneficiaries and the roles and responsibilities for O & M need to be agreed upon early on and closely linked to respective hygiene promotion activities (X.12) to ensure appropriate use and O & M of the facilities.

**Strengths and Weaknesses:**

- ⊕ Can be built and repaired with locally available materials
- ⊕ Low (but variable) capital costs depending on materials and pit depth
- ⊕ Small land area required
- ⊖ Flies and odours are normally noticeable
- ⊖ Low pathogen reduction with possible contamination of groundwater
- ⊖ Costs to empty may be significant compared to capital costs
- ⊖ Sludge requires secondary treatment and/or appropriate discharge

→ **References and further reading material for this technology can be found on page 190**

# Single Ventilated Improved Pit (VIP)

| Phase of Emergency  | Application Level / Scale  | Management Level   | Objectives / Key Features  |
|---|--|--|--|
| <ul style="list-style-type: none"> <li>* Acute Response</li> <li>** Stabilisation</li> <li>** Recovery</li> </ul> | <ul style="list-style-type: none"> <li>** Household</li> <li>** Neighbourhood</li> <li>City</li> </ul> | <ul style="list-style-type: none"> <li>** Household</li> <li>** Shared</li> <li>* Public</li> </ul>  | Excreta containment, Sludge volume reduction, Reduction of odour and flies |
| Space Required  | Technical Complexity   | Inputs   | Outputs  |
| <ul style="list-style-type: none"> <li>* Little</li> </ul>  | <ul style="list-style-type: none"> <li>* Low</li> </ul>  | <ul style="list-style-type: none"> <li>● Excreta, ● Faeces, ● Blackwater,</li> <li>(● Anal Cleansing Water),</li> <li>(● Dry Cleansing Materials)</li> </ul> | <ul style="list-style-type: none"> <li>● Sludge</li> </ul>                 |

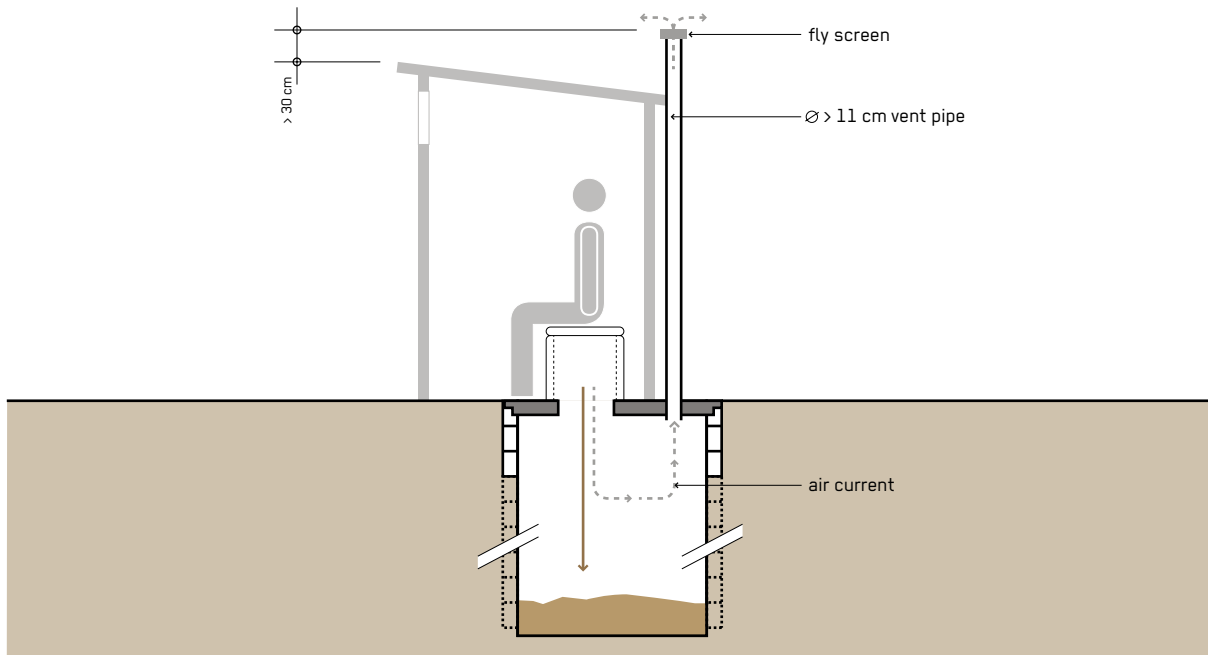

The Single VIP is seen as an improvement over the Single Pit Latrine (S.3) because continuous airflow through the ventilation pipe prevents odours and acts as a trap for flies as they escape towards the light.

When correctly designed, built, used and maintained, Single VIPs can be completely odour-free. Flies that hatch in the pit are attracted to the light at the top of the ventilation pipe. When they fly towards the light and try to escape, they are trapped by the fly-screen and eventually die. The ventilation also allows odours to escape and minimises the attraction for flies.

**Design Considerations:** The only design difference to a Single Pit Latrine is the ventilation. All other design considerations are covered in the Simple Pit Latrine sheet (S.3). For the ventilation, a straight vent pipe is needed with an internal diameter of at least 11 cm and reaching more than 30 cm above the highest point of the toilet

superstructure. Wind passing over the top creates a suction pressure within the pipe and induces an air circulation. Air is drawn through the user interface into the pit and moves up the vent pipe. The vent works best in windy areas and surrounding objects, such as trees or houses, should not interfere with the air stream. Where there is little wind, effectiveness can be improved by painting the pipe black. The heat difference between pit (cool) and vent (warm) creates an additional updraft. To test ventilation efficacy, a smoking stick or similar object can be held over the user interface; the smoke should then be pulled down into the pit. The mesh size of the fly screen must be large enough to prevent clogging with dust and allow air to circulate. The toilet interior must be kept dark (or the toilet hole kept closed with a lid) so that flies in the pit are attracted to the light of the vent pipe. VIPs without dark interiors, or with uncovered defecation holes, reduce odour but not flies.

**Materials:** The latrine superstructure can be made from local materials, such as bamboo, grass matting, wood, plastic or metal sheeting (though this often heats up the interior). Pit lining materials can include brick, rot-resistant timber, bamboo, concrete, stones, or mortar plastered onto the soil. Some agencies have rapid response kits for slabs and superstructure which can be flown in for immediate use or that can be stockpiled in advance. The slab on top can be fabricated on site with a mould and cement. In the acute emergency phase, pre-fabricated plastic slabs may be used. Other slab materials such as wood or bamboo are also possible, where no other materials are available. Once the pit is full, equipment for emptying or materials for covering the pit are required. The ventilation pipe can be made from a range of materials, including PVC or metal piping, masonry, hollowed bamboo or similar.

**Applicability:** Single VIPs are a significant improvement over Single Pit Latrines and can be considered a viable solution in all phases of an emergency. Special attention should be paid to the anticipated groundwater level and associated risks of groundwater pollution. As no water is needed for operation it is also an appropriate solution for water scarce areas. It can be replicated quickly and implemented at scale given sufficient space. The Single VIP should be built in an area with a good breeze to ensure effective ventilation. Like other pit latrines they are not suitable in areas with rocky or compacted soils or in areas that flood frequently. VIPs rarely work as communal toilets as they are often improperly used and with unclear ownership, maintenance quickly becomes a problem.

**Operation and Maintenance:** General operation and maintenance (O&M) tasks include regular cleaning, ensuring the availability of water, hygiene items, soap and dry cleansing materials, conducting minor repairs and monitoring pit fill levels. Dead flies, dust and other debris should be removed from the fly screen to ensure good air flow. As pits are often misused for solid waste disposal, which can complicate pit emptying, awareness raising measures (X.12) should be a part of installation programmes. VIPs for general public use may have a sludge build-up rate too fast for absorption into the soil and will thus require regular emptying. If regular desludging is needed the accessibility for desludging vehicles (C.1, C.2) must be considered.

**Health and Safety:** If used and managed well, a Single VIP can provide a clean, comfortable, and acceptable toilet. Single VIPs need to be equipped with Handwashing Facilities (U.7). They need to be equipped with Handwashing Facilities (U.7) and proper handwashing with soap after toilet use needs to be addressed as part of hygiene promotion activities (X.12). As with all pit-based

systems, groundwater contamination can be an issue and soil properties such as the permeability of the soil and groundwater level should be properly assessed (X.3) to limit exposure of water sources to microbial contamination. The Sphere minimum standards on excreta management should be consulted for further guidance. Emptying of the pit (C.1, C.2) should be carried out in such a way as to minimise the risk of disease transmission including personal protective equipment and hygiene promotion activities (X.12). If the latrine is for communal use additional illumination at night, security guards for protection and accessibility for all users is required. Pits remain susceptible to failure and/or overflowing during floods and health risks associated with flies are not completely removed by ventilation.

**Costs:** Building a Single VIP can be relatively inexpensive. Costs vary depending on the availability and costs of local materials or use of prefabricated slabs and cubicles. However, cost considerations also need to reflect additional O&M requirements and potential follow-up costs like regular desludging, transport, treatment and sludge disposal/reuse.

**Social Considerations:** The design of the Single VIP should be discussed with the community beforehand. It should reflect local user preferences (sitter vs. squatter, anal cleansing practices, direction, positioning, screens etc.) and should account for accessibility and safety of all users including men, women, children, elderly and disabled people (X.10). Potential handing over to beneficiaries and roles and responsibilities for O&M need to be agreed upon early on and closely linked to hygiene promotion (X.12) in order to ensure appropriate use of the facilities.

**Strengths and Weaknesses:**

- ⊕ Flies and odours are significantly reduced (compared to non-ventilated pits)
- ⊕ Can be built and repaired with locally available materials
- ⊕ Low (but variable) capital costs depending on materials and pit depth
- ⊕ Small land area required
- ⊖ Low pathogen reduction with possible contamination of groundwater
- ⊖ Costs to empty may be significant compared to capital costs
- ⊖ Sludge requires secondary treatment and/or appropriate discharge

→ **References and further reading material for this technology can be found on page 191**

# Twin Pit Dry System

| Phase of Emergency                                | Application Level / Scale                   | Management Level   | Objectives / Key Features   |
|---|---|--|---|
| Acute Response<br>★★ Stabilisation<br>★★ Recovery | ★★ Household<br>★★ Neighbourhood<br>★★ City | ★★ Household<br>★★ Shared<br>★ Public  | Excreta containment, Sludge volume reduction, Extended treatment time |
| Space Required                                    | Technical Complexity                        | Inputs   | Outputs   |
| ★★ Medium   | ★ Low                                       | ● Excreta, ● Faeces, (● Organics),<br>(● Anal Cleansing Water),<br>(● Dry Cleansing Materials) | ● Pit Humus   |

fossa alterna

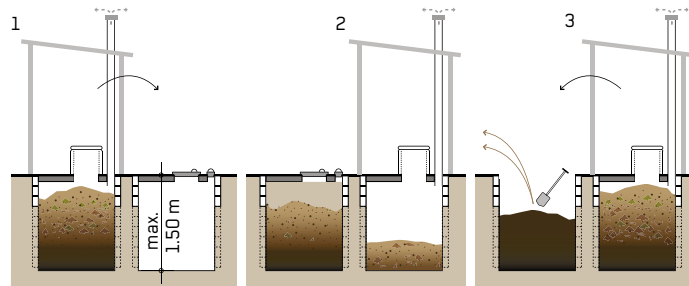

double ventilated improved pit (VIP)

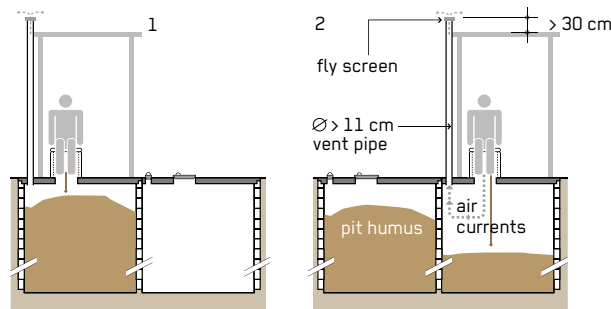

Twin Pit Dry Systems use two pits in alternating order. Twin pit systems include double Ventilated Improved Pits (VIP), and the fossa alterna (FA). Pit alternation allows for effluent to infiltrate into the soil and sludge to decompose in the one pit, while the other pit is in use. The alternating system reduces the amount of pit humus that needs to be emptied and makes the end product more hygienic.

Twin Pit Dry Systems can be constructed as double pit, double VIP or FA. In a double VIP excreta (or faeces, if a Urine Diverting Dry Toilet (U.2) is used as a user interface) are converted into pit humus, while in a FA additional organic materials are added to the pit. After every use of a FA dry organic materials such as ash or leaf litter are added to the pit. The FA is built with a shallow pit, with a depth of around 1.5 m, while the double VIP pits can have a depth of up to 3 m. In both systems, the two pits are used alternately. The effluent infiltrates into the soil. When the first pit has filled up it is sealed and the toilet user interface

is switched to the second pit. While the second pit is in use the materials in the first pit can decompose and dry, thus decrease in volume and become more hygienic. Due to the extended resting time, the material within the pit is partially sanitised and humus-like. Usually the alternation cycle is 6–24 months depending on the pit volume and the number of users.

**Design Considerations:** For each system, only one toilet user interface is needed, which is moved from the first pit to the second pit when the first pit is full. Double VIPs are built like Single VIPs (S.4) but with two collection pits. Each pit must be provided with their own ventilation system. As the FA is much shallower, it can be constructed above the ground, and may be appropriate for flood prone areas or where the groundwater table is high. Pits should be built next to each other with enough distance between them to avoid cross contamination.

**Materials:** The latrine superstructure can be made from local materials, such as bamboo, grass matting, wood, plastic or metal sheeting (though this often heats up the interior). Pit lining materials can include brick, rot-resistant timber, bamboo, concrete, stones, or mortar plastered onto the soil. The slab can be fabricated on-site with a mould and cement. In the acute emergency phase, pre-fabricated plastic slabs may be used. Other slab materials such as wood or bamboo are also possible, where no other materials are available. For the FA there is a need for constant supply of organic material, such as ash or dry leaves, to be added after each use.

**Applicability:** Double pit systems are appropriate where there is enough space and reuse potential for the pit humus that is being generated. Therefore, these systems are most appropriate in rural and peri-urban settings and in communities comfortable with handling and re-using faecal material. As the second pit only comes into operation when the first pit is full, which may take between 6 to 24 months, Twin Pit Dry Systems are recommended as longer-term solutions in prolonged emergency situations.

**Operation and Maintenance:** Other than the operation and maintenance (O&M) required for the Single VIP, the main operational task for double VIPs is to seal pits when they are full and empty full pits prior to re-use. The FA must always be furnished with dry organic material to add to the pit after every use. If pits are used simultaneously the system does not function. Where there is only one user interface and, for the VIP, one ventilation pipe they must be switched to the new pit when the old one is full. In some designs, the entire superstructure can be moved from pit to pit.

**Health and Safety:** By covering excreta or faeces with soil, ash, and/or leaves, flies and odours are kept to a minimum. Keeping the contents sealed in the pit for the duration of at least one year makes the pit humus safer and

easier to handle. However, care should still be given when handling the output product. The same precautions that are taken when handling compost should be taken with the humus derived from double VIPs or the FA. Additional health concerns include that the leachate can potentially contaminate groundwater, that the pits are susceptible to failure and/or overflowing during floods and that the health risks from flies are not completely removed by ventilation.

**Costs:** Construction costs for Twin Pit Dry Systems are usually around double those of single pit systems, except for the user interface that can be switched. However, costs for O&M decrease as the pits need to be emptied less frequently. As the area of the system is doubled compared to single pit systems, any costs associated with elevated land use have to be considered.

**Social Considerations:** Users should have an appreciation of the advantages of the Twin Pit Dry System and should be willing to operate and maintain it. If users do not appreciate the benefits, the system could fail. Double pit systems are usually built as toilets serving single households, ensuring a clear attribution of O&M responsibilities. If used as shared or public facilities the responsibilities for O&M must be clearly determined prior to the implementation.

**Strengths and Weaknesses:**

- ⊕ Easier excavation than single pit systems
- ⊕ Reduction in sludge volume and pathogens
- ⊕ Can be built with locally available materials
- ⊕ Pit humus can be used as fertiliser/soil conditioner
- ⊖ Double the space and materials required
- ⊖ Possible contamination of groundwater
- ⊖ Constant organic material supply needed for FA

→ **References and further reading material for this technology can be found on page 191**

# Twin Pits for Pour Flush

| Phase of Emergency                               | Application Level / Scale                | Management Level                      | Objectives / Key Features   |
|--|--|---------------------------------------|---|
| Acute Response<br>★ Stabilisation<br>★★ Recovery | ★★ Household<br>★★ Neighbourhood<br>City | ★★ Household<br>★★ Shared<br>★ Public | Excreta containment, Sludge volume reduction, Extended treatment time |
| Space Required                                   | Technical Complexity                     | Inputs                                | Outputs   |
| ★★ Medium  | ★ Low                                    | ● Blackwater, (● Greywater)           | ● Pit Humus   |

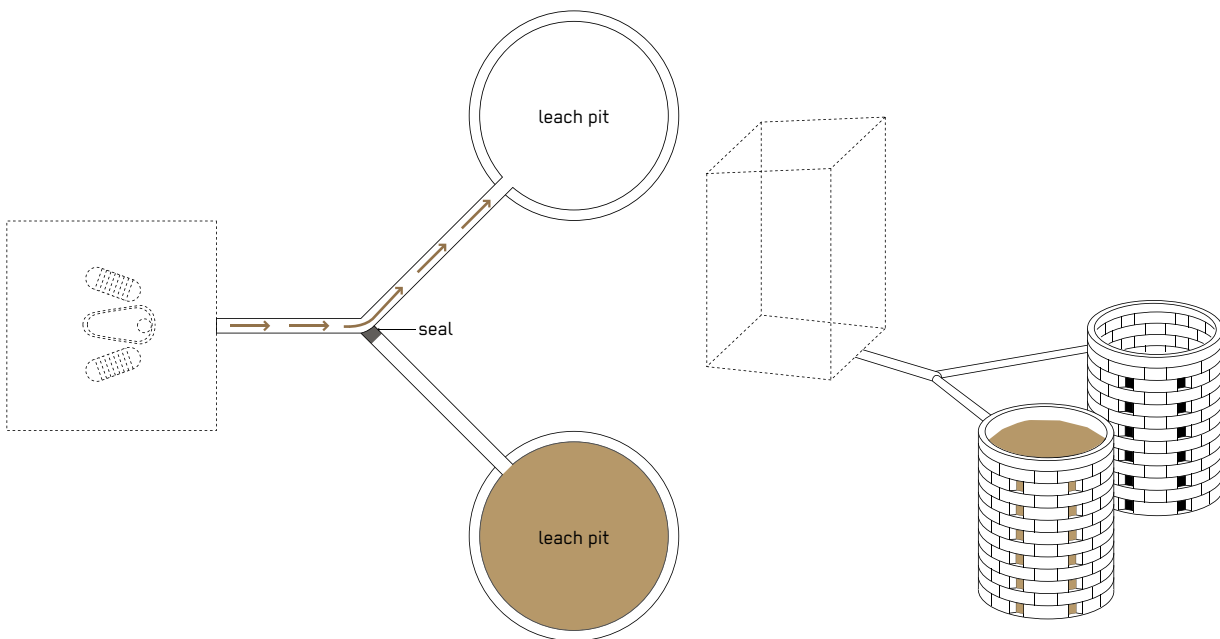

This technology consists of two alternating pits connected to a Flush Toilet (U.4). The blackwater (and in some cases greywater) is collected in one pit and allowed to slowly infiltrate into the surrounding soil. When full, one pit is closed and with time the solids are sufficiently dewatered and enabling manual removal, while the other pit is used.

While one pit fills, the other full pit settles and dewateres. This technology allows water to be used for toilet flushing and soil or organic material is not added to the pits. As the pit sludge can be quite liquid, the full pits require a longer retention time (two years or more is recommended) to degrade the material before it can be safely emptied. This technology can be a more cost-effective alternative to the Septic Tank (S.13) as an on-site water-based technology, where a water flush system is required.

**Design Considerations:** The pits are usually shallower than Single Pit Latrines (S.3) with a depth of around 1–2 m. They should be of an adequate size to accommodate an excreta volume generated over two years. The resting period of the full pit allows the contents to transform into a partially sanitised, soil-like material. It is recommended that the twin pits are constructed at least 1 m apart to minimise cross-contamination between the maturing pit and the one in use. Pits should be constructed over 1 m from any structural foundation as leachate can negatively impact structural supports. The full depth of the pit walls should be lined to prevent collapse and the top 30 cm should be fully mortared to prevent direct infiltration. To ensure that only one of the two pits is used at any time, the idle pipe of the junction connecting to the out-of-use pit should be closed (e.g. with cement or bricks). Alternatively, the Flush Toilet (U.4) could also be directly connected to the pit in use by a single straight pipe fixed in place with light mortar and covered with earth.

The risk of failure and misuse is minimised by ensuring that the junction and pipes are not easily accessible.

**Materials:** If possible, materials should be used that are locally available. The latrine superstructure can be made from local materials, such as bamboo, grass matting, cloth or wood, plastic or metal sheeting (though this often heats up the interior). The pit lining can be made of concrete or bricks among other materials. Moreover, piping is needed as is a technique of sealing the out-of-use pit, as described above. As this is a flush based technology, a reliable water supply for flushing is required.

**Applicability:** Twin Pits for Pour Flush are appropriate for areas where it is not possible to continuously build new pit latrines or regular desludging might be an issue and where there is water available and desired for flushing. It is recommended not to concentrate pits in a small area as the soil may not have sufficient capacity to absorb the liquid and the ground could become water-logged (oversaturated). Clay, tightly packed or rocky soils are not appropriate for the use of pour flush pits. This technology is not suitable for areas with a high groundwater table or where frequent flooding occurs. Greywater can be co-managed along with the blackwater in the twin pits, especially if the greywater quantities are relatively small, however this should then be accounted for in dimensioning the pits. The dewatered, solid material is manually emptied from the pits (C.1). This technology is only recommended as a longer-term solution in a stable environment.

**Operation and Maintenance:** General operation and maintenance (O&M) measures include regular cleaning, routine operational tasks such as checking availability of water, hygiene items, soap and dry cleansing materials, providing advice on proper use, conducting minor repairs and monitoring of pit filling level. As pits are often misused for solid waste disposal, which can complicate pit emptying, awareness raising measures (X.12) should be considered. The pits require regular emptying (after the recommended two years' resting time), and care must be taken to ensure that they do not flood during rainy seasons. Emptying is done manually, e.g. using long handled shovels and proper personal protective equipment or emptying can be done with mobile desludging machines (C.1, C.2).

**Health and Safety:** Twin Pits for Pour Flush need to be equipped with Handwashing Facilities (U.7) and proper handwashing with soap after toilet use needs to be

addressed as part of hygiene promotion activities (X.12). As with all pit-based systems, groundwater contamination can be an issue and soil properties such as the permeability of the soil and groundwater level should be properly assessed (X.3) to limit exposure of water sources to microbial contamination. The Sphere minimum standards on excreta management should be consulted for further guidance. The slab covering the pit should be of a solid and sturdy material, for example from concrete, to prevent people from falling in and prevent animals from entering.

**Costs:** As the complete depth of the pit should be lined with bricks and the top 30 cm with mortar, the costs for this technology are higher than for Twin Pit Dry Systems, but lower than for other water-based on-site technologies, such as a Septic Tank (S.13) or an Anaerobic Baffled Reactor (S.14).

**Social Considerations:** This is a commonly accepted sanitation option that works best in rural and peri-urban areas, and where people are used to flush toilets. It should reflect local user preferences (sitter vs. squatter, anal cleansing practices, direction, positioning etc.) and should account for the accessibility and safety of all users, including men, women, children, elderly and disabled people (X.10). The potential handing over to beneficiaries and the roles and responsibilities for O&M need to be agreed upon early on and closely linked to respective hygiene promotion activities (X.12) to ensure appropriate use and O&M of the facilities.

#### Strengths and Weaknesses:

- ⊕ Because double pits are used alternately, they can have a long life
- ⊕ Potential for use of stored faecal material as soil conditioner
- ⊕ Flies and odours are significantly reduced (compared to pits without a water seal)
- ⊕ Can be built and repaired with locally available materials
- ⊖ Manual removal of humus is required
- ⊖ Clogging is frequent when bulky cleansing materials are used
- ⊖ Higher risk of groundwater contamination due to more leachate than with waterless systems

→ **References and further reading material for this technology can be found on page 191**

# Raised Latrine

| Phase of Emergency   | Application Level / Scale  | Management Level   | Objectives / Key Features  |
|--|--|--|--|
| <ul style="list-style-type: none"> <li>★★ Acute Response</li> <li>★ Stabilisation</li> <li>★ Recovery</li> </ul> | <ul style="list-style-type: none"> <li>★★ Household</li> <li>★★ Neighbourhood</li> <li>★ City</li> </ul> | <ul style="list-style-type: none"> <li>★★ Household</li> <li>★★ Shared</li> <li>★★ Public</li> </ul>   | Excreta containment, Alternative for challenging ground conditions |
| Space Required   | Technical Complexity   | Inputs   | Outputs  |
| <ul style="list-style-type: none"> <li>★ Little</li> </ul>   | <ul style="list-style-type: none"> <li>★ Low</li> </ul>  | <ul style="list-style-type: none"> <li>● Excreta, ● Faeces,</li> <li>(● Anal Cleansing Water),</li> <li>(● Dry Cleansing Materials)</li> </ul> | <ul style="list-style-type: none"> <li>● Sludge</li> </ul>         |

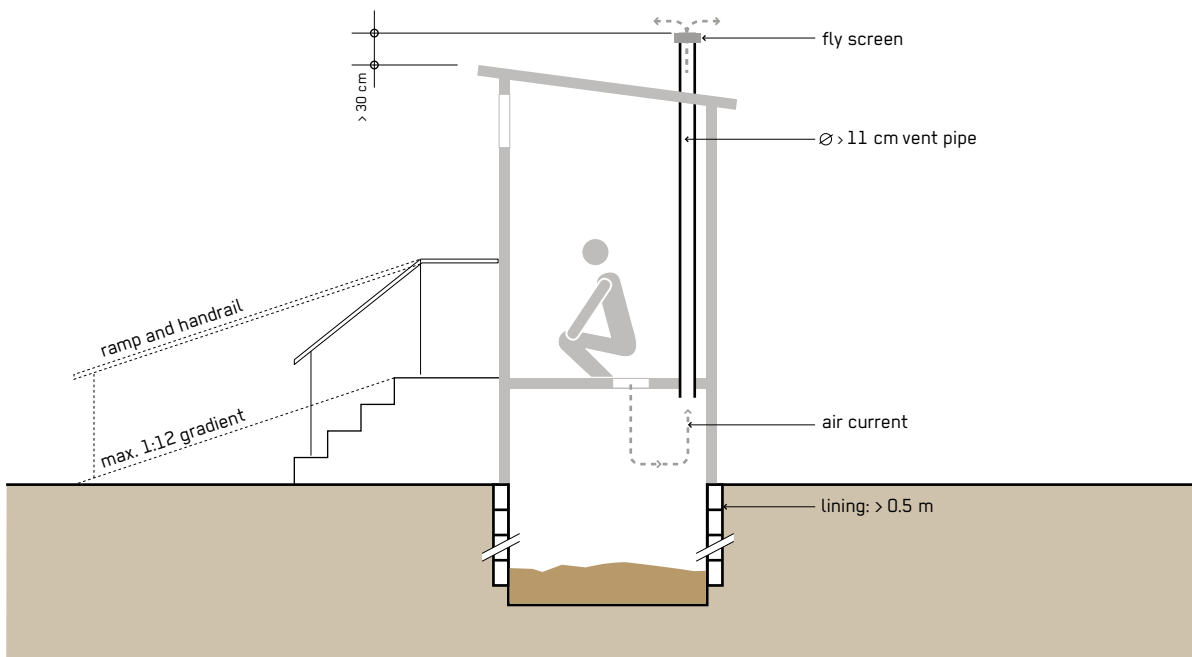

Raised Latrines are alternatives to pit-based latrines in areas with rocky ground, high water tables or flood affected areas. Depending on site conditions they can either be built as autonomous facilities entirely above ground with a holding tank below the user interface or by raised partially above ground, reducing the risk of groundwater contamination.

If Raised Latrines are built entirely above ground, the excreta must be collected in a sealed vault below the user interface. As no percolation occurs from the sealed vault, raised latrines that are entirely above ground have a high sludge accumulation rate. Storage facilities need regular emptying and a sludge management system is necessary. Raised Latrines with the pit partially below ground allow some of the effluent to percolate into the soil through the bottom and walls of the pit, while microbial action partially degrades the organic material. Raised Latrines can either be built as a single pit solution (with ventilation)

or as a toilet block with several cubicles in a row and a trench or larger storage tank underneath. In toilet blocks ventilation is a challenge and thus odours and flies can become an issue.

**Design Considerations:** Raised Latrines with pits partially below ground need pit lining (> 0.5 m) to ensure that the pit remains stable. To reduce odours and flies the latrine should be equipped with a ventilation pipe (see S.4). Raised Latrines must be equipped with stairs or a ramp and corresponding handrails and, if necessary, structural support at the back. Drainage should be considered around the latrine so that rainwater does not enter the pit. In communal latrines, there should be separate latrines for men and women. The Raised Latrine platform usually does not exceed a maximum height of 1.5 m due to costs and user acceptance. The design must include arrangements for emptying.



**Materials:** If possible, materials should be used that are readily available and that can be sourced rapidly. The superstructure can be made from materials including bamboo, grass matting, wood, plastic or metal sheeting (though this often heats up the interior). The lining can be of concrete rings, bricks, stones, timber or sand bags. Several companies have developed variations of prefabricated Raised Latrines that can be delivered and assembled quickly.

**Applicability:** Raised Latrines are particularly suitable for flood prone areas, areas where pit digging is difficult or the water table is high and where construction of permanent structures is not allowed. They can be considered a viable solution in all stages of an emergency provided the technology is acceptable to the users. As no water is needed for operation it is also a solution for water scarce areas. They can be replicated quickly and implemented at scale if enough space is available. In areas with frequent flooding it can also be considered a permanent solution to increase longer-term resilience.

**Operation and Maintenance:** Operation and maintenance (O&M) requirements depend on which latrine design is used. Raised Latrines with a sealed containment facility fill up quickly and need regular emptying or replacement of storage facility and subsequent management of collected sludge. O&M tasks also include regular cleaning, conducting routine operational tasks (e.g. checking of availability of water, hygiene items, soap), providing advice on proper use, conducting minor repairs and monitoring the fill level. As latrines are often misused for solid waste disposal, which can affect later emptying, special awareness-raising measures should be considered. Public Raised Latrines tend to have a high sludge accumulation rate and will require frequent emptying. If regular desludging is needed, availability of and accessibility for desludging vehicles must be considered (C1, C2).

**Health and Safety:** If used and managed well, Raised Latrines can be considered a safe excreta containment technology. They need to be equipped with Handwashing Facilities (U.7) and proper handwashing with soap after toilet use needs to be addressed as part of hygiene promotion activities (X.12). For Raised Latrines partly below ground, groundwater contamination can be an issue and soil properties and the groundwater level should be assessed (X.3) to identify the minimum distance to the next water source and limit exposure to microbial

contamination. The Sphere minimum standards on excreta management should be consulted for further guidance. Emptying pits or replacing storage containers should be done in such a way that the risk of disease transmission is minimised (personal protective equipment and hygiene promotion for emptying personnel). Public latrines need additional illumination at night, security guards for protection and require accessibility for all users.

**Costs:** Building Raised Latrines is relatively inexpensive. Costs vary depending on availability and costs of local materials. Prefabricated versions may be more expensive (particularly costs for stockpiling and transporting) but can usually be implemented faster and with less dependency on local materials. Cost calculations need to reflect ongoing O&M requirements and follow-up costs such as regular desludging, transport, treatment and final disposal/reuse of accumulating sludge. The cost of steps and access ramps for users can also push the cost up.

**Social Considerations:** Due to the raised design, Raised Latrines increase the risk of users being seen when going to the toilet. The location of the Raised Latrine may therefore be particularly important. Other design elements also need to reflect local user preferences (e.g. sitter vs. squatter, cleansing practices, direction, height, positioning etc.). Latrines need to be accessible to all, therefore ramps with a handrail and a turning space for wheelchairs at the latrine level may need to be considered (X.10). O&M roles and responsibilities need to be agreed upon early on and closely linked to hygiene promotion activities (X.12) to ensure appropriate use and O&M of facilities.

#### Strengths and Weaknesses:

- ⊕ Applicable in areas with challenging ground conditions and frequent flooding
- ⊕ Low (but variable) capital costs
- ⊕ Small land area required
- ⊖ Inclusive design is more difficult than for technologies that are not raised
- ⊖ Emptying costs may be significant compared to capital costs
- ⊖ Collected sludge requires further treatment
- ⊖ For above ground facilities emptying service needs to be in place from the design stage

→ **References and further reading material for this technology can be found on page 191**

# Single Vault UDDT (Urine Diversion Dehydration Toilet)

| Phase of Emergency                                | Application Level / Scale               | Management Level   | Objectives / Key Features   |
|---|---|--|---|
| Acute Response<br>** Stabilisation<br>** Recovery | * Household<br>** Neighbourhood<br>City | * Household<br>** Shared<br>** Public  | Excreta containment, Alternative for challenging ground conditions, Nutrient recovery |
| Space Required                                    | Technical Complexity                    | Inputs   | Outputs   |
| * Little  | * Low                                   | ● Faeces, ● Urine,<br>(● Dry Cleansing Materials),<br>(● Anal Cleansing Water) | ● Faeces, ● (Stored) Urine  |

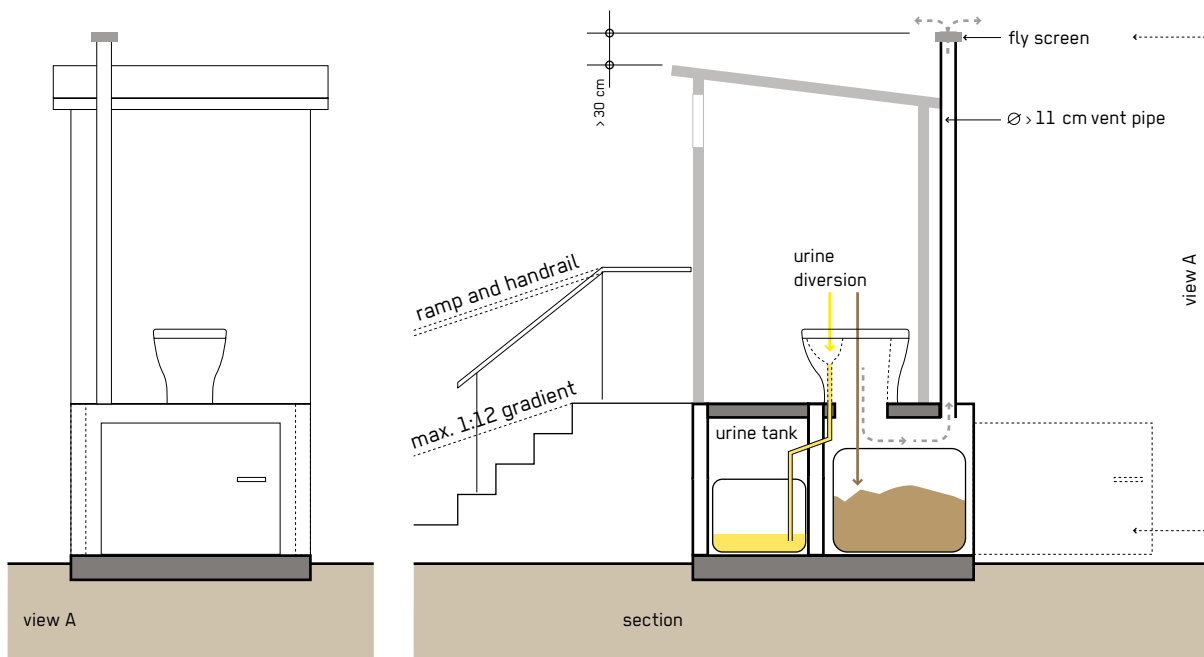

The Single Vault UDDT is a Container-Based Toilet (S.10) that operates without water. Urine and faeces are collected separately. Unlike the Double Vault UDDT (S.9) it does not offer the possibility of prolonged storage and treatment and needs an appropriate management system for regular emptying, transport, treatment, reuse and/or safe disposal of collected excreta products.

In a Urine Diverting Dry Toilet (U.2), urine does not enter the same container as the faeces and is instead diverted into a separate container. If the urine is not to be reused and if soil conditions allow it can alternatively be directly infiltrated into the soil (D.10) as its pathogen load is considered negligible. Infiltrating urine significantly reduces the overall excreta volume (80–90%) without an increased public health risk. Faeces are collected in a separate collection device and cover materials (e.g. ash, lime or sawdust) are added after each use. The collected urine and faeces must be emptied on a regular basis.

**Design Considerations:** The size of the faeces collection container should be chosen according to the expected number of users but should not exceed 50–60 L of volume for easy removal. Containers should be sealable and equipped with handles, allowing easy manipulation, intermediate storage for changes in usage, improved perception and reduced risk in storage and transport. A vent pipe is suggested to remove humidity from the vaults and control flies and odours. Water from the handwashing facility and anal cleansing water (if used) must be drained separately. All connection pipes should be as short as possible with no sharp bends and installed with at least a 1% slope. An odour seal should be installed at the urine drain.

**Materials:** Single Vault UDDTs can be constructed with local materials, e.g. bamboo, wood, corrugated iron, tarpaulin, plastic buckets and jerricans. Depending on local availability potential cover/drying material that can be

used include ash, lime, sawdust, dried soil or dried agricultural waste products. Urine diversion toilet seats or squatting pans can be obtained or produced locally.

**Applicability:** Single Vault UDDTs are suitable for flood-prone, high water table and rocky areas and can be an appropriate solution for the stabilisation and recovery phase provided the technology is acceptable to the users. They should only be implemented if subsequent management can be guaranteed by a local organisation or service provider. They can be replicated quickly given enough space is available. As no water is needed for operation it is a viable solution for water scarce areas. The design can be adjusted to specific user needs and cultural settings (e.g. smaller for children, sitting/squatting). Depending on local acceptability collected products can be used as fertiliser and soil conditioner in agriculture (after treatment). Even without reuse the UDDT offers a safe, hygienic and odour free excreta containment solution. Single Vault UDDTs can be temporary solutions, making them more attractive in situations with landownership issues that do not permit permanent structures. They are adaptable to anticipated disruptions and hazardous events: toilets can be serviced more frequently prior to anticipated events, or additional collection devices can be provided for times when servicing might be difficult.

**Operation and Maintenance:** Key operation and maintenance (O & M) tasks include regular emptying and replacing of collection containers, cleaning, checking availability of hygiene items, soap, cover material, dry cleansing materials and water for handwashing and anal cleansing, conducting minor repairs and advising on proper use. Care should be taken to ensure that no water or urine gets into the faeces container. If this happens, extra cover material can be added to help absorb the liquid. Service personnel should wear proper personal protective equipment including a mask, gloves, boots, an apron or protective suit. Division of O & M responsibilities between users and potential service providers need to be clearly defined.

**Health and Safety:** If used and managed well, Single Vault UDDTs can be a safe excreta containment technology. They need to be equipped with Handwashing Facilities (U.7) and proper handwashing with soap after toilet use needs to be addressed as part of hygiene promotion activities (X.12). Pathogen concentration in faeces is high and there is no significant pathogen reduction during the

short storage time. Thus, it is critical that the faeces-containing vault is handled in such a way that the risk of disease transmission is minimised (i.e. ensure containers are closed and use of personal protective equipment). As faeces are not treated in the vault, there is a need for subsequent treatment. If reuse is not intended the collected faeces can be buried or transported to a final treatment site.

**Costs:** Investments costs for Single Vault UDDTs are low and they can be built with locally available materials and labour. However, operational costs for regular emptying, transport and further processing of excreta products can be considerable and need to be taken into consideration when calculating longer-term costs.

**Social Considerations:** The technology should be discussed with the community beforehand as the use of a urine diversion facility may have considerable acceptability and behavior change implications. Training might be needed to support acceptance, ensure proper use and maintenance and to avoid misuse. It should reflect local user preferences (sitter vs. squatter, anal cleansing practices, direction, positioning etc.) and should account for the accessibility and safety of all users, including men, women, children, elderly and disabled people (X.10). If reuse is not intended and soil conditions allow, urine can be infiltrated directly into the ground, avoiding regular urine management and may increase user acceptance.

**Strengths and Weaknesses:**

- ⊕ Suitable in areas with challenging ground conditions and that are prone to flooding
- ⊕ Waterless operation
- ⊕ No flies and odour when correctly used and maintained
- ⊕ Adaptability to natural and societally-created disruptions/events
- ⊖ Needs an overall management system (high maintenance)
- ⊖ Requires well-trained user and service personnel
- ⊖ Requires constant source of cover material
- ⊖ Manual removal of faeces (and urine) containers required

→ **References and further reading material for this technology can be found on page 191**

# Double Vault UDDT (Urine Diversion Dehydration Toilet)

| Phase of Emergency                                | Application Level / Scale                | Management Level   | Objectives / Key Features  |
|---|--|--|--|
| Acute Response<br>** Stabilisation<br>** Recovery | ** Household<br>** Neighbourhood<br>City | ** Household<br>** Shared<br>* Public  | Excreta containment, Alternative for challenging ground conditions, Pathogen removal and nutrient recovery |
| Space Required                                    | Technical Complexity                     | Inputs   | Outputs  |
| * Little  | ** Medium                                | ● Faeces, ● Urine,<br>(● Dry Cleansing Materials),<br>(● Anal Cleansing Water) | ● Dried Faeces, ● Stored Urine   |

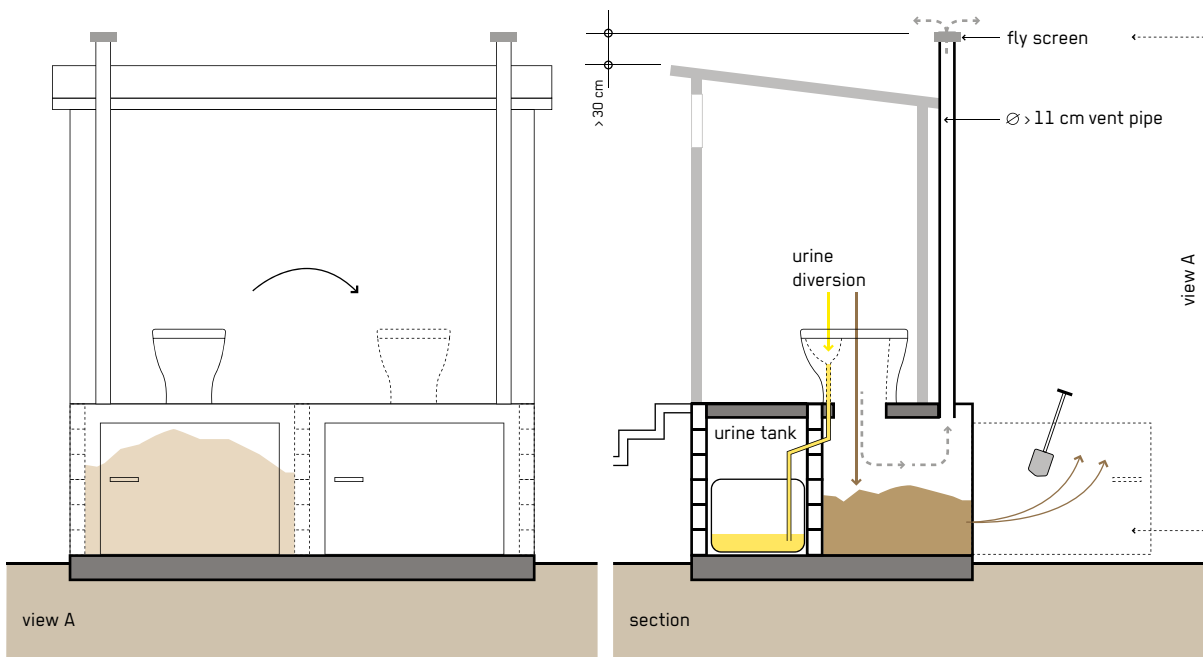

Double Vault UDDTs operate without water. Urine and faeces are diverted using a Urine Diverting Dry Toilet (U.2) and are collected separately. While urine goes into a container (or is drained away), faeces are collected in vaults underneath, where they are stored and dried. Alternating vaults allow for prolonged storage and thereby treatment of collected faeces in the unused vault.

When faeces are not mixed with urine and other liquids, they dry quickly. In absence of moisture, pathogens are destroyed and smell minimised. Use of alternating vaults allow faeces to dehydrate in one vault while the other fills. When one vault is full, the urine-diverting device is moved to the second vault. While the second vault fills up, faeces in the first vault dry and decrease in volume. When the second vault is full, the first one is emptied and put back into service. To encourage drying, a small amount of ash, lime, dry soil or sawdust is used to cover faeces after each use.

**Design Considerations:** The vault size must be chosen according to anticipated number of users (around 100 L/person/year) and to allow for a storage time between 6–24 months. WHO recommends a minimum storage period of 6 months if ash or lime are used as cover material (alkaline treatment), otherwise storage should be for at least 1 year for warm climates and 1.5 to 2 years for colder climates. Vault dimensions should account for cover material, airflow and non-even distribution of faeces. Urine piping should not go directly through vaults to avoid potential leaking. A vent pipe is required to remove humidity from vaults and control flies and odours. Vaults should be made of sealed brickwork or concrete to ensure surface runoff cannot enter. Water from the handwashing facility and anal cleansing water (if applicable) must be drained separately (D.10). If dry anal cleansing material is used a separate trash bin should be provided. Connection pipes should be as short as possible without sharp bends and installed with > 1% slope. An odour seal should be installed at the urine drain.

**Materials:** Double Vault UDDTs can be constructed with materials such as bamboo, wood, concrete, corrugated iron and bricks. Potential cover/drying material that can be used include ash, lime, sawdust, dried soil or dried agricultural waste products. Urine diversion toilet seats or squatting pans can be obtained or produced locally.

**Applicability:** Double Vault UDDTs can be considered an appropriate solution in the stabilisation and recovery phases, provided the technology is acceptable to the users and space is available. If used in urban contexts, they rely on a transport service since urban users usually do not have an interest and/or opportunity to use (or dispose of) urine and dried faeces locally. They are appropriate for water-scarce, rocky, high groundwater or frequently flooded areas. In flood-prone areas special care should be taken to ensure that vaults are watertight. UDDTs might not be appropriate in the acute response due to time needed to educate and train users and to construct. The design can be adjusted to the needs of specific target groups and cultural settings, e.g. smaller for children, sitting/squatting. Depending on context and acceptability collected resources can be used as fertiliser and soil conditioner in agriculture.

**Operation and Maintenance:** Key operation and maintenance tasks include regular emptying and replacing of urine collection containers (if urine is not drained away), cleaning, checking availability of hygiene items, water and dry cleansing materials, conducting minor repairs and advising on proper use. Ample supply of cover material must be secured. Accumulated faeces beneath the toilet should occasionally be pushed to the sides of the chamber. Water or urine should not get into the dehydration vault. If it happens, extra drying material can be added to help absorb the liquid. For vault emptying, personal protective equipment should be used to avoid contact with dried faeces.

**Health and Safety:** If used and managed well, Double Vault UDDTs are a safe excreta containment and treatment technology. They need to be equipped with Handwashing Facilities (U.7) and proper handwashing with soap after toilet use needs to be addressed as part of hygiene promotion activities (X.12). Users need to be trained to understand how the technology works and appreciate its benefits. Although human urine can generally be considered pathogen-free, there is a remaining risk of urine cross-contamination (faecal material entering urine compartment). It is therefore recommended to store urine for 1–6 months (depending on system size) prior to

any potential use as liquid fertiliser in agriculture (D.1) to allow for respective treatment. When vaults are kept dry, problems with flies or odours are low. As a result of faeces drying there is a significant pathogen reduction. After recommended storage time (6–24 months), faeces should be safe to handle. However, some pathogens (e.g. *Ascaris*) might remain viable even after longer storage intervals. If reuse is foreseen, e.g. as soil conditioner for use with ornamental plants, trees, or low-risk crops (D.2), it is recommended that dried faeces should undergo secondary treatment (e.g. T.11 or T.12). If reuse is not intended dried faeces can be safely buried or brought to a final disposal site.

**Costs:** The capital costs for constructing a Double Vault UDDT may vary depending on availability and costs of local materials and prefabricated slabs/toilet seats but are generally low to moderate. The operating costs are very low if self-managed.

**Social Considerations:** The technology should be discussed with the community beforehand as the use of a urine diversion facility might have considerable acceptability and behavior change implications. Training might be needed to support acceptance, ensure proper use and maintenance and to avoid accidental misuse. It should reflect local user preferences (sitter vs. squatter, anal cleansing practices, direction, positioning etc.) and should account for the accessibility and safety of all users, including men, women, children, elderly and disabled people (X.10). If reuse is not intended and soil conditions allow, urine can be drained away in a Soak Pit (D.10). This avoids regular urine management and might increase acceptance.

#### Strengths and Weaknesses:

- ⊕ Long lifespan and low/no operating costs if self-emptied
- ⊕ Requires water only for handwashing and possibly anal cleansing
- ⊕ Significant pathogen reduction
- ⊕ Potential use of urine and faeces as fertiliser and soil conditioner
- ⊖ Requires training and acceptance
- ⊖ Requires constant source of cover material
- ⊖ Manual removal of dried faeces required
- ⊖ Capacity limited by vault size

→ **References and further reading material for this technology can be found on page 191**

# Container-Based Toilet

| Phase of Emergency                                 | Application Level / Scale               | Management Level   | Objectives / Key Features                                     |
|--|---|--|---|
| ** Acute Response<br>* Stabilisation<br>* Recovery | ** Household<br>* Neighbourhood<br>City | * Household<br>** Shared<br>** Public                                    | Excreta containment, Increased privacy, Increased flexibility |
| Space Required                                     | Technical Complexity                    | Inputs / Outputs   |   |
| * Little   | * Low                                   | ● Faeces, ● Urine, (● Dry Cleansing Materials), (● Anal Cleansing Water) |   |

simple bucket type

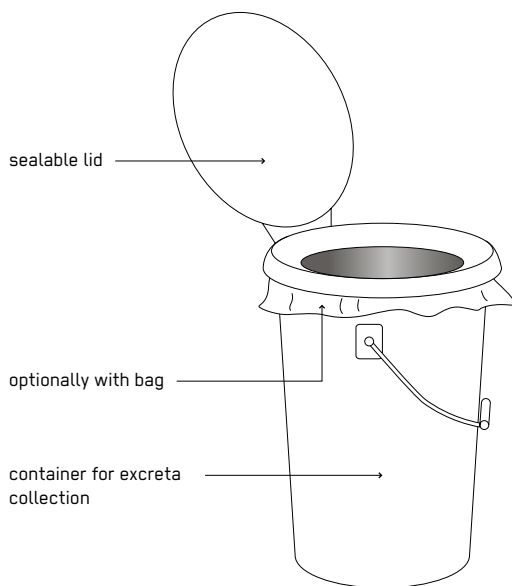

urine diverting type

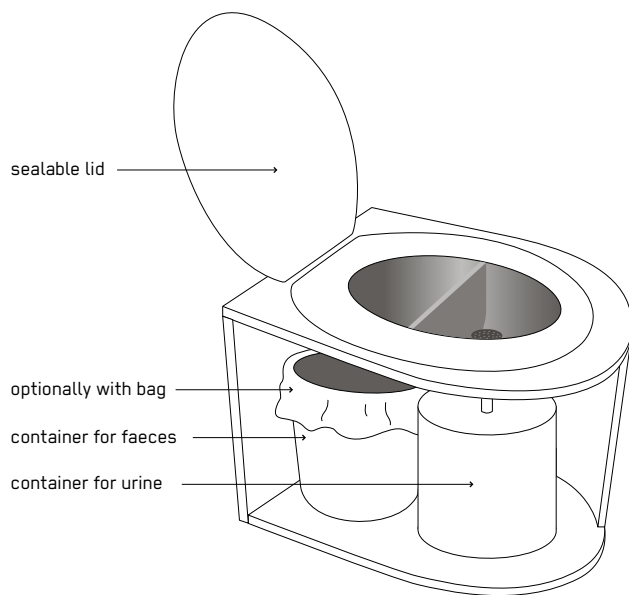

A Container-Based Toilet is an on-site sanitation solution, available in a variety of forms that work on the principle of containing the excreta. Faeces and urine are collected in sealable, removable containers (also sometimes called cartridges), where they are sealed and stored until they are transported to a Transfer Station (C.6) or treatment facility. The portable Container-Based Toilet allows for private in-home use and easy and convenient collection and transport. Very large containers also can be installed below multiple latrines to simplify emptying (S.7).

The Container-Based Toilet can effectively serve a community with a safe and personal sanitation facility. Unlike Chemical Toilets (S.11) that are shared facilities, Container-Based Toilets are no larger than a bucket and fit within the home or tent. They come in a variety of forms from simple buckets with lids (not advisable), to buckets lined with a urea impregnated bag, e.g. the specialised biodegradable 'peepoo bags', to more sophisticated designs

that divert urine. Distribution of the Container-Based Toilets can be done quickly and by hand.

**Design Considerations:** The size of the Container-Based Toilet vault must be chosen according to the anticipated number of users and the collection capacity and interval. The size of the collection container should not exceed 50–60 L to ensure easy and manual removal and transport. Containers should be fully sealable and equipped with handles to ensure safe handling, intermediate storage (if required), storage and transport. A simple cubical can be constructed within the home to increase privacy. Where squatting is preferred, a wooden box can be built to create a platform for the user over the container.

**Materials:** Container-Based Toilets are either prefabricated containers or can be a mixture of both prefabricated containers and a locally-made box for holding the container. The holding box and the cubicles can be made from

wood, woven mats, ferro-cement or metal sheets. Toilet seats or squatting pans can be obtained or produced locally or prefabricated alternatives may be used. Some models of Container-Based Toilets require a bag-type lining, a supplier of these will need to be secured. Biodegradable bags should be favoured as they make further treatment processes like composting easier to complete.

**Applicability:** Container-Based Toilets can be an appropriate solution in all phases of an emergency, provided a company or other organisation is ensuring regular collection, transport and emptying. Without a management service for emptying the containers, this is not a feasible option. A key benefit of this technology is that it increases security for users by eliminating the need to leave the residence to use the toilet (for example at night) and can promote proper management of children's excreta. Container-Based Toilets can be implemented relatively quickly and distributed by hand, if stocks are readily available. They do not need a permanent structure and the toilets can be moved if needed, making the technology more attractive in situations where people may have to move. Container-Based Toilets are particularly suitable for densely populated urban environments. In situations where a bag-based sanitation system (e.g. PeePoo bags) is in place, the transition to a more improved Container-Based Toilet design at a later phase can be easily achieved. Where a longer-term solution is sought, the urine diversion Container-Based Toilet should be considered to reduce treatment costs.

**Operation and Maintenance:** The division of operation and maintenance (O&M) tasks and responsibilities between users and potential service providers need to be clearly defined and considered in the planning process. Key O&M tasks include the regular emptying, cleaning and replacing of the collection containers (depending on the size of the container and the number of users), by either the user or a collector/service provider. The containers are then transported by Manual or Motorised Transport (**C.1**, **C.2**) to the treatment or resource recovery centres where the contents can be safely managed. Containers require careful cleaning by trained staff in a designated cleaning area that can safely manage the hazardous cleaning water. Each Container-Based Toilet needs to be supplied with the appropriate anal cleansing material.

**Health and Safety:** Handwashing Facilities (**U.7**) should be provided and handwashing with soap after using the toilet use must be addressed as part of hygiene promotion activities (**X.12**). Service providers responsible for collecting and emptying containers are particularly at risk of contracting excreta related diseases. Close management of emptying procedures together with good personal protective equipment and bathing facilities for workers are essential for worker protection.

**Costs:** Container-Based Toilets are moderately expensive to implement. However, they can be implemented rapidly and once managed well can be used sustainably in the long-term. Any cost calculations, however, also need to reflect additional O&M requirements like frequent collection, transport, cleaning, storage, treatment and final disposal or reuse of the sludge.

**Social Considerations:** The potential introduction of Container-Based Toilets should be discussed with the target communities beforehand as the system may have behavior change implications and to match the user interface preference (sitter vs. squatter, anal cleansing practices, color etc.). Thorough training or orientation might be needed to support acceptance, ensure proper use and maintenance of the facilities and to avoid accidental misuse. This is especially important where urine diversion models are being introduced.

**Strengths and Weaknesses:**

- ⊕ No need for permanent structures, thereby accommodating the needs of mobile, or transient residents
- ⊕ Reduces risk of gender-based violence
- ⊕ Can be used within the household, thereby ensuring easy access both day and night and can also improve management of children's faeces
- ⊕ Suitable where constraints such as risk of flooding, high water table, rocky ground or collapsing soil exist
- ⊖ Medium to high initial cost
- ⊖ Depends on the quality of a regular collection service
- ⊖ Need for secure disposal or treatment site
- ⊖ Requires well-trained user and service personnel for use, maintenance, servicing and monitoring

→ **References and further reading material for this technology can be found on page 191**

# Chemical Toilet

| Phase of Emergency                             | Application Level/ Scale              | Management Level   | Objectives / Key Features                |
|--|---------------------------------------|--|--|
| ★★ Acute Response<br>Stabilisation<br>Recovery | Household<br>★★ Neighbourhood<br>City | Household<br>Shared<br>★★ Public   | Excreta containment, Fast implementation |
| Space Required                                 | Technical Complexity                  | Inputs   | Outputs                                  |
| * Little                                       | ★★ Medium                             | ● Faeces, ● Excreta,<br>● Blackwater, ● Chemicals,<br>(+ ● Anal Cleansing Water),<br>(+ ● Dry Cleansing Materials) | ● Sludge                                 |

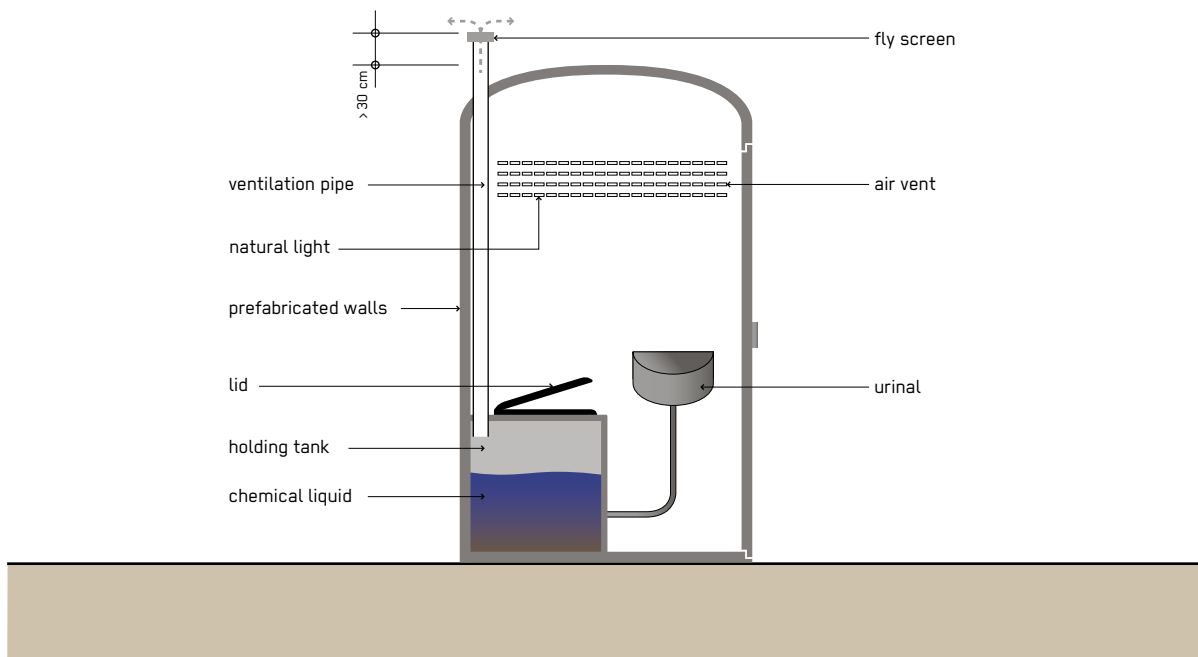

The Chemical Toilet, commonly referred to as a 'porta-loo', can be used as an immediate solution in the acute response phase of an emergency. Chemical toilets are generally contained in a single prefabricated plastic portable unit, or cubicle, that collects human excreta in a sealed holding tank which contains chemicals that disinfects excreta and/or decreases odours.

The Chemical Toilet is designed as a complete prefabricated cubicle unit above a holding tank, commonly with 200 L capacity, where a chemical solution is added. A small amount of water and chemicals are mixed to make the flush water. The holding tank collects the excreta, flush water and anal cleansing material. The chemical additives in both the flush water and holding tank reduce odours and partially disinfect excreta.

**Design Considerations:** One toilet can serve up to 75–100 persons per desludging interval. Standard cubical size is usually about 110 cm square by 210 cm, large enough for one person, and have washable floors, ventilation screens and ventilation pipes. Modifications to the standard design are available on the market with a variety of different user interfaces such as urinals, squatting pans, pedestal toilets and with wheelchair access and hand-washing stations in the cubical. Larger holding tanks (< 200 L) and winterised models with anti-freeze are also available. Toilets must be located in areas that can be accessed by desludging vehicles and motorised emptying vehicles (C.2). The final disposal of sludge is a critical issue and a safe option should be identified before considering Chemical Toilets.

**Materials:** The Chemical Toilet comes as complete prefabricated plastic unit either available in-country from existing suppliers or can be flown in. The chemical solution



commonly used is glutaraldehyde, formaldehyde or caustic soda (sodium hydroxide). More environmentally friendly enzyme mixes have also been developed. Dry anal cleansing materials and cleaning equipment are required as well as desludging trucks for emptying.

**Applicability:** Chemical Toilets are appropriate for the acute response phase of an emergency and are particularly suitable for flood prone affected areas, where pit digging is difficult, within urban areas and where low water and non-permanent solutions are required. As excreta is well contained and well isolated with minimal risk of contamination, it is a good solution where there is a risk of cholera. They are shared facilities and never used as household toilets.

**Operation and Maintenance:** Chemical Toilets come with a basic pump flush that operates using the hand or foot or as dry systems without flush. If 75–100 people are using one toilet per day then they should be emptied daily using a Motorised Emptying and Transport (C.2). The toilets require regular cleaning and checking of water for handwashing and anal cleansing, hygiene items, soap and dry cleansing materials. Where there is a high number of users it is advised to have an attendant to guarantee maintenance and cleaning. It is recommended to have one attendant for every 10 cubicles. Community members can be paid for this job to share the benefits. Some chemicals in the sludge can harm the biological activity in certain treatment facilities such as Anaerobic Baffled Reactors (S.14) or Biogas Reactors (S.16).

**Health and Safety:** If removal of sludge is delayed or not carried out, the Chemical Toilet can very quickly become a serious health risk. Handwashing Facilities (U.7) should be available and always stocked with soap and water or hand sanitiser. Cubicles need to be situated on flat ground and also anchored to avoid unwanted displacements. Smoking should be prohibited within the cubicles as they are flammable.

**Costs:** The medium capital costs and high operating costs make Chemical Toilets unsustainable for use beyond the acute response phase. Overall costs will depend on the number of toilets, whether they are being purchased or rented and the duration of the contract.

**Social Considerations:** The community should be involved from the outset of the implementation process and beneficiaries should be informed of how long the toilets will be available for, and the staging/phasing of excreta disposal provision in the community. In general, the toilets offer a comfortable and safe sanitation facility and are often well accepted. Proper siting of the toilets is important, otherwise strong odours during emptying might negatively affect acceptance of the toilets. Also consider the prevailing wind direction. Other problems can relate to the concept of communal toilet use. Families may not want to share with other cultural groups and may want their own personal toilet. Additionally, it is important to match the user interface that the target group is used to using, e.g. squatting vs. pedestals. Where Muslims are part of the target community, care should be taken regarding the direction the toilets are facing.

**Strengths and Weaknesses:**

- ⊕ Can be mobilised rapidly
- ⊕ Good in terms of acceptance, dignity and containment of excreta
- ⊕ Can be moved easily if needed
- ⊕ Can be used in areas where digging is impossible, or in urban areas
- ⊖ Expensive (particularly O & M)
- ⊖ Requires daily servicing
- ⊖ Impossible if there is no secured place to dump the sludge nearby
- ⊖ Relatively uncommon outside Europe, North America and some parts of Latin America

→ **References and further reading material for this technology can be found on page 191**

# Worm-Based Toilet (Emerging Technology)

| Phase of Emergency                               | Application Level / Scale               | Management Level  | Objectives / Key Features  |
|--|---|---|--|
| Acute Response<br>★ Stabilisation<br>★★ Recovery | ★★ Household<br>★ Neighbourhood<br>City | ★★ Household<br>★★ Shared<br>Public   | Excreta containment, Sludge volume reduction, Pathogen reduction |
| Space Required                                   | Technical Complexity                    | Inputs  | Outputs  |
| ★ Little   | ★★ Medium                               | ● Urine, ● Faeces,<br>(● Dry Cleansing Materials),<br>(● Anal Cleansing Water),<br>● Flushwater | ● Vermi-Compost, ● Effluent                                      |

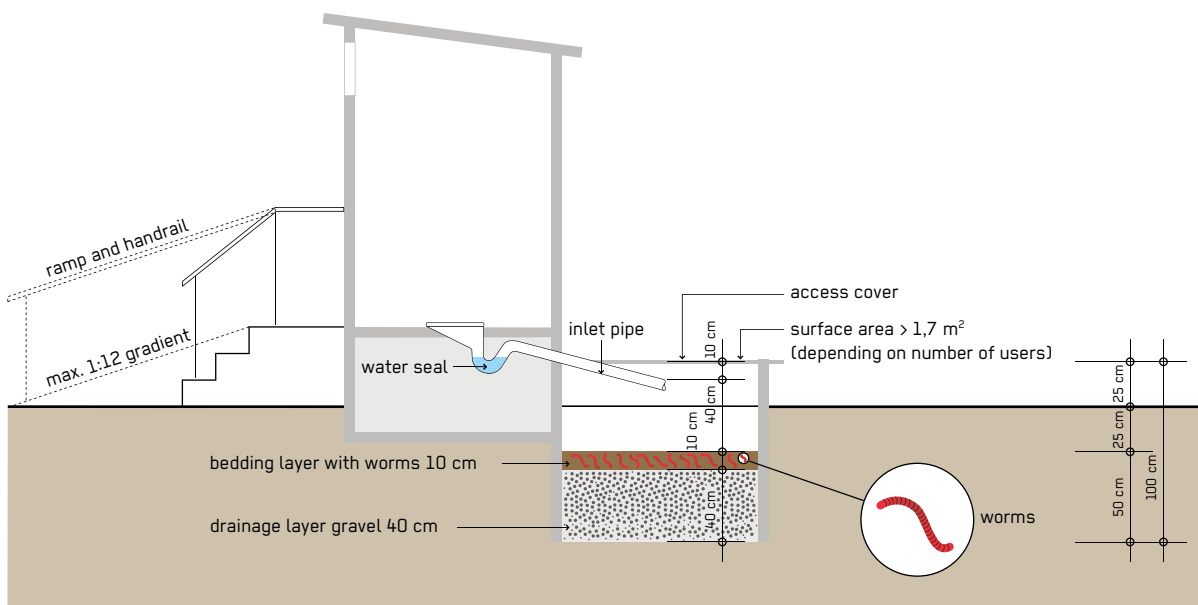

The Worm-Based Toilet is an emerging technology that has been used successfully in rural, peri-urban and camp settings. It consists of a pour flush pan connected to a vermifilter (filter containing worms). The effluent infiltrates into the soil and the vermicompost (worm waste) is emptied approximately every 5 years.

By using composting worms the solids are considerably reduced. 1 kg of human faeces is converted into approximately 100–200 g of vermicompost. The system thus needs emptying less frequently than traditional pit systems. The vermicompost is generated at the top of the system and is a dry humus-like material, which, compared with untreated excreta, is relatively easy and safe to empty.

**Design Considerations:** The surface area of the household tank for the vermifilter varies from 0.7 m<sup>2</sup> to 1 m<sup>2</sup> depending on the number of users. The depth of the tank is approximately 1 m. The bottom of the tank is exposed to the soil. The tank contains 40 cm of drainage material (gravel or stones), 10 cm of organic bedding material (woodchips, coconut husks or compost) and the worms. The lid to this tank needs to fit extremely well, but should not be sealed. This is then connected to the pour flush system.

**Materials:** Worm-Based Toilets can be constructed from locally available materials. The superstructure should contain a roof and a door for privacy. A pour flush pan is also required. The offset tank can be made from various materials including concrete rings, masonry and brickwork. The most important material is the worms (100 g per person). The type of worms required are composting worms. Four species of worms have been successfully used to date, namely *Eisenia fetida*, *Eudrilus eugeniae*,

Perionyx excavatus and Eisenia andrei. They can be found locally, bought from vermicomposting or vermiculture businesses, or imported.

**Applicability:** Worm-Based Toilets are a viable solution if long-term household sanitation is required and emptying is an issue. They are particularly appropriate in contexts where water is available and used for flushing, and in camp communities that have a strategy of implementing household systems. As the toilets can be built half above and half below the ground they can be used in areas with relatively high water tables (approx. 1 m). As the effluent enters the soil, a certain infiltration capacity is required. Securing a worm supply can be an issue.

**Operation and Maintenance:** General operation and maintenance (O&M) measures include regular cleaning of toilets, advice on proper use, minor repairs, regular checking of the well-being of the worms and the monitoring of the filling of the tank. These toilets require emptying approximately every 5 years. Ideally the toilets are emptied by the household after they have been un-used for one week, allowing the fresh faeces to be converted into vermicompost. The vermicompost should be removed from the edges of the tank with a small spade, then the vermicompost from the middle should be spread across the surface to create a bedding later. The harvested vermicompost can be buried on-site. When sensitising the users, it should be highlighted that only water, faeces, urine and possibly toilet paper should go into these toilets. The toilets should only be cleaned with water and a brush, and should be flushed after every use including urination. O&M is still a grey area as the systems which have been built have not been emptied yet. If emptying by the households is not an option (due to acceptability issues or other reasons) other options involving local service providers need to be identified.

**Health and Safety:** If used and managed well, Worm-Based Toilets can be considered a safe excreta containment technology. They need to be equipped with Handwashing Facilities (U.7) and proper handwashing with soap after toilet use needs to be addressed as part of the hygiene

promotion activities (X.12). Recent research studies suggest that the effluent from worm-based systems can be considered safer than the effluent from septic tanks and that the vermicompost generated can be considered safer than faecal sludge. However, more research is required to confirm this.

**Costs:** Worm-Based Toilets can be built using locally available materials. The worms can be costly, but in larger-scale projects worm cultivation can be incorporated. The cost is comparable to that of a well-constructed pit latrine. O&M costs should be included over the lifetime of the toilet. Over time this technology becomes increasingly financially viable compared with other pit latrine systems.

**Social Considerations:** The potential handing over to beneficiaries and the roles and responsibilities for O&M need to be agreed upon from the design phase and closely linked to respective hygiene promotion activities (X.12) to ensure appropriate use, operation and maintenance of the facilities. The community needs to be sensitised to the worms and toilets. This can be done by highlighting advantages of the system, i.e. little space required, convenient water-based system, no odour, less emptying, rather than discussing the use of the worms. There has been little adverse reaction to the use of worms.

#### Strengths and Weaknesses:

- ⊕ No odour
- ⊕ Design is adaptable to locally available materials
- ⊕ Low emptying frequency (> 5 years of use)
- ⊕ Easier and more pleasant to empty
- ⊖ Requires water for flushing (min 200 ml) and composting worms (100 g per person)
- ⊖ Unclear if menstrual hygiene products can be digested by the worms
- ⊖ Bleach or other chemicals cannot be used to clean the toilet
- ⊖ Lack of evidence on O&M

→ **References and further reading material for this technology can be found on page 191**

# Septic Tank

| Phase of Emergency  | Application Level / Scale   | Management Level   | Objectives / Key Features  |
|---|---|--|--|
| <ul style="list-style-type: none"> <li>* Acute Response</li> <li>** Stabilisation</li> <li>** Recovery</li> </ul> | <ul style="list-style-type: none"> <li>** Household</li> <li>** Neighbourhood</li> <li>** City</li> </ul> | <ul style="list-style-type: none"> <li>** Household</li> <li>** Shared</li> <li>** Public</li> </ul> | Excreta containment, Solid/liquid separation                           |
| Space Required  | Technical Complexity  | Inputs   | Outputs  |
| <ul style="list-style-type: none"> <li>** Medium</li> </ul>   | <ul style="list-style-type: none"> <li>* Low</li> </ul>   | <ul style="list-style-type: none"> <li>● Blackwater, ● Greywater</li> </ul>                          | <ul style="list-style-type: none"> <li>● Effluent, ● Sludge</li> </ul> |

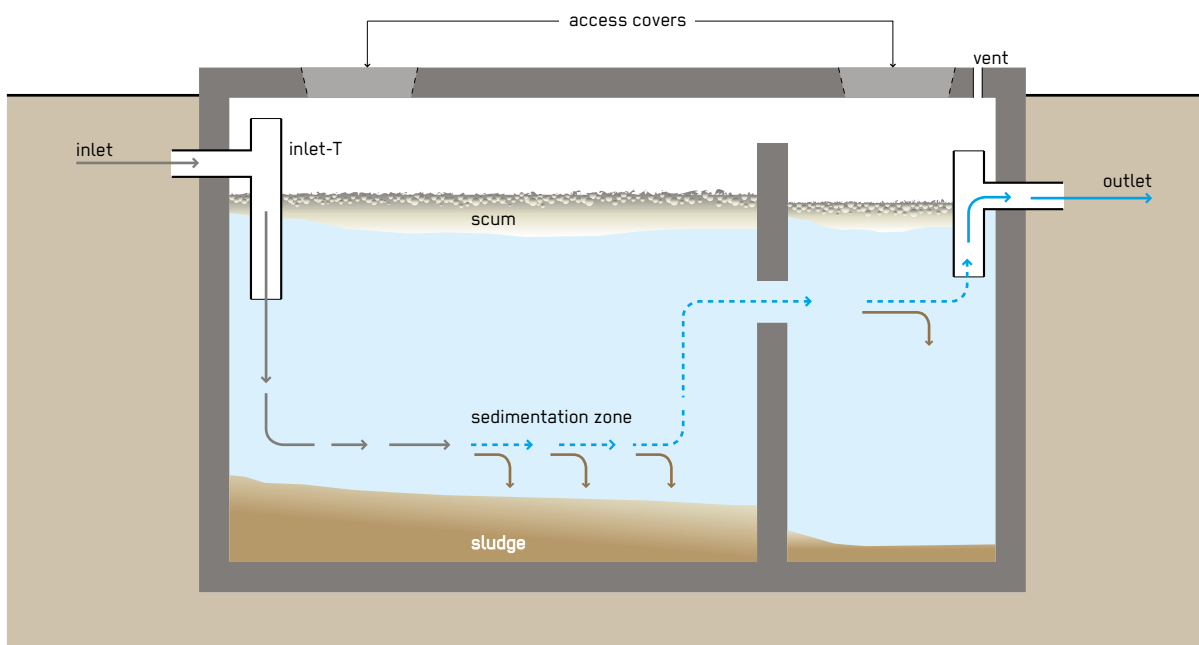

A Septic Tank is a watertight chamber made of concrete, fibreglass, PVC or plastic, through which blackwater and greywater flows for primary treatment, before further treatment or infiltration. Settling and anaerobic processes reduce solids and organics. The liquid effluent is commonly disposed of in a Leach Field (D.9) or Soak Pit (D.10) which provides further treatment.

Wastewater enters the first chamber of the tank, allowing solids to settle and scum (mostly oil and grease) to float to the top. Over time, solids that settle are degraded anaerobically. Generally, the removal of 50% of solids, 30–40% of the biochemical oxygen demand and a 10-fold reduction of E. Coli can be expected in a well-designed and maintained Septic Tank, although efficiencies vary greatly depending on operation and maintenance and climatic conditions.

**Design Considerations:** A Septic Tank should have at least two chambers. The first chamber needs to be at least 50% of the total length. Most of the solids settle out in the first chamber. The baffle, or the separation between the chambers, prevents scum and solids from escaping with the effluent, as well as reduces short circuiting through the tanks. A T-shaped outlet pipe further reduces scum and solids that are discharged. Accessibility to all chambers (through access ports) is necessary for maintenance. Septic Tanks should be vented for controlled release of odorous and potentially harmful gases. The design of a septic tank depends on the expected number of users, the water used per capita, average annual temperature, desludging frequency and wastewater characteristics. The minimum recommended retention time for small tanks is 24 hours, decreasing to 12 hours in very large tanks. The volume must be large enough to avoid turbulent flow. An “aqua privy” is a variation of the Septic Tank where the storage and settling tank is located directly below the toilet so that

the excreta fall into it. The aqua privy can be smaller than a Septic Tank because no flushing water is required to transport excreta to the tank.

**Materials:** A Septic Tank can be made of local bricks, cement blocks or stone and thus can be constructed on site using local materials. Prefabricated tanks are available in fibreglass, PVC or plastic.

**Applicability:** This technology is appropriate at the household level as well as for institutions such as hospitals and schools. A Septic Tank is appropriate where the volume of wastewater produced is too large for disposal in pit latrines, and when there is sufficient water for flushing solids from the toilet to the tank. This depends on the distance between toilet and tank. If Septic Tanks are used in densely populated areas, on-site soil infiltration should not be used, because the ground may become saturated and contaminated, posing a serious health risk. Instead, Septic Tanks should be connected to a conveyance technology, through which the effluent is transported to a subsequent treatment or disposal site. Even though Septic Tanks are watertight, it is not recommended to construct them in areas with high groundwater tables or where there is frequent flooding. As the Septic Tank must be regularly desludged, a vacuum truck should be able to access the location (C.2). They can be implemented in every type of climate, although the efficiency will be lower in colder climates (as anaerobic digestion occurs more efficiently at higher temperatures).

**Operation and Maintenance:** Desludging is required for Septic Tanks and frequency will depend on the volume of the tank relative to the input of solids, the amount of indigestible solids, and the ambient temperature, as well as usage, system characteristics and the requirements of the relevant authority. Well-functioning systems will require emptying every two to five years. Scum and sludge levels need to be monitored to ensure that the tank is functioning well. Emptying is best done by using a Motorised Emptying and Transport technology (C.2), but Manual Emptying and Transport (C.1) can also be an option. The

effluent and faecal sludge require further treatment prior to disposal. The most common cause of failure of Septic Tanks is the failure of the disposal system. Tanks connected to under-designed disposal systems will require emptying more frequently.

**Health and Safety:** Under normal operating conditions, users do not come in contact with the influent or effluent. Effluent, scum and sludge must be handled with care as they contain high levels of pathogens. During sludge and scum removal, workers should be equipped with personal protective equipment. Users should be careful when opening the tank because noxious and flammable gases may be released. If effluent is to infiltrate the ground, it is important to evaluate the contamination risk to groundwater, as well as the infiltration capacity of the soil.

**Costs:** This is a low to medium cost option, both in terms of capital and operational costs. However, additional costs for subsequent regular desludging, transport, treatment and disposal need to be taken into consideration.

**Social Considerations:** The Septic Tank is a very common and well-accepted technology among people who use flush toilets. Because of the delicate ecology in the system, awareness raising on eliminating the use of harsh chemicals for the users is necessary.

**Strengths and Weaknesses:**

- ⊕ Simple and robust technology
- ⊕ No electrical energy is required
- ⊕ Low operating costs and long service life
- ⊕ Built underground
- ⊖ Low reduction in pathogens, solids and organics
- ⊖ Regular desludging must be ensured
- ⊖ Effluent and sludge require further treatment and/or appropriate discharge

→ **References and further reading material for this technology can be found on page 191**

# Anaerobic Baffled Reactor (ABR)

| Phase of Emergency                               | Application Level / Scale               | Management Level                      | Objectives / Key Features                                   |
|--|---|---------------------------------------|---|
| Acute Response<br>★ Stabilisation<br>★★ Recovery | ★ Household<br>★★ Neighbourhood<br>City | ★ Household<br>★★ Shared<br>★★ Public | Excreta containment, Solid/liquid separation, BOD reduction |
| Space Required                                   | Technical Complexity                    | Inputs                                | Outputs   |
| ★★ Medium  | ★★ Medium                               | ● Blackwater, ● Greywater             | ● Effluent, ● Sludge, ● Biogas                              |

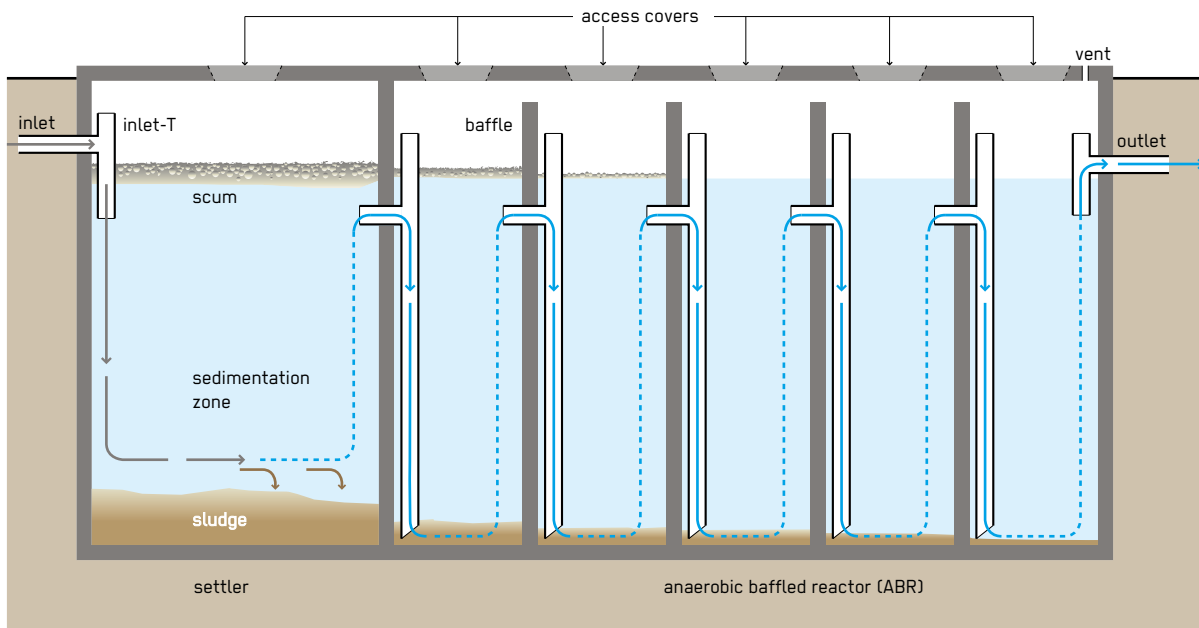

The Anaerobic Baffled Reactor (ABR) treats many different types of wastewater and can be considered an 'improved' Septic Tank (S.13) that uses baffles to optimise treatment. Treatment of the wastewater takes place as it is forced to flow upward through a series of chambers, where pollutants are biologically degraded in an active sludge layer at the bottom of each chamber.

ABRs can treat raw, primary, and secondary treated sewage and greywater (with organic load). The principal working process is anaerobic (in the absence of oxygen) and makes use of biological treatment mechanisms. The upflow chambers provide enhanced removal and digestion of organic matter. Biochemical oxygen demand (BOD) may be reduced by up to 90%, which is far superior to its removal in a conventional Septic Tank (S.13).

**Design Considerations:** Small-scale, stand-alone ABRs typically have an integrated settling compartment, but primary sedimentation can also take place in a separate Settler (T.1) or another preceding technology, e.g. a Septic Tank (S.13). ABRs should consist of at least 4 chambers (as per BOD load), more than 6 are not recommended. The organic load should be  $< 6 \text{ kg/m}^3 \text{ * /day BOD}$ , the water depth at the outlet point is preferably about 1.8 m; a maximum of 2.2 m (for large systems) should not be exceeded. Hydraulic retention time should not be less than 8 hours, and 16–20 hours is a preferred range. Upflow velocity ideally ranges around 0.9 m/h, velocities above 1.2 m/h should be avoided. Accessibility to all chambers (through access ports) is necessary for maintenance. The tank should be vented to allow for controlled release of odorous and potentially harmful gases. Where kitchen wastewater is connected to the system, a grease trap must be positioned before the settler component to avoid excess oil and grease substance entering and hindering treatment processes.

**Materials:** An ABR can be made of concrete, fibreglass, PVC or plastic, and can be prefabricated. A pump might be required for discharging the treated wastewater where gravity flow is not an option.

**Applicability:** Roughly, an ABR for 20 households can take up to several weeks to construct, much quicker (3–4 days) if reinforced fibre plastic ABR prefab modules are used. Once in operation, 3–6 months (up to 9 in colder climates) is needed for the biological environment to establish and maximum treatment efficiency to be reached. Therefore, ABRs are not suitable for the acute response phase of an emergency but are more suited for the stabilisation and recovery periods. They can also be a long-term solutions. The neighbourhood scale is most suitable, but it can also be implemented at the household level or in larger catchment areas and/or public buildings (e.g. schools). Even though ABRs are designed to be watertight, it is not recommended to construct them in areas with high groundwater tables or where there is frequent flooding, alternatively prefabricated modules can be placed above ground. ABRs can be installed in every type of climate, although the efficiency will be lower in colder climates.

**Operation and Maintenance:** ABRs are relatively simple to operate; once the system is fully functioning, specific operation tasks are not required. To reduce start-up time, the ABR can be inoculated with anaerobic bacteria, e.g. by adding Septic Tank sludge, or cow manure. The system should be checked monthly for solid waste, and the sludge level should be monitored every 6 months. Desludging is required every 2–4 years, depending on the accumulation of sludge at the bottom of chambers reducing treatment efficiency. Desludging is best done using a Motorised Emptying and Transport technology (C.2), but Manual Emptying (C.1) can also be an option. A small amount of sludge should be left to ensure the biological process continues.

**Health and Safety:** Effluent, scum and sludge must be handled with care as they contain high levels of pathogens. During sludge and scum removal, workers should be equipped with proper protection personal protective equipment (boots, gloves, and clothing). The effluent should be treated further (e.g. POST) if reused in agriculture or otherwise discharged properly.

**Costs:** The capital costs of an ABR is medium and the operational costs are low. Costs of the ABR depend on what other conveyance technology and treatment modules used, and also on local availability and thus costs of materials (sand, gravel, cement, steel) or prefabricated modules and labor costs. The main operation and maintenance costs are related to the removal of primary sludge and the cost of electricity if pumps are required for discharge (in the absence of a gravity flow option).

**Social Considerations:** Usually, anaerobic treatment systems are a well-accepted technology. Because of the delicate ecology in the system, awareness raising on eliminating the use of harsh chemicals for the users is necessary.

**Strengths and Weaknesses:**

- ⊕ Low operating costs
- ⊕ Resistant to organic and hydraulic shock loadings
- ⊕ High reduction of BOD
- ⊕ Low sludge production; the sludge is stabilised
- ⊖ Requires expert design and construction
- ⊖ Low reduction of pathogens and nutrients
- ⊖ Effluent and sludge require further treatment and/or appropriate discharge
- ⊖ Long start-up time

→ **References and further reading material for this technology can be found on page 192**

# Anaerobic Filter

| Phase of Emergency                               | Application Level / Scale               | Management Level                      | Objectives / Key Features          |
|--|---|---------------------------------------|------------------------------------|
| Acute Response<br>★ Stabilisation<br>★★ Recovery | ★ Household<br>★★ Neighbourhood<br>City | ★ Household<br>★★ Shared<br>★★ Public | Excreta containment, BOD reduction |
| Space Required                                   | Technical Complexity                    | Inputs                                | Outputs                            |
| ★★ Medium  | ★★ Medium                               | ● Blackwater, ● Greywater             | ● Effluent, ● Sludge               |

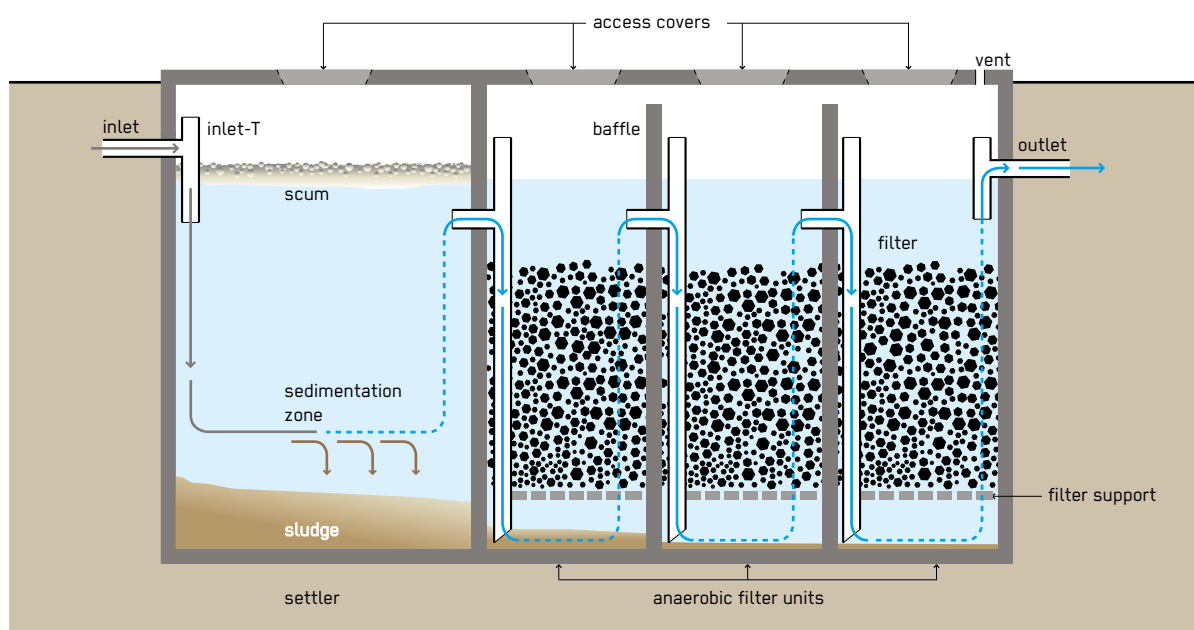

An Anaerobic Filter (AF) can efficiently treat many different types of wastewater. An AF is a fixed-bed biological reactor with one or more filtration chambers in series. As wastewater flows through the filter, particles are trapped and organic matter is degraded by the active biofilm that is attached to the surface of the filter material.

This technology is widely used as a secondary treatment in black or greywater systems and improves the solid removal compared to Septic Tanks (S.13) or Anaerobic Baffled Reactors (S.14). The treatment process is anaerobic making use of biological treatment mechanisms. Suspended solids and biochemical oxygen demand (BOD) removal can be up to 90 %, but is typically between 50 % and 80 %. Nitrogen removal is limited and normally does not exceed 15 % in terms of total nitrogen.

**Design Considerations:** Pre-Treatment (PRE) is essential to remove solids and solid waste that may clog the filter. The majority of settleable solids are removed in a sedimentation chamber in front of the AF. Small-scale, stand-alone units typically have an integrated settling compartment, but primary sedimentation can also take place in a separate Settler (T.1) or another preceding technology, e.g. Septic Tank (S.13). AFs are usually operated in upflow mode because there is less risk that the fixed biomass will be washed out and treatment efficiency reduced. The water level should cover the filter media by at least 0.3 m to guarantee an even-flow regime. The hydraulic retention time (HRT) is the most important design parameter influencing filter performance and a HRT of 12–36 hours is recommended. The ideal filter should have a large surface area for bacteria to grow, with large pore volume to prevent clogging. The surface area ensures increased contact between organic matter and attached biomass that effectively degrades it. Ideally, the material should provide



between 90 to 300 m<sup>2</sup> of surface area/m<sup>3</sup> of occupied reactor volume. The connection between chambers can be designed either with vertical pipes or baffles. Accessibility to all chambers (through access ports) is necessary for maintenance. The tank should be vented to allow for controlled release of odorous and potentially harmful gases. Where kitchen wastewater is connected to the system, a grease trap must be incorporated into the design before the Settler.

**Materials:** An AF can be made of concrete, sand, gravel, cement, steel, as well as fibreglass, PVC or plastic and can be prefabricated. Typical filter material should ideally range from 12 to 55 mm in diameter, decreasing in diameter from bottom to top. Filter materials commonly used include gravel, crushed rocks or bricks, cinder, pumice, shredded glass or specially-formed plastic pieces (even crushed PVC plastic bottles can be used).

**Applicability:** AFs are not suitable for the acute response stage of an emergency because the biological environment within the AF takes time to establish. AFs are more suited for stabilisation and recovery periods, and are long-term solutions. The neighbourhood scale is most suitable, but AFs can also be implemented at the household level, in larger catchment areas or in public buildings (e.g. schools). Even though AFs are watertight, it is not recommended to construct them in areas with high groundwater tables or where there is frequent flooding. However, prefabricated modules can be placed above ground. AFs can be installed in every type of climate, although efficiency will be lower in colder climates. Pathogen and nutrient reduction is low in AFs; if high effluent standards are to be achieved, an additional treatment technology should be added, e.g. the Anaerobic Baffled Reactor (S.14), Waste Stabilisation Ponds (T.5) or Constructed Wetlands (T.6).

**Operation and Maintenance:** An AF requires a start-up period of 6 to 9 months to reach full treatment capacity since the slow-growing anaerobic biomass first needs to be established on the filter media. To reduce start-up time, the filter can be inoculated with anaerobic bacteria, e.g. by spraying Septic Tank sludge onto the filter material. The flow should be gradually increased over time. Scum and sludge levels need to be monitored to ensure that the tank is functioning well. Over time, solids

will clog the pores of the filter. Also the growing bacterial mass can become too thick, break off and eventually clog pores. When the efficiency decreases, the filter must be cleaned. This is done by running the system in reverse mode (backwashing) or by removing and cleaning the filter material. AF tanks should be checked from time to time to ensure that they are watertight.

**Health and Safety:** Effluent, scum and sludge must be handled with care as the effluent still contains pathogens and should be treated further if reused in agriculture, directly used for fertilisation and irrigation or discharged properly. Full personal protective equipment must be worn during the desludging and cleaning of the AF.

**Costs:** The capital cost of an AF is medium and the operational costs are low. The costs of the AF depend on the conveyance technology and treatment used, and also on local availability and thus costs of construction materials (sand, gravel, cement, steel), or cost of the prefabricated modules, and labor costs. The main operation and maintenance costs are related to the removal of primary sludge and cost of electricity if pumps are required for discharge (in the absence of the gravity flow option).

**Social Considerations:** Usually, AF treatment systems are a well-accepted technology. Because of the delicate ecology in the system, awareness raising on eliminating the use of harsh chemicals for the users is necessary.

#### Strengths and Weaknesses:

- ⊕ Low O & M requirements and costs
- ⊕ Robust and stable treatment performance  
(Resistant to organic and hydraulic shock loadings)
- ⊕ No electrical energy is required
- ⊕ High reduction of BOD and solids
- ⊖ Limited reduction of pathogens and nutrients
- ⊖ Requires expert design and construction
- ⊖ Removing and cleaning the clogged filter media is cumbersome
- ⊖ Long start-up time

→ **References and further reading material for this technology can be found on page 192**

# Biogas Reactor

| Phase of Emergency                               | Application Level / Scale                  | Management Level                                 | Objectives / Key Features                                     |
|--|--|--|---|
| Acute Response<br>★ Stabilisation<br>★★ Recovery | ★★ Household<br>★★ Neighbourhood<br>★ City | ★★ Household<br>★★ Shared<br>★★ Public           | Excreta containment, Stabilisation of sludge, Biogas recovery |
| Space Required                                   | Technical Complexity                       | Inputs   | Outputs   |
| ★★ Medium  | ★★ Medium                                  | ● Excreta, ● Blackwater,<br>● Sludge, ● Organics | ● Biogas, ● Sludge  |

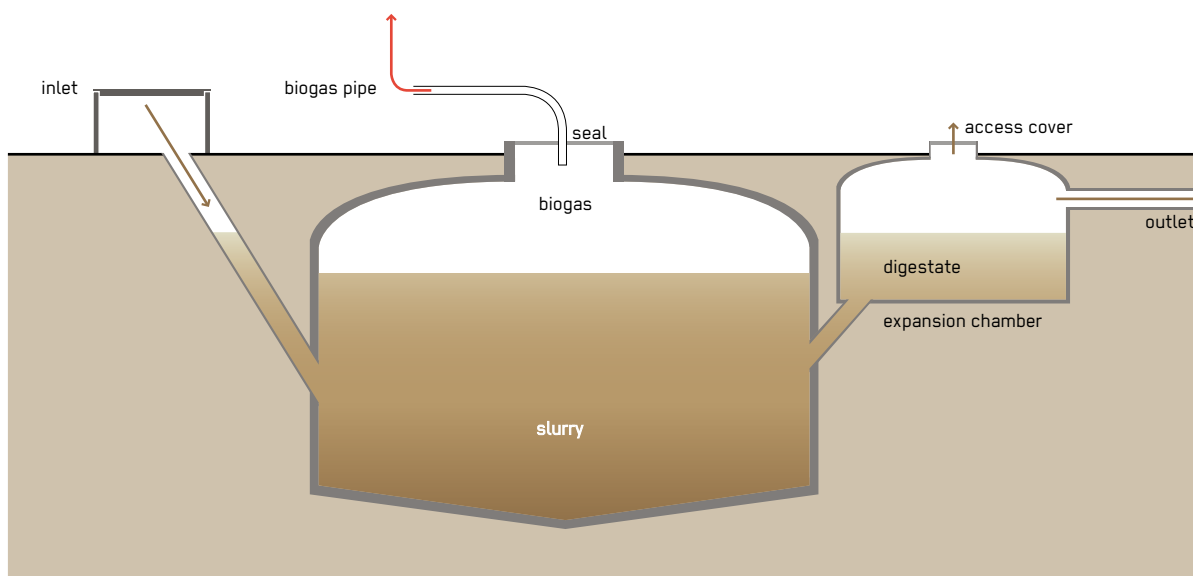

A Biogas Reactor can efficiently treat different types of wastewater. It is an anaerobic treatment technology that produces a digested sludge (digestate) that can be used as a fertiliser and biogas that can be used for energy. Biogas is a mix of methane, carbon dioxide and other trace gases which can be converted to heat, electricity or light (D.7).

A Biogas Reactor is an airtight chamber which facilitates anaerobic degradation of blackwater, sludge, and/or biodegradable waste. Treatment of wastewater takes place as it enters the digester. Inputs are biologically degraded in an active sludge layer within the digester. The digested sludge is discharged from the overflow point at ground level. The chamber also facilitates the collection of biogas produced in the fermentation processes in the reactor. The digestate is rich in organics and nutrients, and is relatively easy to dewater and manage.

**Design Considerations:** Biogas Reactors can be built as fixed dome or floating dome digesters. In the fixed dome, the volume of the reactor is constant. As gas is generated it exerts a pressure and displaces the slurry upward into an expansion chamber. When the gas is removed, the slurry flows back into the reactor. The pressure can be used to transport the biogas through the pipes. In a floating dome reactor, the dome rises and falls with the production and withdrawal of gas. Alternatively, the dome can expand (like a balloon). The hydraulic retention time (HRT) in the reactor should be at least 15 days in hot climates and 25 days in temperate climates. For highly pathogenic inputs, a HRT of 60 days should be considered. Sizes can vary from 1,000 L for a single family up to 100,000 L for institutional or public toilet applications. Because the digestate production is continuous, there must be provisions made for its storage, use and/or transport away from the site.

**Materials:** A Biogas Reactor can be made of bricks, cement, steel, sand, wire for structural strength (e.g. chicken wire), waterproof cement additive (for sealing), water pipes and fittings, a valve and a prefabricated gas outlet pipe. Prefabricated solutions include geo-bags, reinforced fibre plastic modules, and router moulded units and are available from specialist suppliers.

**Applicability:** This technology is appropriate for treating household wastewater as well as wastewater from institutions such as hospitals and schools. It is not suitable for the acute phase of an emergency, as the biology needs time to start up. It is especially applicable in rural areas where animal manure can be added and there is a need for the digestate as fertiliser and gas for cooking. Biogas Reactors can also be used to stabilise sludge from Pit Latrines (S.3, S.4). Often, a Biogas Reactor is used as an alternative to a Septic Tank (S.13) since it offers a similar level of treatment, but with the added benefit of biogas. However, significant gas production cannot be achieved if blackwater is the only input or if the ambient air temperature is below 15 °C. Greywater should not be added as it substantially reduces the HRT. Biogas Reactors are less appropriate for colder climates as the rate of organic matter conversion into biogas is very low. Consequently, the HRT needs to be longer and the design volume substantially increased. Even though Biogas Reactors are watertight, it is not recommended to construct them in areas with high groundwater tables or where there is frequent flooding.

**Operation and Maintenance:** To start the reactor, it should be inoculated with anaerobic bacteria, e.g. by adding cow dung or Septic Tank sludge. Digestate needs to be removed from the overflow frequently. The frequency will depend on the volume of the tank relative to the input of solids, the amount of indigestible solids, and the ambient temperature, as well as usage and system characteristics. Gas should be monitored and used regularly. Water traps should be checked regularly and valves and gas piping should be cleaned so that corrosion and leaks are prevented. Depending on the design and the inputs, the reactor should be emptied and cleaned every 5 to 10 years.

**Health and Safety:** The digestate is partially sanitised but still carries a risk of infection, therefore during digestate removal, workers should be equipped with proper personal protective equipment (PPE). Depending on its end-use, emptied liquid and sludge require further treatment prior to use in agriculture. Cleaning of the reactor can be a health-hazard and appropriate safety precautions (wearing proper PPE) should be taken. There are also dangers associated with the flammable gases but risks are the same as with natural gas. There is no additional risk due to the origin of the gas.

**Costs:** This is a low to medium cost option, both in terms of capital and operational costs. However, additional costs related to the daily operations needed by the reactor should be taken into consideration. Community installations tend to be more economically viable, as long as they are socially accepted. Costs for capacity development and training for operators and users must be budgeted for until the knowledge is well established.

**Social Considerations:** Social acceptance may be a challenge for communities that are not familiar with using biogas or digestate. Social cohesion can be created through shared management and shared benefits (gas and fertiliser) from Biogas Reactors, however, there is also a risk that benefits are unevenly distributed among users which can lead to conflict.

#### Strengths and Weaknesses:

- ⊕ Reduced solid waste management cost and faecal sludge transportation costs
- ⊕ Generation of useable products – gas and fertiliser
- ⊕ Long service life (robust)
- ⊖ Requires expert design and skilled construction
- ⊖ Incomplete pathogen removal, the digestate might require further treatment
- ⊖ Limited gas production below 15 °C and when using only blackwater
- ⊖ Medium level investment cost

→ **References and further reading material for this technology can be found on page 192**

# Hydrated Lime Treatment (Emerging Technology)

| Phase of Emergency                               | Application Level / Scale               | Management Level                 | Objectives / Key Features   |
|--|---|----------------------------------|---|
| ** Acute Response<br>* Stabilisation<br>Recovery | Household<br>** Neighbourhood<br>* City | Household<br>Shared<br>** Public | Pathogen removal, Liquid/solid separation, Minimising immediate public health risks |
| Space Required                                   | Technical Complexity                    | Inputs                           | Outputs   |
| * Little   | ** Medium                               | ● Blackwater, ● Sludge           | ● Effluent, ● Sludge  |

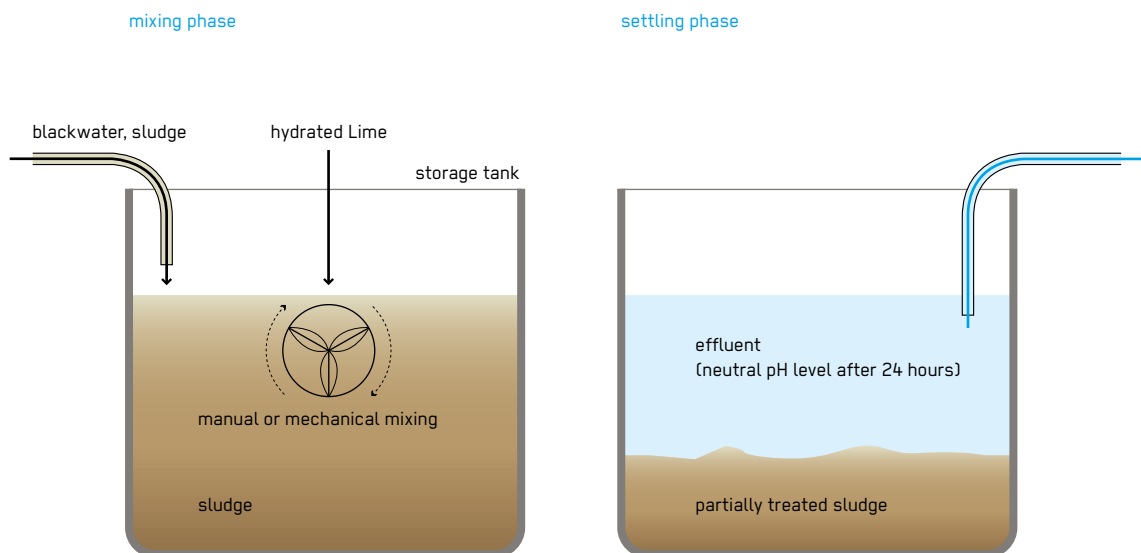

Hydrated Lime Treatment is a cost-effective chemical treatment for faecal sludge from pits and trenches. It uses hydrated or slaked lime (calcium hydroxide:  $\text{Ca(OH)}_2$ ) as an additive to create a highly alkaline environment. It significantly reduces the public and environmental health risks of latrine sludge.

Hydrated lime is used to increase pH and create an alkaline environment in blackwater or sludge, making it no longer a viable habitat for pathogens. The optimum dosage to reach a recommended pH of above 12 should be between 10–17 g lime/kg of faecal sludge with a contact time of at least 2 hours. The exact amount of time required depends on the quality of the lime and the characteristics of the blackwater or sludge. Its effect can be enhanced by increasing the contact time or dosage. The treatment should be undertaken as a batch process. It is a robust technology that can be used to treat both solid and liquid sludge. Above pH 10.4 hydrated lime also acts

as a coagulant with precipitation of  $\text{Mg(OH)}_2$  and allows for separation of sludge and effluent for liquid sludge with < 3% dry solids. To increase the precipitation of solid particles, and depending on the presence of an excess of magnesium cations in blackwater or sludge, magnesium sulphate can be added. After treatment, the pH falls towards neutral usually within 24 hours and the treated sludge decants. After pH neutralisation, the supernatant can be pumped off and safely infiltrated into the soil (e.g. D.10) or used for irrigation or landscaping purposes. However, groundwater pollution may be an issue due to the high nutrient load. The treated solids can be used as a soil amendment or dried and used as cover for landfills.

**Design Considerations:** Hydrated Lime Treatment should be carried out in a leak-proof cistern or tank, if the tank is located below ground, care should be taken to ensure it is absolutely water tight to avoid the leakage of highly alkaline effluent into the soil. In areas with high groundwater

level or in flood prone areas it is recommended to use above ground tanks. Separate tanks may be needed for preparation of the lime slurry and for post-neutralisation of the treated effluent respectively.

**Materials:** Hydrated Lime Treatment needs a reactor vessel. A smaller additional container is needed to prepare the lime slurry (e.g. a 200 L plastic drum). For an even distribution of hydrated lime throughout the sludge, constant mixing is required (either manually or with a mixing pump). The type of pump required depends on the consistency of the sludge. A separate pump is needed to remove the treated effluent from the tank and a shovel or vacuum pump to remove the solid material. In addition a water testing kit (particularly for pH, E.coli, total suspended solids and turbidity) is needed as well as personal protective equipment (PPE) including masks, gloves, boots, apron or suit and respective chemicals (hydrated lime, magnesium sulphate if needed).

**Applicability:** Hydrated Lime Treatment is particularly suitable for the rapid response phase due to its short treatment time, simple process and use of readily available materials. With trained and skilled staff, it allows for safe, cost-effective and rapid treatment of faecal sludge with outputs that can be safely used for irrigation or soil amendment or can be safely infiltrated or disposed of, if the environmental conditions permit.

**Operation and Maintenance:** Lime is corrosive in nature due to its alkalinity and regular maintenance of the pumps used for mixing will be required. Due to the potential health risks when handling hydrated lime, skilled staff are required who follow appropriate health and safety protocols.

**Health and Safety:** Hydrated lime is a powder and corrosive to skin, eyes and lungs. Therefore, adequate PPE must be worn when handling hydrated lime to prevent irritation to eyes, skin, respiratory system, and gastrointestinal tract. Protection from fire and moisture must also be ensured. Lime is an alkaline material that reacts strongly with moisture. Staff must be carefully trained to follow health and safety protocols.

**Costs:** Hydrated Lime Treatment is a relatively cheap treatment option. Costs may vary depending on the availability and costs of local materials and chemicals/lime. As part of an appropriate health risk management, costs for personal protective equipment and staff trainings need to be considered.

**Social Considerations:** Proper health and safety protocols should be in place and include the provision of PPE and respective trainings for involved staff.

**Strengths and Weaknesses:**

- ⊕ Short treatment time (6 log removal of E-coli in < 1day i.e. pathogen count is 1 million times smaller)
- ⊕ Simple process which uses commonly available material
- ⊕ For liquid sludge, a sanitised and stabilised effluent is created suitable for soil infiltration
- ⊖ High chemical input
- ⊖ Mixing is essential for the process
- ⊖ Potential health risks if not handled properly

→ **References and further reading material for this technology can be found on page 192**

# Urea Treatment (Emerging Technology)

| Phase of Emergency                             | Application Level / Scale             | Management Level                                    | Objectives / Key Features                                  |
|--|---------------------------------------|---|--|
| ★★ Acute Response<br>Stabilisation<br>Recovery | Household<br>★★ Neighbourhood<br>City | Household<br>Shared<br>★★ Public                    | Pathogen removal, Minimising immediate public health risks |
| Space Required                                 | Technical Complexity                  | Inputs  | Outputs  |
| * Little                                       | ★★ Medium                             | ● Blackwater, ● Faecal Sludge,<br>● Urine, ● Faeces | ● Sludge   |

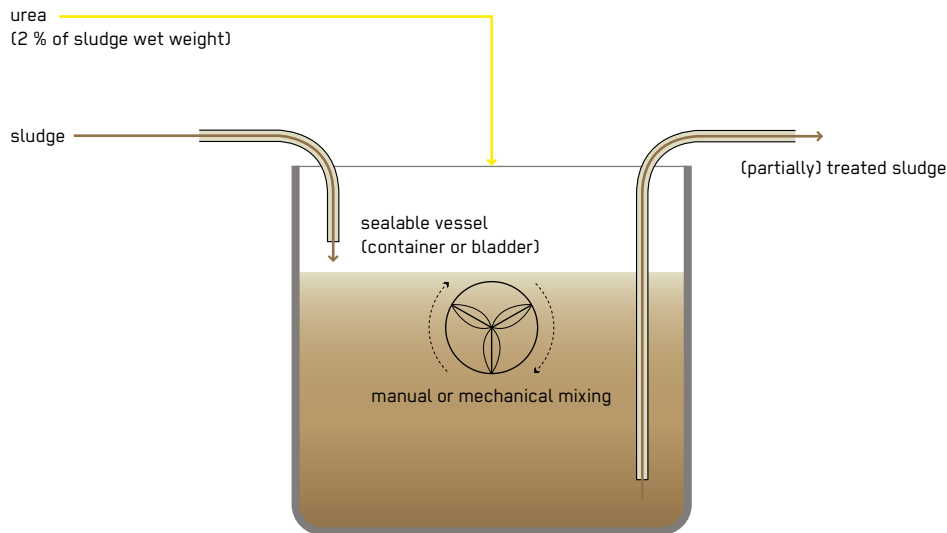

Urea Treatment can be used on faecal sludge, blackwater or source separated urine and faeces. Urea, with the chemical formula  $\text{CO}(\text{NH}_2)_2$ , is used as an additive to create an alkaline environment in the sludge storage device and thereby helps sanitise the sludge.

Urea when added to faecal sludge is catalysed by the enzyme urease, which is present in faecal material, to decompose into ammonia and carbonate. The urea decomposition results in an alkaline pH (above 7) affecting the equilibrium between ammonia and ammonium, favouring the formation of ammonia. The un-ionised ammonia ( $\text{NH}_3$ ) acts as the main sanitising agent. Pathogen inactivation by uncharged ammonia has been reported for several types of microorganisms, bacteria, viruses and parasites. Ammonia disinfection has been shown to be effective in urine, sewage sludge, and compost, but applications for faecal sludge are still in the research phase. The process depends on temperature and partial pressures of

ammonia gas above the liquid. Hence, ventilation and head space also influences the process conditions. It is recommended that treatment is undertaken in a sealed vessel to minimise the amount of ammonia gas that escapes and to force the equilibrium towards soluble ammonia. The treatment should be done as a batch process to ensure consistent sanitisation in the sludge.

**Design Considerations:** Urea is usually added at a ratio of 2% of the overall sludge wet weight. Urea is initially placed in the storage vessel (e.g. bladder/closed tank) and then faecal sludge is pumped into the vessel. The size of the vessel may vary depending on the amount and frequency of the sludge to be treated. A pump is used to circulate the sludge within the storage vessel to ensure adequate contact between the urea and sludge. Urea decomposition requires a minimum of 4 days, hence a retention time in the closed vessel of approximately 1 week is recommended.

**Materials:** Urea Treatment needs a lockable vessel (e.g. a closed tank or portable bladder) and a recirculation pump to achieve a homogeneous sludge-urea mix. For liquid sludge, a diaphragm pump may be used, whereas thicker sludge may need a screw pump or a vacuum pump. In addition, a steady supply of urea is needed. Urea is a conventional, widely used and affordable chemical fertiliser that should be available in most local contexts. In addition, a water testing kit (particularly for pH and E. coli) is needed to control pH levels in the urea sludge mix and to test the level of treatment efficacy.

**Applicability:** Urea Treatment is considered an emerging technology that has not been widely used yet in emergency settings. However, first pilot projects and studies are promising and growing evidence suggests that Urea Treatment may be a suitable treatment option for the acute emergency phase due to its short treatment time (around 1 week), a relatively simple process and use of readily available materials.

**Operation and Maintenance:** Regular maintenance of pumps used for mixing is required. Due to potential health risks when handling urea (see below) the process requires skilled personnel following health and safety protocols and wearing proper personal protective equipment (PPE).

**Health and Safety:** Urea may be hazardous when it comes on contact with skin or eyes (irritant), ingestion or inhalation and may be combustible at high temperatures. Ammonia gas is toxic and precautions are needed when

removing sludge from the tank. PPE (for example masks, gloves, aprons and long-sleeved clothing) must be worn when handling urea to prevent irritation to eyes, skin, and the respiratory system.

**Costs:** Urea Treatment is a relatively cheap treatment option. Costs may vary depending on the availability and costs of local materials and urea. To treat 1 m<sup>3</sup> of faecal sludge, 20 kg of urea are required and urea is generally available and affordable.

**Social Considerations:** Appropriate health and safety protocols must be in place and include the provision of PPE and trainings for involved staff.

#### **Strengths and Weaknesses:**

- ⊕ Treatment time ≈ 1 week (4–8 days)
- ⊕ High level of pathogen removal (6 log removal of E.coli i.e. pathogen count is 1 million times smaller)
- ⊕ Simple process which uses readily available material: urea
- ⊕ Produced sludge has a high nitrogen content which is beneficial for an agricultural application
- ⊖ High chemical input
- ⊖ Mixing is essential for the process
- ⊖ Additional post sludge treatment may be required
- ⊖ Potential health risks if not handled properly

→ **References and further reading material for this technology can be found on page 192**

# Lactic Acid Fermentation (LAF) Treatment (Emerging Technology)

| Phase of Emergency                               | Application Level / Scale             | Management Level                 | Objectives / Key Features                                  |
|--|---------------------------------------|----------------------------------|--|
| ** Acute Response<br>* Stabilisation<br>Recovery | Household<br>** Neighbourhood<br>City | Household<br>Shared<br>** Public | Pathogen removal, Minimising immediate public health risks |
| Space Required                                   | Technical Complexity                  | Inputs                           | Outputs  |
| * Little   | ** Medium                             | ● Blackwater, ● Sludge           | ● Sludge   |

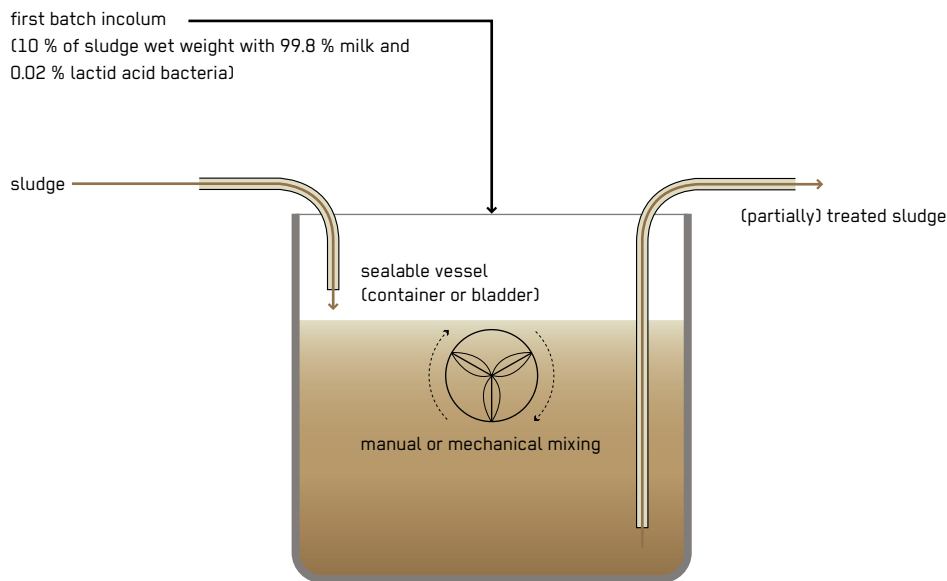

Lactic Acid Fermentation (LAF) is a biological treatment option using lactic acid bacteria (LAB) with the ability to form significant quantities of lactic acid and thereby aid in inactivating pathogens in faecal sludge. LAB are easily obtainable and can be made from molasses, milk and probiotic drinks.

Lactic acid, in its dissociated form can penetrate cell membranes and inactivate and destroy pathogens. The inactivation of pathogens is triggered when the concentration reaches approximately 20–30 g of lactic acid per litre of faecal sludge. This corresponds to a lowering of pH; pH conditions of less than pH 4 induce pathogen inactivation.

**Design Considerations:** It is recommended that the LAF process is carried out under batch conditions in sealed vessels (container or bladder). The vessel size may vary depending on the amount and frequency of sludge generated. LAB is cultured in an inoculum before being added to the fresh sludge. The inoculum for the first batch is a mixture of milk (99.8%) and LAB from, for example, Yakult (0.02%) that has been mixed and stored at room temperature for 48 hours. For subsequent batches the treated sludge can be used as an inoculum. For the biological process, the inoculum is initially added to the tank in the ratio of 10% of the overall sludge wet weight. The fresh faecal sludge is pumped into the vessel and recirculated to get a homogenous mix of fresh sludge and the inoculum. The sludge is then stored over a period of 2 weeks monitoring the pH daily to ensure a sanitised sludge is produced.



**Materials:** LAF Treatment needs a vessel, preferably sealable as LAB are most efficient under anaerobic conditions. However, LAB are aero-tolerant and therefore open tanks can be used if no sealed vessel is available. To achieve a homogeneous mix within the vessel a recirculation pump is required. The type of pump depends on the thickness of the sludge. For liquid sludge, a diaphragm pump may be used, whereas thicker sludge may need a screw pump or a vacuum pump. In addition, an initial supply of milk and a probiotic drink is needed to prepare the LAB molasses. To monitor the pH level and pathogens in the vessel a water testing kit is needed.

**Applicability:** LAF Treatment is considered an emerging technology that has not yet been widely used in emergency settings. However, first pilot projects and studies are promising and growing evidence suggests that LAF Treatment may be a suitable treatment option particularly for the acute response phase due to its short treatment time (around 2 weeks), a relatively simple process and use of readily available materials. It can be applied as an on-site treatment option for pit and trench latrines (S.1, S.3, S.4).

**Operation and Maintenance:** Regular maintenance of pumps is required, especially due to the corrosive nature of the treated sludge. For each new batch of faecal sludge an initial amount of sludge from the previous batch should remain in the reactor vessel as an inoculant for LAB production in the sludge.

**Health and Safety:** Molasses, milk or the LAB do not pose any significant health risk. However, proper personal protective equipment (PPE) should still be considered when handling the treated sludge as the final product may not be sufficiently treated and may still contain pathogens.

**Costs:** LAF Treatment can be considered a relatively cheap treatment option. Costs may vary depending on the availability and costs of local materials. To treat 1 m<sup>3</sup> of faecal sludge an initial amount of 100 L of milk and 200 ml of a probiotic drink is needed. For subsequent batches the treated sludge can be used as the inoculum.

**Social Considerations:** PPE should be worn and training for involved staff is needed to ensure the proper functioning of the technology.

**Strengths and Weaknesses:**

- ⊕ High reduction of pathogens (6 log removal of E.coli i.e. pathogen count is 1 million times smaller)
- ⊕ Simple process which uses readily available material: molasses and LAB
- ⊕ Produced sludge has a high lactic acid content (30 g/L) and can be used as inoculum for subsequent batches
- ⊕ Medium treatment time ≈2 weeks (15 days)
- ⊖ Biological process, therefore susceptible to environmental conditions
- ⊖ High temperatures are required (30 °C optimum)
- ⊖ Produced sludge is acidic (pH 4)
- ⊖ No stabilisation occurs and additional post sludge treatment is required

→ **References and further reading material for this technology can be found on page 192**

# Caustic Soda Treatment (Emerging Technology)

| Phase of Emergency                               | Application Level / Scale             | Management Level                 | Objectives / Key Features                                  |
|--|---------------------------------------|----------------------------------|--|
| ** Acute Response<br>* Stabilisation<br>Recovery | Household<br>** Neighbourhood<br>City | Household<br>Shared<br>** Public | Pathogen removal, Minimising immediate public health risks |
| Space Required                                   | Technical Complexity                  | Inputs                           | Outputs  |
| * Little   | ** Medium                             | ● Blackwater, ● Sludge           | ● Treated Effluent, ● Treated Sludge                       |

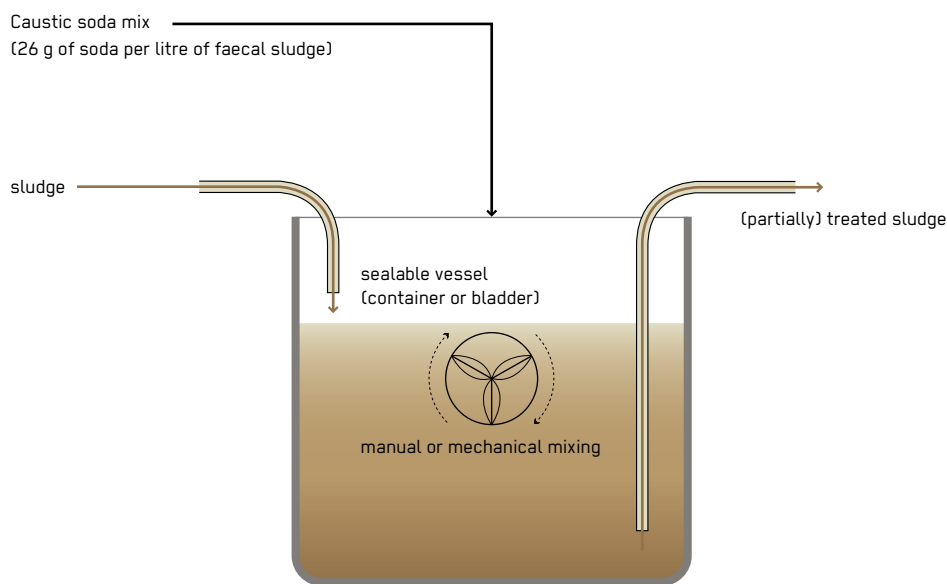

Caustic Soda Treatment is a cost-effective chemical treatment for faecal sludge from pits and trenches. It uses caustic soda also known as lye (sodium hydroxide: NaOH) as an additive to create a highly alkaline environment and thereby sanitises sludge from human waste. It significantly reduces the public and environmental health risks of latrine sludge.

Caustic soda is a white, alkaline, odourless material supplied as flakes packed in drums. It is used to increase the pH of blackwater or sludge and create a highly alkaline environment that destroys pathogens. The optimum dosage to reach the recommended pH of 12 is around 26 g of soda per litre of faecal sludge. The exact amount, however, depends on the characteristics of blackwater or sludge. Its effect can be enhanced by ensuring complete mixing, a longer contact time and a higher dosage of caustic soda. The pH should be maintained above pH 12 for a minimum of 2 hours to ensure an adequate reduction of pathogens.

The Caustic Soda Treatment process should be undertaken as a batch process and can be used to treat both solid and liquid sludge. After treatment, pH decrease towards neutral usually within 24 hours. After neutralisation, the supernatant can be pumped off and safely infiltrated into a Soak Pit (D.10). Care should be taken in areas with high a groundwater table as the supernatant still contains nitrogen and phosphorous which can pollute water bodies. The treated solid fraction at the bottom may be applied as a soil amendment or dried and used as cover for sanitary landfills.

**Design Considerations:** Caustic Soda Treatment can either take place above ground in a separate tank or below ground. In areas with a high groundwater level or in flood prone areas it is recommended to always use above ground tanks. Separate tanks may be needed for the preparation of the soda solution slurry and for the post-neutralisation of the treated effluent respectively.

**Materials:** Caustic Soda Treatment needs a reactor vessel that can either be an above ground tank (between 1–30 m<sup>3</sup>) or a pit below ground with tarpaulin lining. An additional smaller container is needed for the preparation of the caustic soda solution (e.g. 200 L plastic drum). For an even distribution of caustic soda in the tank it is mixed into the sludge either manually or using a mixing pump. The type of pump required depends on the consistency of the sludge. A separate pump is needed for removing the treated effluent from the tank and a shovel or vacuum pump for the removal of solid material. In addition a water testing kit (particularly for pH, E.coli, total suspended solids and turbidity) is needed as well as personal protective equipment (PPE) including a mask, gloves, boots, an apron or safety suit. A steady supply of caustic soda is also required.

**Applicability:** Caustic Soda Treatment is particularly suitable for the rapid response phase due to its short treatment time, simple process and use of readily available materials. With trained and skilled staff, it allows for a safe, cost-effective and extremely fast treatment of faecal sludge.

**Operation and Maintenance:** Caustic Soda is corrosive due to its high alkalinity, therefore a regular maintenance of pumps is required. During storage, caustic soda must be kept dry at all times because it absorbs and reacts with water. Due to potential health risks when handling caustic soda (see below) skilled and trained personnel must follow respective health and safety protocols and wear proper PPE.

**Health and Safety:** Caustic Soda is corrosive to the skin, eyes and lungs. Adequate PPE must be worn when handling it to prevent irritation to eyes, skin, respiratory system, and gastrointestinal tract. The occupational

exposure limit for caustic soda is 2 mg per cubic meter for a 15-minute reference period. Washing with cold water is recommended for affected skin and eye areas followed by rinsing with borax-boric acid buffer solution. Medical attention should be sought. Protection from fire and moisture must be ensured. Caustic soda is an alkaline material which reacts strongly with moisture. Trained personnel must follow health and safety protocols.

**Costs:** Caustic Soda Treatment is a relatively cheap treatment option. In general, caustic soda is twice as expensive on the market as lime (S.17). Costs may vary depending on the availability and costs of local materials and chemicals/soda. As part of a proper health risk management, costs for PPE and respective trainings for staff need to be considered.

**Social Considerations:** Proper health and safety protocols should be in place and include the provision of PPE and respective trainings for involved staff.

#### **Strengths and Weaknesses:**

- ⊕ Short treatment time (6 log removal of E-coli in < 1day i.e. pathogen count is 1 million times smaller)
- ⊕ Simple process which uses a material that is available in most countries
- ⊕ For liquid sludge, a sanitised and stabilised effluent is created suitable for soil infiltration
- ⊖ Mixing is essential for the process
- ⊖ Highly-alkaline sludge and effluent created – requires subsequent neutralisation
- ⊖ Potential health risks if not handled or stored properly

→ **References and further reading material for this technology can be found on page 192**

# Conveyance

This section describes technologies which can be used to convey products from the user interface (U) or on-site collection and storage/treatment (S) facilities to subsequent (semi-) centralised treatment (T) or use and/or disposal (D) technologies. The conveyance technologies are either sewer-based (C.3–C.5), container-based, motorised or human-powered (C.1, C.2, C.6).

|     |                                  |
|-----|----------------------------------|
| C.1 | Manual Emptying and Transport    |
| C.2 | Motorised Emptying and Transport |
| C.3 | Simplified Sewerage              |
| C.4 | Conventional Gravity Sewer       |
| C.5 | Stormwater Drainage              |
| C.6 | Transfer Station and Storage     |

The choice of conveyance technology is contextual and generally depends on the following factors:

- Type and quantity of products to be transported
- Distance to cover
- Accessibility
- Topography
- Soil and groundwater characteristics
- Financial resources available
- Availability of a service provider
- Management considerations
- Local capacity

C

# Manual Emptying and Transport

| Phase of Emergency   | Application Level / Scale  | Management Level  | Objectives / Key Features                       |
|--|--|---|---|
| <ul style="list-style-type: none"> <li>★★ Acute Response</li> <li>★★ Stabilisation</li> <li>★★ Recovery</li> </ul> | <ul style="list-style-type: none"> <li>★★ Household</li> <li>★★ Neighbourhood</li> <li>City</li> </ul> | <ul style="list-style-type: none"> <li>★ Household</li> <li>★★ Shared</li> <li>★★ Public</li> </ul>           | Emptying and transport where access is an issue |
| Space Required   | Technical Complexity   | Inputs / Outputs  |   |
| <ul style="list-style-type: none"> <li>★ Little</li> </ul>   | <ul style="list-style-type: none"> <li>★ Low</li> </ul>  | <ul style="list-style-type: none"> <li>● Sludge, ● Blackwater, ● Effluent, ● Urine, ● Stored Urine</li> </ul> |   |

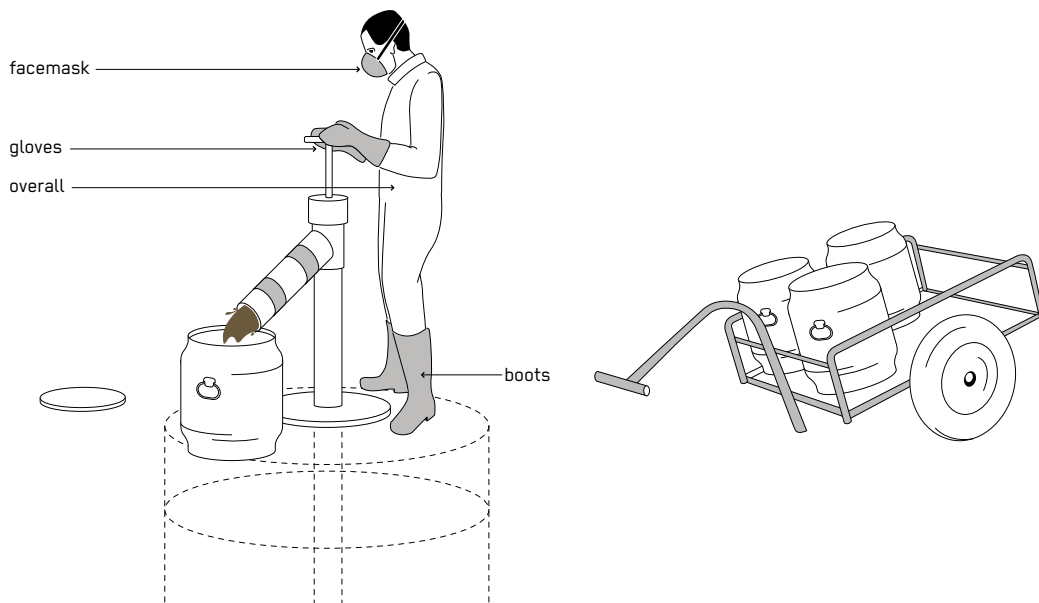

Manual Emptying and Transport refers to the different ways in which sludge and solid products generated at on-site collection and storage/treatment facilities can be manually removed and transported to treatment or disposal sites.

In some situations, collection and storage/treatment facilities can only be emptied manually. The manual emptying of latrine pits, vaults and tanks can be done in one of two ways: (1) using buckets and shovels, or (2) using a portable, manually operated hand pump specially designed for sludge (e.g. Gulper, Rammer, Manual Desludging Hand Pump or Manual Pit Emptying Technology (MAPET)). If the material is solid and cannot be removed through pumping, emptying must be carried out using a shovel and bucket. If the sludge is viscous or watery it should be emptied with a hand pump or a vacuum truck, and not buckets, due to the high risk of collapsing pits, toxic fumes, and exposure to unsanitised sludge.

**Design Considerations:** Sludge hand pumps, such as the Gulper, work on the same concept as water hand pumps: the bottom of the pipe is lowered into the pit/tank while the operator remains at the surface. As the operator pushes and pulls the handle, the sludge is pumped up and is then discharged through the discharge spout. The sludge can be collected in barrels, bags or carts, and removed from the site with little danger to the operator. Alternatively, a MAPET consists of a manually operated pump connected to a vacuum tank mounted on a push-cart for transportation. A hose is connected to the tank and is used to suck sludge from the pit. When the wheel of the hand pump is turned, air is sucked out of the vacuum tank and sludge is sucked up into the tank. Depending on the consistency of the sludge, the MAPET can pump up to a depth of 3m.

**Materials:** In principle, hand pumps and hand carts can often be constructed using locally available material such as steel and PVC pipes. Prefabrication is also possible. For some pumps, additional piping is needed. Other tools such as buckets and shovels should be available locally.

**Applicability:** Manual Emptying and Transport is viable in all phases of emergencies and appropriate for areas that are either not accessible by motorised vacuum trucks, or where vacuum truck emptying is too costly. The method is suitable for dense, urban and informal settlements, although the type and size of transport vehicle determines the feasible distance to the discharge point. In some cases, sludge may be too thick to pump and it may have to be fluidised with water so that it flows more easily. However, this increases the volume to be transported and may be inefficient and costly. Solid waste and sand that enters the pit or vault will make emptying more difficult and may clog pipes or pumps. The hand pump is a significant improvement over emptying with a bucket and shovel (e.g. time efficiency and reduced risk of exposure) and could prove to be a sustainable business opportunity in some regions. The technology is more feasible where a Transfer Station (C.6) is nearby. One difficulty is that pumps are often not readily available on the market, so local technicians must be trained in their manufacture before any units are available.

**Operation and Maintenance:** Chemicals or oil are commonly added during pit emptying to reduce odours. This is not recommended. It can cause difficulties in the subsequent treatment, additional health threats to the workers, environmental pollution and corrosion to the pumps and holding tanks. Hand pumps are unlikely to suffice to empty an entire pit and therefore, emptying may be required more frequently depending on the collection and storage technology used. Hand pumps and hand carts require daily maintenance (cleaning, repairing and disinfection). The pumps can be built and repaired with locally available material. If well maintained and constructed, they are usable for many years.

**Health and Safety:** The most important aspect of manual emptying is ensuring that workers are equipped with personal protective equipment like gloves, boots, overalls and facemasks. Regular medical exams and vaccinations should be required for everyone working with sludge.

**Costs:** The capital costs for Manual Emptying and Transport are low. Operational costs are variable and depend on the fee for the workers. Additional costs need to be considered for daily cleaning and maintenance of equipment.

**Social Considerations:** Manual Emptying might not be a socially acceptable form of employment within the community. Additionally, spillage and odour may further hinder acceptance. This can be overcome if the service is properly formalised, with adequate training and equipment. If putting solid waste in the pits is a common practice it should be addressed as part of hygiene promotion or other awareness raising activities (X.12).

**Strengths and Weaknesses:**

- ⊕ Provides services to communities without sewers and where access is difficult
- ⊕ Low capital costs; variable operating costs depending on transport distance
- ⊕ Simple hand pumps can be built and repaired with locally available materials
- ⊕ Potential for local job creation and income generation
- ⊖ Manual Emptying exposes workers to serious health risks
- ⊖ Emptying pits can take several hours or days depending on pit size
- ⊖ Solid waste in pits may block pipes and damage pumps
- ⊖ Some devices may require specialised repair (welding)

→ **References and further reading material for this technology can be found on page 192**

# Motorised Emptying and Transport

| Phase of Emergency                                   | Application Level / Scale                  | Management Level  | Objectives / Key Features                      |
|--|--|---|--|
| ** Acute Response<br>** Stabilisation<br>** Recovery | ** Household<br>** Neighbourhood<br>* City | Household<br>* Shared<br>** Public                          | Emptying and transport, Efficiency of emptying |
| Space Required                                       | Technical Complexity                       | Inputs / Outputs  |  |
| ** Medium  | ** Medium                                  | ● Sludge, ● Blackwater, ● Effluent, ● Urine, ● Stored Urine |  |

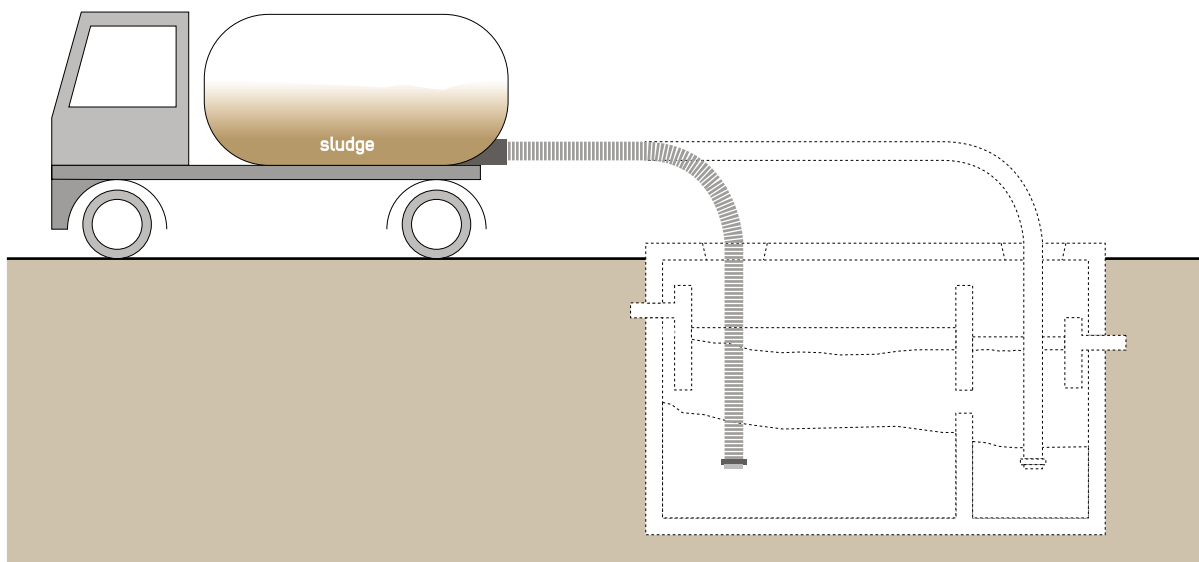

Motorised Emptying and Transport refers to a vehicle equipped with a motorised pump and storage tank for emptying and transporting faecal sludge, septage, wastewater and/or urine. Service technicians are required to operate the pump and the hose. The sludge is not manually lifted or transported.

A truck, or a tractor with a tank on a trailer, is fitted with a pump connected to a hose that is lowered into a tank (e.g. S.13–S.15) or pit (e.g. S.1–S.4), and the sludge is pumped into the holding tank on the vehicle. This type is often referred to as a vacuum truck. Alternative motorised vehicles or machines have been developed for densely populated areas with limited access. Designs such as the Vacutug or ROM desludging units carry a small sludge tank and pump and can navigate narrow pathways.

**Design Considerations:** Generally, storage capacity of a vacuum truck is between 3 to 12 m<sup>3</sup>. Local trucks are commonly adapted for sludge transport by equipping them with holding tanks and pumps. Modified pick-up trucks and tractor trailers can transport around 1.5 m<sup>3</sup>, but capacities vary. Smaller vehicles for densely populated areas have capacities of between 500 to 800 L. These vehicles use, for example, two-wheeled tractor or motorcycle engines and can reach speeds of up to 12 km/h. Some are equipped with an integrated high-pressure pump for fluidising sludge. Pumps are usually effective to a depth of 2 to 3 m (depending on the strength of the pump) and must be located within 30 m of the pit. In general, the closer the vacuum pump is to the pit, the easier the pit is to empty.



**Materials:** The required materials – a vehicle, a tank and a pump – are usually available locally. Second-hand trucks are often used, which can reduce costs but often also reduce efficiency. Fuel is needed to operate the pump and the vehicle; a fuel shortage can be a limiting factor during an emergency.

**Applicability:** Motorised Emptying and Transport is possible in areas accessible to vehicles, and in all phases of an emergency. High faecal sludge density may hinder pumping. In such situations, it is necessary to fluidise the solids with jets of water to improve the flow. Solid waste and sand mixed with the sludge can clog the pipe or pump. To minimise costs, the treatment site must be reasonably accessible to the serviced areas. Greater distances result in greater costs per trip. Transfer Stations (C.6) may be necessary when using small-scale motorised equipment. The costs of conveyance must be balanced to be affordable for users and to sufficiently cover operating costs. Effectiveness may be reduced by travel speed, and the ability of vehicles to negotiate slopes, poor roads and narrow lanes. Both sanitation authorities and private entrepreneurs can operate vacuum trucks. The price and level of service may vary significantly. All operators should be properly incentivised to discharge sludge at a certified facility. Private and public service providers should work together to cover the whole faecal sludge management chain.

**Operation and Maintenance:** Most pump trucks are manufactured in North America, Asia or Europe. Thus, in some regions it is difficult to locate spare parts and a mechanic to repair broken pumps or trucks. New trucks are expensive and sometimes difficult to obtain. Therefore, older trucks are often used, but savings are offset by high maintenance and fuel costs that can account for more than two thirds of total costs incurred by a truck operator. Truck owners should set aside some funds for repair and maintenance. Regular vehicle maintenance can prevent the need for major repairs. Additionally, solid waste in the pits can damage the pumps. Chemical additives for desludging can corrode the sludge tank and are therefore not recommended.

**Health and Safety:** The use of a vacuum truck presents a significant health improvement over manual emptying. Service personnel, however, do still come into contact

with faecal sludge and need to wear personal protective equipment. It is not uncommon for camps to become flooded which restricts access for emptying tanks; therefore, a backup or contingency plan should be in place to avoid serious health impacts.

**Costs:** Investing in a vacuum truck can be expensive, but also potentially lucrative for private entrepreneurs. The major operational cost is fuel. Fuel costs depend on the distance from the source to the discharge point or treatment facility. Operation and maintenance costs are usually included in the emptying fee that is paid by the customer (or responsible Government unit/humanitarian organisation) and directly impact the affordability of the service. Cost for spare parts may also be high and spare parts may not always be available in the local market.

**Social Considerations:** Truck operators can face difficulties such as not being well accepted in the community and finding appropriate locations to discharge the collected sludge. It is thus important to publicly recognise the importance of the sanitation transport service, and identify authorised discharge points (as well as prevent unauthorised discharges). If putting solid waste in the pits is a common practice it should be addressed as part of hygiene promotion or other awareness raising activities (X.12), and through a proper solid waste management scheme (X.8). If Motorised Emptying and Transport is considered as a longer-term solution without external assistance it should be kept in mind that hiring a vacuum truck may be unaffordable for poorer households.

**Strengths and Weaknesses:**

- ⊕ Fast, hygienic and generally effective sludge removal
- ⊕ Efficient transport possible with large vacuum trucks
- ⊕ Potential for local job creation and income generation
- ⊕ Provides an essential service to unsewered areas
- ⊖ Cannot pump thick, dried sludge  
(must be thinned with water or manually removed)
- ⊖ Cannot completely empty deep pits due to limited suction lift
- ⊖ Not all parts and materials may be locally available
- ⊖ May have difficulties with access

→ **References and further reading material for this technology can be found on page 193**

# Simplified Sewer

| Phase of Emergency                               | Application Level / Scale               | Management Level                      | Objectives / Key Features |
|--|---|---------------------------------------|---------------------------|
| Acute Response<br>* Stabilisation<br>** Recovery | Household<br>** Neighbourhood<br>* City | * Household<br>** Shared<br>** Public | Conveyance of wastewater  |
| Space Required                                   | Technical Complexity                    | Inputs / Outputs                      |                           |
| ** Medium  | ** Medium                               | ● Blackwater, ● Greywater, ● Effluent |                           |

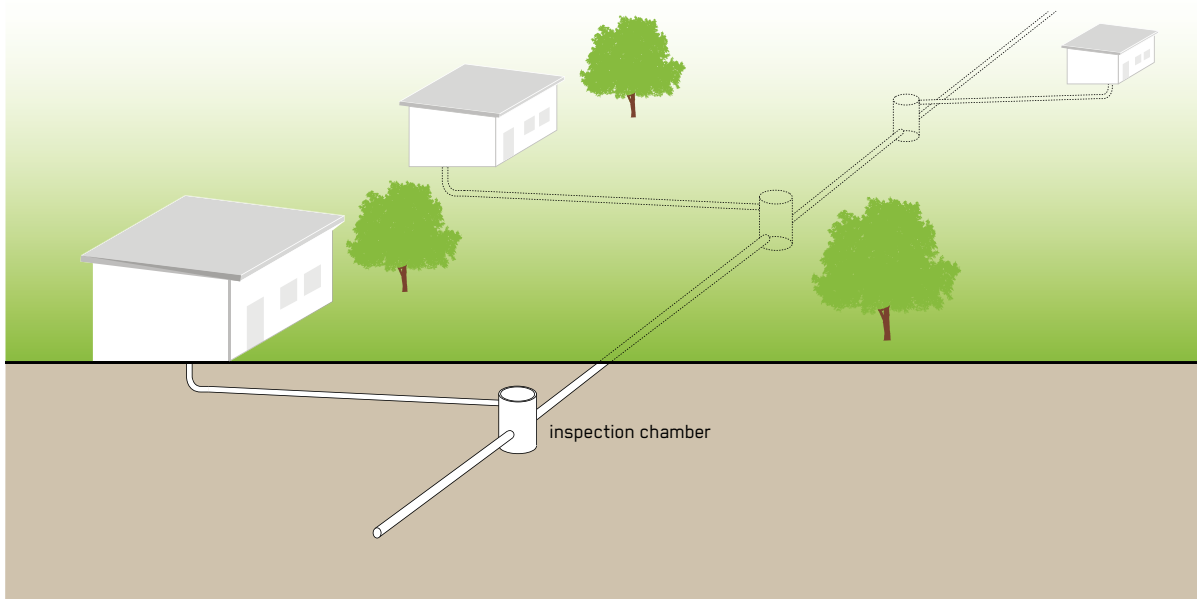

A Simplified Sewer is a sewerage network constructed using small diameter pipes laid at a shallower depth and at a flatter gradient than Conventional Gravity Sewers (C.4). The Simplified Sewer allows for a more flexible design at lower costs. It can be implemented at neighbourhood level.

Conceptually, a Simplified Sewer (also known as a communal sewer) is the same as a Conventional Gravity Sewer, but with less conservative design standards and with design features that are more adaptable to local situations. Rather than laying the pipes under central roads, they are usually laid under walkways, where they are not subjected to heavy traffic loads. This allows pipes to be laid shallower and thus less excavation is required and fewer and shorter pipes are needed.

**Design Considerations:** In contrast to Conventional Gravity Sewers that are designed to ensure a minimum self-cleansing velocity, the design of Simplified Sewers is based on a minimum tractive tension of  $1 \text{ N/m}^2$  (1 Pa) at peak flow. The minimum peak flow should be 1.5 L/s and a minimum sewer diameter of 100 mm is required. A gradient of 0.5% is usually sufficient. For example, a 100 mm diameter sewer laid at a gradient of 1 m in 200 m can serve around 2,800 users with a wastewater flow of around 60 L/person/day. The depth at which the sewers should be laid depends mainly on the amount of traffic on the ground above. Below sidewalks, covers of 40 to 65 cm are typical. The simplified design can also be applied to sewer mains; they can also be laid at a shallow depth, provided they are not placed underneath roads. At each junction or change in direction, simple inspection chambers (or cleanouts) are sufficient, instead of expensive manholes. Inspection boxes are also used at each house connection. Where kitchen greywater contains an appreciable

amount of oil and grease, the installation of grease traps is recommended to prevent clogging. Greywater should be discharged into the sewer to ensure an adequate wastewater flow, but stormwater connections should be discouraged. However, in practice it is difficult to exclude all stormwater flows, especially where there is no alternative for stormwater drainage. The design of the sewers (and treatment plant) should, therefore, account for the extra flow that may result from stormwater inflow.

**Materials:** PVC pipes are recommended for the Simplified Sewer. Inspection chambers can be constructed using bricks with mortared cover to avoid the influx of unwanted products, such as stormwater, soil or grit. Plastic junction boxes can be pre-fabricated. Concrete should not be used in simplified sewerage, as it will corrode quickly.

**Applicability:** Simplified Sewers can be installed in almost all types of settlements but are particularly appropriate in dense urban areas and camps where space for on-site systems is limited. They are also useful for the emergency repair of a damaged existing system or for rapid expansion, to meet the needs of a sudden population growth. They should be considered as an option where there is sufficient population density (minimum 150 people per hectare) and a reliable water supply (at least 60 L/person/day). If well-constructed and maintained, Simplified Sewers are a safe and hygienic means of transporting wastewater. Users must be well trained regarding health risks associated with removing blockages and maintaining inspection chambers.

**Operation and Maintenance:** Trained and responsible users are essential to ensure that the flow is undisturbed and to avoid clogging caused by trash and other solids. Occasional flushing of pipes is recommended to avoid blockages. Blockages can usually be removed by opening the cleanouts and forcing a rigid wire through the pipe. Inspection chambers must be periodically emptied to prevent grit overflowing into the system. Successful

operation requires clearly defined responsibilities between service provider and users. Private contractors or user committees can be hired to do the maintenance.

**Costs:** Simplified Sewerage is between 20 and 50% less expensive than Conventional Gravity Sewerage. Household connections are expensive and often not budgeted for when planning sewers. For Simplified Sewers, household connections include the last 1–10 meters of pipe, excavation, an inspection chamber and other on-site sanitary installations. A Simplified Sewer requires skilled technicians available at any time for operation and maintenance including replacement of pipes, removal of blockages and monitoring inspection chambers.

**Software Considerations:** Simplified Sewers require correct use by users. A common challenge encountered are blockages of the sewer caused by solid waste being put into the system. User training, in combination with solid waste management (X.8) can help to overcome this challenge.

#### Strengths and Weaknesses:

- ⊕ Can be laid at a shallower depth and flatter gradient than Conventional Sewers
- ⊕ Lower capital costs than Conventional Sewers; low operating costs
- ⊕ Can be extended as a community grows
- ⊕ Greywater can be managed concurrently with blackwater
- ⊖ Requires repairs and removals of blockages more frequently than a Conventional Sewer
- ⊖ Requires expert design and construction
- ⊖ Leakages pose a risk of wastewater exfiltration and groundwater infiltration and are difficult to identify

→ **References and further reading material for this technology can be found on page 193**

# Conventional Gravity Sewer

| Phase of Emergency                               | Application Level / Scale               | Management Level                        | Objectives / Key Features               |
|--|---|---|---|
| Acute Response<br>★ Stabilisation<br>★★ Recovery | Household<br>★ Neighbourhood<br>★★ City | Household<br>Shared<br>★★ Public        | Conveyance of wastewater and stormwater |
| Space Required                                   | Technical Complexity                    | Inputs / Outputs                        |   |
| ★★ Medium  | ★★★ High                                | ● Blackwater, ● Greywater, ● Stormwater |   |

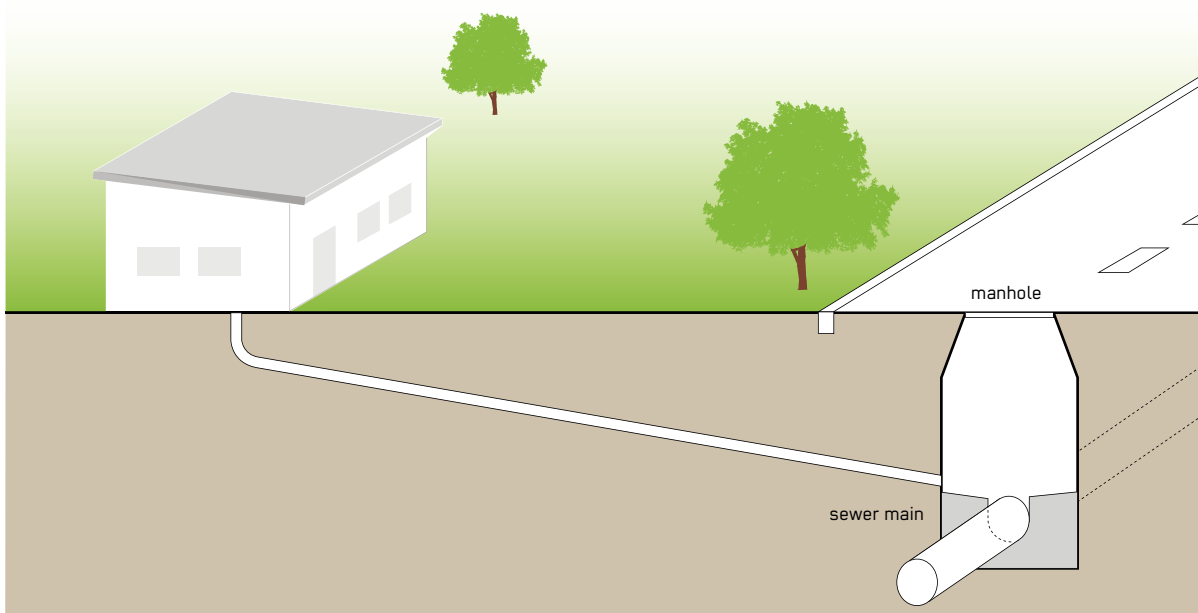

Conventional Gravity Sewers are networks of underground pipes that convey blackwater, greywater and, in many cases, stormwater from individual households to a (semi-) centralised treatment facility, using gravity and pumps where necessary.

The Conventional Gravity Sewer system is designed with many branches. Typically, the network is subdivided into primary (main sewer lines along main roads), secondary and tertiary networks (networks at the neighborhood and household level).

**Design Considerations:** Conventional Gravity Sewers normally do not require on-site pre-treatment, primary treatment or storage of household wastewater. The sewer must be designed, however, so that it maintains a self-cleansing velocity (i.e., a flow that will not allow particles to accumulate). For typical sewer diameters, a minimum velocity of between 0.6 to 0.7 m/s during peak

dry weather conditions should be adopted. This requires a daily water consumption rate of more than 100 L per person per day. A constant downhill gradient must be guaranteed along the sewer length to maintain self-cleansing flows, which can require deep excavations. When a gradient cannot be maintained, a pumping station must be installed. Primary sewers are laid beneath roads, at depths between 1.5 to 3 m to avoid damages caused by traffic loads. The depth also depends on the groundwater table, the lowest point to be served (e.g. a basement) and the topography. The selection of the pipe diameter depends on projected average and peak flows. Access manholes are placed at set intervals above the sewer, at pipe intersections and at changes in pipeline direction (vertically and horizontally). Manholes should be designed to ensure that they do not become a source of stormwater inflow or groundwater infiltration. In the case that connected users discharge highly polluted wastewater (e.g. from industry or restaurants), on-site pre- and primary treatment may

be required before discharge into the sewer system to reduce the risk of clogging and the load of wastewater to the treatment plant. When the sewer carries stormwater (known then as a combined sewer), overflows are required to avoid hydraulic surcharge of treatment plants during rain events. However, combined sewers are no longer be considered state of the art. Rather, local retention and infiltration of stormwater or a separate drainage system for rainwater is recommended. The wastewater treatment system then requires smaller dimensions and is, therefore, cheaper to build, and has a higher treatment efficiency for less diluted wastewater.

**Materials:** Commonly used materials are concrete, PVC, vitrified clay and ductile or cast-iron pipes. Excavation requires an excavator or numerous workers with shovels, depending on soil properties.

**Applicability:** Sewers in the humanitarian context are usually applicable where sewers are already existing and can be rehabilitated, for example in host communities. Furthermore, the construction of a new sewer line can be part of recovery actions. As they can be designed to carry large volumes, Conventional Gravity Sewers are very appropriate to transport wastewater to a (semi-)centralised treatment facility. Planning, construction, operation and maintenance requires expert knowledge. Construction of conventional sewer systems in dense, urban areas is complicated as it disrupts urban activities and traffic. Conventional Gravity Sewers are expensive to build and, because the installation of a sewer line is disruptive and requires extensive coordination between authorities, construction companies and property owners, a professional management system must be in place. Ground shifting may cause cracks in manhole walls or pipe joints, which may become a source of groundwater infiltration or wastewater exfiltration, and compromise the performance of the sewer. Conventional Gravity Sewers can be constructed in cold climates as they are dug deep into the ground and the large and constant water flow resists freezing.

**Operation and Maintenance:** Manholes are used for routine inspection and sewer cleaning. Debris (e.g. grit, sticks or rags) may accumulate in manholes and block the lines. To avoid clogging caused by grease, it is important to inform users about proper oil and grease disposal. Common cleaning methods for Conventional Gravity Sewers include rodding, flushing, jetting and bailing. Sewers can be dangerous because of toxic gases and should be maintained only by professionals, although, in well-organised communities, maintenance of tertiary networks might be handed over to a well-trained group of community members. Proper personal protective equipment should always be used when entering a sewer.

**Costs:** Conventional Gravity Sewers have very high capital as well as operation and maintenance (O&M) costs. Conventional Gravity Sewer O&M is constant and labor intensive. The costs of household sewer connections must be included in the total cost calculations.

**Social Considerations:** If well-constructed and maintained, Conventional Gravity Sewers are a safe and hygienic means of transporting wastewater. This technology provides a high level of hygiene and comfort for the user. However, because the waste is conveyed to an offsite location for treatment, the ultimate health and environmental impacts are determined by the treatment provided by the downstream facility.

**Strengths and Weaknesses:**

- ⊕ Greywater and possibly stormwater can be managed concurrently
- ⊕ Can handle grit and other solids, as well as large volumes of flow
- ⊖ Very high capital costs; high O&M costs
- ⊖ A minimum velocity must be maintained to prevent the deposition of solids in the sewer
- ⊖ Difficult and costly to extend as a community changes and grows
- ⊖ Requires expert design, construction and maintenance

→ **References and further reading material for this technology can be found on page 193**

# Stormwater Drainage

| Phase of Emergency                               | Application Level / Scale                  | Management Level                     | Objectives / Key Features |
|--|--|--------------------------------------|---------------------------|
| Acute Response<br>★ Stabilisation<br>★★ Recovery | ★ Household<br>★★ Neighbourhood<br>★★ City | ★ Household<br>★ Shared<br>★★ Public | Conveyance of stormwater  |
| Space Required                                   | Technical Complexity                       | Inputs / Outputs                     |                           |
| ★★ Medium  | ★★ Medium                                  | ● Greywater, ● Stormwater            |                           |

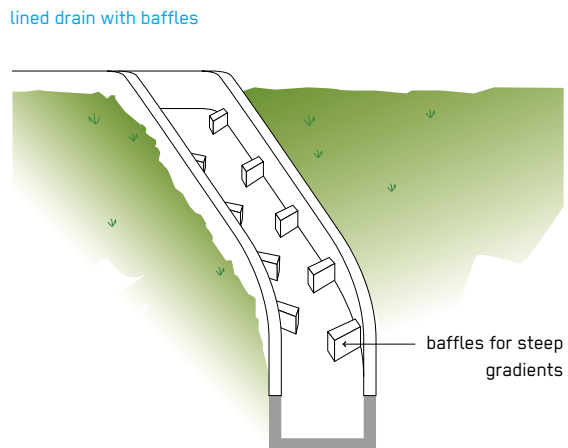
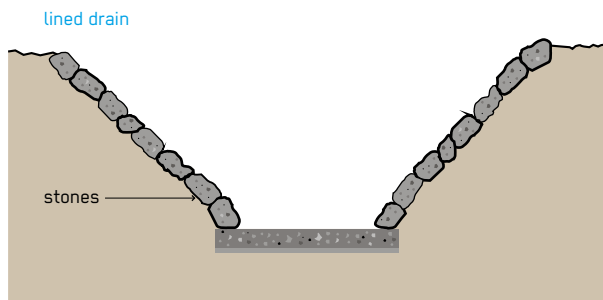
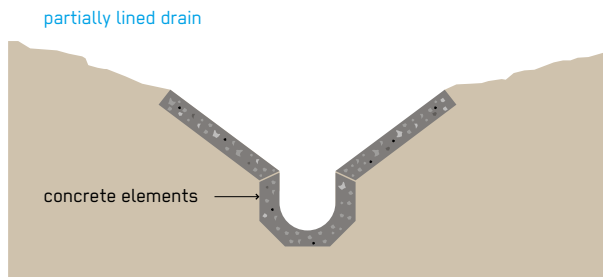

By draining residential and other populated areas, Stormwater Drainage helps to prevent flooding and pooling of water. Avoiding stagnant water can help prevent the spread of disease and prevent the creation of a muddy environment.

Standing water, erosion and muddy conditions can pose public health risks, especially during humanitarian emergencies. This water can come from rainfall run-off, called stormwater, or from settlements and households, called greywater. Where stormwater is not drained from urban areas by a Conventional Gravity Sewer (C.4), other means of management are needed. Stormwater Drainage is of special importance in camps and urban areas, where natural run-off of water is reduced due to surfaces sealed by roads, houses and other paved areas. Constructing stormwater channels for drainage can be challenging in areas with flat terrain due to the lack of gradient, as well as in steep areas, where run-off velocities become high

and difficult to control. Stormwater channels can drain directly into a receiving water body, such as a river or a lake. The minimum implementation of Stormwater Drainage in the acute phase of an emergency should be to protect wells, latrines and other water, sanitation and hygiene facilities of primary interest from flooding. Although this chapter focuses on stormwater channels, there are other means to prevent standing water, e.g. by minimising impervious cover and by using natural or constructed systems to filter and recharge stormwater into the ground. Such systems include designated flooding areas, local infiltration surfaces, such as infiltration trenches, grass filters, retention ponds and others, as well as careful land use management plans. Wherever ground conditions allow, drainage can be done on-site, where greywater is produced.

**Design Considerations:** Design of Stormwater Drainage needs to be done by a skilled and experienced engineer. Detailed information on terrain, land use, slope and rain events is needed. To design stormwater channels, the runoff coefficient of an area needs to be known, indicating the percentage of rainwater that actually runs off and does not infiltrate locally or evaporate. This coefficient depends mainly on soil conditions, land use and terrain. The slope will indicate how fast water will runoff. If possible streets and access roads need to be planned to have stormwater channels along them. Stormwater channels should always be constructed below the housing level, to reduce the risk of residential flooding. To control water on steep slopes (with more than 5% gradient), different systems such as baffles, steps or check walls can be implemented in the stormwater channels. Stormwater channels can be covered or open. Closed channels have the advantages that the space above them can be used and solid waste is prevented from entering from above. Disadvantages of closed channels include more failures due to more difficult operation and maintenance, for example removal of blockages, as well as being more costly. Channels can be built lined or unlined depending on the requirements and size of the channel.

**Materials:** For lined stormwater channels, lining materials are needed. These can be prefabricated drain elements, cement or local materials such as wood. For unlined channels the ground can be reinforced with chicken wire and plants. Basic tools are needed for cleaning secondary channels, such as shovels and rakes.

**Applicability:** Stormwater drainage can be implemented in areas with regular flooding and/or greywater production and where there is no conventional sewerage. Informal settlements and camps are often built in unfavourable geographical settings and may be particularly susceptible to risks associated with stormwater (i.e. flooding). If an area can be developed before residents move in, proper stormwater management should be planned beforehand.

**Operation and Maintenance:** Solid waste must be removed from stormwater channels on a regular basis and particularly before the start of a rainy season or expected rainfall events to assure proper functioning. After the rains it may be necessary to empty sediments from a channel, after the water flow has decreased below the self-cleansing velocity. Structural damages also need to be tended to on a regular basis. These can occur especially in channels with high gradients and runoff velocities.

**Costs:** Channel construction requires labour-intensive excavation work and subsequent transport of soil. For small neighbourhood channels this can be done by the community. Channel lining material is another high-cost item. Secondary channels can often be built with local materials and the help of communities, while bigger primary channels require lining materials and often machines for excavation.

**Social Considerations:** One of the main challenges for Stormwater Drainage is that it is open to abuse by people, for example by throwing solid waste into the channels or by disposing of faecally contaminated water into the drain. To prevent this, the correct use of a Stormwater Drainage system needs to be part of community hygiene behaviour promotion activities (X.12). Also necessary are a functioning solid waste management system (X.8) and measures to ensure complete toilet disconnection from the Stormwater Drainage system.

**Strengths and Weaknesses:**

- ⊕ Can be built with local materials
- ⊕ Allows safe drainage of stormwater
- ⊕ Reduces risk of flooding
- ⊖ Requires appropriate terrain and land management
- ⊖ Prone to failure due to misuse
- ⊖ Source of mosquito breeding if mismanaged

→ **References and further reading material for this technology can be found on page 193**

# Transfer Station and Storage

| Phase of Emergency                                 | Application Level / Scale                | Management Level                   | Objectives / Key Features                       |
|--|--|------------------------------------|---|
| ★ Acute Response<br>★ Stabilisation<br>★★ Recovery | Household<br>★★ Neighbourhood<br>★★ City | Household<br>★ Shared<br>★★ Public | Interface between manual and motorised emptying |
| Space Required                                     | Technical Complexity                     | Inputs / Outputs                   |   |
| ★★ Medium  | ★★ Medium                                | ● Sludge                           |   |

transfer station

bladder

mobile transfer station

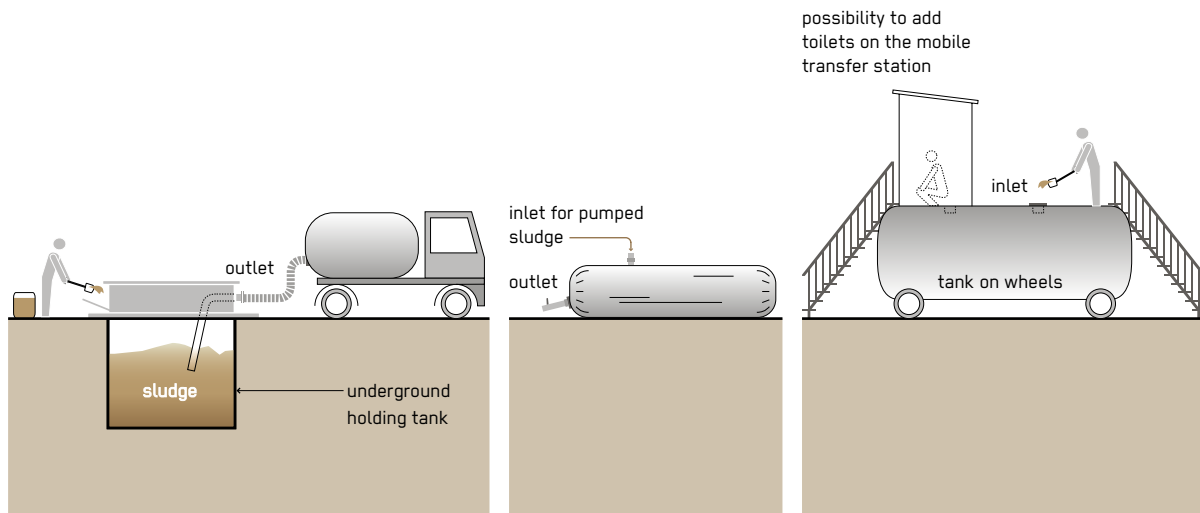

Intermediate semi-centralised storage facilities such as Transfer Stations, bladders or sewer discharge stations are required when faecal sludge cannot be easily transported immediately to a final treatment facility. Motorised Emptying and Transport (C.2), for example by a vacuum truck, is required to empty transfer stations when they are full.

Operators of manual or small-scale motorised sludge emptying equipment should discharge sludge at intermediate storage facilities rather than illegally dumping it or travelling to discharge it at a remote treatment or disposal site. When the storage facility is full, Motorised Emptying and Transport (C.2) can remove the contents and take the sludge to a suitable treatment facility. Municipalities or sewerage authorities may charge for permits to dump at the facilities to offset the operation and maintenance costs of the facility. In urban settings, facilities must be carefully located, as odours can become a nuisance, especially if facilities are not well maintained.

**Design Considerations:** Different types of intermediate storage facilities exist, such as Transfer Stations, sewer discharge stations (SDS) or bladders with different designs and purposes. There are two types of Transfer Stations: fixed and mobile. A fixed Transfer Station, also called an underground holding tank, consists of a parking place for vacuum trucks or sludge carts, a connection point for discharge hoses, and a fixed storage tank. The dumping point should be built low enough to minimise spills when labourers manually empty their sludge carts. The Transfer Station should include a vent, a trash screen (PRE) to remove large debris (solid waste) and a washing facility for disinfecting vessels and vehicles. The holding tank must be well constructed to prevent leaching and/or surface water infiltration. A mobile Transfer Station consists of transportable containers for intermediate storage, basically a tank on wheels. To further minimise transport needs, toilets can be constructed directly above the tank. A variation is the SDS, which is directly connected to a Conventional Gravity Sewer (C.4) main. Sludge emptied



into the SDS is released into the sewer main either directly or at timed intervals (e.g. by pumping) to optimise performance of sewer and wastewater treatment plant, and/or reduce peak loads. Transfer Stations can be equipped with digital data recording devices to track quantity, input type and origin, as well as collect data about individuals who dump there. In this way, the operator can collect detailed information and more accurately plan and adapt to differing loads. Bladders are robust bags that can be filled with any form of liquid, including faecal sludge. Bladders can be placed in any flat terrain. They can be placed on a truck before they fill up and transported after filling. A bladder is very small when empty and therefore easily deployable during an emergency.

**Materials:** Intermediate storage facilities must be sealed. They can be constructed with sealed bricks or cement. For mobile Transfer Stations a container or tank is needed, ideally already mounted on a vehicle. Bladders are prefabricated flexible containers and usually made out of butyl rubber fabric or fabric reinforced plastic.

**Applicability:** Transfer Stations are appropriate for dense, urban areas where there are no alternative discharge points for faecal sludge, as well as for camp settings that are situated away from a suitable treatment facility. Establishing multiple Transfer Stations may help to reduce the incidence of illegal sludge dumping and promote the market for appropriate sludge disposal. They are especially appropriate where small-scale sludge emptying takes place. Local service providers can discharge sludge at Transfer Stations during the day, while large trucks can empty tanks and go to the treatment plant at night when traffic is light. Transfer Stations should be located where they are easily accessible, convenient, and easy to use. Depending on their maintenance, odours can become a problem to local residents. However, the communal benefits gained from them compared to open-air illegal dumping greatly offset any local nuisances. During the acute emergency phase, until there is a more appropriate solution it is possible to use bladders or other small storage units.

**Operation and Maintenance:** Screens at the inlet must be frequently cleaned to ensure a constant flow and prevent back-ups. Sand, grit and consolidated sludge must also be periodically removed from the holding tank. There should be a well-organised system to empty the holding tank. The loading area should be regularly cleaned to minimise odours, flies and other vectors from becoming nuisances.

**Costs:** In big cities, Transfer Stations can reduce costs incurred by truck operators by decreasing transport distances and waiting times in traffic jams. Capital costs for implementing this technology are low to moderate, however, operational costs and respective cost-recovery mechanisms, such as fees, need to be considered. The system for issuing permits or charging access fees must be carefully designed so that those who most need the service are not excluded due to high costs, while still generating enough income to sustainably operate and maintain the Transfer Stations.

**Social Considerations:** Transfer Stations provide an inexpensive, local solution for intermediate faecal sludge storage. By providing a Transfer Station, independent or small-scale service providers are no longer forced to illegally dump sludge, and homeowners are more motivated to empty their pits or tanks. When pits are regularly emptied and illegal dumping is minimised, the overall health of a community can be significantly improved. The location must be carefully chosen to maximise efficiency and minimise odours and problems to nearby residents.

**Strengths and Weaknesses:**

- ⊕ Makes sludge transport to treatment plant more efficient
- ⊕ May reduce illegal dumping of faecal sludge
- ⊕ Potential for local job creation and income generation
- ⊖ Requires expert design and construction
- ⊖ Can lead to odours if not properly maintained

→ **References and further reading material for this technology can be found on page 193**

# (Semi-) Centralised Treatment

This section describes wastewater and faecal sludge treatment technologies generally appropriate for large user groups (i.e. from semi-centralised applications at the neighbourhood level to centralised, city level applications). These are designed to accommodate high flow volumes and provide, in most cases, improved removal of nutrients, organics and pathogens, especially when compared with collection and storage/treatment technologies (S). However, the operation, maintenance, and energy requirements of the technologies within this functional group are generally higher than for smaller-scale technologies. In addition, technologies for pre-treatment and post-treatment are described, even though they are not always required.

|     |                            |      |   |
|-----|----------------------------|------|---|
| PRE | Pre-Treatment Technologies | T.8  | Sedimentation and Thickening Ponds                        |
| T.1 | Settler                    | T.9  | Unplanted Drying Bed                                      |
| T.2 | Anaerobic Baffled Reactor  | T.10 | Planted Drying Bed  |
| T.3 | Anaerobic Filter           | T.11 | Co-Composting   |
| T.4 | Biogas Reactor             | T.12 | Vermicomposting and Vermifiltration (Emerging Technology) |
| T.5 | Waste Stabilisation Ponds  | T.13 | Activated Sludge  |
| T.6 | Constructed Wetland        | POST | Tertiary Filtration and Disinfection                      |
| T.7 | Trickling Filter           |      |   |

Achieving the desired overall objective of a (semi-) centralised treatment scheme (e.g. a multiple-stage configuration for pre-treatment, primary treatment and secondary treatment) requires a design which combines logically different technologies from the list above.

The choice of (semi-) centralised treatment technology is contextual, and generally depends on the following factors:

- Type and quantity of products to be treated (including future developments)
- Desired output product (end-use and/or legal quality requirements)
- Financial resources
- Local availability of materials
- Availability of space
- Soil and groundwater characteristics
- Availability of a constant source of electricity
- Skills and capacity (for design, operation, maintenance and management)
- Management considerations
- Local capacity



# Pre-Treatment Technologies

| Phase of Emergency                               | Application Level / Scale                  | Management Level                     | Objectives / Key Features  |
|--|--|--------------------------------------|--|
| Acute Response<br>★ Stabilisation<br>★★ Recovery | ★ Household<br>★★ Neighbourhood<br>★★ City | ★ Household<br>★ Shared<br>★★ Public | Ensuring durability and proper functioning of subsequent systems |
| Space Required                                   | Technical Complexity                       | Inputs                               | Outputs  |
| ★ Little   | ★★ Medium                                  | ● Blackwater, ● Greywater, ● Sludge  | ● Blackwater, ● Greywater, ● Sludge,<br>● Pre-Treatment Products |

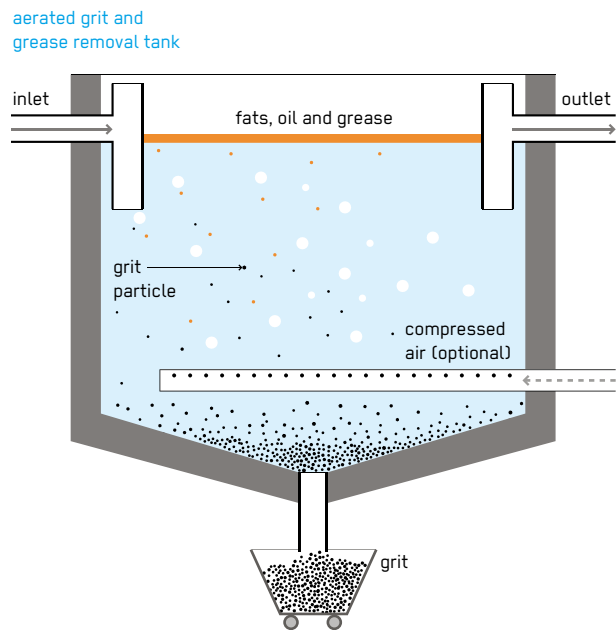
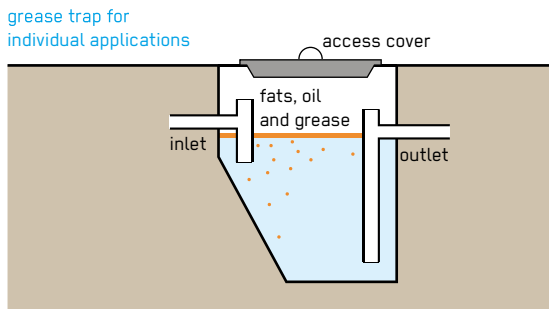
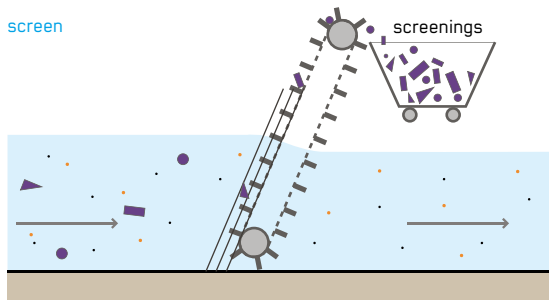

Pre-Treatment is the preliminary removal of wastewater or sludge components, such as oil, grease, and solid material. Sequenced before a conveyance or (semi-) centralised treatment technology or pump, Pre-Treatment units can prevent the accumulation of solids and minimise subsequent blockages, help reduce abrasion of mechanical parts and extend the life of sanitation infrastructure.

Oil, grease, sand and suspended solids can impair transport and/or treatment efficiency through clogging and wear. It is therefore crucial to prevent these from entering the system and early removal of this material that does enter the system is essential for its durability. Preventive measures at individual level (source control) and along conveyance systems are important. For example, sewer inspection chambers should always be closed with manhole covers to prevent extraneous material from entering the sewer. Pre-Treatment Technologies are generally installed at the point where wastewater enters a treatment

plant or leaves larger institutions. These technologies use physical removal mechanisms, such as screening, flotation, settling and filtration.

**Design Considerations: Screen** Screening aims to prevent coarse solid waste, such as plastics and other trash, from entering a sewer or treatment plant. Solids are usually trapped by inclined screens or bar racks. Spacing between the bars is usually 1.5 to 4 cm, depending on cleaning patterns. Screens can be cleaned by hand or mechanically raked. The latter allows for a more frequent solids removal and, correspondingly, a smaller design.

**Grease Trap** These trap oil and grease for easy collection and removal. Grease traps are chambers made of either brickwork, concrete or plastic, with an odour-tight cover. Baffles or tees at the inlet and outlet prevent turbulence at the water surface and separate floating components from effluent. A grease trap can either be located directly under the household sinks, or, for larger amounts of oil

and grease, a grease interceptor can be installed outdoors. If designed large enough, grease traps can also remove grit and other settleable solids through sedimentation, similar to Septic Tanks **(S.13)**.

**Grit Chamber** Where subsequent treatment steps could be hindered or damaged by sand in the wastewater, grit chambers or sand traps allow for the removal of such heavy inorganic materials by settling them out. There are three general types of grit chambers: horizontal-flow, aerated, and vortex chambers. All of these designs allow heavy grit particles to settle out, while lighter, principally organic particles remain in suspension.

**Materials:** Screens, grease traps and grit chambers can all be built with locally available materials, such as concrete and metal bars. The last two are also available as prefabricated units, or can be made out of prefabricated containers. For automatic screens electricity is required. Tools to de-scum, desludge and to remove solid waste are needed, including personal protective equipment for the workers performing these tasks.

**Applicability:** Grease traps should be applied where considerable amounts of oil and grease are discharged (e.g. restaurants, canteens). Grease removal is especially important where there is an immediate risk of clogging, e.g. greywater treatment in Constructed Wetlands **(T.6)**. Screening is essential to prevent solid wastes from entering sewer systems and treatment plants. Trash traps, e.g., mesh boxes, can be applied at strategic locations such as market drains. A grit chamber is especially recommended where roads are not paved and/or stormwater may enter the sewer system, and in sandy environments.

**Operation and Maintenance:** Pre-Treatment products separated from wastewater or sludge should be removed regularly, with a frequency depending on the accumulation rate. For screens, removal should be done at least every day. An under-the-sink grease trap must be cleaned often (once a week to once a month), whereas a larger grease interceptor is designed to be pumped out every 6–12 months. As for grit chambers, special care should be taken after rainfall. If maintenance is too infrequent, strong odours can result from the degradation of accumulated material. Insufficiently maintained pre-treatment units can eventually lead to the failure of downstream

elements of a sanitation system (especially through clogging). The Pre-Treatment products should be disposed of as solid waste in an environmentally sound way. If no solid waste management infrastructure **(X.8)** exists, the solid wastes should be buried.

**Health and Safety:** People involved in Pre-Treatment may come into contact with pathogens or toxic substances; therefore, adequate protection with proper personal equipment, i.e. boots and gloves, is essential, as is safe disposal to prevent the local population from coming into contact with the solid wastes.

**Costs:** The capital and operating costs of Pre-Treatment Technologies are relatively low. The costs of a constant electrical supply have to be considered for automated types of screens. All technologies require regular descumming and desludging and therefore require trained workers.

**Social Considerations:** Removal of solids and grease from Pre-Treatment Technologies is not pleasant and, if households or community members are responsible for doing this, it may not be done regularly. Hiring professionals for this may be the most efficient option but can be costly. Behavioural and technical source control measures at the household or building level can reduce pollution loads and keep Pre-Treatment requirements low. For example, solid waste and cooking oil should be collected separately and not disposed of in sanitation systems. Equipping sinks and showers with appropriate screens, filters and water seals can prevent solids from entering the system.

**Strengths and Weaknesses:**

- ⊕ Relatively low capital and operating costs
- ⊕ Reduced risk of impairing subsequent conveyance and/or treatment technologies
- ⊕ Higher lifetime and durability of sanitation hardware
- ⊖ Frequent maintenance required
- ⊖ Removal of solids and grease is unpleasant
- ⊖ Safe disposal must be planned

→ **References and further reading material for this technology can be found on page 193**

# Settler

| Phase of Emergency                               | Application Level / Scale                | Management Level                   | Objectives / Key Features                |
|--|--|------------------------------------|--|
| Acute Response<br>★ Stabilisation<br>★★ Recovery | Household<br>★★ Neighbourhood<br>★★ City | Household<br>★ Shared<br>★★ Public | Solid / liquid separation, BOD reduction |
| Space Required                                   | Technical Complexity                     | Inputs                             | Outputs                                  |
| ★★ Medium  | ★★ Medium                                | ● Blackwater, ● Greywater          | ● Effluent, ● Sludge                     |

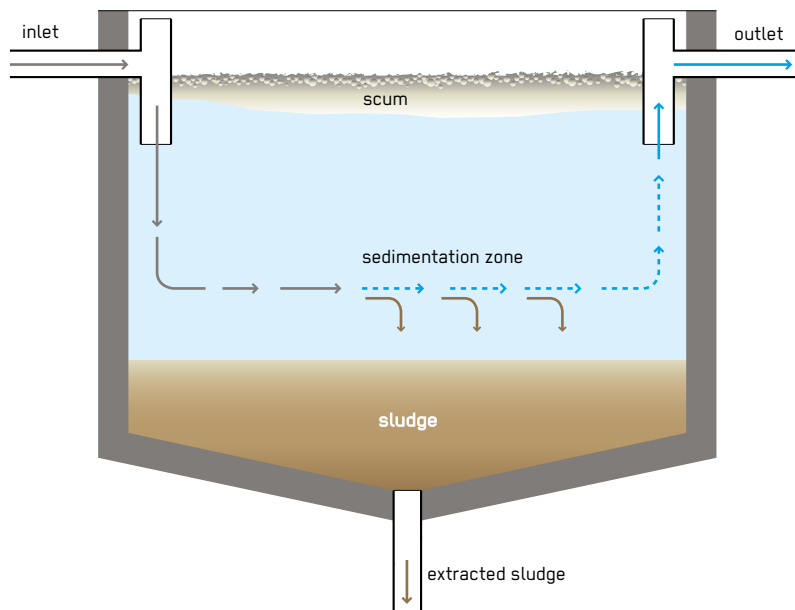

A Settler is a primary treatment technology for blackwater and greywater. It is designed to remove suspended solids by sedimentation. It may also be referred to as a sedimentation or settling basin/tank, or clarifier. The low flow velocity in a Settler allows settleable particles to sink to the bottom, while constituents lighter than water float to the surface.

Settlers are often used as primary clarifiers, and are typically sequenced after Pre-Treatment Technologies (PRE). Settlers can achieve a significant initial reduction in suspended solids (50–70 % removal) and organic material (20–40 % Biochemical Oxygen Demand (BOD) removal) and ensure that these constituents do not impair subsequent treatment processes. Settlers may take a variety of forms, sometimes fulfilling additional functions. They can be independent tanks or integrated into combined treatment units. Several other technologies in this Compendium have a primary sedimentation function or include a

compartment for primary settling: ABR (T.2), Biogas Reactor (T.4), Waste Stabilisation Ponds (T.5), Sedimentation and Thickening Ponds (T.8).

**Design Considerations:** The main purpose of a Settler is to ensure sedimentation by reducing the velocity and turbulence of the wastewater stream. Settlers are typically designed for a hydraulic retention time of 1.5–2.5 hours. Less time is needed if the BOD level should not be too low for the following biological step. The tank should be designed to ensure satisfactory performance at peak flow. In order to prevent eddy currents and short-circuiting, as well as to retain scum inside the basin, a good inlet and outlet construction with an efficient distribution and collection system (baffles, weirs or T-shaped pipes) is important. Depending on design and location, desludging can be done using Manual Emptying and Transport (C.1), Motorised Emptying and Transport (C.2) or by gravity using a bottom outlet. Clarifiers are settling tanks built

with mechanical means for continuous removal of solids being deposited by sedimentation and are equipped with mechanical collectors that continually scrape the settled solids towards a sludge hopper in the base of the tank, from where it is pumped to sludge treatment facilities. A sufficiently sloped tank bottom facilitates sludge removal. Efficiency of the primary Settler depends on wastewater characteristics, retention time and sludge withdrawal rate. It may be reduced by wind-induced circulation, thermal convection and density currents due to temperature differentials and in hot climates, thermal stratification. These phenomena can lead to short-circuiting. To enhance the performance of Settlers inclined plates (lamellae) and tubes can be installed which increase the settling area, or chemical coagulants can be used.

**Materials:** A Settler can be made of concrete, sand, gravel, cement, steel, as well as fibreglass, PVC or plastic, and are available as prefabricated units.

**Applicability:** The choice of a technology to settle solids is governed by the wastewater characteristics, management capacities and desirability of an anaerobic process, with or without biogas production. Technologies that already include some type of primary sedimentation (listed above) do not need a separate Settler. Many treatment technologies, however, require preliminary removal of solids in order to function properly. A primary sedimentation tank is particularly important for technologies that use a filter material (e.g. Anaerobic Filter **(T.3)**) but is often omitted in small Activated Sludge plants **(T.13)**. Settlers can also be installed as stormwater retention tanks to remove a portion of the organic solids that otherwise would be directly discharged into the environment.

**Operation and Maintenance:** In Settlers that are not designed for anaerobic processes, regular sludge removal is necessary to prevent septic conditions and the build-up and release of gas which can hamper the sedimentation process by re-suspending part of the settled solids.

Sludge transported to the surface by gas bubbles is difficult to remove and may pass to the next treatment stage. Frequent scum removal is important and sludge should be disposed of appropriately in a treatment system or buried.

**Health and Safety:** To prevent the release of odorous gases, frequent sludge removal is necessary. Sludge and scum must be handled with care as they contain high levels of pathogenic organisms; they require further treatment and adequate disposal. Appropriate personal protective equipment is necessary for workers who may come in contact with the effluent. Equipment and hands should be disinfected after sludge removal work.

**Costs:** The capital costs of a Settler are medium and operational costs are low. Costs depend on the conveyance and treatment technology it is to be combined with, and also on the local availability and thus costs of materials (sand, gravel, cement, steel) or prefabricated modules and labor costs. The main operation and maintenance costs are related to the removal of primary sludge and the cost of electricity if pumps are required for discharge (in absence of a gravity flow option).

**Social Considerations:** Usually, Settlers are a well-accepted technology. The wearing of adequate personal protective equipment should be addressed and trainings for involved staff might be needed.

**Strengths and Weaknesses:**

- ⊕ Simple and robust technology
- ⊕ Efficient removal of suspended solids
- ⊕ Relatively low capital and operating costs
- ⊖ Frequent removal of sludge required
- ⊖ Effluent, sludge and scum require further treatment
- ⊖ Sophisticated hydraulic and structural design

→ **References and further reading material for this technology can be found on page 193**

# Anaerobic Baffled Reactor (ABR)

| Phase of Emergency                               | Application Level / Scale               | Management Level                      | Objectives / Key Features                   |
|--|---|---------------------------------------|---|
| Acute Response<br>★ Stabilisation<br>★★ Recovery | ★ Household<br>★★ Neighbourhood<br>City | ★ Household<br>★★ Shared<br>★★ Public | Solid / liquid separation,<br>BOD reduction |
| Space Required                                   | Technical Complexity                    | Inputs                                | Outputs                                     |
| ★★ Medium  | ★★ Medium                               | ● Blackwater, ● Greywater             | ● Effluent, ● Sludge, ● Biogas              |

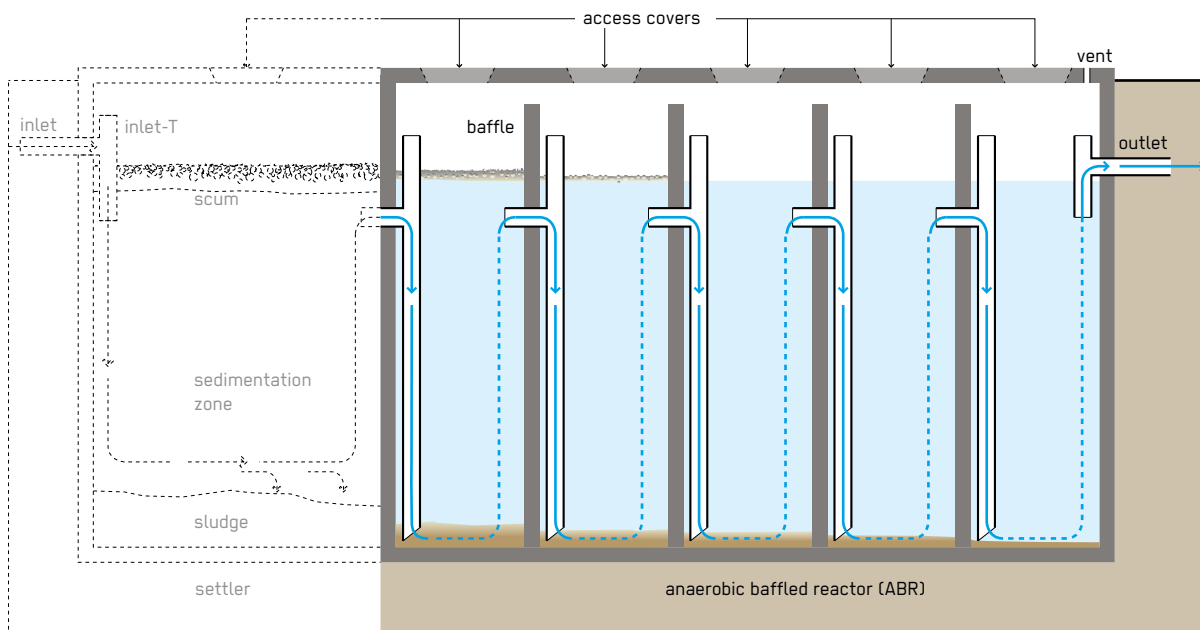

The Anaerobic Baffled Reactor (ABR) can treat many different types of wastewater and can be considered an improved Septic Tank (S.13) that uses baffles to optimise treatment. Treatment of the wastewater takes place as it is forced to flow upward through a series of chambers, where pollutants are biologically degraded in an active sludge layer at the bottom of each chamber.

ABRs can treat raw, primary, secondary treated sewage, and greywater (with organic load). The principle process is anaerobic (in the absence of oxygen) and makes use of biological treatment mechanisms. Up-flow chambers provide enhanced removal and digestion of organic matter. Biochemical Oxygen Demand (BOD) may be reduced by up to 90%, which is far superior to its removal in a conventional Septic Tank (S.13).

**Design Considerations:** Small-scale, stand-alone ABRs typically have an integrated settling compartment, but primary sedimentation can also take place in a separate Settler (T.1) or another preceding technology (e.g. Septic Tanks S.13). ABRs should consist of at least four chambers (as per BOD load); more than six chambers are not recommended. The organic load should be less than 6 kg of BOD/m<sup>3</sup>/day. The water depth at the outlet point should be about 1.8 m, and a depth of 2.2 m (in case of big systems) should not be exceeded. The hydraulic retention time should not be less than eight hours, and 16–20 hours is a preferred range. The up-flow velocity ideally ranges around 0.9 m/h, values higher than 1.2 m/h should be avoided. Accessibility to all chambers (through access covers) is necessary for maintenance. The tank should be vented to allow for controlled release of odorous and anaerobic gases. Where kitchen wastewater is connected to the system, a grease trap must be positioned before the Settler component in order to prevent excess oil and grease substances from entering and hindering treatment processes.



**Materials:** An ABR can be made of concrete, fibreglass, PVC or plastic, and prefabricated units are available. A pump might be required for discharging the treated wastewater where gravity flow is not an option.

**Applicability:** Roughly, an ABR for 20 households can take up to several weeks to construct. If reinforced fibre plastic ABR prefabricated modules are used the time required for construction is much less (3–4 days). Once in operation, three to six months (up to nine in colder climates) are needed for the biological environment to become established and maximum treatment efficiency to be reached. ABRs are thus not appropriate for the acute response phase and are more suitable for the stabilisation and recovery phases as a longer-term solution. Implementation at the neighbourhood scale is most suitable, but the technology can also be implemented at the household level or in larger catchment areas and in public buildings (e.g. schools). Even though ABRs are designed to be watertight, it is not recommended to construct them in areas with high groundwater tables or where there is frequent flooding. Alternatively prefabricated modules can be placed above ground. ABRs can be installed in every type of climate, although the efficiency will be lower in colder climates.

**Operation and Maintenance:** ABRs are relatively simple to operate. Once the system is fully functioning, specific operation tasks are not required. To reduce start-up time, the ABR can be inoculated with anaerobic bacteria, e.g. by adding Septic Tank sludge, or cow manure. The system should be checked monthly for solid waste, and the sludge level should be monitored every six months. Desludging is required every two to four years, depending on the accumulation of sludge at bottom of chambers, which reduces treatment efficiency. Desludging is best done using Motorised Emptying and Transport technology (C.2), but Manual Emptying and Transport (C.1) can also be an option. A small amount of sludge should be left to ensure that the biological process continues.

**Health and Safety:** Effluent, scum and sludge must be handled with care as they contain high levels of pathogens. During sludge and scum removal, workers should be equipped with proper personal protective equipment (boots, gloves, and clothing). If the effluent will be reused in agriculture or directly used for fertigation it should be treated further. Alternatively it can be discharged appropriately.

**Costs:** Capital costs of an ABR are medium and operational costs are very low. Costs of the ABR depend on what other Conveyance and Treatment technology it is to be combined with, and on local availability and thus costs of materials (sand, gravel, cement, steel) or prefabricated modules and labor costs. The main operation and maintenance costs are related to the removal of primary sludge and the cost of electricity if pumps are required for discharge (in the absence of a gravity flow option).

**Social Considerations:** Usually anaerobic filter treatment systems are a well-accepted technology. Because of the delicate ecology in the system, users should be instructed to not dispose of harsh chemicals into the ABR.

**Strengths and Weaknesses:**

- ⊕ Low operating costs
- ⊕ Resistant to sudden loads of organic material or flow increases
- ⊕ High reduction of BOD
- ⊕ Low sludge production; the sludge is stabilised
- ⊖ Requires expert design and construction
- ⊖ Low reduction of pathogens and nutrients
- ⊖ Effluent and sludge require further treatment and/or appropriate discharge
- ⊖ Long start-up time

→ **References and further reading material for this technology can be found on page 193**

# Anaerobic Filter

| Phase of Emergency                               | Application Level / Scale               | Management Level                      | Objectives / Key Features |
|--|---|---------------------------------------|---------------------------|
| Acute Response<br>★ Stabilisation<br>★★ Recovery | ★ Household<br>★★ Neighbourhood<br>City | ★ Household<br>★★ Shared<br>★★ Public | BOD reduction             |
| Space Required                                   | Technical Complexity                    | Inputs                                | Outputs                   |
| ★★ Medium  | ★★ Medium                               | ● Blackwater, ● Greywater             | ● Effluent, ● Sludge      |

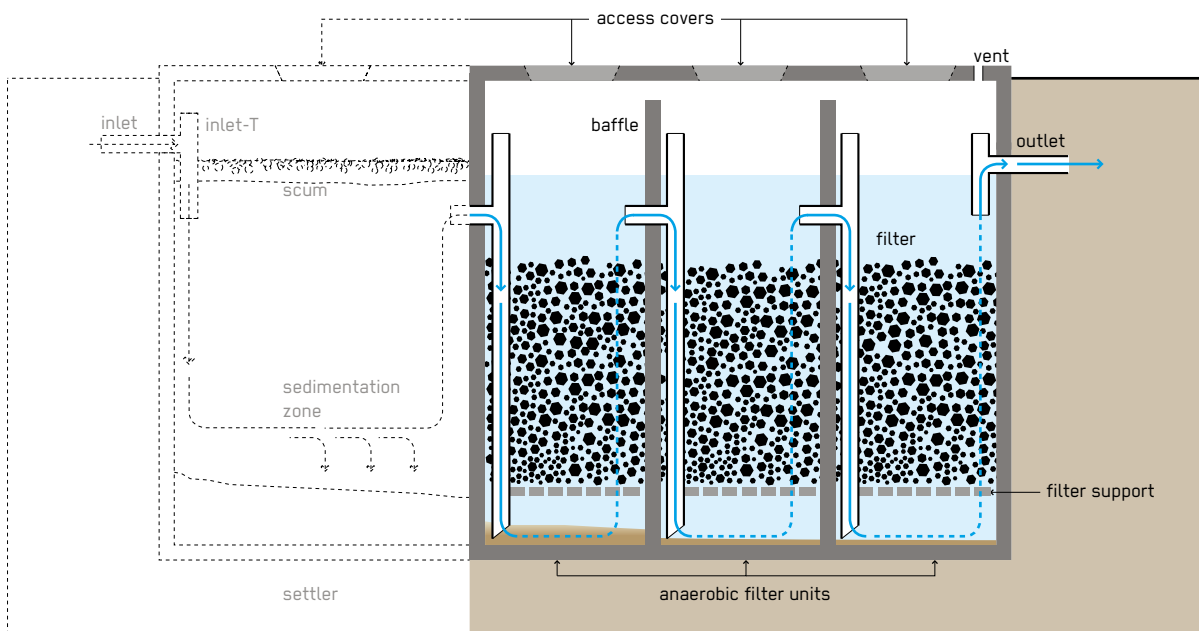

An Anaerobic Filter (AF) can efficiently treat many different types of wastewater. An AF is a fixed-bed biological reactor with one or more filtration chambers in series. As wastewater flows through the filter, particles are trapped and organic matter is degraded by the active biofilm that is attached to the surface of the filter material.

This technology is widely used as a secondary treatment in black or greywater systems and offers more effective solid removal than Septic Tanks (S.13) or Anaerobic Baffled Reactors (T.2). The treatment process is anaerobic making use of biological treatment mechanisms. Suspended solids and biochemical oxygen demand (BOD) removal can be up to 90 %, but is typically between 50 % and 80 %. Nitrogen removal is limited and normally does not exceed 15 % in terms of total nitrogen.

**Design Considerations:** Pre-Treatment (PRE) is essential to remove solids and solid waste that may clog the filter. The majority of settleable solids are removed in a sedimentation chamber sequenced before the AF. Small-scale, stand-alone units typically have an integrated settling compartment, but primary sedimentation can also take place in a separate Settler (T.1) or another preceding technology (e.g. Septic Tank (S.13)). AFs are usually operated in upflow mode because there is less risk that the fixed biomass will be washed out which would reduce treatment efficiency. The water level should cover the filter media by at least 0.3 m to guarantee an even flow regime. The hydraulic retention time (HRT) is the most important design parameter influencing filter performance. An HRT of 12–36 hours is recommended. The ideal filter should have a large surface area for bacteria to grow, with large pore volume to prevent clogging. The surface area ensures increased contact between organic matter and the attached biomass that effectively degrades it. Ideally,

the material should provide between 90–300 m<sup>2</sup> of surface area/m<sup>3</sup> of occupied reactor volume. The connection between chambers can be designed either with vertical pipes or baffles. Accessibility to all chambers (through access ports) is necessary for maintenance. The tank should be vented to allow for controlled release of odorous and potentially harmful gases. Where kitchen wastewater is connected to the system, a grease trap must be incorporated into the design before the Settler.

**Materials:** An AF can be made of concrete, sand, gravel, cement, steel, as well as fibreglass, PVC or plastic, and thus can be found as a prefabricated solution. Typical filter material should ideally range from 12 to 55 mm in diameter. The size of materials decrease from bottom to top. Filter materials commonly used include gravel, crushed rocks or bricks, cinder, pumice, shredded glass or specially formed plastic pieces (even crushed PVC plastic bottles can be used).

**Applicability:** AFs are not suitable for the acute response phase because the biological environment within the AF takes time to establish. The AF is more suitable for the stabilisation and recovery phases and as a longer-term solution. The neighbourhood scale is the most suitable, but the AF can be implemented at the household level or in larger catchment areas and/or public buildings (e.g. schools). Even though AFs are watertight, it is not recommended to construct them in areas with high groundwater tables or where there is frequent flooding. Alternatively, prefabricated modules can be placed above ground. AFs can be installed in all climates, although efficiency will be lower in colder climates. Pathogen and nutrient reduction is low in AFs; if high effluent standards are to be achieved, an additional treatment technology should be added (e.g. ABR (T.2), Constructed Wetland (T.6), Waste Stabilisation Ponds (T.5)).

**Operation and Maintenance:** An AF requires a start-up period of six to nine months to reach full treatment capacity as the slow growing anaerobic biomass first needs to be established on the filter media. To reduce start-up time, the filter can be inoculated with anaerobic bacteria, e.g. by spraying Septic Tank sludge onto the filter material. The flow should be gradually increased over time. Scum and sludge levels need to be monitored to ensure that the tank is functioning well. Over time, solids will clog the

pores of the filter and the growing bacterial mass will become too thick, break off and eventually clog pores. When efficiency decreases, the filter must be cleaned. This is done by running the system in reverse mode (backwashing) or by removing and cleaning the filter material. AF tanks should be checked from time to time to ensure that they are watertight.

**Health and Safety:** Effluent, scum and sludge must be handled with care as the effluent contains pathogens. If the effluent will be reused in agriculture or directly used for fertigation, it should be treated further. Alternatively it can be discharged appropriately. Full personal protective equipment must be worn during desludging and cleaning of the AF.

**Costs:** Capital costs of an AF are medium and operational costs are low. Costs of the AF depend on what other Conveyance and Treatment technology it is to be combined with, and also on local availability and thus costs of materials (sand, gravel, cement, steel) or prefabricated modules and labor costs. The main operation and maintenance (O & M) costs are related to the removal of primary sludge and the cost of electricity if pumps are required for discharge (in absence of a gravity flow option).

**Social Considerations:** Usually, AF treatment systems are a well-accepted technology. Because of the delicate ecology in the system, awareness raising among the users on eliminating the use of harsh chemicals is necessary.

**Strengths and Weaknesses:**

- ⊕ Low O & M requirements and costs
- ⊕ Robust treatment performance and resistant to sudden loads of organic material or flow increases
- ⊕ No electrical energy is required
- ⊕ High reduction of BOD and solids
- ⊖ Low reduction of pathogens and nutrients
- ⊖ Requires expert design and construction
- ⊖ Removing and cleaning the clogged filter media is cumbersome
- ⊖ Long start-up time

→ **References and further reading material for this technology can be found on page 193**

# Biogas Reactor

| Phase of Emergency                               | Application Level / Scale                  | Management Level                       | Objectives / Key Features                |
|--|--|--|--|
| Acute Response<br>★ Stabilisation<br>★★ Recovery | ★ Household<br>★★ Neighbourhood<br>★★ City | ★★ Household<br>★★ Shared<br>★★ Public | Stabilisation of sludge, Biogas recovery |
| Space Required                                   | Technical Complexity                       | Inputs                                 | Outputs                                  |
| ★★ Medium  | ★★ Medium                                  | ● Excreta, ● Blackwater, ● Organics    | ● Biogas                                 |

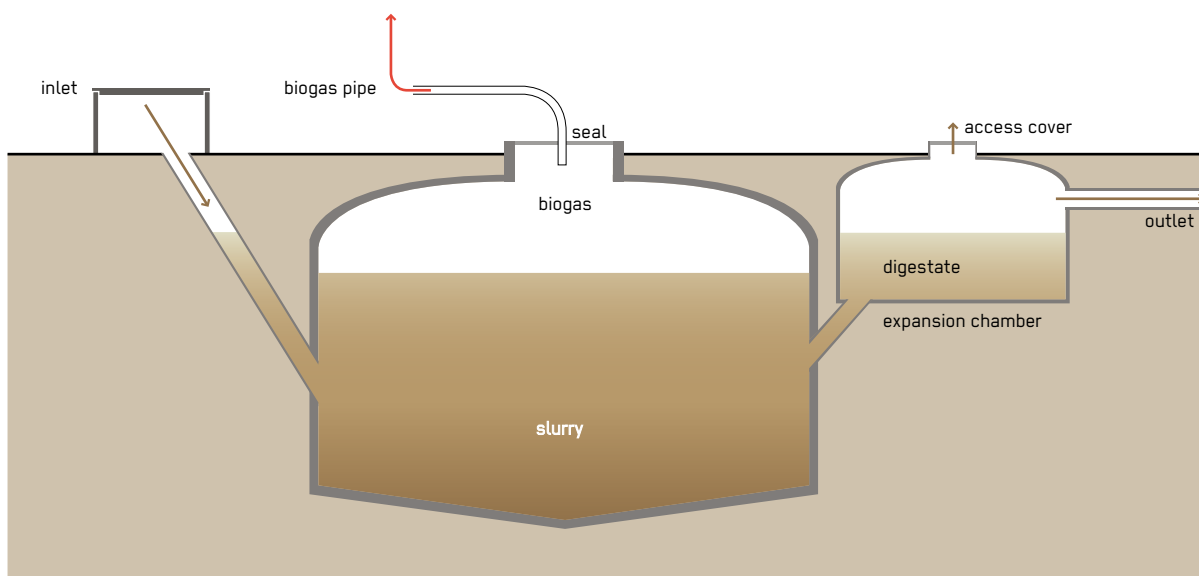

A Biogas Reactor can efficiently treat different types of wastewater. It is an anaerobic treatment technology that produces a digested sludge (digestate) that can be used as a fertiliser and biogas that can be used for energy. Biogas is a mix of methane, carbon dioxide and other trace gases which can be converted to heat, electricity or light (D.7).

A Biogas Reactor is an airtight chamber that facilitates anaerobic degradation of blackwater, sludge, and/or biodegradable waste. Treatment of wastewater takes place as it enters the digester. An active sludge layer within the digester biologically degrades inputs. Digested sludge is discharged from the overflow point at ground level. The digester chamber also collects biogas produced in the fermentation process. The digestate is rich in organics and nutrients, and is easier to dewater and manage.

**Design Considerations:** Biogas Reactors can be built as fixed dome or floating dome digesters. In the fixed dome, the volume of the reactor is constant. As gas is generated it exerts a pressure and displaces the slurry upward into an expansion chamber. When the gas is removed, slurry flows back into the reactor. The pressure can be used to transport the biogas through pipes. In a floating dome reactor, the dome rises and falls with production and withdrawal of gas. Alternatively, it can expand (like a balloon). The hydraulic retention time (HRT) in the reactor should be at least 15 days in hot climates and 25 days in temperate climates. For highly pathogenic inputs, a HRT of 60 days should be considered. Sizes can vary from 1,000 L for a single family up to 100,000 L for institutional or public toilet applications. Because digestate production is continuous, there must be provisions made for its storage, use and/or transport away from the site.

**Materials:** A Biogas Reactor can be made out of bricks, cement, steel, sand, wire for structural strength (e.g. chicken wire), waterproof cement additive (for sealing), water pipes and fittings, a valve and a prefabricated gas outlet pipe. Prefabricated solutions include geo-bags, reinforced fibre plastic modules, and router moulded units and are available from specialist suppliers.

**Applicability:** Biogas Reactor technology is appropriate for treating household wastewater as well as wastewater from institutions such as hospitals and schools. It is not suitable for the acute response phase, as the biological environment needs time to establish itself. Biogas Reactors are especially applicable in rural areas where animal manure can be added and there is a need for the digestate as fertiliser and gas for cooking. Biogas Reactors can also be used for stabilising sludge from Pit Latrines (S.3, S.4). Often, a Biogas Reactor is used as an alternative to a Septic Tank (S.13), since it offers a similar level of treatment, but with the added benefit of producing biogas. However, significant gas production cannot be achieved if blackwater is the only input or if the ambient air temperature is below 15 °C. Greywater should not be added as it substantially reduces the HRT. Biogas Reactors are less appropriate for colder climates as the rate of organic matter conversion into biogas becomes very low. Consequently, in colder climates the HRT needs to be longer and the design volume substantially increased. Even though Biogas Reactors are watertight, it is not recommended to construct them in areas with high groundwater tables or where there is frequent flooding.

**Operation and Maintenance:** To start the reactor, it should be inoculated with anaerobic bacteria (e.g. by adding cow dung or Septic Tank sludge). Digestate needs to be removed from the overflow frequently and will depend on the volume of the tank relative to the input of solids, the amount of indigestible solids, and the ambient temperature, as well as usage and system characteristics. Gas should be monitored and used regularly. Water traps should be checked regularly and valves and gas piping should be cleaned so that corrosion and leaks are prevented. Depending on the design and the inputs, the reactor should be emptied and cleaned every 5 to 10 years.

**Health and Safety:** The digestate is partially sanitised but still carries a risk of infection, therefore during digestate removal, workers should be equipped with proper personal protective equipment (PPE). Depending on its end-use, emptied liquid and sludge require further treatment prior to use in agriculture. Cleaning of the reactor can be a health-hazard and appropriate safety precautions (wearing proper PPE) should be taken. There are also dangers associated with the flammable gases but risks are the same as natural gas. There is no additional risk due to the origin of the gas.

**Costs:** This is a low to medium cost option, both in terms of capital and operational costs. However, additional costs related to the daily operations needed by the reactor need to be taken into consideration. Community installations tend to be more economically viable, as long as they are socially accepted. Costs for capacity development and training for operators and users must be budgeted for until the knowledge is well-established.

**Social Considerations:** Social acceptance might be a challenge for communities that are not familiar with using biogas or digestate. Social cohesion can be created through shared management and shared benefits (gas and fertiliser) from Biogas Reactors, however, there is also a risk that benefits are unevenly distributed among users which can lead to conflict.

**Strengths and Weaknesses:**

- ⊕ Reduced solid waste management cost and faecal sludge transportation costs if co-digestion is used
- ⊕ Generation of useable products, like gas and fertiliser
- ⊕ Robust technology with a long service life
- ⊖ Requires expert design and skilled construction
- ⊖ Incomplete pathogen removal, the digestate might require further treatment
- ⊖ Variable gas production depending on the input material and limited gas production below 15 °C
- ⊖ Medium level investment cost

→ **References and further reading material for this technology can be found on page 194**

# Waste Stabilisation Ponds

| Phase of Emergency                                | Application Level / Scale               | Management Level                       | Objectives / Key Features   |
|---|---|--|---|
| Acute Response<br>** Stabilisation<br>** Recovery | Household<br>* Neighbourhood<br>** City | Household<br>* Shared<br>** Public     | Solid / liquid separation, Sludge stabilisation, Pathogen reduction |
| Space Required                                    | Technical Complexity                    | Inputs                                 | Outputs   |
| *** High  | ** Medium                               | ● Blackwater, ● Greywater,<br>● Sludge | ● Effluent, ● Sludge  |

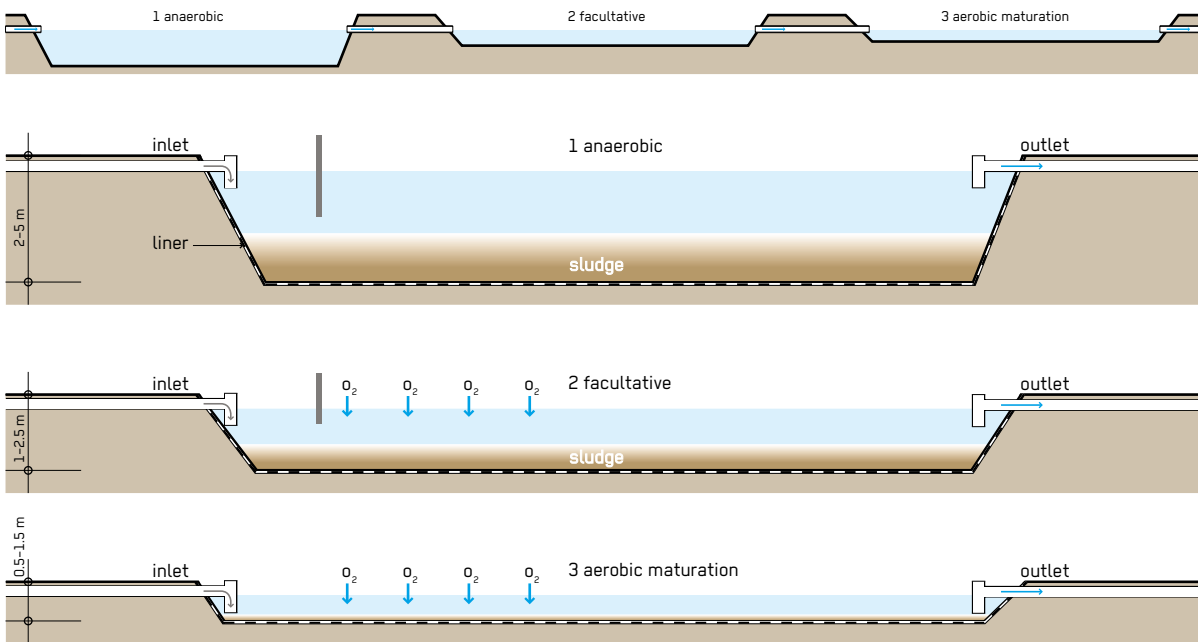

Waste Stabilisation Ponds (WSPs) are large, constructed water bodies. The ponds can be used individually, or linked in a series for improved treatment. There are three types of ponds, (1) anaerobic, (2) facultative and (3) aerobic (maturation), each with different treatment and design characteristics.

For the most effective treatment, WSPs should be linked in a series of three or more, with effluent flowing from the anaerobic pond to the facultative pond and, finally, to the aerobic pond. The anaerobic pond is the primary treatment stage and reduces the organic load in wastewater. Solids and biological oxygen demand (BOD) removal occurs by sedimentation and through subsequent anaerobic digestion inside the sludge. Anaerobic bacteria convert organic carbon into methane and, through this process, remove up to 60% of BOD. In a series of WSPs, the effluent from the anaerobic pond is transferred to the facultative pond, where further BOD is removed. The top layer of the pond

receives oxygen from natural diffusion, wind mixing and algae-driven photosynthesis. The lower layer is deprived of oxygen and becomes anoxic or anaerobic. Settleable solids accumulate and are digested on the bottom of the pond. Aerobic and anaerobic organisms work together to achieve BOD reduction of up to 75%. Anaerobic and facultative ponds are designed for BOD removal, while aerobic ponds are designed for pathogen removal. An aerobic pond is commonly referred to as a maturation, polishing, or finishing pond because it is usually the last step in a series of ponds and provides the final level of treatment. It is the shallowest pond, ensuring that sunlight penetrates the full depth for photosynthesis to occur. Photosynthetic algae release oxygen into the water and consume carbon dioxide produced by respiration of bacteria. Because photosynthesis is driven by sunlight, the dissolved oxygen levels are highest during the day and drop off at night. Dissolved oxygen is also provided by natural wind mixing.

**Design Considerations:** Anaerobic ponds are built with a depth of 2 to 5 m and have a relatively short detention time of one to seven days. Facultative ponds should be constructed with a depth of 1 to 2.5 m and have a detention time between five and 30 days. Their efficiency may be improved with the installation of mechanical aerators. Aerobic ponds are usually between 0.5 to 1.5 m deep. If used in combination with algae and/or fish harvesting **(D.13)** they are effective at removing the majority of nitrogen and phosphorus from the effluent. Ideally, several aerobic ponds can be built in series to provide a high level of pathogen removal. A good hydraulic design is important to avoid short-circuiting, i.e. wastewater travelling directly from inlet to outlet. The inlet and outlet should be as far apart as possible, and baffles can be installed to ensure complete mixing within the ponds and avoid stagnating areas. Pre-Treatment **(PRE)** is essential to prevent scum formation and to hinder excess solids and garbage from entering the ponds. To protect ponds from runoff and erosion, a protective berm or mound should be constructed around each pond using excavated material.

**Materials:** Mechanical equipment is necessary to dig ponds. To prevent leaching into groundwater, the ponds should have a liner, which can be made from clay, asphalt, compacted earth, or any other impervious material.

**Applicability:** WSPs are among the most common and efficient methods of wastewater or effluent treatment around the world. They are especially appropriate for rural and peri-urban communities that have large, unused land, at a distance from homes and public spaces. WSPs are not suitable for the acute response phase due to the long implementation time needed and are more appropriate for the stabilisation and recovery phases and as a longer-term solution.

**Operation and Maintenance:** Scum that builds on the pond surface should be regularly removed. Aquatic plants (macrophytes) that are present in the pond should also be removed as they may provide a breeding habitat for

mosquitoes and prevent light from penetrating the water column. The anaerobic pond must be desludged approximately every 2 to 5 years, when the accumulated solids reach one third of the pond volume. For facultative ponds sludge removal is less and maturation ponds hardly ever need desludging. Sludge can be removed using a raft-mounted sludge pump, a mechanical scraper at the bottom of the pond or by draining and dewatering the pond and removing the sludge with a front-end loader.

**Health and Safety:** Although effluent from aerobic ponds is generally low in pathogens, the ponds should in no way be used for recreation or as a direct source of water for consumption or domestic use. A fence should be installed to ensure that people and animals stay out of the area and that solid waste does not enter the ponds.

**Costs:** Investment costs to purchase land and dig the ponds may be high, but operation and maintenance costs are relatively low.

**Social Considerations:** The anaerobic pond(s) may generate bad odours. It is thus important to locate the ponds far from settlements. Alternatively, the surface of anaerobic ponds can be artificially aerated. Due to algae growth in the aerobic ponds, the effluent may look very green.

**Strengths and Weaknesses:**

- ⊕ Resistant to sudden loads of organic material or flow increases
- ⊕ High reduction of solids, BOD and pathogens
- ⊕ Low operating costs
- ⊕ No electrical energy is required
- ⊖ Requires a large land area
- ⊖ High capital costs depending on the price of land
- ⊖ Requires expert design and construction
- ⊖ Sludge requires proper removal and treatment

→ **References and further reading material for this technology can be found on page 194**

# Constructed Wetland

| Phase of Emergency                               | Application Level / Scale                  | Management Level                         | Objectives / Key Features            |
|--|--|--|--------------------------------------|
| Acute Response<br>* Stabilisation<br>** Recovery | * Household<br>** Neighbourhood<br>** City | * Household<br>** Shared<br>** Public    | TSS and TDS reduction, Nitrification |
| Space Required                                   | Technical Complexity                       | Inputs                                   | Outputs                              |
| *** High   | ** Medium                                  | ● Effluent, ● Blackwater,<br>● Greywater | ● Effluent, ● Biomass                |

horizontal subsurface flow constructed wetland

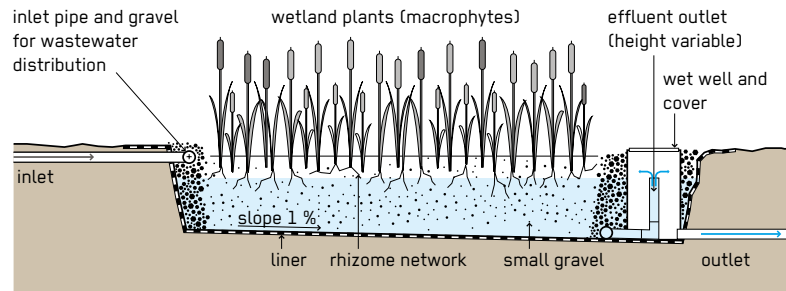

vertical flow constructed wetland

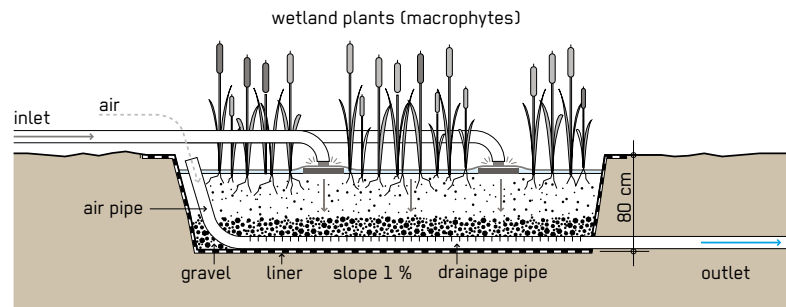

Constructed Wetlands are engineered wetlands designed to filter and treat different types of wastewater mimicking processes found in natural environments.

Constructed Wetlands can effectively treat raw, primary or secondary treated sewage, as well as greywater. The main types of Constructed Wetlands are horizontal flow (HF) wetlands and vertical flow (VF) wetlands, including the French VF wetland, which is a double-stage VF Constructed Wetland. In Constructed Wetlands a gravel media acts as a filter for removing solids, as a fixed surface to which bacteria can attach, and as a base for vegetation. The important difference between a vertical and horizontal wetland beyond the direction of the flow path, is the aeration regime. Compared to other wastewater treatment technologies, Constructed Wetlands are robust in that performance is less susceptible to input variations.

**Design Considerations:** For HF and VF wetlands efficient primary treatment is essential to prevent clogging. French VF wetlands can receive raw wastewater and require no pre-treatment. VF and French VF wetlands require intermittent loading (several times a day) to ensure aerobic conditions in the filter whereas HF wetlands and free-water surface (FWS) wetlands are loaded continuously. The specification (grain size, etc.) of sand and gravel used for the main layer defines the treatment efficiency in VF and French VF wetlands. In HF wetlands mainly anaerobic processes occur, whereas in VF and French VF wetlands with intermittent loading, aerobic processes are dominant. If topography allows intermittent loading it can be done with siphons thus avoiding external energy and pumps. Sizing of the surface mainly depends on the organic load (chemical oxygen demand per m<sup>2</sup> per day) and minimum yearly temperature. French VF wetlands consist of two stages, with at least two treatment lines to be used alternatively. The wetland plants must have deep roots



and should be able to adapt to humid environments with slightly saline and nutrient-rich soil conditions. *Phragmites australis* or *communis* (reeds) are often chosen because they form a matrix of rhizomes efficient at maintaining the permeability necessary for large filtration and also decrease the risk of clogging.

**Materials:** In principle, Constructed Wetlands can be built using locally available material, however, availability of sand and gravel (with required grain size distribution and cleanliness) is often a problem. Additional materials include a liner or clay, wetland plants, and a syphon or pump for intermittent loading. They are typically not suitable for pre-fabrication.

**Applicability:** Constructed Wetlands require wastewater to function and therefore are applicable only for water-borne sanitation systems. They are a viable solution where land is available and a wastewater treatment solution is required for a longer period of time. Wetland plants take time to become established, therefore the start-up time for Constructed Wetlands is quite long. Thus this technology is not suitable for the acute response phase but for the stabilisation and recovery periods and as a longer-term solution.

**Operation and Maintenance:** In general, operation and maintenance (O&M) requirements are low. For VF and HF wetlands, the regular removal of primary sludge from mechanical pre-treatment is the most critical routine O&M activity. In French VF wetlands, the loading has to be alternated between the VF beds of the first stage on a weekly basis. Distribution pipes should be cleaned once a year to remove the sludge and biofilm that might cause blockage. During the first growing season, it is important to remove weeds that can compete with the planted wetland vegetation.

**Health and Safety:** Under normal operating conditions, users do not come in contact with the influent or effluent. Influent, scum and primary sludge must be handled with

care as they contain high levels of pathogenic organisms. Removal of primary sludge can be a health hazard and appropriate safety precautions have to be taken. The facility should be designed and located such that odours (mainly from primary treatment) and mosquitos (mainly relevant for FWS wetlands) do not bother community members.

**Costs:** As Constructed Wetlands are self-sustaining their lifetime costs are significantly lower than those of conventional treatment systems. Sewer lines might be the highest costs when implementing a water-borne sanitation system using Constructed Wetlands. The main O&M costs are related to the removal of primary sludge from the primary treatment (for VF and HF wetlands) and cost of electricity if pumps are used for intermittent loading. The cost of changing the filter material (approximately every 10 years) should be factored in. The systems require significant space, and are therefore not preferred where land costs are high.

**Social Considerations:** Usually, treatment wetlands are easily accepted by locals and only minimal technical capacity is required for O&M.

**Strengths and Weaknesses:**

- ⊕ Low O&M requirements
- ⊕ Robust treatment performance and resistant to sudden loads of organic material or flow increases
- ⊕ Adaptable to local conditions
- ⊕ Long service life and possible use of the harvest material
- ⊖ Land requirement
- ⊖ Risk of clogging, depending on pre- and primary treatment
- ⊖ Electric pumps required for intermittent loading of VF and French VF wetlands (if landscape does not allow gravity-driven systems)

→ **References and further reading material for this technology can be found on page 194**

# Trickling Filter

| Phase of Emergency                               | Application Level / Scale               | Management Level                         | Objectives / Key Features            |
|--|---|--|--------------------------------------|
| Acute Response<br>★ Stabilisation<br>★★ Recovery | Household<br>★ Neighbourhood<br>★★ City | Household<br>Shared<br>★★ Public         | TSS and TDS reduction, Nitrification |
| Space Required                                   | Technical Complexity                    | Inputs                                   | Outputs                              |
| ★★ Medium  | ★★★ High                                | ● Effluent, ● Blackwater,<br>● Greywater | ● Effluent, ● Sludge                 |

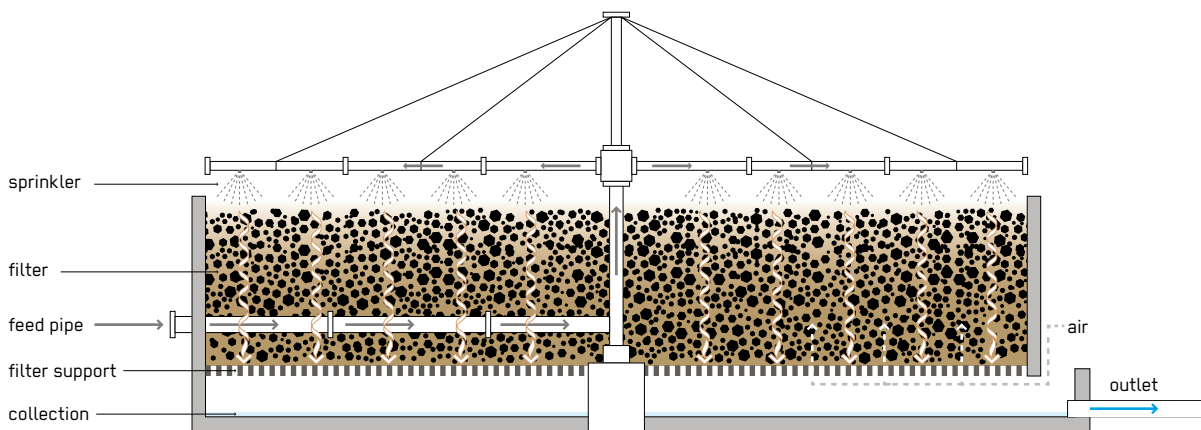

A Trickling Filter is a fixed-bed, biological reactor that operates under (mostly) aerobic conditions. Pre-settled wastewater is continuously 'trickled' or sprayed over the filter. As the water percolates through the pores of the filter, organics are degraded by the biofilm covering the filter material.

The Trickling Filter is filled with a high specific surface area material, such as rocks, gravel, shredded PVC bottles, or special pre-formed plastic filter media. The high specific surface provides a large area for biofilm formation. Organisms that grow in the thin biofilm over the surface of the media oxidise the organic load in the wastewater into carbon dioxide and water, while generating new biomass. The incoming pre-treated wastewater is trickled over the filter, e.g. with the use of a rotating sprinkler. In this way, the filter media goes through cycles of being dosed and exposed to air. However, oxygen is depleted within the biomass and the inner layers may be anoxic or anaerobic.

**Design Considerations:** The filter is usually 1 to 2.5 m deep, but filters packed with lighter plastic filling can be up to 12 m deep. Primary treatment is essential to prevent clogging and to ensure efficient treatment. Adequate air flow is important to ensure sufficient treatment performance and prevent odours. The underdrains should provide a passageway for air at the maximum filling rate. A perforated slab supports the bottom of the filter, allowing the effluent and excess sludge to be collected. With time, the biomass will grow thick and the attached layer will be deprived of oxygen; it will enter an endogenous state, will lose its ability to stay attached and will slough off. High-rate loading conditions will also cause sloughing. The collected effluent should be clarified in a settling tank to remove any biomass that may have dislodged from the filter. The hydraulic and nutrient loading rate (i.e. how much wastewater can be applied to the filter) is determined based on wastewater characteristics, type of filter media, ambient temperature, and discharge requirements.

**Materials:** Not all parts and materials may be locally available. The ideal filter material is low-cost and durable, has a high surface to volume ratio, is light, and allows air to circulate. If available, crushed rock or gravel is usually the cheapest option. The particles should be uniform and 95% of them should have a diameter between 7 and 10 cm. A material with a specific surface area between 45 and 60 m<sup>2</sup>/m<sup>3</sup> for rocks and 90 to 150 m<sup>2</sup>/m<sup>3</sup> for plastic packing is normally used. Larger pores (as in recycled plastic packing) are less prone to clogging and provide for good air circulation.

**Applicability:** A Trickling Filter is usually part of a wastewater treatment plant as a secondary or tertiary treatment step and is applicable only in water-borne systems. It is a viable solution during the stabilisation and recovery phase of an emergency when a longer-term solution is required. This technology can only be used following primary clarification since high solids loading will cause the filter to clog. A low-energy (working with gravity) trickling system can be designed, but in general, a continuous supply of power and wastewater is required. Trickling Filters are compact, they are best suited for peri-urban or large, rural settlements. Trickling Filters can be built in almost all environments, but special adaptations for cold climates are required.

**Operation and Maintenance:** A skilled operator is required full-time to monitor the filter and repair the pump in case of problems. Sludge that accumulates on the filter must be periodically washed away to prevent clogging and keep the biofilm thin and aerobic. High hydraulic loading rates (flushing doses) can be used to flush the filter. Optimum dosing rates and flushing frequency should be determined from the field operation. The packing must be kept

moist. This may be problematic at night when water flow is reduced or when there are power failures. Snails grazing on the biofilm and filter flies are well known problems associated with Trickling Filters and must be handled by backwashing and periodic flooding.

**Costs:** Capital costs are moderate to high depending on the filter material and feeder pumps used. Costs for energy have to be considered. Energy is required to operate the pumps feeding the Trickling Filter.

**Social Considerations:** Odour and fly problems require that the filter be built away from homes and businesses. Appropriate measures must be taken for pre- and primary treatment, effluent discharge and solids treatment, all of which can still pose health risks.

#### **Strengths and Weaknesses:**

- ⊕ Can be operated at a range of organic and hydraulic loading rates
- ⊕ Efficient nitrification (ammonium oxidation)
- ⊕ High treatment efficiency with lower land area requirements compared to wetlands
- ⊖ High capital costs
- ⊖ Requires expert design and construction, particularly the dosing system
- ⊖ Requires operation and maintenance by skilled personnel
- ⊖ Requires a constant source of electricity and constant wastewater flow

→ **References and further reading material for this technology can be found on page 194**

# Sedimentation and Thickening Ponds

| Phase of Emergency                               | Application Level / Scale               | Management Level                 | Objectives / Key Features  |
|--|---|----------------------------------|--|
| Acute Response<br>★ Stabilisation<br>★★ Recovery | Household<br>★ Neighbourhood<br>★★ City | Household<br>Shared<br>★★ Public | Solid / liquid separation of faecal sludge, Sludge stabilisation |
| Space Required                                   | Technical Complexity                    | Inputs                           | Outputs  |
| ★★★ High   | ★★ Medium                               | ● Sludge                         | ● Sludge, ● Effluent   |

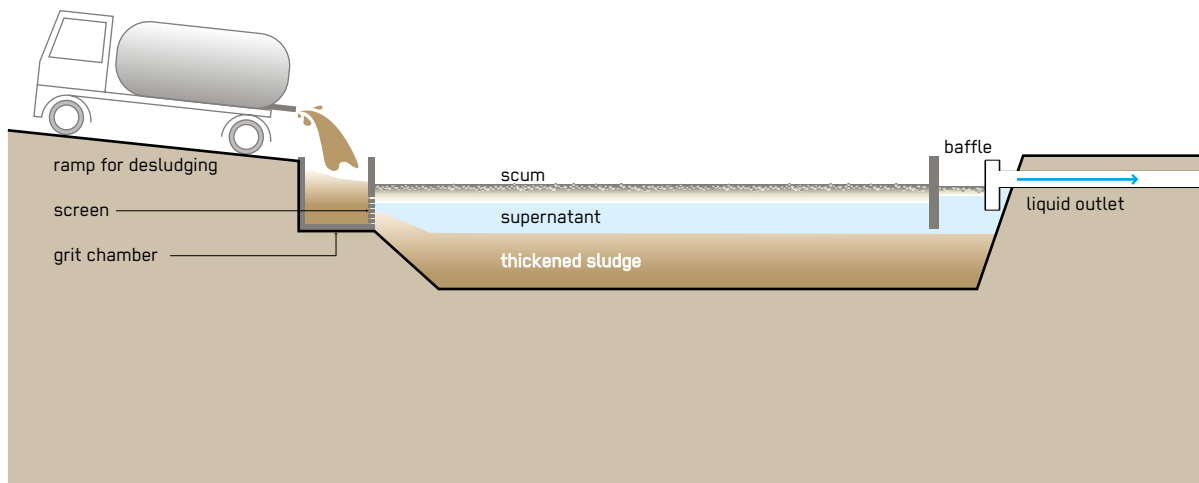

Sedimentation or Thickening Ponds or tanks are settling ponds that allow sludge to thicken and dewater. The effluent is removed and treated, while the thickened sludge can be further treated in a subsequent technology.

Faecal sludge is not a uniform product and, therefore, its treatment must be specific to the characteristics of the sludge. Sludge which is rich in organics and has not undergone significant degradation is difficult to dewater. Conversely, sludge that has undergone significant anaerobic degradation is more easily dewatered. In order to be properly dried, fresh sludge, which is rich in organic matter (e.g. latrine or public toilet sludge), must first be stabilised, which can be done through anaerobic degradation in Sedimentation/Thickening Ponds. The same type of pond can be used to thicken sludge which is already partially stabilised, e.g. originating from Septic Tanks (S.13). The degradation process may hinder the settling of sludge because the gases produced bubble

up and re-suspend the solids. As the sludge settles and digests, the supernatant must be decanted and treated separately. The thickened sludge can then be dried or co-composted (T.9–T.11).

**Design Considerations:** Two tanks/ponds operating in parallel are required; one can be loaded, while the other is resting. To achieve maximum efficiency, loading and resting periods should not exceed four to five weeks, although much longer cycles are common. When a four-week loading and four-week resting cycle is used, total solids can be increased to 14% (depending on the initial concentration). Beyond that, the quality of the supernatant may start decreasing, while sludge does not thicken further. It is also possible to have shorter cycles, for example 1 week, in order to get a sludge that is less thickened but easier to pump. The lower part of the pond is where accumulation and thickening, and thus natural compaction, takes place. The height of this zone must be estimated

based on the quantity of solids to be received during the whole duration of loading and the desired final concentration. The height of the supernatant zone is typically 1 m. For an optimal design, it is recommended to test the settling capacity of the sludge beforehand. As in a Settler (T.1), the settling surface and the design of the inlet and outlet baffles are important in order to stabilise the hydraulic flow and optimise settling. The zone reserved for scum depends on the storage duration and is typically around 0.5 m. It is important that each zone's height is well estimated in order to avoid sludge leaving the pond together with the supernatant. Access for maintenance is necessary and depends on the method planned for sludge removal.

**Materials:** This is standard civil engineering work, requiring digging and concrete. Key items are the sludge removal equipment.

**Applicability:** Sedimentation and Thickening Ponds are appropriate for sludge stabilisation (for example when there is fresh sludge), and/or thickening. Sludge can be thickened when difficult to dry in the raw state (for example because it is less concentrated), and/or because the climate is not conducive to open air drying, (due to high humidity or a long rainy season). Both the thickened sludge and the supernatant need further treatment, for example in drying beds or waste stabilisation ponds respectively. If a wastewater treatment plant is nearby and is able to absorb the supernatant, it can be treated there. Sedimentation and Thickening Ponds are most appropriate where there is inexpensive, available space located far from homes and businesses.

**Operation and Maintenance:** A trained staff member for operation and maintenance is required. The maintenance is not intensive. The discharging area must be maintained and kept clean to reduce the potential of disease trans-

mission and nuisance (flies and odours). Solid waste that is discharged along with the sludge must be removed from the screen at the inlet of the ponds (PRE). The thickened sludge must be mechanically removed (with a front-end loader or other specialised equipment) after it has sufficiently thickened; alternatively, it can be pumped if it is still sufficiently liquid. It is essential to plan for sludge removal and allocate financial resources for it.

**Health and Safety:** Both incoming and thickened sludge are pathogenic. Workers should be equipped with proper personal protective equipment (boots, gloves, and clothing).

**Costs:** Considering the land required, the construction costs and the need for sludge removal equipment, the capital costs are medium. The operating costs are low, with the major expense being the regular sludge removal.

**Social Considerations:** The Sedimentation and Thickening Pond may cause a nuisance for nearby residents due to bad odours and the presence of flies. It should be located away from residential areas.

**Strengths and Weaknesses:**

- ⊕ The thickened sludge is easier to further treat, to handle and less prone to splashing and spraying
- ⊕ Can be built and repaired with locally available materials
- ⊕ No electrical energy is required if there is no pump
- ⊖ Odours and flies are normally noticeable
- ⊖ Long storage times
- ⊖ Important mechanical means and know-how needed for sludge management
- ⊖ Effluent and sludge require further treatment

→ **References and further reading material for this technology can be found on page 194**

# Unplanted Drying Beds

| Phase of Emergency                               | Application Level / Scale               | Management Level                 | Objectives / Key Features              |
|--|---|----------------------------------|--|
| Acute Response<br>★ Stabilisation<br>★★ Recovery | Household<br>★ Neighbourhood<br>★★ City | Household<br>Shared<br>★★ Public | Sludge drying, Sludge volume reduction |
| Space Required                                   | Technical Complexity                    | Inputs                           | Outputs                                |
| ★★★ High   | ★★ Medium                               | ● Sludge                         | ● Sludge, ● Effluent                   |

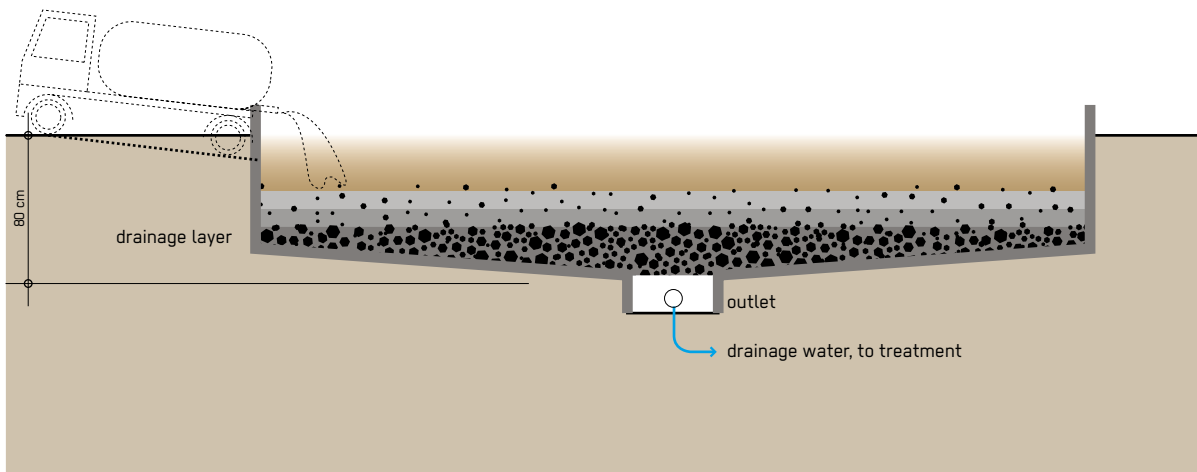

An Unplanted Drying Bed is a simple, permeable bed that, when loaded with sludge, allows the sludge to dewater by filtration and evaporation and separates and drains the percolated leachate. Approximately 50% to 80% of the sludge volume drains off as the liquid evaporates. Once dry, the sludge is removed and the bed can receive liquid sludge again. The dry sludge, however, is not effectively sanitised and needs further treatment.

An Unplanted Drying Bed is made of layers of gravel and sand that support the sludge and allow the liquid to infiltrate. The bottom of the drying bed is lined with perforated pipes to drain the leachate that percolates through the bed. Sludge should not be applied in layers that are too thick (maximum 30 cm), or the sludge will not dry effectively. The final moisture content after 10 to 15 days of drying should be approximately 60%. When the sludge reaches sufficient dryness, it must be separated from the sand layer and transported for further treatment, end

use or final disposal. The leachate that is collected in the drainage pipes must also be treated properly, for example in Waste Stabilisation Ponds (T.5), depending on where it is discharged.

**Design Considerations:** The drainage pipes are covered by three to five graded layers of gravel and sand. The bottom layer should be coarse gravel and the top layer fine sand (0.1 to 0.5 mm effective grain size). The top sand layer should be 20 to 30 cm thick because some sand will be lost each time the sludge is removed. To improve drying and percolation, sludge application can alternate between two or more beds. The number of beds needed is a function of the frequency of sludge arrivals and the number of days necessary for drying in the local climate, to which a few days must be added for sludge removal. The inlet should be equipped with a splash plate to prevent erosion of the sand layer and to allow for even distribution of the sludge. The bed surface depends essentially

on the characteristics of the local sludge and its capacity to dry, and on the climate. This translates into an admissible loading rate of around 50 kg total solids/m<sup>2</sup>/year in a temperate climate, and around 100 to 200 kg total solids/m<sup>2</sup>/year in a tropical climate. Usually, the beds are designed to be able to receive a 30 cm sludge layer. The design of the Unplanted Drying Beds must ensure access to people and trucks for discharging the sludge and removing the dried sludge. If installed in wet climates, the facility should be covered with a roof and special caution should be given to prevent the inflow of surface runoff.

**Materials:** Drying beds require the availability of gravel and sand of the correct grain size. Furthermore, piping for the drainage is needed. To remove dried sludge, shovels and rakes are required as well as personal protective equipment for the workers. The bed itself can be constructed with cement and bricks or concrete and needs to be sealed at the bottom.

**Applicability:** Unplanted Drying Beds are particularly adapted to warm climates and sludge that is stabilised and rather concentrated. Sludge drying is an effective way to decrease the volume of sludge, which is especially important when it has to be transported elsewhere for further treatment, end-use or disposal. Sludge drying is not effective at stabilising the organic fraction or decreasing the pathogenic content. Further storage or treatment of the dried sludge might be required to eliminate pathogens. Excessive rain or high humidity may prevent the sludge from properly drying. Unplanted Drying Beds are best suited where there is inexpensive, available space situated far from homes and businesses. If designed to service urban areas, they should be at the border of the community, but within economic reach for Motorised Emptying operators (C.2). The necessary surface area required can be reduced by thickening the sludge beforehand, for example in a Sedimentation/Thickening Pond (T.8).

**Operation and Maintenance:** A trained staff for operation and maintenance is required. Dried sludge can be removed after 10 to 15 days, depending on climatic conditions. It can be removed with shovels and wheelbarrows. Because some sand is lost with every removal of sludge, the top layer must be replaced when it gets thin. The discharge area must be kept clean and the effluent drains should be regularly flushed.

**Health and Safety:** Both the incoming and dried sludge are pathogenic. Workers should be equipped with proper personal protective equipment (boots, gloves, and clothing). The dried sludge and effluent are not sanitised and may require further treatment or storage, depending on the desired end-use. The leachate also needs further treatment.

**Costs:** This is an option with medium capital costs and low operating costs. As there is a lot of space required, the land costs might be considerable.

**Social Considerations:** Unplanted Drying Beds may cause a nuisance for nearby residents due to bad odours and the presence of flies. Thus, it should be located away from residential areas. The staff should be properly trained on sludge management and safety measures.

**Strengths and Weaknesses:**

- ⊕ Good dewatering efficiency, especially in dry and hot climates
- ⊕ Can be built and repaired with locally available materials
- ⊕ Relatively low capital costs; low operating costs
- ⊕ Simple operation
- ⊖ Requires a large land area
- ⊖ Odours and flies are normally noticeable
- ⊖ Labour intensive product removal
- ⊖ Limited stabilisation and pathogen reduction

→ **References and further reading material for this technology can be found on page 194**

# Planted Drying Beds

| Phase of Emergency                               | Application Level / Scale               | Management Level                 | Objectives / Key Features                             |
|--|---|----------------------------------|---|
| Acute Response<br>★ Stabilisation<br>★★ Recovery | Household<br>★ Neighbourhood<br>★★ City | Household<br>Shared<br>★★ Public | Sludge drying and humification,<br>Biomass production |
| Space Required                                   | Technical Complexity                    | Inputs                           | Outputs   |
| ★★★ High   | ★★ Medium                               | ● Sludge                         | ● Sludge, ● Effluent, ● Biomass                       |

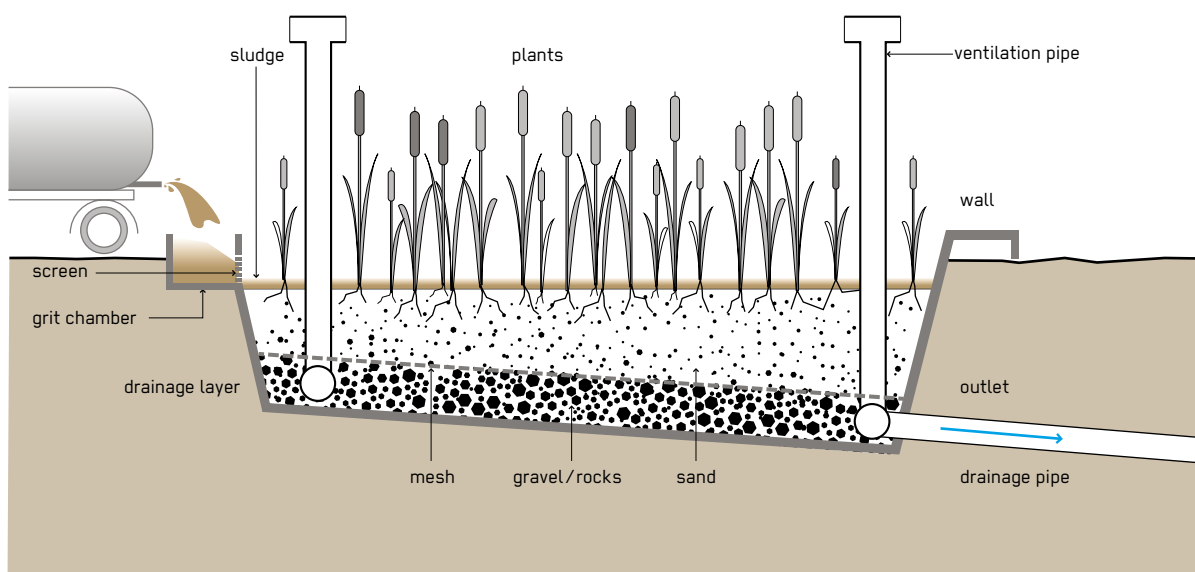

A Planted Drying Bed is similar to an Unplanted Drying Bed (T.9), but has the added benefit of transpiration and enhanced sludge treatment due to the plants. The key benefit of the planted bed over the unplanted bed is that the sludge does not need to be removed after each feeding/drying cycle, but does need to be removed every three to five years. Fresh sludge can be directly applied onto the previous layer.

Planted Drying Beds dewater and stabilise the sludge. Plants with their root systems maintain filter porosity, while creating pathways through the thickening sludge that allow water to easily percolate. Compared to Unplanted Drying Beds, Planted Drying Beds have the advantage that they function in humid climates. However, they need a continuous supply of sludge in order to keep plants alive. The appearance of the bed is similar to a vertical flow Constructed Wetland (T.6). The beds are filled with sand and gravel to support the vegetation. Sludge is

applied to the surface and the filtrate flows down through the subsurface where it is collected in drains. The final moisture content of humus after a few years should be around 60%, depending on the climatic conditions and the initial characteristics of the sludge.

**Design Considerations:** Ventilation pipes connected to the drainage system contribute to aerobic conditions in the filter. A general design for layering the bed is: 25 cm of coarse gravel (grain diameter of 2–4 cm); 10 cm of middle-sized gravel (grain diameter of 5–15 mm); 20 cm of fine gravel (grain diameter of 2–6 mm); and 5 cm of earth or coarse sand. Free space (1 m) should be left above the top of the sand layer to account for about three to five years of accumulation; a classic accumulation rate under tropical conditions is 20–30 cm/year. Reeds (*Phragmites* sp.), antelope grass (*Echinochloa* sp.) and papyrus (*Cyperus papyrus*) are suitable plants for the filter. Local, non-invasive species can also be used if they grow in damp



soil conditions, are resistant to salty water and readily reproduce after cutting. Sludge should be applied every three to seven days in layers between 7 to 10 cm thick, depending on the sludge characteristics, the environment and operating constraints. Sludge application rates of 100 to 200 kg total solids/m<sup>2</sup>/year have been reported in warm tropical climates. In colder climates loading rates from 50 to 70 kg total solids/m<sup>2</sup>/year are common. Two or more parallel beds should be alternately used to allow for sufficient degradation and pathogen reduction of the top layer of sludge before it is removed. The leachate drained by the drainage pipes must be treated properly, for example in Waste Stabilisation Ponds (T.5), depending on where it is discharged. The infrastructure must be designed to ensure good access for vacuum trucks and for removal of humus.

**Materials:** Planted drying beds require availability of gravel and sand with the right grain size. Local plants can be used. Furthermore, piping is needed for drainage and ventilation. To remove dried sludge, shovels and rakes are required as well as personal protective equipment (PPE). The bed itself can be constructed with cement and bricks or concrete and needs to be sealed at the bottom.

**Applicability:** This technology is effective at decreasing the sludge volume (down to 50%) through decomposition and drying, which is especially important when sludge needs to be transported elsewhere for end-use or disposal. It facilitates treatment of low-concentrated sludge. The sludge should be stabilised before being applied; in emergency settings where sludge often does not have much time to stabilise (e.g. in holding tanks with high emptying frequency), a prior treatment step may be needed. In dry climates, beds should be fed regularly to avoid drying of the plants. Planted Drying Beds are appropriate for towns or camps generating a constant sludge supply. They should be located as close as possible to initial sludge emptying to avoid high transport costs.

**Operation and Maintenance:** Trained operation and maintenance staff are required. They should be trained to distribute the sludge on the different beds properly and to manage the plants. The plants should be grown

sufficiently before applying the sludge. The acclimation phase is crucial and requires much care. Plants should be periodically thinned and/or harvested. After three to five years sludge can be removed, manually or mechanically. Drains must be maintained, and the effluent properly collected and subjected to further treatment and disposal options.

**Health and Safety:** Faecal sludge is hazardous and anyone working with it should wear proper PPE. The degree of pathogen reduction in the sludge will vary with the climate. Depending on the desired end-use, further storage and drying might be required. The leachate should be further treated. The planted beds may attract wildlife, including snakes.

**Costs:** This is an option with medium capital and low operating costs. The main capital costs are for civil engineering work and for appropriate filter media. The main operating costs are for the staff in charge of maintenance of the beds, and for sludge removal and replanting.

**Social Considerations:** Because of the pleasing aesthetics, there should be few problems with acceptance, especially if located sufficiently away from dense housing. The treatment process being aerobic, the odours are not strong and are mainly generated during the discharge from the trucks.

**Strengths and Weaknesses:**

- ⊕ Can handle high loading
- ⊕ Better sludge treatment than in Unplanted Drying Beds
- ⊕ Can be built and repaired with locally available materials
- ⊕ No electrical energy required
- ⊖ Requires a large land area
- ⊖ Requires specific skills to manage the plants
- ⊖ Odours and flies may be noticeable
- ⊖ Leachate requires further treatment

→ **References and further reading material for this technology can be found on page 194**

# Co-Composting

| Phase of Emergency   | Application Level / Scale  | Management Level   | Objectives / Key Features                                   |
|--|--|--|---|
| <ul style="list-style-type: none"> <li>★ Acute Response</li> <li>★ Stabilisation</li> <li>★★ Recovery</li> </ul> | <ul style="list-style-type: none"> <li>Household</li> <li>★★ Neighbourhood</li> <li>★★ City</li> </ul> | <ul style="list-style-type: none"> <li>Household</li> <li>★ Shared</li> <li>★★ Public</li> </ul> | Compost production, Pathogen removal                        |
| Space Required   | Technical Complexity   | Inputs   | Outputs   |
| <ul style="list-style-type: none"> <li>★★★ High</li> </ul>   | <ul style="list-style-type: none"> <li>★★ Medium</li> </ul>  | <ul style="list-style-type: none"> <li>● Organics, ● Sludge</li> </ul>                           | <ul style="list-style-type: none"> <li>● Compost</li> </ul> |

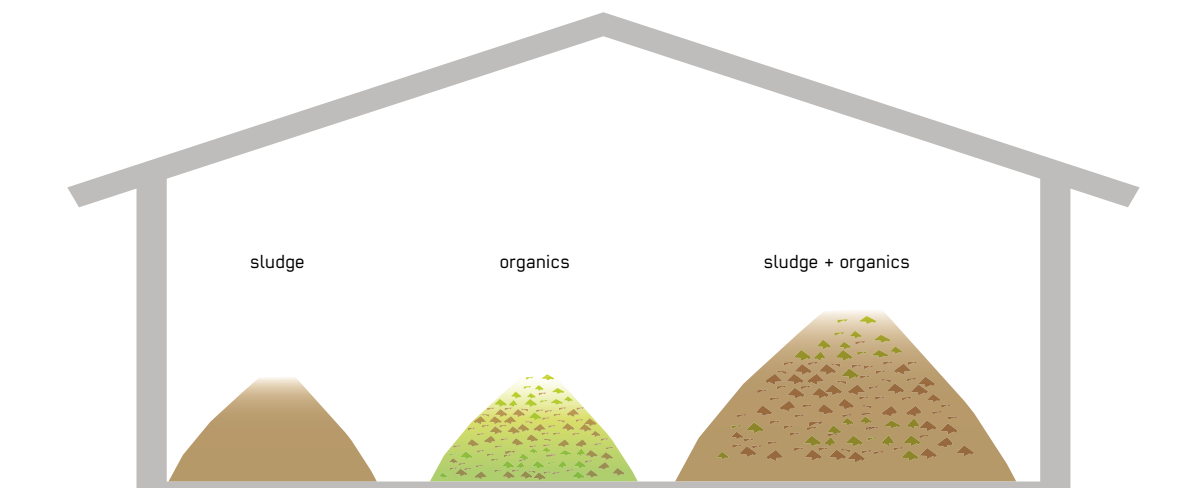

Co-Composting is the controlled aerobic degradation of organics, using more than one feedstock (faecal sludge and organic solid waste). Thermophilic conditions, marked by temperatures that exceed 60°C, are achieved when certain basic parameters (moisture, carbon-nitrogen (C:N) ratio, aeration) are met that result in the elimination of pathogens and rapid decomposition of the waste material. The process produces a safe, stable end product that can be used as a compost or soil amendment.

Faecal sludge has a high moisture and nitrogen content, while organic solid waste (from food or agricultural waste) is high in organic carbon and has good bulking properties which promotes aeration. By combining the two, the benefits of each can be used to optimise process and product. Three commonly used methods of Co-Composting are (1) open windrow, (2) in-vessel and (3) a combination of open-windrow and passively-aerated static pile. In open windrow Co-Composting, the mixed material (sludge and

organic waste) is piled into long heaps called windrows and left to decompose. In-vessel Co-Composting requires controlled moisture, air supply and mechanical mixing. The third method uses a combination of static-pile and open-windrow. Waste sits in a static-pile for around two to three months and then it is moved to windrows for further decomposition.

**Design Considerations:** Key components in the design of a Co-Composting facility include space for sorting and waste separation, drying beds, composting units, screening, storage of compost and discards, hygiene and disinfection infrastructure, on-site wastewater treatment system, staff facilities and a buffer zone. Depending on the climate and available space, the facility may need to be covered. The facility should be located close to sources of organic waste and faecal sludge to minimise transport costs, but still a distance away from living areas to minimise any perceived or real health risks. Windrow

piles should be at least 1 m high and insulated with a 30 cm layer of compost, soil, or grass soil to promote an even distribution of heat. In colder climates heaps work best at 2.5 m high and 5 m wide. Sludge must be dewatered in Unplanted Drying Beds (T.9) prior to mixing with organic waste. A sealed or impervious composting pad (the surface where the heaps are located) must be constructed to collect the leachate which can then be reintegrated into the piles or treated.

**Materials:** Co-Composting facilities can be constructed using locally available material. The compost pad can be made out of concrete, or well-compressed clay. If required, a cover/roof can be made from local materials such as bamboo, grass matting, or wood, plastic or metal sheeting. Water may be a required additive, depending on the climate. Prefabricated composting vessels of different sizes are available on the market.

**Applicability:** Because of the high level of organisation and labour needed to sort organic waste, manage the facility and monitor treatment efficiency, this technology is unlikely to be practical in the acute response phase. However, it can be considered a viable option in the stabilisation and recovery phases of an emergency. Experience has shown that Co-Composting facilities operate best when they are established as a business with compost as the marketable product that can generate revenue to support cost recovery. However, compost sales cannot be expected to cover the full cost of the service.

**Operation and Maintenance:** The operation requirements for Co-Composting facilities are high. Well-trained maintenance staff must carefully monitor quality and quantity of input material, the C:N ratio, and manage moisture and oxygen content. Staff should also carefully track turning schedules, temperature, and maturing times to ensure high-quality treatment. Organic waste must first be sorted so it is free from non-organic materials. Turning must be periodically done with either a front-end loader or by hand using a pitch fork or shovel. Robust grinders for shredding large pieces of organic solid waste (i.e., small branches and coconut shells) and pile turners help to optimise the process, reduce manual labour, and ensure a more homogenous end product.

**Health and Safety:** Health risks can be minimised if workers adopt basic precautions and hygienic practices and wear personal protective equipment. If material is found to be dusty, proper ventilation should be provided and workers should wear masks. To ensure pathogens are removed to a safe level, the World Health Organization (WHO) recommends that compost temperature should be maintained between 55–60 °C for at least one week. If there is any doubt, compost should be stored for at least a year before use. If resources exist, helminth egg inactivation should be monitored as a proxy measure of sterilisation. WHO guidelines should be consulted for detailed information.

**Costs:** Costs of building a Co-Composting facility vary depending on the method chosen and the cost of local materials and if machinery such as aerators and grinders are included in the design. The main costs to consider are the overall operation requirements including transport and supply of faecal sludge and organic solid waste and disposal of compost.

**Social Considerations:** Before considering a Co-Composting system, the concept should be discussed with the affected community. If the community has experience of separating their organic waste and composting, this can be an enabling factor. Identifying that compost made from human waste is an acceptable product for potential users (market survey) and ensuring that the compost product conforms to local guidelines/standards are necessary prerequisites. Without these, different treatment processes should be identified.

**Strengths and Weaknesses:**

- ⊕ Sustainable management of organic waste
- ⊕ Proven, effective treatment method
- ⊕ Can be built and maintained with locally available materials
- ⊕ Valuable end-product available for many uses and can be sold to defray operational costs
- ⊖ Requires a large, well located land area
- ⊖ Long treatment times
- ⊖ Transport of input products can be costly
- ⊖ Control over input quality is required

→ **References and further reading material for this technology can be found on page 194**

# Vermicomposting and Vermifiltration (Emerging Technology)

| Phase of Emergency                                 | Application Level / Scale                | Management Level  | Objectives / Key Features                              |
|--|--|---|--|
| ★ Acute Response<br>★ Stabilisation<br>★★ Recovery | Household<br>★★ Neighbourhood<br>★★ City | Household<br>★ Shared<br>★★ Public  | Compost production, Pathogen removal, Sludge reduction |
| Space Required                                     | Technical Complexity                     | Inputs  | Outputs  |
| ★★ Medium  | ★★ Medium                                | ● Urine, ● Faeces, ● Sludge,<br>● Anal Cleansing Water),<br>● Dry Cleansing Materials),<br>● Flush Water) | ● (Vermi-)Compost, ● Effluent                          |

vermicomposting

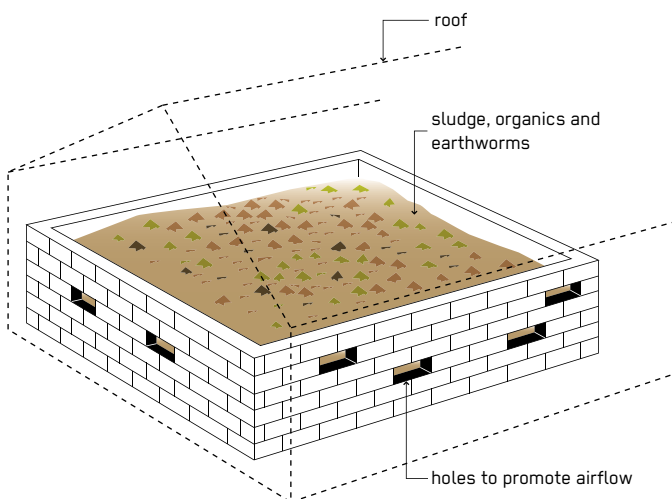

vermifiltration

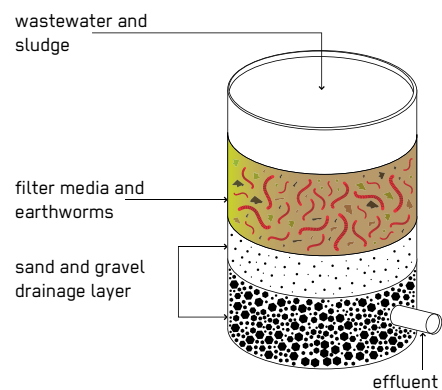

Vermicomposting and Vermifiltration are two low cost, options for human waste treatment in which earthworms are used as biofilters. The end-product is worm cast or vermicompost which contains reduced levels of contaminants and depending on the processes chosen can reduce volume of faecal sludge by over 90%. Vermicompost contains water-soluble nutrients and is an excellent, nutrient-rich organic fertiliser and soil conditioner.

Both Vermicomposting and Vermifiltration are aerobic treatment systems. Two parameters are particularly important: moisture content and the carbon to nitrogen (C:N) ratio. Faecal sludge has a high moisture and nitrogen content, while organic solid waste is high in organic carbon and has good bulking properties which promotes aeration. By combining the two, the benefits of each can be used to optimise process and product. The most commonly used method of Vermicomposting is the in-vessel method. Vermifiltration happens in a water-tight

container and can receive more liquid inputs such as wastewater or watery sludge.

**Design Considerations:** The design of a Vermicomposting facility is similar to Co-Composting (T.11) using vessels and with the addition of earthworms. Vermifilters consist of enclosed reactors containing filter media and worms. These are used on a small scale in Worm-Based Toilets (S.12). In Vermifiltration systems the solids (faecal sludge and toilet paper) are trapped on top of the filter where they are processed into humus by the worms and bacteria, while the liquid passes through the filter. In separating solid and liquid fractions the quality of the effluent is increased. Ventilation must be sufficient to ensure an aerobic environment for the worms and microorganisms, while also inhibiting entry of unwanted flies. The temperature within the reactor needs to be maintained within a range suitable for the species of compost worms used. The specific design of a vermifilter will depend on the

characteristics and volume of sludge. Vermicomposting or vermifilters can be combined with other treatments - for example, the digestate from anaerobic digestion (S.13–S.16) could be vermifiltered to achieve solids reduction and increase pathogen elimination. Effluent produced during the vermifiltration process can be directly infiltrated into the soil, or further treated through evapotranspiration in a planted system.

**Materials:** Vermicomposting tanks can be made from local materials (bricks or concrete). Vermifilters require enclosed reactors made from durable materials that eliminate vermin entry, usually plastic or concrete. Filter material for the vermifilter can be sawdust, straw, coir, bark mulch or peat. Worms are required, and three species to date have been successfully used: *Eisenia fetida*, *Eudrilus eugeniae* and *Eisenia andrei*. It is possible to find worms in the local environment, buy them from vermicomposting or vermifilter businesses or import them. Prefabricated composting vessels of different sizes are available on the market.

**Applicability:** Vermifiltration can be applied in all emergency phases provided there is access to worms. Vermicomposting requires a high level of organisation and labour to sort organic waste, manage the facility and monitor treatment efficiency and is therefore unlikely to be practical in the acute response phase of emergency situations. However, it can be considered a viable option in the stabilisation and recovery phases where there is an available source of well-sorted organic solid waste and space. Experience has shown that vermicomposting facilities operate best when they are established as a business venture with compost as a marketable product that can generate revenue to support cost recovery. However, compost sales cannot be expected to cover the full cost of the service.

**Operation and Maintenance:** A Vermicomposting facility requires well-trained maintenance staff to carefully monitor quality and quantity of the input material and worm health as well as manage moisture and oxygen content. Organic waste must first be sorted so it is free from plastics and other non-organic materials. Turning must be periodically done with either a front-end loader or by hand using a pitch fork or shovel. A Vermifilter has low mechanical and manual maintenance requirements, and where gravity-operated requires no energy inputs. Recirculation, if required for improved effluent quality, would require a pump.

**Health and Safety:** Unlike Co-Composting (T.11), pasteurising temperatures cannot be achieved as worms and bacteria are sensitive to extreme temperatures, thus for wastes containing high levels of pathogens (such as raw sewage or septic tank waste), further treatment may be required to produce a pathogen-free compost. Health risks can be minimised if adequate control measures are consistently practiced, and workers adopt basic precautions, hygiene practices and wear personal protective equipment. If material is found to be dusty, workers should wear masks. Vermicompost should be stored for at least a year before use. If resources exist, helminth egg inactivation should be monitored as a proxy measure of sterilisation. If reuse is not intended the compost can either be buried or brought to a final disposal site. The World Health Organization guidelines should be consulted for detailed information.

**Costs:** Costs of building a Vermicompost facility vary depending on the method chosen and the cost of local materials and if machinery such as aerators are included in the design. The main costs to consider are the overall operation requirements including transport and supply of faecal sludge and organic solid waste and disposal of compost. The cost of vermifilters depends on the scale and design of the system.

**Social Considerations:** Before considering a Vermicomposting system, the concept needs to be discussed with the affected community beforehand. If the community has experience with separating organic waste and composting this can be a facilitating factor. Identifying that compost made from human waste is an acceptable product for potential users (market survey) and ensuring that the compost product conforms to local guidelines/standards are necessary prerequisites. Without these, different treatment processes should be identified.

**Strengths and Weaknesses:**

- ⊕ Reduces quantity of organic waste
- ⊕ Simple robust technology
- ⊕ Can be built and maintained with locally available materials
- ⊕ Relatively low capital costs
- ⊖ Requires a large, well located land area (Vermicomposting)
- ⊖ Rodents can be attracted to the organic material (food waste etc.)

→ **References and further reading material for this technology can be found on page 194**

# Activated Sludge

| Phase of Emergency                               | Application Level / Scale               | Management Level                         | Objectives / Key Features   |
|--|---|--|---|
| Acute Response<br>★ Stabilisation<br>★★ Recovery | Household<br>★ Neighbourhood<br>★★ City | Household<br>Shared<br>★★ Public         | BOD reduction, Nitrification and nutrient removal, Pathogen reduction |
| Space Required                                   | Technical Complexity                    | Inputs                                   | Outputs   |
| ★★ Medium  | ★★★ High                                | ● Blackwater, ● Greywater,<br>● Effluent | ● Effluent, ● Sludge  |

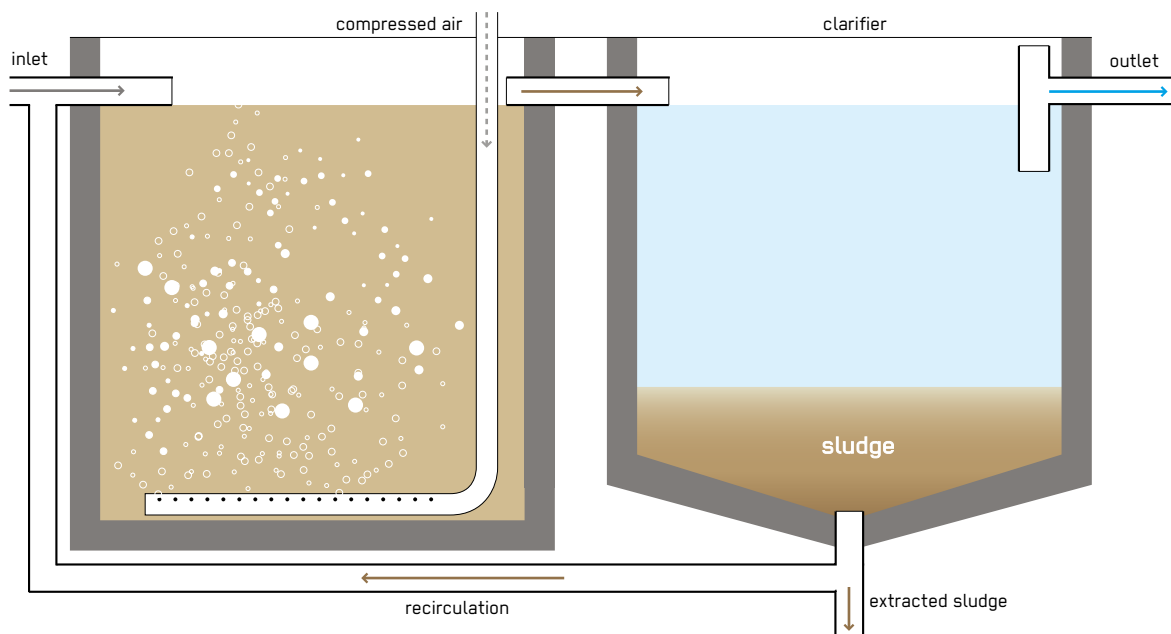

An Activated Sludge process refers to a multi-chamber reactor unit that makes use of highly concentrated microorganisms to degrade organics and remove nutrients from wastewater to produce a high-quality effluent. To maintain aerobic conditions and to keep Activated Sludge suspended, a continuous and well-timed supply of oxygen is required.

Different configurations can be employed to ensure wastewater is mixed and aerated. Aeration and mixing can be provided by pumping air or oxygen into the tank or by using surface aerators. Microorganisms oxidise organic carbon in wastewater to produce new cells, carbon dioxide and water. Aerobic bacteria are the most common organisms, but facultative bacteria along with higher organisms can be present. The exact composition depends on the reactor design, the environment, and wastewater characteristics. Several weeks are needed to establish the microorganisms required for a stable biological process.

The flocs (agglomerations of sludge particles), which form in the aerated tank, are removed in the secondary clarifier by gravity settling. Excess sludge is partially removed and partially recycled for the biological process. In an immersed membrane bioreactor (IMBR), the activated sludge reactor is combined with a micro- or ultrafiltration membrane unit. By passing the membrane, treated water gets separated from sludge. The system can be set up as a pre-assembled solution or can be constructed on-site. The IMBR is an efficient compact technology for municipal (and industrial) wastewater treatment. The major drawback impeding wider application is membrane fouling, which significantly reduces membrane performance and lifespan, resulting in a significant increase in operation and maintenance (O & M) costs.

**Design Considerations:** Activated Sludge processes usually require primary treatment that removes settleable solids and are sometimes followed by a final polishing

step **(POST)**. The biological processes are effective at removing soluble, colloidal and particulate materials. The reactor can be designed for biological nitrification and denitrification, as well as for phosphorus removal. The design must be based on an accurate estimation of the wastewater composition and volume. Treatment efficiency can be severely compromised if the plant is under- or over-dimensioned. Depending on the temperature, the solids retention time in the reactor ranges from 3–5 days for biochemical oxygen demand (BOD) removal, to 3–18 days for nitrification. Excess sludge requires treatment to reduce its water and organic content and to obtain a stabilised product suitable for reuse or final disposal. To achieve specific effluent goals for BOD, nitrogen and phosphorus, different adaptations and modifications can be made, which include sequencing batch reactors, oxidation ditches, extended aeration, moving beds and membrane bioreactors.

**Materials:** Usually the Activated Sludge reactor is made of plastic or concrete. The aerators consist of stainless steel or plastic and a membrane of rubber seal. For the potential subsequent membrane process either ceramic, polymeric, or composite membranes can be used. The material used has an impact on fouling propensity in IMBRs. Different pre-fabricated models are available.

**Applicability:** Activated Sludge treatment can be an appropriate solution in the stabilisation and recovery phases of a humanitarian emergency, particularly in more densely populated urban areas or larger camp contexts where water-based systems are preferred. It is a centralised treatment that needs well-trained staff, constant electricity and a highly developed management system. Because of economies of scale and less fluctuating influent characteristics, it is more effective for treatment of larger volumes. Activated Sludge processes are appropriate in almost every climate, but treatment capacity is reduced in colder environments. Given that the system is well operated the quality of the treated water can be suitable for reuse.

**Operation and Maintenance:** Trained technical staff are required for maintenance and trouble-shooting. Mechanical equipment (mixers, aerators and pumps) must be constantly maintained. Influent and effluent must be continuously monitored and control parameters adjusted, if necessary, to avoid abnormalities like kill-off of active

biomass or development of detrimental organisms (e.g. filamentous bacteria). Access to the facility should only be allowed to trained personnel.

**Health and Safety:** Due to the space required and odour produced, Activated Sludge facilities are generally located on the periphery of densely populated areas. Although the effluent produced is of high quality, it still poses a public health risk and should not be directly handled. In the excess sludge, pathogens are substantially reduced but not eliminated. IMBR performance and treatment quality can be improved depending on the membrane used. Involved personnel need to be equipped with proper personal protective equipment.

**Costs:** Capital costs for Activated Sludge facilities are high. Costs may vary depending on availability and costs of construction material and electricity. Due to the requirements of skilled staff, continuous monitoring tasks and constant energy requirements the operational costs are high and need to be reflected in the total cost calculations.

**Social Considerations:** The installation of an activated sludge reactor should be carried out in areas where there is knowledge and experience with this technology and skilled personnel are available. Depending on the cultural context and existing regulations there may be barriers to re-using processed water.

**Strengths and Weaknesses:**

- ⊕ Resistant to sudden loads of organic material or flow increases
- ⊕ High reduction of BOD and pathogens (up to 99%)
- ⊕ High nutrient removal possible
- ⊕ Can be modified to meet specific discharge limits
- ⊖ High energy consumption requiring constant source of electricity
- ⊖ High capital and operating costs
- ⊖ Requires expert design and O & M by skilled personnel and not all parts and materials may be locally available
- ⊖ Prone to complicated chemical and microbiological problems

→ **References and further reading material for this technology can be found on page 194**

# Tertiary Filtration and Disinfection

| Phase of Emergency   | Application Level / Scale   | Management Level   | Objectives / Key Features  |
|--|---|--|--|
| <ul style="list-style-type: none"> <li>★ Acute Response</li> <li>★ Stabilisation</li> <li>★★ Recovery</li> </ul> | <ul style="list-style-type: none"> <li>Household</li> <li>★ Neighbourhood</li> <li>★★ City</li> </ul> | <ul style="list-style-type: none"> <li>Household</li> <li>★ Shared</li> <li>★★ Public</li> </ul> | Removal of residual suspended solids and pathogens                   |
| Space Required   | Technical Complexity  | Inputs   | Outputs  |
| <ul style="list-style-type: none"> <li>★ Little</li> </ul>   | <ul style="list-style-type: none"> <li>★★ Medium</li> </ul>   | <ul style="list-style-type: none"> <li>● Effluent</li> </ul>                                     | <ul style="list-style-type: none"> <li>● Treated Effluent</li> </ul> |

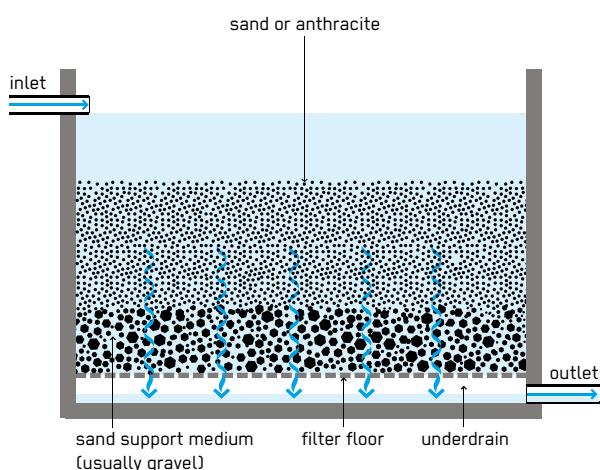

tertiary filtration (e.g. depth filtration)

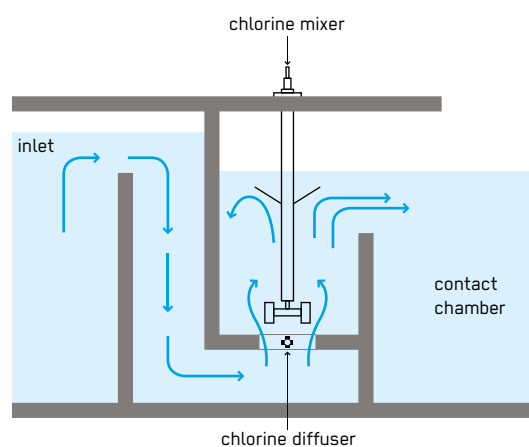

disinfection (e.g. chlorination)

Depending on the end-use of the effluent or national standards for discharge and end-use, a Post-Treatment step may be required to remove pathogens, residual suspended solids and/or dissolved constituents. Tertiary Filtration and Disinfection processes are most commonly used to achieve this.

Post-Treatment is not always necessary and a pragmatic approach is recommended. The effluent quality should correspond with any intended end-use, the quality of the receiving water body or local regulations for effluent discharge. The World Health Organization Guidelines provide useful information on risk assessment and management associated with microbial hazards and toxic chemicals. Chlorine solutions can disinfect an effluent with low organic content and reduce pathogens in faecal sludge, however, the chlorine is scavenged by oxidation of organics and thus not used in an efficient manner. Disinfection of sludge is not Post-Treatment and can be done through

Lactic Acid Fermentation (S.19), Urea Treatment (S.18) and Lime Treatment (S.17).

**Design Considerations:** Tertiary Filtration processes can be classified as either depth (or packed-bed) filtration or surface filtration (e.g. membranes). Depth filtration involves removal of residual suspended solids by passing the liquid through a filter bed made of a granular filter medium (e.g. sand). If activated carbon is used as the filter medium, the dominating process is adsorption. Activated carbon absorbers remove a variety of organic and inorganic compounds, and also eliminate taste and odour. Surface filtration involves the removal of particulate material by mechanical sieving as the liquid passes through a thin septum (e.g. filter layer). Depth filtration is successfully used to remove protozoan cysts and oocysts, while ultrafiltration membranes reliably eliminate bacteria and viruses. Low pressure membrane filtration processes (including gravity-driven membrane filters) are being developed.



Disinfection includes the destruction, inactivation, and/or removal of pathogenic microorganisms achieved by chemical, physical, or biological means. Due to its low cost, availability and easy operation, chlorine has historically been the disinfectant of choice for treating wastewater. Chlorine oxidises organic matter, including microorganisms and pathogens. Alternative disinfection systems include ultraviolet (UV) light and ozonation. UV light found in sunlight kills viruses and bacteria. Disinfection can thus take place in shallow ponds. UV radiation can also be generated through special lamps, which can be installed in a channel or pipe. Ozone is a powerful oxidant and is generated from oxygen in an energy-intensive process. It degrades both organic and inorganic pollutants, including odour-producing agents.

**Materials:** Post-Treatment technologies require special materials. Accessing chlorine, UV lamps, filter materials such as activated carbon or membranes may be a challenge, especially during an acute response phase. Accessing chlorine may be sensitive as it can be used for the construction of chemical weapons.

**Applicability:** The decision to install a Post-Treatment technology depends mainly on quality requirements for desired end-use and/or national standards. Other factors to consider are effluent characteristics, budget, availability of materials, and operation and maintenance capacity. Post-Treatment can only be applied effectively after a functioning secondary treatment. Pathogens tend to be masked by suspended solids in unfiltered secondary effluent. Chlorine should not be used if water contains significant amounts of organic matter, as disinfection by-products can form. Post-Treatment is not a high priority during the acute response. However, as it is very effective in removing pathogens, it can be considered for implementation during recovery to minimise public health risks.

**Operation and Maintenance:** Post-Treatment methods require continuous monitoring (influent and effluent quality, head loss of filters, dosage of disinfectants, etc.) to ensure high performance. Due to the accumulation of solids and microbial growth, the effectiveness of sand, membrane and activated carbon filters decreases over time. Frequent cleaning (backwashing) or replacement of filter material is required. Expert know-how is required,

especially to avoid damaging membranes or to determine the right dosage of chlorine and ensure proper mixing. Ozone must be generated on-site because it is chemically unstable and rapidly decomposes to oxygen. In UV disinfection, the UV lamp needs regular cleaning and annual replacement.

**Health and Safety:** Personal protective equipment should be used at all times. If chlorine (or ozone) is applied to an effluent that is not well treated, disinfection by-products such as trihalomethanes may form and threaten environmental and human health. There are also safety concerns related to handling and storage of liquid chlorine. Activated carbon adsorption and ozonation can remove unpleasant colours and odours, increasing the acceptance of reusing reclaimed water. Filter media are contaminated after use and need proper treatment/disposal when replaced.

**Costs:** Sand filtration and ponds are relatively cheap (but the latter needs a lot of space), while activated carbon and membrane filters are costlier. In activated carbon adsorption, the filter material needs to be regularly replaced. Ozonation costs are generally higher compared to other disinfection methods. Chlorine is often widely available and not expensive.

**Social Considerations:** Professionals are needed to operate and manage Post-Treatment technologies.

**Strengths and Weaknesses:**

- ⊕ Additional removal of pathogens and/or chemical contaminants
- ⊕ May allow for direct reuse of the treated wastewater
- ⊖ Skills, technology, spare parts and materials may not be locally available
- ⊖ Constant source of electricity and/or chemicals needed
- ⊖ Filter materials need regular backwashing or replacement
- ⊖ Chlorination and ozonation can form toxic disinfection by-products

→ **References and further reading material for this technology can be found on page 195**

# Use and/or Disposal

This section presents the different technologies and methods which can be used for products after storage, transport and treatment to ultimately return them to the environment, either as useful resources or reduced-risk materials. The return of products to the environment should, in the worst case, be done in such a way as to minimise risks to public and environmental health, and in the best case, aim to maximise the benefits of reuse (e.g. by improving soils, as a fertiliser etc.) Where relevant, the World Health Organization (WHO) Guidelines for the Safe Use of Wastewater, Excreta and Greywater are referenced in the technology information sheets.

- D.1 Application of Stored Urine
- D.2 Application of Dried Faeces
- D.3 Application of Pit Humus and Compost
- D.4 Application of Sludge
- D.5 Fill and Cover: Arborloo and Deep Row Entrenchment
- D.6 Surface Disposal and Sanitary Landfill
- D.7 Use of Biogas
- D.8 Co-Combustion of Sludge (Emerging Technology)
- D.9 Leach Field
- D.10 Soak Pit
- D.11 Irrigation
- D.12 Water Disposal and Groundwater Recharge
- D.13 Fish Ponds

The choice of use and/or disposal technology is contextual and generally depends on the following factors:

- Type and quality of products
- Socio-cultural acceptance
- Local demands
- Local laws and regulations
- Availability of materials and equipment
- Availability of space
- Soil and groundwater characteristics
- Local capacity

D

# Application of Stored Urine

| Phase of Emergency                               | Application Level / Scale                   | Management Level                       | Objectives / Key Features                        |
|--|---|--|--|
| Acute Response<br>★ Stabilisation<br>★★ Recovery | ★★ Household<br>★★ Neighbourhood<br>★★ City | ★★ Household<br>★★ Shared<br>★★ Public | Productive use of nutrients as liquid fertiliser |
| Space Required                                   | Technical Complexity                        | Inputs                                 | Outputs  |
| ★★★ High   | ★ Low                                       | ● Stored Urine                         | ● Biomass  |

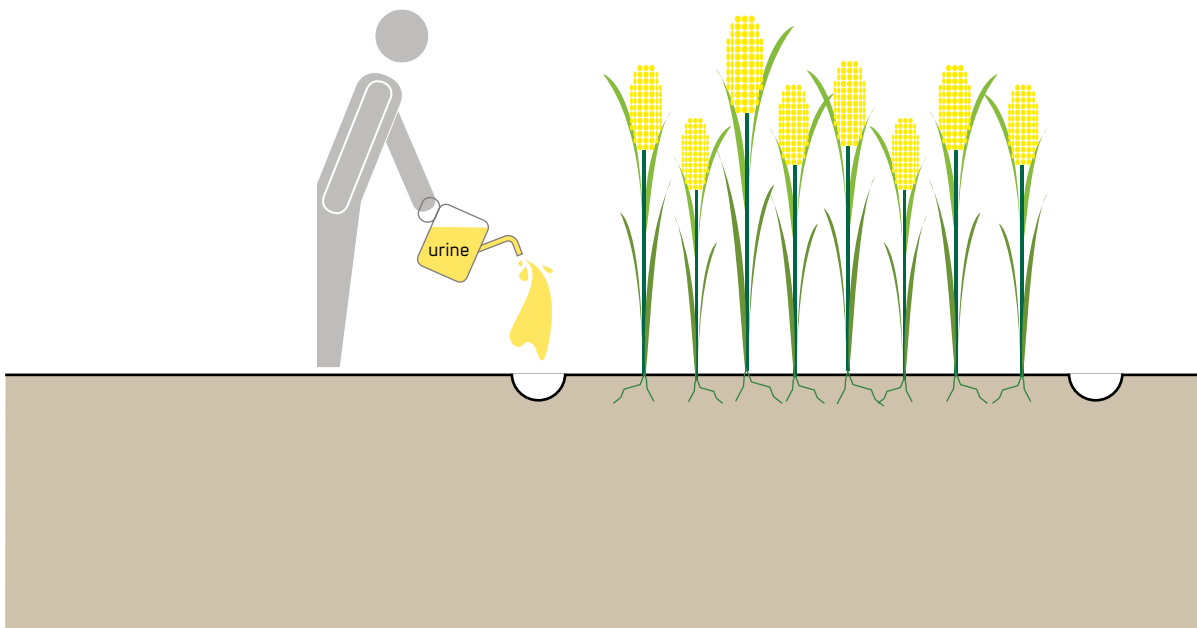

Stored urine coming from urine diverting sanitation systems (U.2, S.8, S.9) is a concentrated source of nutrients that can be applied as a liquid fertiliser in agriculture (to replace or substitute chemical fertilisers) or as an additive to enrich compost.

Urine contains most of the nutrients excreted by the body. Soluble substances in urine include essential plant nutrients such as the macronutrients nitrogen (N), phosphorus (P) and potassium (K) as well as smaller quantities of micronutrients such as boron (B), iron (Fe) and zinc (Zn). The nutrients in urine are in a form readily available to plants, similar to ammonia and urea based fertilisers, and with comparable results on plant growth. The World Health Organization guidelines recommend that urine is stored for at least one month before being used in agriculture at the household level. In larger systems, storage times should be longer (up to six months). Urine from healthy people is considered free of pathogens. For fully grown individuals

there is nearly a mass balance between nutrient consumption and excretion. The nutrient content in urine is dependent on diet, sex, climate, water intake, time of the day when excreted etc. Roughly 88% of N, 61% of P and 74% of K excreted by the human body is in urine.

**Design Considerations:** Stored urine should not be applied directly to plants due its high pH. Instead, it can be applied directly to the soil before planting, by pouring into furrows or holes at a sufficient distance away from plant roots and immediately covered, or it can be diluted several times, and used frequently on plants as a general fertiliser. A good availability of nutrients is particularly important in the early stages of cultivation. Once crops enter their reproductive stage they adsorb few nutrients. Fertilisation should therefore stop after  $\frac{2}{3}$  to  $\frac{3}{4}$  of the time between sowing and harvest. The optimal application rate depends on N demand, the tolerance of the crops and N concentration in the (diluted) urine. The annual urine volume from

one person is sufficient to fertilise around 300–400 m<sup>2</sup> of cropland. There is no standard recommendation for dilution and existing recommendations vary widely (usually between ratios of 1:3 to 1:10). The advantages of dilution are a noticeable odour reduction and a decreased risk of over-application. At the same time dilution increases the total volume and thus labour and transport needs. Diluted urine can also be used like any fertiliser in (drip) irrigation systems, commonly referred to as “fertigation”.

**Materials:** Materials needed include sufficient closed containers to store urine for one month or more, agricultural equipment to dig furrows and holes and watering pots or (drip) irrigation devices. People involved in using urine in agricultural production should be provided with personal protective equipment such as shoes, gloves and masks.

**Applicability:** Urine Application is not considered a priority in acute emergencies, but might be an option during the stabilisation and recovery phases provided it is acceptable to the local population and farmers have an interest in using urine as a fertiliser. Urine fertilisation is ideal for rural and peri-urban areas where agricultural lands are close to the point of urine collection. Households can use urine on their own plot of land or if facilities and infrastructure exist, urine can be collected at a semi-centralised location for distribution and transport to agricultural land. Stored urine has a relatively strong odour and can be offensive to work with. If urine is diluted and immediately tilled into the soil the odour can be reduced.

**Operation and Maintenance:** Over time, some minerals in urine will precipitate (e.g. calcium and magnesium phosphates). Equipment that is used to collect, transport or apply urine (e.g. watering cans with small holes) can thus clog over time. Most deposits can easily be removed with hot water and a little weak acid, such as vinegar.

**Health and Safety:** Urine poses a minimal risk of infection, especially when stored for an extended period, however urine should be carefully handled and a waiting period of one month between fertilisation and harvest should be respected. Urine should be applied close to the ground, thus reducing the possibility of direct contact with the

edible parts of plants. As an additional safety measure, urine use could be restricted to non-food crops (flowers), crops that are processed or cooked before consumption (e.g. eggplant), or crops or trees that allow for a minimum distance between the soil and harvested part of the crop (e.g. all kinds of fruit trees). As hormones and pharmaceuticals are partly excreted with urine, there is a small possibility that these will be adsorbed by plants and enter the human food chain. This risk is however minimal when compared to the risks associated with the pharmaceuticals in animal manure, pesticide use or the direct discharge of untreated wastewater into water bodies.

**Costs:** The costs for urine application are low. However, urine application can be labour intensive and land availability could be an issue. If urine needs to be transported over longer distances, transport costs might be considerable and not always economically viable as urine has a relatively low value per volume. However, urine fertilisation could offer livelihood opportunities, improved yields and the potential to substitute costly chemical fertilisers with a readily available product.

**Social Considerations:** The potential application of urine in agriculture should be discussed with the affected communities beforehand. Regular training or orientation may be needed in order to support acceptance, ensure proper application and to avoid accidental misuse.

**Strengths and Weaknesses:**

- ⊕ May encourage income generation (improved yields)
- ⊕ Reduces dependence on chemical fertilisers
- ⊕ Low risk of pathogen transmission
- ⊕ Low cost
- ⊖ Urine is heavy, difficult to transport and application is labour intensive
- ⊖ Odour may be offensive
- ⊖ Risk of soil salinisation if the soil is prone to accumulation of salts
- ⊖ Social acceptance may be low in some areas

→ **References and further reading material for this technology can be found on page 195**

# Application of Dried Faeces

| Phase of Emergency                               | Application Level / Scale               | Management Level                      | Objectives / Key Features                            |
|--|---|---------------------------------------|--|
| Acute Response<br>★ Stabilisation<br>★★ Recovery | ★★ Household<br>★ Neighbourhood<br>City | ★★ Household<br>★★ Shared<br>★ Public | Productive use of nutrients, Use as soil conditioner |
| Space Required                                   | Technical Complexity                    | Inputs                                | Outputs  |
| ★★★ High   | ★ Low                                   | ● Dried Faeces                        | ● Biomass  |

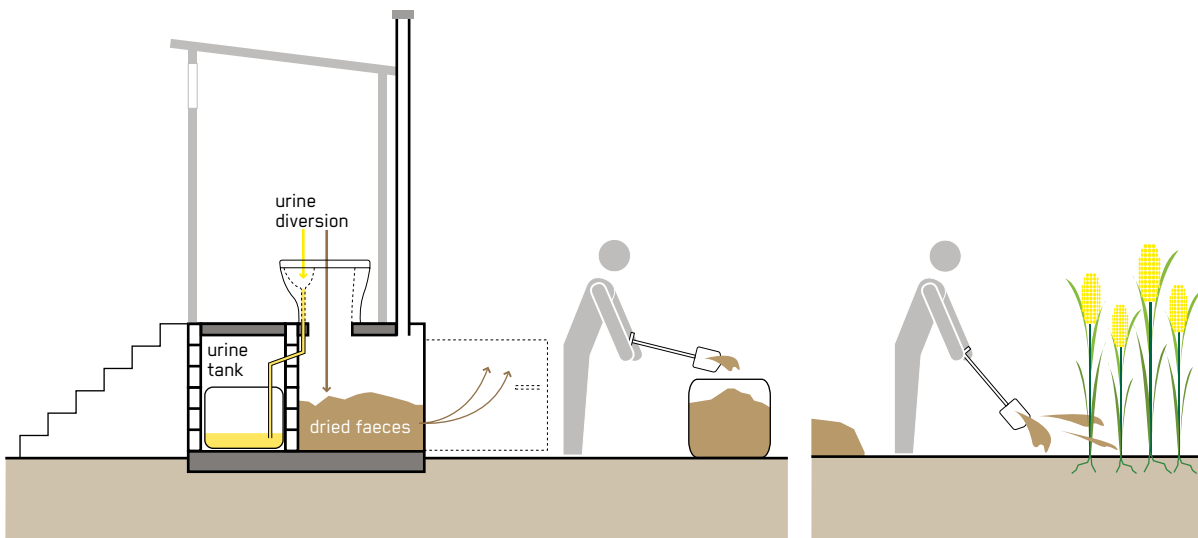

When faeces are stored in the absence of moisture (e.g. urine or anal cleansing water), they dehydrate into a coarse, crumbly, white-beige, material or powder and can be used as a soil conditioner.

Dehydration is very different from composting as the organic material is not degraded or transformed, only the moisture is removed through the addition of drying materials after defecation and proper ventilation and time. Through dehydration faeces can reduce in volume by about 75%. Completely dry faeces are a crumbly, powdery substance. The material is rich in carbon and nutrients, but can still contain worm eggs, protozoan cysts or oocysts (spores that can survive extreme environmental conditions and be re-animated under favourable conditions) and other pathogens. The degree of pathogen inactivation will depend on the temperature, the pH (using ash or lime raises the pH) and the storage time. It is generally recommended that faeces should be stored and

dehydrated for between 6 to 24 months, although pathogens can remain viable even after this time. See World Health Organization (WHO) Guidelines for the Safe Use of Wastewater, Excreta and Greywater for more specific guidance. The dehydrated faeces can be used as an additive in subsequent composting, mixed directly into the soil or buried elsewhere if reuse is not intended. Extended storage is also an option if there is no immediate use for the material.

**Design Considerations:** Faeces that are dried and kept at between 2 and 20 °C should be stored for 1.5 to 2 years before being used. At higher temperatures (> 20 °C average), storage over one year is recommended to inactivate helminths (e.g. *Ascaris* eggs). A shorter storage time of six months is required if the faeces have a pH above 9 (e.g. by adding ash or lime increases the pH). For further detail the WHO Guidelines for the Safe Use of Wastewater, Excreta and Greywater should be consulted.

**Materials:** The Application of Dried Faeces requires wheelbarrows, shovels, spades, rakes, and personal protective equipment (PPE). For cultivating the land where dried faeces have been applied other gardening tools may be required. Dried faeces can be stored and transported in used containers or bags.

**Applicability:** The Application of Dried Faeces is usually not considered a priority in acute emergencies, but might be an option during the stabilisation and recovery phases provided it is acceptable to the local population, farmers and potential consumers of agricultural products. Dried faeces can help improve poor soils and boost its carbon and water-storing properties, while posing low risk of pathogen transmission. Dried faeces are less efficient as a soil amendment than composted faeces. The dehydration process works best in hot and dry climates.

**Operation and Maintenance:** When removing dehydrated faeces from dehydration vaults, care must be taken to avoid the powder being inhaled. Workers should wear PPE. Faeces should be kept as dry as possible. If water or urine enters and mixes with drying faeces, more drying material should be added to help absorb the moisture. Prevention is the best way to keep faeces dry.

**Health and Safety:** Dehydrated faeces are a hostile environment for organisms and most pathogens die off relatively quickly (usually within weeks). However, some pathogens (e.g. *Ascaris* eggs) may remain viable even after longer drying periods and therefore a secondary treatment like Co-Composting (T.11) or Vermicomposting (T.12) is recommended before dehydrated faeces are applied in agriculture. Dried faeces are usually incorporated into the soil prior to the planting season and the WHO Guidelines for the Safe Use of Wastewater, Excreta and Greywater

with its flexible multi-barrier approach should be consulted for further guidance. PPE (e.g. gloves, masks and boots) should be used when removing, transporting and applying dried faeces.

**Costs:** Costs to consider include the potential transport cost from the toilet to the field and costs for labour, agricultural equipment and PPE. Application of dried faeces can contribute to revenue generation by increasing agricultural yields and to money savings if it replaces other fertilisers or soil conditioners.

**Social Considerations:** The handling and use of dried faeces may not be acceptable in some cultures and the potential Application of Dried Faeces needs be discussed with the affected communities. However, because dehydrated faeces should be dry, crumbly, and odour free, using them might be easier to accept than manure or sludge. Offensive odours may be generated if the level of dehydration is insufficient.

**Strengths and Weaknesses:**

- ⊕ Can improve the structure and water-holding capacity of the soil
- ⊕ Low risk of pathogen transmission
- ⊖ Labour intensive
- ⊖ Pathogens may exist in a dormant stage (cysts and oocysts) which may become infectious if moisture is added
- ⊖ Contains only limited amount of nutrients
- ⊖ Social acceptance may be low in some areas

→ **References and further reading material for this technology can be found on page 195**

# Application of Pit Humus and Compost

| Phase of Emergency                               | Application Level / Scale                  | Management Level                      | Objectives / Key Features                            |
|--|--|---------------------------------------|--|
| Acute Response<br>* Stabilisation<br>** Recovery | ** Household<br>** Neighbourhood<br>* City | ** Household<br>** Shared<br>* Public | Productive use of nutrients, Use as soil conditioner |
| Space Required                                   | Technical Complexity                       | Inputs                                | Outputs  |
| *** High   | * Low                                      | ● Pit Humus, ● Compost                | ● Biomass  |

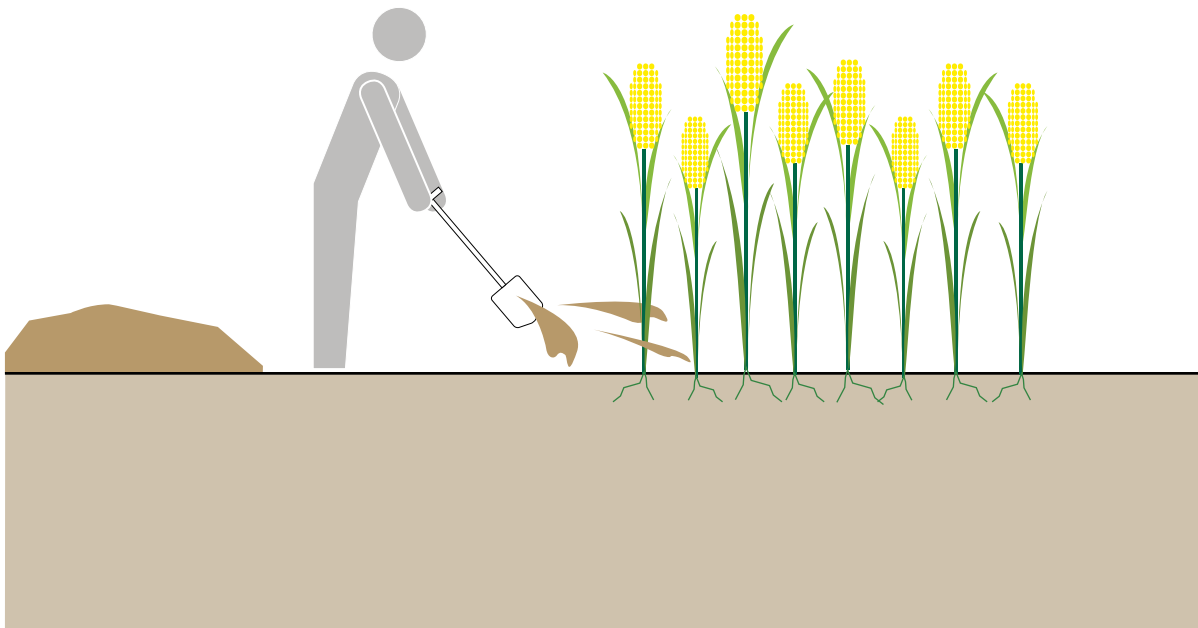

Compost is a soil-like substance resulting from controlled aerobic degradation of organic material in e.g. Co-Composting facilities (T.11, T.12). Pit humus is the material removed from double pit systems (S.5, S.6). It is produced passively underground and has a different composition from compost. Both products can be used as soil conditioners.

The process of thermophilic composting generates heat (50 to 80 °C) which can kill most pathogens present in the material being composted. Double pit systems have almost no increase in temperature because the conditions in the pit (presence of oxygen, moisture, the carbon to nitrogen ratio) are not optimised for the composting processes. Because of this the material is not actually compost; it is referred to as pit humus. The texture and quality of pit humus depends on the materials that have been added to the excreta (e.g. organic matter) and storage conditions. The World Health Organization (WHO)

Guidelines for the Safe Use of Wastewater, Excreta and Greywater stipulate that compost should achieve and maintain a temperature of 50 °C for at least one week before it is considered safe to use. Achieving this value, however, requires a significantly long period of composting. For technologies that generate pit humus, a minimum of one year of storage is recommended to eliminate bacterial pathogens and reduce viruses and parasitic protozoa. WHO guidelines should be consulted for detailed information.

**Design Considerations:** It has been shown that the productivity of poor soil can be improved by applying equal parts compost and topsoil. A 10 × 10 m plot that is well fertilised with compost, managed and watered can produce sufficient vegetables for a family of 5 all year round, depending on the climate.



**Materials:** Materials required for Application of Pit Humus and Compost are locally available in most situations and include wheelbarrows, shovels, spades, rakes, and personal protective equipment (PPE). For cultivating land where compost or pit humus has been applied other gardening tools such as hoes, watering cans, seeds, etc. are required.

**Applicability:** Compost and pit humus add nutrients and organic content to the soil and improve the soil's ability to store air and water. They can be mixed into the soil before crops are planted, used to start seedlings or indoor plants, to plant trees, or simply mixed into an existing compost pile for further treatment. Utilising both pit humus and compost is appropriate for the stabilisation and recovery phases of an emergency. Food production as part of camp greening programmes have been shown to increase the availability of micronutrients and contribute to overall food security, resilience and well-being of the affected community. Where food production is not an option, pit humus and compost can be used to restore land where natural disasters have removed the top layer of the soil.

**Operation and Maintenance:** Pit humus must be allowed to adequately mature before being removed from the system. It can then be used without further treatment. Matured pit humus will be dewatered and consolidated making it quite difficult to remove mechanically (see Manual Emptying and Transport **(C.1)**). Workers should wear PPE. Conducting training on the best methods of gardening and food production may be required.

**Health and Safety:** Pit humus, particularly from double pit systems that are not used correctly, poses a risk of pathogen transmission. If in doubt, material removed from the pit should be further composted in a regular compost heap before being used. Compost and pit humus are usually applied prior to the planting season. As opposed to sludge, which can originate from a variety of domestic,

chemical and industrial sources, compost and pit humus have very few non-organic inputs. The only non-organic contaminants would originate from human excreta (e.g. pharmaceutical residues) or from contaminated organic material (e.g. pesticides). Compost and pit humus are considered less contaminated than sludge. They are inoffensive, earth-like products. However, direct, unprotected handling should be actively discouraged.

**Costs:** The capital costs for tools to apply pit humus and compost are generally low. Additional infrastructure such as greenhouses or poly-tunnels or irrigation systems may also be required which would increase costs. The operating costs are low if self-managed.

**Social Considerations:** Social acceptance may be a challenge for communities that are not familiar with using pit humus or compost. Conducting training and demonstration activities that promote hands-on experience can effectively show their non-offensive nature and their beneficial use. If vegetable production is being promoted, the varieties should reflect those grown and consumed in the local context.

#### **Strengths and Weaknesses:**

- ⊕ Low risk of pathogen transmission
- ⊕ Can improve structure and water-holding capacity of soil and reduces chemical fertiliser needs
- ⊕ May encourage income generation (improved yield and productivity)
- ⊕ Can strengthen relations with land owners and authorities by greening and improving surrounding environment
- ⊖ Commonly requires an extended period of support to take the process through a complete cycle
- ⊖ Social acceptance may be low in some areas

→ **References and further reading material for this technology can be found on page 195**

# Application of Sludge

| Phase of Emergency                                | Application Level / Scale               | Management Level                       | Objectives / Key Features                            |
|---|---|--|--|
| Acute Response<br>** Stabilisation<br>** Recovery | Household<br>* Neighbourhood<br>** City | ** Household<br>** Shared<br>** Public | Productive use of nutrients, Use as soil conditioner |
| Space Required                                    | Technical Complexity                    | Inputs                                 | Outputs  |
| *** High  | * Low                                   | ● Sludge                               | ● Biomass  |

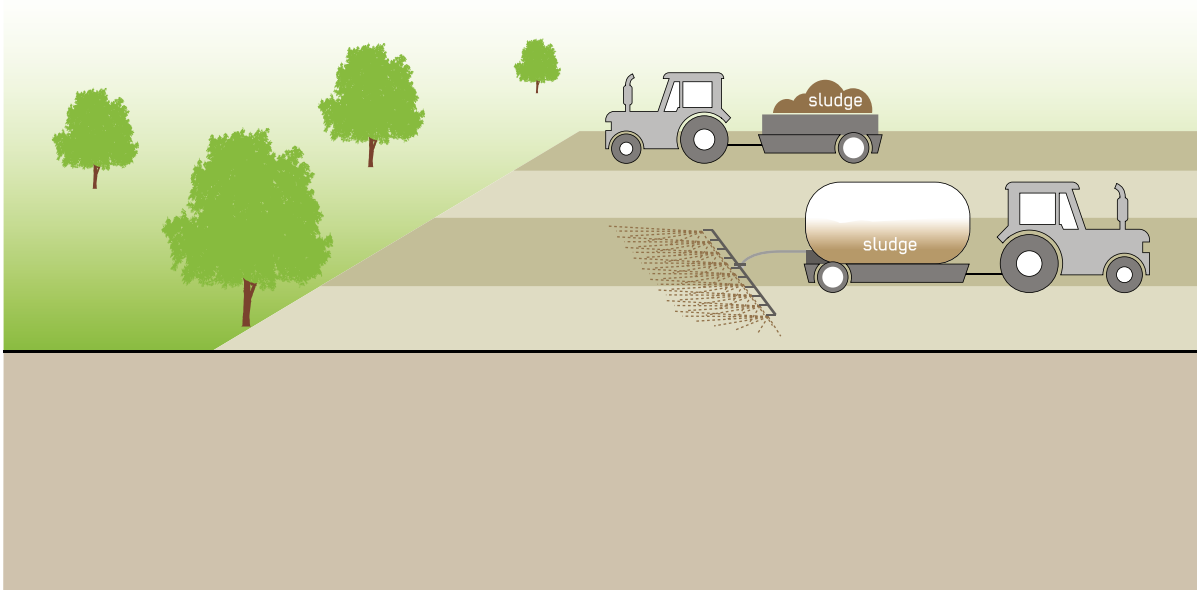

Depending on the treatment type and quality, digested or stabilised sludge can be applied to public or private lands for landscaping or agriculture.

Treated sludge (e.g. from Planted Drying Beds: **T.10**) can be used in agriculture, home gardening, forestry, sod and turf growing, landscaping, parks, golf courses, mine reclamation, as a dump cover, or for erosion control. Although sludge has lower nutrient levels than commercial fertilisers (for nitrogen, phosphorus and potassium), it can replace a part of the fertiliser need. Additionally, treated sludge has been found to have some properties superior to those of fertilisers, such as bulking and water retention properties, and the slow, steady release of nutrients.

**Design Considerations:** Solids are spread on the ground surface using conventional manure spreaders, tank trucks or specially designed vehicles. Liquid sludge (e.g. from anaerobic reactors) can be sprayed onto or injected into the ground. The user must consider the level of treatment of the sludge and the type of use to determine how and when to best apply the sludge. Application rates and usage of sludge should account for the presence of pathogens and contaminants, and the quantity of nutrients available so that it is used at a sustainable and agronomic rate. On-farm Co-Composting (**T.11**) can be used to achieve improved treatment and increase the volume of soil conditioner.

**Materials:** A vehicle to transport and equipment to spread the sludge are required. This may include conventional manure spreaders, tank trucks or specially designed vehicles.

**Applicability:** The World Health Organization (WHO) Guidelines for the Safe Use of Wastewater, Excreta and Greywater should be consulted regarding the type of crops and conditions for the safe use of sludge. Depending on the source, sludge can serve as a source of nutrients. The Application of Sludge on land may be less expensive than disposal. Application of Sludge can be considered during the stabilisation and recovery phases of an emergency, when a functional sludge treatment system is in place.

**Operation and Maintenance:** The equipment used for applying sludge requires maintenance. The amount and rate of sludge application should be monitored to prevent nutrient overloading of both the soil and water bodies.

**Health and Safety:** Even after treatment, sludge is rarely pathogen-free. The WHO Guidelines for the Safe Use of Wastewater, Excreta and Greywater should be consulted regarding the security measures needed to protect public and environmental health. Workers should wear personal protective equipment (e.g. clothing, boots, masks). Although sludge is sometimes criticised for containing potentially high levels of heavy metals or other contaminants, faecal sludge from pits and tanks should not have any chemical inputs and is, therefore, not a high-risk source of heavy metal contamination. Sludge that originates from large-scale wastewater treatment plants is more likely to be contaminated as it may receive industrial and domestic chemicals, as well as surface water run-off, which can contain hydrocarbons and metals. Sludge from domestic wastewater and on-site sanitation systems can be considered safer as it is not contaminated by industrial waste.

**Costs:** The main cost to consider is the potential transport of the sludge to the fields. The Application of Sludge contributes to revenue generation by increasing agricultural yields. The application of sludge can save money if it replaces commercial fertilisers.

**Social Considerations:** The greatest barrier to the use of sludge is, generally, social acceptance. However, even when farmers or local industries do not accept sludge, it can still be useful for municipal projects and can provide significant savings (e.g. mine reclamation). Depending on the source of the sludge and the treatment method, sludge can be treated to a level where it is generally safe and no longer generates significant odour or vector problems. Following appropriate safety and application regulations is important. The WHO guidelines should be consulted for more detailed information.

**Strengths and Weaknesses:**

- ⊕ Can reduce the use of chemical fertilisers and improve the water-holding capacity of soil
- ⊕ Can accelerate reforestation
- ⊕ Can reduce erosion
- ⊕ Low costs
- ⊖ Odours may be noticeable, depending on prior treatment
- ⊖ May require special spreading equipment
- ⊖ May pose public health risks, depending on its quality and application
- ⊖ Social acceptance may be low in some areas

→ **References and further reading material for this technology can be found on page 195**

# Fill and Cover: Arborloo and Deep Row Entrenchment

| Phase of Emergency                                   | Application Level / Scale                | Management Level  | Objectives / Key Features   |
|--|--|---|---|
| ** Acute Response<br>** Stabilisation<br>** Recovery | ** Household<br>** Neighbourhood<br>City | ** Household<br>* Shared<br>** Public   | Productive use of nutrients, Use as soil conditioner, Safe disposal |
| Space Required                                       | Technical Complexity                     | Inputs  | Outputs   |
| ** Medium  | * Low                                    | ● Excreta, ● Organics),<br>(● + Anal Cleansing Water),<br>(● + Dry Cleansing Materials) | ● Biomass)  |

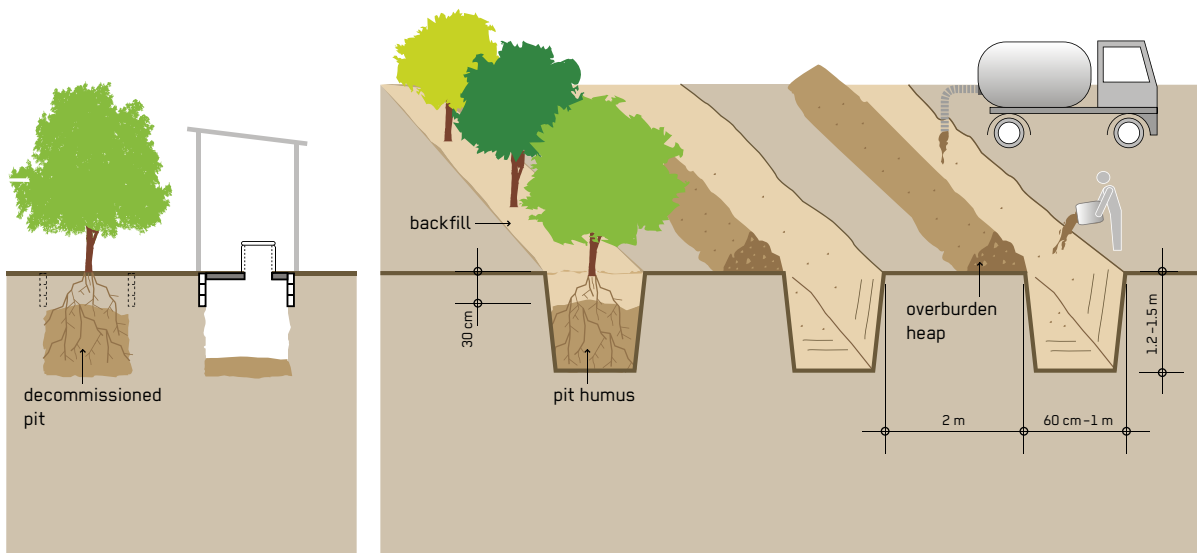

To decommission a pit or trench, it can be topped up with soil and covered. Similarly, untreated (faecal) sludge and excreta can be disposed of in a Deep Row Entrenchment. The covered full pit or trench poses no immediate health risk and the contents will degrade naturally over time. Trees can be planted on top of the nutrient-rich pits and trenches and will grow vigorously.

When pits (S.3, S.4) or trenches (S.1) are full "Fill and Cover", i.e. filling the remainder of the pit and covering it, is an option. The Arborloo is a shallow pit designed specifically on this principal, with a tree being planted in the pit once it is full, and the superstructure, ring beam and slab moved to a new shallow pit. Before an Arborloo pit is first used, a layer of leaves is put on the bottom of the empty pit. A cup of soil, ash or a mixture of the two should be added to the pit to cover excreta after each defecation. If available, leaves can be occasionally added to improve the porosity and air content of the pile. When the pit is full

(usually every 6 to 12 months), the top 15 cm is filled with soil and a tree is planted. Banana, papaya and guava trees (among many others) have proven to be successful. Deep Row Entrenchment is a method that can be considered as both a treatment and disposal option. It consists of digging deep trenches, filling them with sludge and covering them with soil. As with the Arborloo, trees can be planted on top, which benefit from the organic matter and nutrients that are slowly released from the sludge.

**Design Considerations:** An Arborloo is an option if the site is suitable for a tree to grow with enough available space. A shallow pit, about 1 m deep, is needed for an Arborloo. A tree should not be planted, however, directly in the raw excreta. It should be planted in the soil on top of the pit, allowing its roots to penetrate the pit contents as it grows. It may be best to wait for the rainy season before planting if water is scarce. Deep Row Entrenchment is usually constructed with a backhoe. Dimensions are typically 1.2–1.5 m

deep, about 0.6–1 m wide and with a length of several meters, depending of the space available. Space between rows can be 2 m or more edge-to-edge. The depth of the trench is determined by the volume of sludge to be applied. The trench is filled with sludge to within 0.3 m of the surface and then backfilled with the overburden heaped. Trees or other vegetation are planted on or between trenches. Variables to consider are trench dimensions, spacing, method of filling (layered with soil or co-composted with vegetable matter), species, composition and density of vegetation and end purpose.

**Materials:** Tools are needed to dig the pit hole, and a backhoe is useful in the case of Deep Row Entrenchment. Small trees should be available for transplanting.

**Applicability:** Fill and Cover is an adequate solution when emptying is not possible or where there is space to continuously dig new pits. The Arborloo can be applied in rural, peri-urban, and even denser areas if enough space is available. Planting a tree in the abandoned pit is a good way to reforest an area, provide a sustainable source of fresh fruit and prevent people from falling into old pit sites. The same principle can be applied to trench latrines. Depending on the local conditions, however, the content of a covered pit or trench could contaminate groundwater resources until it is entirely decomposed. Deep Row Entrenchment can be considered where there is land available with adequate size and no groundwater contamination risk. These options can be applied in all phases of emergency, as soon as a pit or trench is full.

**Operation and Maintenance:** For the Arborloo a cup of soil and/or ash should be added to the pit after each defecation and leaves should be periodically added. Ideally, the contents of the pit should be periodically levelled with a stick to prevent a cone shape from forming in the middle. Once the pit is full, the latrine superstructure needs to be moved to a new pit. There is little maintenance associated with a closed pit or trench other than taking care of the tree or plant. Trees planted in filled pits and trenches should be regularly watered. Small fences should be constructed around saplings to protect them from animals.

**Health and Safety:** There is minimal risk of infection if the filled pit or trench is properly covered and clearly marked. It may be preferable to cover a pit and to plant a tree rather than emptying it, especially if there is no appropriate technology available to remove and treat the faecal sludge and space is no constraint. Users do not come in contact with the faecal material and, thus, there is a very low risk of pathogen transmission. As for Deep Row Entrenchment, personal protective equipment is required during sludge collection and disposal into the trench.

**Costs:** Fill and Cover is a low-cost solution. The main cost items are tools, machinery and staff needed to dig the pits or trenches. Trees and edible crops can generate income or reduce food expenses.

**Social Considerations:** Arborloo and Deep Row Entrenchment are simple and do not produce visible or olfactory nuisance, except during sludge transport for the latter. They also reduce the risk of exposure to pathogens after covering. Arborloo demonstration projects that allow for the participation of community members are useful to display the ease of the system, its inoffensive nature, and the nutrient value of human excreta.

#### Strengths and Weaknesses:

- ⊕ Technique is simple to apply for all users
- ⊕ Low cost
- ⊕ Low risk of pathogen transmission
- ⊕ May encourage income generation (tree planting and fruit production)

- ⊖ New pit must be dug; the old pit cannot be re-used
- ⊖ Covering a pit or planting a tree does not eliminate the risk of groundwater contamination
- ⊖ Space required

→ **References and further reading material for this technology can be found on page 195**

# Surface Disposal and Sanitary Landfill

| Phase of Emergency   | Application Level / Scale   | Management Level  | Objectives / Key Features |
|--|---|---|---------------------------|
| <ul style="list-style-type: none"> <li>★★ Acute Response</li> <li>★ Stabilisation</li> <li>★ Recovery</li> </ul> | <ul style="list-style-type: none"> <li>★ Household</li> <li>★ Neighbourhood</li> <li>★★ City</li> </ul> | <ul style="list-style-type: none"> <li>★ Household</li> <li>★★ Shared</li> <li>★★ Public</li> </ul>   | Safe disposal             |
| Space Required   | Technical Complexity  | Inputs  | Outputs                   |
| <ul style="list-style-type: none"> <li>★★★ High</li> </ul>   | <ul style="list-style-type: none"> <li>★★ Medium</li> </ul>   | <ul style="list-style-type: none"> <li>● Sludge, ● Pit Humus, ● Compost,</li> <li>● Dried Faeces, ● Dry Cleansing Material, ● Pre-Treatment Products</li> </ul> | Outputs                   |

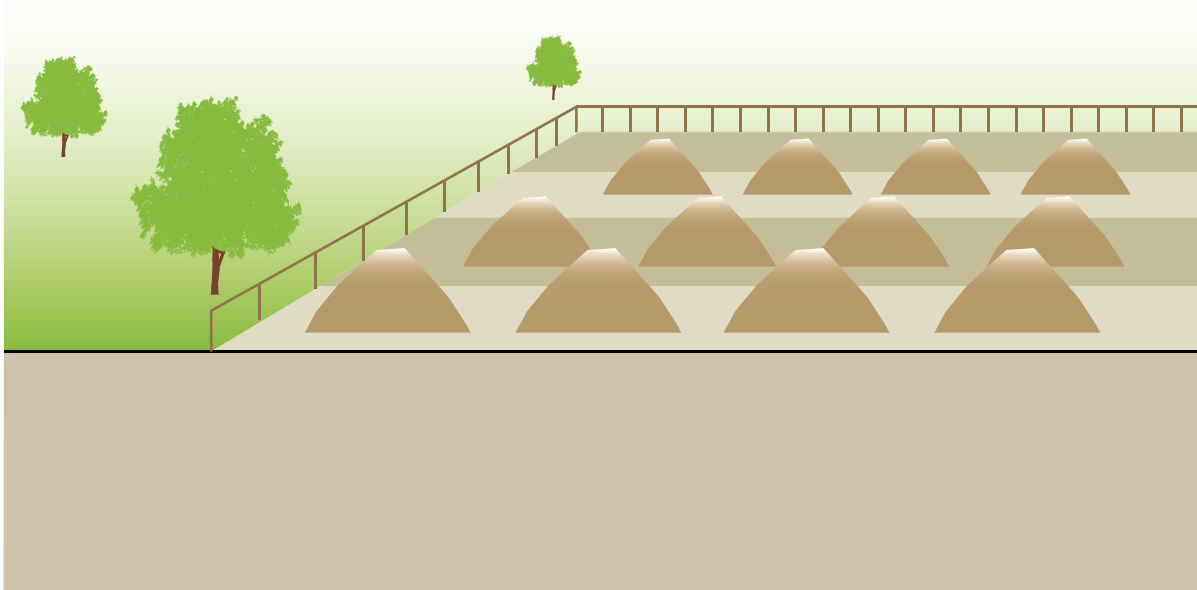

Surface Disposal refers to the storage of sludge, faeces or other materials that cannot be used elsewhere. Sanitary Landfills are land disposal sites, designed to protect the environment from pollution. Once the material has been taken to a Surface Disposal site or a Sanitary Landfill, it is not used later.

Sanitary Landfills are designed for solid waste as well as sludge and other materials. Surface Disposal is the disposal primarily of sludge, but can also include dry cleansing materials. As cleansing materials cannot always be disposed of with water-based products, they are at times separated and must be disposed of separately. When there is no demand for the use of sludge, it can be placed in monofills (sludge-only Sanitary Landfills) or heaped into permanent piles. Temporary storage before Surface Disposal contributes to further dehydration of the product and the die-off of pathogens before final disposal.

**Design Considerations:** Landfilling sludge together with municipal solid waste (MSW) is not recommended as it reduces the life of a landfill, which are generally designed for noxious materials. As opposed to more centralised MSW landfills, Surface Disposal sites can be situated close to where sludge is generated and treated, limiting the need for long transport distances. With Surface Disposal there is generally no limit to the quantity of sludge that can be applied to the surface since nutrient loads or agronomic rates are not a concern. However, the likelihood and danger of groundwater contamination must be considered. More advanced Surface Disposal systems may incorporate a liner and leachate collection system, with subsequent treatment of the leachate, to prevent nutrients and contaminants from entering the groundwater. In a Sanitary Landfill, the gas produced can be collected and used for combustion or energy production. Sites for temporary storage facilities should be covered to avoid rewetting by rain-water and the generation of additional leachate.

**Materials:** For more advanced systems, leachate piping and liner materials are needed and possibly piping to collect the gas produced. For some landfill uses it is advised to cover the waste and therefore a waterproof cover is needed.

**Applicability:** Where sludge use is not possible, its contained and controlled storage is preferable to uncontrolled dumping. Sludge storage may, in some cases, be a good intermediate step to further dry and sanitise sludge and generate a safe, acceptable product. Surface Disposal and storage can be used in almost every climate and environment, although they may not be feasible where there is frequent flooding or where the groundwater table is high. Surface Disposal and Sanitary Landfills can be suitable options for sludge disposal during an acute response phase, if there is land available away from human contact and waterbodies. Immediate Surface Disposal sites can later be upgraded to more advanced Sanitary Landfills by retrofitting leachate piping and lining materials for groundwater protection. An engineered Sanitary Landfill needs expert technical design. A simple Surface Disposal site will have a negative long-term effect on the environment, but can be a suitable short-term intervention during a crisis.

**Operation and Maintenance:** Staff should ensure that only appropriate materials are disposed of at the site and must maintain control over the traffic and hours of operation. Workers should wear appropriate personal protective equipment.

**Health and Safety:** If a Surface Disposal and storage site is protected (e.g. by a robust fence) and located far from the public, there should be no risk of contact or nuisance. Adequate siting and design should prevent the

contamination of groundwater resources by leachate. Vermin and pooling water can exacerbate odour and vector problems and should be prevented at disposal or storage sites.

**Costs:** As land requirements are substantial for Sanitary Landfills and Surface Disposal, the associated costs can be substantial. Additional costs for operating and maintaining the facility need to be considered.

**Social Considerations:** Sanitary Landfills and Surface Disposal sites can be constructed and managed with the help of local communities. However, these sites should be located away from population centres for protection of public health. Where informal economies are built around scavenging landfills, the participants in the informal economy should be effectively informed of the dangers that infectious landfill wastes, including human waste, can pose to their health.

#### **Strengths and Weaknesses:**

- ⊕ May prevent uncontrolled disposal
- ⊕ Storage may render the product more hygienic
- ⊕ Can make use of vacant or abandoned land
- ⊕ Low technical skills required for operation and maintenance
- ⊖ Requires large land area
- ⊖ Potential leaching of nutrients and contaminants into groundwater
- ⊖ Odours may be noticeable, depending on prior treatment
- ⊖ May require special spreading equipment

→ **References and further reading material for this technology can be found on page 195**

# Use of Biogas

| Phase of Emergency                              | Application Level / Scale               | Management Level                       | Objectives / Key Features |
|---|---|--|---------------------------|
| Acute Response<br>★ Stabilisation<br>★ Recovery | ★★ Household<br>★ Neighbourhood<br>City | ★★ Household<br>★★ Shared<br>★★ Public | Productive use of energy  |
| Space Required                                  | Technical Complexity                    | Inputs                                 | Outputs                   |
| ★ Little  | ★★ Medium                               | ● Biogas                               |                           |

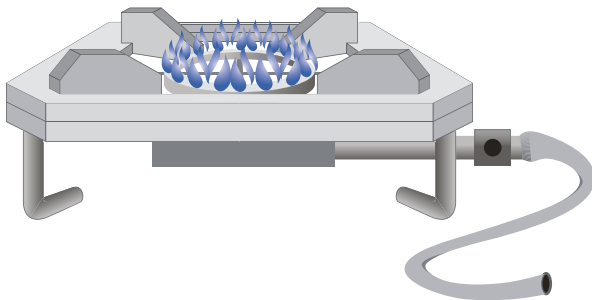

Anaerobic digestion of sludge and other organic matter produces biogas (a mix of methane and other gases). Biogas can be used like other fuel gas for cooking, heating, lighting and electricity production.

When produced in household-level Biogas Reactors (S.16), biogas is most suitable for cooking or lighting. Where biogas is produced in large anaerobic digesters (T.4), electricity generation is an alternative.

**Design Considerations:** Gas demand can be defined on the basis of energy previously consumed. For example, 1 kg of dried cow dung corresponds to 100 L of biogas, 1 kg of firewood corresponds to around 200 L of biogas, and 1 kg of charcoal corresponds to 500 L of biogas. Gas consumption for cooking per person and per meal is between 150 and 300 L biogas. Approximately 30–40 L biogas is required to boil one litre of water, 120–140 L for 0.5 kg rice and 160–190 L for 0.5 kg vegetables. Tests have shown that the biogas consumption rate of a household biogas stove

is between 300 to 400 L per hour. However, this depends on the stove design and methane content of the biogas. Compared to other gases, biogas needs less air for combustion. Therefore, conventional gas appliances need to be modified when they are used for biogas combustion (e.g. larger gas jets and burner holes). The distance through which the gas must travel should be minimised as leaks may occur. Drip valves should be installed for the drainage of condensed water, which accumulates at the lowest points of the gas pipe.

**Materials:** Appliances required depend on how the biogas will be used. Many appliances have to be designed specifically for use with biogas and these are not always widely available. However, conventional gas burning stoves can be easily modified for use with biogas by widening the jets and burner holes and reducing the primary air intake. When biogas is used for cooking, a simple pressure indicator should be installed to inform the user of the amount of gas available.



**Applicability:** Biogas Reactors (**S.16, T.4**) can be considered as a treatment option during the stabilisation and recovery phase and the production of useable energy (biogas) can partially reduce dependence on other fuels and contribute to a community's self-reliance. When considering the use of biogas, it is important to consider the calorific efficiency of biogas in different applications; it is 55 % in stoves, 24 % in engines, but only 3 % in lamps. A biogas lamp is only half as efficient as a kerosene lamp. For common household or community level installations, the most efficient use of biogas is in stoves for cooking. For larger installations, the most efficient use of biogas is electricity generation with a heat-power combination. In this case, 88 % efficiency can be reached.

**Operation and Maintenance:** Biogas is usually fully saturated with water vapour, which leads to condensation. To prevent blocking and corrosion, the accumulated water should be periodically emptied from the system's water traps. Trained personnel must regularly check gas pipelines, fittings and appliances. Cooking stoves should be kept clean and the burner ring should be checked for blockages. When using biogas for an engine, it is necessary to first reduce the hydrogen sulphide content as it forms corrosive acids when combined with condensing water.

**Health and Safety:** When faecal matter and organic material is anaerobically digested as it is in a Biogas Reactor, the biogas produced is primarily composed of methane and carbon dioxide, with lesser amounts of hydrogen sulphide, ammonia, and other gases, depending on the material being digested. Each of these gases has safety issues. Overall, biogas risks include explosion, asphyxiation, disease, and hydrogen sulphide poisoning.

**Costs:** The costs depend on the chosen application for the biogas and the appliance required. Piping is required and generally available in local markets. Gas cooking stoves are cheap and widely available. With proper instructions and simple tools the modifications can be done by a local handy person.

**Social Considerations:** In general, users find cooking with biogas acceptable as it can immediately be switched on and off (unlike wood and coal). Also, it burns without smoke, and, does not contribute to indoor air pollution. Biogas generated from faeces may not be appropriate in all cultural contexts. Training and orientation on biogas production, safety, and piping should be given to support user acceptance, to ensure efficient use and maintenance of the stove, to facilitate rapid identification of leakages and other potential issues. In some cases, users will need to learn how to cook with gas. It should also be demonstrated to users that biogas is not dangerous (due to its low concentration of methane).

**Strengths and Weaknesses:**

- ⊕ Free energy source
- ⊕ Can substitute fuel wood and other sources for cooking
- ⊕ Comparably few operation skills and little maintenance required
- ⊖ May not meet energy requirements and cannot replace all energy types
- ⊖ Biogas can only be stored for several days (low energy density) and needs to be used daily
- ⊖ Biogas lamps have lower efficiency compared to kerosene lamps
- ⊖ Biogas production below 15 °C is not economically feasible

→ **References and further reading material for this technology can be found on page 195**

# Co-Combustion of Sludge

| Phase of Emergency                             | Application Level / Scale             | Management Level                 | Objectives / Key Features                           |
|--|---------------------------------------|----------------------------------|---|
| Acute Response<br>Stabilisation<br>★★ Recovery | Household<br>Neighbourhood<br>★★ City | Household<br>Shared<br>★★ Public | Volume reduction, Pathogen removal, Heat production |
| Space Required                                 | Technical Complexity                  | Inputs                           | Outputs   |
| ★★★ High                                       | ★★★ High                              | ● Dried Sludge                   |   |

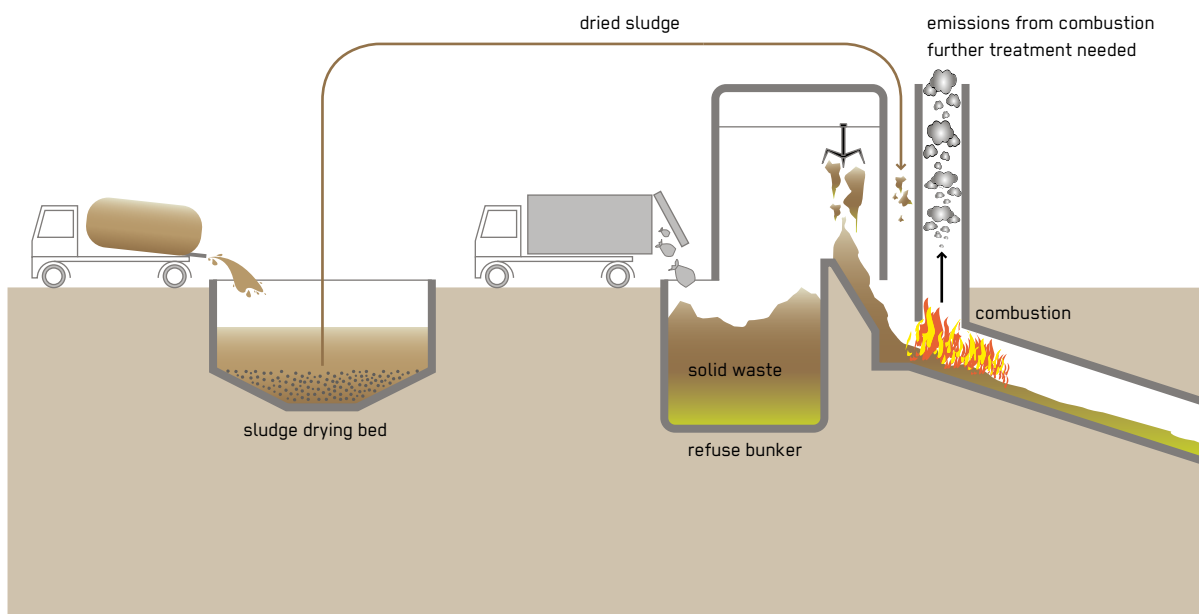

Co-Combustion of Sludge through the process of incineration is an effective disposal and resource recovery option for dewatered faecal sludge.

In Co-Combustion the pathogens are killed and the sludge is sanitised. As part of the process energy is generated, which can be used for heating or the production of electricity.

**Design Considerations:** In Co-Combustion of Sludge or more general thermo-chemical conversion, some form of heat is applied to sanitation products such as faecal sludge to destroy pathogens and drastically reduce the sludge volume, with energy produced in the form of heat. Before incineration, sludge needs to be dewatered e.g. in Unplanted or Planted Drying Beds (T.9, T.10). Co-Combustion (or incineration) of Sludge together with solid waste happens at temperatures of 850–900 °C. The energy can be used for example, to power cement kilns. The ash produced

can be used in construction or can be safely disposed of. The ash may be hazardous as it could have a high heavy metal content, depending on the source of the sludge. Methods for incineration include mass burn incineration, fluidised-bed incineration and co-incineration with municipal solid waste or in cement factories. An emerging technology in heat application treatment is pyrolysis or gasification of faecal sludge. Pyrolysis or gasification happens through heating in an oxygen-depleted environment, thus preventing combustion. Gasification occurs at temperatures above 800 °C, pyrolysis between 350 and 800 °C. In these processes char is produced, which can be used in furnaces and kilns in the same way as coal.

**Materials:** The main requirement for incineration is an incineration furnace. An incineration furnace requires many different special parts and materials, particularly for the treatment of the exhaust gases, which can be dangerous for public and environmental health. The required special

parts are often not locally available. With an existing solid waste incineration plant, Co-Combustion of Sludge can be done immediately. Pyrolysis and gasification reactors can be constructed with locally available materials (e.g. oil drum, locally produced burner) on a small scale.

**Applicability:** Co-Combustion of Sludge is an option, if a functioning incineration plant is within an acceptable distance to keep transport costs down. With an existing, functional incinerator, this technology can be used straight away in the acute phase of an emergency. As there is only some dewatering needed as a pre-treatment, sludge can be disposed of very quickly. The necessities in terms of skills, institutional set-up and financial resources to implement such a system from scratch are very high and only suitable for the recovery phase.

**Operation and Maintenance:** Highly skilled workers are needed to operate and maintain an incinerator and a pyrolysis or gasification reactor. Since high temperatures are reached, only trained staff should operate and maintain the reactor and be in the vicinity. Regular monitoring of the plant or reactor is needed.

**Health and Safety:** Along with heat, by-products of incineration and pyrolysis include several gaseous pollutants, as well as tar, ash and unburned solid residues. These by-products need further treatment or safe disposal, as they might be hazardous to human and environmental health.

**Costs:** The costs of installing a new incinerator are very high. Operation and maintenance (O&M) costs are also high, as specialised personnel must operate the plant. Other important costs to consider are the transport of products to the plant, which is often located outside of urban settlements. Capital costs for small-scale pyrolysis or gasification reactors are low to medium while O&M costs are relatively high as specialised personnel is needed.

**Social Considerations:** Co-Combustion of Sludge may not be appropriate in all cultural contexts. The incineration of sludge coming from human excreta and the use of incinerated sludge products in the cement industry might therefore be disregarded and need to be properly addressed as part of awareness raising measures.

**Strengths and Weaknesses:**

- ⊕ Effective pathogen reduction
- ⊕ Fast treatment time
- ⊕ High reduction of sludge volume
- ⊖ High energy input needed
- ⊖ High O&M costs
- ⊖ Residual ash and tar

→ **References and further reading material for this technology can be found on page 195**

# Leach Field

| Phase of Emergency                               | Application Level / Scale               | Management Level                      | Objectives / Key Features  |
|--|---|---------------------------------------|--|
| Acute Response<br>★ Stabilisation<br>★★ Recovery | ★★ Household<br>★ Neighbourhood<br>City | ★★ Household<br>★★ Shared<br>★ Public | Use of treatment capacity of the soil, Safe disposal of effluent |
| Space Required                                   | Technical Complexity                    | Inputs                                | Outputs  |
| ★★ Medium  | ★★ Medium                               | ● Effluent                            |  |

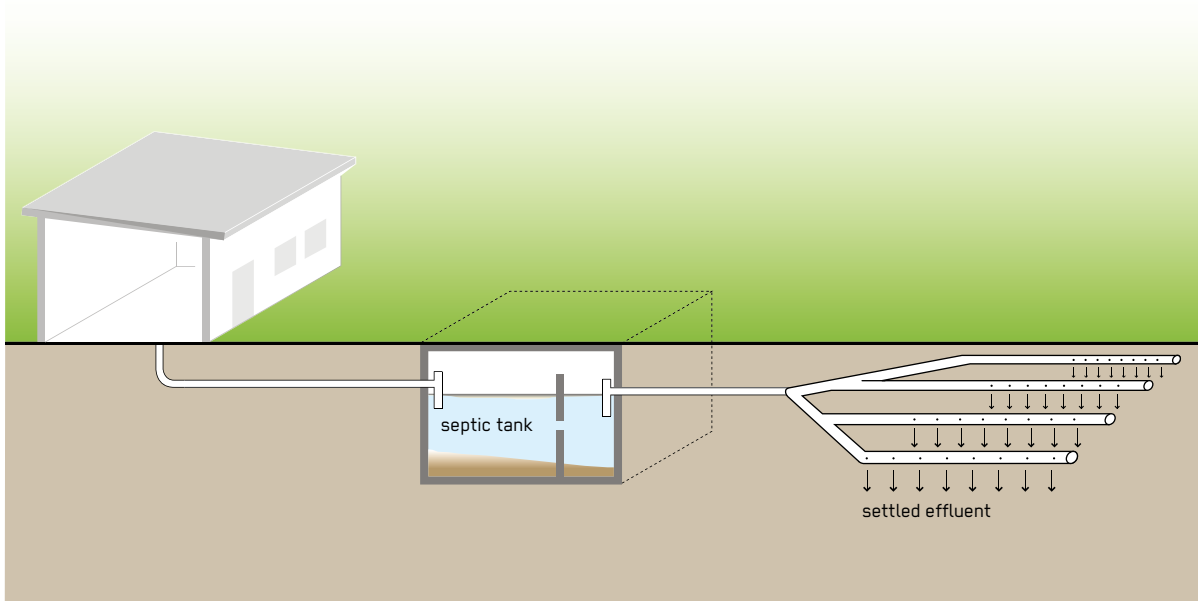

A Leach Field, or drainage field, is a network of perforated pipes that are laid in underground gravel-filled trenches to dissipate the effluent from a water-based collection and storage/treatment or a (semi-) centralised treatment technology on a wider surface area.

Pre-settled effluent is fed into a piping system (distribution box and several parallel channels) that distributes the flow into the subsurface soil for absorption and subsequent treatment. A dosing or pressurised distribution system may be installed to ensure that the whole length of the Leach Field is utilised and that aerobic conditions are re-established between dosings. Such a dosing system releases the pressurised effluent into the Leach Field with a timer (usually 3 to 4 times a day).

**Design Considerations:** Each trench is 0.3 to 1.5 m deep and 0.3 to 1 m wide. The bottom of each trench is filled with about 15 cm of clean rock and a perforated distribution pipe is laid on top. More rock is placed to cover the pipe. A layer of geotextile fabric is placed on the rock layer to prevent small particles from plugging the pipe. A final layer of sand and/or topsoil covers the fabric and fills the trench to the ground level. The pipe should be placed at least 15 cm beneath the surface to prevent effluent from surfacing. The trenches should be dug no longer than 20 m in length and at least 1 to 2 m apart. To prevent contamination, a Leach Field should be located at least 30 m away from any drinking water source and be built at least 1.5 m above the groundwater table. A Leach Field should be laid out such that it will not interfere with a future sewer connection.

**Materials:** Leach Fields require piping and rocks and a geotextile fabric to cover the piping in the trenches. These are materials that are usually locally available.

**Applicability:** Leach Fields can be a quick and easy to build means of disposing of large quantities of wastewater during an emergency, if there is enough land available with good infiltration capacity and unsaturated soil. Due to potential oversaturation of the soil, Leach Fields are not appropriate for dense urban areas, areas prone to flooding, or areas with high groundwater tables. Leach Fields can be used in almost every climate, although there may be problems with pooling effluent in areas where the ground freezes. Homeowners with a Leach Field must be aware of how it works and of their maintenance responsibilities. Trees and deep-rooted plants should be kept away from the Leach Field as roots can crack and disturb the pipes and layer beneath.

**Operation and Maintenance:** A Leach Field will become clogged over time, although this may take more than 20 years, if a well-maintained and well-functioning primary treatment technology is in place. Effectively, a Leach Field should require minimal maintenance; however, if the system stops working efficiently, the pipes should be cleaned and/or removed and replaced. There should also be no heavy traffic above it as this could crush the pipes or compact the soil.

**Health and Safety:** Since the technology is underground and requires little attention, users will rarely come into contact with the effluent, and there is no immediate health risk. Groundwater contamination can be an issue and the Leach Field must be kept far away from any

potential potable water source. Soil properties such as the permeability of the soil and groundwater level should be properly assessed **(X.3)** to limit exposure of water sources to microbial contamination. The Sphere minimum standards on excreta management should be consulted for further guidance.

**Costs:** If all required materials are locally available, the material costs can be kept low. However, this technology requires a lot of land, which can be expensive particularly in urban areas.

**Social Considerations:** Large quantities of wastewater percolating into the soil can become a concern to the local community. Therefore, the safety and effectiveness of this technology needs to be well communicated to the community.

#### **Strengths and Weaknesses:**

- ⊕ Can be used for the combined treatment and disposal of effluent
- ⊕ Has a long lifespan (depending on conditions)
- ⊕ Low maintenance requirement if operated without mechanical equipment
- ⊕ Relatively low capital and operating costs
- ⊖ Requires expert design and construction
- ⊖ Requires a large land area
- ⊖ Primary treatment is required to prevent clogging
- ⊖ May negatively affect soil and groundwater properties

→ **References and further reading material for this technology can be found on page 195**

# Soak Pit

| Phase of Emergency   | Application Level / Scale   | Management Level  | Objectives / Key Features  |
|--|---|---|--|
| <ul style="list-style-type: none"> <li>* Acute Response</li> <li>* Stabilisation</li> <li>** Recovery</li> </ul> | <ul style="list-style-type: none"> <li>** Household</li> <li>* Neighbourhood</li> <li>City</li> </ul> | <ul style="list-style-type: none"> <li>** Household</li> <li>** Shared</li> <li>Public</li> </ul>                   | Use of treatment capacity of the soil, Safe disposal of effluent |
| Space Required   | Technical Complexity  | Inputs  | Outputs  |
| <ul style="list-style-type: none"> <li>* Little</li> </ul>   | <ul style="list-style-type: none"> <li>* Low</li> </ul>   | <ul style="list-style-type: none"> <li>● Effluent, ● Greywater, ● Urine,</li> <li>● Anal Cleansing Water</li> </ul> |  |

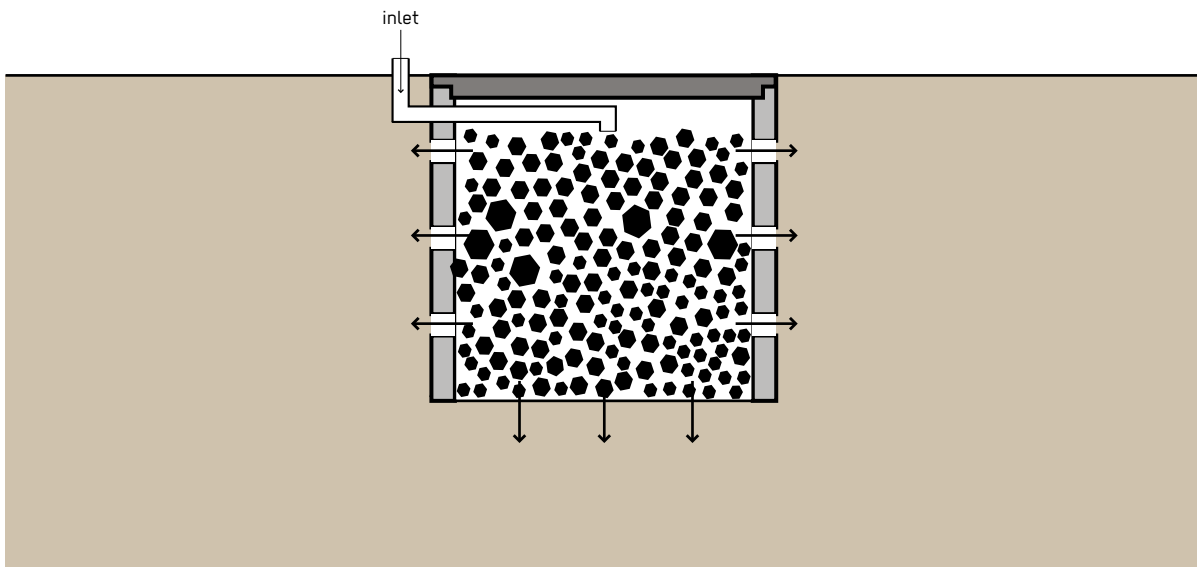

A Soak Pit, also known as a soakaway or leach pit, is a covered, porous-walled chamber set in the ground that allows water to slowly percolate. Pre-settled effluent from a water-based collection and storage/treatment or a (semi-) centralised treatment technology is discharged to the underground chamber from which it infiltrates into the surrounding soil.

As wastewater (greywater or blackwater after primary treatment) percolates through the soil from the soak pit, small particles are filtered out by the soil matrix and organics are digested by microorganisms. Thus, Soak Pits are best suited for soil with good absorptive properties; clay, hard packed or rocky soil is not appropriate.

**Design Considerations:** The Soak Pit should be between 1.5 and 4 m deep, and as a rule of thumb, never less than 2 m above the highest groundwater table. It should be located at a safe distance from a drinking water source (ideally more than 30 m). The Soak Pit should be kept away from high-traffic areas so that the soil above and around it is not compacted. It can be left empty and lined with a porous material to provide support and prevent collapse, or left unlined and filled with coarse rocks and gravel. The rocks and gravel will prevent the walls from collapsing, but will still provide adequate space for the wastewater. In both cases, a layer of sand and fine gravel should be spread across the bottom to help disperse the flow. To allow for future access, a removable (preferably concrete) lid should be used to seal the pit until it needs to be maintained. As the bottom may clog, the design should only consider the sidewall area. Preferably a percolation test is done to assess the leaching capacity of the soil.

**Materials:** Bricks and cement or wood are needed for lining and rocks and gravel for filling a soak pit. This filling can also replace the lining, by supporting the walls from inside.

**Applicability:** A Soak Pit exposed to raw wastewater will quickly clog. Soak Pits are designed to discharge pre-settled blackwater or greywater. The technology is appropriate for rural and peri-urban settlements. They depend on soil with a sufficient absorptive capacity (e.g. sandy soils) and are not appropriate for areas prone to flooding or with high groundwater tables. As Soak Pits are very low cost, cheap and easy to implement technologies for water-based systems, they can be the first solution for wastewater discharge in an emergency. Once it is possible to provide better treatment to the wastewater, Soak Pits can potentially be upgraded or replaced.

**Operation and Maintenance:** A well-sized Soak Pit should last between 3 and 5 years without maintenance. To extend the life of a Soak Pit, the effluent must be clarified and/or filtered to prevent the excessive build-up of solids. Particles and biomass will eventually clog the pit so that it will need to be cleaned or moved. When the performance of the Soak Pit deteriorates, the material inside can be excavated and refilled.

**Health and Safety:** As long as the Soak Pit is not used for raw sewage, and as long as the previous collection and storage/treatment technology is functioning well, health concerns are minimal. The technology is located underground and, thus, humans and animals should have no

contact with the effluent. Groundwater contamination can be an issue and the Soak Pit must be kept far away from any potential potable water source. Soil properties such as the permeability of the soil and groundwater level should be properly assessed (**X.3**) to limit exposure of water sources to microbial contamination. The Sphere minimum standards on excreta management should be consulted for further guidance.

**Costs:** Soak Pits are very low in cost for construction, operation and maintenance.

**Social Considerations:** A Soak Pit is a very low-cost and low-tech solution for discharging wastewater. Since the Soak Pit is odourless, installed underground and wastewater kept away from human contact, even the most sensitive communities may have little acceptance issues.

**Strengths and Weaknesses:**

- ⊕ Can be built and repaired with locally available materials
- ⊕ Technique simple to apply for all users
- ⊕ Small land area required
- ⊕ Low capital and operating costs
- ⊖ Primary treatment is required to prevent clogging
- ⊖ May negatively affect soil and groundwater properties

→ **References and further reading material for this technology can be found on page 196**

# Irrigation

| Phase of Emergency                                | Application Level / Scale                   | Management Level                            | Objectives / Key Features             |
|---|---|---|---------------------------------------|
| Acute Response<br>** Stabilisation<br>** Recovery | ** Household<br>** Neighbourhood<br>** City | ** Household<br>** Shared<br>** Public      | Productive use of water and nutrients |
| Space Required                                    | Technical Complexity                        | Inputs                                      | Outputs                               |
| *** High  | ** Medium                                   | ● Effluent, ● Stormwater,<br>● Stored Urine | ● Biomass                             |

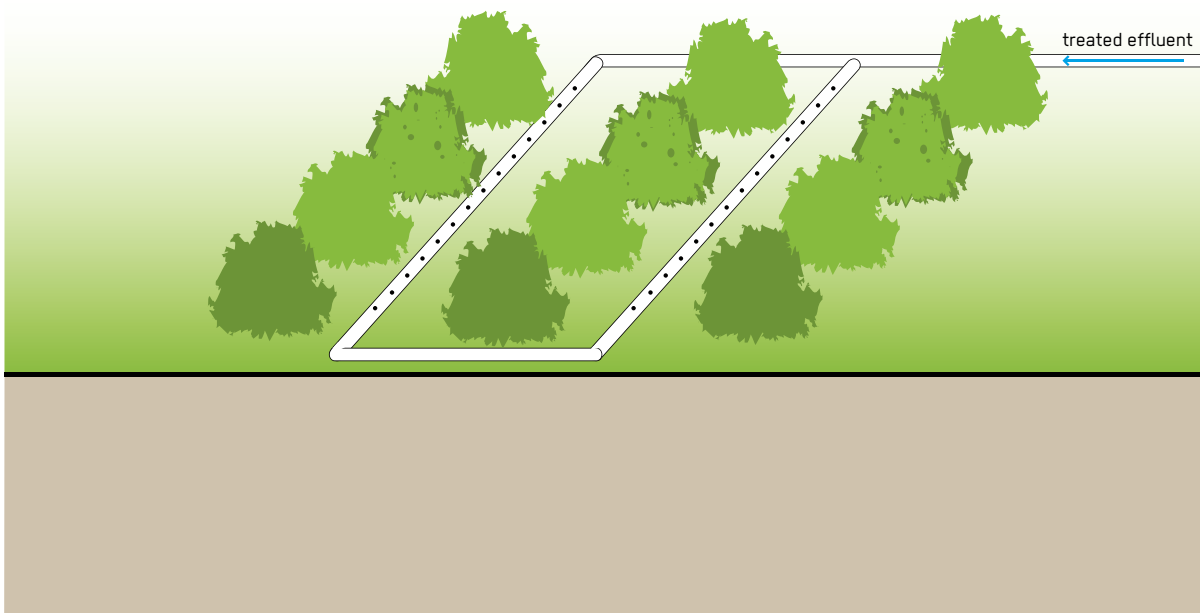

To reduce the dependence on freshwater and maintain a constant source of water for irrigation throughout the year, wastewater of varying quality can be used in agriculture and horticulture. However, only water that has had secondary treatment (i.e. physical and biological treatment) should be used to limit the risk of crop contamination and the health risks to workers.

There are two kinds of Irrigation technologies appropriate for treated wastewater: (1) drip irrigation above or below ground, where the water is slowly dripped on or near the root area; and (2) surface water irrigation where water is routed over-land in a series of dug channels or furrows. To minimise evaporation and contact with pathogens, spray or sprinkler irrigation should be avoided. Adequately treated wastewater can significantly reduce dependence on fresh water, and/or improve crop yields by supplying water and nutrients to plants. Raw sewage or untreated blackwater should not be used, and even well treated

water should be used with caution. Long-term use of poorly or improperly treated water may cause long-term damage to the soil structure and its ability to hold water.

**Design Considerations:** The application rate must be appropriate for soil, crop and climate, or it could hinder growth. To increase the nutrient value, urine can be dosed into irrigation water; this is called "fertigation" (fertilisation plus irrigation). The dilution ratio has to be adapted to the specific needs and resistance of the crop. In drip irrigation systems care should be taken to ensure that there is sufficient head (i.e. pressure) and maintenance to reduce the potential for clogging (especially, with urine from which struvite will spontaneously precipitate).



**Materials:** A filtration unit to reduce the risk of clogging is highly recommended before the irrigation water is used in a drip irrigation system. A drip irrigation system can be constructed using locally available materials such as a storage tank, and a hose or drip tape. Ready-made kits are also widely available.

**Applicability:** Irrigation with treated wastewater can be considered an option in the stabilisation and recovery phases of emergencies. Increasingly, food production and 'camp greening' programmes are being implemented. Reusing treated greywater for irrigation can reduce dependency on other freshwater supplies.

**Operation and Maintenance:** Drip irrigation systems must be periodically flushed to avoid biofilm growth and clogging from all types of solids. Pipes should be checked for leaks, as they are prone to damage from rodents and humans. Large-scale operations will require a trained operator. Workers should wear appropriate personal protective equipment.

**Health and Safety:** Adequate treatment (i.e. adequate pathogen reduction) should precede any irrigation scheme to limit health risks to those who come into contact with the water. Even treated effluent can still be contaminated depending on the degree of treatment the effluent has undergone. When effluent is used for irrigation, households and industries connected to the system should be made aware of the products that are and are not appropriate to discharge into the system. Drip irrigation is the only type of irrigation that should be used with edible crops, and even then, care should be taken to prevent workers and harvested crops from coming into contact with the treated effluent. The World Health Organization Guidelines for the Safe Use of Wastewater, Excreta and Greywater should be consulted for detailed information and specific guidance.

**Costs:** Transport costs of the treated water to the fields must be considered. Overall costs are highly dependent on the system applied. Irrigation with treated wastewater can generate revenue by increasing agricultural yields and save money if it replaces the need for other fertilisers and water. Commercial scale irrigation systems for industrial production are expensive, requiring pumps and an operator. Small-scale drip irrigation systems can be constructed out of locally available low-tech materials, and are inexpensive.

**Social Considerations:** The greatest barrier to the use of treated wastewater for Irrigation is social acceptance. It may not be acceptable to use irrigation water coming from a water-based sanitation system for edible crops. However, it may still be an option for biomass production, fodder crops and municipal projects such as irrigation of parks, street trees, etc. Depending on the source of the wastewater and on the treatment method, it can be treated to a level where it no longer generates significant odour or vector problems. Following appropriate safety and application regulations is important.

**Strengths and Weaknesses:**

- ⊕ Reduces depletion of groundwater and improves the availability of drinking water
- ⊕ Reduces the need for fertiliser
- ⊕ Potential for local job creation and income generation
- ⊕ Low risk of pathogen transmission if water is properly treated
- ⊖ May require expert design and installation
- ⊖ Drip irrigation sensitive to clogging
- ⊖ Risk of soil salinisation if the soil is prone to the accumulation of salts
- ⊖ Social acceptance may be low in some areas

→ **References and further reading material for this technology can be found on page 196**

# Water Disposal and Groundwater Recharge

| Phase of Emergency                               | Application Level / Scale                   | Management Level                       | Objectives / Key Features           |
|--|---|--|-------------------------------------|
| Acute Response<br>★ Stabilisation<br>★★ Recovery | ★★ Household<br>★★ Neighbourhood<br>★★ City | ★★ Household<br>★★ Shared<br>★★ Public | Safe disposal, Groundwater recharge |
| Space Required                                   | Technical Complexity                        | Inputs                                 | Outputs                             |
| ★ Little   | ★★ Medium                                   | ● Effluent, ● Stormwater               |                                     |

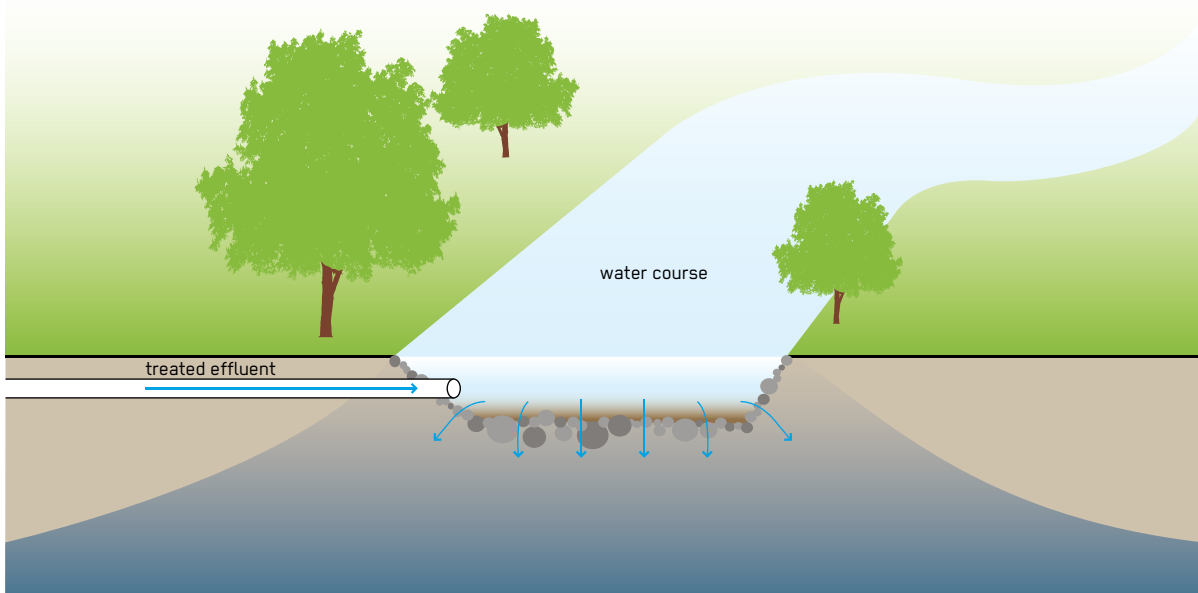

Treated effluent and/or stormwater can be directly discharged into receiving water bodies (such as rivers, lakes, etc.) or into the ground to recharge aquifers, depending on their quality.

The uses of the surface water body, whether for industry, recreation, spawning habitat, etc., and its size determine the quality and quantity of treated wastewater that can be introduced without deleterious effects. Alternatively, water can be discharged into aquifers. Groundwater Recharge is increasing in popularity as groundwater resources deplete and as saltwater intrusion becomes a greater threat to coastal communities. Although the soil is known to act as a filter for a variety of contaminants, Groundwater Recharge should not be viewed as a treatment method.

**Design Considerations:** It is necessary to ensure that the assimilation capacity of the receiving water body is not exceeded, i.e. that the receiving body can accept the quantity of nutrients without being overloaded. Parameters such as turbidity, temperature, suspended solids, biochemical oxygen demand, nitrogen and phosphorus content (among others) should be carefully controlled and monitored before releasing any water into a natural water body. Local authorities should be consulted to determine the discharge limits for the relevant parameters as they can widely vary. For especially sensitive areas, a post-treatment technology (e.g. chlorination (**POST**)) may be required to meet microbiological limits. The quality of water extracted from a recharged aquifer is a function of the quality of the wastewater introduced, the method of recharge, the characteristics of the aquifer, the residence time, the amount of blending with other waters, the direction of groundwater flow and the history of the system. Careful analysis of these factors should precede any recharge project.

**Materials:** Groundwater Recharge does not require materials. Preceding technologies to add the water to the receiving water body, like Leach Fields (D.9) or Soak Pits (D.10), require materials. Equipment for regular monitoring and evaluation of the groundwater quality might be needed.

**Applicability:** The adequacy of discharge into a water body or aquifer will depend entirely on the local environmental conditions and legal regulations. Generally, discharge to a water body is only appropriate when there is a safe distance between the discharge point and the next closest point of use. Similarly, Groundwater Recharge is most appropriate for areas that are at risk of saltwater intrusion or aquifers that have a long retention time. Depending on the volume, the point of discharge and/or the quality of the water, a permit may be required. This technology should be implemented downstream of any settlement, as treated wastewater may still contain pathogens.

**Operation and Maintenance:** Regular monitoring and sampling is important to ensure compliance with regulations and to ensure public health requirements. Depending on the recharge method, some mechanical maintenance may be required.

**Health and Safety:** For Groundwater Recharge, cations (e.g.  $Mg^{2+}$ ,  $K^+$ ,  $NH_4^+$ ) and organic matter will generally be retained within a solid matrix, while other contaminants (such as nitrates) will remain in the water. There are numerous models for the remediation potential of contaminants and microorganisms, but predicting downstream or extracted water quality for a large suite of parameters is

rarely feasible. Therefore, potable and non-potable water sources should be clearly identified, the most important parameters modelled and a risk assessment completed.

**Costs:** There are no direct costs associated with this technology. There can be indirect costs depending on the recharge method, for example, construction of an outlet pipe or construction of a Soak Pit (D.10). Regular monitoring of groundwater requires the installation of monitoring wells.

**Social Considerations:** The domestic or recreational use of water bodies at the location of recharge should be prohibited, as there are still some health risks if this water is used for consumption. This would require an information campaign at this location, for example using warning signs.

**Strengths and Weaknesses:**

- ⊕ Contributes to a “drought-resistant” water supply by replenishing groundwater
- ⊕ May increase productivity of water bodies by contributing to maintenance of constant levels
- ⊖ Discharge of nutrients and micro-pollutants may affect natural water bodies and/or drinking water
- ⊖ Introduction of pollutants may have long-term impacts
- ⊖ May negatively affect soil and groundwater properties

→ **References and further reading material for this technology can be found on page 196**

# Fish Ponds

| Phase of Emergency                               | Application Level / Scale               | Management Level                   | Objectives / Key Features                       |
|--|---|------------------------------------|---|
| Acute Response<br>★ Stabilisation<br>★★ Recovery | Household<br>★ Neighbourhood<br>★★ City | Household<br>★ Shared<br>★★ Public | Productive use of nutrients for fish production |
| Space Required                                   | Technical Complexity                    | Inputs                             | Outputs   |
| ★★★ High   | ★★ Medium                               | ● Effluent, ● Sludge               | ● Biomass                                       |

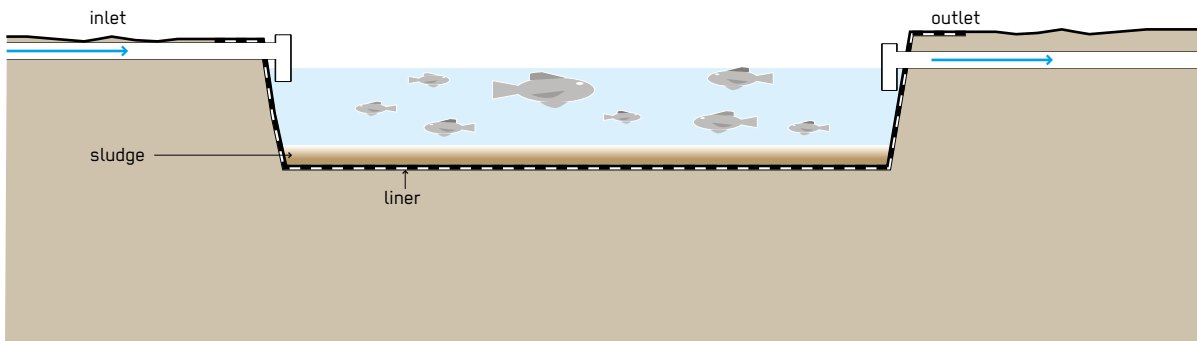

Fish can be raised in ponds (aquaculture) receiving effluent or sludge. The fish feed on algae and other organisms that grow in the nutrient-rich water and are eventually harvested for consumption.

There are three kinds of aquaculture designs for raising fish: (1) fertilisation of Fish Ponds with effluent; (2) fertilisation of Fish Ponds with excreta/sludge; and (3) fish grown directly in aerobic ponds (T.5). Fish introduced into aerobic ponds can effectively reduce algae and help control the mosquito population. It is also possible to combine fish and floating plants in a single pond. The fish themselves do not dramatically improve the water quality, but due to their economic value they can offset the costs of operating a treatment facility. Under ideal operating conditions, up to 10,000 kg/ha/month of fish can be harvested in larger-scale aquaculture. If the fish are not acceptable for human consumption, they can be a valuable source of protein for other high-value carnivores (like shrimp) or converted into fish meal for pigs and chickens.

**Design Considerations:** The design should be based on the quantity of nutrients to be removed, the type of fish, nutrients required by the fish and the water requirements needed to ensure healthy living conditions (e.g. low ammonium levels, required water temperature, oxygen levels, etc.). When introducing nutrients as effluent or sludge, it is important not to overload the system. Oxygen levels will show huge diurnal fluctuations due to photosynthesis and respiration. The critical period is early morning before sunrise when aeration may be required to maintain aerobic conditions. The biochemical oxygen demand should not exceed 1 g/m<sup>2</sup>/day. Only fish tolerant of low dissolved oxygen levels should be chosen such as tilapia, catfish and carp. These species are also tolerant to disease exposure and adverse environmental conditions. The specific choice will depend on local preferences, availability and ambient temperatures.

**Materials:** The materials required are those necessary to build a pond (T.5). The ponds can be lined or left unlined if the soil has a high clay content. An initial fish population must be brought, and sometimes additional fish feed, depending on the conditions.

**Applicability:** A Fish Pond is only appropriate where there is enough land (or a pre-existing pond), a source of fresh water and a suitable climate. The water used to dilute the waste should not be too warm, and the ammonium level should be kept low or negligible due its toxicity to fish. Fish Ponds can be considered from the stabilisation phase, when the construction or use of bigger sanitation infrastructure is possible. This technology is appropriate for warm or tropical climates with high levels of sunlight (ponds should not be shaded by trees or buildings) with no freezing temperatures, and preferably with high rainfall and minimal evaporation.

**Operation and Maintenance:** The fish should be stocked in the pond and harvested when they reach an appropriate age/size. Partial harvesting can maintain a suitable biomass while maintaining the availability of fish for consumption over time. Knowledge of fish health and care is important for the staff to understand what conditions are needed and which measures to take if the fish population faces a problem (disease, death in numbers). The pond should be drained periodically so that; (1) it can be desludged and; (2) it can be left to dry in the sun for 1 to 2 weeks to destroy any pathogens living on the bottom or sides of the pond. Workers should wear appropriate personal protective equipment.

**Health and Safety:** Various health hazards are associated with waste-fed aquaculture, especially hazards associated with excreta-related pathogens. The World Health Organization Guidelines for the Safe Use of Wastewater, Excreta and Greywater should be consulted for detailed information and specific guidance. The timing of the application of wastewater and excreta is an important risk management tool. It is recommended to stop the application of wastewater and excreta two or three weeks before harvest or alternatively to transfer the fish for depuration

in ponds which are not fed with wastewater or sludge. Before consumption fish should be stored in clean water for at least three days. Fish should always be cooked before consumption. If a fish is healthy, cleaned after harvest and cooked well, it is considered safe for consumption.

**Costs:** Raising fish is an income-generating activity, which can help finance the operation and maintenance of existing ponds. Capital costs are low if this activity is done in existing ponds and medium if the ponds first need to be built. The main operational costs are for pond and fish management and the required human resources. Funds must be allocated for sludge removal every few years.

**Social Considerations:** This technology may be of interest in contexts where there are little or no sources of dietary protein. The quality and condition of the fish will influence local acceptance. There may be concerns about contamination of the fish; in some cultures, fish grown in this way may be completely unacceptable. It is however a common practice in many countries and the fish usually find a ready market as they cost less to grow than fish grown on expensive feeds. The introduction of Fish Ponds may require additional information or hygiene promotion activities.

**Strengths and Weaknesses:**

- ⊕ Can provide a cheap, locally available protein source
- ⊕ Potential for local job creation and income generation
- ⊕ Relatively low capital costs; operating costs should be offset by production revenue
- ⊕ Can be built and maintained with locally available materials
- ⊖ Requires a large land (pond) area, usually on flat land
- ⊖ May require expert design and installation
- ⊖ Fish may pose a health risk if improperly prepared or cooked
- ⊖ Social acceptance may be low in some areas

→ **References and further reading material for this technology can be found on page 196**

# PART 2:

## Cross-Cutting Issues

The selection of an appropriate combination of sanitation technologies does not obey to technical considerations only. It is influenced by surrounding factors, such as the local physical conditions and the “enabling environment”. The WASH history in the project area must be taken into consideration, especially local practices, specific needs of the population and existing infrastructure. Sanitation interventions have to consider potential transition and exit strategies and certain contexts may require specific approaches, such as the response in urban settings, cholera prevention, community engagement or market-based programming. This section concisely introduces the most relevant cross-cutting issues clustered into three groups:

### Initial Situation

- X.1 Assessment of the Initial Situation
- X.2 Rehabilitation of Existing Infrastructure
- X.3 Soil and Groundwater Assessment
- X.4 Institutional and Regulatory Environment

### Conceptual Aspects

- X.5 Resilience and Preparedness
- X.6 Exit Strategy, Hand-over and Decommissioning of Infrastructure
- X.7 Urban Settings and Protracted Crisis Scenarios
- X.8 Solid Waste Management
- X.9 Cholera Prevention and Epidemic Management

### Design and Social Considerations

- X.10 Inclusive and Equitable Design
- X.11 Child Excreta Management
- X.12 Hygiene Promotion and Working with Affected Communities
- X.13 Market-Based Programming

X

# Initial Situation

## X.1 Assessment of the Initial Situation

In a humanitarian emergency, the assessment of the initial situation is a crucial first step in the planning process. It provides the baseline information necessary to guide decision-making for practical implementation. The main goals of the assessment are to gain a first understanding of the context and key risks and to become familiar with the actors involved. An initial assessment should provide enough information to start elaborating sanitation scenarios, including context-specific design parameters. This stage is characterised mainly by data collection, via different means, and subsequent data analysis.

Collecting good quality, relevant data is often not an easy task, particularly in contexts where data is already scarce, as it has either not been collected or analysed properly, or, sometimes, hidden or manipulated for political or personal reasons. Secondary data (**see table 1**) is existing data (e.g. reports, statistics or maps) usually available from Governmental agencies, national or regional WASH cluster structures or other organisations previously active in the affected area, and which can serve as a preliminary introduction to the context. However, secondary data should always be considered with care, and the collection of primary data (**see table 1**) that involves direct contact with the respondents (by means of interviews or questionnaires or other participatory methods) is recommended. The best way to get a reasonably accurate assessment is to rely on several sources of information, which can be cross-checked, triangulated and, if necessary, complemented by further research.

The human dimension of an initial assessment should not be overlooked as this is when the first contact occurs and trust can be developed with the stakeholders. The role of the local facilitator(s) is very important here (**X.12**), as they help to open doors and gain access to information. It should be remembered that data sets, if they exist, are not always readily accessible and getting accurate information usually depends on the goodwill of local partners and actors.

### Initial WASH Assessment

An initial rapid WASH assessment typically follows a multi-sectoral needs assessment. The purpose of a rapid WASH assessment is, from a WASH perspective, to identify the impact of the crisis, make initial estimates of needs, and define priorities for action. Such an assessment is crucial, even in an acute emergency; it is the basis of a successful WASH emergency response programme and will ultimately determine whether sanitation facilities are properly designed, used and maintained.

An initial rapid WASH assessment should take place within the first three days of the onset of the emergency. Depending on the scale of the emergency, and the time and resources available, the assessment exercise should be completed within one day. It is important that the assessment is coordinated and supervised by an experienced WASH professional and jointly undertaken with WASH actors, preferably familiar with the context, that speak the local language and ideally in gender-balanced teams. Implementing a successful WASH needs assessment requires expertise in water engineering, hydrogeology, sanitation, hygiene, data collection, data management, as well as social competencies. Often decisions at the initial stage of a crisis are based on limited or dynamic information, but it is important also to plan for the various future scenarios that may unfold. Many assessment

Table 1:  
Assessment Data  
Sources

| Primary Data Sources   | Secondary Data Sources  |
|--|---|
| <ul style="list-style-type: none"> <li>• Key informant interviews</li> <li>• Focus group discussions</li> <li>• (Semi-structured) interviews</li> <li>• Participatory/community mapping</li> <li>• Observation and (transect) walks</li> <li>• Participatory methods such as 3-pile-sorting, problem ranking, pocket chart voting</li> <li>• Emergency market mapping</li> <li>• Mobile based surveys</li> </ul> | <ul style="list-style-type: none"> <li>• Water, energy, environment, health, urban development ministries and local authorities</li> <li>• Census data and household enumeration</li> <li>• Demographic and health surveys</li> <li>• Global satellite images providers (UNITAR/UNOSAT)</li> <li>• UNHCR and UNICEF databases and reports</li> <li>• Country-specific cluster information on "humanitarianresponse.info"</li> <li>• Other UN agencies, UN-OCHA, UN-Habitat and UNICEF</li> <li>• NGOs and development agencies that worked in the area before the crisis</li> </ul> |



checklists are available, based on agreed humanitarian standards (for example, see the needs assessment checklist in the Sphere Handbook). It is important to share assessment information with the relevant coordination groups (e.g. WASH Cluster) in a timely manner and in a format, that can be readily used by other humanitarian agencies.

The overall aim of initial WASH assessments is to allow humanitarian actors to distinguish between urgent lifesaving needs and needs that require attention at a later phase. The specific objectives of an initial WASH assessment are:

- To identify water and hygiene conditions: drinking water sources, coverage and infrastructure, types of supply (e.g. networks, taps in houses, fountains, trucks), operators (public/private), prevalence of diseases related to faecal matter (e.g. diarrhoea, cholera, bacillary dysentery, cryptosporidiosis) that require careful management
- To assess ground conditions and environmental factors (e.g. presence of rocky ground, high groundwater table, flood prone areas, climatic data etc.) which may affect decisions on appropriate sanitation options **(X.3)**
- To identify sanitation actors and their roles, and to conduct a brief stakeholder analysis
- To assess key hygiene practices, cultural habits and taboos in terms of water needs and sanitation, for example anal cleansing habits (with water or with dry material) and defecating position (sitting vs. squatting) (secondary data, key informants)
- To identify sanitation “hot spots” (e.g. open defecation areas, surface water points used for bathing, washing or drinking purposes, open drains, wastewater and faecal sludge discharge points)
- To identify specific vulnerabilities, for example people with disabilities or specific diseases in order to tailor WASH services accordingly **(X.10)**
- To assess capacity of the affected people and relevant authorities to respond (through stakeholder analysis, key informants, observation)
- To identify institutional and legal constraints (e.g. land ownership, discharge standards, discharge requirements etc.)
- To identify existing WASH infrastructure conditions, management arrangements and services
- To assess accessibility of the area (e.g. for desludging vehicles) and potential space limitations or opportunities
- To assess potential to work/respond through local market structures and check the availability of relevant construction material **(X.13)**

Key information should be collected from as many different people and sources as possible to validate findings. Additional data may be collected after decisions have been made for confirmation. Key technical partners during the assessment are the line ministries (e.g. water, health), NGOs (international and national) and UN agencies such as UNHCR, OCHA, UNICEF and WHO.

### Assessment of Existing Sanitation Infrastructure Conditions

Determining the condition of the existing sanitation infrastructure is an essential part of any needs assessment especially in contexts where it is insufficient or aging. When assessing sanitation infrastructure, the entire sanitation chain from the user interface **U** through collection and storage/treatment **S**, conveyance **C**, (semi-) centralised treatment **T** to use and/or disposal **D** should be described. Key characteristics of each component of the sanitation service chain should be noted including existing gaps, access issues, hazards, damage and the overall risks to public health. Certain large-scale sanitation infrastructures (such as large sewage plants) can be difficult to assess and may require specialised expertise. Once infrastructure has been assessed the team can define priorities for the sanitation response **(X.2)**.

→ **References and further reading material can be found on page 196**

## X.2 Rehabilitation of Existing Infrastructure

Planning the rehabilitation and reconstruction of sanitation infrastructure is a task that normally falls under the management of specific government agencies. However, in post disaster/emergency situations, depending on the scale of the resulting damage, aid agencies, civil society and other organisations, private and public, may collaborate with the government to facilitate the rehabilitation and/or (re)construction of the infrastructure, based on damage and needs assessments.

Before thinking about new emergency sanitation technology components to be implemented, it is recommended to conduct a proper assessment of what sanitation infrastructure (components) are in place, what might still be functioning and what can be rehabilitated with minimal effort (e.g. after a typhoon all above surface infrastructure may be destroyed or blown away but underground pits and septic tanks may still be in place and operational. With rehabilitation of the superstructure it may be possible to put these into service again).

Rehabilitation can be a complex process that, depending on the size of the systems, can take between a couple of weeks to up to several years. When undertaking rehabilitation programmes, it is important that the different organisations involved coordinate with the government and among themselves, and conform to existing national policies and standards (X.4). Linkages to existing long-term governmental programmes should also be examined and developed.

Once the acute needs of the affected population have been met, further assessments will indicate key sanitation facilities that require rehabilitation. The basic principle of the rehabilitation of sanitation infrastructure is to prevent the deterioration of existing infrastructure, promote safe sanitation and hygiene practices and prevent sanitation emergencies. Additionally, rehabilitation efforts provide an opportunity to improve the quality of the existing sanitation system, the environment and to build safer more resilient communities. It is therefore important to appropriately incorporate the principals of sustainability from the earliest stages of the rehabilitation effort.

#### Considering Sustainability in Sanitation Rehabilitation Programmes:

- Avoid building sanitation infrastructure that are exposed to hazards, inefficient or insufficient (too small)
- Ensure technical sustainability – local technical capacity and materials should match the level required by the sanitation technology being implemented
- Build on local knowledge and utilise local materials where appropriate and possible
- Where local communities are to operate and maintain the infrastructure, they should be involved throughout entire project cycle
- Where required, increase community and local authorities' knowledge and capacities on the operation and maintenance of the infrastructure that they will eventually take over

In line with the Sphere standards, it is important to agree on the construction standards and guidelines with relevant national and local authorities to ensure that key safety and performance requirements are met. Local or national building codes should be adhered to. In situations where building codes do not exist or have not been enforced, international building codes and/or uniform building codes can be tailored to the local situation. Local culture, climatic conditions, available resources, building and maintenance capacities, accessibility and affordability should all be a part of system design, implementation and operation and maintenance.

The success of a sanitation rehabilitation programme requires well-functioning and sustainable management. To understand the contribution the local market can make to sustainable sanitation, market mapping and analysis can be implemented (X.13). Market mapping and analysis can identify strategies, such as cash-based interventions, local procurement and other innovative forms of support to enable sanitation rehabilitation programmes to take advantage of existing market capabilities. Engaging with the existing market can contribute to a more efficient use of humanitarian resources, encourage recovery and reduce dependence on outside assistance.

When external actors participate in infrastructure rehabilitation the terms of engagement should be clear, including the duration of project support, transition and exit strategies (X.6). The handover of responsibilities to local government, community, service providers or other organisations should include clear instructions and training on infrastructure operation and maintenance.

### X.3 Soil and Groundwater Assessment

A reliable knowledge of existing soil and groundwater conditions is important in sanitation planning and a key factor in the selection of appropriate technologies, especially where infiltration-based sanitation systems such as Single Pit Latrines (S.3) or Soak Pits (D.10) are to be used. Soils with a high infiltration capacity can be desirable from a technology perspective, but may be undesirable from a health and safety perspective, as they increase the risk of groundwater contamination. On the other hand, more compact, impermeable soils such as clay may severely limit infiltration and making drainage almost impossible. This has a direct impact on the filling rate of pits and the quality of faecal sludge. The main danger is the contamination of groundwater used for drinking water by pathogens of faecal origin. When pit latrines are densely concentrated in an area and shallow aquifers are used as a source of drinking water, nitrate (which should not exceed 50 mg/L in drinking water according to World Health Organization guidelines) may also be a health hazard.

When a settlement or camp is built, and too many trees are felled, soil can lose permeability through compaction, resulting in an increased runoff and a higher risk of flooding. Infiltration can also be reduced, which results in less recharge of shallow aquifers. At the same time, the installation of sanitation infrastructure increases the risk of surface and groundwater contamination. Two flows of possible bacteriological contamination must be considered simultaneously: contamination through runoff water flowing into a drinking water well and contamination of the groundwater.

To assess the risk of water source contamination, an approach based on the travel time for effluent from the latrine to the water source is recommended. To reduce the risk of bacteriological source contamination, the liquid phase coming from the latrine should travel for at least 25 days in the saturated zone of an aquifer. The soil type and the groundwater flow direction must be evaluated. The latter depends on the gradient of the aquifer, which also has a direct influence on the speed at which the groundwater travels.

Water infiltrating from the surface through the unsaturated zone usually flows faster than groundwater in the saturated zone. In **figure 5**, the water body H1 is higher than the water body H2, meaning that the groundwater will flow from left to right. The hand pump (HP) is most at risk from surface contamination from latrine 2 which has a higher topographic altitude, but most at risk from groundwater contamination from latrine 1 as water is flowing from left to right due to the hydraulic gradient. The hand pump creates a cone of depression in the water table, which can locally invert the flow of water (highlighted in dark blue).

Small amounts of wastewater entering the soil might take a longer time to travel through the unsaturated zone. However, if the unsaturated zone is sufficiently wet, the transport will be several times faster (and the die-off of microbes lower) and so the contamination risk will increase. Therefore the size of the latrine facility and the volume of wastewater potentially entering the soil are important to consider, as well as the impact of rainwater. Large latrine facilities pose a significantly higher risk.

## Percolation Test

To assess the speed of movement of contaminated water through the soil, a percolation test should be carried out. Percolation refers to the movement of water through soil, and percolation tests are performed to determine the rate at which water infiltrates. This is an easy test to conduct in field conditions, and gives crucial information when designing a water supply and/or sanitation strategy. There are different methods, each associated with a specific table linking observations to infiltration rates. Percolation tests should be performed in order to check how suitable a site is for projects such as latrines, reservoirs and sanitary landfills.

A percolation test is performed essentially by digging a hole with a shovel or an auger, filling the hole with water to a specified depth and measuring how long it takes the water to drain out of the hole. The base of the test hole should be at the same depth as the planned base of the latrine pits to ensure that the test is a relatively good reflection of percolation conditions at this depth. After the hole is bored or dug and cleaned of loose material, the bottom should be covered with 5 cm of gravel, to avoid clogging during the test. This test should be carried out at the earliest 12 hours after water was first added to the hole (on a wet, saturated soil, not on a dry soil). This procedure must be respected to ensure that the soil is given time to swell and to approach the conditions expected once the sanitation system will be in operation.

The following table gives guideline infiltration rates for clean water and wastewater in different types of soil

Figure 5:  
Surface and Groundwater  
Potential Contamination  
Pathways

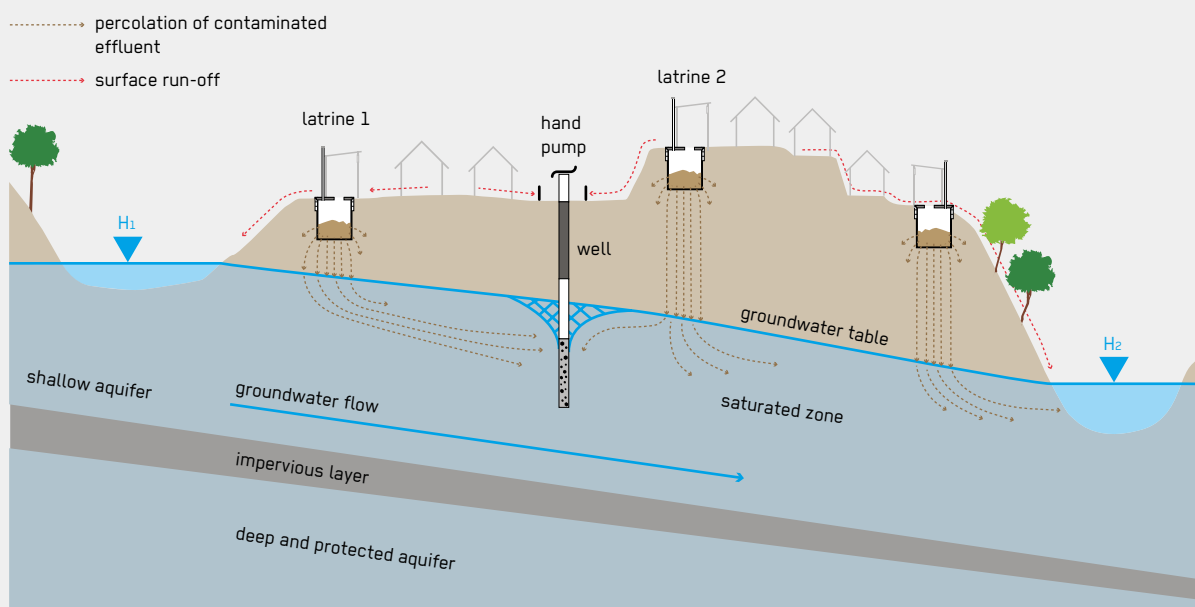

and simple descriptions to assist soil identification. The soils fall under two broad categories: (1) granular soils, and (2) fissured and fractured soils. It should be noted for granular soils that infiltration rates for wastewater are much lower than those for clean water and are also likely to decrease with time as the soil becomes saturated and clogged. Infiltration also occurs through the walls of the pit, at an angle of about 45°.

Table 2:  
Soil Infiltration Rate  
(adapted from Reed and  
Dean, 1994)

| Soil type                       | Description   | Infiltration rate (L/m <sup>2</sup> /day) or (mm/day) |                          |
|---------------------------------|---|---|--------------------------|
|                                 |   | Clean water   | Wastewater               |
| Gravel, coarse, and medium sand | Moist soil will not stick together  | 1,500-2,400   | 50                       |
| Fine and loamy sand             | Moist soil sticks together but will not form a ball                           | 720-1,500   | 33                       |
| Sandy loam and loam             | Moist soil forms a ball but still feels gritty when rubbed between fingers    | 480-720   | 25                       |
| Loam, porous silt loam          | Moist soil forms a ball which easily deforms and feels smooth between fingers | 240-480   | 20                       |
| Silty clay loam and clay loam   | Moist soil forms a strong ball which smears when rubbed but does not go shiny | 120-240   | 10                       |
| Clay                            | Moist soil mold like plasticine and feels very sticky when wet                | 24-120  | Unsuitable for soak pits |

For example: if, during the percolation test, the water level drops 12 mm in 30 minutes, this indicates a percolation value (or infiltration rate) in mm/day =  $12/30 \times 60 \times 24 = 576$  mm/day (typical value for sandy loam – cf. **table 2**). Note that the value in mm/day is always equal to the value in L/m<sup>2</sup>/day. For Soak Pits or Pit Latrines to function correctly, the infiltration rate for clean water should be at least 120 mm/day.

### Groundwater Level

The groundwater level can be estimated through the observation of nearby wells, of nearby vegetation (some plants and trees are indicative of high groundwater table) and through interviews with locals. Seasonal variations should also be taken into account, as pits that are dry during the dry season may fill with water during wetter periods of the year. In the worst case, flooding may occur. Groundwater pollution will extend in the direction of groundwater flow (which is mainly horizontal). Therefore, if wells are built in the same aquifer, water should be abstracted from below the polluted zone, provided that the well is adequately sealed at the level of pollution and the abstraction rate is not high enough to draw

polluted water into the well. If the pollution of a shallow water table is a cause of concern, it may be necessary to restrict the depth of latrines and use Raised Latrines (**S.7**) or other above-ground solutions.

In general, if a water source is being contaminated by a large number of latrines, it is usually easier to move the water source than change the sanitation system. It should be remembered that drinking water contamination also commonly occurs at the point of abstraction, during transport and storage, and at the point of use, through unhygienic collection and storage devices and poor personal hygiene.

### Mitigation Measures to Reduce the Risk of Microbiological Contamination

If the soil and groundwater assessment show that it is likely that latrines will contaminate a water source, the following options can be considered:

- Implementation of Raised Latrines (**S.7**)
- In high water table or flood situations, the containment infrastructure should be watertight to minimise the contamination of groundwater and the

- environment, with a safe transport of the effluent.
- Surface water sources, such as wells, should be protected to reduce the contamination potential via the ground surface. Protective measures include withdrawing water from a depth below the level of contamination, building a protective well wall at the surface to prevent flood water from entering the well, sealing the well with clay or a similar material to prevent surface run-off from flowing down the side of the well via the annular space.
- Where distances between containment pits and water sources are inadequate, a water safety plan should be implemented to minimise contamination risk.
- Chlorination of drinking water
- Moving the water source

→ **References and further reading material can be found on page 196**

## X.4 Institutional and Regulatory Environment

During humanitarian emergencies, states are primarily responsible for the safety and security of the affected population as well as for refugees and internally displaced persons (IDPs) on their territory. National laws, regulations, standards and codes provide the architecture for the emergency response, including sanitation and other WASH interventions. Regulations specify how sanitation services are to be provided and by whom, what delivery standards should be met, the ownership of infrastructure and services, and how operation and maintenance models are to be designed and implemented. Standards and codes specify, for example, the level of wastewater treatment needed to protect the quality of receiving waters, the design of sanitation technologies, or the quality of material and equipment to be used in the performance of environmental services.

The overall WASH emergency response is implemented by water and sanitation related government departments. Local government therefore plays an important role and is usually responsible for all local public services, land issues, and disposal and discharge sites. National policies and decisions will therefore have a major impact on the approach that local authorities take in the relief effort in general.

In reality, many countries experiencing conflict, natural disaster or any public emergency often are confronted with significant constraints in terms of capacities and resources and are therefore unable to fully assume the responsibility for the coordination and implementation of an effective response. In such cases, the government may request non-state actors such as the operational UN

organisations, local and international NGOs, the International Red Cross and Red Crescent Movement and private companies to support in delivering the humanitarian requirements of the affected population.

### Coordination of Response Delivery

It is of utmost importance that emergency response operations supported by external or non-governmental agencies do not counteract or operate in isolation or in parallel to government efforts. Existing national capacities and local structures should always be the starting point when planning emergency response services, and where required should be assisted by targeted capacity-building measures.

To ensure effective coordination between the government and different WASH actors, external coordination mechanisms such as the WASH Cluster may be necessary. The Global WASH Cluster provides an open, formal platform for all emergency WASH actors to coordinate and work together. For the WASH Cluster, the cluster lead agency is UNICEF. In some instances, the WASH Cluster can also be administered or co-led by a local or international NGO that has the WASH expertise and the necessary local networks to fulfil this role. Cluster coordination arrangements will depend on the government, UN and NGO response capacity and the presence and effectiveness of existing coordination mechanisms as well as on the scale, phasing, and anticipated duration of the emergency. Whatever structure is adopted, it must be flexible enough to suit all stages of the emergency response e.g. expanding during intensive relief activities and scaling back as the Cluster merges or phases out. Identifying an appropriate coordination structure at the national level will depend on the government structures and coordination mechanisms that are already in place.

External humanitarian actors have basically three different ways of interacting with a specific country context: (1) they coordinate their relief interventions via the established WASH cluster mechanism, (2) they are directly involved in the humanitarian relief interventions and (3) they partner with or (financially) support local actors in their efforts to deliver adequate response.

### Legal and Regulatory Framework

When planning a WASH response, national laws and regulations regarding sanitation infrastructure need to be understood. Laws generally provide the overall framework within which regulations provide the more detailed guidance. A range of laws address wastewater management, including environmental legislation, public health laws and planning laws, within which standards for water quality, wastewater discharge, effluent quality and re-

use as well as environmental standards to protect water sources can be found. Codes of practice often state which systems are accepted and how they should be designed and built.

It may not be possible in the acute phase of the emergency to design sanitation systems in line with national standards and regulations; the solutions should be discussed with the responsible authorities. Pilot status and moratoria are ways to implement infrastructure out of the existing codes of practice and standards, and may also lay the ground for future reforms.

Planning with the hand-over and exit strategy in mind (X.6) typically increases the overall acceptability and potential sustainability of new systems. If national guidelines are not specific or existent, the Sphere Humanitarian Charter and Minimum Standards in Humanitarian Response should be referred to for standards.

→ **References and further reading material can be found on page 196**

# Conceptual Aspects

## X.5 Resilience and Preparedness

Preventive measures help reduce the severity of a disaster and to streamline disaster management. Many emergency situations follow predictable patterns and most disaster-prone regions are well known. At the same time disaster and crisis scenarios are becoming increasingly complex and traditional re-active relief interventions are proving insufficient. Disaster prevention or mitigation thus has an important role to play and must be considered by both relief and development actors to address the underlying vulnerabilities and to build capacities to cope better with future shocks. Preventive measures include strengthening resilience, increasing preparedness in case of an acute emergency and disaster risk reduction (see table 3). These are integral parts of both sanitation planning and national, regional and local development strategies.

Table 3:  
Preventive Measures,  
Definitions and Implications for  
Sanitation Infrastructure

|                         | Definition  | Key Aspects Related to Sanitation Infrastructure  |
|-------------------------|---|---|
| Resilience              | <b>Ability</b> of countries, communities, individuals, or organisations that are exposed to disasters, crises and underlying vulnerabilities <b>to manage change</b> .                        | <ul style="list-style-type: none"> <li>• Implementation of robust and durable sanitation infrastructure adapted to local extreme conditions</li> <li>• Capacity building on how to build, repair, operate and maintain sanitation infrastructure</li> <li>• Hygiene promotion and sensitisation measures</li> <li>• Establishing community structures (WASH committees &amp; health clubs)</li> </ul>   |
| Preparedness            | <b>Precautionary measures</b> to strengthen the ability of the affected population and involved organisations <b>to respond immediately</b> .   | <ul style="list-style-type: none"> <li>• Contingency planning and emergency preparedness plans including how to deal with wastewater when sewer networks do not function, and how to deal with faecal contamination of water sources</li> <li>• Stockpiling of sanitation equipment and availability of materials/infrastructure</li> <li>• Emergency services and stand-by arrangements</li> <li>• Establishment of support networks among different regions</li> <li>• Capacity building and training of volunteers and emergency personnel</li> <li>• Strengthening of local structures through community planning and training</li> </ul> |
| Disaster Risk Reduction | <b>All preventive measures</b> (incl. resilience and preparedness) that aim <b>to reduce disaster risks</b> through systematic efforts to analyse and reduce the causal factors of disasters. | <ul style="list-style-type: none"> <li>• Reducing potential impact of hazard events on sanitation hardware and services (resilience and mitigation)</li> <li>• Ensuring a rapid service level and structural recovery of sanitation hardware and services after hazard events (preparedness)</li> <li>• Ensuring sanitation system design addresses earlier vulnerabilities (build back better and resilience)</li> <li>• Ensuring sanitation services have minimal negative effects on society (do no harm)</li> </ul>   |

## Resilience

At its core resilience can be described as the ability of countries, communities, individuals, or organisations that are exposed to disasters, crises and underlying vulnerabilities to manage change. This can be achieved by anticipating, reducing the impact of, coping with and recovering from effects of adversity without compromising long-term prospects. Strengthening resilience requires longer-term engagement and investments. It needs an in-depth analysis of previous emergencies, of underlying causes of vulnerability and of existing human, psychological, social, financial, physical, natural or political assets at different levels of society. The goal is to develop locally appropriate measures that can be incorporated into existing structures and processes to increase capacity and capability of involved stakeholders and their self-organisation potential. Important components to enhance resilience include capacity development, trainings, education, awareness raising, sensitisation and advocacy as well as improving the robustness and durability of implemented sanitation technologies and services.

**Robustness** is the ability of a technology to provide a satisfactory outcome in a variable environment. It is important that in emergencies, sanitation technologies be resilient against failure and keep functioning despite disruptions (such as power cuts, water shortages and floods). It is therefore important to think about robustness early in the planning for sanitation provision. Given the uncertainties, it is advisable to consider sanitation systems so that they are functional in a range of possible scenarios. For example, flood-proof, raised latrines can avoid sludge overflowing during floods; wastewater treatment plants should have stormwater by-passes. There is no 'silver bullet' for planning a robust sanitation option. Each technology has specific strengths and weaknesses depending on the local context and available skills and capacity.

**Durability** is the ability of a technology to last a long time without significant deterioration. The longer it lasts, the fewer resources are needed to build replacements and the more resistant technologies are to wear and tear, thus further reducing the operation and maintenance (O&M) costs along with the risks of failure. Technologies should be chosen taking account of local capacities for O&M, repair and the availability of spare parts. It may be necessary in some cases to choose a lower level of service, to avoid having essential equipment that cannot be repaired when it breaks down (e.g. pumps, grinders etc.). To increase the durability of most treatment technologies appropriate pre-treatment needs to be considered.

## Preparedness

The Sphere guidelines describe the term preparedness as precautionary measures taken in view of anticipated disaster or crisis scenarios to strengthen the ability of the affected population and involved organisations to respond immediately. Preparedness is the result of capacities, relationships and knowledge developed by governments, humanitarian agencies, local civil society organisations, communities and individuals to anticipate and respond effectively to the impact of likely, imminent hazards. People at risk and the responsible organisations and institutions should be able to make all necessary logistical and organisational preparations prior to the potential event and know what to do in case of an emergency. Apart from early warning systems and the development of emergency plans it can include the stockpiling of equipment as well as the availability of potential evacuation plans.

## Disaster Risk Reduction and Prevention

Disaster Risk Reduction (DRR) can be seen as an umbrella term for all preventive measures including those described under resilience and preparedness. It aims to reduce disaster risks through systematic efforts to analyse and reduce causal factors of disasters. Examples of disaster risk reduction include reduced exposure to hazards, reducing the vulnerability of people and property, proper management of land and environment, and improving preparedness and early warning systems. A proper risk analysis forms the basis for adequate DRR measures. It assesses the potential exposure of communities to these risks, the social and infrastructural vulnerability and communities' capacity to deal with risks. The importance of the DRR approach is being increasingly recognised by the international community. Historically, development actors have not invested significantly into DRR and prevention, whether due to a lack of awareness, a lack of incentives or a lack of emergency-related expertise. In recent years DRR and conflict prevention have therefore turned into cross-cutting issues that are addressed through relief, recovery and development instruments. Non-functioning or inadequate sanitation services can potentially cause disasters, and hazards in turn can degrade sanitation services, resulting in increased disaster risk. It is therefore inevitable to consider potential disaster risks when setting up or developing sanitation services whether it is in relief, recovery or development.

→ **References and further reading material can be found on page 196**

## X.6 Exit Strategy, Hand-over and Decommissioning of Infrastructure

An exit strategy in the context of emergency sanitation interventions is a planned approach of why, what, when and how implementing organisations will end their sanitation related humanitarian engagement. This includes the process of transitioning, handing-over, decommissioning of infrastructure and exiting or disengaging from activities, projects, programme areas or countries.

Potential exit and transition strategies should be considered from the start of activities. This is particularly important in all non-acute scenarios, and should be implemented as soon as basic sanitation services are (re-)established at a level that successfully reduce vulnerabilities brought upon by acute environmental health risks. For post-acute, chronic and protracted crises, exit criteria are applied. These criteria help compare the advantages and cost-effectiveness of a sustained humanitarian intervention with those of an intervention led by local authorities and agencies, or other donors and/or partners. Exit and transition strategies are context-dependent. However, they must be addressed at an early stage of an intervention for reasons of transparency with partners and to promote a seamless handover to respective government departments or development partners respectively. Humanitarian sanitation interventions must be in line with national strategies and policies (X.4). If the local situation allows they should be carried out in coordination with the government and/or relevant development actors to jointly define scope and focus of the interventions. Implementing partners must specify when and how project support will be terminated and handed over to the local government, other local organisations or service providers capable to sustain/maintain the achieved sanitation service levels, or clarify whether and how projects will be followed up (e.g. by another phase and potential for follow-on funding to continue WASH activities if needed). The following sustainability criteria should be addressed as early as possible to allow for a successful hand-over to local governments or other development actors and guarantee the future viability of the system:

**Technical sustainability:** Sanitation interventions must support locally appropriate technologies and designs as well as available and affordable local construction materials. Interventions need to be balanced between technically feasible solutions and what the affected population, local government entities or service providers desire and can manage after the project ends in order for sanitation services to remain operational.

**Financial sustainability:** The respective costs for the long-term operation and maintenance (O&M) of sanitation infrastructure need to be considered during the selection of the system modules. While cost recovery is not a priority in acute humanitarian sanitation response, awareness of the protracted financial consequences of (re-)establishing sanitation services is essential from the outset.

**Socio-cultural and institutional sustainability:** All sanitation interventions need to consider local acceptability and appropriateness of the implemented systems, convenience, system perceptions, gender issues and impacts on human dignity. Actions need to be taken to ensure that hygiene promotion activities and behaviour change interventions are sustainable. The capacity of the affected population, community-based organisations or sanitation service providers to manage infrastructure, including financial management and O&M, should be known to identify the requirements for an enabling environment. Organisations and structures (public, private and community) need to be in-place to provide the necessary support.

**Environmental sustainability:** The impact of interventions on local water resources needs to be assessed prior to the intervention. To build resilient sanitation systems the design needs to be adapted to the identified risks. The inclusion of integrated water resource management and sanitation safety plans is considered an integral part of the response. The design involves a comprehensive evaluation of water resources; an assessment of current and future demand; the definition of roles and functions of local and national authorities; and the identification and enforcement of water-use rules and/or master plans for water, or wastewater, systems in urban settings.

In acute scenarios involving temporary and generally on-site solutions it may be necessary to consider dismantling and decommissioning these sanitation facilities. The implementing organisation responsible for construction is usually also responsible for decommissioning. Some key issues to consider when decommissioning on-site sanitation infrastructure are outlined on the following page.



### Decommissioning of Sanitation Infrastructure:

1. Decommissioning should ideally be carried out towards the end of the 'dry' season when the contents of containment technologies will have had the most opportunity to dry out.
2. Staff should be trained and provided with protective personal equipment in order to dismantle superstructures, remove latrine slabs and pipes, and backfill pits and tanks.
3. Lime, chlorine or another form of disinfectant should be used to clean latrine slabs or pedestals, to reduce health risks and to prevent unpleasant odours.
4. If pit/tank content is wet it may be necessary to remove it using a Manual or Motorised Emptying and Transport device (C.1, C.2) or dig an overflow trench to absorb displaced fluids. The trench can either be dug around the top of the latrine or as a single line drain to work as a Leach Field (D.9).
5. Debris from toilet superstructure or other dismantled facilities can be thrown into pits along with wood chips, ash or other available organic matter to aid decomposition. As these are added, fluids will overspill into the overflow trench; once the flow stops this can then be backfilled with soil and site rubble.
6. The pit or tank should be capped with a mound of soil and rubble to allow for further settling of contents.
7. Vegetation can be planted on top if in line with site rehabilitation (D.5). If not, a larger pile of debris should be placed over the filled pit to allow for further subsidence as the contents settle and decompose. Capping with concrete should be considered if in a populated area where access is possible. However, potential subsequent settling must be considered.
8. If possible the area should be fenced off to prevent it from being disturbed.
9. Used superstructure materials (wood, tarpaulin, slabs etc.) and prefabricated plastic superstructure units may become a solid waste problem (X.8).  
If these cannot be re-used (after proper disinfection) they should be recycled or disposed of in accordance with local regulations.

→ **References and further reading material can be found on page 196**

## X.7 Urban Settings and Protracted Crisis Scenarios

By 2050 the world's urban population is expected to nearly double, making urbanisation one of the 21<sup>st</sup> century's most transformative trends. At the same time, natural disasters, armed conflicts and extreme violence are increasingly taking place in urban areas, causing long lasting and cumulative damage to fragile or often already dysfunctional public services (such as sanitation) and posing substantial sustainability challenges.

When crises in urban areas last years or even decades, the humanitarian needs become acute as entire systems and public services are weakened to the point of collapse. The resilience of society is stretched to the limit when the means of covering basic human needs is beyond their control. This is particularly the case for those living in urban rather than rural areas, as they are dependent on increasingly complex essential services, such as sanitation infrastructure, sewage networks or faecal sludge management services. Humanitarian approaches and responses must therefore be designed very differently from at present.

Particular attention should be given to the cumulative impact of chronic service degradation and the increasing risk to public health. To a large extent, the problems stem from the complexity of urban systems and their dependence on large-scale, interconnected infrastructure that relies on the availability of qualified staff and reliable energy and water supplies to ensure service delivery. In many of these contexts, the water supply system fails, electricity is cut off and the collapse of this infrastructure significantly affects the capacity to run a complex sanitation system. This is compounded by the fact that educational institutions often stop working and job opportunities in established sectors are lost. Coupled with the social, political and economic fragility of many states, as well as natural disasters, these dynamics force millions of people to flee their homes and seek safe havens elsewhere, usually in cities either within their own country or abroad, often overburdening the capacities of the host city's infrastructure.

While traditional humanitarian approaches have been largely developed in rural contexts, addressing vulnerabilities and specific needs of urban populations under protracted crisis requires complex socio-technical approaches and long-term solutions that go beyond the current humanitarian-development divide and often beyond the capacity and skill-set of humanitarian actors. In terms of sanitation challenges, it also means that humanitarian organisations need to deal with more complex offsite sanitation systems and services, and sometimes the rehabilitation of sewer-based systems and large-scale centralised treatment plants.

## Understanding Essential Urban Services

Local and global economic and political forces are constantly changing the way people live and where they reside, blurring the once clear distinction between “rural” and “urban” areas. However, critical components of essential services, such as wastewater treatment plants, are often located outside the city limits. Urban contexts can therefore be defined as the area within which people reside who are vulnerable to disruptions in essential services and the network of components supporting those services.

Urban services are the provision of commodities, actions or other items of value to an urban population. Essential urban services are those that are vital to ensure the subsistence of the population, including electricity, health, water, wastewater collection and treatment, and solid waste disposal. All urban services require three elements in order to function: people (e.g. service providers, private-sector contractors and entrepreneurs), hardware (e.g. infrastructure, equipment, heavy machinery) and consumables (e.g. fuel, chlorine, medicines). Disruption to an essential service is understood to occur when the functions of any of the critical people, hardware or consumables are compromised. Short-term disruption to a service may not have a major impact on the survival of the civilian population, while its deterioration over the long term brings about the cumulative impact on services with the related risks to public health.

### Direct, Indirect and Cumulative Impact

Direct impact refers to the (usually) immediate and physical impact such as damage to essential urban infrastructure, the death of technicians and repair crews, looting of hospital stores or service providers’ warehouses and/or removal of parts directly from service infrastructure.

Indirect impacts are understood to derive from direct impacts, affecting an associated component of a system, usually in the short to medium term. An example is the “brain drain” that occurs after massive social disruption, or shortages of spare parts due to a lack of finances to buy them. These impacts can accumulate over time, resulting, for example, in a lack of maintenance due to insufficient long-term staffing and thus a lack of long-term service provision, poor or no infrastructure maintenance and/or machinery being run with poorly calibrated or poorly fitting parts.

Cumulative impact refers to the long-term deterioration of essential services through incremental direct and/or indirect impact(s) on one or more of the critical components of essential service delivery (i.e. people, hardware and consumables). Field experience suggests that the cumulative impact is the most destructive and the most

difficult to recover from. This is typically due to the large scale of the infrastructural rehabilitation work needed to restore any service or combination of services in urban areas. Cumulative impact is even more evident in situations of protracted conflict in urban areas.

More specifically, the concept of cumulative impact calls for a move from traditional assistance paradigms to one that takes into account the longer-term realities and needs in urban areas. It also explains how the quality of essential urban services can deteriorate to a point of no return through a “vicious cycle” of accumulated direct and indirect impacts, which pose serious risks to people’s health and well-being and lead to undue displacement.

### A Better Approach to Assisting Affected People

When considering urban sanitation services under protracted crisis the distinctions between the stages of relief-rehabilitation-development response are rarely ever clear. For example, the asymmetries in quality or coverage of services between neighbourhoods mean that multiple types of programs, such as pit emptying or rehabilitation of a large wastewater treatment plant, may be required simultaneously in the same city.

Given the intricacy of the interconnectivity of urban services inside and outside urban areas, as well as between the services themselves, attempts to impose clarity through responses driven by artificial boundaries (e.g. attempts to shift from emergency relief to “development”) may be counterproductive. Responses are context-dependent and the needs in urban areas can at times therefore necessitate a mixture of the stages classically referred to as “relief”, “rehabilitation” and “development” at any given time during a protracted crisis.

Additionally, the main shortcoming of funding models for humanitarian contexts has been well identified: short-term funding cycles that do not match the needs of the people or of authorities attempting rehabilitation. More context-adapted and sustained funding mechanisms are required to enable a shift away from reactive repair of damage to infrastructure (direct impact) to the proactive preventive maintenance and rehabilitation (indirect and cumulative impact) necessary to stabilise or even to restore essential urban services. It is especially the case for sanitation, which is often perceived as a low priority by different local and international stakeholders, in comparison with other essential services, such as water and electricity.

The complexity of urban contexts makes partnerships particularly important in restoring more resilient systems, yet also makes them trickier. The ability to engage with the numerous horizontal networks of informal governance overlaid onto vertical hierarchies is best acquired through

experience. As an example, engaging with those private companies that regularly guarantee technical support to public service providers might represent the turning point in providing assistance during a protracted crisis. As there is no preferred model for such partnerships, the most relevant vulnerabilities and opportunities in the context will ultimately shape relations with authorities, beneficiaries, the private sector, and other non-State actors.

All the above-mentioned core issues are best addressed by pursuing a path of acknowledgment of the sheer scale and duration of the challenge, the multifaceted interconnectivity of essential services, cumulative and indirect impacts as well as direct impacts, the need to rethink the relief-rehabilitation-development spectrum; and funding that does not match the duration or scale of the needs. The key to success in addressing such a challenge lies in achieving a consensus that reinforces the paradigm shift in the way assistance is delivered to affected people in urban settings.

→ **References and further reading material can be found on page 196**

## X.8 Solid Waste Management

Appropriate Solid Waste Management (SWM) is critical for public health. This is particularly true in emergencies and situations of humanitarian crisis as existing services, such as collection, treatment or disposal, may be disrupted. Additionally, extra waste caused by the crisis may have a public health impact. On one hand disasters and conflicts can result in large amounts of waste, in particular debris and remains from building and other

wreckage. On the other hand, displacement of people and new temporary settlements (camps) will require new arrangements. Unmanaged solid waste attracts insects and animals that can act as disease transmitting vectors, such as flies, rats, or other animals scavenging the garbage. Solid waste littered into drainage channels will cause blockages, flooding or stagnant ponds. This can propagate the breeding of mosquitoes that transmit malaria, dengue and yellow fever. Large piles of unmanaged solid waste are often set on fire and smoke can be a health hazard if the burning waste contains items such as plastics or chemicals. Exposure to unmanaged hazardous waste, such as excreta (from the lack of sanitation facilities), infectious medical waste, sharp items (needles, glass) or toxic chemicals may be a further direct threat to people's health. Soil and water, in contact with waste, become rapidly contaminated threatening soil quality, food safety, as well as surface and groundwater resource quality. Finally, yet importantly, indiscriminately dumped solid waste in a settlement area is unappealing and lowers the pride of communities.

### The Solid Waste Management "System"

Solid waste can be broadly defined as any unwanted solid product or material generated by people or industrial processes that has no value for the one who discards it. Other terms for solid waste are "garbage", "trash", "refuse" and "rubbish". With denser settlement patterns, solid waste challenges become more acute. Municipal solid waste refers to solid wastes deriving from settlements (houses, shops, offices, lying on streets and in public places) and is usually the responsibility of local government. Although other solid waste generated inside municipal areas, for

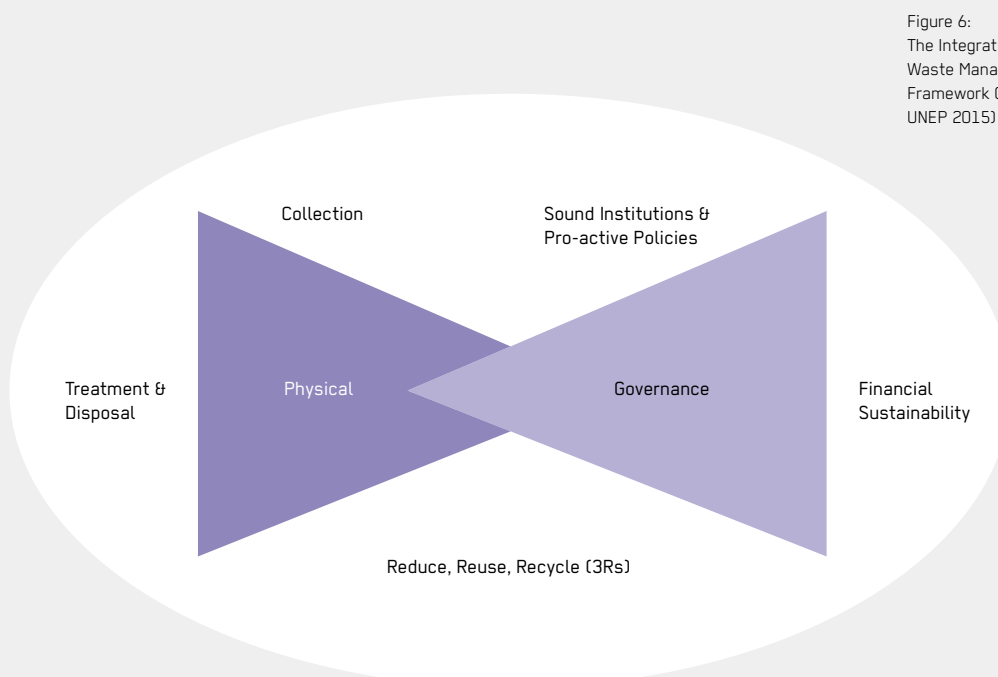

Figure 6:  
The Integrated Sustainable  
Waste Management (ISWM)  
Framework (adapted from  
UNEP 2015)

instance excreta from lacking sanitation facilities, or waste from industrial processes or construction are typically not identified as "municipal waste", they nevertheless need to be considered as they also end up in the municipal solid waste stream. Integrated sustainable waste management (see figure 6) incorporates considerations of all physical elements of the waste management system, starting from waste generation through storage, collection, transport, recycling, treatment and final disposal. It furthermore includes governance and strategic considerations including economic and financial sustainability, political/legal and institutional aspects, and the involvement of all stakeholders (various waste generators and service users, informal and formal waste service providers and waste users, international agencies, local, regional and national governments, civil society and non-governmental organisations, etc.).

### Planning and Implementing Solid Waste Management Services

For an appropriate and sustainable SWM service, the following tasks should be considered:

**Planning/implementation in coordination and inclusion of all relevant stakeholders:** SWM services must be planned and implemented in coordination with service users, relevant agencies and authorities, and potential or existing service providers. This should happen before a solid waste problem becomes a major health risk to the affected population.

**Consideration of links to other sanitation branches:** Solid waste can create a range of challenges in other branches of sanitation. Litter can clog stormwater channels, creating standing water and overflows leading to flooding of streets and houses. Solid waste thrown into pit latrines can make it very difficult to empty these latrines and to further treat, process and reuse/dispose of the faecal sludge collected in the pits. These links should be considered, especially for awareness raising campaigns.

**Assessment and understanding of waste generation and current waste practices:** The basis of all planning and implementation is to measure how much (kg) and know what type (organic, plastic etc.) of waste is generated. Besides household waste, waste streams with high-risk potential (e.g. healthcare waste) must be carefully evaluated.

**Consideration of menstrual hygiene products:** Menstrual hygiene products which are not disposed of correctly can create challenges, e.g. by clogging toilets or due to their infectious nature. Menstrual hygiene product waste is usually produced within toilet cubicles. Therefore, solid

waste bins with a lid and lining should be provided and operated and managed within all public toilets and people should be educated on the correct and safe disposal of menstrual hygiene products.

**Fostering an environment that avoids and reduces waste:** Not using materials that are not essential, are hazardous or difficult to handle (e.g. disposable plastic water sachets, multicomponent materials, solvents or aerosol cans) is one way to structurally avoid waste. Furthermore, measures at the service-user level can incentivise behaviour change to lessen waste generation.

**Enhancing recovery, recycling and ensuring treatment:** Waste should be seen as a resource. Enhancing recycling on-site (at household level) or off-site (neighbourhood or central level) not only reduces need (and costs) for residual waste management, but can also provide employment opportunities to the local population and reduce dependency on external resources. To boost recycling, implementing waste segregation (as early as possible) is a key activity. This augments the value of different waste fractions and eases further processing. Typical examples are the processing of organic waste by composting for fertiliser, or anaerobic digestion for energy, recycling of waste paper for briquettes and fuel, or recycling of other waste streams (rubber, plastic, metal) to produce secondary low-cost products. Nevertheless, the technologies and approaches selected and implemented should consider market demand for waste derived end products, and not aggravate health risk and environmental pollution. Mixed waste incineration is usually not a favourable option as such waste typically has a high moisture content and the technology requires high capital expenditure, highly skilled and costly operation and management, and results in severe respiratory health hazards and environmental contamination.

**Provision of a collection and transport system:** Removing waste from residential areas avoids its accumulation in the neighbourhood. Regular collection avoids contact and exposure of residents to waste and eliminates attraction and proliferation of disease transmitting animal vectors. It also decreases the risk of waste burning, a measure often used to eliminate waste, which results in severe respiratory health hazards. The potential for small-scale business development should be considered. Often an informal sector is active and can be professionalised.

**Ensuring safe disposal:** It comprises selection of a location that avoids contamination of surface and groundwater with waste leachate. Disposal sites should be fenced off to prevent access by people and animals. Furthermore, drainage around the site should avoid water flowing into

the waste. The waste tipping face at the site should be covered daily or at least weekly with a thin layer of earth to prevent attracting vectors such as flies and rodents.

**Planning of clean-up campaigns:** In consultation with the population and responsible local authorities it will be necessary to organise periodic cleaning of public spaces to ensure a hygienic environment but also remind and reactivate the necessity of public participation in neighbourhood cleanliness as a civil duty and citizen responsibility.

**Ensuring safe waste management from healthcare facilities:**

Healthcare waste may expose the population, healthcare workers and waste handlers to the risk of infections, toxic effects and injuries. In a disaster situation, the most hazardous types of waste are likely to be chemicals or infectious wastes (wound dressings, blood-stained cloths, syringes and other sharps, etc.). Such waste should be separated at source from non-infectious waste (paper, plastic wrappings, food waste, etc.) for special treatment (incineration or controlled containment).

**Safeguarding staff welfare:** All staff involved in waste management must be provided with protective clothing and equipment to safeguard against exposure to the hazards in waste. When necessary, immunisation against tetanus and hepatitis B should be provided.

**Development of an appropriate operation and maintenance structure:** A plan for sustainable operation of waste management services must consider social acceptance, financial sustainability, workers' skills and capacities as well as a suitable legal and institutional setup. Some key questions that need to be resolved are: What participation is required from the service users and how can this be ensured? Who provides what kind of service? How is the service monitored and evaluated? How are the costs of this service covered in long term?

**Rapid Emergency Response**

Immediately after an emergency/disaster, hygiene and waste disposal are usually poor, so vermin and other pests, including rodents, can spread and breed rapidly. The Sphere minimum standard for SWM states that the environment should be free from littering by solid waste, including medical waste and that there should be means of safely disposing domestic waste. All households should have access to refuse containers and these should be within 100 m from communal refuse pits and be emptied twice a week. Refuse containers should be a minimum of 100 L in size for every 10 households. Medical waste has to be isolated and disposed of separately and safely. Another high priority is debris clearance and re-

spective waste clean-up. This is necessary to provide access to emergency response services, rescue survivors, retrieve dead bodies and address urgent public health and environmental issues. Management of disaster waste will depend on the types of waste and debris generated. During the rapid response phase, any hazardous waste and human or animal remains should be separated from other waste streams wherever possible. Temporary, and if possible, final disposal sites need to be rapidly identified and prepared. Restoring services must consider long-term feasibility.

**From Emergency Towards Development**

Routines should be rapidly developed and implemented for waste storage, collection and disposal. This is particularly important in high-density sites such as refugee camps. In urban and out-of-camp settings, national systems should be used and strengthened. Such plans should also integrate a long-term development vision that enhances recycling and recovery options, technical skills and capacity, financial self-sufficiency and various other elements of a sustainable SWM system. A camp can be treated like an urban area, however here SWM is a joint responsibility of camp coordination and camp management that ensures coordination and collaboration with the WASH and health sectors.

→ **References and further reading material can be found on page 196**

**X.9 Cholera Prevention and Epidemic Management**

Cholera is a faecal-oral disease that causes infection of the small intestine leading to severe watery diarrhoea, rapid dehydration, and death if left untreated. There are many ways to prevent and control the spread of cholera, which requires actions both inside the health sector and beyond, including access to safe water, sanitation and good hygiene practices (WASH). Cholera occurs in both humanitarian emergency settings and in endemic settings where cholera outbreaks occur regularly among the same populations, usually coinciding with the rainy season. However, in most cases, cholera outbreaks happen to impact nations/regions already dealing with a pre-existing fragile context, including poor hygienic conditions, limited access to drinking water and to sanitation facilities. Although the focus here will be mainly on cholera in emergencies it is important to recognise that where possible, efforts to control cholera should seek to build long-term systems and consider the longer-term prevention beyond reactive approaches (X.5).

The following key messages contain important background information for all those dealing with cholera:

- Cholera is caused by the bacterium *Vibrio cholera* entering the body in the faecal-oral pathway through the consumption of water and/or food that has been contaminated through poor water and sanitation systems, and inappropriate hygienic practices, such as the absence of handwashing with soap after defecation.
- Most infected people do not develop any symptoms. They are called “healthy carriers” and can spread cholera easily if water sources become contaminated with faeces containing the bacterium, when hygiene conditions are poor and open defecation is prevalent.
- Cholera must be treated in special units called Cholera Treatment Centres (CTC) in order to prevent the spread of the disease in the community.
- Every single case of cholera should be investigated in order to assess and break the path of transmission.
- Faeces and vomit produced by cholera patients are highly infectious and should be appropriately and safely handled and disposed of (e.g. disinfection with chlorine solution or lime).
- While cholera can spread quickly through the environment, there are several known and effective ways to halt transmission. Practices that isolate faeces from food and water such as treating and storing water safely and using improved sanitation facilities are essential to control a cholera outbreak.

### WASH interventions

Provision of WASH services are key elements of both the prevention of and response to cholera outbreaks. In cholera endemic and risk prone areas, significant efforts need to be made to ensure safe and adequate water supply and disinfection, water quality monitoring, hygiene promotion, sanitation and safe excreta disposal at household and community levels and in CTCs and healthcare facilities. In terms of sanitation, the focus should be on the following:

#### **Improving access to and use of safe excreta disposal:**

Faecal matter needs to be kept away from water and food (containment) and cholera bacteria that could potentially contaminate food and water need to be killed prior to consumption (disinfection). Suspected or confirmed cholera cases have to be provided with separate toilets or latrines that are not used by other individuals. A sufficient number of functioning, accessible, appropriate and safe toilets for staff, patients, and caregivers (**see box on the following page**) need to be ensured (including regular cleaning and maintenance at least daily) that do not contaminate the health-care setting or water supplies.

**Environment free from human excreta:** It should be ensured that latrines with functional handwashing facilities are used and kept clean; that people, including children, do not defecate in the open and that all faeces are disposed of safely in a latrine or buried (**X.11**). Excreta disposal facilities need to be provided in markets, public places and institutions with functioning and well-managed Handwashing Facilities (**U.7**). They should be culturally appropriate and a sustainable cleaning and management system should be established for public and communal facilities.

**Handwashing:** Handwashing Facilities (**U.7**) must be available and accessible; and proper handwashing practices must be promoted, particularly at key times (after latrine use, after cleaning a child’s bottom, before cooking and feeding, after caring for a cholera patient).

**Personal protective equipment:** Personal protective equipment (e.g. boots, masks, gloves, clothing etc.) must be provided for those involved in operation and maintenance along the sanitation service chain.

**Food hygiene:** Hygiene promotion activities need to include the promotion of food hygiene (proper preparation, reheating and storage of food, cleaning of cooking utensils).

**Chlorine solution disinfection:** Different chlorine solutions (with different percentages of free residual chlorine) must be available for different purposes: (1) 0.05% for handwashing with soap, skin disinfection, laundry (patient and administrative), latrines, kitchen, mortuary and waste area (or alternatively alcohol-based hand rub), (2) 0.2% for disinfecting floors, objects, beds, clothes, kitchen utilities of patients, and (3) 2% to add to excreta/vomit for disinfection and to wash dead bodies (or alternatively lime treatment).

WASH related cholera relief interventions can be broadly distinguished between households, institutions, and health care facilities (**see following page**).

**Households:**

Risk of contamination is particularly high in household settings, and household members of cholera patients are 100 times more at risk of contracting disease than other community members.

- Excreta (which may contain cholera) needs to be properly disposed of and separated from the human living environment and water sources.
- An excreta management system needs to be set up, even in the early stages of an emergency.
- Sanitation solutions that do not contaminate groundwater need to be identified.
- Promotion of handwashing with soap, especially before eating, cooking, after cleaning a baby, child or adult's bottom, after using the latrine, and when caring for a sick person.
- Promotion of food hygiene (proper preparation, reheating and storage of food, cleaning of cooking utensils).
- Promotion of water treatment and storage (water containers need to be covered and regularly cleaned, and water should be removed using a tap or cup with a handle so that hands do not come in contact with water).
- Latrines need to be regularly cleaned and maintained, and privacy and safety ensured to encourage use.
- If someone dies of cholera (or a condition suspected to be cholera), the body should be touched as little as possible followed by handwashing with soap. Trained personnel should be asked to assist with safe and proper burial. Special funeral guidelines have to be adopted according to and respecting local traditions.

**Institutions:**

- Public places should be equipped with gender-segregated sanitation facilities.
- All sanitation facilities should have functioning handwashing and bathing facilities if needed.
- Handwashing stations with soap **(U.7)** should be available in all public places, especially near toilets or food establishments.
- Signs/posters can help encourage people to wash hands with soap after toilet use and before cooking/eating.
- Food safety should be addressed in institutions/public places (e.g. schools, government buildings, and markets).

**Healthcare Facilities:**

- In CTCs, typically established when an outbreak is suspected or confirmed, many patients are too weak to use a toilet. Buckets (10–15 L) are placed under a purpose-built hole in the cholera bed and at the bedside. Buckets can be raised on a block to prevent splashing of the surrounding area. Approximately 1 cm of 2% chlorine solution should be put into the bucket before it is placed under the bed. Buckets should be emptied in nearby toilets used by cholera patients. After collection and disposal of excreta, buckets should be rinsed with 0.5% chlorine solution, disposing of rinse water in drains or a toilet.
- Recommended number of latrines is 1 for every 20 persons in observation, 1 for every 50 patients in hospitalisation plus 1–2 for staff.
- Suspected and confirmed cholera patients should be isolated from other patients.
- Separate facilities should be available for cholera patients to prevent spread of infection.
- All liquid human waste is disposed of in a latrine, or is buried.
- Easy to clean plastic slabs are recommended.
- Safe containment of excreta and faecal sludge should be ensured on-site; the toilets should not be connected to a sewer network to avoid spreading the disease.
- Safe water should be available in sufficient quantities for patients, healthcare providers, for cleaning and disinfection within the facility.
- For cholera outbreaks, appropriate personal protective equipment needs to be provided and used.
- Dead bodies should be prepared and buried in a way that avoids disease transmission.

→ **References and further reading material can be found on page 197**

# Design and Social Considerations

## X.10 Inclusive and Equitable Design

Access to adequate sanitation is a human right and applies to everyone. Sanitation services and facilities and particularly on-site facilities and user interfaces are far too often designed in a standard way, without taking into account the diversity of needs of different user groups. Particularly in the rapid response phase where time and money are limiting factors simple, uniform and easy to implement designs are a preferred option. However, there is a wide range of different abilities and needs in any affected community. Consequently, if this range of abilities and needs is not properly addressed during the assessment, planning and design stage, people will be excluded from otherwise well-intentioned sanitation facilities and services.

An inclusive and equitable (or universal) design approach considers people's diversity as a normal part of every society where the needs and rights of different groups and individuals are of equal value and properly balanced. Inclusive design aims to identify and remove potential barriers and create facilities and environments that can be used by everyone, irrespective of age, gender, disease or disability. It helps improve one's sense of dignity and self-reliance, health and well-being, it supports caregivers and counteracts misunderstanding and ignorance. Often only minor adaptations or design improvements are needed to make sanitation facilities more inclusive. If considered in the design stage, additional costs of 3–7% support barrier-free systems.

In order to be inclusive all potential user groups need to be adequately considered in the design of sanitation facilities. This includes people with long-term physical, mental, intellectual or sensory impairments, people with reduced mobility, people of different ages, sick or injured people, children, pregnant women, women and girls with specific requirements regarding safety and safe menstrual hygiene management among others. People may belong to different user groups at the same time (intersectionality) and some of the potential user groups may be hidden or less visible. Hence it is crucial to identify user groups and their potential barriers already during the initial assessment phase (X.1). It is essential that facilities are built from the perspective of the persons concerned and they should be consulted and

actively involved in the later program design and implementation process. Depending on anticipated users the interventions, adaptations and design improvements may include:

### Assessment and monitoring:

- Collecting data from each user group and ensuring that data are disaggregated by gender, age and, if applicable, type of impairment.
- Conducting focus groups and other direct consultations involving all relevant user groups in gender-separated groups with trained facilitators of the same gender as the group members.
- Consulting different user groups about their needs, in order to inform the location, accessibility, design and use of all sanitation services and facilities.
- Involving organisations of persons with disabilities and older people's organisations in sanitation responses and seeking advice from specialist organisations on how to ensure that sanitation facilities are accessible.
- Ensuring that all relevant user groups are represented in community WASH committees and WASH program evaluation.
- Training staff, outreach workers and partners in inclusive design, disability- and age-awareness and recognition of specific needs of different user groups.
- Monitoring the sanitation response to ensure inclusion of all user groups.

### Planning availability of accessible sanitation and washing facilities:

- Consideration of a minimum of 15% of all public latrines to be inclusive with other latrines built as barrier-free and as accessible as possible.
- Consideration of individual inclusive latrine units or inclusive units in blocks of latrines.
- Ensuring that all accessible facilities are labelled with large access symbols.

### Reaching the facility:

- Minimising distance of public or shared facilities to homes and shelter and locating accessible sanitation facilities and shelters so that people with physical limitations, reduced mobility or security concerns can be accommodated close to accessible latrines and other WASH facilities.
- Improving access to public facilities through wider paths, a handrailed slope or steps, string-guided paths or ground surface indicators and additional landmarks for people with visual impairments.



- Providing ramps with a low slope (no steeper than 1 unit height per 12 units length) with a minimum width of around 1.5 m and handrails at either side (preferably on both) and side kerbs.
- Providing brightly coloured visual signs that show accessible public or shared facilities.
- Providing mobile or household devices like bedpans, potties, buckets, bags or diapers for people with reduced mobility, people with incontinence or people who are bedbound.
- Ensuring that all hazardous areas are marked and fenced.

**Entering and circulating inside the facility:**

- The recommended base area of a transitional or mobile latrine during the initial phase of emergency response is at least 120 × 120 cm and ideally 180 × 180 cm.
- For wheelchair users, the entrance area should be large enough to manoeuvre and should allow enough space to open the door. There should be minimal/no difference in floor level between outside and inside.
- The door should be at least 90 cm wide and open outwards with a large lever handle (no round handle) and a rope or rail at the inside to pull door closed and secure door fastening.
- Locks should be easy to handle for persons with grip difficulties, for example a sliding or revolving metal or wooden bolt could be used.
- Space inside the latrine should be sufficient for wheelchair-manoevre with a turning cycle of around

- 1.5 m (depending on wheelchair-models, check sizes and shapes of wheelchairs in emergency areas) and 1 m space to latrine for transfer. Additionally, there needs to be space for a caregiver to stand.
- Surfaces need to be slip-resistant.

**Using the facility:**

- Providing handrail or rope for support when sitting/squatting and standing up. Handrails should be installed at a height of around 80 cm above the floor and be strong enough to support body weight.
- Providing accessible handwashing devices (reachable height, easy-to-use taps, for people with limited grip/strength) and locating accessible handwashing facilities close to accessible latrines.
- Providing fixed or movable seats and sitting aids (commode chair, chair/stool with hole, cleanable seat, fixed or removable, different dimensions for children/adults).
- The toilet seat or type of latrine can be shaped differently according to customs and habits and should be decided on in consultation with the concerned population, including people with disabilities.

**Information dissemination:**

- Ensuring that all relevant WASH information and hygiene promotion messages are disseminated using appropriate and various communication means (e.g. using large print, loudspeakers, simple language, illustrations).

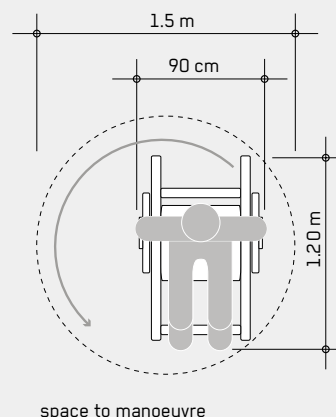
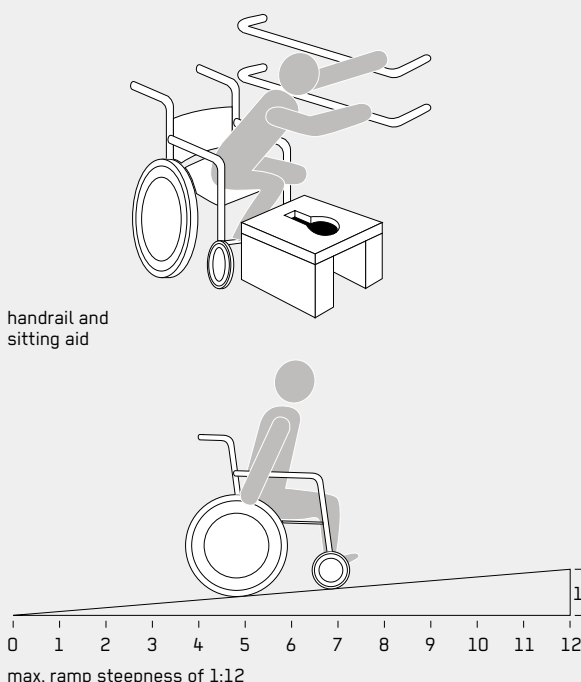

Figure 7: Accessible Design Examples (adapted from Jones & Reed 2005)

## Gender-Friendly Design

Adaptations and design improvements to make sanitation facilities more gender and menstrual hygiene management-friendly include:

- Public or shared facilities that are accessible, well-maintained and gender-segregated
- Provision of privacy and security (latrines with solid walls, lockable doors, roof coverage in terraced areas, lighting at night, screened-unit blocks)
- Access to sustainable supply of locally acceptable menstrual hygiene materials including information on correct use (appropriate, affordable, produced by local supplier if possible). If they are not reusable, correct disposal options must be provided and communicated.
- Provision of disposal bins for discrete disposal of menstrual hygiene materials
- Provision of washing facilities with water and soap inside the cabin and/or possibilities for discreet washing and drying of reusable menstrual hygiene products with discreet drainage so that water with menstrual blood cannot be seen

## Culturally Appropriate Design

When designing and implementing sanitation infrastructure, special consideration needs to be given to culturally appropriate design of the facilities. This is particularly the case if people from different cultural, ethnic and/or religious groups are living together. People have the choice to use a toilet facility or not and may not use it if it is considered inappropriate, is not convenient or does not correspond to the user's customs and habits. Culturally appropriate design therefore considers aspects such as an appropriate user interface (for sitters or squatters), the type of anal cleansing material that users find acceptable (e.g. toilet paper, water, sticks or stones), gender aspects and privacy (e.g. gender-segregated facilities for women and men), that different cultural groups may not be willing to use the same latrines or existing taboos related to toilet use, handling of waste or potential reuse options. Cultural beliefs and norms may also affect the siting (people may not want to be seen when going to a toilet) and the orientation of facilities (e.g. religious rules that the toilet should face away from the prayer point) and may limit technology options (e.g. reuse-oriented technologies may not be considered in contexts where handling and reuse of excreta is culturally not acceptable or the implementation of urinals in Muslim societies may not be an option). Cultural issues can be manifold and need to be addressed during the assessment stage (X.1) in order to understand and respond adequately to people's needs, habits and practices.

Figure 8:  
Gender-Friendly Design  
(adapted from Columbia  
University & IRC 2017)

→ **References and further reading material can be found on page 197**

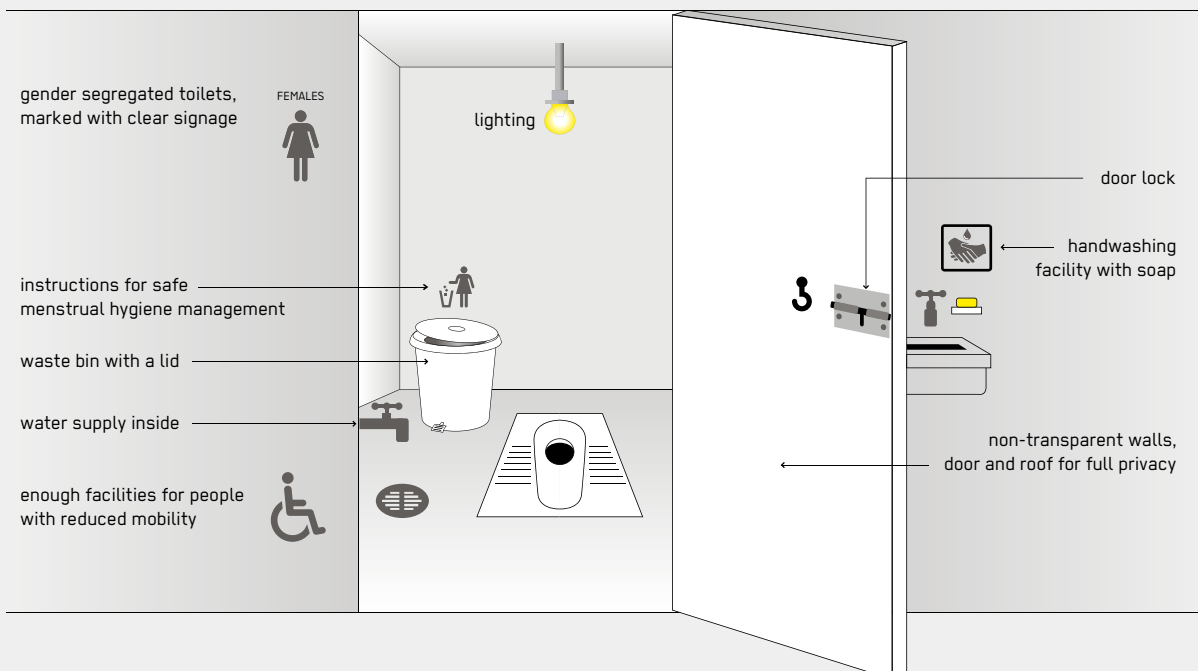

## X.11 Child Excreta Management

When providing sanitation hardware solutions in emergencies, special attention should be given to the safe management of children's faeces. Children's faeces are generally more dangerous than adult faeces as excreta-related infections are usually more prevalent in children, with a higher prevalence of diarrhoea and soil-transmitted helminth infections. The immune system of a child takes several years to develop and children may not have developed the necessary antibodies. In addition, toddlers and small children are often unable to fully control their defecation and children may defecate in areas where other children could be exposed (e.g. on the ground where children play, children may put contaminated fingers/objects into their mouths). Hence children are more susceptible to faecal-oral transmitted diseases. These can result in increased malnutrition, stunting and reduced cognitive abilities. Unfortunately, children's faeces are often considered less harmful and therefore are often not properly collected or disposed of safely. Additionally, children may often not use a toilet because of their age, stage of physical development, or safety concerns of their parents. They might be afraid to use toilets for fear of falling in, bad smells, or a fear of dark spaces. Hence, addressing child excreta management includes the context-specific consideration of the following components:

**Infrastructure:** Sanitation hardware interventions should consider the specific needs of children. These include that public or shared toilet facilities are close to households, have proper lighting and are equipped with child-friendly user-interfaces such as smaller bowls or squat holes. The superstructure has to be large enough to be occupied by a parent or caregiver and child together. A children's toilet can be further enhanced with child-friendly colourful artwork and picture-based hygiene messages.

**Non-Food Items:** For toddlers and small children the provision of age-appropriate faecal containment products such as nappies, diapers and potties needs to be considered. If disposable nappies or diapers are being used, there needs to be an adequate collection and management system (incl. hygiene promotion) in place with subsequent burial or treatment options. Washable nappies may be an alternative. If potties are being used the child faeces can be discarded or rinsed into the toilet and the potty cleaned with soap or disinfectant afterwards.

**Hygiene Promotion:** Hygiene promotion (X.12) measures for children's faeces include the provision of information and training to parents and caregivers about safe disposal options, children's toilet training, laundering

practices, and actively advocating to prevent indiscriminate defecation and household contamination with child faeces. Hygiene promotion includes hygiene messages on the importance of handwashing with soap after contact with child excreta and washing the child after defecation. It may also include encouraging clean-up of already contaminated environments with shovels or other tools to avoid direct contact with children excreta.

→ **References and further reading material can be found on page 197**

## X.12 Hygiene Promotion and Working with Affected Communities

Hygiene Promotion (HP) is a planned, systematic approach to enable people to take action to prevent or reduce the impact of WASH related diseases. It is about making sanitation services work or work more effectively and must be supported by all involved in the response including government, local or international agencies and NGOs. No sanitation intervention should be undertaken without including hygiene promotion. HP should recognise the differences within any population and aim to respond in various ways to the different WASH needs of women and men and girls and boys of different ages from different backgrounds, with different cultural and social norms, beliefs, religions, needs, abilities, gender identities, levels of self-confidence and self-efficacy etc.

### Key Components of Hygiene Promotion in Emergencies:

- Community and individual action
- Use and maintenance of facilities
- Access to and use of hygiene items
- Coordination and collaboration with other WASH stakeholders
- Assessment, monitoring and evaluation
- Accountability and participation of affected populations
- Identification of behavioural drivers and focused selection of behaviour change techniques

In an emergency, community structures and cohesion may have become disrupted and people will often be traumatised and grieving for the loss of loved ones. Hygiene promoters working with community members must be sensitive to this and at first may need to simply listen to people's experiences in order to develop their trust. However, there will always be some members of the affected community who are keen to engage immediately and who can support the process of re-establishing access to

sanitation and hygiene. A sanitation intervention can help to restore people's dignity not only by ensuring access to facilities and services but also by supporting community and group organisation, engagement and decision making. Different degrees of participation (information, consultation, collaboration, or delegation of power) may be possible at different times in the emergency but there will always be space for some level of consultation.

HP uses a variety of strategies and tools to address WASH related disease risks. These can involve: advocacy, community mobilisation, interactive education and learning, behaviour change communication, participatory research, market-based approaches and people centred design.

### Hygiene Promotion Principles in Relation to Improving Sanitation

A vital strategy in promoting sanitation and hygiene or increasing demand for services where there is none, is to try to understand the affected community's different perspectives on sanitation and hygiene and to involve them in decisions about the programme.

**1. Listen and ask:** It is vital to learn about sanitation practices and norms. For example: What do different people usually do? What is happening now and what has changed as a result of the emergency? What do different people need and want to ensure that sanitation facilities are effective and have an impact on health? What are the priority sanitation risks? Who are most vulnerable and what support do they need to access sanitation services and facilities? Who can help e.g. affected population (who also have skills and capacities), local agencies or government departments? It is important not to treat everyone the same but to identify different groups to work with e.g. youth, mothers and fathers of young children, religious leaders, primary school children, canteen workers, hairdressers etc. See also cross-cutting chapters on inclusive and equitable design (X.10) and assessment of the initial situation (X.1).

**2. Involve and enable action:** Interactive discussions can be used to support different user groups to identify what they can do immediately to improve sanitation and hygiene. It is important to find out what is potentially stopping them from acting (the barriers and obstacles to improved sanitation and hygiene) and to find out what help they need, if any. By conducting surveys and differentiating between doers and non-doers, users and non-users of facilities drivers can be identified that motivate action. Supporting community organisation is also useful and can help to ensure that people motivate each other. A variety of interventions can help to respond to the immediate risks but will depend on the context e.g. interim

sanitation solutions, tools for digging pits, soap or alternatives for handwashing, potties or nappies for children etc. Consider how sanitation and hygiene facilities will be maintained from the beginning and the community's involvement in this e.g. through the formation of committees or user groups.

**3. Focus on vulnerability:** It is vital to identify people with specific needs (e.g. women and girls, older people, and people with disabilities) and find out what they feel and need to manage their sanitation and hygiene needs (e.g. menstrual hygiene management). Ensuring that you have women on the team will mean they can talk more easily with other women. Finding out how babies and young children's excreta is managed and asking mothers and caregivers what support they want to do this effectively, is also crucial. Work with local organisations representing vulnerable groups such as disabled people's organisations. See also cross-cutting chapters on inclusive and equitable design (X.10), child excreta management (X.11) and assessment of the initial situation (X.1).

**4. Plan together:** Setting practical objectives and indicators and compiling a WASH strategy with others involved in the WASH response are also key processes in an HP intervention. In this process the 'doable' actions that can have an impact on sanitation and hygiene should be identified and how effectiveness will be monitored should be decided. The affected community should contribute to this strategy. The recruitment, training and support of existing and new team members will help to ensure that plans come to fruition.

**5. Collaborate and coordinate to implement:** A variety of methods and tools can be used to work with different groups to motivate action to improve and effectively use and maintain sanitation facilities and services for women and men, people in different age groups and with different abilities. Working closely with others involved in the response – especially the Government, local authorities and other sectors is also important. Coordination involving the sharing of plans and ideas can minimise duplication and increase the efficient use of resources. It should be possible to undertake joint activities such as assessments or evaluations or HP outreach workers may focus on other priority health issues as well as hygiene.

**6. Monitor and review:** By means of observation (Do people use the facilities?) and surveys (Did people change their behaviour?) the effectiveness of HP and behaviour change efforts can be monitored. Continually seeking feedback from the population will enable adaptations in programming and improve effectiveness. It is also important to keep track of any rumours that might be detrimental and

to respond to these as soon as possible e.g. by incorporating them into discussions with community groups or providing information on social media.

### Hygiene Promotion Methods

**Interactive Methods:** Methods that encourage dialogue and group discussion such as ‘community mapping’ and ‘three pile sorting’ using pictures and visual representations, require the active participation of community members and are usually more effective than just ‘disseminating messages’ as the latter erroneously assumes that people will passively internalise and act upon the information provided.

**Access to hygiene and sanitation items:** It is important to consider the different needs of men, women, boys and girls. For example, women and adolescent girls will often need support with managing menstruation and consultation on this should be included in any sanitation programme.

### WASH Behavioural Insights

In recent years, there has been a significant amount of work undertaken on trying to understand different influences on sanitation and hygiene behaviour. It is clear that knowledge about germs and the transmission of disease is often insufficient and inadequate to change behaviour. The following suggestions can help to make programmes more effective:

**1. Make the practice easy and attractive:** It should be ensured that products and supplies (e.g. a handwashing station with soap and water) are easily accessible in each location where the desired behaviour is expected to take place. Emphasising convenience and ease of the desired behaviour (small immediate doable actions) is often more effective at promoting behaviour change than focussing on the ‘ideal’ behaviour. Rewards and incentives such as competitions should be considered and it is useful to find ways to attract attention such as painting colourful latrine doors or handwashing facilities with mirrors.

**2. Consider when people are likely to be most receptive:** Disruption in context (such as that associated with most emergencies) or significant life changes such as giving birth may provide a window of opportunity for shifts in habit because people become more mindful of what they are doing. Linking the desired behaviour to an existing habit is also more likely to succeed. For example, encourage handwashing at the same time as behaviours associated with infant care such as feeding or nappy changing.

**3. Draw on social norms and motivations:** Psychosocial approaches to behaviour change have shown that many drivers are relevant for behaviour change and that behaviour change techniques according to these drivers should be applied. To change health risk perceptions personal information on these risks should be delivered. To change attitudes, beliefs about costs and benefits of a behaviour should be discussed. Appealing to people’s senses of disgust, nurturing behaviours and affiliation with a group can change emotional components of attitudes and motivate action. To change perceived norms, it is useful to convey the idea that most people perform the desired behaviour. Identify what people perceive others will think of them if they engage in the practice and try to change this perception if required. People can be encouraged to make public commitments to use toilets, wash hands or support others in building latrines with a focus on groups and communities not just on individuals. To change perceived abilities to perform a behaviour one might demonstrate the behaviour and prompt behavioural practice. To foster behaviour realisation (self-regulation) action and barrier planning is vital but also memory aids to facilitate remembering the behaviour in key situations (e.g. handwashing before touching food) are useful. Community approaches (such as Community-Led Total Sanitation and Community Health Clubs) to the promotion of sanitation and hygiene have been found to be effective and other strategies such as behaviour centred design and in-depth assessment of motivation are worth exploring.

**4. Encourage the habit:** The promotion of the habitual behaviour through use of cues such as footsteps leading to the latrine and then to the handwashing facility can be considered (nudges). In addition, behavioural trials may be useful by e.g. asking people to use soap or a handwashing facility for two weeks and interview them about their experiences. Games with children can also help to internalise the link between handwashing and germs.

### Common Pitfalls

Several reports, reviews and guidelines have observed a variety of pitfalls in hygiene promotion:

- Too much focus on disseminating one-way messages without listening, discussion and dialogue so that people can clarify issues and work out how to adapt changes to their specific situation.
- Too much focus on designing promotional materials such as posters and leaflets before understanding the problem properly.
- Too much focus on personal hygiene and not enough on the use, operation and maintenance of facilities.

- Too little focus on practical actions that people can adopt and how to communicate these.
- Too many behaviours and too many audiences targeted at once.
- The belief that people will always be motivated by the promise of better health in the future and failure to explore other motivations such as nurture and disgust.

→ **References and further reading material can be found on page 197**

## X.13 Market-Based Programming

Market-Based Programming (MBP) refers to a range of programme modalities that are based on understanding and supporting local sanitation market systems. It is often distinguished from in-kind delivery of goods or services like slabs, soap or buckets and direct building of sanitation infrastructure although the boundaries between the modalities are fluid. The choice of the appropriate sets of modalities depend on the humanitarian context, including type and phase of an emergency, potential public health risks, WASH needs and vulnerabilities, the application level and target group (individual, household, communal and institutional levels), the knowledge, attitude and practice of the affected population as well as the intended outcomes of a programme. Appropriate levels of market assessment and analysis, along with a needs assessment and response analysis, should form the foundations of all sanitation programmes to ensure that they are responsive to realities on the ground, rather than being predetermined by standard approaches and assumptions.

### Market Assessments and Analysis

Market assessments include analysis of local markets (e.g. supply capacity and elasticity, access, quality of goods/services available), the enabling environment (e.g. access to markets and financial services, infrastructure, policy, regulatory frameworks, currency stability) and household factors (e.g. financial literacy, willingness to pay, household buying power dynamics, levels of debt, spending priorities). Market assessments can be in-depth analysis such as that detailed in the Emergency Market Mapping Analysis (EMMA) toolkit, or as simple as a few questions added to existing assessments, depending on context, time and resources available. Market tools such as Pre-Crisis Market Analysis (PCMA) can be used to understand critical markets, when they are functioning normally and to identify their capacity to adapt to future shock events, especially in cyclical or protracted crises. This understanding can be used to improve future responses or design preparedness programmes that

strengthen markets and build resilience in anticipation of a crisis and to increase the speed of emergency response. Implementing market-based approaches is nothing new to the WASH sector. Programmes have, for example, often included cash for work as part of latrine reconstruction programmes, vouchers for desludging or hygiene kits, sanitation fairs to present latrine options and products, capacity building of artisans and traders, technical support to faecal sludge management service providers, and support for financial systems and processes (e.g. micro-finance loans for latrine construction). Many of these approaches have worked well and at scale, also in settings where technical and quality standards must be met.

### 1. Demand Side (Market Access)

The demand side can be strengthened by using markets through Cash Transfer Programming (CTP), supporting markets to create market access and market system change through social sanitation marketing including behaviour change communication.

**Using markets through CTP:** To generate demand for sanitation products and services cash grants can be provided. The use of the grant can be influenced or controlled by the design of the cash transfer: grants can be provided to individuals, households or communities; at a regular interval over a period of time, in tranches or paid in lump sum. They can be conditional, if beneficiaries are required to fulfil conditions on either accessing the grant (cash for work) or utilising the grant (to build a latrine) or unconditional, if the grant is given to ensure beneficiaries are able to meet a range of basic needs. This specific example is widely referred to as multi-purpose cash-transfers, usually based on a minimum expenditure basket, which defines what a household needs – on a regular or seasonal basis and its average cost over time. Grants given in the form of vouchers can be restricted to specific commodities or services (e.g. hygiene items) or unrestricted value vouchers (up to a defined value for cash or commodities) redeemable with selected suppliers. CTP focuses exclusively on overcoming financial barriers faced by beneficiaries, without addressing other barriers to access.

**Supporting markets to create market access:** Market actors or other entities in the market system might need temporary support so that users can adequately access goods, services or incomes needed to meet needs in a crisis. A sanitation fair can promote innovation and create demand for goods and services. Vendors or service providers may need to be (pre-) qualified to meet the selection criteria (e.g. enabling vendors to receive digital payments) or standards (e.g. quality and format of accounting) of the CTP programme.

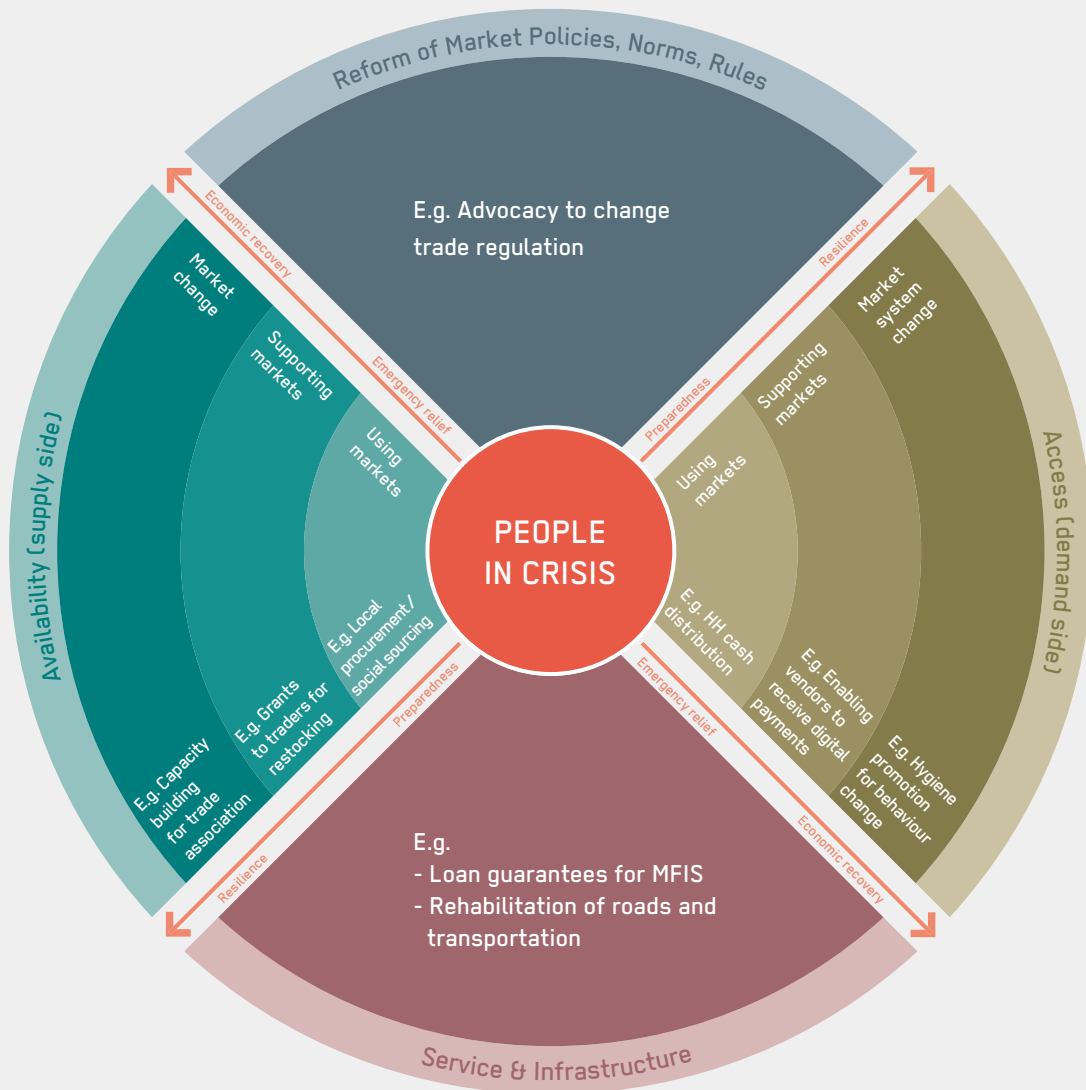

Figure 9:  
Markets in Crisis  
(adapted from CRS 2017)

**Market system change through sanitation marketing including behaviour change communication** is an emerging field in humanitarian WASH assistance. Sanitation marketing aims to develop products/services that address user needs and experiences and adopt marketing tools and promotional campaigns to influence users to take up and use latrines. How behaviour is modified or adopted depends on the application of what is known as the marketing mix, including product, place, price, and promotion (4 Ps). Even though the final influence on each of the 4 Ps might be limited, a sanitation marketing intervention tries to steer the target population towards the intended outcomes. Sanitation marketing strategies also include behaviour change communication, which motivate adoption of a particular behaviour (e.g. use of latrines) or complementary behaviour (e.g. handwashing with soap) by individuals or households. When working with target groups who are not used to using toilets, the application of the Participatory Hygiene and Sanitation

Transformation (PHAST) approach or the Community-Led Total Sanitation (CLTS) approach, both of which focus on changing community practices and in particular open defecation, can be considered as a response option.

## 2. Supply Side (Market Availability)

Using markets, supporting markets and developing markets can strengthen availability and capacity of the market system to deliver critical goods and services. Using markets starts with integration of existing local market structures to deliver immediate humanitarian assistance, which is usually based on in-kind distribution and directly built sanitation infrastructure. Market awareness is crucial for market integration as it enables local or regional procurement of goods and services. A temporary direct support of suppliers or vendors might be needed to ensure sufficient supply.

Supporting markets includes interventions that target market actors aiming to restore market systems after a shock event. This can be done through providing grants to market vendors to recover stock, creating access to information on technology options, associated costs and contact details of suppliers of sanitation related goods and services, providing fuel vouchers or subsidies or spare parts to transport businesses (e.g. for desludging truck operators), supporting market traders to increase warehousing capacity (e.g. for hygiene items) or water utilities to scale up existing wastewater treatment capacity (e.g. in host communities after refugee influx).

Market development includes interventions that target market actors aiming to achieve long-term economic recovery. This can be done through business model development (e.g. supporting a community-based organisation to establish local manufacturing and marketing of soap or sanitary napkins), value chain development (e.g. examining if there is a market for compost products), supply chain development (e.g. creating access to packaged toilet products including transportation services), product design (e.g. designing affordable latrine models for different wealth groups) and improved access to financial services (e.g. offering micro-loans for latrine construction).

### **3. Reform of the Market Regulatory Framework**

In order to help markets recover, humanitarian interventions can also include a range of activities aiming to reform the regulatory frameworks of relevant markets (national rules, norms, standards). This could be through advocacy for improved regulations (e.g. the approval of permanent infrastructure for wastewater treatment in a refugee camp), a direct engagement in policy-making processes or by building capacities of involved actors (e.g. governments, regulators, utilities etc.).

### **4. Strengthening of Market Services and Infrastructure**

To allow functioning of critical market systems, the broader market services and infrastructure might need to be supported, restored or developed. This could include loan guarantees for microfinance institutions, the provision of digital cash delivery technologies, and support to improved market information as well as the rehabilitation of roads, transportation and telecommunication networks.

### **Opportunities of Market-Based Programming**

MBP is increasingly heralded as having a critical place in the future of humanitarian programming. The proposed benefits of working through existing market systems include improvements in efficiency, effectiveness and scalability of programming and increased beneficiary dignity and choice (e.g. cash grants for latrine construction enable beneficiaries to choose their own design/style). Where feasible, MBP might promote a faster economic recovery and resilience-building due to economic multiplier effects, a better transition to development programming as well as higher levels of acceptance and sustainability (e.g. construction of a latrine increases the sense of ownership and thus the likelihood that operation and maintenance are performed properly by beneficiaries).

### **Risks and Challenges of Market-Based Programming**

Sanitation infrastructure is technically complex, subject to regulation, expensive (high capital expenditure) and dangerous if implemented poorly. Working through markets partly shifts the handling of quality and safety risks from humanitarian implementers to local market actors and beneficiaries (e.g. less control over construction quality in a CTP latrine construction programme as beneficiaries use less skilled labour and fewer salvaged materials). Providing beneficiary choice does not negate the responsibility of humanitarian implementers to ensure access to sanitation facilities and services that are safely managed, inclusive and meet minimum humanitarian standards. Design of market-based programmes should therefore include risk mitigation strategies (e.g. use of conditionality or restriction of cash transfers) as well as enabling activities such as technical support, capacity building and regular monitoring. Where sanitation programmes have identified risk factors related to knowledge, attitude and practice, these need to be addressed with appropriate complementary activities, like community engagement and sanitation marketing that seek to understand socio-cultural issues, build accountability and support healthy behaviour.

→ **References and further reading material can be found on page 197**



# Appendix

# Glossary

## A

**Activated Sludge:** See T.13

**Aerobic:** Describes biological processes that occur in the presence of oxygen.

**Aerobic Pond:** A lagoon that forms the third treatment stage in Waste Stabilisation Ponds. See T.5 (Syn.: Maturation Pond, Polishing Pond)

**Anaerobic:** Describes biological processes that occur in the absence of oxygen.

**Anaerobic Baffled Reactor (ABR):** See S.14 and T.2

**Anaerobic Digester:** See S.16 and T.4 (Syn.: Biogas Reactor)

**Anaerobic Digestion:** The degradation and stabilisation of organic compounds by microorganisms in the absence of oxygen, leading to production of biogas.

**Anaerobic Filter:** See S.15 and T.3

**Anaerobic Pond:** A lagoon that forms the first treatment stage in Waste Stabilisation Ponds. See T.5

**Anal Cleansing Water:** See Products, page 10

**Anoxic:** Describes the process by which nitrate is biologically converted to nitrogen gas in the absence of oxygen. This process is also known as denitrification.

**Application of Dehydrated Faeces:** See D.2

**Application of Pit Humus and Compost:** See D.3

**Application of Sludge:** See D.4

**Application of Stored Urine:** See D.1

**Aquaculture:** The controlled cultivation of aquatic plants and animals. See D.13

**Aquifer:** An underground layer of permeable rock or sediment (usually gravel or sand) that holds or transmits groundwater. See X.3

**Arborloo:** See D.5

## B

**Bacteria:** Simple, single cell organisms that are found everywhere on earth. They are essential for maintaining life and performing essential "services", such as composting, aerobic degradation of waste, and digesting food in our intestines. Some types, however, can be pathogenic and cause mild to severe illnesses. Bacteria obtain nutrients from their environment by excreting enzymes that dissolve complex molecules into more simple ones which can then pass through the cell membrane.

**Bar Rack:** See PRE (Syn.: Screen, Trash Trap)

**Biochemical Oxygen Demand (BOD):** A measure of the amount of oxygen used by microorganisms to degrade organic matter in water over time (expressed in mg/L and normally measured over five days as BOD5). It is an indirect measure of the amount of biodegradable organic material present in water or wastewater: the more the organic content, the more oxygen is required to degrade it (high BOD).

**Biodegradation:** Biological transformation of organic material into more basic compounds and elements (e.g., carbon dioxide, water) by bacteria, fungi, and other microorganisms.

**Biogas:** See Products, page 10

**Biogas Combustion:** See D.7

**Biogas Reactor:** See S.16 and T.4 (Syn.: Anaerobic Digester)

**Biomass:** See Products, page 10

**Blackwater:** See Products, page 10

**BOD:** See Biochemical Oxygen Demand

**Borehole Latrine:** See S.2

## C

**Capital Cost:** Funds spent for the acquisition of a fixed asset, such as sanitation infrastructure.

**Cash Transfer Programming (CTP):** A modality of Market-Based Programming. See X.13

**Caustic Soda:** See S.20

**Centralised Treatment:** See Functional Group T, page 98

**Cesspit:** An ambiguous term either used to describe a Soak Pit (Leach Pit), or a Holding Tank. (Syn.: Cesspool)

**Cesspool:** See Cesspit (Syn.)

**Chemical Oxygen Demand (COD):** A measure of the amount of oxygen required for chemical oxidation of organic material in water by a strong chemical oxidant (expressed in mg/L). COD is always equal to or higher than BOD since it is the total oxygen required for complete oxidation. It is an indirect measure of the amount of organic material present in water or wastewater: the more the organic content, the more oxygen is required to chemically oxidise it (high COD).

**Chemical Toilet:** See S.11

**Cholera Treatment Centres (CTC):** Special medical units to treat cholera. See X.9

**Cistern Flush Toilet:** A type of flush toilet. See U.4

**Clarifier:** See T.1 (Syn.: Settler, Sedimentation/Settling Tank/Basin)

**C:N Ratio:** The ratio of the mass of carbon to the mass of nitrogen in a substrate.

**Coagulation:** The destabilisation of particles in water by adding chemicals (e.g., aluminium sulphate or ferric chloride) so that they can aggregate and form larger flocs.

**Co-Composting:** See T.11

**Collection and Storage/Treatment:** See Functional Group S, page 42

**Compost:** See Products, page 10

**Composting:** The process by which biodegradable components are biologically decomposed by microorganisms (mainly bacteria and fungi) under controlled aerobic conditions.

**Condominium Sewer:** See C.3 (Syn.: Simplified Sewer)

**Constructed Wetland:** A treatment technology for wastewater that aims to replicate the naturally occurring processes in wetlands. See T.6

**Container-Based Sanitation:** Sanitation system where toilets collect human excreta in sealable, removable containers that are transported to treatment facilities. See S.10

**Conventional Gravity Sewer:** See C.4

**Conveyance:** See Functional Group C, page 84

## D

**Decentralised Wastewater Treatment System (DEWATS):** A small-scale system used to collect, treat, discharge, and/or reclaim wastewater from a small community or service area.

**Deep Trench Latrine:** See S.1

**Dehydrated Faeces:** See Products, page 10 (Syn.: Dried Faeces)

**Dehydration Vaults:** See S.9 (Syn. Double Vault UDDT)

**Desludging:** The process of removing the accumulated sludge from a storage or treatment facility.

**Detention Time:** See Hydraulic Retention Time (Syn.)

**Dewatering:** The process of reducing the water content of a sludge or slurry. Dewatered sludge may still have a significant moisture content, but it typically is dry enough to be conveyed as a solid (e.g., shovelled).

**Digestate:** The solid and/or liquid material remaining after undergoing anaerobic digestion.

**Disinfection:** The elimination of (pathogenic) microorganisms by inactivation (using chemical agents, radiation or heat) or by physical separation processes (e.g., membranes). See POST

**Disposal:** See Functional Group D, page 130

**Double Vault UDDT:** See S.9

**Double Ventilated Improved Pit (VIP):** See S.5

**Dried Faeces:** See Products, page 10 (Syn.: Dehydrated Faeces)

**Dry Cleansing Materials:** See Products, page 10

**Dry Toilet:** See U.1

## E

**Eco-Humus:** See Pit Humus (Syn.)

**E. coli:** *Escherichia coli*, a bacterium inhabiting the intestines of humans and warm-blooded animals. It is used as an indicator of faecal contamination of water.

**Ecological Sanitation (EcoSan):** An approach that aims to safely recycle nutrients, water and/or energy contained in excreta and wastewater in such a way that the use of non-renewable resources is minimised. (Syn.: Resources-Oriented Sanitation)

**Effluent:** See Products, page 10

**Emerging Technology:** A technology that has moved beyond the laboratory and small-pilot phase and is being implemented at a scale that indicates that expansion is possible.

**End-Use:** The utilisation of products derived from a sanitation system. (Syn.: Use)

**Environmental Sanitation:** Interventions that reduce peoples' exposure to disease by providing a clean environment in which to live, with measures to break the cycle of disease. This usually includes hygienic management of human and animal excreta, solid waste, wastewater, and stormwater; the control of disease vectors; and the provision of washing facilities for personal and domestic hygiene. Environmental Sanitation involves both behaviours and facilities that work together to form a hygienic environment.

**Eutrophication:** The enrichment of water, both fresh and saline, by nutrients (especially the compounds of nitrogen and phosphorus) that accelerate the growth of algae and higher forms of plant life and lead to the depletion of oxygen.

**Evaporation:** The phase change from liquid to gas that takes place below the boiling temperature and normally occurs on the surface of a liquid.

**Evapotranspiration:** The combined loss of water from a surface by evaporation and plant transpiration.

**Excreta:** See Products, page 10

## F

**Facultative Pond:** A lagoon that forms the second treatment stage in Waste Stabilisation Ponds. See T.5

**Faecal Sludge:** See Products, page 11 (Syn.: Sludge)

**Faeces:** See Products, page 10

**Fill and Cover:** See D.5

**Filtrate:** The liquid that has passed through a filter.

**Filtration:** A mechanical separation process using a porous medium (e.g., cloth, paper, sand bed, or mixed media bed) that captures particulate material and permits the liquid or gaseous fraction to pass through. The size of the pores of the medium determines what is captured and what passes through.

**Fish Pond:** See D.13

**Flotation:** The process whereby lighter fractions of a wastewater, including oil, grease, soaps, etc., rise to the surface, and thereby can be separated.

**Flocculation:** The process by which the size of particles increases as a result of particle collision. Particles form aggregates or flocs from finely divided particles and from chemically destabilised particles and can then be removed by settling or filtration.

**Flushwater:** See Products, page 11

**Fossa Alterna:** See S.5

**Free-Water Surface Constructed Wetland:** See T.7

**Functional Group:** See Compendium Terminology, page 12

## G

**Grease Trap:** See PRE

**Greywater:** See Products, page 11

**Grit Chamber:** See PRE (Syn.: Sand Trap)

**Groundwater:** Water that is located beneath the earth's surface. See X.3

**Groundwater Recharge:** See D.12

**Groundwater Table:** The level below the earth's surface which is saturated with water. It corresponds to the level where water is found when a hole is dug or drilled. A groundwater table is not static and can vary by season, year or usage (Syn.: Water Table).

## H

**Handwashing:** See U.7

**Helminth:** A parasitic worm, i.e. one that lives in or on its host, causing damage. Some examples that infect humans are roundworms (e.g., *Ascaris* and hookworm) and tapeworms. The infective eggs of helminths can be found in excreta, wastewater and sludge. They are very resistant to inactivation and may remain viable in faeces and sludge for several years.

**Horizontal Subsurface Flow Constructed Wetland:** A type of Constructed Wetland. See T.6

**Human-Powered Emptying and Transport:** See C.1 (Syn.: Manual Emptying and Transport).

**Humus:** The stable remnant of decomposed organic material. It improves soil structure and increases water retention, but has no nutritive value.

**Hydraulic Retention Time (HRT):** The average amount of time that liquid and soluble compounds stay in a reactor or tank. (Syn.: Detention Time)

## I

**Immersed Membrane Bioreactor (IMBR):** A type of Activated Sludge system. See T.13

**Improved Sanitation:** Facilities that ensure hygienic separation of human excreta from human contact.

**Influent:** The general name for the liquid that enters into a system or process (e.g., wastewater).

**Irrigation:** See D.11

## L

**Lactic Acid Fermentation:** See S.19

**Leachate:** The liquid fraction that is separated from the solid component by gravity filtration through media (e.g., liquid that drains from drying beds).

**Leach Field:** See D.9

**Leach Pit:** See Soak Pit D.10

**Lime:** The common name for calcium oxide (quicklime, CaO) or calcium hydroxide (slaked or hydrated lime, Ca(OH)<sub>2</sub>). It is a white, caustic and alkaline powder produced by heating limestone. Slaked lime is less caustic than quicklime and is widely used in water/wastewater treatment and construction (for mortars and plasters). It can also be used for on-site treatment of faecal sludge. See S.17

**Log Reduction:** Organism removal efficiencies. 1 log unit = 90 %, 2 log units = 99 %, 3 log units = 99.9 %, and so on.

## M

**Macrophyte:** An aquatic plant large enough to be readily visible to the naked eye. Its roots and differentiated tissues may be emergent (reeds, cattails, bulrushes, wild rice), submergent (water milfoil, bladderwort) or floating (duckweed, lily pads).

**Market-Based Programming (MBP):** Ways of supporting local sanitation market systems. See X.13

**Maturation Pond:** See Aerobic Pond (Syn.)

**Methane:** A colourless, odourless, flammable, gaseous hydrocarbon with the chemical formula CH<sub>4</sub>. Methane is present in natural gas and is the main component (50–75%) of biogas that is formed by the anaerobic decomposition of organic matter.

**Microorganism:** Any cellular or non-cellular microbiological entity capable of replication or of transferring genetic material (e.g. bacteria, viruses, protozoa, algae or fungi).

**Micro-Pollutant:** Pollutant that is present in extremely low concentrations (e.g. trace organic compounds).

**Motorised Emptying and Transport:** See C.2

## N

**Night Soil:** A historical term for faecal sludge.

**Nutrient:** Any substance that is used for growth. Nitrogen (N), phosphorus (P) and potassium (K) are the main nutrients contained in agricultural fertilisers. N and P are also primarily responsible for the eutrophication of water bodies.

## O

**Off-site Sanitation:** A sanitation system in which excreta and wastewater are collected and conveyed away from the plot where they are generated. An offsite sanitation system relies on a sewer technology (see C.3 and C.4) for conveyance.

**On-site Sanitation:** A sanitation system in which excreta and wastewater are collected and stored or treated on the plot where they are generated.

**Open Defecation:** Practice of defecating outside in the open environment. See U.5

**Operation and Maintenance (O & M):** Routine or periodic tasks required to keep a process or system functioning according to performance requirements and to prevent delays, repairs or downtime.

**Organics:** See Products, page 11

## P

**Parasite:** An organism that lives on or in another organism and damages its host.

**Pathogen:** An organism or other agent that causes disease.

**Percolation:** The movement of liquid through a filtering medium with the force of gravity. See X.3

**Personal Protective Equipment (PPE):** Protective clothing including boots, masks, gloves, apron, etc. or other garments or equipment designed to protect the wearer's body from injury or infection from sanitation products.

**pH:** The measure of acidity or alkalinity of a substance. A pH value below 7 indicates that it is acidic, a pH value above 7 indicates that it is basic (alkaline).

**Pit Humus:** See Products, page 11 (Syn.: EcoHumus)

**Planted Drying Beds:** See T.10

**Polishing Pond:** See Aerobic Pond (Syn.)

**Post-Treatment:** See POST (Syn.: Tertiary Treatment)

**Pour Flush Toilet:** A type of flush toilet. See U.4

**Pre-Treatment:** See PRE

**Pre-Treatment Products:** See Products, page 11

**Primary Treatment:** The first major stage in wastewater treatment that removes solids and organic matter mostly by the process of sedimentation or flotation.

**Product:** See Compendium Terminology, page 9

**Protozoa:** A diverse group of unicellular eukaryotic organisms, including amoeba, ciliates, and flagellates. Some can be pathogenic and cause mild to severe illnesses.

## R

**Raised Latrine:** See S.7

**Resources-Oriented Sanitation:** See Ecological Sanitation (Syn.)

**Reuse:** Use of recycled water or other sanitation products

**Runoff:** see Surface Runoff

## S

**Sand Trap:** See PRE (Syn.: Grit Chamber)

**Sanitation:** The means of safely collecting and hygienically disposing of excreta and liquid wastes for the protection of public health and the preservation of the quality of public water bodies and, more generally, of the environment.

**Sanitation System:** See Compendium Terminology, page 9

**Sanitation Technology:** See Compendium Terminology, page 9

**Screen:** See PRE (Syn.: Bar Rack, Trash Trap)

**Scum:** The layer of solids formed by wastewater constituents that float to the surface of a tank or reactor (e.g., oil and grease).

**Secondary Treatment:** Follows primary treatment to achieve the removal of biodegradable organic matter and suspended solids from effluent. Nutrient removal (e.g., phosphorus) and disinfection can be included in the definition of secondary treatment or tertiary treatment, depending on the configuration.

**Sedimentation:** Gravity settling of particles in a liquid such that they accumulate. (Syn.: Settling)

**Sedimentation Tank/Basin:** See T.1 (Syn.: Settler, Clarifier, Settling Tank/Basin)

**Sedimentation and Thickening Ponds:** See T.8

**(Semi-) Centralised Treatment:** See Functional Group T, page 98

**Septage:** A historical term to define sludge removed from septic tanks.

**Septic:** Describes the conditions under which putrefaction and anaerobic digestion take place.

**Septic Tank:** See S.13

**Settler:** See T.1 (Syn.: Clarifier, Sedimentation/Settling Tank/Basin)

**Settling:** See Sedimentation (Syn.)

**Settling Tank/Basin:** See T.1 (Syn.: Settler, Clarifier, Sedimentation Tank/Basin)

**Sewage:** Waste matter that is transported through the sewer.

**Sewer:** An open channel or closed pipe used to convey sewage. See C.3 and C.4

**Sewerage:** The physical sewer infrastructure (sometimes used interchangeably with sewage).

**Sewer Discharge Station:** A type of Transfer Station and Storage. See C.6

**Shallow Trench Latrine:** See U.6

**Simplified Sewer:** See C.3 (Syn.: Condominium Sewer)

**Single Pit:** See S.3

**Single Ventilated Improved Pit (VIP):** See S.3

**Sitter:** A person who prefers to sit on the toilet.

**Sludge:** See Products, page 11

**Small-Bore Sewer:** See C.3 (Syn.: Solids-Free Sewer, Settled Sewer)

**Soak Pit:** See D.10 (Syn.: Leach Pit)

**Soil Conditioner:** A product that enhances the water and nutrient retaining properties of soil.

**Solid Waste Management:** See X.8

**Solids-Free Sewer:** See C.3 (Syn.: Small-Bore Sewer, Settled Sewer)

**Specific Surface Area:** The ratio of the surface area to the volume of a solid material (e.g., filter media).

**Squatter:** A person who prefers to squat over the toilet.

**Stabilisation:** The degradation of organic matter with the goal of reducing readily biodegradable compounds to lessen environmental impacts (e.g., oxygen depletion, nutrient leaching).

**Stored Urine:** See Products, page 11

**Stormwater:** See Products, page 11 and C.5

**Sullage:** A historical term for greywater

**Superstructure:** The walls and roof built around a toilet or bathing facility to provide privacy and protection to the user.

**Surface Disposal and Storage:** See D.6

**Surface Runoff:** The portion of precipitation that does not infiltrate the ground and runs overland.

**Surface Water:** A natural or man-made water body that appears on the surface, such as a stream, river, lake, pond, or reservoir.

**System Template:** See page 13

## T

**Tertiary Filtration:** Application of filtration processes for tertiary treatment of effluent. See POST

**Tertiary Treatment:** Follows secondary treatment to achieve enhanced removal of pollutants from effluent. Nutrient removal (e.g., phosphorus) and disinfection can be included in the definition of secondary treatment or tertiary treatment, depending on the configuration. See POST (Syn.: Post-Treatment)

**Thickening Ponds:** See T.8

**Toilet:** User interface for urination and defecation.

**Total Solids (TS):** The residue that remains after filtering a water or sludge sample and drying it at 105° C (expressed in mg/L). It is the sum of Total Dissolved Solids (TDS) and Total Suspended Solids (TSS).

**Transfer Station:** See C.6 (Syn.: Underground Holding Tank)

**Trash Trap:** See PRE (Syn.: Screen, Bar Rack)

**Trickling Filter:** See T.7

**Twin Pits for Pour Flush:** See S.6

## U

**Underground Holding Tank:** See C.6 (Syn.: Transfer Station)

**Unplanted Drying Beds:** See T.9

**Urea:** The organic molecule (NH<sub>2</sub>)<sub>2</sub>CO that is excreted in urine and that contains the nutrient nitrogen. Over time, urea breaks down into carbon dioxide and ammonium, which is readily used by organisms in soil. It can also be used for on-site faecal sludge treatment. See S.18

**Urinal:** See U.3

**Urine:** See Products, page 11

**Urine-Diverting Dry Toilet (UDDT):** See U.2

**Use and/or Disposal:** See Functional Group D, page 130

**User Interface:** See Functional Group U, page 26

## V

**Vector:** An organism (most commonly an insect) that transmits a disease to a host. For example, flies are vectors as they can carry and transmit pathogens from faeces to humans.

**Vermi-Composting:** See T.12

**Vermi-Filtration:** See T.12

**Vertical Flow Constructed Wetland:** A type of Constructed Wetland. See T.6

**Virus:** An infectious agent consisting of a nucleic acid (DNA or RNA) and a protein coat. Viruses can only replicate in the cells of a living host. Some pathogenic viruses are known to be waterborne (e.g., the rotavirus that can cause diarrheal disease).

## W

**Washer:** A person who prefers to use water to cleanse after defecating, rather than wipe with dry material.

**Waste Stabilisation Ponds (WSP):** See T.5

**Wastewater:** Used water from any combination of domestic, industrial, commercial or agricultural activities, surface runoff/stormwater, and any sewer inflow/infiltration.

**Water Disposal:** See D.12

**Water Table:** See Groundwater Table (Syn.)

**Wiper:** Someone who prefers to use dry material (e.g., toilet paper or newspapers) to cleanse after defecating, rather than wash with water.

**Worm-Based Toilet:** See S.12

# References

All listed references are also available at and can be downloaded from the Compendium of Sanitation Technologies in Emergencies online platform and the Sustainable Sanitation Alliance (SuSanA) library.

## U.1 Dry Toilet

### Construction manual for different slab designs:

- Brandberg, B. (1997): Latrine Building. A Handbook for Implementation of the Sanplat System. Intermediate Technology Publications, London, UK.

### Detailed construction manuals for slabs and pit lining:

- CAWST (2011): Introduction to Low Cost Sanitation. Latrine Construction. A CAWST Construction Manual. CAWST, Calgary, Canada
- Morgan, P. R. (2007): Toilets That Make Compost. SEI, Stockholm, Sweden.
- Morgan, P. R. (2009): Ecological Toilets. Start Simple and Upgrade from Arborloo to VIP. SEI, Stockholm, Sweden.

### Guidance and checklists for design, construction and maintenance:

- Reed, B. (2012): An Engineer's Guide to Latrine Slabs. WEDC, Loughborough University, Leicestershire, UK.

## U.2 Urine-Diverting Dry Toilet

### Step-by step instruction on how to build a UDDT:

- Morgan, P. R. (2007): Toilets That Make Compost. SEI, Stockholm, Sweden.
- Gensch, R., Miso, A., Itchon, G., Sayre, E. (2010): Low-Cost Sustainable Sanitation Solutions for Mindanao and the Philippines. Xavier University Press, Cagayan de Oro City, Philippines.

### Overview of UDDT solutions:

- Morgan, P. R. (2009): Ecological Toilets. Start Simple and Upgrade from Arborloo to VIP. SEI, Stockholm, Sweden.
- Münch, E., Winker, M. (2011): Technology Review of Urine Diversion Components. GIZ, Eschborn, Germany.
- Rieck, C., Von Münch, E., Hoffmann, H. (2012): Technology Review of Urine-Diverting Dry Toilets (UDDTs). GIZ, Eschborn, Germany.

### Book on ecological sanitation:

- Winblad, U., Simpson-H., M. (2004): Ecological Sanitation. SEI, Stockholm, Sweden.

## U.3 Urinal

### Directions for making simple Urinals:

- Austin, A., Duncker, L. (2002): Urine-Diversion. Ecological Sanitation Systems in South Africa. CSIR, Pretoria, South Africa.

### Overview of waterless Urinals:

- Von Münch, E., Dahm, P. (2009): Waterless Urinals: A Proposal to Save Water and Recover Urine Nutrients in Africa. Addis Ababa, Ethiopia.

### Review of different urine diversion technologies:

- Von Münch, E., Winker, M. (2011): Technology Review of Urine Diversion Components. GIZ, Eschborn, Germany.

### Low cost sanitation technologies:

- NWP (2006): Smart Sanitation Solutions. Examples of Innovative, Low-Cost Technologies for Toilets, Collection, Transportation, Treatment and Use of Sanitation Products. Netherlands Water Partnership, The Hague, Netherlands.

## U.4 Flush Toilet

### Pour flush toilet drawings, dimensions and critical design criteria:

- Mara, D. D. (1985): Design of Pour-Flush Latrines. UNDP Interregional Project INT/81/047. The World Bank, Washington D.C., US.
- Mara, D. D. (1996): Low-Cost Urban Sanitation. Wiley, Chichester, UK.
- Maki, B. (2005): Assembling and Installing a New Toilet.
- Vandervort, D. (2007): Toilets: Installation and Repair.

## U.5 Controlled Open Defecation

### Information on Controlled Open Defecation:

- Harvey, P. A. (2007): Excreta Disposal in Emergencies. WEDC, Loughborough University, UK.
- WEDC (2013): Open Defecation Fields in Emergencies – Poster 24. WEDC, Loughborough University, UK.

## U.6 Shallow Trench Latrines

### Information on Shallow Trench Latrines:

- Harvey, P. A. (2007): Excreta Disposal in Emergencies. WEDC, Loughborough University, UK.
- WEDC (2013): Shallow Trench Latrines in Emergencies – Poster 25. WEDC, Loughborough University, UK.

## U.7 Handwashing Facility

### Challenges and practices for handwashing in emergencies:

- Ramos, M., Benelli, P., Irvine, E., Watson, J. (2016): WASH in Emergencies: Problem Exploration Report – Handwashing. Humanitarian Innovation Fund, London, UK.

### Hygiene promotion and behaviour change:

- WEDC (2013): Managing hygiene promotion in WASH programmes. WEDC, Loughborough University, UK.
- Mosler, H.-J., Contzen, N. (2016). Systematic behaviour change in water, sanitation and hygiene. Eawag, Dübendorf, Switzerland.

## S.1 Deep Trench Latrine

### Key design features of Deep Trench Latrines:

- WEDC (2013): Deep Trench Latrines in Emergencies – Poster 26. WEDC, Loughborough University, UK.

### General overview, designs, construction and sizing of pits:

- Harvey, P. A. (2007): Excreta Disposal in Emergencies. WEDC, Loughborough University, UK.
- Harvey, P., Baghri, S., Reed, B. (2002): Emergency Sanitation. Assessment and Programme Design. WEDC, Loughborough, UK.
- Reed, B., Torr, D., Scott, R. (2016): Emergency Sanitation: Developing Criteria for Pit Latrine Lining. WEDC, Loughborough, UK.

## S.2 Borehole Latrine

### General Overview, depth and diameter of hole, advantages and disadvantages:

- Harvey, P. A. (2007): Excreta Disposal in Emergencies. WEDC, Loughborough, UK.
- WEDC (2013): Borehole latrine – Poster 18. WEDC, Loughborough, UK.

## S.3 Single Pit Latrine

### Pit Latrines and its impact on groundwater quality:

- ARGOSS (2001): Guidelines for assessing the risk to groundwater from on-site sanitation. NERC, British Geological Survey Commissioned Report, UK.
- Graham, J. P., Polizzotto, M. L. (2013): Pit latrines and their impacts on groundwater quality: a systematic review. Environmental Health Perspectives, Washington D.C., US.

### Pit Latrine design and calculation of pit size and technology life:

- Pickford, J. (1995): Low Cost Sanitation. A Survey of Practical Experience. Intermediate Technology Publications, London, UK.

- Robens Institute (1996): Simple Pit Latrine. University of Surrey, Guildford, UK.
- Reed, B. (2014): Latrine pit design. WEDC, Loughborough, UK.
- Reed, B., Torr, D., Scott, R. (2016): Emergency Sanitation: Developing Criteria for Pit Latrine Lining. WEDC, Loughborough, UK.
- WEDC (2017): Mobile Note 59 - Raised and Elevated Latrines. WEDC, Loughborough, UK.

- Calculating the size of Raised Latrines:**
- UNHCR (2018): UNHCR WASH Manual – Raised Pit Latrines, UNHCR. Geneva, Switzerland

## S.4 Single Ventilated Improved Pit (VIP)

### VIP working principles, design and construction information:

- Morgan, P. (2011): The upgradable Blair VIP (uBVIP) explained. Aquamor, Zimbabwe.
- Mara, D. D. (1984): The Design of Ventilated Improved Pit Latrines. UNDP Interregional Project. The World Bank/UNDP, US.
- WEDC (2012): Ventilated Improved Pit (VIP) – Guide 27. WEDC, Loughborough, UK.
- WEDC (2014): Latrine pit design – WEDC Guide 23. WEDC, Loughborough, UK.

### Pit superstructure, lining and latrine excavation:

- WEDC (2014): Latrine superstructure – WEDC Guide 28. WEDC, Loughborough, UK.
- WEDC (2014): Latrine pit excavation and pit lining – WEDC Guide 24. WEDC, Loughborough, UK.

## S.5 Twin Pit Dry System

### Construction guidelines for Fossa Alterna:

- Morgan, P., EcoSanRes (2007): Toilets That Make Compost. SEI, Stockholm, Sweden.
- Monvois, J., Ganert, J., Freneux, C., Guillaume, M. (2010): How to Select Appropriate Technical Solutions for Sanitation. Programme Solidarité Eau (pS-Eau), Paris, France.

### Effect of eco-humus on plant growth:

- Morgan, P. (2004): Plant Trials Using Fossa Alterna Humus. EcoSanRes/ SEI, Stockholm, Sweden.

## S.6 Twin Pit with Pour Flush

### Overview various on-site sanitation technologies:

- Franceys, R., Pickford, J., Reed, R. (1992): A Guide to the Development of on-Site Sanitation. WHO, Geneva, Switzerland.

### Design guidelines for pour-flush toilets:

- Mara, D. D. (1985): The Design of Pour-Flush Latrines. WHO, Washington D.C., US.

## S.7 Raised Latrine

### Overview on elevated and Raised Latrines:

- WEDC (2014): Pit latrines for special circumstances – Guide 29. WEDC, Loughborough, UK.

## S.8 Single Vault Urine Diversion Dehydration Toilet (UDDT)

### Overview of UD principles, construction, operation and technology components:

- Rieck, C., von Münch, E., Hoffmann, H. (2012): Technology Review of Urine-diverting dry toilets (UDDTs). GIZ, Eschborn, Germany.
- Deegener, S., Samwel, M. (2015): Urine Diverting Dry Toilets – Principles, Operation and Construction. Women in Europe for a Common Future (WECF).

### Case studies from Haiti and the Philippines:

- Kramer, S., Preneta, N., Kilbride, A. (2013): Piloting ecological sanitation in the emergency context of Port-au-Prince, Haiti, after the 2010 earthquake. SOIL Haiti, Nakuru, Kenya.
- Gensch, R., Miso, A., Itchon, G., Sayre, E. (2010): Low-Cost Sustainable Sanitation Solutions for Mindanao and the Philippines. Xavier University Press, Cagayan de Oro, Philippines.

## S.9 Double Vault Urine Diversion Dehydration Toilet (UDDT)

### Overview of UD principles, construction, operation and technology components:

- Rieck, C., von Münch, E., Hoffmann, H. (2012): Technology Review of Urine-diverting dry toilets (UDDTs). GIZ, Eschborn, Germany.
- Deegener, S., Samwel, M. (2015): Urine Diverting Dry Toilets – Principles, Operation and Construction. Women in Europe for a Common Future (WECF).
- Harvey, P. A. (2007): Excreta Disposal in Emergencies. WEDC, Loughborough, UK.

### Practical UDDT construction manual Philippines:

- Gensch, R., Miso, A., Itchon, G., Sayre, E. (2010): Low-Cost Sustainable Sanitation Solutions for Mindanao and the Philippines. Xavier University Press, Cagayan de Oro, Philippines.

## S.10 Container-Based Toilet

### Container-based sanitation in urban emergency settings:

- Reade, A. (2016): What Potential Is There Of Container Based Sanitation And The Social Enterprise In Urban Emergencies? ELHRA.

### Experiences from implementing urine diversion container-based sanitation:

- Kramer, S., Preneta, N., Kilbride, A. (2013): Piloting ecological sanitation in the emergency context of Port-au-Prince, Haiti, after the 2010 earthquake. SOIL Haiti, Nakuru, Kenya.
- Mijthab, M. (2011). moSan - mobile sanitation: Toilet for the urban poor in Bangladesh. Hochschule Magdeburg-Stendal (FH), Institut für Industrial Design, Germany.
- Tilmans, S., Russel, K., Sklar, R., Page, L., Kramer, S., Davis, J. (2015): Container-based sanitation: assessing costs and effectiveness of excreta management in Cap Haitien, Haiti. Environment and Urbanization Journal.

## S.11 Chemical Toilet

### Guidance for choosing portable or chemical toilets in emergency situations:

- Harvey, P.A. (2007): Excreta Disposal in Emergencies. WEDC, Loughborough, UK.

### Experiences and lessons learnt from implanting portable toilets in the emergency context:

- Eyrard, J. (2011): Is the "Portaloo" solution replicable? – Emergency WASH response after earthquake in Port au Prince, Haiti 2010. ACF, France.

## S.12 Worm-Based Toilet (E)

### Documentation of general development and trialling of this technology:

- Furlong C., et al. (2015): The development of an onsite sanitation system based on vermifiltration: the 'tiger toilet'. Journal of Water, Sanitation and Hygiene for Development. Loughborough, UK.
- Furlong, C., Gibson, W. T., Oak, A., Thakar, G., Kodgire, M. (2016): Technical and user evaluation of a novel worm-based, on-site sanitation system in rural India. Practical Action Publishing, UK.
- Furlong C., Rajapaksha, N. S., Butt, K. R., Gibson, W. T. (2017): Is composting worm availability the main barrier to large-scale adoption of worm-based organic waste processing technologies? Journal of Cleaner Production, US.
- Furlong C., Lamb, J., Bastable, A. (2017): Learning from Oxfam's Tiger Worm Toilets projects. 40th WEDC International Conference, Loughborough, UK.

## S.13 Septic Tank

### Design manuals:

- Oxfam (2008): Septic Tank Guidelines. Technical Brief. Oxford, UK.
- Mara, D. D. (1996): Low-Cost Urban Sanitation. Wiley, Chichester, UK.

- Polprasert, C., Rajput, V. S. (1982): Environmental Sanitation Reviews: Septic Tank and Septic Systems. Environmental Sanitation Information Center, Bangkok, Thailand.

**Comprehensive overview of decentralised wastewater treatment systems:**

- Ulrich, A., Reuter, S., Gutterer, B., Sasse, L., Panzerbieter, T., Reckerzügel, T. (2009): Decentralised Wastewater Treatment Systems (DEWATS) and Sanitation in Developing Countries. WEDC, Loughborough, UK.

### S.14 Anaerobic Baffled Reactor

**Systematic overview of sanitation systems and technologies including ABR's:**

- Tilley, E., Ulrich, L., Lüthi, C., Reymond, Ph., Zurbrügg, C. (2014): Compendium of Sanitation Systems and Technologies. Eawag, Dübendorf, Switzerland.
- Ulrich, A., Reuter, S., Gutterer, B., Sasse, L., Panzerbieter, T., Reckerzügel, T. (2009): Decentralised Wastewater Treatment Systems (DEWATS) and Sanitation in Developing Countries. WEDC, Loughborough, UK.

**Analyses the appropriateness of ABRs for on-site primary sanitation in low-income communities:**

- Foxon, K. M., Pillay, S., Lalbahadur, T., Rodda, N., Holder, F., Buckley, C. A. (2004): The Anaerobic Baffled Reactor (ABR): An Appropriate Technology for on-Site Sanitation. Water SA, South Africa.

### S.15 Anaerobic Filter

**Systematic overview of sanitation systems and technologies including AF's:**

- Tilley, E., Ulrich, L., Lüthi, C., Reymond, Ph., Zurbrügg, C. (2014): Compendium of Sanitation Systems and Technologies. Eawag, Dübendorf, Switzerland.
- Ulrich, A., Reuter, S., Gutterer, B., Sasse, L., Panzerbieter, T., Reckerzügel, T. (2009): Decentralised Wastewater Treatment Systems (DEWATS) and Sanitation in Developing Countries. WEDC, Loughborough, UK.
- Morel, A., Diener, S. (2006): Greywater Management in Low and Middle-Income Countries, Review of Different Treatment Systems for Households or Neighborhoods. EAWAG, Dübendorf, Switzerland.

**Low-cost, decentralised wastewater management and efficient resource recovery:**

- Rose, D. G. (1999): Community-Based Technologies for Domestic Wastewater Treatment and Reuse-options for urban agriculture. International Development Research Center Canada (IDRC), Ottawa, Canada.

### S.16 Biogas Reactor

**Overview of technical and social information on Biogas Reactors:**

- Mang, H.-P., Li, Z. (2010): Technology Review of Biogas Sanitation. GIZ, Eschborn, Germany.
- Cheng, S., Zifu, L., Mang, H. P., Huba, E. M., Gao, R., Wang, X., (2014): Development and application of prefabricated biogas digesters in developing countries. Renewable and Sustainable Energy Reviews Journal.
- Ulrich, A., Reuter, S., Gutterer, B., Sasse, L., Panzerbieter, T., Reckerzügel, T. (2009): Decentralised Wastewater Treatment Systems (DEWATS) and Sanitation in Developing Countries. WEDC, Loughborough, UK.
- Khatavkar, A., Matthews, S. (2013): Bio-Latrines. Practical Action East Africa, Nairobi, Kenya.

**Anaerobic digestion of biowaste:**

- Vögeli, Y., Lohri, C. R., Gallardo, A., Diener, S., Zurbrügg, C. (2014): Anaerobic Digestion of Biowaste in Developing Countries. Practical Information and Case Studies. Eawag, Dübendorf, Switzerland.

### S.17 Hydrated Lime Treatment (E)

**Lime Treatment in emergencies:**

- Anderson, C., Malambo, D. H., Perez, M. E., Nobela, H. N., de Pooter, L., Spit, J., Hooijmans, C. M., de Vossenber, J. V., Greya, W., Thole, B., van Lier, J. B., Brdjanovic, D. (2015): Lactic Acid Fermentation, Urea and Lime Addition: Promising Faecal Sludge Sanitizing Methods for Emergency Sanitation. Env. Research and Public Health Journal.

**Case studies from Haiti, Cambodia and the Philippines:**

- Strande, L., Ronteltap, M., Brdjanovic, D. (2014): Faecal Sludge Management (FSM) book - Systems Approach for Implementation and Operation. IWA Publishing, London, UK.
- Chakraborty I., Capito, M., Jacks, C., Pringle R. (2014): Household-level application of hydrated lime for on-site treatment and agricultural use of latrine sludge. WEDC, Hanoi, Vietnam.
- Sozzi, E., Fesselet, J. F., Taylor, H. (2011): Standard operating procedure for the physicochemical treatment of CTC wastewaters. Médecins Sans Frontières (MSF), France.
- USAID (2015): Implementer's Guide to Lime Stabilisation for Septage Management in the Philippines. Philippines.

### S.18 Urea Treatment (E)

**Urea addition as sludge sanitising method in emergencies:**

- Anderson, C., Malambo, D. H., Perez, M.

- E., Nobela, H. N., de Pooter, L., Spit, J., Hooijmans, C. M., Greya, W., Thole, B., van Lier, J. B., Brdjanovic, D. (2015): Lactic Acid Fermentation, Urea and Lime Addition: Promising Faecal Sludge Sanitizing Methods for Emergency Sanitation. Env. Research and Public Health Journal.

**Studies on urea treatment efficacy:**

- Nordin, A., Nyberg, K., Vinneras, B. (2009): Inactivation of Ascaris Eggs in Source-Separated Urine and Feces by Ammonia at Ambient Temperatures. Applied and Environmental Microbiology Journal.
- Vinnerås, B. (2007): Comparison of composting, storage and urea treatment for sanitising of faecal matter and manure. Bioresource Technology Journal.
- González P., M. E. (2014): Sanitising faecal sludge with ammonia (from urea) in the context of emergency situations. UNESCO-IHE, Delft, Netherlands.

### S.19 Lactic Acid Fermentation (LAF) Treatment (E)

**Study on LAF Treatment efficacy:**

- Anderson, C., Malambo, D. H., Perez, M. E., Nobela, H. N., de Pooter, L., Spit, J., Hooijmans, C. M., Greya, W., Thole, B., van Lier, J. B., Brdjanovic, D. (2015): Lactic Acid Fermentation, Urea and Lime Addition: Promising Faecal Sludge Sanitizing Methods for Emergency Sanitation, Env. Research and Public Health Journal.
- Ligocka, A., Paluszak, Z. (2004): Capability of lactic acid bacteria to inhibit pathogens in sewage sludge subject to biotechnological processes. University of Technology and Agriculture, Bydgoszcz, Poland.
- Malambo, D. (2014): Sanitizing Faecal Sludge using Lactic Acid Bacteria in Emergencies. Unesco-IHE, Delft, Netherlands.

### S.20 Caustic Soda Treatment (E)

**Report showing different application rates of Caustic Soda:**

- Mamani, G., Spit, J., Kemboi, E. (2016): Sanitation Innovations for Humanitarian Disasters in Urban Areas. Speedy Sanitization And Stabilization. ELRHA.

### C.1 Manual Emptying and Transport

**Information on collection and transport of faecal sludge:**

- Strande, L., Ronteltap, M., Brdjanovic, D. (2014): Faecal Sludge Management (FSM) book - Systems Approach for Implementation and Operation. IWA Publishing, London, UK.

**Comparison of approaches on pit emptying from South Africa, Kenya:**

- Eales, K. (2005): Bringing pit emptying



out of the darkness. A comparison of approaches in Durban, South Africa, and Kibera, Kenya. Building Partnerships for Development in Water and Sanitation, UK.

## C.2 Motorised Emptying and Transport

**Description and comparison of different vehicles and methods for faecal sludge emptying and transport:**

- Strande, L., Ronteltap, M., Brdjanovic, D. (2014): Faecal Sludge Management. Systems Approach for Implementation and Operation. IWA Publishing, London, UK.

**Information on faecal sludge emptying and transport:**

- Chowdhry, S., Koné, D. (2012): Business Analysis of Faecal Sludge Management: Emptying and Transportation Services in Africa and Asia. Bill & Melinda Gates Foundation, Seattle, US.
- O’Riordan, M. (2009): Investigation into Methods of Pit Latrine Emptying. Management of Sludge Accumulation in VIP Latrines. Water Research Commission, Pretoria, South Africa.
- Boesch, A., Schertenleib, R. (1985): Emptying on-Site Excreta Disposal Systems. Field Tests with Mechanized Equipment in Gaborone (Botswana). IRCWD, Dübendorf, Switzerland.

## C.3 Simplified Sewer

**Design guidelines for manual calculations:**

- Bakalian, A., Wright, A., Otis, R., Azevedo N., J. (1994): Simplified Sewerage: Design Guidelines. UNDP-World Bank Water and Sanitation Program, Washington D.C., US.

**Comprehensive overview including design examples and case studies:**

- Mara, D. D. (1996a): Low-Cost Sewerage. Wiley, Chichester, UK.
- Mara, D. D. (1996b): Low-Cost Urban Sanitation. Wiley, Chichester, UK.
- Mara, D. D., Sleigh, A., Tayler, K. (2001): PC-Based Simplified Sewer Design. University of Leeds, UK.
- Reed, R. A. (1995): Sustainable Sewerage, Guidelines for community schemes. Intermediate Technology Pub, UK.

## C.4 Conventional Gravity Sewer

**Technical aspects and standard designs:**

- Bizier, P. (2007): Gravity Sanitary Sewer Design and Construction. American Society of Civil Engineers (ASCE), New York, US.
- Tchobanoglous, G. (1981): Wastewater Engineering: Collection and Pumping of Wastewater. McGraw-Hill, New York, US.

- EPA (n.y.): Collection Systems Technology Fact Sheet – Sewers. Conventional Gravity. United States Environmental Protection Agency (EPA).

## C.5 Stormwater Drainage

**Different tools for detailed planning and design guidelines:**

- Cotton, A., Talyer, K. (2000): Services for the urban poor: 4. Technical guidelines for planners and engineers. WEDC, Loughborough, UK.

**Low cost surface water and stormwater drainage technologies:**

- Bjerregaard, M., Meekings, H. (2008): Low Cost Drainage for Emergencies. Oxfam, UK.
- WHO (1991): Surface water drainage for low income communities. Geneva, Switzerland
- EPA (2009): Managing Stormwater with Low Impact Development Practices: Addressing Barriers to LID. EPA, UK.

## C.6 Transfer Station and Storage

**Information on FSM incl. intermediate storage technologies:**

- Strande, L., Ronteltap, M., Brdjanovic, D. (2014): Faecal Sludge Management (FSM) book - Systems Approach for Implementation and Operation. IWA Publishing, London, UK.
- Chowdhry, S., Koné, D. (2012): Business Analysis of Faecal Sludge Management: Emptying and Transportation Services in Africa and Asia. Bill & Melinda Gates Foundation, Seattle, US.

## PRE Pre-Treatment Technologies

**Design considerations for different contexts:**

- Robbins, D. M., Ligon, G. C. (2014): How to Design Wastewater Systems for Local Conditions in Developing Countries. IWA Publishing, London, UK.
- Tchobanoglous, G., Burton, F. L., Stensel, H. D. (2004): Wastewater Engineering: Treatment and Reuse. Metcalf & Eddy, New York, US.
- Ulrich, A., Reuter, S., Gutterer, B., Sasse, L., Panzerbieter, T., Reckerzügel, T. (2009): Decentralised Wastewater Treatment Systems (DEWATS) and Sanitation in Developing Countries. WEDC, Loughborough, UK.

## T.1 Settler

**Systematic overview of different sanitation systems and technologies:**

- Tilley, E., Ulrich, L., Lüthi, C., Reymond, Ph., Zurbrügg, C. (2014): Compendium of Sanitation Systems and Technologies. Eawag, Dübendorf, Switzerland.

- Ulrich, A., Reuter, S., Gutterer, B., Sasse, L., Panzerbieter, T., Reckerzügel, T. (2009): Decentralised Wastewater Treatment Systems (DEWATS) and Sanitation in Developing Countries. WEDC, Loughborough, UK.

**Manual on primary, secondary and tertiary treatment including general principles and practices:**

- EPA Ireland (1997): Waste Water Treatment Manuals – Primary, Secondary and Tertiary Treatment. Wexford, Ireland.

## T.2 Anaerobic Baffled Reactor

**Systematic overview of sanitation systems and technologies including ABR’s:**

- Tilley, E., Ulrich, L., Lüthi, C., Reymond, Ph., Zurbrügg, C. (2014): Compendium of Sanitation Systems and Technologies. Eawag, Dübendorf, Switzerland.
- Ulrich, A., Reuter, S., Gutterer, B., Sasse, L., Panzerbieter, T., Reckerzügel, T. (2009): Decentralised Wastewater Treatment Systems (DEWATS) and Sanitation in Developing Countries. WEDC, Loughborough, UK.

**Analysis of the appropriateness of ABRs for on-site primary sanitation in low-income communities:**

- Foxon, K. M., Pillay, S., Lalbahadur, T., Rodda, N., Holder, F., Buckley, C. A. (2004): The Anaerobic Baffled Reactor (ABR): An Appropriate Technology for on-Site Sanitation. Water SA, South Africa.

## T.3 Anaerobic Filter

**Systematic overview of sanitation systems and technologies including AF’s:**

- Tilley, E., Ulrich, L., Lüthi, C., Reymond, Ph., Zurbrügg, C. (2014): Compendium of Sanitation Systems and Technologies. Eawag, Dübendorf, Switzerland.
- Ulrich, A., Reuter, S., Gutterer, B., Sasse, L., Panzerbieter, T., Reckerzügel, T. (2009): Decentralised Wastewater Treatment Systems (DEWATS) and Sanitation in Developing Countries. WEDC, Loughborough, UK.
- Morel, A., Diener, S. (2006): Greywater Management in Low and Middle-Income Countries, Review of Different Treatment Systems for Households or Neighborhoods. EAWAG, Dübendorf, Switzerland.

**Low-cost, decentralised wastewater management and efficient resource recovery:**

- Rose, D. G. (1999): Community-Based Technologies for Domestic Wastewater Treatment and Reuse-options for urban agriculture. International Development Research Center Canada (IDRC), Ottawa, Canada.

## T.4 Biogas Reactor

### Overview of technical and social information on Biogas Reactors:

- Mang, H.-P., Li, Z. (2010): Technology Review of Biogas Sanitation. GIZ, Eschborn, Germany.
- Cheng, S., Zifu L., Mang H.P., Huba, E.M., Gao, R. Wang, X. (2014): Development and application of prefabricated biogas digesters in developing countries, Renewable and Sustainable Energy Reviews.
- Ulrich, A., Reuter, S., Gutierrez, B., Sasse, L., Panzerbieter, T., Reckerzügel, T. (2009): Decentralised Wastewater Treatment Systems (DEWATS) and Sanitation in Developing Countries. WEDC, Loughborough, UK.
- Khataavkar, A., Matthews, S. (2013): Bio-Latrines. Practical Action East Africa, Nairobi, Kenya.

### Anaerobic digestion of biowaste:

- Vögeli, Y., Lohri, C. R., Gallardo, A., Diener, S. and Zurbrugg, C. (2014): Anaerobic Digestion of Biowaste in Developing Countries. Practical Information and Case Studies. Eawag, Dübendorf, Switzerland.

## T.5 Waste Stabilisation Ponds

### WSP design:

- Shilton, A. (2005): Pond Treatment Technology. Integrated Environmental Technology Series. IWA Publishing, London, UK.
- Von Sperling, M. (2007): Waste Stabilisation Ponds. Biological Wastewater Treatment Series. IWA Publishing, London, UK.
- Von Sperling, M., De Lemos Chernicharo, C. A. (2005): Biological Wastewater Treatment in Warm Climate Regions. IWA Publishing, London, UK.
- Kayombo, S., Mbvette, T. S. A., Katima, J. H. Y., Ladegaard, N., Jorgensen, S. E. (2004): Waste Stabilization Ponds and Constructed Wetlands Design Manual. UNEP-IETC/Danida, Dar es Salaam, Tanzania.

## T.6 Constructed Wetland

### Practical issues and case studies:

- Dotro G., Langergraber G., Nivala J., Pui-gagut J., Stein O.R., Von Sperling, M. (2017): Biological Wastewater Treatment Series. IWA Publishing, London, UK.
- Muellegger, E., Langergraber, G., Lechner, M. (2012): Treatment wetlands. EcoSan Club, Austria.

### Review on treatment wetlands and suitable plants:

- Hoffmann, H., Platzer, C., Winker, M., Von Muench, E. (2011): Technology review of constructed wetlands. Subsurface flow constructed wetlands for greywater and domestic wastewater treatment. GIZ, Eschborn, Germany.

- Groupe Macrophytes (2005) : Épuration des Eaux Usées Domestiques par Filtrés Plantés de Macrophytes. Recommandations Techniques pour la Conception et la Réalisation. Cemagref - Agence de l'Eau RM & C, France.

## T.7 Trickling Filter

### Design information and example calculations:

- Tchobanoglous, G., Burton, F. L., Stensel, H. D. (2004): Wastewater Engineering: Treatment and Reuse. Metcalf & Eddy, New York, US.
- Ulrich, A., Reuter, S., Gutierrez, B., Sasse, L., Panzerbieter, T., Reckerzügel, T. (2009): Decentralised Wastewater Treatment Systems (DEWATS) and Sanitation in Developing Countries – A Practical Guide. WEDC, Loughborough, UK.
- U.S. EPA (2000): Wastewater Technology Fact Sheet. Trickling Filters. Environmental Protection Agency, Washington D.C., US

## T.8 Sedimentation and Thickening Ponds

### General design information:

- Strande, L., Ronteltap, M., Brdjanovic, D. (2014): Faecal Sludge Management. Systems Approach for Implementation and Operation. IWA Publishing, London, UK.
- Heinss, U., Larmie, S. A., Strauss, M. (1999): Characteristics of Faecal Sludges and Their Solids-Liquid Separation. Eawag, Dübendorf, Switzerland.

## T.9 Unplanted Drying Beds

### General design information:

- Strande, L., Ronteltap, M., Brdjanovic, D. (2014): Faecal Sludge Management. Systems Approach for Implementation and Operation. IWA Publishing, London, UK.
- Tchobanoglous, G., Burton, F. L., Stensel, H. D. (2004): Wastewater Engineering: Treatment and Reuse. Metcalf & Eddy, New York, US.

## T.10 Planted Drying Beds

### General design information:

- Strande, L., Ronteltap, M., Brdjanovic, D. (2014): Faecal Sludge Management. Systems Approach for Implementation and Operation. IWA Publishing, London, UK.
- Tchobanoglous, G., Burton, F. L., Stensel, H. D. (2004): Wastewater Engineering: Treatment and Reuse. Metcalf & Eddy, New York, US.

## T.11 Co-Composting

### Information on co-composting and thermophilic composting:

- Strauss, M., Drescher, S., Zurbrugg, C., Montangero, A., Olufunke, C., Drechsel, P. (2003): Co-composting of Faecal Sludge and Municipal Organic Waste. Eawag, Dübendorf, Switzerland.
- Kramer, S., Preneta, N., Kilbride, A. (2013): Thermophilic composting of human wastes in uncertain urban environments: a case study from Haiti. Sustainable Organic Integrated Livelihoods (SOIL), Oakland, Haiti.
- Rothenberger, S., Zurbrugg, C., Enayetullah, I., Sinha, A.H.M. (2006): Decentralised Composting For Cities Of Low-And Middle-Income. Countries A Users' Manual. Waste Concern, Dhaka, Bangladesh.

### Guidelines to refer to regarding the safe use of co-compost:

- WHO (2006): WHO Guidelines for the safe use of wastewater, excreta and greywater. Geneva, Switzerland.

## T.12 Vermicomposting and Vermifiltration (E)

### Development and trialling of Vermicomposting and Vermifiltration:

- Furlong C., et al. (2015): The development of an onsite sanitation system based on vermifiltration: the 'tiger toilet'. Journal of WASH for Development, Loughborough, UK.
- Furlong, C., Gibson, W. T., Oak, A., Patankar, R. (2015b): Faecal sludge treatment by vermifiltration: proof of concept. Loughborough, UK.
- Eastman, B. R., Kane, P. N., Edwards, C. A., Trytek, L., Gunadi, B., Stermer, A. L., Mobley, J. R. (2001): The effectiveness of vermiculture in human pathogen reduction for USEPA biosolids stabilization. Compost Science & Utilization.
- Furlong, C., Templeton, M. R., Gibson, W. T. (2014): Processing of human faeces by wet vermifiltration for improved on-site sanitation. Journal of WASH for Development, Loughborough, UK.

## T.13 Activated Sludge

### Design recommendations for Activated Sludge treatment:

- Heinss, U., Larmie, S. A., Strauss, M. (1998): Solids Separation and Pond Systems for the Treatment of Faecal Sludges in the Tropics. Eawag, Dübendorf, Switzerland.
- Heinss, U., Larmie, S. A., Strauss, M. (1999): Characteristics of Faecal Sludges and Their Solids-Liquid Separation. Eawag, Dübendorf, Switzerland.
- Strande, L., Ronteltap, M., Brdjanovic, D. (2014): Faecal Sludge Management. Systems Approach for Implementation and Operation. IWA Publishing, London, UK.

## POST Tertiary Filtration and Disinfection

### Design considerations in different contexts:

- Tchobanoglous, G., Burton, F. L., Stensel, H. D. (2004): Wastewater Engineering: Treatment and Reuse. Metcalf & Eddy, New York, US.
- Robbins, D. M., Ligon, G.C. (2014): How to Design Wastewater Systems for Local Conditions in Developing Countries. IWA Publishing, London, UK.
- NWRI (2012): Ultraviolet Disinfection. Guidelines for Drinking Water and Water Reuse. California, US.

### Guidelines for the safe use of sanitation products:

- WHO (2006): Guidelines for the Safe Use of Wastewater, Excreta and Greywater. Volume IV: Wastewater Use in Agriculture. Geneva, Switzerland.

## D.1 Application of Urine

### Guidelines for urine use in agriculture:

- Richert, A., Gensch, R., Jönsson, H., Stenström, T.-A., Dagerskog, L. (2011): Practical Guidance on the Use of Urine in Crop Production, SEI, Stockholm, Sweden.
- Gensch, R., Miso, A., Itchon, G. (2011): Urine as a Liquid Fertilizer in Agricultural Production in the Philippines. Xavier University Press, Cagayan de Oro, Philippines.
- WHO (2006): Guidelines for the Safe Use of Wastewater, Excreta and Greywater. Volume IV: Wastewater Use in Agriculture. Geneva, Switzerland.

## D.2 Application of Dried Faeces

### Guidelines for the safe use of faeces and urine:

- WHO (2006): Guidelines for the Safe Use of Wastewater, Excreta and Greywater. Volume IV: Wastewater Use in Agriculture. Geneva, Switzerland.
- Schönning, C., Stenström, T. A. (2004): Guidelines for the Safe Use of Urine and Faeces in Ecological Sanitation Systems. SEI, Stockholm, Sweden.

### Information on ecological sanitation:

- Austin, A., Duncker, L. (2002): Urine-Diversion. Ecological Sanitation Systems in South Africa. CSIR, Pretoria, South Africa.
- Rieck, C., Von Münch, E., Hoffmann, H. (2012): Technology Review of Urine-Diverting Dry Toilets (UDDTs). Overview of Design, Operation, Management and Costs. GIZ, Eschborn, Germany.
- Winblad, U., Simpson-H., M. (2004): Ecological Sanitation. SEI, Stockholm, Sweden.

## D.3 Application of Pit Humus and Compost

### Information on compost production, gardening and growing vegetables in refugee camps:

- SOILS Publications (2016): An Illustrated Guide for Vegetable Micro-Gardens in Refugee Camps (In Arabic).
- Adam-Bradford, A., Tomkins, M., Perkins, C., van Veenhuizen, R., Binego, L., Hunt, S., Belton, J. (2016): Transforming Land, Transforming Lives: Greening Innovation and Urban Agriculture in the Context of Forced Displacement. Lemon Tree Trust, Dallas, US.
- Jenkins, J. (2005): A Guide to Composting Human Manure. Jenkins Publishing, PA, US.
- Morgan, P. R. (2007): Toilets That Make Compost. SEI, Stockholm, Sweden.

## D.4 Application of Sludge

### Guidelines for the safe reuse of sludge:

- WHO (2006): Guidelines for the Safe Use of Wastewater, Excreta and Greywater. Volume IV: Wastewater Use in Agriculture. Geneva, Switzerland.

### Use of sludge from wastewater treatment plants:

- European Commission (2016): Sewage Sludge. EU
- EPA (1999): Biosolids Generation, Use, and Disposal in the United States. U.S. Environmental Protection Agency, Washington, D.C., US.
- EPA (1994): A Plain English Guide to the EPA Part 503 Biosolids Rule. U.S. Environmental Protection Agency, Washington, D.C., US.
- Strande, L., Ronteltap, M., Brdjanovic, D. (2014): Faecal Sludge Management. Systems Approach for Implementation and Operation. IWA Publishing, London, UK.

## D.5 Fill and Cover: Arborloo and Deep Row Entrenchment

### Information on Arborloos:

- Hebert, P. (2010): Rapid Assessment of CRS Experience with Arborloos in East Africa. Catholic Relief Service (CRS), Baltimore, US.
- Morgan, P. R. (2007): Toilets That Make Compost. Low-Cost, Sanitary Toilets That Produce Valuable Compost for Crops in an African Context. SEI, Stockholm, Sweden.
- Morgan, P. R. (2009): Ecological Toilets. Start Simple and Upgrade from Arborloo to VIP. SEI, Stockholm, Sweden.

### Information on Deep Row Entrenchment:

- Still D., Louton B., Bakare B., Taylor C., Foxon K., Lorentz S. (2012): Investigating the Potential of Deep Row Entrenchment of Pit Latrine and Waste Water Sludges for Forestry and Land Rehabilitation Purposes. WRC, South Africa.

- Strande, L., Ronteltap, M., Brdjanovic, D. (2014): Faecal Sludge Management. Systems Approach for Implementation and Operation. IWA Publishing, London, UK.

## D.6 Surface Disposal and Sanitary Landfill

### Information on faecal sludge management, bio-solids treatment and management:

- Strande, L., Ronteltap, M., Brdjanovic, D. (2014): Faecal Sludge Management. Systems Approach for Implementation and Operation. IWA Publishing, London, UK.
- EPA (1999). Biosolids Generation, Use, and Disposal in the United States. U.S. Environmental Protection Agency, Washington, D.C., US.

### Design guidelines for sanitary landfills with focus on siting criteria:

- Cointreau, S. (2004): Sanitary Landfill Design and Siting Criteria. Washington, DC, US.

## D.7 Use of Biogas

### Guidance on biogas applications and basics of cooking with biogas:

- Fulford, D. (1996): Biogas Stove Design. A short course. Kingdom Bioenergy Ltd., University of Reading, UK.
- Deublein, D., Steinhauser, A. (2011): Biogas from Waste and Renewable Resources. Wiley-VCH, Weinheim, Germany.
- GIZ (n.Y.): GIZ HERA Cooking Energy Compendium – A practical guidebook for implementers of cooking energy interventions. Eschborn, Germany.

## D.8 Co-Combustion of Sludge

### General information on co-combustion:

- Kengne, I., Diaz-A., B. M., Strande, L. (n.Y.): Faecal Sludge Management: Systems Approach for Implementation and Operation (Chapter 10.6.4.). Eawag, Dübendorf, Switzerland.

## D.9 Leach Field

### Information on Leach Fields for wastewater and greywater treatment:

- Crites, R., Tchobanoglous, G. (1998): Small and Decentralized Wastewater Management Systems. WCB/McGraw-Hill, New York, US.
- Morel, A., Diener, S. (2006): Greywater Management in Low and Middle-Income Countries. Eawag, Dübendorf, Switzerland.
- Polprasert, C., Rajput, V. S. (1982): Environmental Sanitation Reviews: Septic Tank and Septic Systems. Environmental Sanitation Information Center, AIT, Bangkok, Thailand.

- EPA (1980): Onsite Wastewater Treatment and Disposal Systems. U.S. Environmental Protection Agency, Cincinnati, US.

## D.10 Soak Pit

### Detailed construction instructions and dimensioning:

- Ahrens, B. (2005): A Comparison of Wash Area and Soak Pit Construction: The Changing Nature of Urban, Rural, and Peri-Urban Linkages in Sikasso, Mali. Peace Corps, US.
- Mara, D. D. (1996): Low-Cost Urban Sanitation. Wiley, Chichester, UK.
- Oxfam (2008): Septic Tank Guidelines. Technical Brief. Oxfam, Oxford, UK.
- Polprasert, C., Rajput, V. S. (1982): Environmental Sanitation Reviews. Septic Tank and Septic Systems. Environmental Sanitation Information Center, AIT, Bangkok, Thailand.

## D.11 Irrigation

### Guidelines for the safe use of wastewater in irrigation:

- WHO (2006): Guidelines for the Safe Use of Wastewater, Excreta and Greywater. Volume 2: Wastewater Use in Agriculture. Geneva, Switzerland.
- Palada, M., Bhattarai, S., Wu, D., Roberts, M., Bhattarai, M., Kimsan, R., Midmore, D. (2011): More Crop Per Drop. Using Simple Drip Irrigation Systems for Small-Scale Vegetable Production. World Vegetable Center, Shanhua, Taiwan.

### Information on various irrigation techniques:

- Pescod, M. B. (1992): Wastewater Treatment and Use in Agriculture. FAO Irrigation and Drainage. FAO, Rome, Italy.

## D.12 Water Disposal and Groundwater Recharge

### Detailed information on Groundwater Recharge and Water Disposal:

- Seiler, K. P., Gat, J. R. (2007): Groundwater Recharge from Run-off, Infiltration and Percolation. Springer, Dordrecht, Netherlands.
- Tchobanoglous, G., Burton, F. L., Stensel, H. D. (2004): Wastewater Engineering: Treatment and Reuse, Metcalf & Eddy, McGraw-Hill, New York, US.

### Guidelines for safe reuse of wastewater:

- WHO (2006): Guidelines for the Safe Use of Wastewater, Excreta and Greywater. Volume 3: Wastewater and Excreta Use in Aquaculture. Geneva, Switzerland.
- ARGOSS (2001): Guidelines for Assessing the Risk to Groundwater from on-Site Sanitation. British Geological Survey Commissioned, Keyworth, UK.

## D.13 Fish Ponds

### General information on aquaculture:

- Cross, P., Strauss, M. (1985): Health Aspects of Nightsoil and Sludge Use in Agriculture and Aquaculture. International Reference Centre for Waste Disposal, Dübendorf, Switzerland.
- Iqbal, S. (1999): Duckweed Aquaculture. Potentials, Possibilities and Limitations for Combined Wastewater Treatment and Animal Feed Production in Developing Countries. Eawag-Sandec, Dübendorf, Switzerland.
- Mara, D. D. (2003): Domestic Wastewater Treatment in Developing Countries. Earthscan, London, UK.

### Guidelines for the safe reuse of wastewater and excreta in aquaculture:

- WHO (2006): Guidelines for the Safe Use of Wastewater, Excreta and Greywater. Volume 3: Wastewater and Excreta Use in Aquaculture. World Health Organization, Geneva, Switzerland.

## X.1 Basic Assessment Requirements

- IASC (2003): Initial Rapid Assessment (IRA) Guidance Notes for Country Level. Geneva, CH.
- Harvey, P. A. (2007): Excreta Disposal in Emergencies – A Field Manual. WEDC, Loughborough, UK.
- Strande, L., Ronteltap M., Brdjanovic, D. (2014): Faecal Sludge Management. Systems Approach for Implementation and Operation. IWA Publishing London, UK.
- UNHCR (2015): WASH Manual: WASH Needs Assessment. Geneva, Switzerland.
- The Sphere Project (2011): The Sphere Handbook: Humanitarian Charter and Minimum Standards in Disaster Response. Practical Action Publishing, Rugby, UK.

## X.3 Soil and Groundwater Assessment

- ARGOSS (2001): Guidelines for assessing the risk to groundwater from on-site sanitation. DFID & British Geological Survey, UK.
- Wolf, L., Nick, A., Cronin, A. (2015): How to keep your groundwater drinkable: Safer siting of sanitation systems - Working Group 11 Publication. Sustainable Sanitation Alliance (SuSanA).

## X.4 Institutional and Regulatory Environment

- Luethi, C., Morel, A., Tilley, E., Ulrich, L. (2011): Community-Led Urban Environmental Sanitation Planning: CLUES - Complete guidelines for decision-makers with 30 tools. Eawag, Dübendorf, Switzerland.
- Global WASH Cluster (2009): WASH Cluster Coordination Handbook. New York, US.

- Gensch, R., Hansen, R., Ihme, M. (2014): Linking Relief, Rehabilitation and Development in the WASH Sector. German WASH Network, Berlin, Germany.
- The Sphere Project (2015): The Core Humanitarian Standard and the Sphere Core Standards. Analysis and Comparison. Geneva, Switzerland.
- The Sphere Project (2011): The Sphere Handbook: Humanitarian Charter and Minimum Standards in Disaster Response. Practical Action Publishing, Rugby, UK.

## X.5 Resilience and Preparedness

- Gensch, R., Hansen, R., Ihme, M. (2014): Linking Relief, Rehabilitation and Development in the WASH Sector. German WASH Network, Berlin, Germany.
- Steets, J. (2011): Donor Strategies for Addressing the Transition Gap and Linking Humanitarian and Development Assistance. Global Public Policy Institute, Berlin, Germany.
- IFRC (2012): The road to resilience – Bridging relief and development for a more sustainable future. IFRC, Geneva, Switzerland.
- UNDP (2010): Disaster Risk Reduction and Recovery. UNDP Bureau for Crisis Prevention and Recovery, New York, US.

## X.6 Exit Strategy, Hand-over and Decommissioning of Infrastructure

- German Federal Foreign Office (2016): German Humanitarian WASH Strategy. Berlin, Germany.
- SuSanA (2008): Towards more sustainable sanitation solutions – SuSanA Vision Document. Eschborn, Germany.
- Harvey, P. A. (2007): Excreta Disposal in Emergencies. WEDC, Loughborough, UK.

## X.7 Urban Settings and Protracted Crisis Scenarios

- ICRC (2015): Urban services during protracted armed conflict – a call for a better approach to assisting affected people. IRFC, Geneva, Switzerland.

## X.8 Solid Waste Management

- UNEP (2015): Global Waste Management Outlook. Nairobi, Kenya.
- The Sphere Project (2011): Humanitarian Charter and Minimum Standards in Disaster Response. Geneva, CH.
- UNEP/OCHA Environment Unit (2011): Disaster Waste Management Guidelines. Geneva, CH.

- Hoorweg, D., Bhada-Tata, P. (2012): What a Waste. A Global Review of Solid Waste Management. World Bank, Washington D.C., US.

## X.9 Cholera Prevention and Epidemic Management

- UNICEF (2017): Cholera Toolkit. New York, US.
- UNICEF (2017): Guidelines for Water, Sanitation and Hygiene in Cholera Treatment Centres. UNICEF Somalia.
- WHO (1993): Guidelines for Cholera Control. Geneva, Switzerland.
- WHO (2006): Five keys to safer food manual, Geneva, Switzerland.

## X.10 Inclusive and Equitable Design

- Jones, H., Wilbur, J. (2014): Compendium of accessible WASH technologies. WEDC, WaterAid, Share, UK.
- Jones, H., Reed, B. (2005): Water and sanitation for disabled people and other vulnerable groups: Designing services to improve accessibility. WEDC, Loughborough, UK.
- House, S., Mahon, T., Cavill, S. (2012): Menstrual hygiene matters: A resource for improving menstrual hygiene around the world. WaterAid, UK.
- ADCAP Consortium (2016): Minimum Standards for Age and Disability Inclusion in Humanitarian Action. London, UK.
- CBM (2017): Humanitarian hands-on tools – step-by-step practical guidance on inclusive humanitarian field work. CBM, Germany.
- Centre for Universal Design (1997): The principles of universal design. NC University, US.
- DIAUD/ CBM (2016): The Inclusion Imperative: Towards Disability-Inclusive and Accessible Urban Development. Key Recommendations for an Inclusive Urban Agenda.
- Handicap International (2008): How to Build an Accessible Environment in Developing Countries. Manual 2 – Access to Water and Sanitation Facilities. Handicap International, France.
- UNICEF (upcoming): Including Children with Disabilities in Humanitarian Action – WASH guidance, United Nations Children’s Fund, New York.
- Columbia University, IRC (2017): Toolkit for Integrating Menstrual Hygiene Management into Humanitarian Response. Columbia University and International Rescue Committee

## X.11 Child Excreta Management

- WASHplus Weekly (2015): Management of Child Faeces: Current Disposal Practices. USAID.
- WSP, UNICEF (2015): Management of Child Faeces: Current Disposal Practices. Research Brief.
- Miller-P., M., Voigt, L., McLennan, L., Cairncross, S., Jenkind, M (2015): Infant and Young Children Faeces Management. WaterSHED/London School of Hygiene and Tropical Medicine, UK.

## X.12 Hygiene Promotion and Working with Affected Communities

- Clatworthy, D., Sommer, M., Schmitt, M. (2017): A Toolkit for integrating MHM into Humanitarian Response: The Full Guide. IRC/Columbia University, US.
- Davis Jr., Thomas P. (2010): Barrier Analysis Facilitator’s Guide: A Tool for Improving Behaviour Change Communication in Child Survival and Community Development Programmes. Food for the Hungry/Core Group Washington D.C., US.
- Ferron, S., Morgan, J., O’Reilly, M. (2007): Hygiene promotion: a practical manual for relief and development. ITDG Publishing, Rugby, UK.
- Mosler, H.-J., Contzen, N. (2016): Systematic behavior change in water, sanitation and hygiene. A practical guide using the RANAS approach. Eawag, Dübendorf, Switzerland.
- Neal D., Vujcic, J., Hernandez, O., Wood, W. (2015): The Science of Habit: Creating Disruptive and Sticky Behaviour Change in Handwashing Behaviour. USAID/WASHplus Project, Washington D.C., US.
- UNHCR (2017): Hygiene Promotion Guidelines. Geneva, Switzerland.

## X.13 Market-Based Programming

- EMMA (2017): Emergency Market Mapping and Analysis-Toolkit. Interagency Publication
- CaLP (n.Y.): Comparative table of humanitarian market analysis tools. The Cash Learning Partnership, Oxford, UK
- Juillard, H., Sloane, E. (2016): Revised Pre-Crisis Market Analysis (PCMA). IRC/ USAID/Oxfam.
- GTO (2017): Market Based Programming in Humanitarian WASH. German Toilet Organization, Berlin, Germany.
- Devine, J., Kullmann, C. (2011): WSP Scaling Up Rural Sanitation. Introductory Guide to Sanitation Marketing. The World Bank/ WSP.
- SEEP (2010): Minimum Economic Recovery Standards. The SEEP Network, Washington D.C., US.

- Global WASH Cluster (2016): Cash and Markets In The WASH Sector – A Global Wash Cluster Position Paper. Geneva, Switzerland.
- Ahmed, M., Hrybyk, A. (2016): Pintakasi Study – A Review of Shelter/WASH Delivery Methods in Post-Disaster Recovery Interventions. Catholic Relief Services, Philippines.
- CRS (2017): Updated Market-Based Programming Framework, Catholic Relief Service

# Bibliographic References

Gensch, R., Jennings, A., Renggli, S., Reymond, P. (2018). Compendium of Sanitation Technologies in Emergencies. German WASH Network (GWN), Swiss Federal Institute of Aquatic Science and Technology (Eawag), Global WASH Cluster (GWC) and Sustainable Sanitation Alliance (SuSanA). Berlin, Germany. ISBN: 978-3-906484-68-6

© German WASH Network ([www.washnet.de](http://www.washnet.de)) and Eawag, Department of Sanitation, Water and Solid Waste for Development ([www.sandec.ch](http://www.sandec.ch))

Permission is granted for reproduction of this material, in whole or part, for education, scientific, humanitarian or development related purposes except those involving commercial sale, provided that full citation of the source is made.

The Compendium of Sanitation Technologies in Emergencies is also available as an interactive online version. The online version is a capacity building tool of the Global WASH Cluster (GWC) hosted by the Sustainable Sanitation Alliance (SuSanA).

 [www.washcluster.net/emersan-compendium](http://www.washcluster.net/emersan-compendium)

## **Graphic Design and Layout:**

Buntesamt (Layout), Monacografico (Graphics) and Cornelia Wiekort (Cover Design)

**Text Editing:** Patrick Bracken, Heidi Johnston

**First Edition:** 2,000 Copies

**Printed by:** Buch- und Offsetdruckerei H. Heenemann, Berlin, Germany

This publication has been developed to assist those working in humanitarian assistance where resources, including time, may be limited due to the urgency of their work. It is intended to support decision making and is a complement to, not a substitute for, sound professional judgement. The authors and publishers do not guarantee, and accept no legal liability of whatever nature arising from or connected to the content of this publication.



German WASH Network  
c/o German Toilet Organization  
Paulsenstr. 23  
12163 Berlin, Germany  
info@washnet.de  
www.washnet.de

Eawag  
Department Sandec  
Überlandstr. 133  
8600 Dübendorf, Switzerland  
info@sandec.ch  
www.eawag.ch & www.sandec.ch

Appropriate and adequate sanitation solutions are crucial for the protection of human health in emergencies. In recent years there has been an increasing number of sanitation innovations, appropriate for a variety of humanitarian contexts and a stronger sector focus on the entire sanitation service chain (from the toilet via collection and conveyance to the final treatment and safe disposal and/or reuse).

Building on these developments, the Compendium of Sanitation Technologies in Emergencies provides a comprehensive, structured and user-friendly manual and planning guide for sanitation solutions in emergency settings. It compiles a wide range of information on tried and tested technologies in a single document and gives a systematic overview of existing and emerging sanitation technologies.

This publication is primarily a capacity building tool and reference book. In addition, it supports and enables decision making by providing the necessary framework for developing a sanitation system design. It gives concise information on key decision criteria for each technology, facilitating the combination of technologies to come up with full sanitation system solutions. Furthermore this compendium prioritises linking the sanitation technology selection with relevant cross-cutting issues, thereby promoting access to safe sanitation for all.

 [www.washcluster.net/emersan-compendium](http://www.washcluster.net/emersan-compendium)

With support from:



ISBN: 978-3-906484-68-6