



ULTRAVIOLET DISINFECTION GUIDANCE MANUAL FOR THE FINAL LONG TERM 2 ENHANCED SURFACE WATER TREATMENT RULE

Office of Water (4601)
EPA 815-R-06-007
November 2006

U.S. Environmental Protection Agency
Office of Water (4601)
1200 Pennsylvania Avenue NW
Washington, DC 20460
EPA 815-R-06-007

<http://www.epa.gov/safewater/disinfection/lt2/compliance.html>

November 2006

Purpose:

The purpose of this guidance manual is solely to provide technical information on the application of ultraviolet light for the disinfection of drinking water by public water systems. This guidance is not a substitute for applicable legal requirements, nor is it a regulation itself. Thus, it does not impose legally-binding requirements on any party, including EPA, states, or the regulated community. Interested parties are free to raise questions and objections to the guidance and the appropriateness of using it in a particular situation. Although this manual covers many aspects of implementing a UV disinfection system, it is not comprehensive in terms of all types of UV systems, design alternatives, and validation protocols that may provide satisfactory performance. The mention of trade names or commercial products does not constitute endorsement or recommendation for use.

Authorship:

This manual was developed under the direction of EPA's Office of Water, and was prepared by Malcolm Pirnie, Inc., Carollo Engineers, P.C., The Cadmus Group, Inc., Dr. Karl G. Linden, and Dr. James P. Malley, Jr. Questions concerning this document should be addressed to:

Dan Schmelling
U.S. Environmental Protection Agency
Mail Code 4607M
1200 Pennsylvania Avenue NW
Washington, DC 20460-0001
Tel: (202) 564-5281
Fax: (202) 564-3767
Email: schmelling.dan@epa.gov

Acknowledgements:

This document was prepared by the United States Environmental Protection Agency, Office of Water. The Work Assignment Manager was Daniel Schmelling, and the Contract Project Officer was Jane Holtorf. Technical consultants played a significant role in the development of this document. The work was conducted jointly by Malcolm Pirnie, Inc and Carollo Engineers, P.C. under contract with The Cadmus Group, Inc. The primary contributors to the document included:

- Daniel Schmelling (USEPA)
- Christine Cotton and Douglas Owen (Malcolm Pirnie)
- Erin Mackey and Harold Wright (Carollo Engineers)
- Karl Linden (Duke University)
- James Malley, Jr. (University of New Hampshire)

Other contributors included Laurel Passantino, Amy Samuelson, Matthew Yonkin, and James Collins (Malcolm Pirnie); Dennis Greene, Trinia Dzurny and Stuart Hurley (Carollo Engineers); Laura Dufresne (The Cadmus Group, Inc.); and Maureen Donnelly and James Melstad (previously of The Cadmus Group, Inc.).

The following provided valuable technical information to assist in the development of this manual:

American Water Works Association
Jim Bolton (Executive Director, International Ultraviolet Association)
Calgon Carbon Corporation
David Cornwell (Environmental Engineering and Technology)
Steven Deem (Washington Department of Health)
Joel DuCoste (North Carolina State University)
Tom Hargy (Clancy Environmental Consultants)
Oluf Hoyer (DVGW)
Richard Hubel (West Yost & Associates)
Chris McMeen (then with Washington Department of Health)
Alexander Mofidi (Metropolitan Water District of Southern California)
Mike Montysko (State of New York)
Issam Najm (Water Quality and Treatment Solutions, Inc.)
Ondeo Degremont
Jeffrey Rosen (Clancy Environmental Consultants, Inc.)
Richard Sakaji (California Department of Health Services)
Severn Trent Services
Regina Sommer (University of Vienna)
Paul Swaim (CH2M Hill)
Trojan Technologies, Inc.
Matthew Valade (Hazen and Sawyer)
WEDECO UV Technologies, Inc.

Table of Contents

Table of Contents	i
List of Figures	vii
List of Tables	ix
List of Examples	x
List of Checklists	x
Glossary	xi
List of Units, Abbreviations, and Acronyms	xxi
1. Introduction	1-1
1.1 Guidance Manual Objectives.....	1-2
1.2 Organization.....	1-2
1.3 Regulations Summary.....	1-3
1.3.1 Filtered PWSs	1-4
1.3.2 Unfiltered PWSs	1-6
1.3.3 PWSs with Uncovered Finished Water Storage Facilities.....	1-6
1.4 UV Disinfection Requirements for Filtered and Unfiltered PWSs.....	1-6
1.4.1 UV Dose and Validation Testing Requirements.....	1-6
1.4.2 UV Disinfection Monitoring Requirements [40 CFR 141.720(d)(3)(i)]	1-8
1.4.3 UV Disinfection Reporting Requirements [40 CFR 141.721(f)(15)]	1-8
1.4.4 Off-specification Operational Requirement for Filtered and Unfiltered Systems [40 CFR 141.720(d)(3)(ii)]	1-8
1.5 Regulations Timeline.....	1-9
1.6 Alternative Approaches for Disinfecting with UV Light	1-9
2. Overview of UV Disinfection	2-1
2.1 History of UV Light for Drinking Water Disinfection.....	2-1
2.2 UV Light Generation and Transmission.....	2-2
2.2.1 Nature of UV Light.....	2-2
2.2.2 Propagation of UV Light.....	2-3
2.3 Microbial Response to UV Light.....	2-6
2.3.1 Mechanisms of Microbial Inactivation by UV Light.....	2-6
2.3.2 Microbial Repair	2-8
2.3.2.1 Photorepair	2-8
2.3.2.2 Dark Repair	2-9
2.3.3 UV Intensity, UV Dose, and UV Dose Distribution.....	2-9
2.3.4 Microbial Response (UV Dose-Response)	2-11
2.3.5 Microbial Spectral Response	2-13
2.4 UV Disinfection Equipment	2-14
2.4.1 UV Reactor Configuration.....	2-15
2.4.2 UV Lamps	2-16
2.4.2.1 Lamp Start-up	2-19
2.4.2.2 Lamp Output	2-19
2.4.2.3 Lamp Sensitivity to Power Quality	2-21
2.4.2.4 Lamp Aging	2-22
2.4.3 Ballasts	2-24
2.4.4 Lamp Sleeves	2-25

2.4.5	Cleaning Systems	2-27
2.4.6	UV Sensors	2-28
2.4.7	UVT Analyzers	2-29
2.4.8	Temperature Sensors	2-30
2.4.9	UV Reactor Dose-Monitoring Strategy	2-31
2.5	Water Quality Effects and Byproduct Formation	2-31
2.5.1	Effect of Water Quality on UV Reactor Performance	2-32
2.5.1.1	UVT	2-32
2.5.1.2	Particle Content	2-32
2.5.1.3	Upstream Water Treatment Processes	2-32
2.5.1.4	Fouling Potential	2-34
2.5.1.5	Algal Occurrence and Growth	2-36
2.5.2	Chlorine Reduction through UV Reactors	2-36
2.5.3	Byproducts from UV Disinfection	2-37
2.5.3.1	Trihalomethanes, Haloacetic Acids, and Total Organic Halides	2-37
2.5.3.2	Biodegradable Compounds	2-37
2.5.3.3	Nitrite	2-37
3.	Planning Analyses for UV Facilities	3-1
3.1	UV Disinfection Goals	3-1
3.2	Evaluating Integration of UV Disinfection into the Treatment Process	3-3
3.2.1	UV Disinfection Effects on Treatment	3-3
3.2.2	Upstream Treatment Process Effect on UV Disinfection	3-4
3.3	Identifying Potential Locations for UV Facilities	3-5
3.3.1	Installation Locations for Filtered Systems	3-5
3.3.1.1	Combined Filter Effluent Installation (Upstream of the Clearwell)	3-5
3.3.1.2	Individual Filter Effluent Piping Installation	3-6
3.3.1.3	UV Disinfection Downstream of the Clearwell	3-8
3.3.2	Unfiltered System Installation Locations	3-9
3.3.3	Groundwater System Installation Locations	3-10
3.3.4	Uncovered Reservoir Installation Locations	3-10
3.4	Defining Key Design Parameters	3-10
3.4.1	Off-specification Requirements	3-10
3.4.2	Target Pathogen Inactivation and Required UV Dose	3-12
3.4.3	Design Flow Rate	3-12
3.4.4	Water Quality	3-12
3.4.4.1	UVT and UVT Scans	3-13
3.4.4.2	Water Quality Parameters That Affect Fouling	3-18
3.4.4.3	Additional Water Quality Considerations for Unfiltered Supplies and Treatment of Uncovered Reservoir Water	3-19
3.4.5	Fouling/Aging Factor	3-21
3.4.5.1	Testing to Determine the Fouling Factor	3-22
3.4.5.2	Testing to Determine the Aging Factor	3-23
3.4.6	Power Quality Evaluations	3-25
3.5	Evaluating UV Reactors, Dose Monitoring Strategy, and Operational Approach	3-26
3.5.1	Characteristics of LPHO and MP Reactors	3-26
3.5.2	Dose-monitoring Strategy and Operational Approach	3-27
3.5.2.1	UV Intensity Setpoint Approach	3-28

3.5.2.2	Calculated Dose Approach.....	3-29
3.5.2.3	Advantages and Disadvantages.....	3-30
3.6	Assessing UV Equipment Validation Issues	3-31
3.6.1	Off-site Versus On-site Validation.....	3-31
3.6.2	Validation and Installation Hydraulics Recommendations.....	3-32
3.6.3	Selection of Validation and Hydraulic Approach	3-33
3.7	Assessing Head Loss Constraints	3-35
3.7.1	Eliminating Existing Hydraulic Inefficiencies.....	3-35
3.7.2	Modifying Clearwell Operation.....	3-35
3.7.3	Modifying Filter Operation.....	3-36
3.7.4	Installing Intermediate Booster Pumps	3-36
3.7.5	Modifying Operation of HSPs	3-36
3.8	Estimating UV Facility Footprint.....	3-36
3.8.1	UV Equipment Constraints	3-36
3.8.2	Develop UV Facility Layout.....	3-37
3.9	Preparing Preliminary Costs and Selecting the UV Facility Option	3-38
3.10	Reporting to the State	3-38
4.	Design Considerations for UV Facilities	4-1
4.1	UV Facility Hydraulics.....	4-2
4.1.1	Inlet and Outlet Piping Configuration.....	4-3
4.1.2	Flow Distribution, Control, and Measurement	4-3
4.1.2.1	Flow Distribution and Control	4-3
4.1.2.2	Flow Rate Measurement	4-3
4.1.3	Water Level Control.....	4-5
4.1.4	Air Relief and Pressure Control Valves.....	4-6
4.1.5	Flow Control and Isolation Valves	4-6
4.1.6	Installation of Intermediate Booster Pumps.....	4-6
4.1.7	Evaluating Existing Pumps and Potential Water Hammer Issues.....	4-7
4.1.8	Groundwater System Hydraulic Issues	4-7
4.1.9	Uncovered Finished Water Reservoir Hydraulic Issues	4-8
4.2	Operating Approach Selection.....	4-8
4.3	Instrumentation and Control.....	4-9
4.3.1	UV Reactor Start-up and Sequencing	4-9
4.3.1.1	UV Reactor Start-up.....	4-10
4.3.1.2	UV Reactor Sequencing.....	4-10
4.3.1.3	Groundwater Pump Cycling Effects on UV Reactor Start-up	4-11
4.3.2	UV Equipment Automation	4-11
4.3.3	Alarms and Control Systems Interlocks.....	4-12
4.3.4	UV Reactor Control Signals	4-12
4.3.4.1	UV Intensity.....	4-13
4.3.4.2	UV Transmittance	4-13
4.3.4.3	Flow Rate Measurement	4-14
4.3.4.4	Calculated and Validated UV Dose (If Applicable)	4-14
4.3.4.5	Operational Setpoints.....	4-14
4.3.4.6	Lamp Age.....	4-14
4.3.4.7	Lamp Power, Lamp Status, and Reactor Status	4-14
4.3.4.8	UV Reactor Sleeve Cleaning	4-14

4.3.4.9	Alarms	4-15
4.4	Electrical Power Configuration and Back-up Power	4-15
4.4.1	Considerations for Electrical Power	4-15
4.4.2	Back-up Power Supply and Power Conditioning	4-15
4.4.2.1	Back-up Power Supply	4-16
4.4.2.2	Power Conditioning Equipment	4-16
4.4.3	Ground Fault Interrupt and Electrical Lockout	4-17
4.5	UV Facility Layout	4-17
4.5.1	Additional Considerations for Unfiltered and Uncovered Reservoir UV Facility Layouts	4-18
4.5.2	Additional Considerations for Groundwater UV Facility Layouts	4-19
4.6	Elements of UV Equipment Specifications	4-19
4.6.1	UV Equipment Specification Components	4-19
4.6.2	Information Provided by Manufacturer in UV Reactor Bid	4-22
4.7	Final UV Facility Design	4-23
4.8	Reporting to the State during Design	4-24
5.	Validation of UV Reactors	5-1
5.1	Minimum Requirements for Validation Testing	5-2
5.2	Overview of the Recommended Validation Protocol	5-3
5.2.1	Key Steps in Recommended Validation Protocol	5-3
5.2.2	Alternative Validation Protocols	5-6
5.2.3	Third Party Oversight	5-6
5.2.4	Emerging Methods	5-7
5.3	Selecting the Challenge Microorganism	5-7
5.4	Equipment Needs for Full-scale Reactor Testing	5-9
5.4.1	Water Source	5-9
5.4.2	UV Absorbing Chemical	5-10
5.4.3	Mixing	5-10
5.4.4	Sampling Ports	5-11
5.4.5	Configuration of Inlet and Outlet Piping	5-12
5.4.6	Accounting for Non-uniform Lamp Aging	5-12
5.4.7	Lamp Positioning to Address Lamp Variability	5-14
5.4.8	UV Sensors	5-14
5.4.9	UV Sensor Port Windows	5-15
5.5	Accuracy of Measurement Equipment	5-15
5.5.1	Flow Meters	5-18
5.5.2	UV Spectrophotometers	5-18
5.5.3	Power Measurements	5-19
5.5.4	UV Sensors	5-19
5.6	Identifying Test Conditions	5-20
5.6.1	Test Conditions for the UV Intensity Setpoint Approach	5-22
5.6.2	Test Conditions for the Calculated Dose Approach	5-23
5.6.3	Test Conditions for Confirming an Existing Validation Equation	5-26
5.6.4	Quality-control Samples	5-26
5.7	Guidelines for Conducting Experimental Tests	5-27
5.7.1	Preparing the Challenge Microorganism	5-27

5.7.2	Full-scale UV Reactor Testing.....	5-28
5.7.3	Collimated Beam Testing.....	5-30
5.8	Analyzing Experimental Data.....	5-30
5.8.1	Calculating the Reduction Equivalent Dose (RED).....	5-30
5.8.2	Selecting the Minimum RED for the UV Intensity Setpoint Approach	5-34
5.8.3	Developing the Dose-monitoring Equation for the Calculated Dose Approach.....	5-34
5.9	Deriving the Validation Factor (VF)	5-36
5.9.1	RED Bias Factor	5-37
5.9.2	Uncertainty in Validation (U_{Val})	5-38
5.9.2.1	Calculating U_{SP} for the UV Intensity Setpoint Approach.....	5-41
5.9.2.2	Calculating U_{IN} for the Calculated Dose Approach.....	5-41
5.10	Determining the Validated Dose and Validated Operating Conditions.....	5-42
5.10.1	Determining the Validated Dose and Operating Conditions for the UV Intensity Setpoint Approach.....	5-42
5.10.2	Determining the Validated Dose and Operating Conditions for the Calculated Dose Approach.....	5-43
5.11	Documentation.....	5-44
5.11.1	UV Reactor Documentation.....	5-44
5.11.2	Validation Test Plan.....	5-46
5.11.3	Validation Report.....	5-48
5.12	Guidelines for Reviewing Validation Reports.....	5-50
5.13	Evaluating the Need for “Re-validation”.....	5-54
6.	Start-up and Operation of UV Facilities.....	6-1
6.1	UV Facility Start-up.....	6-1
6.1.1	O&M Manual.....	6-1
6.1.2	State Coordination during Start-up	6-3
6.1.3	Functional Testing.....	6-3
6.1.3.1	Verification of UV Equipment Components.....	6-4
6.1.3.2	Verification of Instrumentation and Control Systems	6-5
6.1.3.3	Verification of Flow Distribution and Head Loss.....	6-6
6.1.4	Determining Validated Operational Conditions and Setting Operational Controls.....	6-7
6.1.5	Performance Testing	6-10
6.1.6	Final Inspection.....	6-12
6.2	Operation of UV Facilities.....	6-12
6.2.1	Operational Requirements.....	6-13
6.2.2	Recommended Operational Tasks.....	6-13
6.2.3	Start-up and Shut-down of UV Reactors	6-14
6.2.3.1	Routine Start-up.....	6-14
6.2.3.2	Start-up Following Maintenance.....	6-14
6.2.3.3	Routine Shut-down	6-15
6.2.3.4	Shut-down Prior to Maintenance	6-15
6.2.3.5	Winterization.....	6-15
6.3	Maintenance of UV Reactors.....	6-16
6.3.1	Summary of Recommended Maintenance Tasks.....	6-16
6.3.2	General Guidelines for UV Reactor Maintenance	6-18

6.3.2.1	Fouling	6-18
6.3.2.2	Lamp Output Variability	6-19
6.3.2.3	Reference UV Sensors	6-20
6.3.2.4	Electrical Concerns	6-20
6.3.2.5	UV Reactor Temperature and Water Level	6-21
6.3.2.6	UV Lamp Replacement.....	6-21
6.3.2.7	Lamp Sleeves	6-21
6.3.2.8	On-line UVT Analyzer.....	6-22
6.3.3	Spare Parts.....	6-22
6.4	Monitoring and Recording of UV Facility Operation	6-24
6.4.1	Monitoring and Recording for Compliance Parameters	6-24
6.4.1.1	Monitoring of Duty UV Sensor Calibration.....	6-24
6.4.1.2	Monitoring of UVT Analyzer Calibration	6-29
6.4.1.3	Off-specification Events.....	6-31
6.4.1.4	Monitoring and Recording Frequency of Required Parameters	6-32
6.4.2	Monitoring and Recording for Operational Parameters Not Related to Compliance	6-36
6.5	UV Facility Reporting to the State	6-37
6.5.1	Required Reporting.....	6-38
6.5.2	Example Reporting Forms and Calculation Worksheets	6-39
6.6	Operational Challenges.....	6-48
6.6.1	Low UV Intensity or Validated Dose Below the Setpoint.....	6-48
6.6.2	Low UV Transmittance.....	6-48
6.6.3	Failure to Meet UV Sensor Calibration Criterion.....	6-50
6.7	Staffing, Training, and Safety Issues	6-50
6.7.1	Staffing Levels	6-53
6.7.2	Training.....	6-53
6.7.3	Safety Issues.....	6-53
7.	Bibliography	7-1

Appendices

Appendix A.	Preparing and Assaying Challenge Microorganisms	A-1
Appendix B.	UV Reactor Testing Examples.....	B-1
Appendix C.	Collimated Beam Testing to Develop a UV Dose-response Curve	C-1
Appendix D.	Background to the UV Reactor Validation Protocol	D-1
Appendix E.	UV Lamp Break Issues	E-1
Appendix F.	Case Studies	F-1
Appendix G.	Reduction Equivalent Dose Bias Tables	G-1

List of Figures

Figure 1.1. LT2ESWTR Compliance Timeline for Initial Source Water Monitoring and Treatment Installation	1-10
Figure 2.1. UV Light in the Electromagnetic Spectrum	2-2
Figure 2.2. Refraction of Light	2-4
Figure 2.3. Reflection of Light	2-4
Figure 2.4. Scattering of Light.....	2-5
Figure 2.5. Structure of DNA and Nucleotide Sequences within DNA	2-7
Figure 2.6. UV Absorbance of Nucleotides (left) and Nucleic Acid (right) at pH 7.....	2-7
Figure 2.7. Hypothetical Dose Distributions for Two Reactors with Differing Hydraulics.....	2-10
Figure 2.8. Shapes of UV Dose-Response Curves	2-12
Figure 2.9. Comparison of Microbial UV Action and DNA UV Absorbance	2-14
Figure 2.10. Example of UV Disinfection Equipment	2-15
Figure 2.11. Examples of UV Reactors: (a) Closed-channel and (b) Open-channel.....	2-15
Figure 2.12. Construction of a UV Lamp	2-19
Figure 2.13. UV Output of LP (a) and MP (b) Mercury Vapor Lamps.....	2-20
Figure 2.14. UV Lamp Output and its Relationship to the UV Absorbance of DNA	2-21
Figure 2.15. Reduction in UV Output of (a) LPHO and (b) MP Lamps Over Time.....	2-23
Figure 2.16. Lamp Aging for an MP Lamp	2-23
Figure 2.17. Aged UV Lamp (right) Compared to a New UV Lamp (left).....	2-24
Figure 2.18. UVT of Quartz that is 1 mm Thick at a Zero-degree Incidence Angle.....	2-26
Figure 2.19. Examples of (a) Mechanical Wiper System and (b) Mechanical-chemical Wiper System.....	2-28
Figure 2.20. Example of a Dry UV Sensor Mounted on a UV Reactor	2-29
Figure 2.21. Example UVT Analyzer Design.....	2-30
Figure 2.22. Example Effect of Ozonation on UV Absorbance if Ozone is Quenched Prior to UV Disinfection.....	2-33
Figure 2.23. Example Effect of UV Disinfection on Free Chlorine Residual Loss.....	2-36
Figure 3.1. Example Flowchart for Planning UV Facilities	3-2
Figure 3.2. Schematic for UV Facility Upstream of the Clearwell	3-5
Figure 3.3. Schematic of Individual Filter Effluent Piping Installation in Filter Gallery.....	3-6
Figure 3.4. UV Disinfection Downstream of High Service Pumps.....	3-8
Figure 3.5. Example Cumulative Frequency Diagram for Three Filtered Waters.....	3-16
Figure 3.6. Example Flow Rate and UVT (at 254 nm) Data	3-17
Figure 3.7. Schematic of Hydraulic Option #1 (90°-Bend, T-Bend, S-Bend Inlet Piping Scenarios)	3-33
Figure 3.8. UV Reactor Validation Options and How They Affect Installation Hydraulics.....	3-34
Figure 4.1. Flowchart for Planning, Design, and Construction of UV Facilities	4-2
Figure 4.2. Open-channel Flow Distribution Options	4-4
Figure 5.1. Overview of Recommended Validation Protocol.....	5-4
Figure 5.2. Block Diagram of a Typical Biodosimetry Test Stand for Full-scale Reactor Testing.....	5-10

Figure 5.3. Hypothetical Examples of the Spectral Response of a Germicidal and a Non-germicidal UV Sensor.....	5-18
Figure 5.4. U_{VAL} Decision Tree for the UV Intensity Setpoint Approach.....	5-39
Figure 5.5. U_{VAL} Decision Tree for the Calculated Dose Approach.....	5-40
Figure 5.6 UVT of Standard and “Ozone-Free” Quartz Assuming Air-Quartz and Quartz-Water Interfaces.....	5-55
Figure 6.1. Start-up and Operation Flowchart	6-2
Figure 6.2. Example Summary Monthly Report.....	6-41
Figure 6.3. Example Daily Operating Log for Calculated Dose Approach.....	6-42
Figure 6.4. Example Daily Operating Log for UV Intensity Setpoint Approach.....	6-43
Figure 6.5. Example Off-specification Calculation Worksheet.....	6-44
Figure 6.6. Example Monthly UV Sensor Calibration Check Log.....	6-45
Figure 6.7. Example UV Sensor CF Calculation Worksheet.....	6-46
Figure 6.8. Example Monthly UVT Analyzer Calibration Check Log.....	6-47
Figure 6.9. Low UV Intensity or Low Validated Dose Decision Chart	6-49
Figure 6.10. Low UV Transmittance Decision Chart.....	6-51
Figure 6.11. Monitoring of UV Sensor Calibration Flowchart.....	6-52

List of Tables

Table 1.1. Summary of Microbial and DBP Rules	1-4
Table 1.2. Bin Requirements for Filtered PWSs	1-5
Table 1.3. Requirements for Unfiltered PWSs	1-6
Table 1.4. UV Dose Requirements – millijoules per centimeter squared (mJ/cm ²)	1-7
Table 2.1. Typical Mercury Vapor Lamp Characteristics	2-17
Table 2.2. Mercury Vapor Lamp Operational Advantages.....	2-17
Table 2.3. Typical Start-up and Restart Times for LPHO and MP Lamps.....	2-22
Table 2.4. Comparison of Magnetic and Electronic Ballasts.....	2-25
Table 2.5. UV Absorbance Characteristics of Common Water Treatment Chemicals	2-34
Table 3.1. Potential Method to Determine Design Flow	3-12
Table 3.2. Summary of UVT Data Collection and Analysis	3-14
Table 3.3. Summary of Fouling Data Collection and Analysis	3-19
Table 3.4. Summary of Particle and Algal Data Collection and Analysis.....	3-20
Table 3.5. Power Quality Triggers for UV Reactors	3-25
Table 3.6. Dose-monitoring Approaches – Key Characteristics.....	3-28
Table 3.7. Advantages and Disadvantages of Single-setpoint and Variable-setpoint Operations for the UV Intensity Setpoint Approach	3-29
Table 3.8. Advantages and Disadvantages of Off-site and On-site Validation	3-31
Table 4.1. Comparison of Techniques for UV Facility Flow Rate Measurement for Combined Filter Effluent and Post-clearwell UV Facilities.....	4-5
Table 4.2. Typical Alarm Conditions for UV Reactors.....	4-13
Table 4.3. Possible Content for UV Equipment Specifications.....	4-20
Table 4.4. Suggested Information to Be Provided by UV Manufacturer	4-22
Table 5.1. Summary of LT2ESWTR Validation Requirements	5-2
Table 5.2. UV Sensitivity of Challenge Microorganisms.....	5-8
Table 5.3. Hypothetical Example of the Spectral Response of a Germicidal UV Sensor	5-16
Table 5.4. Hypothetical Example of the Spectral Response of a Non-germicidal UV Sensor..	5-17
Table 5.5. Factors to be Considered in Validation Test Design	5-21
Table 5.6. Minimum Test Conditions for the UV Intensity Setpoint Approach.....	5-23
Table 5.7. Minimum Test Conditions for the Calculated Dose Approach	5-25
Table 6.1. Functional Testing of Cleaning Systems	6-5
Table 6.2. Example Monitoring During a Four Week Performance Test.....	6-12
Table 6.3. Recommended Operational Tasks for the UV Reactor	6-13
Table 6.4. Recommended Maintenance Tasks	6-16
Table 6.5. Typical Design and Guaranteed Lives of Major UV Components (Based on Manufacturers’ Input)	6-23
Table 6.6. Off-specification Examples for Each Monitoring Approach.....	6-32
Table 6.7. Recommended Recording Frequency for Required Monitoring Parameters.....	6-33
Table 6.8. Recommended Monitoring Parameters and Recording Frequency	6-37
Table 6.9. Factors Impacting Staffing Needs.....	6-53

List of Examples

Example 5.1. Determining Flow Conditions for Validation Testing.....	5-24
Example 5.2. Calculating RED Using Validation Test Data	5-31
Example 5.3. Validation Testing Using Two Challenge Microorganisms	5-33
Example 5.4. Determining the RED Bias factor	5-38
Example 6.1. Setting Operational Controls for the UV Intensity Setpoint Approach – Single Setpoint Operation	6-8
Example 6.2. Setting Operational Controls for the Calculated Dose Approach.....	6-9
Example 6.3. Duty UV Sensors are Verified using Reference Sensor	6-26
Example 6.4. Duty UV Sensors that Do Not Meet Calibration Criteria.....	6-28
Example 6.5. UVT Analyzer Calibration Check	6-31
Example 6.6. Routine and Off-specification Recording.....	6-34
Example 6.7. Off-specification Computation	6-39

List of Checklists

Checklist 5.1. UV Reactor Documentation.....	5-45
Checklist 5.2. Key Elements of the Validation Test Plan.....	5-47
Checklist 5.3. Key Elements of the Validation Report.....	5-49
Checklist 5.4. Review for Quality Assurance/Quality Control.....	5-51
Checklist 5.5. Review for Key Validation Report Elements	5-52

Glossary

The following definitions were derived from existing UV literature, standard physics textbooks, and/or industry standards and conventions. Some concepts have more than one acceptable term or definition, but for consistency within the document, only one term is used.

Absorption – the transformation of UV light to other forms of energy as it passes through a substance.

A₂₅₄ (UV Absorbance at 254 nm)– a measure of the amount of UV light that is absorbed by a substance at 254 nm.

Action Spectra Correction Factor (CF_{as}) – a correction factor to account for greater proportional inactivation of a challenge microorganism compared to the target pathogen that results from differences in action spectra.

Action Spectrum – the relative efficiency of UV energy frequencies at inactivating microorganisms. Each microorganism has a unique action spectrum.

Bacteriophage – a virus that infects bacterial cells and can be used a microbial surrogate during validation testing.

Ballast – an electrical device that provide the proper voltage and current required to initiate and maintain the gas discharge within the UV lamp.

Beer’s Law –an empirical equation describing the absorption of light as a function of the transmitting medium’s properties; also know as the Beer-Lambert law.

Bioassay – in the context of this document, an empirical assessment of the inactivation response of a specific microorganism to a controlled dose of UV light, usually in UV reactors. Bioassay has been used in the UV disinfection literature in the same context as “biodosimetry” (see **Biodosimetry**).

Biodosimetry – a procedure used to determine the reduction equivalent dose (RED) of a UV reactor. Biodosimetry involves measuring the inactivation of a challenge microorganism after exposure to UV light in a UV reactor and comparing the results to the known UV dose-response curve of the challenge microorganism (determined via bench-scale collimated beam testing).

Calculated Dose Approach – See **Dose-monitoring Strategy**.

Challenge Microorganism – a non-pathogenic microorganism used in validation testing of UV reactors.

Collimated Beam Test – a controlled bench-scale test that is used to determine the UV dose-response of a challenge microorganism. Both time and UV light intensity are directly measured; the UV dose is calculated using the intensity of the incident UV light, UV absorbance of the water, and exposure time.

Dark Repair – an enzyme-mediated microbial process that removes and regenerates a damaged section of deoxyribonucleic acid (DNA), using an existing complimentary strand of DNA. Dark repair refers to all microbial repair processes not requiring reactivating light.

Design Flow Rate – the maximum flow that can be treated at the UV facility. See Section 3.4 for potential methods for determining design flow rate.

Design UVT – The minimum UVT that will typically occur at the design flow of the UV facility. The design UVT and design flow are typically used by the UV manufacturer to determine the appropriate UV equipment for a target pathogen inactivation. The design UVT may not necessarily be the minimum operating UVT (see **Minimum Operating UVT**).

Diffuse Reflection – that portion of light reflected by a rough surface that radiates in all directions.

Dose Distribution – see **UV Dose**.

Dose-monitoring Strategy – the method by which a UV reactor maintains the required dose at or near some specified value by monitoring UV dose delivery. Such strategies must include, at a minimum, flow rate and UV intensity (measured via **duty UV sensor[s]**) and lamp status. They sometimes include UVT and lamp power. Two common Dose-monitoring Strategies that are discussed in this manual are the UV Intensity Setpoint Approach and the Calculated Dose Approach.

- **The UV Intensity Setpoint Approach** relies on one or more “setpoints” for UV intensity that are established during validation testing to determine UV dose. During operations, the UV intensity as measured by the UV sensors must meet or exceed the setpoint(s) to ensure delivery of the required dose. Reactors must also be operated within validated operation conditions for flow rates and lamp status [40 CFR 141.720(d)(2)]. In the UV Intensity Setpoint Approach, UVT does not need to be monitored separately. Instead, the intensity readings by the sensors account for changes in UVT. The operating strategy can be with either a single setpoint (one UV intensity setpoint is used for all validated flow rates) or a variable setpoint (the UV intensity setpoint is determined using a lookup table or equation for a range of flow rates).
- **The Calculated Dose Approach** uses a dose-monitoring equation to estimate the UV dose based on operating conditions (typically flow rate, UV intensity, and UVT). The dose-monitoring equation may be developed by the UV manufacturers

using numerical methods; however, EPA recommends that systems use an empirical dose-monitoring equation developed through validation testing. During reactor operations, the UV reactor control system inputs the measured parameters into the dose-monitoring equation to produce a calculated dose. The system operator divides the calculated dose by the Validation Factor (see Chapter 5 for more details on the Validation Factor) and compares the resulting value to the required dose for the target pathogen and log inactivation level.

Dose-pacing Strategy – the method by which a UV reactor maintains the required dose at or near some specified value that typically involves adjusting the lamp power or turning "on" or "off" banks of UV lamps or whole UV reactors to respond to changes in UVT, lamp intensity, or flow rate. A programmable logic controller (PLC) makes adjustments using an equation(s) developed during the UV reactor validation process.

Duty UV Sensor (or Duty Sensor) – the duty (on-line) UV sensor installed in the UV reactor that monitors UV intensity during UV equipment operations.

Emission Spectrum – the relative power emitted by a lamp at different wavelengths.

End-of-Lamp Life – The duration of lamp operations after which the lamp should be replaced

First-order Inactivation – in the context of this document, inactivation of a microorganism that is directly proportional to the UV dose.

Fluence – see the definition for **UV Dose**.

Fluence Rate – see the definition for **UV Intensity**.

Fouling/Aging Factor – a site-specific factor (the product of a fouling factor and aging factor) that is used to account for the decline in UV transmittance through the lamp sleeve due to fouling (e.g., by water quality parameters) and aging of the lamp and lamp sleeve. The lamp fouling portion of the factor is the estimated fraction of UV light passing through a fouled sleeve as compared to a new sleeve. The lamp aging portion of the factor is the fraction of UV light emitted from aged sleeves and lamps compared to new sleeves and lamps. It can be estimated by the lamp and sleeve aging characteristics obtained from the UV manufacturer.

Gas Discharge – a mixture of non-excited atoms, excited atoms, cations, and free electrons formed when a sufficiently high voltage is applied across a volume of gas. Most commercial UV lamps use mercury gas discharges to generate UV light.

Germicidal Effectiveness – the relative inactivation efficiency of each UV wavelength in an emission spectrum. This value is usually approximated by the relative absorbance of DNA at each wavelength.

Germicidal Range – the range of UV wavelengths responsible for microbial inactivation in water (200 to 300 nm).

Germicidal Sensor – A UV sensor with a spectral response that peaks between 250 and 280 nm and has less than 10 percent of its total measurement due to light above 300 nm when mounted on the UV reactor and viewing the UV lamps through the water that will be treated at the water treatment plant.

Inactivation – in the context of UV disinfection, a process by which a microorganism is rendered unable to reproduce, thereby rendering it unable to infect a host.

Lamp Burn-in – During the first few hours of mercury-vapor lamp operation, output will diminish rapidly, then stabilize as the impurities within the lamp are burned off. This initial “burn-in” period is typically assumed to be complete at 100 hours.

Lamp Envelope – the exterior surface of the UV lamp, which is typically made of quartz.

Lamp Sleeve – the quartz tube or thimble that surrounds and protects the UV lamp. The exterior is in direct contact with the water being treated. There is typically an air gap (approximately 1 cm) between the lamp envelope and the quartz sleeve.

Lamp Status – see **UV Lamp Status**

Light Pipe – a quartz cylinder that transmits light from the interior of the UV reactor to the photodetector of a UV intensity sensor.

Lignin Sulfonate – a commercially available liquid lignin mixture (typically procured from paper mills) used to adjust the UV transmittance of natural waters during validation testing.

Low-pressure (LP) Lamp – a mercury-vapor lamp that operates at an internal pressure of 0.13 to 1.3 Pa (2×10^{-5} to 2×10^{-4} psi) and electrical input of 0.5 watts per centimeter (W/cm). This results in essentially monochromatic light output at 254 nm.

Low-pressure high-output (LPHO) Lamp – a low-pressure mercury-vapor lamp that operates under increased electrical input (1.5 to 10 W/cm), resulting in a higher UV intensity than low-pressure lamps. It also has essentially monochromatic light output at 254 nm.

Medium-pressure (MP) Lamp – a mercury vapor lamp that operates at an internal pressure of 1.3 and 13,000 Pa (2 to 200 psi) and electrical input of 50 to 150 W/cm. This results in a polychromatic (or broad spectrum) output of UV and visible light at multiple wavelengths, including wavelengths in the germicidal range.

Microbial Repair – enzyme-mediated microbial process where damaged strands of deoxyribonucleic acid (DNA) are repaired. Energy for this process can be derived by light energy (photorepair) or chemical energy (dark repair).

Minimum Operating UVT: The lowest UVT expected to occur during lifetime of the UV facility. Understanding the minimum UVT is critical because the UV reactor should be designed and validated for the range of UVT and flow rate combinations expected at the WTP to avoid off-specification operation.

Monochromatic – light output at only one wavelength, such as UV light generated by low-pressure and low-pressure high-output lamps.

Monitoring Window – a quartz disc that transmits light from the interior of the UV reactor to the photodetector of a UV sensor.

MS-2 Bacteriophage – a non-pathogenic bacteriophage commonly used as a challenge organism in UV reactor validation testing.

Non-germicidal Sensor – A UV sensor with a spectral response that is not restricted to the germicidal range (see “Germicidal Sensor” for more details).

Off-line Chemical Clean (OCC) – a process to clean lamp sleeves where the UV reactor is taken off-line and a cleaning solution (typically a weak acid) is sprayed into the reactor through a service port. After the foulants have dissolved, the reactor is drained, rinsed, and returned to service. Also called “flush-and-rinse” systems.

Off-specification – A UV facility that is operating outside of the validated operating conditions (e.g., at a flow rate higher than the validated range or a UVT below the validated range).

On-line Mechanical Clean (OMC) – a process to clean lamp sleeves where an automatic mechanical wiper (e.g., O-ring) wipes the surface of the lamp sleeve at a prescribed frequency.

On-line Mechanical-Chemical Clean (OMCC) – a process to clean lamp sleeves where an automatic mechanical wiper (e.g., O-ring) with a chemical solution located within the cleaning mechanism wipes the surface of the lamp sleeve at a prescribed frequency.

Operating Strategy – the strategy used by the PWS to operate the UV equipment with the UV Intensity Setpoint Approach. Typically, single setpoint or variable setpoint operation is used.

Petri Factor – a ratio used in collimated beam testing that is equal to the average intensity measured across the surface of a suspension in a petri dish divided by the intensity at the center of a petri dish.

Photodetector – a device that produces an electrical current proportional to the UV light intensity at the detector's surface.

Photorepair– a microbial repair process where enzymes are activated by light in the near UV and visible range, thereby repairing UV induced damage. Photoreactivation requires the presence of light.

Polychromatic – light energy output at several wavelengths such as with MP lamps.

Polychromatic Bias – a potential bias in validation test data resulting from polychromatic differences between validation and operation of a UV reactor at a water system. Polychromatic bias can occur in MP reactors when non-germicidal sensors are used.

Quartz Sleeve – see **lamp sleeve**.

Radiometer – an instrument used to measure UV irradiance.

Rayleigh Scattering – light scattering by particles smaller than the wavelength of the light.

Reduction Equivalent Dose (RED) – see **UV Dose**.

Reduction Equivalent Dose (RED) Bias – a correction that accounts for the difference between the UV dose measured with a surrogate microorganism and the UV dose that would be delivered to a target pathogen due to differences in the microorganisms' inactivation kinetics.

Reference UV Sensor (or Reference Sensor) – a calibrated, off-line UV sensor used to monitor duty UV sensor calibration and to determine UV sensor uncertainty.

Required Dose – the UV dose required for a certain level of log inactivation. Required doses are set forth by the LT2ESWTR.

Sensor Correction Factor – a correction factor that may need to be temporarily applied during operations when duty sensor(s) fail a calibration check and can not be immediately replaced. The sensor correction factor allows the UV facility to remain in operation while the problem is resolved.

Setpoint (also called “operational setpoint”) – a specific value for a critical parameter, such as UV intensity, that is related to UV dose. Setpoints are established during validation testing. During operations, the PWS compares the measured parameter to the setpoint to confirm performance.

Solarization – a change in the structure of a material due to exposure to UV light that increases light scattering and attenuation.

Spectral Response – A measure of the output of the UV sensor as a function of wavelength.

State – the agency of the state or Tribal government that has jurisdiction over public water systems. During any period when a state or Tribal government does not have primary enforcement responsibility pursuant to section 1413 of the Act, the term “state” means the Regional Administrator, U.S. Environmental Protection Agency.

Subpart H Systems – public water systems using surface water or ground water under the direct influence of surface water as a source that are subject to the requirements of subpart H of 40 CFR Part 141.

Target Log Inactivation - For the target pathogen, the specific log inactivation the PWS wants to achieve using UV disinfection. The target log inactivation is driven by requirements of the SWTR, LT1ESWTR, IESWTR, and LT2ESWTR.

Target Pathogen (also called “target microorganism”) – For the purposes of this manual, the target pathogen is defined as the microorganism for which a PWS wants to obtain inactivation credit using UV disinfection.

UV Absorbance (A) – a measure of the amount of UV light that is absorbed by a substance (e.g., water, microbial DNA, lamp envelope, quartz sleeve) at a specific wavelength (e.g., 254 nm). This measurement accounts for absorption and scattering in the medium (e.g., water). Standard Method 5910B details this measurement method. However, for UV disinfection applications, the sample should not be filtered or adjusted for pH as described in Standard Methods.

UV Absorbance at 254 nm (A_{254}) – a measure of the amount of UV light that is absorbed by a substance at 254 nm.

UV Action Spectrum – the relative efficiency of UV energy at different wavelengths in inactivating microorganisms. Each microorganism has a unique action spectrum.

UV Dose – the UV energy per unit area incident on a surface, typically reported in units of mJ/cm^2 or J/m^2 . The UV dose received by a waterborne microorganism in a reactor vessel accounts for the effects on UV intensity of the absorbance of the water, absorbance of the quartz sleeves, reflection and refraction of light from the water surface and reactor walls, and the germicidal effectiveness of the UV wavelengths transmitted. This guidance manual also uses the following terms related to UV dose:

- **UV dose distribution** – the probability distribution of delivered UV doses that microorganisms receive in a flow-through UV reactor; typically shown as a histogram. An example is shown in Figure 2-8.

- **Reduction Equivalent Dose (RED)** – The UV dose derived by entering the log inactivation measured during full-scale reactor testing into the UV dose-response curve that was derived through collimated beam testing. RED values are always specific to the challenge microorganism used during experimental testing and the validation test conditions for full-scale reactor testing.
- **Required Dose (D_{req})** – The UV dose in units of mJ/cm^2 needed to achieve the target log inactivation for the target pathogen. The required dose is specified in the LT2ESWTR and presented in Table 1.4 of this guidance manual.
- **Validated Dose (D_{val})** – The UV dose in units of mJ/cm^2 delivered by the UV reactor as determined through validation testing. The validated dose is compared to the Required Dose (D_{req}) to determine log inactivation credit.
- **Calculated Dose** - the RED calculated using the dose-monitoring equation that was developed through validation testing.

UV Dose-Response – the relationship indicating the level of inactivation of a microorganism as a function of UV dose.

UV Equipment – the UV reactor and related components of the UV disinfection process, including (but not limited to) UV reactor appurtenances, ballasts, and control panels.

UV Facility – all of the components of the UV disinfection process, including (but not limited to) UV reactors, control systems, piping, valves, and building (if applicable).

UV Intensity – the power passing through a unit area perpendicular to the direction of propagation. UV intensity is used in this guidance manual to describe the magnitude of UV light measured by UV sensors in a reactor and with a radiometer in bench-scale UV experiments.

UV Intensity Setpoint Approach – See **Dose-Monitoring Strategy**.

UV Irradiance – the power per unit area incident to the direction of light propagation at all angles, including normal.

UV Lamp Status – a parameter that is monitored during validation testing and long-term operation of UV reactors that indicates whether a particular UV lamp is on or off.

UV Light – light emitted with wavelengths from 200 to 400 nm.

UV Reactor – the vessel or chamber where exposure to UV light takes place, consisting of UV lamps, quartz sleeves, UV sensors, quartz sleeve cleaning systems, and baffles or other hydraulic controls. The UV reactor also includes additional hardware for monitoring UV dose delivery; typically comprised of (but not limited to): UV sensors and UVT monitors.

UV Reactor Validation – Experimental testing to determine the operating conditions under which a UV reactor delivers the dose required for inactivation credit of *Cryptosporidium*, *Giardia lamblia*, and viruses.

UV Sensitivity – the resistance of a microorganism to inactivation by UV light, expressed as mJ/cm² per log inactivation.

UV Sensor – a photosensitive detector used to measure the UV intensity at a point within the UV reactor that converts the signal to units of milliamps (mA).

UV Transmittance (UVT) – a measure of the fraction of incident light transmitted through a material (e.g., water sample or quartz). The UVT is usually reported for a wavelength of 254 nm and a pathlength of 1-cm. If an alternate pathlength is used, it should be specified or converted to units of cm⁻¹. UVT is often represented as a percentage and is related to the UV absorbance (A_{254}) by the following equation (for a 1-cm path length): % UVT = 100×10^{-A} .

Validated Dose – see **UV Dose**.

Validation Factor – an uncertainty term that accounts for the bias and uncertainty associated with validation testing.

Validated Operating Conditions – the operating conditions under which the UV reactor is confirmed as delivering the dose required for LT2ESWTR inactivation credit. These operating conditions must include flow rate, UV intensity as measured by a UV sensor, and UV lamp status. Also commonly referred to as the “validated range” or the “validated limits.”

Validation Uncertainty – an uncertainty term that accounts for error in measurements made during validation testing to develop the UV intensity setpoint(s) (for the UV Intensity Setpoint Approach) or dose-monitoring equation (for the Calculated Dose Approach).

Visible Light – Wavelengths of light in the visible range (380 – 720 nm).

This page intentionally left blank.

List of Units, Abbreviations, and Acronyms

λ	wavelength
μg	microgram
$\mu\text{g/L}$	microgram per liter
μm	micrometer, micron
A_{254}	ultraviolet light absorbance at 254 nanometers
ACGIH	American Conference of Governmental Industrial Hygienists
AIAA	American Institute of Aeronautics and Astronautics
ANSI	American National Standards Institute
AOC	assimilable organic carbon
APHA	American Public Health Association
ATCC	American Type Culture Collection
AWA	Australian Water Association
AWWA	American Water Works Association
B_{Poly}	polychromatic bias
$^{\circ}\text{C}$	degree Centigrade
CCPP	calcium carbonate precipitation potential
CCWA	Clayton County Water Authority
CEC	Clancy Environmental Consultants
CF	correction factor
CF_{as}	action spectra correction factor
CFD	computational fluid dynamics
CFR	Code of Federal Regulations
cfu	colony forming unit
cfu/mL	colony forming units per milliliter
cm	centimeter
cPEL	ceiling permissible exposure limit
CT	contact time
DBP	disinfection byproduct
DBPR	Stage 2 Disinfectants and Disinfection Byproducts Rule
DNA	deoxyribonucleic acid
DOC	dissolved organic carbon
D_{Req}	required UV dose
DVGW	Deutsche Vereinigung des Gas- und Wasserfaches
ENR BCI	Engineering News Record Building Cost Index
EOLL	end-of-lamp-life
EPA	U.S. Environmental Protection Agency
EPRI	Electric Power Research Institute
$^{\circ}\text{F}$	degree Fahrenheit
g	gram
g/L	gram per liter
g/mL	gram per milliliter
GAC	granular activated carbon
GFI	ground fault interrupter

gpm	gallon per minute
gpm/sf	gallon per minute per square foot
GWUDI	ground water under the direct influence of surface water
HAA	haloacetic acid
HAA5	five haloacetic acids (monochloroacetic, dichloroacetic, trichloroacetic, monobromoacetic, and dibromoacetic acids)
HazMat	hazardous materials
hr	hour
HSP	high-service pump
HVAC	heating, ventilating, and air conditioning system
Hz	Hertz
I&C	instrumentation and control
IDLH	Immediately Dangerous to Life or Health
IEEE	Institute of Electrical and Electronic Engineers
IESWTR	Interim Enhanced Surface Water Treatment Rule
IFE	individual filter effluents
J	joule
J/m ²	joule per meter squared
kVA	kilovolt ampere
kW	kilowatt
L	liter
LED	light emitting diode
LID	light intensity distribution
log I	log Inactivation
LP	low pressure
LPHO	low pressure high output
LRAA	locational running annual average
LSA	lignin sulfonic acid
LT1ESWTR	Long Term 1 Enhanced Surface Water Treatment Rule
LT2ESWTR	Long Term 2 Enhanced Surface Water Treatment Rule
M	molar
M ⁻¹ cm ⁻¹	molar absorption coefficient
m/s ²	meter per second squared
mA	milliampere
mA/mW	milliampere per milliwatt
MCL	maximum contaminant level
mg	milligram
mg/cm	milligram per centimeter
mg/L	milligram per liter
mgd	million gallon per day
mg-Hg/m ³	milligrams mercury per meter cubed
min	minute
mJ	millijoule
mJ/cm ²	millijoule per centimeter squared
mL	milliliter
mm	millimeter

m-mhos/cm	millimhos per centimeter
MP	medium pressure
MS2	male-specific-2 bacteriophage
mW	milliwatt
mW/cm	milliwatt per centimeter
mW/cm ²	milliwatt per centimeter squared
mWs/cm ²	milliwatt second per centimeter squared
NEC	National Electric Code
NIOSH	National Institute for Occupational Safety and Health
NIST	National Institute of Standards and Technology
nm	nanometer
NOM	natural organic matter
NPL	National Physical Laboratory
NSF	National Science Foundation
NTU	nephelometric turbidity unit
NWRI	National Water Research Institute
NYSERDA	New York State Energy Research and Development Authority
O&M	operation and maintenance
OCC	off-line chemical cleaning
OMC	on-line mechanical cleaning
OMCC	on-line mechanical-chemical cleaning
ÖNORM	Österreichisches Normungsinstitut
oocysts/L	oocysts per liter
ORP	oxidation-reduction potential
OSHA	Occupational Safety and Health Administration
Pa	pascal
PAC	powder activated carbon
PEL	permissible exposure limit
pfu	plaque forming unit
pfu/mL	plaque forming units per milliliter
PLC	programmable logic controller
psi	pounds per square inch
psig	pounds-force per square inch gauge
PTB	Physikalisch Technische Bundesanstalt
PWS	public water system
PWSID	public water system identification
QA/QC	quality assurance/quality control
RAA	running annual average
RCRA	Resource Conservation and Recovery Act
RED	reduction equivalent dose
RNA	ribonucleic acid
s	second
SCADA	Supervisory Control and Data Acquisition
SDWA	Safe Drinking Water Act
SMCL	secondary maximum contaminant level
SUVA	specific ultraviolet absorbance

SWTR	Surface Water Treatment Rule
TCU	total color unit
THM	trihalomethane
TLV	threshold limit value
TNTC	too numerous to count
TOC	total organic carbon
TSA	tryptic soy agar
TSB	tryptic soy broth
TTHM	total trihalomethane
UPS	uninterruptible power supply
UV	ultraviolet
U_{Val}	Uncertainty in Validation
UV-A	ultraviolet range from 315 to 400 nm
UV-B	ultraviolet range from 280 to 315 nm
UV-C	ultraviolet range from 200 to 280 nm
U_{DR}	Uncertainty of the Dose-response Fit
U_{IN}	Uncertainty in Interpolation
U_S	Uncertainty in UV Sensor Measurements
U_{SP}	Uncertainty in the Setpoint Value
UVT	ultraviolet transmittance
VF	validation factor
VFD	variable frequency drive
W	watt
W/cm	watt per centimeter
W/cm^2	watt per centimeter squared
W/m^2	watt per meter squared
W/nm	watt per nanometer
WEF	Water Environment Federation
WTP	water treatment plant

1. Introduction

Interest in using ultraviolet (UV) light to disinfect drinking water is growing among public water systems (PWSs)¹ due to its ability to inactivate pathogenic microorganisms without forming regulated disinfection byproducts (DBPs). UV light has proven effective against some pathogens, such as *Cryptosporidium*, that are resistant to commonly used disinfectants like chlorine.

The United States Environmental Protection Agency (EPA) developed the Long Term 2 Enhanced Surface Water Treatment Rule (LT2ESWTR) to further reduce microbial contamination of drinking water. The rule requires additional treatment for some PWSs based on their source water *Cryptosporidium* concentrations and current treatment practices. UV disinfection is one option PWSs have to comply with the additional treatment requirements.

The design, operation, and maintenance needs for UV disinfection differ from those of traditional chemical disinfectants used in drinking water applications. EPA has developed this guidance manual to familiarize states² and PWSs with these distinctions, as well as associated regulatory requirements in the LT2ESWTR. Particularly important design and operation considerations include monitoring, reliability, redundancy, lamp cleaning and replacement, and lamp breakage. Regulatory requirements include UV dose, UV reactor validation, monitoring, reporting, and off-specification compliance.

EPA developed the requirements for UV disinfection in the LT2ESWTR and the guidance in this manual solely for PWSs using UV light to meet drinking water disinfection standards established under the Safe Drinking Water Act (SDWA). EPA has not addressed and did not consider the extension of these requirements and guidance to other applications, including point-of-entry or point-of-use devices for residential water treatment that are not operated by PWSs to meet SDWA disinfection standards.

Chapter 1 covers:

- 1.1 Guidance Manual Objectives
- 1.2 Organization
- 1.3 Regulations Summary
- 1.4 UV Disinfection Requirements for Filtered and Unfiltered PWSs
- 1.5 Regulations Timeline
- 1.6 Alternative Approaches for Disinfecting with UV Light

¹ Throughout this document, the terms “PWS” and “water system” are used interchangeably.

² Throughout this document, the terms “state” and “states” are used to refer to all regulatory agencies, including both state and federal, with primary enforcement authority for PWSs.

1.1 Guidance Manual Objectives

This manual's objectives are as follows:

- Provide PWSs and designers with technical information and guidance on selecting, designing, and operating UV installations and complying with the UV disinfection-related requirements in the LT2ESWTR.
- Provide states with guidance and the necessary tools to assess UV installations during the design, start-up, and routine operation phases.
- Provide manufacturers with testing and performance standards for UV reactors and components intended for treating drinking water.

1.2 Organization

This manual consists of seven chapters and seven appendices:

- Chapter 1 – **Introduction**. The remainder of this chapter summarizes the microbial treatment and UV disinfection requirements of the LT2ESWTR.
- Chapter 2 – **Overview of UV Disinfection**. This chapter describes the principles of UV disinfection, dose-response relationships, water quality impacts, and UV reactors.
- Chapter 3 – **Planning Analyses for UV Facilities**. This chapter discusses planning for UV disinfection facilities, including disinfection goals, potential locations, basic design parameters, UV reactor evaluation, operational strategies, facility hydraulics, pilot- and demonstration-scale testing, and preliminary costs.
- Chapter 4 – **Design Considerations for UV Facilities**. This chapter discusses the key design features for UV disinfection facilities and presents some common approaches to facility design. Key design features include hydraulics, operational optimization, instrumentation and controls, electrical power considerations, facility layout, and specifications.
- Chapter 5 – **Validation of UV Reactors**. This chapter summarizes the LT2ESWTR requirements for validation testing and presents EPA's recommended validation protocol.
- Chapter 6 – **Start-up and Operation of UV Facilities**. This chapter discusses start-up and operation issues for UV disinfection facilities, recommended maintenance tasks, and monitoring requirements and recommendations.
- Chapter 7 – **Bibliography**. This chapter lists the references used in Chapters 1 through 6 and Appendices A through G.

- Seven appendices provide supplemental information to Chapters 1 – 6.

- Appendix A. Preparing and Assaying Challenge Microorganisms
- Appendix B. UV Reactor Testing Examples
- Appendix C. Collimated Beam Testing to Develop a UV Dose-response Curve
- Appendix D. Background to the UV Reactor Validation Protocol
- Appendix E. UV Lamp Break Issues
- Appendix F. Case Studies
- Appendix G. Reduction Equivalent Dose Bias Tables

1.3 Regulations Summary

This section summarizes general microbial treatment and specific UV disinfection requirements in the LT2ESWTR. The rule applies to all PWSs that use surface water or groundwater under the direct influence of surface water (GWUDI). It builds on existing regulations—the Surface Water Treatment Rule (SWTR), Interim Enhanced Surface Water Treatment Rule (IESWTR), and Long Term 1 Enhanced Surface Water Treatment Rule (LT1ESWTR)—to improve control of *Cryptosporidium* and other microbial pathogens.

EPA has developed a Stage 2 Disinfectants and Disinfection Byproducts Rule (DBPR) with the LT2ESWTR to address the risk-risk trade off between microbial disinfection and the DBPs formed by commonly used disinfectants. The Stage 2 DBPR aims to reduce peak DBP concentrations in the distribution system by modifying the Stage 1 DBPR monitoring requirements and procedures for compliance determination. Consequently, when a PWS assesses its disinfection strategy, it must consider both the disinfectant effectiveness against the target pathogen and the DBPs formed as a result of the disinfectant.

Table 1.1 highlights microbial treatment requirements and DBP maximum contaminant levels (MCLs) from the SWTR, IESWTR, LT1ESWTR, LT2ESWTR, Stage 1 DBPR, and Stage 2 DBPR. See the original regulations or the *Code of Federal Regulations* (CFR) for complete requirements. Details on the Stage 2 DBPR can be found in 40 CFR 141.600 – 141.629.

Table 1.1. Summary of Microbial and DBP Rules

Surface Water Treatment Rules – Minimum Treatment Requirements¹				
Regulation	<i>Giardia</i>	Virus	<i>Cryptosporidium</i>	
SWTR	3-log removal and/or inactivation	4-log removal and/or inactivation	Not addressed	
IESWTR and LT1ESWTR	No change from SWTR		2-log removal	
LT2ESWTR	No change from SWTR		0- to 2.5-log additional treatment for filtered systems ²	
			2- or 3-log inactivation for unfiltered systems ²	
DBP Rules – MCLs Based on Running Annual Averages (RAAs) or Locational RAAs (LRAAs)				
Regulation	Total Trihalomethanes (TTHM) (µg/L)³	Five Haloacetic Acids (HAA5) (µg/L)³	Bromate (µg/L)³	Chlorite (µg/L)³
Stage 1 DBPR	80 as RAA	60 as RAA	10	1000
Stage 2 DBPR ⁴	80 as LRAA	60 as LRAA	No change from Stage 1	

¹ The term “log” means the order of magnitude reduction in concentration; e.g., 2-log removal equals a 99% reduction, 3-log removal equals a 99.9% reduction, and 4-log removal equals a 99.99-percent reduction.

² Specific requirements for each plant depend on source water monitoring results and current treatment practices (40 CFR 141.710 – 141.712).

³ micrograms/liter (µg/L)

⁴ Monitoring locations for LRAAs are identified from the Initial Distribution System Evaluation.

The following sections describe LT2ESWTR requirements for filtered and unfiltered PWSs.

1.3.1 Filtered PWSs

The LT2ESWTR requires filtered PWSs to conduct source water monitoring³ to determine average *Cryptosporidium* concentrations. Based on the monitoring results, filtered PWSs will be classified in one of four possible treatment bins. A PWS’s bin classification determines the extent of any additional *Cryptosporidium* treatment requirements. The rule requires filtered PWSs to comply with additional treatment requirements by using one or more management or treatment techniques from a “microbial toolbox” of options (40 CFR 141.711). UV is one option in the microbial toolbox; see the LT2ESWTR for additional options (40 CFR 141.715).

³ The full monitoring requirements are described in the *Source Water Monitoring Guidance Manual for Public Water Systems for the Long Term 2 Enhanced Surface Water Treatment Rule* (USEPA 2006).

Filtered PWSs are exempt from *Cryptosporidium* monitoring if the PWS provides, or will provide, a total of at least 5.5-log *Cryptosporidium* treatment—the maximum treatment required by the LT2ESWTR for filtered PWSs⁴—by the treatment compliance date, which varies, depending on population (see Section 1.5 for compliance dates) [40 CFR 141.701(d)]. Installing a UV disinfection system that is validated for the appropriate inactivation credit in addition to filtration treatment can achieve this objective.

Treatment Bin Classification

Table 1.2 presents the bin classifications and their corresponding additional treatment requirements for filtered PWSs (40 CFR 141.711). PWSs with average *Cryptosporidium* concentrations of less than 0.075 oocysts per liter (oocysts/L) are placed in Bin 1 where no additional treatment is required. For concentrations of 0.075 oocysts/L or more, treatment beyond that required by existing rules is necessary. The additional treatment required for each bin, specified in terms of log removal, depends on the type of treatment the PWS already uses.

Table 1.2. Bin Requirements for Filtered PWSs¹

<i>Cryptosporidium</i> Concentration (oocysts/L)	Bin Classifi- cation	And if the following filtration treatment is operating in full compliance with existing regulations, then the <i>additional</i> treatment requirements are²...			
		Conventional Filtration Treatment (includes softening)	Direct Filtration	Slow Sand or Diatomaceous Earth Filtration	Alternative Filtration Technologies
< 0.075	1	No additional treatment	No additional treatment	No additional treatment	No additional treatment
≥ 0.075 and < 1.0	2	1 log treatment ³	1.5 log treatment ³	1 log treatment ³	As determined by the state ^{3,5}
≥ 1.0 and < 3.0	3	2 log treatment ⁴	2.5 log treatment ⁴	2 log treatment ⁴	As determined by the state ^{4,6}
≥ 3.0	4	2.5 log treatment ⁴	3 log treatment ⁴	2.5 log treatment ⁴	As determined by the state ^{4,7}

¹ From 40 CFR 141.711

² Additional treatment requirements reflect a *Cryptosporidium* removal credit of 3 log for a conventional, slow sand, or diatomaceous earth filtration, and a 2.5-log credit for direct filtration plants.

³ PWSs may use any technology or combination of technologies from the microbial toolbox.

⁴ PWSs must achieve at least 1 log of the required treatment using ozone, chlorine dioxide, UV light, membranes, bag/cartridge filters, or bank filtration.

⁵ Total *Cryptosporidium* treatment must be at least 4.0 log.

⁶ Total *Cryptosporidium* treatment must be at least 5.0 log.

⁷ Total *Cryptosporidium* treatment must be at least 5.5 log.

⁴ Treatment requirements for filtered PWSs [40 CFR 141.711] are based on a determination that conventional, slow sand, and diatomaceous earth filtration plants in compliance with the IESWTR and LTIESWTR achieve an average of 3-log removal of *Cryptosporidium*. EPA has determined that direct filtration plants achieve an average of 2.5-log removal of *Cryptosporidium* (their removal is less than in conventional filtration because they lack a sedimentation process).

1.3.2 Unfiltered PWSs

All existing requirements for unfiltered PWSs remain in effect, including disinfection to achieve at least 3-log inactivation of *Giardia* and 4-log inactivation of viruses. The LT2ESWTR requires 2- or 3-log inactivation of *Cryptosporidium*, depending on the source water concentration of *Cryptosporidium*, as shown in Table 1.3 [40 CFR 141.712)].

Table 1.3. Requirements for Unfiltered PWSs

Average <i>Cryptosporidium</i> Concentration (oocysts/L)	Additional <i>Cryptosporidium</i> Inactivation Requirements
≤ 0.01	2 log ¹
> 0.01	3 log ¹

¹ Overall disinfection requirements must be met with a minimum of two disinfectants [40 CFR 141.712(d)].

Unfiltered PWSs are exempt from *Cryptosporidium* monitoring if the PWS provides, or will provide, a total of at least 3-log *Cryptosporidium* inactivation—the maximum treatment required by the LT2ESWTR for unfiltered systems [40 CFR 141.701(d)]—by the treatment compliance date. (See Figure 1.1.) Installing a UV disinfection system that is validated for the appropriate inactivation credit can achieve this objective.

1.3.3 PWSs with Uncovered Finished Water Storage Facilities

The LT2ESWTR requires PWSs with uncovered finished water storage facilities to either cover the storage facility or treat the discharge of the storage facility that is distributed to consumers to achieve inactivation and/or removal of 4-log virus, 3-log *Giardia*, and 2-log *Cryptosporidium*. UV disinfection is a treatment option that can help water systems meet these requirements.

1.4 UV Disinfection Requirements for Filtered and Unfiltered PWSs

The LT2ESWTR has several requirements related to the use of UV disinfection. They address the UV doses for different levels of inactivation credit, performance validation testing of UV reactors, monitoring, reporting, and off-specification operation.

1.4.1 UV Dose and Validation Testing Requirements

EPA developed UV dose requirements for PWSs to receive credit for inactivation of *Cryptosporidium*, *Giardia*, and viruses (Table 1.4). The UV dose values in Table 1.4 are applicable only to post-filter applications of UV disinfection in filtered systems and to unfiltered systems.

Unlike chemical disinfectants, UV leaves no residual that can be monitored to determine UV dose and inactivation credit. The UV dose depends on the UV intensity (measured by UV sensors), the flow rate, and the UV transmittance (UVT).⁵ A relationship between the required UV dose and these parameters must be established and then monitored at the water treatment plant to ensure sufficient disinfection of microbial pathogens.

Table 1.4. UV Dose Requirements – millijoules per centimeter squared (mJ/cm²)¹

Target Pathogens	Log Inactivation							
	0.5	1.0	1.5	2.0	2.5	3.0	3.5	4.0
<i>Cryptosporidium</i>	1.6	2.5	3.9	5.8	8.5	12	15	22
<i>Giardia</i>	1.5	2.1	3.0	5.2	7.7	11	15	22
Virus	39	58	79	100	121	143	163	186

¹ 40 CFR 141.720(d)(1)

The UV dose requirements in Table 1.4 account for uncertainty in the UV dose-response relationships of the target pathogens but do not address other significant sources of uncertainty in full-scale UV disinfection applications. These other sources of uncertainty are due to the hydraulic effects of the UV installation, the UV reactor equipment (e.g., UV sensors), and the monitoring approach.

Due to these factors, the LT2ESWTR requires PWSs to use UV reactors that have undergone validation testing. This validation testing must determine the operating conditions under which the reactor delivers the required UV dose for treatment credit [40 CFR 141.720(d)(2)]. These operating conditions must include flow rate, UV intensity as measured by a UV sensor, and UV lamp status. Further, validation testing must meet the following requirements:

- Validated operating conditions must account for UV absorbance of the water, lamp fouling and aging, measurement uncertainty of online sensors, UV dose distributions arising from the velocity profiles through the reactor, failure of UV lamps or other critical system components, and inlet and outlet piping or channel configurations of the UV reactor [40 CFR 141.720(d)(2)(i)].
- Validation testing must involve full-scale testing of a reactor that conforms uniformly to the UV reactors used by the PWS, and it also must demonstrate inactivation of a test microorganism whose dose-response characteristics have been quantified with a low-pressure mercury vapor lamp [40 CFR 141.720(d)(2)(ii)].

Using the above requirements as a basis, Chapter 5 presents EPA's recommended validation protocol. Water systems are not required to follow this protocol but may follow alternatives that achieve compliance with the regulatory requirements as long as they are acceptable to the state. Also, states may have additional requirements than are provided in the federal rule.

⁵ UV intensity measurements may account for UVT depending on sensor locations.

1.4.2 UV Disinfection Monitoring Requirements [40 CFR 141.720(d)(3)(i)]

The LT2ESWTR requires PWSs to monitor their UV reactors to demonstrate that they are operating within the range of conditions that were validated for the required UV dose. At a minimum, PWSs must monitor each reactor for flow rate, lamp status, UV intensity as measured by a UV sensor, and any other parameters required by the state. UV absorbance should also be measured when it is used in a dose-monitoring strategy. PWSs must verify the calibration of UV sensors and recalibrate sensors in accordance with a protocol the state approves. Section 6.4.1.2 of this guidance describes recommended frequencies for checking sensors.

1.4.3 UV Disinfection Reporting Requirements [40 CFR 141.721(f)(15)]

The LT2ESWTR requires PWSs to report the following items:

- **Initial reporting** – Validation test results demonstrating operating conditions that achieve the UV dose required for compliance with the LT2ESWTR.
- **Routine reporting** – Percentage of water entering the distribution system that was not treated by the UV reactors operating within validated conditions on a monthly basis.

1.4.4 Off-specification Operational Requirement for Filtered and Unfiltered Systems [40 CFR 141.720(d)(3)(ii)]

To receive disinfection credit for UV, both filtered and unfiltered PWSs must treat at least 95 percent of the water delivered to the public during each month by UV reactors operating within validated conditions for the required UV dose. EPA views this 95-percent limit as a feasible minimum level of performance for PWSs to achieve, while ensuring the desired level of health protection is provided. For purposes of design and operation, PWSs should strive to deliver the required UV dose at all times during treatment.

In this manual, operating outside the validated limits is defined as off-specification. Off-specification compliance is based on the volume of water treated. Guidance for calculating off-specification is provided in Chapter 6.

1.5 Regulations Timeline

Figure 1.1 provides a timeline for LT2ESWTR initial source water monitoring and treatment installation. Compliance dates vary among the following PWS sizes:

- Systems serving 100,000 or more people
- Systems serving 50,000 to 99,999 people
- Systems serving 10,000 to 49,999 people
- Systems serving fewer than 10,000 people

Treatment installation dates pertain only to PWSs that are required to provide additional treatment for *Cryptosporidium*. Further, the actual duration of the treatment installation phase will be contingent on a number of PWS-specific factors, including scope of design (i.e., new facility or retrofit); scale of design (size of facility); available in-house resources; procurement methods; and validation testing requirements (discussed in detail in Chapters 3, 4, and 5).

1.6 Alternative Approaches for Disinfecting with UV Light

This manual provides technical information about using UV disinfection for drinking water treatment. Although it covers many aspects of implementing a UV installation, it is not comprehensive in terms of all types of UV installations, design alternatives, and validation protocols that may provide satisfactory performance. For example, pulsed UV and eximer lamps are two types of UV technologies not included in this manual, but they may provide effective disinfection.

Currently, substantial research is being conducted on UV disinfection and its applications in various industries. As more information becomes available, UV equipment or methods of operation, design, and validation will evolve. Water systems are not limited by the information provided in this guidance manual but must meet the requirements of the LT2 and other drinking water rules, as well as any state-specific requirements. States may approve alternatives in UV installation design, operation, and validation that are not described in this manual.

Figure 1.1. LT2ESWTR Compliance Timeline for Initial Source Water Monitoring and Treatment Installation

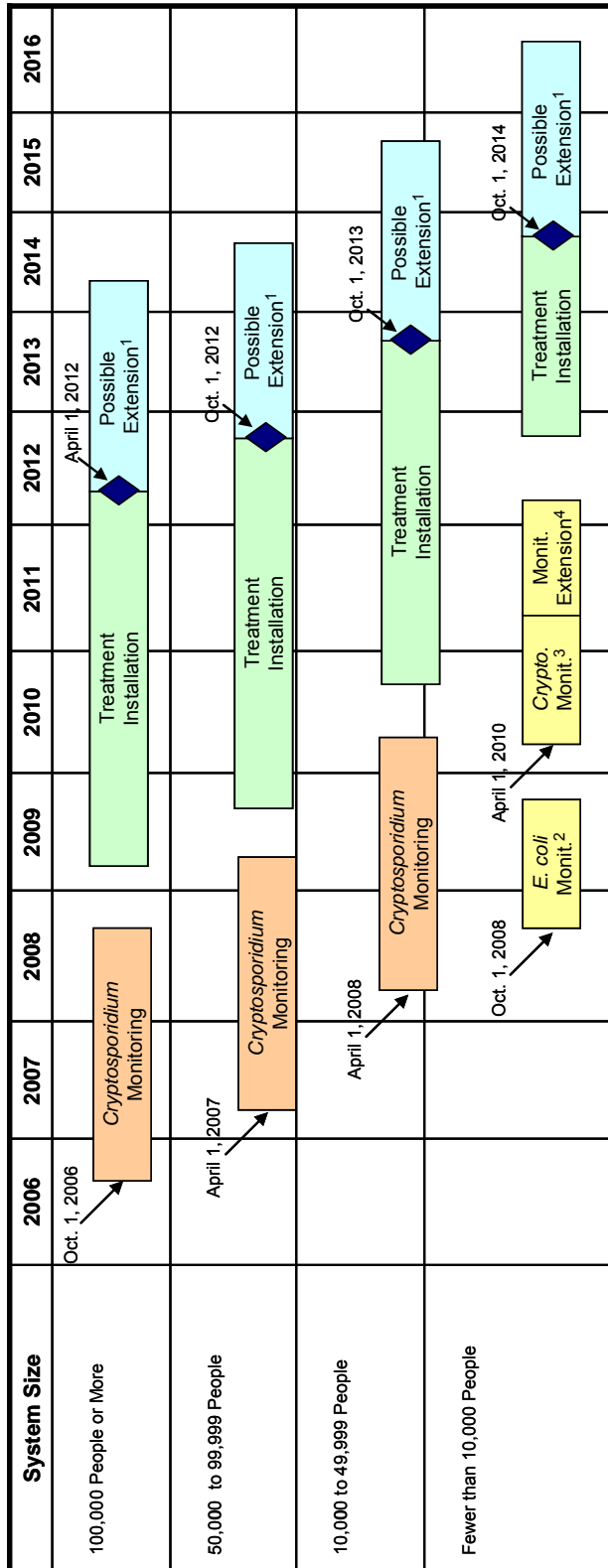

◆ Regulatory Compliance Date

- ¹ Two-year extension may be granted at the discretion of the state for systems requiring capital improvements.
- ² E. coli monitoring applies only to filtered systems or unfiltered systems that are required to install filtration.
- ³ Cryptosporidium monitoring for small systems is necessary only if E. coli monitoring indicates an annual mean concentration greater than 50 E. coli per 100 mL.
- ⁴ Systems serving fewer than 10,000 people may monitor Cryptosporidium either by collecting two samples per month for one year or one sample per month for two years.

2. Overview of UV Disinfection

Chapter 2 provides an overview of UV disinfection. This overview includes discussion of basic chemical and physical principles, the components of UV equipment, and performance monitoring for UV facilities. The overview material in Chapter 2 is intended to present generally accepted facts and research results related to UV disinfection. The material is not intended to provide guidance or recommendations for designing, validating, or installing UV disinfection facilities. Some guidance is included in this chapter to enhance the information presented, but any guidance that appears in this section is also documented in the appropriate subsequent chapters in this manual.

Chapter 2 covers:

- 2.1 History of UV Light for Drinking Water Disinfection
- 2.2 UV Light Generation and Transmission
- 2.3 Microbial Response to UV Light
- 2.4 UV Disinfection Equipment
- 2.5 Water Quality Effects and Byproduct Formation

2.1 History of UV Light for Drinking Water Disinfection

UV disinfection is an established technology supported by decades of fundamental and applied research and practice in North America and Europe. Downes and Blunt (1877) discovered the germicidal properties of sunlight. The development of mercury lamps as artificial UV light sources in 1901 and the use of quartz as a UV transmitting material in 1906 were soon followed by the first drinking water disinfection application in Marseilles, France, in 1910. In 1929, Gates identified a link between UV disinfection and absorption of UV light by nucleic acid (Gates 1929). The development of the fluorescent lamp in the 1930s led to the production of germicidal tubular lamps. Considerable research on the mechanisms of UV disinfection and the inactivation of microorganisms occurred during the 1950s (Dulbecco 1950, Kelner 1950, Brandt and Giese 1956, Powell 1959).

Although substantial research on UV disinfection occurred during the first half of the 20th century, the low cost of chlorine and operational problems with early UV disinfection equipment limited its growth as a drinking water treatment technology. The first reliable applications of UV light for disinfecting municipal drinking water occurred in Switzerland and Austria in 1955 (Kruithof and van der Leer 1990). By 1985, the number of such installations in these countries had risen to approximately 500 and 600, respectively. After chlorinated disinfection byproducts (DBPs) were discovered, UV disinfection became popular in Norway and the Netherlands with the first installations occurring in 1975 and 1980, respectively.

As of the year 2000, more than 400 UV disinfection facilities worldwide were treating drinking water; these UV facilities typically treat flows of less than 1 million gallons per day (mgd) (USEPA 2000). Since 2000, several large UV installations across the United States have been constructed or are currently under design. The largest of these facilities includes a 180-mgd

facility in operation in Seattle, Washington, and a 2,200-mgd facility under design for the New York City Department of Environmental Protection (Schulz 2004). Because of the susceptibility of *Cryptosporidium* to UV disinfection and the emphasis in recent regulations on controlling *Cryptosporidium*, the number of public water systems (PWSs) using UV disinfection is expected to increase significantly over the next decade.

2.2 UV Light Generation and Transmission

The use of UV light to disinfect drinking water involves (1) generating UV light with the desired germicidal properties and (2) delivering (or transmitting) that light to pathogens. This section summarizes how UV light is generated and the environmental conditions that affect its delivery to pathogens.

2.2.1 Nature of UV Light

UV light is the region of the electromagnetic spectrum that lies between X-rays and visible light (Figure 2.1). The UV spectrum is divided into four regions: vacuum UV [100 to 200 nanometers (nm)]; UV-C (200 to 280 nm); UV-B (280 to 315 nm); and UV-A (315 to 400 nm) (Meulemans 1986). UV disinfection primarily occurs due to the germicidal action of UV-B and UV-C light on microorganisms. The germicidal action of UV-A light is small relative to UV-B light and UV-C light; therefore, very long exposure times are necessary for UV-A light to be effective as a disinfectant. Although light in the vacuum UV range can disinfect microorganisms (Munakata et al. 1991), vacuum UV light is impractical for water disinfection applications because it rapidly dissipates in water over very short distances. For the purposes of this manual, the practical germicidal wavelength for UV light is defined as the range between 200 and 300 nm. The germicidal range is discussed further in Section 2.3.1.

Figure 2.1. UV Light in the Electromagnetic Spectrum

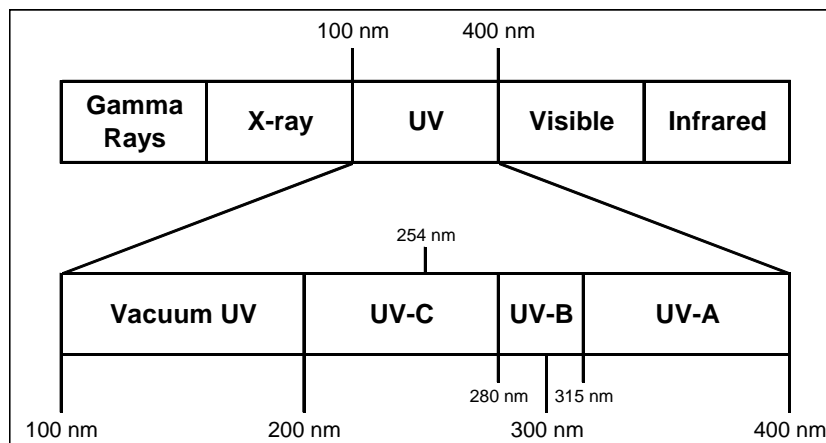

Typically, UV light is generated by applying a voltage across a gas mixture, resulting in a discharge of photons. The specific wavelengths of light emitted from photon discharge depend on the elemental composition of the gas and the power level of the lamp. Nearly all UV lamps currently designed for water treatment use a gas mixture containing mercury vapor. Mercury gas is advantageous for UV disinfection applications because it emits light in the germicidal wavelength range. Other gases such as xenon also emit light in the germicidal range.

The light output from mercury-based UV lamps depends on the concentration of mercury atoms, which is directly related to the mercury vapor pressure. In low-pressure (LP) UV lamps, mercury at low vapor pressure [near vacuum; 2×10^{-5} to 2×10^{-3} pounds per square inch (psi)] and moderate temperature [40 degrees centigrade (°C)] produces essentially monochromatic (one wavelength) UV light at 253.7 nm. In medium-pressure (MP) UV lamps, a higher vapor pressure [2 – 200 psi] and higher operating temperature (600 – 900 °C) is used to increase the frequency of collisions between mercury atoms, which produces UV light over a broad spectrum (polychromatic) with an overall higher intensity. The characteristics of LP and MP lamps are discussed in Section 2.4.2 and summarized in Table 2.1.

2.2.2 Propagation of UV Light

As UV light propagates from its source, it interacts with the materials it encounters through absorption, reflection, refraction, and scattering. In disinfection applications, these phenomena result from interactions between the emitted UV light and UV reactor components (e.g., lamp envelopes, lamp sleeves, and reactor walls) and also the water being treated. When assessing water quality, UV absorbance or UV transmittance (UVT) is the parameter that incorporates the effect of absorption and scattering. This section briefly describes both the phenomena that influence light propagation and the measurement techniques used to quantify UV light propagation.

Absorption is the transformation of light to other forms of energy as it passes through a substance. UV absorbance of a substance varies with the wavelength (λ) of the light. The components of a UV reactor and the water passing through the reactor all absorb UV light to varying degrees, depending on their material composition. When UV light is absorbed, it is no longer available to disinfect microorganisms.

Unlike absorption, the phenomena of refraction, reflection, and scattering change the direction of UV light, but the UV light is still available to disinfect microorganisms.

Refraction (Figure 2.2) is the change in the direction of light propagation as it passes through the interface between one medium and another. In UV reactors, refraction occurs when light passes from the UV lamp into an air gap, from the air gap into the lamp sleeve, and from the lamp sleeve into the water. Refraction changes the angle that UV light strikes target pathogens, but how this ultimately affects the UV disinfection process is unknown.

Reflection is the change in direction of light propagation when it is deflected by a surface (Figure 2.3). Reflection may be classified as specular or diffuse. Specular reflection occurs from smooth polished surfaces and follows the Law of Reflection (the angle of incidence is equal to the angle of reflection). Diffuse reflection occurs from rough surfaces and scatters light in all

directions with little dependence on the incident angle. In UV reactors, reflection will take place at interfaces that do not transmit UV light (e.g., the reactor wall) and also at UV transmitting interfaces (e.g., the inside of a lamp sleeve). The type of reflection and intensity of light reflected from a surface depends on the material of the surface.

Figure 2.2. Refraction of Light

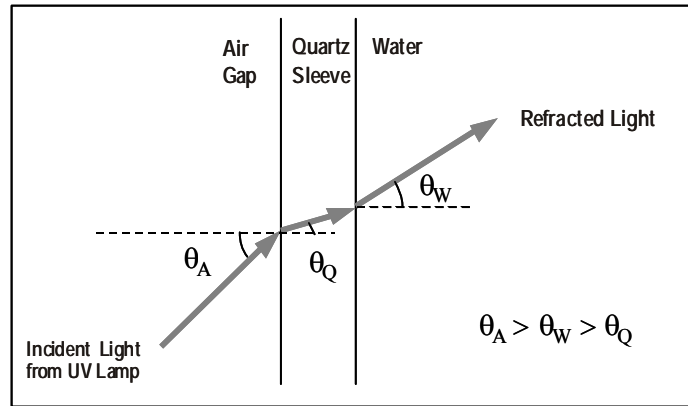
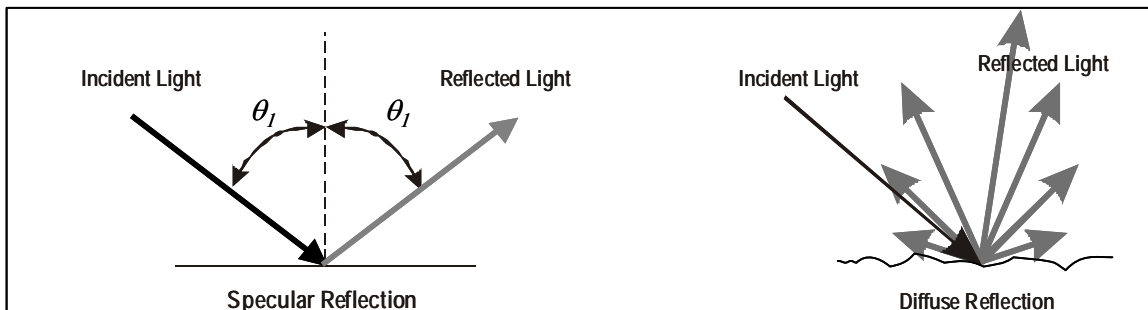
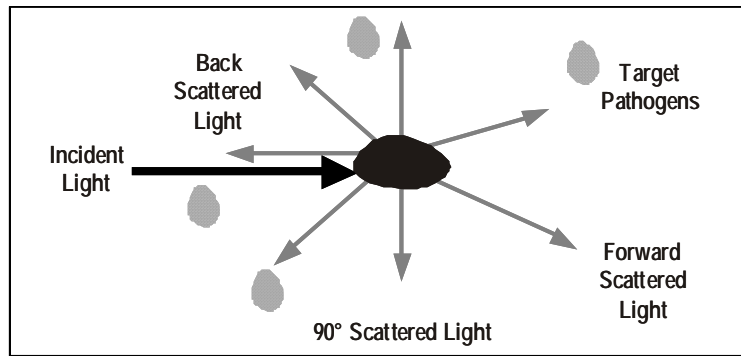

Figure 2.3. Reflection of Light



Scattering of light is the change in direction of light propagation caused by interaction with a particle (Figure 2.4). Particles can cause scattering in all directions, including toward the incident light source (back-scattering). Scattering of light caused by particles smaller than the wavelength of the light is called Rayleigh scattering. Rayleigh scattering depends inversely on wavelength to the fourth power ($1/\lambda^4$) and thus is more prominent at shorter wavelengths. Particles larger than the wavelength of light scatter more light in the forward direction but also cause some backscattering that is relatively independent of wavelength.

UV absorbance (A) quantifies the decrease in the amount of incident light as it passes through a water sample over a specified distance or pathlength. UV absorbance at 254 nm (A_{254}) is a water quality parameter commonly used to characterize the DBP formation potential of the water (e.g., specific UV absorbance calculations). In UV disinfection applications, A_{254} is used to measure the amount of UV light passing through the water and reaching the target organisms. A_{254} is measured using a spectrophotometer with 254 nm incident light and is typically reported on a per centimeter (cm^{-1}) basis.

Figure 2.4. Scattering of Light

Standard Method 5910B (APHA et al. 1998) calls for filtering the sample through a 0.45- μm membrane and adjusting the pH before measuring the absorbance. For UV disinfection applications, however, A_{254} measurements should reflect the water to be treated. Therefore, water samples should be analyzed without filtering or adjusting the pH. More information on collecting A_{254} data is provided in Section 3.4.4.1. Although Standard Methods defines this measurement as UV absorption, this manual refers to it as UV absorbance because the latter term is widely used in the water treatment industry.

UV Transmittance (UVT) has also been used extensively in the literature when describing the behavior of UV light. UVT is the percentage of light passing through material (e.g., a water sample or quartz) over a specified distance. The UVT can be calculated using Beer's law (Equation 2.1):

$$\% \text{ UVT} = 100 * \frac{I}{I_0} \quad \text{Equation 2.1}$$

where

- UVT = UV transmittance at a specified wavelength (e.g., 254 nm) and pathlength (e.g., 1 cm)
- I = Intensity of light transmitted through the sample [milliwatt per centimeter squared (mW/cm^2)]
- I_0 = Intensity of light incident on the sample (mW/cm^2)

UVT can also be calculated by relating it to UV absorbance using Equation 2.2:

$$\% \text{ UVT} = 100 * 10^{-A} \quad \text{Equation 2.2}$$

where

- UVT = UV transmittance at a specified wavelength (e.g., 254 nm) and pathlength (e.g., 1 cm)
- A = UV absorbance at a specified wavelength and pathlength (unitless)

UVT is typically reported at 254 nm because UV manufacturers and PWSs widely use A_{254} . This manual assumes UVT is at 254 nm unless specifically stated otherwise.

2.3 Microbial Response to UV Light

The mechanism of disinfection by UV light differs considerably from the mechanisms of chemical disinfectants such as chlorine and ozone. Chemical disinfectants inactivate microorganisms by destroying or damaging cellular structures, interfering with metabolism, and hindering biosynthesis and growth (Snowball and Hornsey 1988). UV light inactivates microorganisms by damaging their nucleic acid, thereby preventing them from replicating. A microorganism that cannot replicate cannot infect a host.

It is important that the assays used to quantify microorganism inactivation measure the ability of the microorganism to reproduce (Jagger 1967). For bacteria, assays measure the ability of the microorganism to divide and form colonies. For viruses, assays measure the ability of the microorganism to form plaques in host cells. For protozoan cysts, the assays measure the ability of the microorganism to infect a host or tissue culture. Assays that do not measure a response to reproduction may result in misleading information on the inactivation of microorganisms using UV light.

This section describes how UV light causes microbial inactivation, discusses how microorganisms can repair the damage, and introduces the concept of UV dose-response.

2.3.1 Mechanisms of Microbial Inactivation by UV Light

Nucleic acid is the molecule responsible for defining the metabolic functions and reproduction of all forms of life. The two most common forms of nucleic acid are deoxyribonucleic acid (DNA) and ribonucleic acid (RNA). DNA and RNA consist of single- or double-stranded polymers comprising building blocks called nucleotides (Figure 2.5). In DNA, the nucleotides are classified as either purines (adenine and guanine) or pyrimidines (thymine and cytosine). In RNA, the purines are the same as in DNA, but the pyrimidines are uracil and cytosine.

As shown in Figure 2.6, the nucleotides absorb UV light at wavelengths from 200 to 300 nm. The UV absorption of DNA and RNA reflects their nucleotide composition and tends to have a peak near 260 nm and a local minimum near 230 nm.

All purines and pyrimidines strongly absorb UV light, but the rate of UV-induced damage is greater with pyrimidines (Jagger 1967). Absorbed UV light induces six types of damage in the pyrimidines of nucleic acid (Setlow 1967, Snowball and Hornsey 1988, Pfeifer 1997). The damage varies depending on UV dose. The following three types of damage contribute to microorganism inactivation:

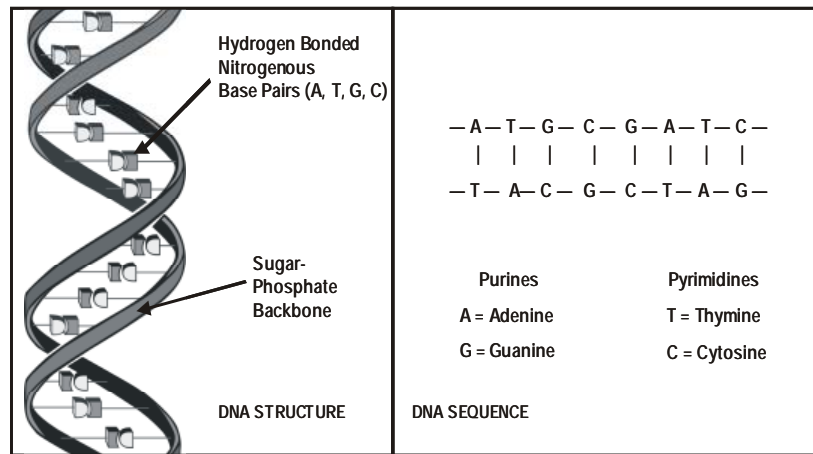
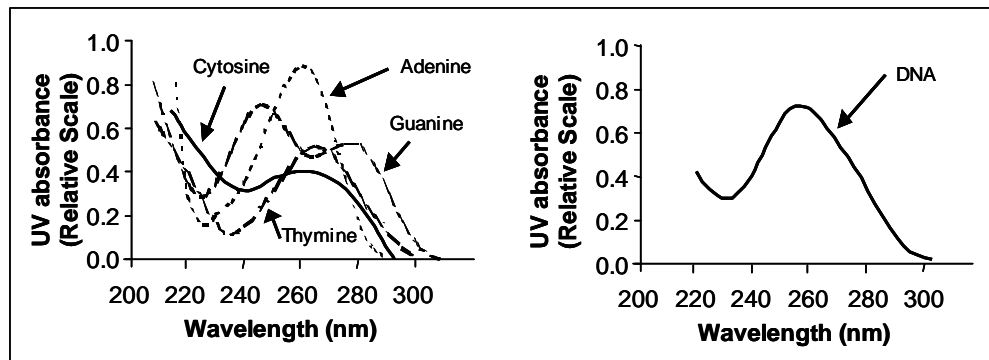
Figure 2.5. Structure of DNA and Nucleotide Sequences within DNA**Figure 2.6. UV Absorbance of Nucleotides (left) and Nucleic Acid (right) at pH 7**

Source: Adapted from Jagger (1967)

- **Pyrimidine dimers** form when covalent bonds are present between adjacent pyrimidines on the same DNA or RNA strand, and they are the most common damage resulting from UV disinfection.
- **Pyrimidine (6-4) pyrimidone photoproducts** are similar to pyrimidine dimers and form on the same sites.
- **Protein-DNA cross-links** are covalent bonds between a protein and a DNA strand, and they may be important for the disinfection of certain microorganisms.

The other three types of damage do not significantly contribute to UV disinfection: pyrimidine hydrates occur much less frequently than dimers, and single- and double-strand breaks and DNA-DNA cross-links occur only at doses that are several orders of magnitude higher than the doses typically used for UV disinfection (Jagger 1967).

Pyrimidine dimers are the most common form of nucleic acid damage, being 1000 times more likely to occur than strand breaks, DNA-DNA cross-links, and protein-DNA cross-links. Of the three possible pyrimidine dimers that can form within DNA (thymine-thymine, cytosine-cytosine, and thymine-cytosine), thymine-thymine dimers are the most common. For RNA, because thymine is not present, uracil-uracil and cytosine-cytosine dimers are formed. Microorganisms with DNA rich in thymine tend to be more sensitive to UV disinfection (Adler 1966).

Pyrimidine dimer damage and other forms of nucleic acid damage prevent the replication of the microorganism. The damage, however, does not prevent the metabolic functions in the microorganism such as respiration. UV doses capable of causing oxidative damage that prevent cell metabolism and kill the microorganism (similar to the damage caused by chemical disinfectants) are several orders of magnitude greater than doses required to damage the nucleic acid and prevent replication.

2.3.2 Microbial Repair

Many microorganisms have enzyme systems that repair damage caused by UV light. Repair mechanisms are classified as either photorepair or dark repair (Knudson 1985). Microbial repair can increase the UV dose needed to achieve a given degree of inactivation of a pathogen, but the process does not prevent inactivation.

Even though microbial repair can occur, neither photorepair nor dark repair is anticipated to affect the performance of drinking water UV disinfection, as described below:

- Photorepair of UV irradiated bacteria can be prevented by keeping the UV disinfected water in the dark for at least two hours before exposure to room light or sunlight. Treated water typically remains in the dark in the piping, reservoirs, and distribution system after UV disinfection. Most facilities also use chemical disinfection to provide further inactivation of bacteria and virus and protection of the distribution system. Both of these common practices make photorepair unlikely to be an issue for PWSs.
- Dark repair is also not a concern for PWSs because the required UV doses shown in Table 1.4 are derived from data that are assumed to account for dark repair.

2.3.2.1 Photorepair

In photorepair (or photoreactivation), enzymes energized by exposure to light between 310 and 490 nm (near and in the visible range) break the covalent bonds that form the pyrimidine dimers. Photorepair requires reactivating light and repairs only pyrimidine dimers (Jagger 1967).

Knudson (1985) found that bacteria have the enzymes necessary for photorepair. Unlike bacteria, viruses lack the necessary enzymes for repair but can repair using the enzymes of a host cell (Rauth 1965). Linden et al. (2002a) did not observe photorepair of *Giardia* at UV doses typical for UV disinfection applications (16 and 40 mJ/cm²). However, unpublished data from the same study show *Giardia* reactivation in light conditions at very low UV doses (0.5 mJ/cm²,

Linden 2002). Shin et al. (2001) reported that *Cryptosporidium* does not regain infectivity after inactivation by UV light. One study showed that *Cryptosporidium* can undergo some DNA photorepair (Oguma et al. 2001). Even though the DNA is repaired, however, infectivity is not restored.

2.3.2.2 Dark Repair

Dark repair is defined as any repair process that does not require the presence of light. The term is somewhat misleading because dark repair can also occur in the presence of light. Excision repair, a form of dark repair, is an enzyme-mediated process in which the damaged section of DNA is removed and regenerated using the existing complementary strand of DNA. As such, excision repair can occur only with double stranded DNA and RNA. The extent of dark repair varies with the microorganism. With bacteria and protozoa, dark repair enzymes start to act immediately following exposure to UV light; therefore, reported dose-response data are assumed to account for dark repair.

Knudson (1985) found that bacteria can undergo dark repair, but some lack the enzymes needed for dark repair (Knudson 1985). Viruses also lack the necessary enzymes for repair but can repair using the enzymes of a host cell (Rauth 1965). Oguma et al. (2001) used an assay that measures the number of dimers formed in nucleic acid to show that dark repair occurs in *Cryptosporidium*, even though the microorganism did not regain infectivity. Linden et al. (2002a) did not observe dark repair of *Giardia* at UV doses typical for UV disinfection applications (16 and 40 mJ/cm²). Shin et al. (2001) reported *Cryptosporidium* does not regain infectivity after inactivation by UV light.

2.3.3 UV Intensity, UV Dose, and UV Dose Distribution

UV intensity is a fundamental property of UV light and has the units of watts per meter squared (W/m²) (Halliday and Resnick 1978). UV intensity has a formal definition that is derived from Maxwell's equations, which are fundamental equations that define the wavelike properties of light. The total UV intensity at a point in space is the sum of the intensity of UV light from all directions.

UV dose is the integral of UV intensity during the exposure period (i.e., the area under an intensity versus time curve). If the UV intensity is constant over the exposure time, UV dose is defined as the product of the intensity and the exposure time. Units commonly used for UV dose are joule per meter squared (J/m²), mJ/cm², and milliwatt seconds per centimeter squared (mWs/cm²), with mJ/cm² being the most common units in North America and J/m² being the most common in Europe.⁵

In a completely mixed batch system, the UV dose that the microorganisms receive is equal to the volume-averaged UV intensity within the system. An example of a completely mixed batch system is the collimated beam study in which a petri dish containing the stirred

⁵ 10 J/m² = 1 mJ/cm² = 1 mWs/cm²

microbial solution is irradiated by a collimated UV light beam (see Appendix C for details). In this case, the average UV intensity is calculated from the measured UV intensity incident on the surface of the microbial suspension, the suspension depth, and the UV absorbance of the water (see Appendix C for details). When using polychromatic light sources (e.g., MP lamps), UV dose calculations in batch system also incorporate the intensity at each wavelength in the germicidal range and the germicidal effectiveness at the associated UV wavelengths.

Dose delivery in a continuous flow UV reactor is considerably more complex than in a completely mixed batch reactor. Some microorganisms travel close to the UV lamps and experience a higher dose, while others that travel close to the reactor walls may experience a lower dose. Some microorganisms move through the reactor quickly, while others travel a more circuitous path. The result is that each microorganism leaving the reactor receives a different UV dose. Accordingly, UV dose delivered to the microorganisms passing through the reactor is best described using a dose distribution (Cabaj et al. 1996) as opposed to a single dose value. A dose distribution can be defined as a histogram of dose delivery (see Figure 2.7). Alternatively, the dose distribution can be defined as a probability distribution that a microorganism leaving a UV reactor will receive a given dose.

Figure 2.7. Hypothetical Dose Distributions for Two Reactors with Differing Hydraulics

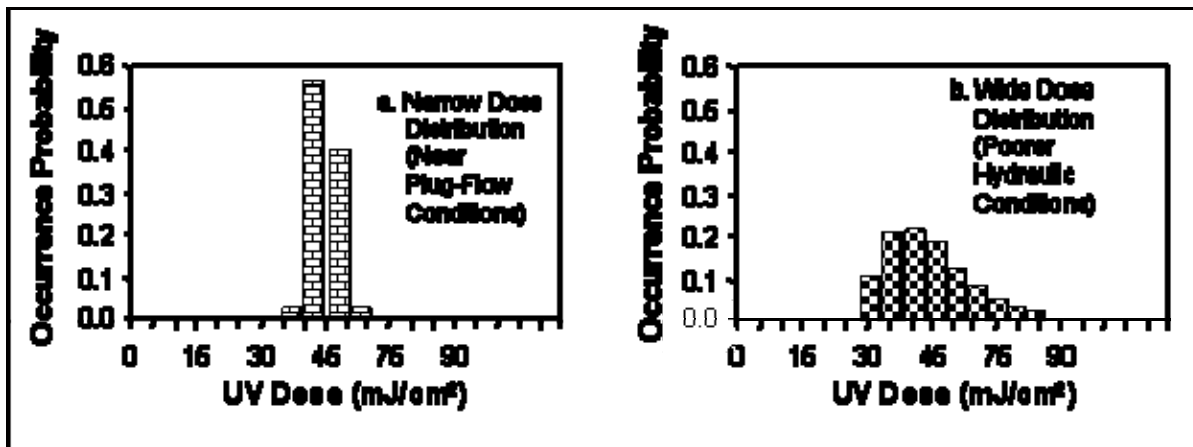

The width of the dose distribution is indicative of the dose delivery efficiency of the reactor. A narrow dose distribution (Figure 2.7a) indicates a more efficient reactor, and a wider dose distribution (Figure 2.7b) indicates a less efficient reactor. In particular, the average log inactivation a reactor achieves with a given microorganism is strongly affected by microorganisms that receive the lowest UV doses.

The dose distribution a UV reactor delivers can be estimated using mathematical models based on computational fluid dynamics (CFD) and the light intensity distribution (LID). CFD is used to predict the trajectories of microorganisms as they travel through the UV reactor. LID is used to predict the intensity at each point within the UV reactor. UV dose to each microorganism is calculated by integrating the UV intensity over the microorganism's trajectory through the reactor. Biodosimetry (discussed below) is often used to verify these modeling results.

Currently, dose delivery is measured using a technique termed biosimetry. With biosimetry, the log inactivation of a surrogate microorganism is measured through the UV reactor and related to a dose value termed the reduction equivalent dose (RED) using the UV dose-response curve of the surrogate microorganism. Methods for conducting biosimetry are presented in Chapter 5. Although alternatives to biosimetry are being developed (e.g., the use of actinometric microspheres) for measuring the dose distribution of a reactor, such methods have not yet been proven for measuring dose delivery in UV reactors.

2.3.4 Microbial Response (UV Dose-Response)

Microbial response is a measure of the sensitivity of the microorganism to UV light and is unique to each microorganism. UV dose-response is determined by irradiating water samples containing the microorganism with various UV doses using a collimated beam apparatus (as described in Appendix C of this manual) and measuring the concentration of infectious microorganisms before and after exposure. The microbial response is calculated using Equation 2.3.

$$\text{Log Inactivation} = \log_{10} \frac{N_0}{N} \quad \text{Equation 2.3}$$

where

- N_0 = Concentration of infectious microorganisms before exposure to UV light
- N = Concentration of infectious microorganisms after exposure to UV light

UV dose-response relationships can be expressed as either the proportion of microorganisms *inactivated* or the proportion of microorganisms *remaining* as a function of UV dose. Microbial inactivation has a dose-response curve with a positive slope, while microbial survival has a dose-response curve with a negative slope. This manual presents microbial response as log inactivation because the terminology is widely accepted in the industry. Therefore, all dose-response curves presented (log inactivation as a function of dose) have a positive slope with log inactivation on a logarithmic (base 10) scale and UV dose on a linear scale.

Figure 2.8 presents examples of UV dose-response curves. The shape of the UV dose-response curve typically has three regions. At low UV doses, the UV dose-response shows a shoulder region where little if any inactivation occurs (e.g., *Bacillus subtilis* curve, Figure 2.8). The shoulder region has been attributed to dark repair (Morton and Haynes 1969) and photorepair (Hoyer 1998). Above some threshold dose level, the dose-response shows first-order inactivation where inactivation increases linearly with increased dose. In many cases, the dose-response shows first-order inactivation without a shoulder (e.g., *E. coli* curve, Figure 2.8). At higher UV doses, the dose-response shows tailing, a region where the slope of the dose-response decreases with increased dose (e.g., rotavirus and total coliform curves, Figure 2.8). Tailing has been attributed to the presence of UV-resistant sub-populations of the microorganism and the presence of particulate-associated and clumped microorganisms (Parker and Darby 1995). The shape of the dose-response curve can affect validation results, and information on how to account for tailing and shoulders in validation testing is included in Section C.6.

Figure 2.8. Shapes of UV Dose-Response Curves

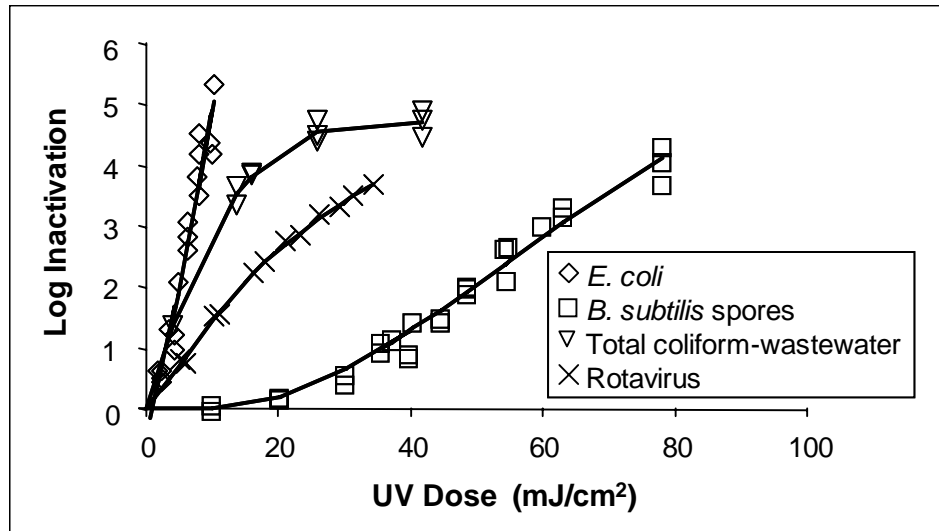

Source: Adapted from Chang et al. (1985)

Microbial response to UV light can vary significantly among microorganisms. The UV sensitivity of viruses and bacteriophage can vary by more than two orders of magnitude (Rauth 1965). With bacteria, spore-forming and gram-positive bacteria are more resistant to UV light than gram-negative bacteria (Jagger 1967). Among the pathogens of interest in drinking water, viruses are most resistant to UV disinfection followed by bacteria, *Cryptosporidium* oocysts, and *Giardia* cysts.

UV dose-response is generally independent of the following factors:

- UV intensity:** In general, UV dose-response follows the Law of Reflectivity over an intensity range of 1 – 200 mW/cm², where the same level of inactivation is achieved with a given UV dose regardless of whether that dose was obtained with a high UV intensity and low exposure time or vice versa (Oliver and Cosgrove 1975, Rice and Ewell 2001). Non-reciprocity has been observed at low intensities where repair may compete with inactivation (Sommer et al. 1998, Setlow 1967).
- UV absorbance:** UV absorbance of the suspension is considered when calculating UV dose. Increasing intensity or exposure time, however, may be necessary to achieve a constant UV dose as the absorbance of a suspension changes.
- Temperature:** Temperature effects on dose-response are minimal and depend on the microorganism. For male-specific-2 (MS2) bacteriophage, inactivation is not temperature-dependent (Malley 2000). Severin et al. (1983) studied three microorganisms to determine the dose required to achieve 2-log inactivation as a function of temperature. For *E. coli* and *Candia parapsilosis*, the dose requires decreases by less than 10 percent as the temperature increases from 5 to 35 °C, and

for f2 bacteriophage, the dose requires decreases by less than 20 percent over the same temperature interval (Severin et al. 1983).

- **pH:** Dose-response is independent of the suspension pH from pH 6 to pH 9 (Malley 2000).

Particle association and clumping of microorganisms affects UV dose-response. Small floc particles can enmesh and protect MS2 bacteriophage, and potentially other viruses, from exposure to UV light (Templeton et al. 2003). Similarly, the inactivation rate of particle-associated coliforms is slower than that of non-particle-associated coliforms (Örmeçi and Linden 2003). The shielding effect of clumping or particle association can cause a tailing or flattening of the dose-response curve at higher inactivation levels (Figure 2.8, total coliform curve).

Several studies have examined the effect of particles on UV disinfection performance. Research by Linden et al. (2002b) indicated that the UV dose-response of microorganisms added to filtered drinking waters is not altered by variation in turbidity that meets regulatory requirements for filtered effluents. For unfiltered waters, source water turbidity up to 10 nephelometric turbidity units (NTU) did not affect the UV dose-response of separately added (seeded) microorganisms (Passantino et al. 2004, Oppenheimer et al. 2002). The effect of particle enmeshment on the UV dose-response of seeded microorganisms in water has been studied by adding clays or natural particles. When coagulating suspensions containing kaolinite or montmorillonite clay using alum or ferric chloride, no difference was observed in the log inactivation of the seeded microorganisms (Templeton et al. 2004, Mamane-Gravetz and Linden 2004). When humic acid particles and a coagulant were added to the suspensions, however, significantly less inactivation was achieved (Templeton et al. 2004). Further research is needed to understand fully the effect of coagulation and particles on microbial inactivation by UV light.

2.3.5 Microbial Spectral Response

Microbial response varies as a function of wavelength of the UV light. The action spectrum (also called UV action) of a microorganism is a measure of inactivation effectiveness as a function of wavelength. Figure 2.9 illustrates the UV action spectrum for three microbial species and the UV absorbance of DNA as a function of wavelength. Because of the similarity between the UV action and DNA absorbance spectra and because DNA absorbance is easier to measure than UV action, the DNA absorbance spectrum of a microorganism is often used as a surrogate for its UV action spectrum. In Figure 2.9, the scale of the y-axis represents the ratio of inactivation effectiveness at a given wavelength to the inactivation effectiveness at 254 nm.

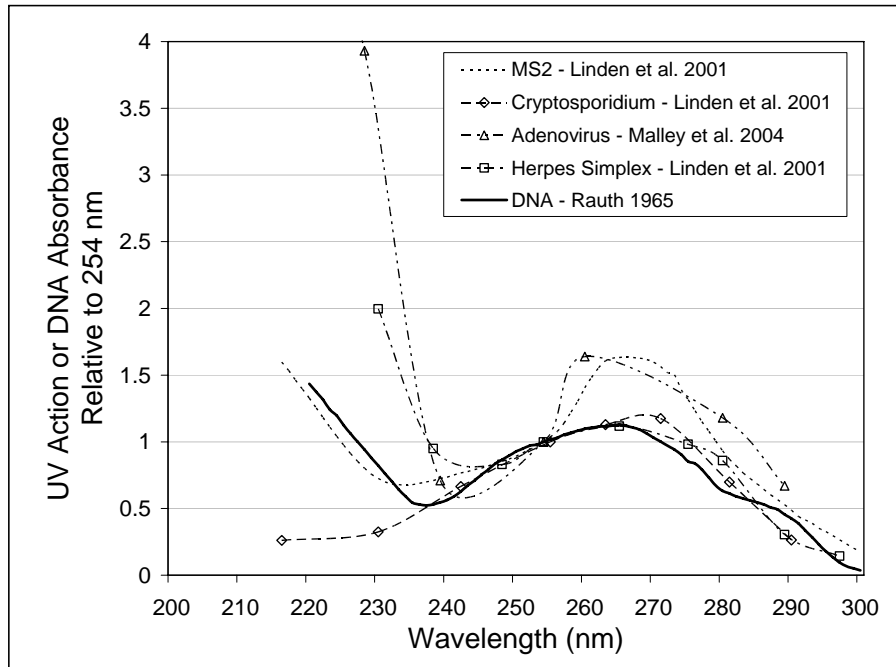
Figure 2.9. Comparison of Microbial UV Action and DNA UV Absorbance

Source: Adapted from Rauth (1965), Linden et al. (2001), and Malley et al. (2004)

For most microorganisms, the UV action peaks at or near 260 nm, has a local minimum near 230 nm, and drops to zero near 300 nm, which means that UV light at 260 nm is the most effective at inactivating microorganisms. Because no efficient way to produce UV light at 260 nm is available and mercury produces UV light very efficiently at 254 nm, however, the latter has become the standard. Although the action spectrum of various microorganisms is similar at wavelengths above 240 nm, significant differences occur at wavelengths below 240 nm (Rauth 1965).

2.4 UV Disinfection Equipment

The goal in designing UV reactors for drinking water disinfection is to efficiently deliver the dose necessary to inactivate pathogenic microorganisms. An example of UV equipment is shown in Figure 2.10. Commercial UV reactors consist of open or closed-channel vessels, containing UV lamps, lamp sleeves, UV sensors, and temperature sensors. UV lamps typically are housed within the lamp sleeves, which protect and insulate the lamps. Some reactors include automatic cleaning mechanisms to keep the lamp sleeves free of deposits. UV sensors, flow meters, and, in some cases, UVT analyzers, are used to monitor dose delivery by the reactor. This section briefly describes the components of the UV equipment and its monitoring systems.

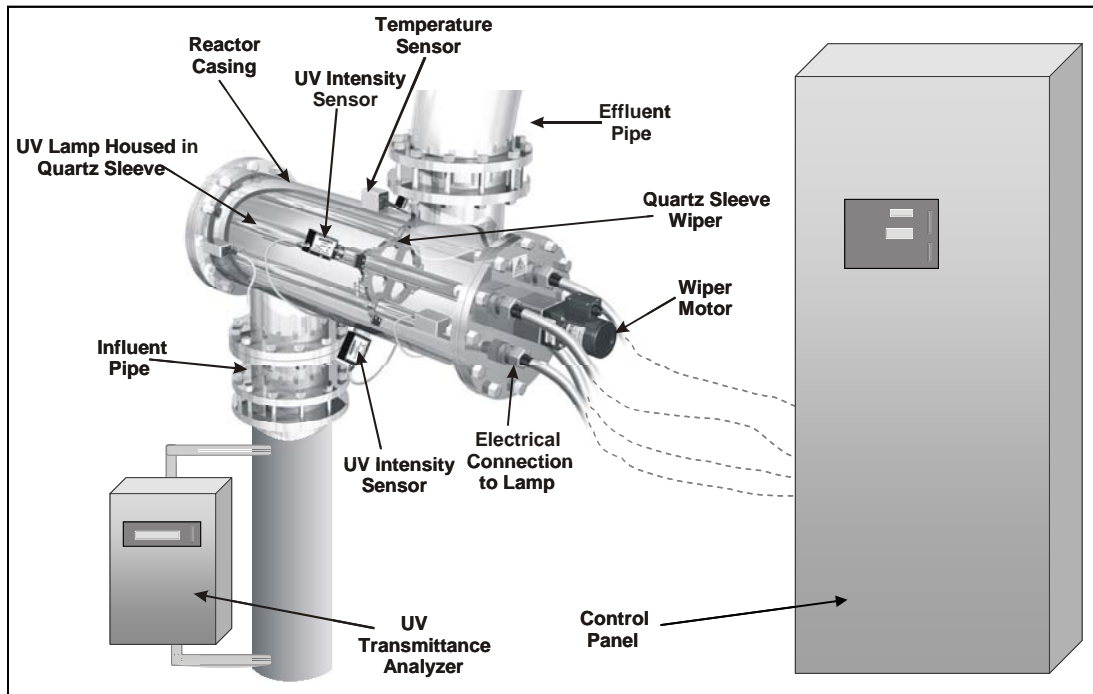
Figure 2.10. Example of UV Disinfection Equipment

Source: Courtesy of and adapted from Severn Trent Services
 Note: Not to scale

2.4.1 UV Reactor Configuration

UV reactors are typically classified as either closed or open channel. Water flows under pressure (i.e., no free surface) in closed-channel reactors (Figure 2.11a). Drinking water UV applications have used only closed reactors to date. Open-channel reactors (Figure 2.11b) are open basins with channels containing racks of UV lamps and are most commonly used in wastewater applications.

Figure 2.11. Examples of UV Reactors: (a) Closed-channel and (b) Open-channel

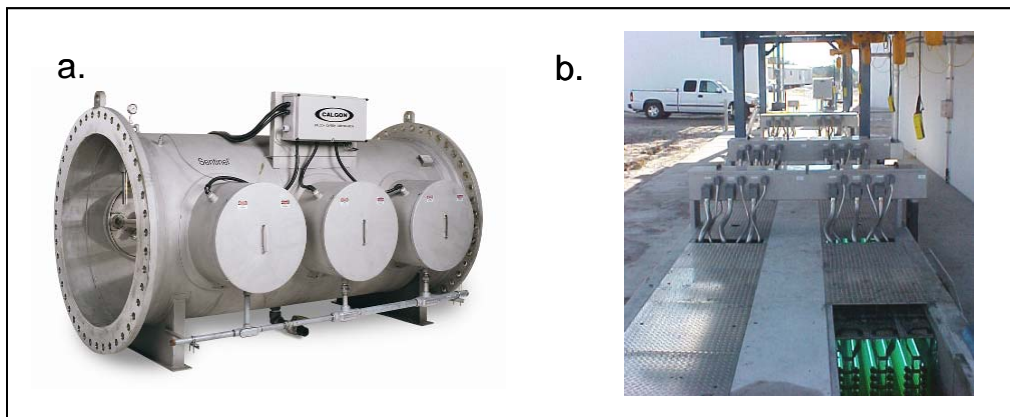

Source: (a) Courtesy of Calgon Carbon Corporation and (b) Courtesy of WEDECO UV Systems

UV equipment manufacturers design their UV reactors to provide efficient and cost-effective dose delivery. Lamp placement, baffles, and inlet and outlet conditions all affect mixing within a reactor and dose delivery. Individual reactor designs use various methods to optimize dose delivery (e.g., higher lamp output versus lower lamp output and improved hydrodynamics through increased head loss).

The lamp configuration in a reactor is designed to optimize dose delivery. In a reactor with a square cross-section, lamps are typically placed with lamp arrays perpendicular to flow. This pattern may be staggered to improve disinfection efficiency. With a circular cross-section, lamps typically are evenly spaced on one or more concentric circles parallel to flow. However, UV lamps may be oriented parallel, perpendicular, or diagonal to the flow direction. Depending on the reactor installation, lamps may consequently be oriented horizontally, vertically, or diagonally relative to the ground surface. Orienting MP lamps parallel to the ground prevents overheating at the top of the lamps and reduces the potential for lamp breakage due to temperature differentials.

The thickness of the water layer between lamps and between the lamps and the reactor wall influences dose delivery. If the water layer is too thin, the reactor wall and adjacent lamps will absorb UV light. If the water layer is too thick, water will pass through regions of lower UV intensity and experience a lower UV dose. The optimal spacing between lamps depends on the UVT of the water, the output of the lamp, and the hydraulic mixing within the reactor.

The flow through UV reactors is turbulent. Residence times are on the order of tenths of a second for MP lamps and seconds for LP lamps. In theory, optimal dose delivery is obtained with plug flow hydraulics through a UV reactor. In practice, however, UV reactors do not have such ideal hydrodynamics. For example, turbulence and eddies form in the wake behind lamp sleeves oriented perpendicularly to flow. Some manufacturers insert baffles to improve hydrodynamics in the reactor. Improvements to the hydraulic behavior of a reactor are often obtained at the expense of head loss.

Inlet and outlet conditions can significantly affect reactor hydrodynamics and UV dose delivery. For example, changes in flow direction of 90 degrees at inlets and outlets promote short-circuiting, eddies, and dead zones within the reactor. Straight inlet configurations with gradual changes in cross-sectional area will help create flow conditions for optimal dose delivery.

2.4.2 UV Lamps

UV light can be produced by the following variety of lamps:

- LP mercury vapor lamps
- Low-pressure high-output (LPHO) mercury vapor lamps
- MP mercury vapor lamps
- Electrode-less mercury vapor lamps
- Metal halide lamps

- Xenon lamps (pulsed UV)
- Eximer lamps
- UV lasers
- Light emitting diodes (LEDs)

Full-scale drinking water applications generally use LP, LPHO, or MP mercury vapor lamps. Therefore, this manual limits discussion to these UV lamp technologies. Table 2.1 lists characteristics of these lamps, and Table 2.2 lists operational advantages of the lamp types.

Table 2.1. Typical Mercury Vapor Lamp Characteristics

Parameter	Low-pressure	Low-pressure High-output	Medium-pressure
Germicidal UV Light	Monochromatic at 254 nm	Monochromatic at 254 nm	Polychromatic, including germicidal range (200 – 300 nm)
Mercury Vapor Pressure (Pa)	Approximately 0.93 (1.35x10 ⁻⁴ psi)	0.18 – 1.6 (2.6x10 ⁻⁵ – 2.3x10 ⁻⁴ psi)	40,000 – 4,000,000 (5.80 – 580 psi)
Operating Temperature (°C)	Approximately 40	60 – 100	600 – 900
Electrical Input [watts per centimeter (W/cm)]	0.5	1.5 – 10	50 – 250
Germicidal UV Output (W/cm)	0.2	0.5 – 3.5	5 – 30
Electrical to Germicidal UV Conversion Efficiency (%)	35 – 38	30 – 35	10 – 20
Arc Length (cm)	10 – 150	10 – 150	5 – 120
Relative Number of Lamps Needed for a Given Dose	High	Intermediate	Low
Lifetime [hour (hr)]	8,000 – 10,000	8,000 – 12,000	4,000 – 8,000

Note: Information in this table was compiled from UV manufacturer data.

Table 2.2. Mercury Vapor Lamp Operational Advantages

Low-pressure and Low-pressure High-output	Medium-pressure
<ul style="list-style-type: none"> • Higher germicidal efficiency; nearly all output at 254 nm • Smaller power draw per lamp (less reduction in dose if lamp fails) • Longer lamp life 	<ul style="list-style-type: none"> • Higher power output • Fewer lamps for a given application

LP, LPHO, and MP lamps consist of the following elements, arranged as shown in Figure 2.12:

- **Lamp Envelope:** The envelope of the lamp is designed to transmit germicidal UV light, act as an electrical insulator, and not react with the lamp's fill gases. A non-crystalline form of quartz, vitreous silica, is often used for the lamp envelope because of its high UVT and its resistance to high temperatures. The UVT of the envelope affects the spectral output of lamps, especially with MP lamps at lower wavelengths. Because of this, lamp envelopes can be made from doped quartz (quartz that is altered to absorb specific wavelengths) to prevent undesirable non-germicidal photochemical reactions. Envelopes are approximately 1 – 2 millimeters (mm) thick, and the diameter is selected to optimize the UV output and lamp life.
- **Electrodes:** Electrode design and operation are critical for reliable long-term operation of lamps. Electrodes promote heat transfer so that lamps can operate at an appropriate temperature. The electrodes in LP and LPHO lamps are made of a coil of tungsten wire embedded with oxides of calcium, barium, or strontium. In MP lamps, electrodes consist of a tungsten rod wrapped in a coil of tungsten wire.
- **Mercury Fill:** The mercury fill present in UV lamps can be in the solid, liquid, or vapor phase. Amalgams (alloys of mercury and other metals such as indium or gallium in the solid phase) are typically used in LPHO lamps, while LP and MP lamps contain liquid elemental mercury. As the lamps heat, the vapor pressure of mercury increases. LP and LPHO lamps operate at lower temperatures and have lower mercury vapor pressures than MP lamps. In MP lamps, the concentration of mercury in the vapor phase is controlled by the amount of mercury in the lamp. In LPHO lamps, an excess of mercury is placed in the lamp, and the amount of mercury entering the vapor phase is limited by either a mercury amalgam attached to the lamp envelope, a cold spot on the lamp wall, or a mercury condensation chamber located behind each electrode.
- **Inert Gas Fill:** In addition to mercury, lamps are filled with an inert gas (typically argon). The inert gas aids in starting the gas discharge and reduces deterioration of the electrode. The vapor pressure of the inert gas is typically 0.02 – 1 psi.

In addition to amalgam LPHO lamps, another method is used to increase the output from LP lamps. In this application, a standard LP lamp with reinforced filaments is used, allowing for an increase in current through the lamp. The higher current increases the output from the lamp.

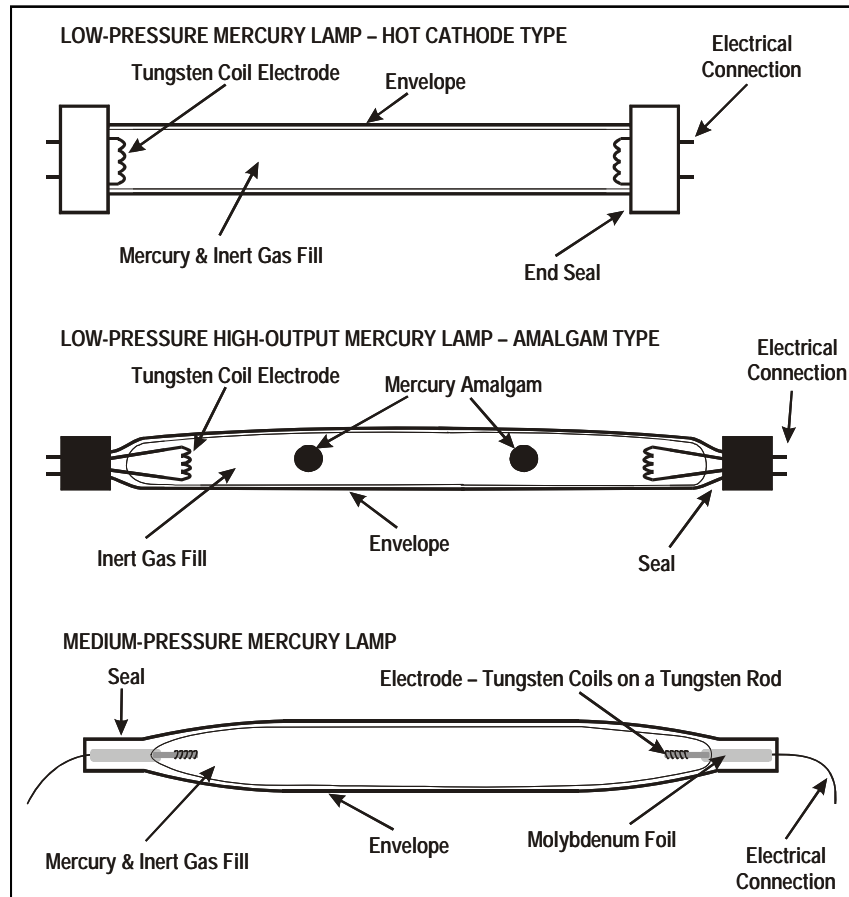
Figure 2.12. Construction of a UV Lamp

2.4.2.1 Lamp Start-up

As lamps start up, the following series of events occurs to generate an arc (i.e., produce UV light). First, the electrode emits electrons that collide with the inert gas atoms, causing the inert gas to ionize. This creates a plasma that allows current to flow, which heats the gas. The mercury in operating lamps vaporizes in the presence of the hot inert gas, and collisions between the vapor-phase mercury and high-energy electrons in the plasma cause the mercury atoms to reach one of many excited states. As the mercury returns from a given excited state to ground state, energy is released (according to the difference in the state energies) in the wavelength range of the UV spectrum.

2.4.2.2 Lamp Output

The light that LP and LPHO lamps emit is essentially monochromatic at 253.7 nm (Figure 2.13a) in the ultraviolet range and is near the maximum of the microbial action spectrum. These lamps also emit small amounts of light at 185, 313, 365, 405, 436, and 546 nm due to higher energy electron transition in the mercury. Lamp output at 185 nm promotes ozone

formation. Because ozone is corrosive, toxic, and absorbs UV light, LP and LPHO lamps used in water disinfection applications are manufactured to reduce the output at 185 nm.

Figure 2.13. UV Output of LP (a) and MP (b) Mercury Vapor Lamps

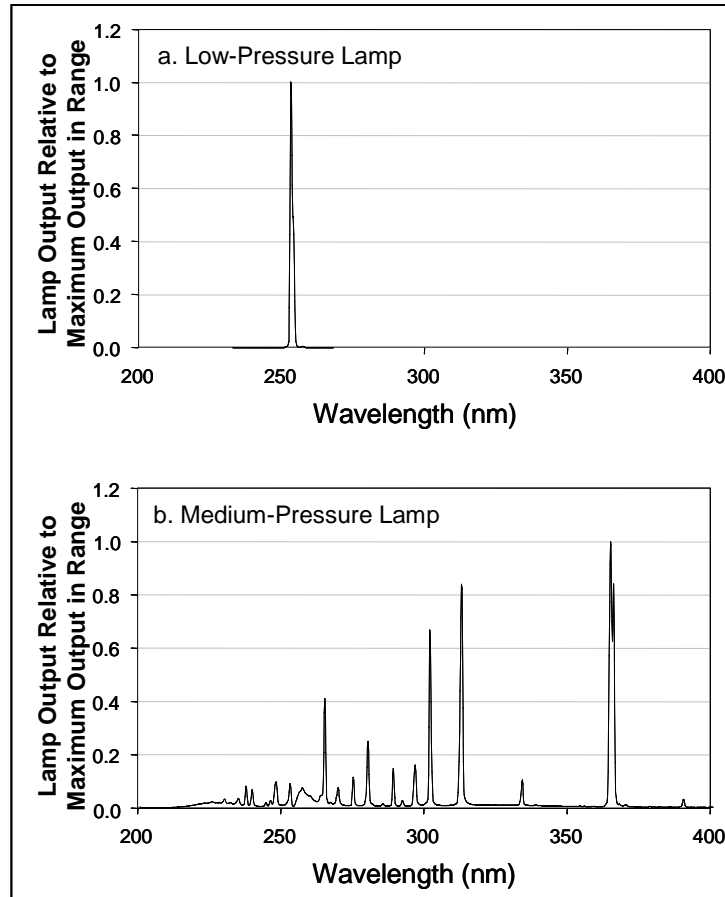

Source: Sharpless and Linden (2001)

MP lamps emit a wide range of UV wavelengths from 200 to 400 nm (Figure 2.13b). The combination of free electrons and mercury in the lamp creates a broad continuum of UV energy below 245 nm. Electron transitions in the mercury cause the peaks in the spectrum.

All UV lamps also emit light in the visible range. Visible light can promote algal growth as discussed in Section 2.5.1.5.

Figure 2.14 shows the output of LP and MP lamps superimposed on the DNA absorption spectrum. In Figure 2.14, the DNA absorbance is plotted relative to the maximum absorbance in the range (260 nm), and the lamp outputs are presented on a relative scale. In absolute terms, however, the intensity and power of LP and MP lamps differ significantly (see Table 2.1 for more information on lamp operating characteristics).

Figure 2.14. UV Lamp Output and its Relationship to the UV Absorbance of DNA

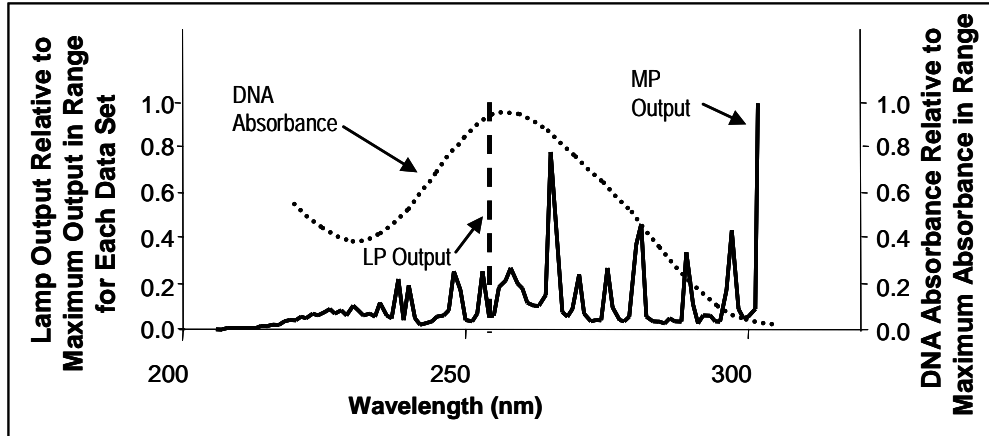

Source: Courtesy of Bolton Photosciences, Inc.

2.4.2.3 Lamp Sensitivity to Power Quality

A UV lamp can lose its arc if a voltage fluctuation, power quality anomaly, or power interruption occurs. For example, voltage sags that vary more than 10 – 30 percent from the nominal voltage for as few as 0.5 – 3 cycles (0.01 – 0.05 seconds) may cause a UV lamp to lose its arc.

The most common sources of power quality problems that may cause UV lamps to lose their arcs are as follows:

- Faulty wiring and grounding
- Off-site accidents (e.g., transformer damaged by a car accident)
- Weather-related damage
- Animal-related damage
- Facility and equipment modifications
- Starting or stopping equipment with large electrical needs on the same circuit at the water plant
- Power transfer to emergency generator or alternate feeders

LP lamps generally can return to full operating status within 15 seconds after power is restored. LPHO and MP reactors that are more typically used in drinking water applications, however, exhibit significant restart times if power is interrupted. The start-up time for lamps should be considered in the design of UV disinfection systems as start-up time can contribute to off-specification operations (see Section 3.4.1). The start-up and restart behaviors for LPHO and MP lamps are summarized in Table 2.3.

Table 2.3. Typical Start-up and Restart Times for LPHO and MP Lamps¹

Lamp Type	Cold Start ²	Warm Start ³
LPHO	total time: 4 – 7 minutes (min) (0 – 2 min warm-up plus 4 – 5 min to full power)	total time: 2 – 7 min (0 – 2 min warm-up plus 2 – 5 min to full power)
MP	total time: 1 – 5 min (No warm-up or cool down plus 1 – 5 min to full power ⁴)	total time: 4 – 10 min (2 – 5 min cool down plus 2 – 5 min to full power ⁴)

¹ Information shown in table is compiled from Calgon Carbon Corporation, Severn Trent, Trojan, and WEDECO. Contact the manufacturer to determine the start-up and restart times for specific equipment models.

² A cold start occurs when UV lamps have not been operating for a significant period of time.

³ A warm start occurs when UV lamps have just lost their arcs (e.g., due to voltage sag).

⁴ 60 percent intensity is reached after 3 min.

Source: Cotton et al. (2005)

The effects of temperature can increase or decrease the times listed in Table 2.3 and should be discussed with the UV manufacturer. Individual manufacturers report that colder water temperatures (below 10 °C) can result in slower start-ups for LPHO lamps than those listed in Table 2.3. Conversely, MP manufacturers report shorter restart times with colder temperatures because the cold water accelerates the condensation of mercury (i.e., cool down), which is necessary for re-striking the arc.

2.4.2.4 Lamp Aging

UV lamps degrade as they age, resulting in a reduction in output that causes a drop in UV dose delivery over time. Lamp aging can be accounted for with the fouling/aging factor (described in Section 3.4.5) in the design of the UV facility.

Lamp degradation occurs with both LP and MP lamps and is a function of the number of lamp hours in operation, number of on/off cycles, power applied per unit (lamp) length, water temperature, and heat transfer from lamps. The rate of decrease in lamp output often slows as the lamp ages (Figure 2.15). The reduction in output occurs at all wavelengths across the germicidal range as shown in Figure 2.16, which is an example of MP lamp output reduction after 8,220 hours of operation.

Preliminary findings from ongoing research into lamp aging at water and wastewater UV facilities shows that LPHO and MP lamp aging is non-uniform with respect to axial and horizontal output and varies greatly from lamp to lamp (Mackey et al. 2005). The lamp aging study by Mackey et al. is still ongoing, and any future findings from this or other studies should be evaluated and considered once results are available.

Figure 2.15. Reduction in UV Output of (a) LPHO and (b) MP Lamps Over Time

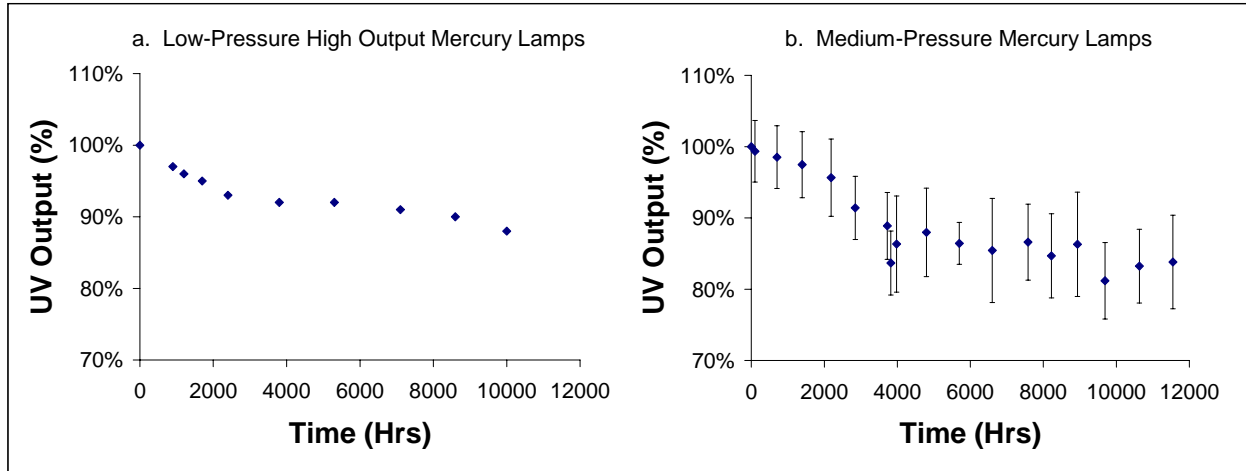

Source: (a) Adapted from WEDECO, (b) adapted from Linden et al. (2004)

Figure 2.16. Lamp Aging for an MP Lamp

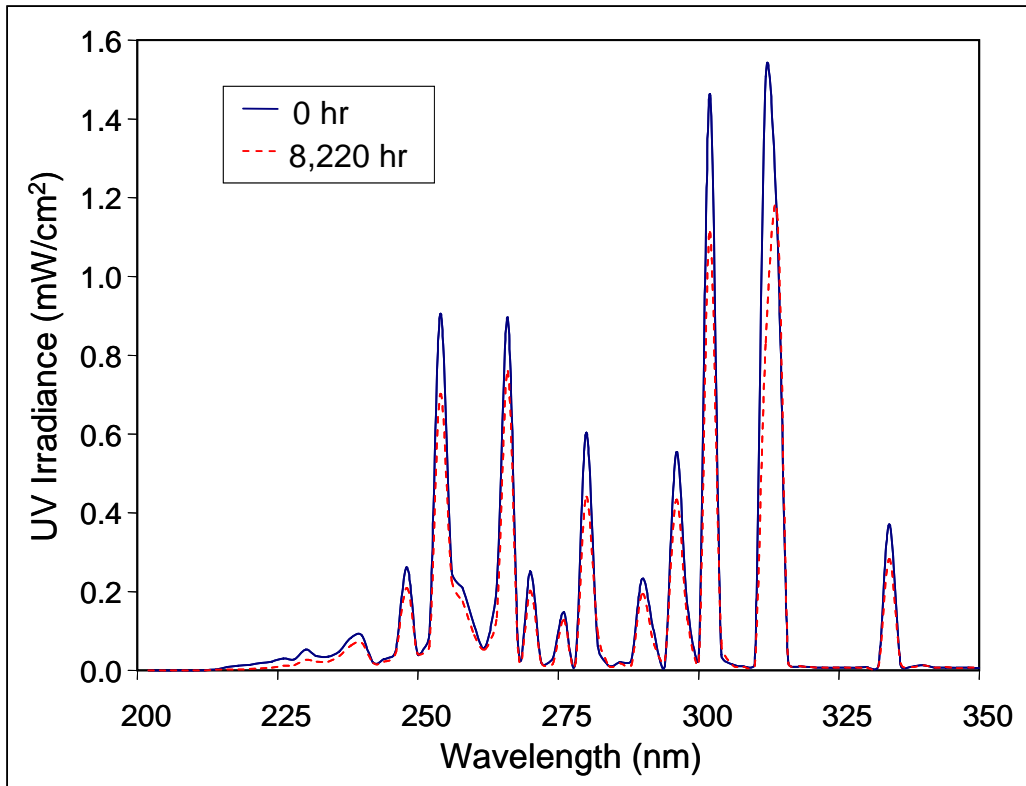

Source: Adapted from Linden et al. (2004)

Any deposits on the inner or outer surfaces of the lamp envelope and metallic impurities within the envelope can absorb UV light and cause premature lamp aging. In LP and LPHO lamps using UV-transmitting glass, mercury may combine with sodium in the glass to create a UV-absorbing coating. Electrode sputtering during start-up can also coat the inside surface of the lamp envelope with tungsten as the lamp ages. The tungsten coating is black, non-uniform, concentrated within a few inches of the electrode, and can absorb UV light (Figure 2.17). If the lamps are not sufficiently cooled during operation, electrode material in MP lamps may evaporate and condense on the inside of the envelope.

Figure 2.17. Aged UV Lamp (right) Compared to a New UV Lamp (left)

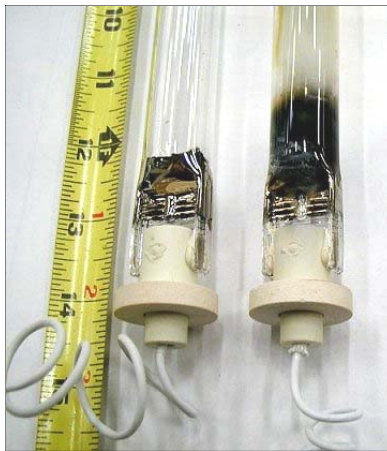

Source: Mackey et al. (2004)

UV lamp manufacturers can reduce electrode sputtering by designing lamps that pre-heat the electrode before applying the start voltage, are driven by a sinusoidal current waveform, or have a higher argon (inert gas) content. Electrode sputtering can be reduced by minimizing the number of lamp starts during operation.

2.4.3 Ballasts

Ballasts are used to regulate the incoming power supply at the level needed to energize and operate the UV lamps. Power supplies and ballasts are available in many different configurations and are tailored to a unique lamp type and application. UV reactors typically use magnetic ballasts or electronic ballasts.

Electronic and magnetic ballasts each have specific advantages and disadvantages. UV reactor manufacturers consider these advantages and disadvantages when determining what technology to incorporate into their equipment designs. Electronic and inductor-based magnetic ballasts can provide almost continuous adjustment of lamp intensity. Most transformer-based magnetic ballasts, however, allow only step adjustment of lamp intensity. Transformer-based magnetic ballasts are typically more electrically efficient than inductor-based ballasts but are less efficient than electronic ballasts. However, higher efficiency and additional features can increase

the electronic ballast cost. UV lamps that are powered by magnetic ballasts tend to have more lamp end-darkening (i.e., electrode sputtering) and have shorter lives compared to lamps powered by electronic ballasts due to the higher frequencies used by electronic ballasts. Electronic ballasts are generally more susceptible to power quality problems (Section 2.4.2.3) compared to magnetic ballasts; however, the power quality tolerances of both ballast types depend on the electrical design. A comparison of magnetic and electronic ballast technologies is shown in Table 2.4.

Table 2.4. Comparison of Magnetic and Electronic Ballasts

Magnetic Ballast	Electronic Ballast
<ul style="list-style-type: none"> • Less expensive • Continuous power adjustment occurs with inductor-based magnetic ballast (but not with transformer-based magnetic ballast) • More resistant to power surges • Proven technology (in use for nearly 70 years) • Greater separation distance allowed between the UV reactor and control panel 	<ul style="list-style-type: none"> • Continuous power adjustment and ability to adjust to lower power levels (e.g., 30 %) • More power efficient • Lighter weight and smaller size • Allows for longer lamp operating life and less lamp end-darkening

2.4.4 Lamp Sleeves

UV lamps are housed within lamp sleeves to help keep the lamp at optimal operating temperature and to protect the lamp from breaking. Lamp sleeves are tubes of quartz (vitreous silica) that are open at one or both ends. The sleeve length is sufficient to include the lamp and associated electrical connections. The sleeve diameter is typically 2.5 – 5.0 cm for LP and LPHO lamps and 3.5 – 10.0 cm for MP lamps. The distance between the exterior of the lamp and interior of the lamp sleeve is approximately 1 cm. The positioning of the UV lamp along the length of the sleeve can vary, depending on reactor configuration. Lamp sleeves absorb some UV light (Figure 2.18), which may influence dose delivery by the reactor.

Figure 2.18. UVT of Quartz that is 1 mm Thick at a Zero-degree Incidence Angle

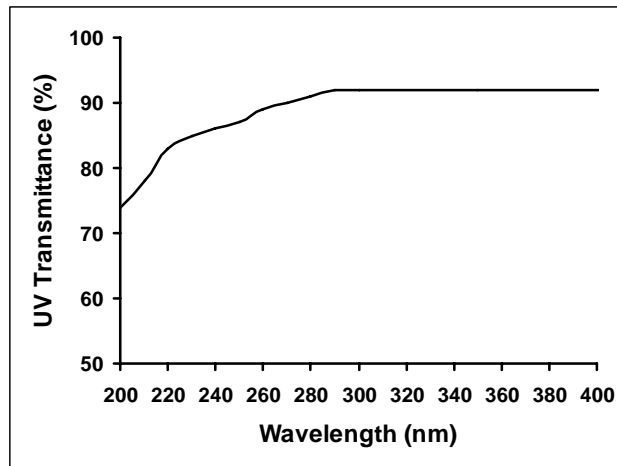

Source: GE Quartz (2004a)

The lamp sleeve assemblies are sealed to prevent water condensation within the sleeve and contain any ozone formed between the lamp envelope and lamp sleeve. Components within the sleeve should withstand exposure to UV light, ozone, and high temperatures. If the components are not made of the appropriate material, UV light exposure can cause component deterioration and off-gassing of any impurities present in the quartz sleeve. Off-gassed materials can form UV-absorbing deposits on the inner surfaces of the lamp sleeve. Off-gassing and ozone formation are of greater concern with MP lamps because they operate at a higher temperature and emit low-wavelength ozone-forming UV light. Off-gassing can be minimized through proper manufacturing of the lamp sleeves.

Lamp sleeves are vulnerable to fractures. Fractures can occur from internal stress and external mechanical forces such as wiper jams, water hammer, resonant vibration, and impact by objects. Fractures may also occur if lamp sleeves are not handled properly when removed for manual cleaning. Most lamp sleeves are designed to withstand continuous positive pressures of at least 120 pounds per square inch gauge (psig) (Roberts 2000, Aquafine 2001, Dinkloh 2001). However, pressures of negative 1.5 psig have been shown to adversely affect sleeve integrity (Dinkloh 2001). Section 4.1.4 discusses design considerations to reduce the potential for pressure-related incidents. If a lamp sleeve fractures while in service, water can enter the sleeve. The temperature difference between the hot lamp and cooler water may cause the lamp to break. Lamp breaks are undesirable due to the potential for mercury release. Appendix E discusses the lamp sleeve and lamp breaks. The tolerance level of the sleeve depends on the quality of the quartz and the sleeve's thickness and length.

Lamp sleeves can also foul, decreasing the UVT of the lamp sleeve. Fouling on the internal lamp sleeve surface arises from the deposition of material from components within the lamp or sleeve due to temperature and exposure to UV light. The UV reactor manufacturer can control internal lamp sleeve fouling through appropriate material selection. For example, some UV reactors using LP or LPHO lamps have sleeves made of Teflon[®] or Teflon-coated quartz. Teflon sleeves have a lower UVT, however, and their transmittance reduces faster than quartz

sleeves without Teflon. Deposition of compounds in the water on the lamp sleeve surface cause fouling on external surfaces. A combination of thermal effects and photochemical processes causes the external fouling (Derrick and Blatchley 2005). Some compounds that may contribute to fouling are discussed in Section 2.5.1. External fouling can be removed by cleaning.

Solarization can also decrease the UVT of the sleeve. Solarization is photo-thermal damage to the quartz that increases light scattering and attenuation (Polymicro Technologies 2004). Quartz solarizes if exposed to prolonged high energy radiation such as UV light. Resistance to this type of solarization increases as the purity of the quartz increases. Solarization on quartz can be reversed by heating the quartz to about 500 °C (GE Quartz 2004b).

2.4.5 Cleaning Systems

UV reactor manufacturers have developed different approaches for cleaning lamp sleeves, depending on the application. These approaches include off-line chemical cleaning (OCC), on-line mechanical cleaning (OMC), and on-line mechanical-chemical cleaning (OMCC) methods.

For OCC systems, the reactor is shut down, drained, and flushed with a cleaning solution. Solutions used to clean lamp sleeves include citric acid, phosphoric acid, or a solution the UV reactor manufacturer provides that is consistent with National Sanitation Foundation International/American National Standards Institute (NSF/ANSI) 60 Standard (Drinking Water Treatment Chemicals – Health Effects). The reactor is filled with the cleaning solution for a time sufficient to dissolve the substances fouling the sleeves (approximately 15 minutes), rinsed, and returned to operation. The entire cleaning cycle typically lasts approximately 3 hours. Alternatively, instead of rinsing the UV reactor with a cleaning solution, the sleeves can be removed and manually cleaned. Some LPHO UV equipment uses OCC systems. The frequency of OCC can range from monthly to yearly and depends on the site-specific water quality and degree and frequency of fouling.

OMC and OMCC systems use wipers that are attached to electric motors or pneumatic piston drives. In OMC systems, mechanical wipers may consist of stainless steel brush collars or Teflon rings that move along the lamp sleeve (Figure 2.19a). In OMCC systems, a collar filled with cleaning solution moves along the lamp sleeve (Figure 2.19b). The wiper physically removes fouling on the lamp sleeve surface while the cleaning solution within the collar dissolves fouling materials.

Figure 2.19. Examples of (a) Mechanical Wiper System and (b) Mechanical-chemical Wiper System

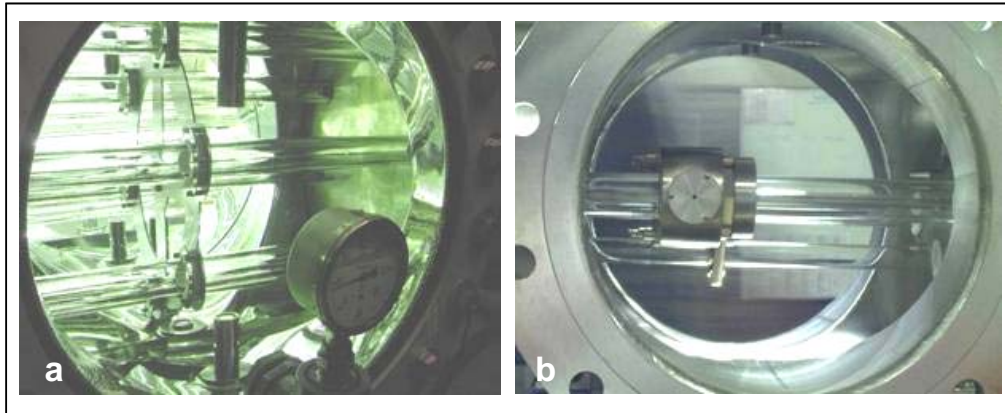

Source: (a) Courtesy of Infilco Degremont, (b) Courtesy of Trojan Technologies

Draining the reactor is unnecessary when mechanical and mechanical-chemical wipers are used. Therefore, the reactor can remain on-line while the lamp sleeves are cleaned. MP equipment typically uses OMC or OMCC systems because the higher lamp temperatures can accelerate fouling under certain water qualities. The cleaning frequency for these OMC and OMCC systems ranges from 1 – 12 cycles per hour (Mackey et al. 2004).

2.4.6 UV Sensors

UV sensors measure the UV intensity at a point within the UV reactor (Figure 2.20) and are used with measurements of flow rate and, potentially, UVT to indicate UV dose delivery. The measurement responds to changes in lamp output due to lamp power setting, lamp aging, lamp sleeve aging, and lamp sleeve fouling. Depending on sensor position, UV sensors may also respond to changes in UVT of the water being treated. UV sensors comprise optical components, a photodetector, an amplifier, its housing, and an electrical connector. The optical components may include monitoring windows, light pipes, diffusers, apertures, and filters. Monitoring windows and light pipes deliver light to the photodetector. Diffusers and apertures reduce the amount of UV light reaching the photodetector, thereby reducing the sensor degradation that UV light causes. Optical filters modify the spectral response such that the sensor responds only to germicidal wavelengths (i.e., 200 – 300 nm). Verification of sensor performance is described in Chapter 5.

Figure 2.20. Example of a Dry UV Sensor Mounted on a UV Reactor



Source: Courtesy of WEDECO

UV sensors can be classified as dry or wet. Dry sensors monitor UV light through a monitoring window, whereas wet UV sensors directly contact the water flowing through the reactor. Monitoring windows and the wetted ends of wet sensors can foul over time and may require cleaning similar to lamp sleeves.

2.4.7 UVT Analyzers

As stated previously, UVT is an important parameter in determining UV dose delivery. UVT analyzers are essential if UVT is part of the dose-monitoring strategy (see Section 2.4.9 for a discussion of dose monitoring approaches). If UVT is not part of the dose-monitoring strategy, analyzers may be provided for the purpose of monitoring water quality and helping to diagnose operational problems. Several commercial UV reactors use the measurement of UVT to calculate UV dose in the reactor and, if necessary, change lamp output or the number of energized lamps to maintain appropriate UV dose delivery.

Two types of commercial on-line UVT analyzers are available. One analyzer calculates UVT by measuring the UV intensity at various distances from a lamp. This type of analyzer is schematically displayed in Figure 2.21. In this analyzer, which is external to the UV reactor, a stream of water passes through a cavity containing an LP lamp with three UV sensors located at various distances from the lamp. The difference in sensor readings is used to calculate UVT.

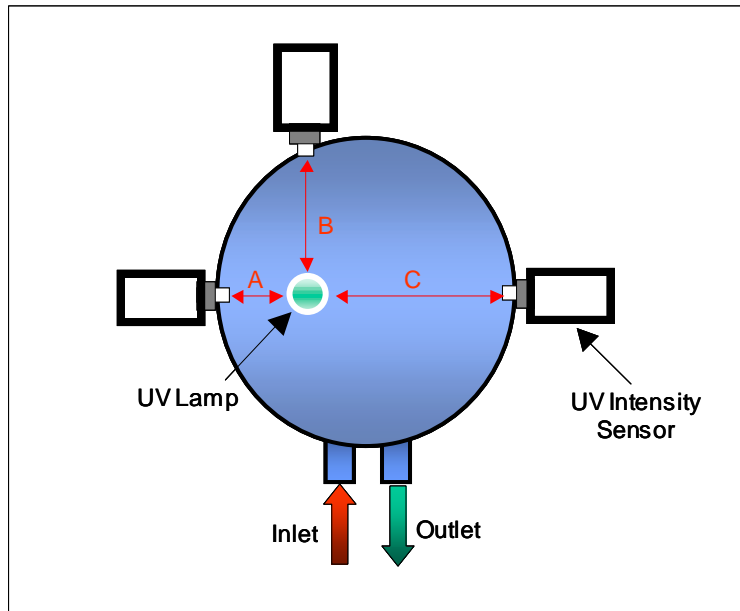
Figure 2.21. Example UVT Analyzer Design

Source: Courtesy of Severn Trent Services

The other type of on-line UVT analyzer is a flow-through spectrophotometer that uses a monochromatic UV light source at 253.7 nm. The instrument measures the A_{254} and calculates and displays UVT.

2.4.8 Temperature Sensors

The energy input to UV reactors that is not converted to light (approximately 60 – 90 percent, depending on lamp and ballast assembly) is wasted as heat. As it passes through a reactor, water can absorb the heat, keeping the reactor from overheating. Nevertheless, temperatures can increase when either of the following events occurs:

- Water level in the reactor drops and lamps are exposed to air.
- Water stops flowing in the reactor.

UV reactors can be equipped with temperature sensors that monitor the water temperature within the reactor. If the temperature is above the recommended operating range, the reactor will shut off to minimize the potential for the lamps to overheat. Because of the high operating temperature of MP lamps, dissipating heat can be more difficult than in reactors that use LP or LPHO lamps. As such, UV reactors with MP lamps typically have temperature sensors; however, reactors with LP or LPHO lamps may not because of the lower lamp operating temperature.

2.4.9 UV Reactor Dose-Monitoring Strategy

The dose-monitoring strategy establishes the operating parameters used to confirm UV dose delivery. This guidance manual focuses on UV reactors that use one of these two strategies, described below. Other existing dose-monitoring strategies or new strategies developed after this manual is published, however, may also be suitable for reactor operations provided they meet minimum regulatory requirements.⁶

1. **UV Intensity Setpoint Approach.** This approach relies on one or more “setpoints” for UV intensity that are established during validation testing to determine UV dose. During operations, the UV intensity as measured by the UV sensors must meet or exceed the setpoint(s) to ensure delivery of the required dose. Reactors must also be operated within validated operation conditions for flow rates and lamp status [40 CFR 141.720(d)(2)]. In the UV Intensity Setpoint Approach, UVT does not need to be monitored separately. Instead, the intensity readings by the sensors account for changes in UVT. The operating strategy can be with either a single setpoint (one UV intensity setpoint is used for all validated flow rates) or a variable setpoint (the UV intensity setpoint is determined using a lookup table or equation for a range of flow rates).
2. **Calculated Dose Approach.** This approach uses a dose monitoring equation to estimate the UV dose based on the flow rate, UV intensity, and UVT, as measured during reactor operations. The dose monitoring equation may be developed by the UV manufacturers using numerical methods; however, EPA recommends that water systems use an empirical dose monitoring equation developed through validation testing. During reactor operations, the UV reactor control system inputs the measured parameters into the dose monitoring equation to produce a calculated dose. The water system operator divides the calculated dose by the Validation Factor (see Chapter 5 for more details on the Validation Factor) and compares the resulting value to the required dose for the target pathogen and log inactivation level.

The dose-monitoring strategies are described in more detail in Section 3.5.2. Any dose monitoring strategy must be evaluated during reactor validation (as described in Section 5.1), and the outputs measured during validation will be part of the monitoring requirements described in Section 6.4.1 [40 CFR 141.720(d)].

2.5 Water Quality Effects and Byproduct Formation

Constituents in the water to be treated can affect the performance of UV disinfection. Additionally, all disinfectants can form byproducts, and the goal of the overall disinfection process is to maximize disinfection while controlling byproduct formation. This section

⁶ At a minimum, water systems must monitor flow rate, lamp status, and UV intensity plus any other parameters required by the State to show that a reactor is operating within validated conditions [40 CFR 141.720(d)(3)(i)].

discusses water quality characteristics affecting UV disinfection performance and the byproducts that may form during the UV disinfection process.

2.5.1 Effect of Water Quality on UV Reactor Performance

UVT, particle content, upstream water treatment processes, constituents that foul reactor components, and algae affect the performance of UV reactors. These effects can be adequately addressed through proper design of the UV disinfection equipment. The design guidelines are discussed in Section 3.4.

2.5.1.1 UVT

UVT has a strong effect on the dose delivery of a UV reactor. As UVT decreases, the intensity throughout the reactor decreases, which reduces the dose the reactor delivers. UV reactors are typically sized to deliver the required UV dose under specified UVT conditions for the application. Section 3.4.4.1 discusses approaches for selecting the UVT for UV facility design.

UV absorbers in typical source waters include soluble and particulate forms of humic and fulvic acids; other aromatic organics (e.g., phenols); metals (e.g., iron); and anions (e.g., nitrates and sulfites) (Yip and Konasewich 1972, DeMers and Renner 1992). UV absorbance will vary over time due to changing concentrations of these compounds and seasonal effects—rainfall, lake stratification and destratification (turnover), and changes in biological activity of microorganisms within the water source.

2.5.1.2 Particle Content

As described in Section 2.3.4, particle content can also affect UV disinfection performance. Particles in source waters are diverse in composition and size and include large molecules, microorganisms, clay particles, algae, and flocs. Sources of particles include wastewater discharges, erosion, runoff, microbial growth, and animal waste. The particle concentration will vary over time both seasonally and over the short term. Storm events, lake turnover, and spring runoff are some events that increase the concentration of particles.

2.5.1.3 Upstream Water Treatment Processes

Unit processes and chemical addition upstream of UV reactors can significantly affect UV reactor performance because they can change the particle content and UVT of the water. Additionally, when UV disinfection is used in combination with another disinfectant, synergistic disinfection potentially may occur (i.e., the combination of disinfectants may be more effective than either disinfectant acting alone).

Water treatment processes upstream of the UV reactors can be operated to maximize UVT, thereby optimizing the design and costs of the UV reactor (Section 3.2.2). For example,

coagulation, flocculation, and sedimentation remove soluble and particulate material, and filtration removes particles. Activated carbon absorption also reduces soluble organics.

Adding oxidants (such as chlorine and ozone) can increase the UVT (APHA et al. 1998) by degrading natural organic matter, reducing soluble material, and precipitating metals. An example of the effect ozone has on decreasing UV absorbance is shown in Figure 2.22. Ozone is also a strong absorber of UV light, however, and will decrease the UVT if an ozone residual is present in significant concentrations in the water passing through a UV reactor. Quenching agents that do not absorb UV light (such as sodium bisulfite) can be used to destroy the ozone residual upstream of the UV reactors. Thiosulfate is not recommended as a quenching agent because it absorbs UV light and can decrease the UVT.

Figure 2.22. Example Effect of Ozonation on UV Absorbance if Ozone is Quenched Prior to UV Disinfection

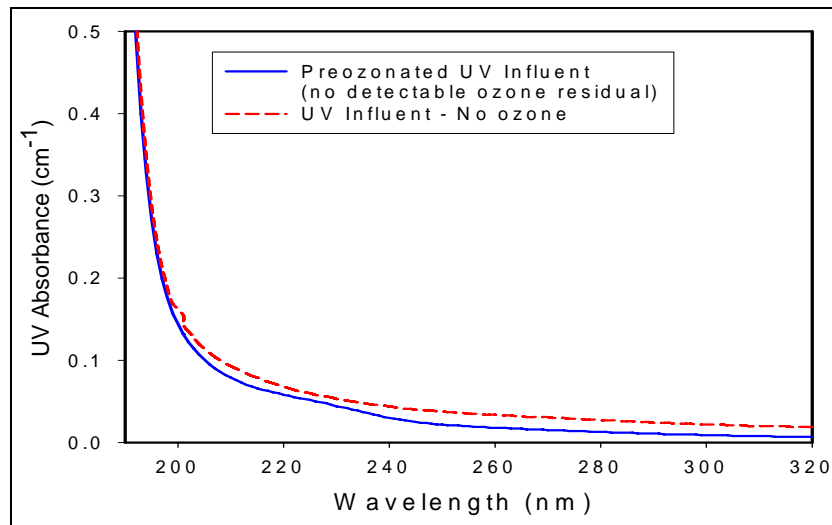

Source: Malley (2002)

In addition to ozone, other chemicals used in water treatment such as ferric iron and permanganate also absorb UV light and can decrease UVT. Table 2.5 lists the UV absorption coefficients at 254 nm of several common water treatment chemicals along with their “impact threshold concentration,” which is the concentration that will decrease the UVT at 254 nm from 91 to 90 percent (Bolton et al. 2001). Note that these data are only for 254 nm, and the effect these chemicals have on UVT may be significantly different at other wavelengths generated by MP or other polychromatic lamps. The following chemicals were also evaluated in the same study (Bolton et al. 2001) and were found to have no significant absorbance: ammonia (NH₃), ammonium ion (NH₄⁺), calcium ion (Ca²⁺), hydroxide ion (OH⁻), magnesium ion (Mg²⁺), manganese ion (Mn²⁺), phosphate species, and sulfate ion (SO₄²⁻).

UV disinfection is often used in combination with other disinfectants, and the interaction of the disinfectants can affect the overall inactivation achieved. Research shows that applying ozone prior to UV disinfection is beneficial: the ozone increases the UVT, while the UV disinfection provides *Cryptosporidium* inactivation (Malley et al. 2003, Crozes et al. 2003).

Whether the effects of multiple disinfectants are synergistic (i.e., more inactivation observed when processes are used in combination than is expected from the sum of

Table 2.5. UV Absorbance Characteristics of Common Water Treatment Chemicals

Compound ¹	Molar Absorption Coefficient (M ⁻¹ cm ⁻¹)	Impact Threshold Concentration ² (mg/L)
Ozone (O ₃) (aqueous)	3,250	0.071
Ferric iron (Fe ³⁺)	4,716	0.057
Permanganate (MnO ₄ ⁻)	657	0.91
Thiosulfate (S ₂ O ₃ ²⁻)	201	2.7
Hypochlorite (ClO ⁻)	29.5	8.4
Hydrogen peroxide (H ₂ O ₂)	18.7	8.7
Ferrous iron (Fe ²⁺)	28	9.6
Sulfite (SO ₃ ²⁻)	16.5	23
Zinc (Zn ²⁺)	1.7	187

¹ The following chemicals were also evaluated in the same study (Bolton et al. 2001) and were found to have no significant absorbance: ammonia (NH₃), ammonium ion (NH₄⁺), calcium ion (Ca²⁺), hydroxide ion (OH⁻), magnesium ion (Mg²⁺), manganese ion (Mn²⁺), phosphate species, and sulfate ion (SO₄²⁻)

² Concentration in mg/L resulting in UVT decrease from 91 % to 90 % (A₂₅₄ increase from 0.041 cm⁻¹ to 0.046 cm⁻¹)

Source: Adapted from Bolton et al. (2001)

the disinfectants acting alone) is currently under debate. Two studies reported synergistic effects when using UV disinfection and free chlorine, monochloramine, or chlorine dioxide (Ballester et al. 2003, Lotierzo et al. 2003), while others did not observe synergism (Coronell et al. 2003, Oppenheimer et al. 2003). The importance of the sequence of the disinfectants is also a subject of debate. Ballester et al. (2003) obtained improved disinfection with UV disinfection followed by monochloramine addition than with chloramination followed by UV disinfection, while the sequence of disinfectants did not affect the disinfection effectiveness in the study by Lotierzo et al. (2003).

2.5.1.4 Fouling Potential

Compounds in the water can foul the external surfaces of the lamp sleeves and other wetted components (e.g., monitoring windows of UV sensors) of UV reactors. Fouling on the lamp sleeves reduces the transmittance of UV light through the sleeve into the water, thereby reducing the output from the UV lamp into the water. Also, fouling on the monitoring windows affects measured UV intensity and dose monitoring. Sleeve fouling can be accounted for with the fouling/aging factor (described in Section 3.4.5) in the design of the UV facility.

Hardness (as CaCO₃), alkalinity, temperature, ion concentration, oxidation reduction potential (ORP), and pH all influence the rate of fouling and, subsequently, the necessary frequency of sleeve cleaning. Fouling can occur for the following reasons:

- Compounds for which the solubility decreases as temperature increases may precipitate [e.g., CaCO₃, CaSO₄, MgCO₃, MgSO₄, FePO₄, FeCO₃, Al₂(SO₄)₃]. These compounds will foul MP lamps faster than LP or LPHO lamps because MP lamps operate at higher temperatures.
- Photochemical reactions that are independent of sleeve temperature may cause sleeve fouling (Derrick 2005).
- Compounds with low solubility may precipitate [e.g., Fe(OH)₃, Al(OH)₃].
- Particles may deposit on the lamp sleeve surface due to gravity settling and turbulence-induced collisions (Lin et al. 1999a).
- Organic fouling can occur when a reactor is left off and full of water for an extended period of time (Toivanen 2000).
- Inorganic constituents can oxidize and precipitate (Wait et al. 2005).

Fouling rate kinetics has been reported as independent of time following a short induction period (Lin et al. 1999b). Depending on the water quality and UV lamp type, significant fouling may occur in hours or take up to several months.

Pilot studies lasting 5 – 12 months using UV reactors with LP, LPHO and MP lamps found that standard cleaning protocols and wiper frequencies (1 – 12 cleaning cycles per hour) were sufficient to overcome the effect of sleeve fouling with water that had total and calcium hardness levels less than 140 milligrams per liter (mg/L) and iron less than 0.1 mg/L (Mackey et al. 2001, Mackey et al. 2004).

Inorganic fouling is a complex process, however, and is not related only to hardness and iron concentrations. The solubility of inorganic constituents depends on whether they are in an oxidized or reduced state, which can be affected by both the ORP and pH of the water (Wait et al. 2005). ORP is a measurement of the water's ability to oxidize or reduce constituents in the water. Both pH and ORP are needed to predict the oxidation state of an inorganic constituent. Studies have found that fouling rates increase as ORP increases (Collins and Malley 2005, Wait et al. 2005, Derrick 2005). In some waters with high ORP, however, fouling rates can be minimized if the iron and manganese are removed through oxidation, precipitation, and filtration (Wait et al. 2005, Derrick 2005, Jeffcoat 2005). Although ORP can provide valuable information, measuring it can be challenging and may not be possible in all instances.

Ultimately, the fouling potential is difficult to predict, but standard cleaning equipment can remove fouling and may need to be included. Also, pilot-scale or demonstration-scale testing can determine the fouling tendencies and cleaning regime if the PWS is concerned about fouling.

2.5.1.5 Algal Occurrence and Growth

The presence of algae in the water being treated may reduce UVT and interfere with the UV disinfection process. Algae also may grow upstream or downstream of UV reactors, which has been observed in MP pilot studies (Mackey et al. 2004). Visible light emitted from the lamps is transmitted through water farther than germicidal wavelengths. Algal growth depends on the concentration of nutrients in the water, hydraulics (i.e., dead spaces), and the amount of visible light transmitted beyond the reactor.

2.5.2 Chlorine Reduction through UV Reactors

When UV disinfection is applied to water with a free or total chlorine residual, some reduction of the residual may occur. The reduction in free chlorine residual is proportional to the delivered dose and independent of flow rate (Brodkorb and Richards 2004). The reduction in total chlorine residual is also proportional to the delivered dose (Wilczak and Lai, 2006). The reduction in chlorine residual further depends on the chlorine species, UV light source, and water quality characteristics (Örmeci et al. 2005, Venkatesan et al. 2003). An example of the effect of UV light on the free chlorine residual is shown in Figure 2.23. In other evaluations, a loss of about 0.3 mg/L of the free chlorine residual was observed in a WTP at a dose between 80 and 120 mJ/cm² (Kubik 2005), and a loss of 0.2 mg/L of the total chlorine residual was observed in bench-scale testing at doses up to 40 mJ/cm² (Wilczak and Lai 2006).

Figure 2.23. Example Effect of UV Disinfection on Free Chlorine Residual Loss

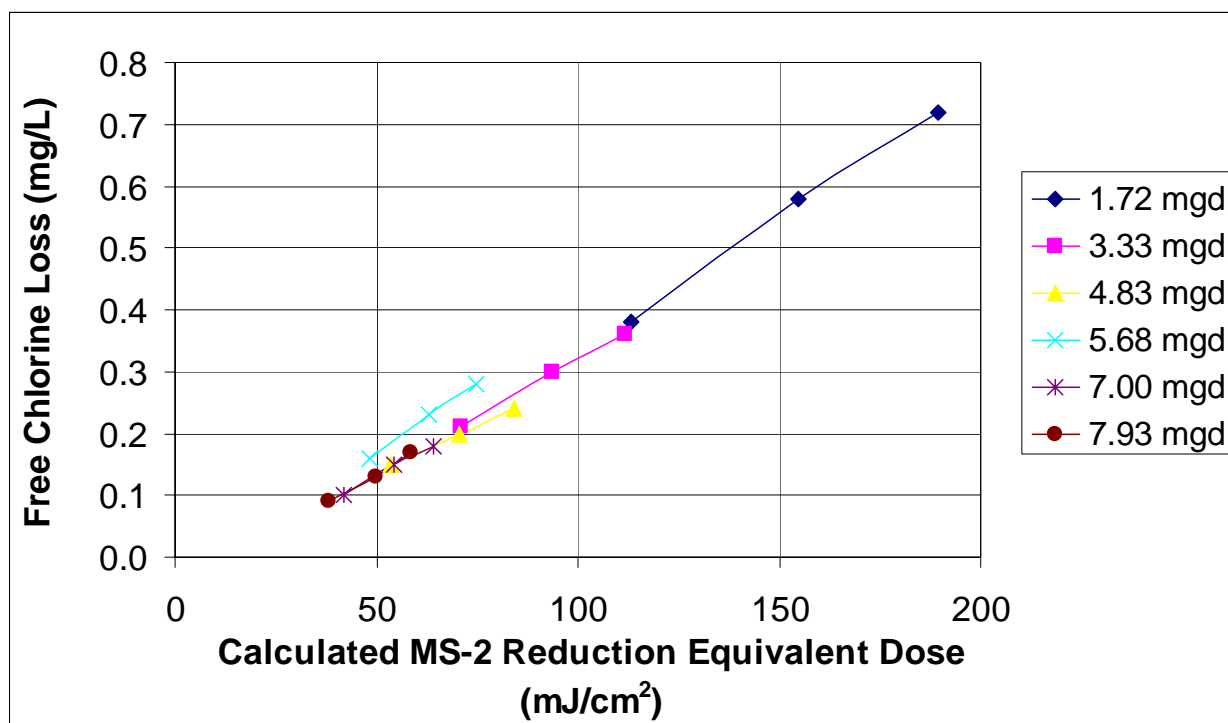

Source: Brodkorb and Richards (2004)

2.5.3 Byproducts from UV Disinfection

Studies indicate that UV disinfection at UV doses up to 200 mJ/cm² do not change the pH, turbidity, dissolved organic carbon level, UVT, color, nitrate, nitrite, bromide, iron, or manganese of the water being treated (Malley et al. 1996). Byproducts from UV disinfection, however, can arise either directly through photochemical reactions or indirectly through reactions with products of photochemical reactions. Photochemical reactions occur only when a chemical species absorbs UV light and the resulting excited state reacts to form a new species. The resulting concentration of new species depends on the concentration of the reactants and the UV dose. In drinking water, research on potential byproducts of UV disinfection has focused on the effect of UV light on the formation of halogenated DBPs after subsequent chlorination, the transformation of organic material to more degradable components, and on the potential formation of other DBPs (e.g., biodegradable compounds, nitrite, mutagenicity, and other byproducts).

2.5.3.1 Trihalomethanes, Haloacetic Acids, and Total Organic Halides

Trihalomethanes (THMs) and haloacetic acids (HAAs) are two categories of halogenated DBPs that EPA currently regulates. UV light at doses less than 400 mJ/cm² has not been found to significantly affect the formation of THMs or HAAs upon subsequent chlorination (Malley et al. 1996, Kashinkunti et al. 2003, Zheng et al. 1999, Liu et al. 2002, Venkatesan et al. 2003).

2.5.3.2 Biodegradable Compounds

Several studies have shown low-level formation of non-regulated DBPs (e.g., aldehydes) as a result of applying UV light at doses greater than 400 mJ/cm² to wastewater and raw drinking water sources (Liu et al. 2002, Venkatesan et al. 2003). At the doses typical for UV disinfection in drinking water (< 140 mJ/cm²), however, no significant change was observed (Kashinkunti et al. 2003). UV disinfection has not been found to significantly increase the assimilable organic carbon (AOC) of drinking water at UV doses ranging from 18 – 250 mJ/cm² (Kruithof and van der Leer 1990, Akhlaq et al. 1990, Malley et al. 1996).

2.5.3.3 Nitrite

The conversion of nitrate to nitrite is possible with MP lamps that emit at wavelengths below 225 nm [von Sonntag and Schuchmann (1992), Mack and Bolton (1999), IJpelaar et al. (2003), Peldszus et al. (2004)]. Sharpless and Linden (2001) reported a conversion rate from nitrate to nitrite of approximately 1 percent. Therefore, the nitrate-to-nitrite conversion is unlikely to be a significant issue for PWSs under current regulations. The nitrate levels would have to be higher than the nitrate MCL of 10 mg/L for the nitrite MCL of 1 mg/L to be exceeded.

This page intentionally left blank.

3. Planning Analyses for UV Facilities

This chapter provides information on the elements that should be addressed during the UV disinfection planning or preliminary design phase.

Chapter 3 covers:

- 3.1 UV Disinfection Goals
- 3.2 Evaluating Integration of UV Disinfection into the Treatment Process
- 3.3 Identifying Potential Locations for UV Facilities
- 3.4 Defining Key Design Parameters
- 3.5 Evaluating UV Reactors, Dose Monitoring Strategy, and Operational Approach
- 3.6 Assessing UV Equipment Validation Issues
- 3.7 Assessing Head Loss Constraints
- 3.8 Estimating UV Facility Footprint
- 3.9 Preparing Preliminary Costs and Selecting the UV Facility Option
- 3.10 Reporting to the State

The planning for any UV facility is site-specific. Given the wide range of possible treatment scenarios, a guidance document such as this one cannot address or anticipate all possible treatment conditions. The information presented here should be used within the context of sound engineering judgment and applied appropriately on a case-by-case basis. Appendix F presents case studies that illustrate how various public water systems (PWSs) have implemented UV disinfection in their water systems. Additionally, this manual was written with the understanding that UV technology will continue to expand and evolve, so the information presented is current only as of the publication date. Furthermore, unless otherwise stated, throughout Chapter 3 the water to be disinfected is assumed to be from *surface water systems* [(i.e., filtered water, an unfiltered source water, or groundwater under the direct influence (GWUDI)], meeting applicable regulatory requirements that pre-date the Long Term 2 Enhanced Surface Water Treatment Rule (LT2ESWTR).

The process of planning and designing a UV facility is presented in Figure 3.1. Once the design parameters are defined and the implementation issues are identified, they are incorporated into the detailed design phase, which is discussed in Chapter 4.

3.1 UV Disinfection Goals

The first step in planning a UV disinfection facility is to define the goals for the facility as part of a comprehensive disinfection strategy for the entire treatment process. Additionally, the target pathogen(s), target log-inactivation, and corresponding required UV dose should be identified.

Figure 3.1. Example Flowchart for Planning UV Facilities

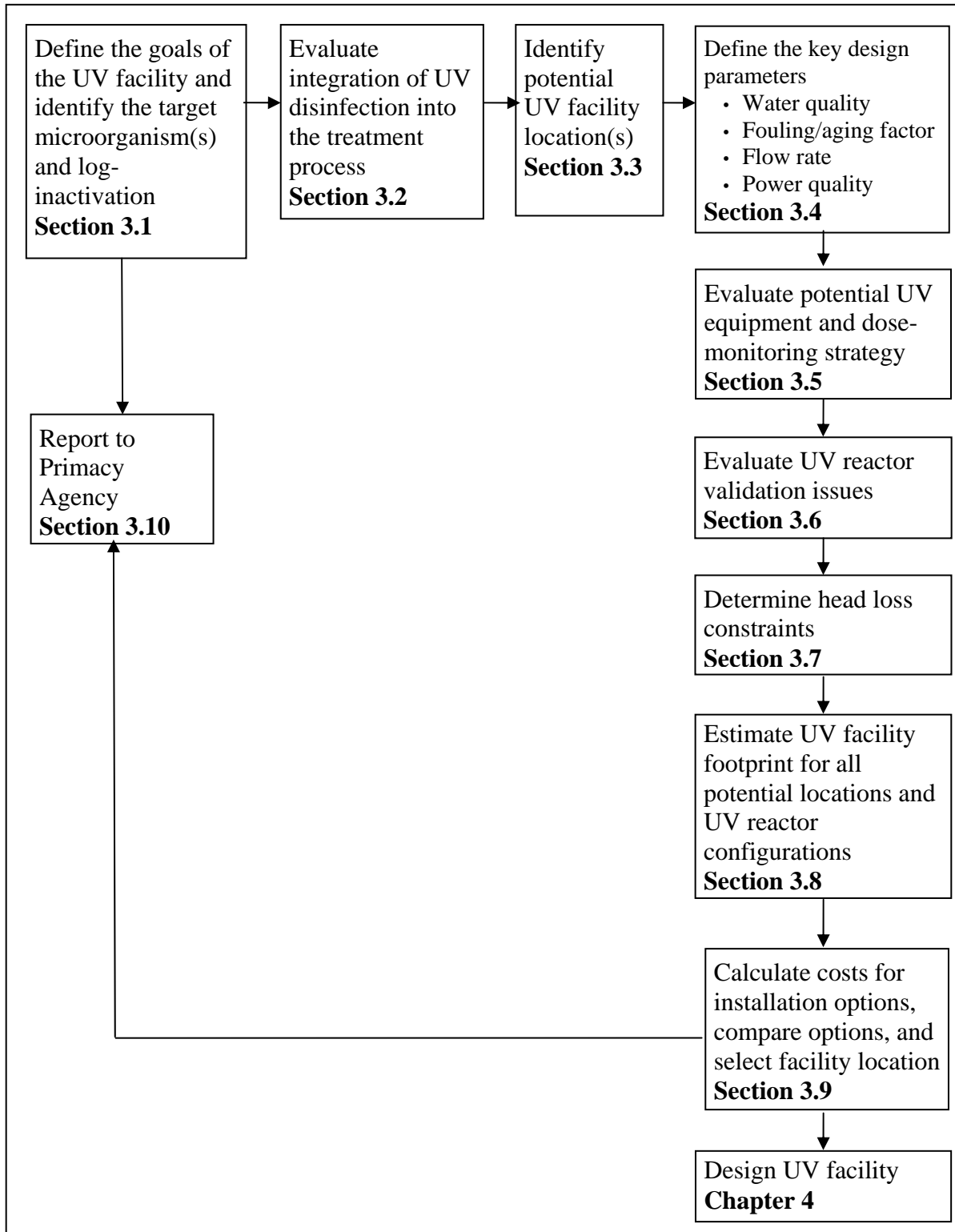

- **Comprehensive Disinfection Strategy:** A comprehensive disinfection strategy provides multiple barriers to reduce microbial risk, while minimizing disinfectant byproduct (DBP) formation. UV disinfection is a tool that can contribute to a comprehensive disinfection strategy by providing a cost-effective method of inactivating pathogens that are more resistant to traditional disinfection methods. Also, UV disinfection can replace chemicals for primary disinfection of chlorine-resistant pathogens (e.g., *Cryptosporidium* and *Giardia*), thereby reducing DBP formation. Note that PWSs that plan to significantly change their disinfection process, including adding UV disinfection, must prepare a disinfection benchmark¹ (40 CFR 141.708) and consult with the state before making any changes. Further, PWSs must continue to provide 2-log *Cryptosporidium* removal by meeting filtered water turbidity requirements (40 CFR 141.173 for PWSs serving at least 10,000 people and 40 CFR 141.551 for PWSs serving fewer than 10,000 people) unless they meet the filtration avoidance criteria.
- **Target Pathogen and Log Inactivation:** The required UV doses for *Cryptosporidium* and *Giardia* inactivation are lower than those needed to inactivate viruses. (See Table 1.4.) Accordingly, the capital and operational costs for inactivating *Cryptosporidium* and *Giardia* should be lower than for viruses. One study estimated capital costs for *Cryptosporidium* and *Giardia* inactivation by UV disinfection on a log removal basis to be about half the cost associated with the UV inactivation of viruses (Cotton et al. 2002). Additionally, most viruses can be easily inactivated with chlorine so UV disinfection for virus inactivation may not be necessary. The target log inactivation also should be considered because higher target inactivation requires higher UV doses that will affect the design and cost of the UV facility. Therefore, the target microorganism(s) and their log-inactivation level should be determined early in the planning process.

3.2 Evaluating Integration of UV Disinfection into the Treatment Process

When installed, UV disinfection will typically be one of several treatment processes to help meet water quality goals. Accordingly, UV disinfection should be evaluated in the context of the complete treatment process, and the impacts on UV disinfection on other treatment processes should be considered. These issues are summarized in this section.

3.2.1 UV Disinfection Effects on Treatment

Typically, UV disinfection cannot entirely replace chemical disinfectants used in the treatment process. Some of the reasons are listed below.

- Surface water systems must maintain a disinfectant residual in the distribution system (40 CFR 141.72).

¹ More information on completing a disinfection benchmark can be found in *Disinfection Profiling and Benchmarking Guidance Manual* (EPA 1999).

- UV disinfection is not as efficient in inactivating viruses as more traditional, chlorine-based disinfection processes.
- Chemical disinfectants may also be needed to oxidize other constituents present in the water (e.g., iron, manganese, or taste- and odor-causing compounds).
- Some water systems apply chlorine to reduce algal growth in sedimentation basins.

Consequently, some level of chlorine-based disinfectant (chlorine or chloramines) usually will be needed even when UV disinfection is implemented. Therefore, any reduction in chlorine-based disinfectants should be evaluated in the context of other water quality and treatment goals.

When UV disinfection is applied to water having a chlorine residual, some chlorine residual reduction may occur, depending on the UV dose, chlorine species, UV light source, and water quality characteristics (Brodkorb and Richards 2004, Örmeci et al. 2005, Venkatesan et al. 2003). Brodkorb and Richards (2004) reported chlorine residual reduction between 0.1 and 0.7 milligrams per liter (mg/L) at a wide range of UV doses (described in Section 2.5.2). Significant chlorine reduction could occur inadvertently if the UV equipment cannot provide enough power modulation capacity and actually operates at much higher doses than designed. Two options are available to avoid chlorine reduction by UV disinfection:

1. Consider moving the chlorine addition point to after the UV facility if possible, especially when targeting viruses (because their required UV doses are higher).
2. Procure the UV equipment that has adequate power modulation to prevent overdosing and subsequent chlorine reduction.

In addition, UV disinfection of water having a chlorine residual, which results in a higher oxidation-reduction potential (ORP), could result in sleeve fouling (Section 2.5.1.4) if iron or manganese are present even at low levels and a proper cleaning system is not in place (Malley et al. 2001). Several studies have shown that fouling occurs at iron levels below the secondary maximum contaminant level (SMCL) when the water has a high oxidation-reduction potential (ORP) (Collins and Malley 2005, Derrick 2005, Wait et al. 2005). Again, moving the point of chlorination to after the UV facility can possibly reduce sleeve fouling (Section 3.4.4.2). Alternatively, oxidation and removal of iron and manganese (e.g., by adding potassium permanganate upstream of the sedimentation basin) reduces the fouling potential.

3.2.2 Upstream Treatment Process Effect on UV Disinfection

Water treatment processes upstream of the UV reactors can be operated to maximize the ultraviolet transmittance (UVT), thereby optimizing the design and costs of the UV equipment (Section 3.4.4.1). For example, coagulation, flocculation, and sedimentation remove soluble and particulate material, and optimizing coagulation for organics removal will increase the UVT, which could reduce the UV facility costs. Also, upstream chemicals may affect UV disinfection performance as described in Sections 2.5.1.3 and 3.4.4.1.

3.3 Identifying Potential Locations for UV Facilities

The UV dose tables (see Table 1.4) in the LT2ESWTR apply to post-filter applications of UV disinfection in filtration plants and to unfiltered systems that meet filtration avoidance criteria. In general, installing UV disinfection prior to filtration in conventional water treatment plants (WTPs) is not recommended because of the potential particle interference in raw and settled waters. As such, only post-filter locations are discussed for filtered systems in this section.

After the potential locations are identified, design criteria, hydraulics, validation issues, and footprint estimations should be evaluated at each location to identify which location is most feasible for the UV facility. These evaluations are described in subsequent sections.

3.3.1 Installation Locations for Filtered Systems

In conventional WTPs, the three most common installation locations are downstream of the combined filter effluent (upstream of the clearwell), on the individual filter effluent piping (upstream of the clearwell), and downstream of the clearwell.

3.3.1.1 Combined Filter Effluent Installation (Upstream of the Clearwell)

A combined filter effluent installation is defined as the application of UV disinfection to the filtered effluent after the effluent from individual filters has been combined (as opposed to applying UV disinfection to the individual filter effluents) and ahead of the clearwell, as shown in Figure 3.2. For retrofits on existing WTPs, these installations are usually housed in a separate building.

Figure 3.2. Schematic for UV Facility Upstream of the Clearwell

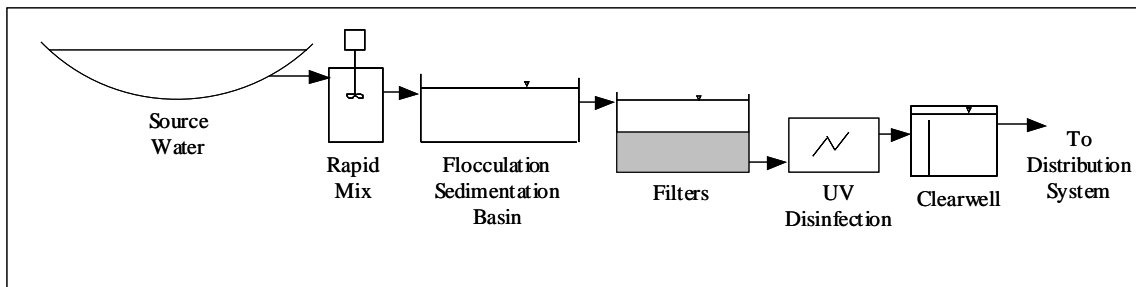

This type of design and installation has several advantages:

- The UV reactor operation is largely independent of the operation of individual filters, which provides flexibility for design and operation.

- If the entire UV facility failed, a WTP can continue to disinfect by adding a chemical disinfectant to the clearwell. (Note that backup chemical disinfection will likely not provide *Cryptosporidium* inactivation.)
- Surge and pressure fluctuations typically are not a concern for this installation location unless membrane filtration, pressure filters, or intermediate booster pumps are used.
- Because this type of UV facility is typically constructed in a new building, there may be greater flexibility to maintain the recommended inlet and outlet hydraulic conditions for the UV reactors (Section 3.6.2).

The primary disadvantages of this type of installation are:

- An additional building and space may be necessary.
- The piping and fittings may result in greater head loss than alternative configurations, which may result in the need for intermediate booster pumps.

3.3.1.2 Individual Filter Effluent Piping Installation

Individual filter effluent piping installations are defined as UV reactors installed on each filter effluent pipe (Figure 3.3). This type of installation is typically located within an existing filter gallery.

Figure 3.3. Schematic of Individual Filter Effluent Piping Installation in Filter Gallery

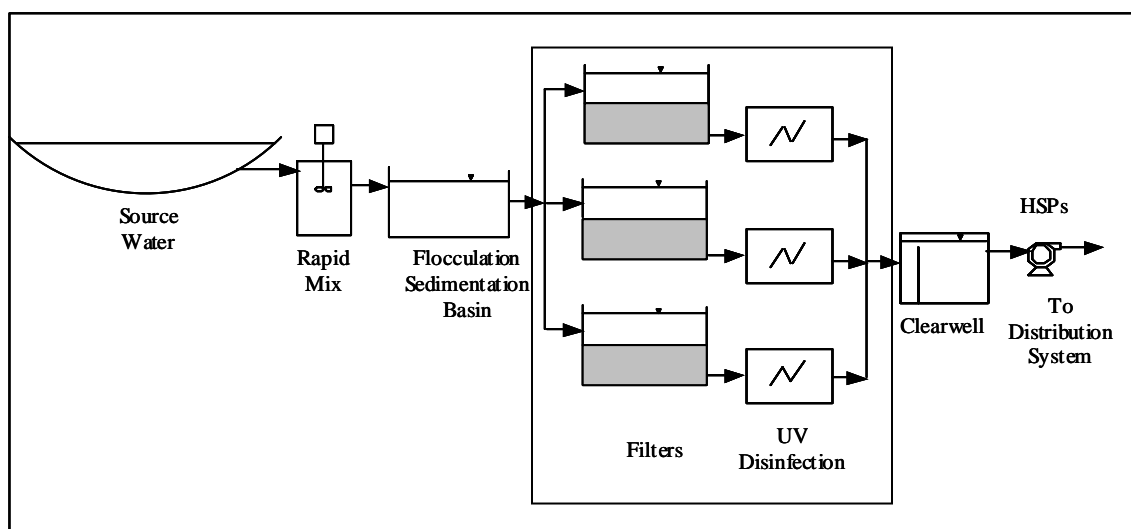

The primary advantages of this type of installation are:

- A new building is not necessary, which will decrease construction costs.
- The hydraulic effect of the UV facility is less because the only additional head loss is from the UV reactors (most necessary valves and appurtenances are already present in the filter gallery).
- If the UV reactors fail, a WTP can continue to disinfect by adding a chemical disinfectant to the clearwell. (Note that backup chemical disinfection likely will not provide *Cryptosporidium* inactivation.)

This installation location, however, has several disadvantages:

- Many filter galleries have insufficient space within existing effluent piping to accommodate the UV reactors.
- Sufficient space is needed in the filter gallery or nearby for the control panels and electrical equipment.
- Access to existing equipment may be impeded by the UV reactor, and access to UV reactor components for maintenance may be more restricted than for a combined filter effluent installation.
- Environmental conditions (e.g., moisture) in the filter gallery may not be appropriate for the installation of the UV reactors, associated control panels, and electrical equipment. This situation would necessitate improvements to the heating, ventilating, and air conditioning (HVAC) system.
- The existing piping may constrain how the UV reactor is validated because of the unique inlet and outlet conditions that may be present (Section 3.6.2).
- Surge and pressure fluctuations would need to be investigated if UV reactors are installed directly downstream of pressure filters or membrane filtration because water hammer can damage lamp sleeves.

Additionally, the individual filter effluent installation may also complicate treatment plant operations and limit operational flexibility, as described below:

- In general, this option increases the number of UV reactors required compared to a combined filter installation because the number of filters dictates the number of UV reactors. More reactors may increase operation and maintenance costs.
- The head loss of the UV reactors may affect the operation of the filters and the clearwell.
- The operations of the UV reactor and the filter are closely related. If one reactor or one filter is off-line, the other process may not be operable.

- When a UV reactor goes off-line, the corresponding filter also should be taken off-line to minimize off-specification operation.
- The filter backwash cycle can complicate UV reactor operation.
 - Lamps that remain energized during a backwash may require cooling water because some lamps should not be energized in stagnant water. *The designer should consult the UV manufacturer to determine whether the UV reactor requires cooling water during start-up.*
 - If a UV reactor is off-line during a backwash, the UV reactor may be operating outside of its validated limits (i.e., off-specification—discussed in Section 3.4.1) if water is being treated during lamp warm-up. If the piping configuration permits, energizing the UV reactors during the filter-to-waste period and having the filter-to-waste water pass through the reactors during the warm-up period would cool the lamps and reduce the volume of the off-specification water.

3.3.1.3 UV Disinfection Downstream of the Clearwell

A WTP may be able to locate the UV facility downstream of the clearwell, either upstream or downstream of the high-service pumps (HSPs), as shown in Figure 3.4. In many WTPs, the HSPs pump water directly from the clearwell, which limits space and the availability of suitable piping for installing the UV facility upstream of the HSPs. Installation downstream of the HSPs may provide greater space and flexibility in locating the UV facility.

Figure 3.4. UV Disinfection Downstream of High Service Pumps

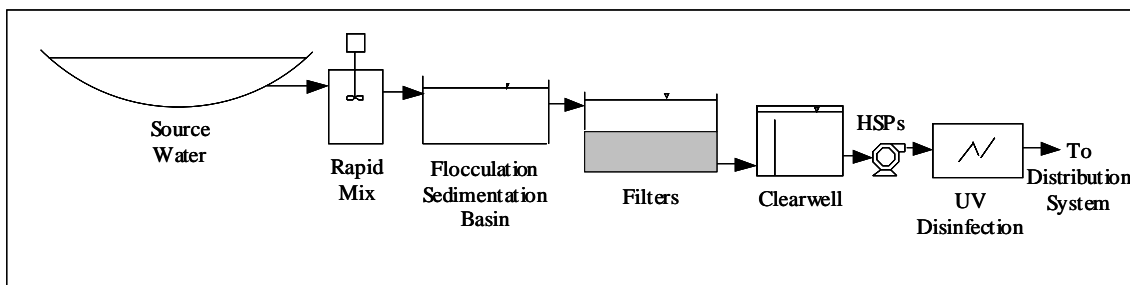

The primary advantage of this type of installation is that UV reactor installation is possible even if the space or available head is insufficient to allow installation of the UV equipment between the filters and the clearwell. However, these options have significant disadvantages:

- UV facilities located downstream of the clearwell may experience greater fluctuations in flow rate because the flow rate is more closely related to demand changes.

Accommodating flow rate fluctuations may necessitate increasing the UV reactor size or number of UV reactors.

- Post-clearwell installation locations are more prone to water hammer because of their proximity to the HSPs and subsequent high pressures, and water hammer could damage lamp sleeves and the lamps. Hydropneumatic tanks or pressure-relief valves may be needed to avoid water hammer.
- In the event of a lamp break, post-clearwell installations may have less ability to contain mercury and quartz resulting from the break in a low-velocity collection area (depending on the distribution system configuration).
- In post-HSP installations, the water is at distribution system pressure. The UV reactor housing may need reinforcement to accommodate high pressure, which would increase the cost of the UV reactors.
- A UV facility located after the HSPs will reduce the discharge pressure to the distribution system, and a UV facility located between the clearwell and HSPs will reduce the suction head available for the pumps. As a result, discharge pressures and storage utilization could be affected at these two locations unless the HSPs are upgraded to account for the UV facility hydraulic needs.
- When UV disinfection is applied to water with a free or total chlorine residual, some reduction of the residual may occur, which may necessitate increasing the chlorine dose in the clearwell or moving the chlorination point to downstream of the UV facility.

3.3.2 Unfiltered System Installation Locations

In an unfiltered system, UV facilities can be located either before or after a storage reservoir. If the storage is covered, UV disinfection facilities can be installed in either location. If the storage reservoir is uncovered, however, the PWS is subject to the uncovered reservoir requirements of the LT2ESWTR and as such should install UV disinfection on the discharge side of the reservoir to provide the necessary treatment. Most unfiltered systems flow to the distribution system by gravity; however, water hammer may still be a concern if the facility is located near HSPs (if applicable). This installation location is similar to installations downstream of the clearwell, and as such, the items described in Section 3.3.1.3 also apply to this location.

More debris may be present in the influent to UV reactors in unfiltered applications than in post-filter applications. Debris entering the UV reactor with sufficient momentum can cause the lamp and sleeve to break. The mass and size of an object that might cause damage are installation-specific and depend on UV reactor configuration (e.g., horizontal versus vertical reactor orientation) and water velocity through the reactor. Methods of addressing debris are described in Section 4.5.1, and additional information on lamp breakage is presented in Appendix E.

3.3.3 Groundwater System Installation Locations

For groundwater applications of UV disinfection, UV facilities may be installed either at each well in a production system or at a centralized facility. If installed at or near well pumps, the hydraulic and water hammer considerations described in Section 3.3.1.3 will also apply. An engineering cost analysis can be conducted to compare centralized versus wellhead UV disinfection treatment, as well as any other treatment needs, such as removing iron, manganese, or sulfides.

3.3.4 Uncovered Reservoir Installation Locations

The LT2ESWTR requires PWSs with uncovered finished water storage facilities to either cover the storage facility or treat the discharge of the storage facility that is distributed to consumers to achieve inactivation and/or removal of 4-log virus, 3-log *Giardia*, and 2-log *Cryptosporidium* [40 CFR 141.714(c)]. When applying UV disinfection to uncovered reservoirs, the UV facility should be on the outlet of the uncovered reservoir. In some cases, the inlet and outlet to the uncovered reservoir is the same pipe, and the UV facility should be designed so it operates when the water flows from the uncovered reservoir to the customer. Water from most uncovered reservoirs flows by gravity to the distribution system; however, water hammer may still be a concern if the UV reactors are located close to HSPs. As such, the items described in Section 3.3.1.3 also apply to this location.

3.4 Defining Key Design Parameters

Off-specification requirements (see Section 3.4.1 below), target pathogen inactivation, flow, water quality, the fouling/aging factor, and power quality affect the sizing of the UV reactors and associated support facilities. Specifically, UV manufacturers use the design flow, design UVT, the range of UVT expected, and the fouling/aging factor to determine the appropriate number of UV reactors to achieve the required UV dose.

Pilot- and demonstration-scale testing for UV disinfection systems can be helpful in determining key design parameters but typically are unnecessary. For example, pilot- or demonstration-scale testing may be warranted when bench-scale analysis cannot determine the design criteria (e.g., prediction of fouling/aging factor in waters with high inorganic constituents). This section also describes some pilot- or demonstration-scale testing that can be used to determine key design criteria if deemed necessary by the PWS or design engineer.

3.4.1 Off-specification Requirements

The LT2ESWTR requires validation of UV reactors to demonstrate that they achieve the required UV dose [40 CFR 141.720(d)]. Validation testing establishes the conditions under which the UV reactors must be operated to ensure the required UV dose delivery [40 CFR 141.720(d)].

Receiving log inactivation credit to meet the treatment requirement of the LT2ESWTR requires that at least 95 percent of the water delivered to the public during each month is treated by UV reactors operating within validated limits [40 CFR 141.720(d)(3)]. In other words, the UV reactors cannot be operated outside of their validated limits for more than 5 percent of the volume of water that is treated each month. Operating outside of the validated limits is defined in this manual as off-specification operation.

Determining the appropriate design criteria related to flow, water quality (UVT and fouling), the fouling/aging factor, and power quality is important to comply with LT2ESWTR off-specification requirements. These design criteria also define the conditions under which the UV reactors must be validated and then operated. If the design parameters are not sufficiently conservative, the UV reactors may often operate off-specification and be out of compliance.

The UV reactors are off-specification when any of the following conditions occur:

- The flow rate is higher than the validated range.
- The UVT is lower than the validated range [if the Calculated Dose Approach is used (see Section 3.5.2)].
- The UV intensity is below the validated setpoint [if the UV Intensity Setpoint Approach is used (see Section 3.5.2)].
- The validated dose² is less than the required UV dose at a given flow rate [if the Calculated Dose Approach is used (see Section 3.5.2)].
- One or more lamps are not energized unless the UV reactor was validated with these lamps off.
- All UV lamps are off because of a power interruption or power quality problem, and water is flowing through the reactors.
- One or more UV sensors are not within calibration criteria, and the remedial actions are not taken. (See Section 6.4.1.1).
- A UVT analyzer is needed for the dose-monitoring strategy; the UVT analyzer is out of calibration; and a corrective action was not taken. (See Section 6.4.1.2.)
- The UV equipment includes installed or replaced components (or both) that are *not* equal to or better than the components used during validation testing unless the UV equipment was re-validated. (See Section 5.13.)

² For the purposes of this manual, the “Validated Dose” is the UV dose in units of mJ/cm² delivered by the UV reactor as determined through validation testing. The validated dose is compared to the required dose to determine log inactivation credit. For the Calculated Dose Approach, the validated dose equals the calculated dose from the dose-monitoring equation, divided by the Validation Factor. The Validation Factor accounts for key uncertainties and biases resulting from validation testing.

3.4.2 Target Pathogen Inactivation and Required UV Dose

As described in Section 3.1, the UV facility design criteria should include the target pathogen, log inactivation level, and corresponding required UV dose. The required UV dose (D_{Req}) for the various pathogens and inactivation are shown in Table 1.4; however, the PWS may consider increasing the required dose beyond those listed in Table 1.4 by 10 to 20 percent to provide flexibility and conservatism. Similar approaches are commonly used by many PWSs with chlorine disinfection where they provide higher chlorine residuals and contact times (CT) than required.

3.4.3 Design Flow Rate

The UV facility design criteria should identify the average, maximum, and minimum flow rates that the UV reactors will experience. Methods for determining the design flow rate for the installation locations described previously are listed in Table 3.1.

Table 3.1. Potential Method to Determine Design Flow

Installation Location	Design Flow Basis
Combined Filter Effluent	Combined rated capacity of all duty filters ¹
Individual Filter Effluent	Rated design flow for individual filter
Downstream of the Clearwell	Rated capacity of the HSP station
Unfiltered Application	Rated capacity of the treatment facility
Groundwater Application	Rated capacity of the well pump or well field
Uncovered Reservoir Application	Maximum reservoir outflow

¹ Does not include redundant filters

3.4.4 Water Quality

As highlighted in Chapter 2, the following water quality parameters and issues affect UV dose delivery and should be considered in UV facility planning:

- UVT at 254 nanometers (nm)
- UV transmittance scan from 200 – 300 nm (i.e., germicidal range)
- Sleeve and UV sensor window fouling, including
 - Calcium
 - Alkalinity
 - Hardness
 - Iron
 - Manganese
 - pH

- Lamp temperature
 - ORP
- Particle content and algae (unfiltered and uncovered reservoir applications)

Water quality data should be collected from locations that are representative of the potential UV facility location(s). The duration of sampling, numbers of samples collected, and data analyses used to evaluate water quality for UV disinfection are similar to the approaches used for other water treatment technologies. The data collection should capture typical water quality and any water quality variation due to storm events, reservoir turnover, seasonal changes, source water blends, and variations in upstream treatment. The data collection frequency should be based on flow rate variability, the consistency of the source and treated water qualities, and the potential for obtaining cost and energy savings by refining the design criteria. The extent of water quality data to be collected and the data analysis should be left to the discretion of the PWS and the design engineer based on experience and professional judgment.

Water quality information should be communicated to the UV manufacturers, so they can determine the applicable UV reactors for the target pathogen inactivation. This section provides more details on the data collection and analysis recommendations.

3.4.4.1 UVT and UVT Scans

The most important water quality characteristic affecting UV facility design is UVT^{3,4} because the UVT of the water directly influences UV dose delivery, as discussed in Chapter 2. Overly conservative design UVT values (i.e., low UVT) can result in over-design and increased capital costs. Conversely, inappropriately high design UVT values can result in frequent UV reactor off-specification operation, which could violate LT2ESWTR requirements.

Quantifying both a design UVT and the full range of UVT expected during operation is essential. Understanding the full range of UVT is critical because the UV reactor should be validated for the range of UVT and flow combinations expected at the WTP to avoid off-specification operation. Specifying a matrix of flow and UVT conditions for the UV reactors to meet the required UV dose may be appropriate. Also, the UV manufacturers may use the UVT range at the WTP to help determine the turndown (i.e., power modulation) needs of the UV reactors.

This section discusses the issues with using existing UVT data and describes the data collection, UVT measurement, and data analysis that can be used to determine design UVT and UVT range. Table 3.2 summarizes the recommendations for collecting and analyzing UVT data.

³ UVT in this section implies UVT measurement specifically at 254 nm and 1 cm pathlength unless otherwise noted.

⁴ $A_{254} = -\log\left(\frac{UVT(\%)}{100}\right)$

Table 3.2. Summary of UVT Data Collection and Analysis¹

Issue	Recommendation
Water Quality Events to Capture in Data Collection	<ul style="list-style-type: none"> • Typical/average water quality conditions • Rainfall effects on source water • Reservoir turnover • Seasonal variations • Possible water quality blends if multiple source waters are used • Variation in upstream water treatment
Water Quality Sampling Locations	Locations that are representative of potential UV facility location(s)
Sample Type for Various Installation Options ²	<ul style="list-style-type: none"> • Composite samples from operating filters or grab samples from the combined filtered water header should be collected for combined filter effluent installations • Grab samples from representative filter(s) for individual filter piping effluent installations • Grab samples from any locations downstream of clearwell under consideration
Collection Frequency and Period	<ul style="list-style-type: none"> • Weekly for 1 – 2 months if water quality is stable • Weekly³ for 6 – 12 months (or more) if water quality changes seasonally
Existing Data for Potential Use	A ₂₅₄ is often collected in filtered waters to determine the specific UV absorbance (SUVA), and these measurements could be used in the data analysis. However, ultraviolet light absorbance at 254 nm (A ₂₅₄) is typically filtered for the SUVA calculation, which would bias the A ₂₅₄ low (high UVT). Therefore, such data should only be used with this understanding.
Recommended Data Analysis	<ul style="list-style-type: none"> • Cumulative frequency analysis • UVT occurrence with flows
Recommended Data to Provide to UV Manufacturer	<ul style="list-style-type: none"> • Matrix of flows with corresponding UVTs • Target pathogen(s) and log inactivation • Design UVT⁴ (corresponding to design flow) • Range of operating UVTs

¹ Existing A₂₅₄ or UVT data may be available, which would reduce the sampling and analysis needed.

² The potential installation locations are described in detail in Section 3.3.1.

³ More frequent samples may be needed to capture a water quality event (e.g., storm events).

⁴ The design UVT is the UVT that will typically occur at the location of the facility.

Availability of Existing UVT Measurements

UVT data collection may not be necessary if sufficient filtered water UVT data are available to perform the recommended data analysis described subsequently. Additionally, filtered water A₂₅₄ is often collected to determine the SUVA, and these measurements could be used in the data analysis. However, the water sample is typically passed through a 0.45-micrometer (µm) filter for the A₂₅₄ measurement needed for the SUVA calculation, which may bias the A₂₅₄ low (high UVT). If the only available A₂₅₄ measurements are on water that has been passed through a 0.45- µm) filter, they can still provide input to the planning process, but additional UVT data collection may be necessary to understand the magnitude of the bias.

Data Collection

UVT measurements should be collected from locations that are representative of the potential facility location(s). UVT data can be collected using grab or composite samples, and the type of sample collected depends on the potential UV facility locations under consideration. For example, composite samples from operating filters or a grab sample from a combined filter effluent header should be collected for combined filter effluent UV facilities. For individual filter effluent pipe installations, grab samples from representative filters at the beginning and the end of filter runs are recommended. Grab samples from any location(s) downstream of the clearwell under consideration should be collected.

As with most engineering designs, the larger the data set, the more refined the design UVT can be. If UVT data are not available, weekly UVT measurement is recommended, but the duration of the sampling period depends on the source water quality. For example, a PWS with very stable UVT measurements may need only one or two months of data. A PWS that experiences seasonal changes, however, would benefit from more frequent data collection during seasonal events and over a longer period (6 to 12 months or more). If seasonal UVT decreases occur regularly, increased sampling frequency (e.g., daily) during these periods will better capture the magnitude and duration of the decreases. The possible effect of upstream processes on UVT should be assessed by collecting UVT data during the various operating conditions (e.g., a range of alum doses). If different sources or combinations of sources are used during the year, the UVT of the potential source water blends should be characterized to properly identify the representative water quality conditions.

UVT Measurement

UVT can be measured with a bench-top spectrophotometer or can be continuously measured by an on-line UVT analyzer. During planning, UVT is typically measured using a spectrophotometer and is typically reported as a percent. The wavelength of the spectrophotometer should be set to 254 nm, and the pathlength of the quartz cuvette used to measure UVT is usually 1 centimeter (cm). If the UVT is high, however, longer pathlengths can be used to improve measurement resolution. When longer pathlengths are used, the A_{254} measured on the spectrophotometer should be normalized by the specific pathlength to calculate the A_{254} on a per cm basis, and then the UVT should be calculated based on the A_{254} with the converted 1-cm pathlength. Because particles can affect the absorbance of UV light, samples for UVT should *not* be passed through a 0.45- μm filter before analysis. The sample pH also should not be adjusted.

Data Analysis

A cumulative frequency diagram of the UVT data can help the PWS determine its design UVT value and will also illustrate the UVT range. Cumulative frequency diagrams can be prepared by ranking UVT results from lowest to highest and then calculating the percentile for each value. Figure 3.5 presents an example cumulative frequency diagram for three filtered waters; the cumulative frequency percentile (x-axis) shows the percentage of the dataset that is less than a given value of UVT over the data collection period. For example, if the 90th percentile UVT is 91 percent, then 90 percent of the measurements are greater than 91 percent, and 10 percent of the UVT measurements are less than 91 percent.

In Figure 3.5, the UVT data for Filtered Waters 1, 2, and 3 display different characteristics. Filtered Water 1 has a relatively stable UVT, while Filtered Waters 2 and 3 have gradually increasing cumulative frequency slopes that indicate greater variability. Selection of an appropriate UVT design value for these waters should consider the variability in UVT and flow values and the maximum allowable volume of off-specification finished water at different UVT design levels. The water supply's preferred level of conservatism should also be taken into account in this comparison.

Figure 3.5. Example Cumulative Frequency Diagram for Three Filtered Waters

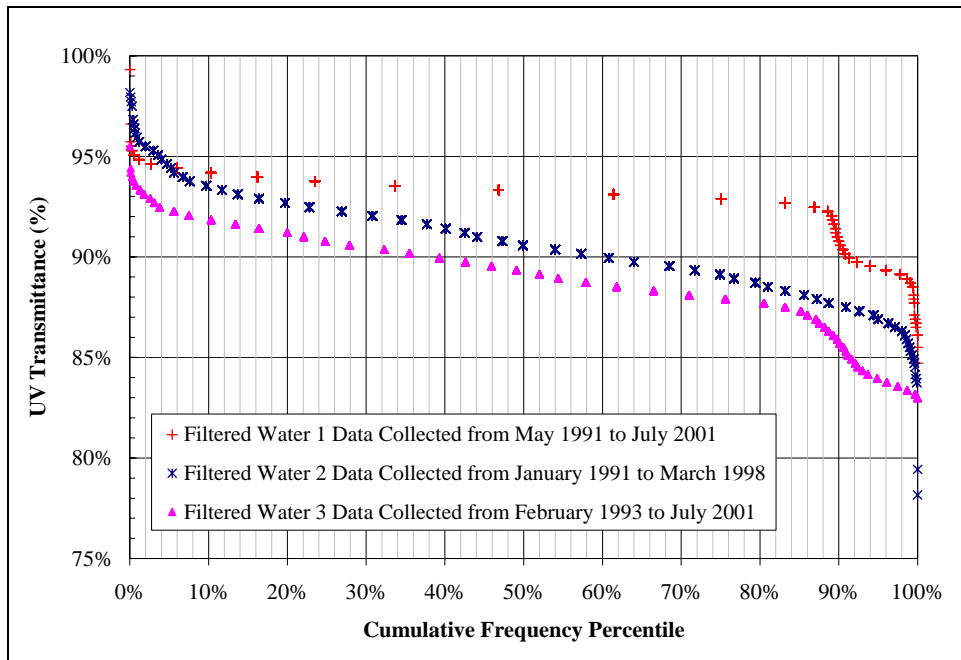

Additionally, the minimum operating UVT may not correspond to the period with the highest flow rates. The relationship between seasonal flow rates and UVT data should be considered when selecting a design UVT value and the matrix of UVT and flow conditions to be defined for the UV manufacturer. Figure 3.6 presents flow rate and UVT variations and seasonal patterns for Filtered Water 3. For this example WTP, the low UVT typically occurs in September and October and not during the high flow rate period in the summer. In this example, the following conditions for UVT and flow could be communicated to the UV manufacturers, so they can determine the applicable UV reactors for the required UV dose:

A 90th-percentile design UVT value of 86 percent at the design 220-million gallons per day (mgd) capacity

Minimum UVT of 83 percent coupled with a flow of 140 mgd

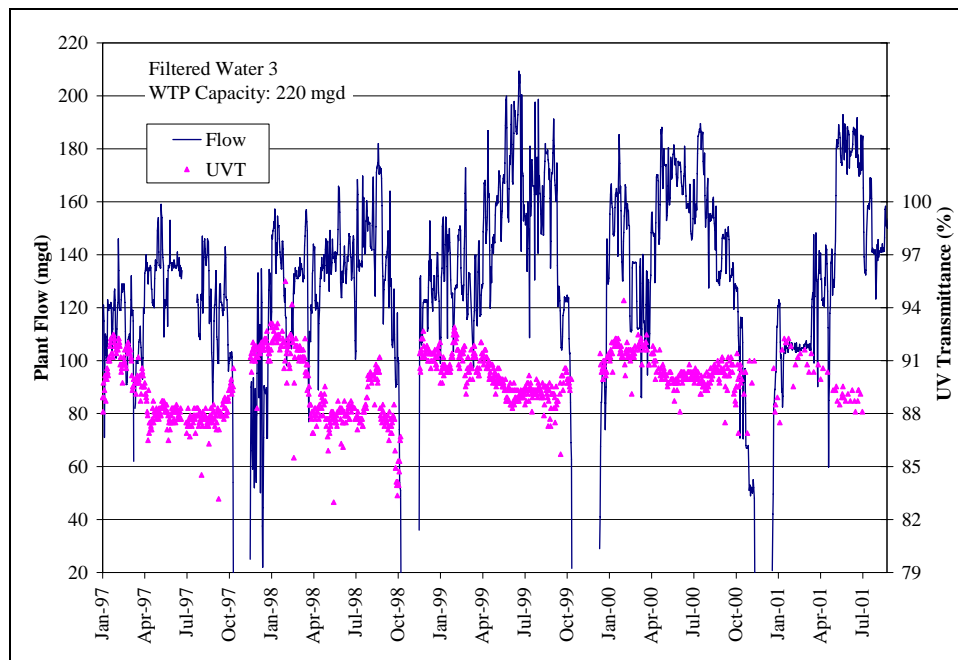
Figure 3.6. Example Flow Rate and UVT (at 254 nm) Data

Upstream Treatment Chemicals Effect on UVT

As described in Section 2.5.1.3 and Bolton et al. (2001), the following chemicals alone will not significantly affect UVT under typical filtered water conditions: alum, aluminum, ammonia, ammonium, zinc, phosphate, calcium, hydroxide, ferrous iron (Fe^{+2}), hypochlorite (ClO^-), ferric iron (Fe^{+3}), and permanganate. However, ozone residual affects UVT, as described below. If other chemicals of concern are present, the effect of water treatment chemicals on UV absorbance can be assessed by preparing solutions of various concentrations and measuring their UV absorbance using a standard spectrophotometer.

If ozone is added before UV disinfection, the UVT of the water can be increased measurably, thereby improving the efficiency of UV disinfection. Ozone also absorbs UV light, however, so if residual ozone enters the UV reactor, the resulting decrease in UVT can be significant and should be considered when determining the design UVT. To address this issue, PWSs can monitor the ozone residual and add an ozone-reducing chemical prior to the UV reactor to maintain the ozone residual below a specified setpoint value. Several chemicals can quench ozone, but some (such as sodium thiosulfate) also have a high UV absorbance value and can decrease UVT. Such chemicals should not be used prior to UV disinfection unless their application causes no residual concentration. Sodium bisulfite is an alternative to sodium thiosulfate that does not significantly affect UVT.

UVT Scans

If MP lamps are being considered, measuring the UVT at the wavelengths in the germicidal range (in addition to 254 nm) may also be important. A UVT scan is used to determine the UVT of the water over 200 – 300 nm (i.e., germicidal range). In a UVT scan, the absorbance at each wavelength is measured and converted to UVT using Equation 2.2 ($\% \text{UVT} = 100 \times 10^{-A}$). The UV absorbance of water typically decreases with increasing wavelength over the germicidal range. Thus, the UV light attenuation in a UV reactor and the corresponding disinfection performance depend on the absorbance at each emitted wavelength. Some UV manufacturers use site-specific UVT scans in their UV dose monitoring and control systems. UVT scans can also vary seasonally; therefore, UVT scans could be measured at different times during the year to account for this variation. Also, the UVT scans can be used to determine the appropriate UV-absorbing chemical for validating the UV reactors that will be installed.

3.4.4.2 Water Quality Parameters That Affect Fouling

Water quality can affect the amount and type of lamp sleeve fouling that occurs in UV reactors. The factors that affect fouling pertain to all UV equipment.

Fouling is typically caused by precipitation of compounds on the lamp sleeve, as described in Section 2.5.1.4. The rate of fouling and the consequent frequency of sleeve cleaning depend on ORP, hardness, alkalinity, lamp temperature, pH, and the presence of certain inorganic constituents (e.g., iron and calcium). If significant seasonal shifts in any of the parameters or coagulant doses are expected, the duration of the monitoring period should be sufficiently long to capture the variations.

Although fouling should not be a significant problem for most PWSs, the water quality parameters listed below should be monitored before the UV facility is designed, unless adequate water quality data are available. A summary of the data collection and analysis related to fouling parameters is provided in Table 3.3. Providing these data to UV manufacturers is recommended to help them qualitatively assess the fouling potential for their UV reactors and to assist designers in determining whether a particular cleaning system should be specified. These data will also help determine the fouling/aging factor, which is discussed in Section 3.4.5. (Note that ORP can be challenging to measure, so the data collected may have limited value.)

- Calcium
- Alkalinity
- Hardness
- Iron
- Manganese
- pH
- ORP

Table 3.3. Summary of Fouling Data Collection and Analysis

Issue	Fouling Parameters ¹
Collection Location	Locations that are representative of potential UV facility location(s)
Collection Frequency ² and Period	<ul style="list-style-type: none"> • Monthly for 1 – 2 months if water quality is stable • Monthly for 6 – 12 months (or more) if water quality changes seasonally
Recommended Data Analysis	Based on design engineer's and PWS' best professional judgment
Recommended Data to Provide to UV Manufacturer	Median and maximum values

¹ Fouling parameters include calcium, alkalinity, hardness, iron, manganese, pH, and ORP.

² More frequent samples may be necessary to capture a water quality event (e.g., storm events).

Pilot tests of waters with total hardness levels less than 140 mg/L and iron less than 0.1 mg/L found that standard cleaning protocols and wiper frequencies (one sweep every 15 – 60 minutes) addressed the effect of sleeve fouling at the sites tested (Mackey et al. 2001, Mackey et al. 2004). Recent research has shown, however, that the addition of a chemical oxidant directly upstream of UV reactors (i.e., downstream of filters) will increase the ORP and potential for fouling (Derrick 2005, Wait et al. 2005). Therefore, moving the chemical oxidation point from immediately upstream of the UV reactors to downstream of the UV reactors should be considered to reduce the potential for fouling. It should be noted that if oxidation and filtration occur prior to UV disinfection, the iron and manganese are typically oxidized and then filtered out prior to the UV reactor, and fouling will be minimal (Derrick 2005, Wait et al. 2005, Jeffcoat 2005).

If the ORP, pH, and inorganic constituent concentrations are low, fouling is not likely to be an issue, and a cleaning system may not be necessary. However, a cleaning system should be considered if iron and manganese are present. Also, if the chemical oxidation point cannot be moved from immediately upstream of the UV equipment and iron and manganese are present, pilot testing (Section 3.4.5.1) may be necessary to determine the fouling rate and effectiveness of sleeve cleaning.

3.4.4.3 Additional Water Quality Considerations for Unfiltered Supplies and Treatment of Uncovered Reservoir Water

Water supplies are susceptible to variable water quality, turbidity spikes, reservoir turnover, and seasonal algal blooms. Typically, water treatment processes at filtered WTPs dampen the effects of such variations on UV disinfection. Unfiltered supplies, however, generally do not have upstream treatment that mitigates these variations. Specifically, the presence of particles and algae may affect UV dose delivery, and water quality and UVT may

fluctuate more in unfiltered supplies and thus should be a consideration in the water quality data analysis.

Uncovered reservoirs have similar water quality issues as unfiltered supplies. In most cases, however, the problems are less severe because the water has been treated before it enters the uncovered reservoir and the operation of uncovered reservoirs is more controlled (e.g., smaller volumes, storm water control, concrete lining, and bird control). One exception is that algal blooms may be more prevalent in uncovered reservoirs than in unfiltered supplies if phosphate-based corrosion inhibitors are added at the WTP. Phosphates can promote algal growth.

Issues that should be considered in the water quality data analysis for unfiltered supplies and uncovered reservoirs are described in this section and summarized in Table 3.4.

Table 3.4. Summary of Particle and Algal Data Collection and Analysis

Issue	Particles and Algae
Collection Location	Locations that are representative of potential UV facility location(s)
Collection Frequency ¹ and Period	<ul style="list-style-type: none"> • Monthly for 1 – 2 months for an Unfiltered PWS • Bi-weekly for the summer months² for Uncovered Reservoirs
Recommended Data Analysis	Based on design engineer's and PWS' best professional judgment
Recommended Data to Provide to UV Manufacturer	Median and maximum values

¹ More frequent samples may be needed to capture a water quality event (e.g., storm events).

² Algal blooms often occur in summer months in uncovered reservoir supplies.

Water Quality Fluctuations from Reservoir Turnover

Reservoir turnover in unfiltered supplies and uncovered reservoirs may cause water quality changes that affect UV disinfection. The UVT and parameters that affect fouling should be monitored over a complete reservoir cycle to account for these issues in the design criteria. For example, reservoir turnover can cause increased iron levels, which is a factor that should be considered when assessing fouling potential. If the potential for increased iron levels is not assessed, the appropriate sleeve cleaning technology may not be installed, and UV dose delivery may be affected.

Particle Content and UVT Variability

For unfiltered systems, the Surface Water Treatment Rule (SWTR) allows turbidity up to 5 nephelometric turbidity units (NTU) immediately prior to the first point of disinfection application (40 CFR 141.71). Storm-related turbidity spikes are more prevalent in unfiltered supplies than in filtered supplies because no upstream treatment is available to remove the particles. Particles in water absorb and scatter UV light to varying degrees based on their size and composition. Particles affect the disinfection process in two ways:

1. Particles can decrease the UVT of water and thereby affect UV dose delivery.
2. Microorganisms can associate with particles and be shielded from UV light, thereby changing the characteristics of the UV dose-response curve that is obtained using collimated beam studies.

Several studies have found that the effects of turbidity up to 10 NTU on UV disinfection can be accounted for in the UVT measurements (Passantino et al. 2004, Christensen and Linden 2002). However, the most commonly used spectrophotometer (bench-top direct reading) may underestimate the UVT of water with turbidity greater than 3 NTU (Christensen and Linden 2002). To reduce this underestimation, all unfiltered systems and uncovered reservoir applications should use a bench-top UV spectrophotometer with an integrating sphere to provide more accurate UVT measurements for planning purposes.

For unfiltered waters susceptible to turbidity fluctuations, the UVT sampling should occur during these events and be accounted for in the design UVT and UVT range. If the design UVT is appropriate, the UV reactor will be able to respond to changes in UVT that arise due to particles.

As described previously, particle content and UVT variability will probably be less prevalent in uncovered reservoirs compared to unfiltered supplies. The UVT sampling, however, should be conducted during a period sufficient to include seasonal events (e.g., rainstorms and runoff) that will affect the design UVT and the UVT range.

Algae

Previous research with male-specific-2 bacteriophage (MS2) has shown that algal counts up to 70,000 cells/mL do not affect disinfection performance (Wobma et al. 2004). Whether algal counts greater than 70,000 cells/mL affect the UV disinfection process is unknown. Therefore, for both unfiltered supplies and uncovered reservoirs, UVT sampling should be conducted during algal blooms to enable their effects on UVT to be assessed. At high algal concentrations, bench-, pilot-, or demonstration-scale testing may be warranted to determine if UV disinfection is significantly affected.

3.4.5 Fouling/Aging Factor

Sleeve fouling, sleeve aging, lamp aging, and UV sensor window fouling (if applicable) affect long-term UV reactor performance, as described in Sections 2.4.2 and 2.4.4. The fouling/aging factor accounts for these issues.

An acceptable fouling/aging factor and guaranteed lamp life should be determined based on experience and professional judgment. Alternatively, pilot- or demonstration-scale testing can be used to estimate the fouling factor and aging factor if deemed necessary by the PWS, as described in Sections 3.4.5.1 and 3.4.5.2, respectively.

The lamp-fouling portion of the factor (i.e., fouling factor) is the estimated fraction of UV light passing through a fouled sleeve as compared to a new sleeve. A lamp sleeve can

become fouled when inorganics (e.g. iron) precipitate onto a lamp sleeve and reduce the UV transmittance of the sleeve. Water quality parameters that affect fouling are described in Section 3.4.4.2.

The lamp aging portion of the factor (i.e., aging factor) is the fraction of UV light emitted from aged sleeves and lamps compared to new sleeves and lamps and can be estimated by the lamp and sleeve aging characteristics obtained from the UV manufacturer. The lamp aging factor is important because as UV lamps age, the output of the lamps decrease.

The fouling/aging factor is calculated by multiplying the fouling factor by the aging factor and typically ranges from 0.4 (NWRI 2003) to 0.9. The fouling/aging factor is typically used in validation testing to ensure the UV equipment can meet the required dose in a fouled and/or aged condition. (See Equation 3.1.)

$$UV \text{ Dose with Clean Lamps} * \text{Fouling Factor} * \text{Aging Factor} \geq \text{Required UV Dose} \text{ Equation 3.1}$$

When purchasing a pre-validated reactor, the PWS should determine if validation testing was conducted under conditions of reduced lamp output (e.g., 70 percent) that is equal to or less than reduced lamp output expected for fouled/aged conditions at its water treatment plant (e.g., 0.75, or 75 percent). If the site-specific fouling/aging factor is lower (e.g., 0.5, or 50 percent) than considered during validation testing, adjustments in validation test results or additional testing should be considered.

Selection of a fouling/aging factor coupled with a guaranteed lamp life is a trade-off between maintenance costs (the frequency of lamp replacement or chemical cleanings necessary) and capital costs (the size of the UV reactors). Both a fouling/aging factor and a guaranteed lamp life should be selected because doing so will guarantee that the fouling/aging factor will not be exceeded within the guaranteed lamp life. Lamps for a UV reactor with a lower fouling/aging factor will require less frequent replacement because the UV reactors are designed with more or higher powered lamps to achieve the necessary UV output at the guaranteed lamp life. This strategy, however, may necessitate an increase in the size of the UV reactor and facility. Conversely, the use of an insufficiently conservative factor may underestimate the reduction in the lamp output and potentially result in off-specification operation or more frequent lamp replacement.

3.4.5.1 Testing to Determine the Fouling Factor

The specific fouling rate and optimal cleaning protocol for any given application cannot be predicted with existing empirically-proven, mathematical equations. A proper cleaning protocol and sleeve-fouling factor, however, can be adequately estimated for most water sources without pilot- or demonstration-scale testing and then adjusted during normal operation.

Alternatively, fouling rates can be evaluated on a site-specific basis through pilot- or demonstration-scale testing or during UV reactor start-up. Testing could consist of the following test elements:

- **Test setup:** The UV sensors, lamp and sleeve type, power system, and cleaning system tested in a pilot- or demonstration-scale system should be identical to the full-scale reactor. Differences in lamp and lamp sleeve geometry can lead to erroneous conclusions based on pilot data alone.
- **Flow and UV equipment conditions:** Water should flow through the reactor at the minimum flow rate, and the lamps should be operated at maximum power.
- **Establishment of cleaning settings:** UV equipment with on-line chemical cleaning (OCC) systems should be operated for a prescribed length of time (e.g., 2 weeks) without a chemical cleaning to evaluate fouling. With water systems using on-line mechanical cleaning (OMC) and on-line mechanical-chemical cleaning (OMCC), the cleaning systems should be operated at the manufacturer's recommended frequency to assess fouling. One sleeve should be unwiped, however, for the entire testing period to serve as a control to verify that fouling is occurring.
- **Assessment of fouling factor:** Fouling is assessed by placing a new lamp inside a fouled sleeve, igniting it, and measuring the UV intensity. The UV intensity should be compared to a similar measurement made using a new, clean sleeve. The ratio of these two measurements (UV light passing through the fouled sleeve to that passing through the new sleeve) is the fouling factor.
- **Evaluation of sleeve cleaning efficiency:** A sleeve cleaning assessment can also be performed to determine if more frequent cleaning could reduce the fouling factor.
- **Sensor window fouling (if applicable):** To assess fouling on the UV sensor windows, the windows should be cleaned with phosphoric or citric acid at varying time intervals, and the change in UV sensor readings recorded. The fouling rate of the lamp sleeves is likely to be greater than the fouling rate of the sensor windows because the sleeves are hotter than the windows, and higher temperatures accelerate fouling.
- **Quality assurance:** The fouled sleeve should be manually cleaned, which should restore the sleeve UV intensity value to very near that of a new, clean sleeve after the fouling factor has been determined. If not, the inside of the sleeve should be manually cleaned and the UV intensity measured again. If the UV intensity is still low, the sleeve material has likely degraded, and the test should be performed with a new sleeve to ensure that the test results indicate fouling only and not sleeve degradation.

The fouling factor data can be analyzed to determine the water system's preferred fouling factor under the observed sleeve cleaning efficiencies.

3.4.5.2 Testing to Determine the Aging Factor

The aging factor is the fraction of UV light emitted from aged sleeves and lamps compared to the fraction emitted from new sleeves and lamps. The lamp aging factor is typically between 0.5 and 0.8. In most cases, the aging factor can be determined from manufacturer data

with existing empirically proven, mathematical equations. The PWS, however, may desire testing to better understand lamp aging characteristics. Lamp aging tests assess the reduction and variance in lamp germicidal output over time under defined worst-case operating conditions. Factors to consider in designing the test(s) include lamp batch, lamp assembly, electrical characteristics of the ballasts, heat transfer from the lamps to the water, and lamp operation. Because lamps are manufactured in batches, lamps from several different lots should be evaluated to ensure that collected data are representative.

Lamp age can be tested with either a pilot- or demonstration-scale UV reactor or a test stand designed to simulate the UV lamp aging in full-scale operation. For either setup, lamps should be operated in an environment that reflects conditions expected when the UV equipment is installed at a WTP (e.g., use lamp sleeves, ballasts, and cleaning systems that will be used in the final application).

During testing, the following activities should be considered:

- Monitor the UV intensity, UVT, electrical power delivered to the ballast, electrical power delivered to the lamp, and water temperature over the lamp life.
- Visually inspect the lamp sleeves at regular intervals to document any degradation of the lamp assembly, including electrodes and seals, and any darkening of the lamp envelope.
- Document any fouling on the internal surfaces of the lamp sleeves.
- Using either a radiometer equipped with a germicidal filter or a reference UV sensor, measure the germicidal output of the lamp under fixed conditions of ballast operation (e.g., power setting); heat transfer (e.g., lamp sleeves); and environment (water temperature and transmission). The following procedure should be used:
 - Take one measurement with lamps that have been aged 100 hours (“new”).
 - Measure the output from various positions along the lamp based on visual inspection (i.e., the pattern of darkening on the lamp).
 - Measure lamp output as a function of lamp power setting if lamp power is variable.
 - Assess the output from lamps of different lots.

The lamp output measured under fixed operating conditions can be plotted over time and fit to estimate the mean expected performance for various lamp ages. To determine the aging factor, measure the output of a new lamp and the output at the end-of-lamp life. The aging factor is the ratio of the output at the guaranteed lamp life to new lamp output and is expressed as a fraction.

Although it does not impact reactor design, studies have shown that non-uniform lamp aging can occur. Non-uniform lamp aging should be considered during validation testing. (See Section 5.4.6)

3.4.6 Power Quality Evaluations

UV lamps can turn off if a voltage fluctuation, power quality anomaly, or a power interruption occurs. Power quality tolerances depend on the UV equipment design and vary significantly among UV manufacturers (Table 3.5). The UV manufacturer should be contacted to determine the power quality tolerance and the length of time for the equipment to reach full power after a power quality event. (See Section 2.4.2.3.)

Table 3.5. Power Quality Triggers for UV Reactors¹

Power Quality Event		LPHO Manufacturer #1	LPHO Manufacturer #2	MP Manufacturer #1	MP Manufacturer #2
Voltage Sag/Swell Tolerance	Voltage ²	± 20%	± 10%	± 30%	± 20%
	Duration ³	2 seconds (s)	> 0.03 s	> 0.02 s	2 s
Power Interruption Tolerances ⁴	Duration ³	> 0.05 s	> 0.03 s	> 0.009 s	> 0.05 s

¹ Information shown in the table is compiled from Calgon Carbon Corporation, Trojan Technologies, and WEDECO.

² Percent of line voltage. For example, a 10-percent voltage loss is when the voltage is at 90% of the line voltage.

³ 1 cycle is 0.017 s.

⁴ Power interruption assumes total voltage loss.

Source: Cotton et al. (2005)

Studies have shown that the typical industrial power user experiences an average of eight power quality events per month (Grebe et al. 1996). Accordingly, power quality problems alone likely will not cause UV reactors to exceed the maximum off-specification requirements even though UV reactors are sensitive to power quality (Cotton et al. 2005). Therefore, a power quality assessment is probably necessary only when the installation site is (1) known to have power quality problems (e.g., 30 power interruptions and/or brownouts per month); or (2) located in a remote area and the power quality is unknown.

If power quality may be a problem at the intended installation location, a power quality assessment can be performed to quantify and understand the potential for off-specification operation, which consists of the following five steps:

1. Estimate the power quality at the potential location(s) of the UV facility. Local power suppliers often can provide data on power quality and reliability and should be the first source of information. Other sources of information are operating records of power quality incidents (if available), power interruptions, or Supervisory Control and Data Acquisition (SCADA) information for the existing plant.

2. Understand the power quality tolerance of the UV equipment under consideration by contacting the UV manufacturer or consulting published data.
3. Contact the UV manufacturer to determine how long it will take their equipment to be functioning at full power after a power quality event.
4. Estimate the off-specification time for the potential UV equipment-based information gathered in Steps 1 through 3. Examples of how to estimate off-specification based on this information are presented in Cotton et al. (2005).
5. Determine if backup power or power conditioning equipment is needed to reduce off-specification time or to improve UV equipment reliability.

Generally, personnel with a working knowledge of electrical supply and installation will be able to review power supply data and determine if power quality problems exist. More advanced assessments can include the installation of power quality monitors or the retention of an outside consultant to conduct a detailed power quality assessment.

3.5 Evaluating UV Reactors, Dose Monitoring Strategy, and Operational Approach

Selecting the appropriate UV reactor depends on the installation locations under consideration and the design parameters discussed in Section 3.4. The UV reactor manufacturer is a valuable resource for such evaluations and can determine what UV reactors are most appropriate for the installation locations under consideration. Evaluating the available UV reactors in the planning process is important because each manufacturer's UV reactors are unique and proprietary, and installation needs (e.g., power requirements) differ. UV reactors can generally be characterized based on lamp type with low-pressure high-output (LPHO) lamps and medium-pressure (MP) lamps applicable to most WTPs. This section discusses the general characteristics of LPHO and MP reactors and describes the various control strategies. UV manufacturers should be contacted directly to gain a better understanding of the available and appropriate UV reactors.

3.5.1 Characteristics of LPHO and MP Reactors

The fundamental difference between LPHO and MP reactors is the lamp intensity output (which influences the UV reactor configuration and size), lamp life and replacement, power use, power modulation capabilities, and sleeve cleaning.

- **UV reactor configuration and size:** Several UV reactor configurations are available. Reactors can be in-line (i.e., shaped like a pipe), S-shaped, or U-shaped, depending on the UV manufacturer and the site constraints of the specific installation location. Typically, LPHO reactors have a larger footprint than MP reactors because more UV lamps are needed to deliver the same required UV dose. MP reactor footprints will also vary, depending on lamp orientation (e.g., parallel versus perpendicular to flow).

- **Lamp life and replacement:** Lamp life also varies between LPHO and MP reactors. Most manufacturers provide warranties of 8,000 – 12,000 hours for LPHO lamps and 4,000 – 8,000 hours for MP lamps. Although the lamp life for LPHO reactors is greater than that for MP reactors, more lamps are needed for an LPHO reactor. The actual number of lamps replaced during a given period, therefore, may be less for MP reactors.
- **Power use:** Even though LPHO reactors typically have more lamps, they require less power input than similarly sized MP reactors because LPHO lamps are more efficient in converting the power to germicidal UV light for disinfection. This decreased energy efficiency results in higher power needs and increases in overall power consumption for MP reactors compared to LPHO reactors.
- **Power modulation capabilities:** The ability of the UV equipment to adjust lamp power or number of UV lamps energized will affect the energy use. Unlike the other issues described, power modulation capabilities depend on the UV equipment design and not the lamp type.
- **Sleeve Cleaning:** The lamp sleeve cleaning systems for LPHO and MP reactors can also differ. LPHO reactors typically have OCC systems, and MP reactors typically have OMC systems. Although OCC systems tend to be more labor intensive than OMC systems, OMC systems typically have more parts to replace. The extent of fouling will determine the amount of maintenance (labor and parts) that is needed on a routine basis and will affect the overall maintenance costs.

As described, the PWS should evaluate the differences between LPHO and MP reactors and determine any preferences based on the different characteristics and site-specific constraints. If one technology is precluded, it should not be evaluated further in the planning analyses.

3.5.2 Dose-monitoring Strategy and Operational Approach

The dose-monitoring strategy establishes the operating parameters used to confirm UV dose delivery. It affects how a reactor is validated, how instrumentation and controls are designed, and how the reactor is operated. In the planning phase, the water system should evaluate the various dose-monitoring strategies to determine whether a particular approach is preferable based on the ease of integration into their existing operation and control system. If a particular dose-monitoring strategy is preferred, the water system should select a UV equipment that has been validated for that strategy. The effect of the dose-monitoring strategy on the instrumentation and controls design is described in Section 4.3.

UV manufacturers commonly design their reactors to operate using either:

- The UV Intensity Setpoint Approach or
- The Calculated Dose Approach

This guidance manual focuses on the design, validation, and operation of UV reactors that use one of these two approaches. Another existing dose-monitoring strategy or a new strategy developed after this manual is published, however, may also be suitable for reactor operations as long as they meet minimum regulatory requirements.⁵ Alternative strategies should be considered on a case-by-case basis.

Table 3.6 summarizes key characteristics of the two dose-monitoring approaches discussed in this manual. The next two sections provide an overview of how the approaches operate. Advantages and disadvantages of each are discussed in Section 3.5.2.3, and Section 6.4 provides additional guidance on monitoring frequency and reporting requirements for these control strategies.

Table 3.6. Dose-monitoring Approaches – Key Characteristics

Dose-monitoring Strategy	Parameter Used as the Operational Setpoint	Parameters Monitored During Operations to Confirm Dose Delivery
UV Intensity Setpoint Approach	UV Intensity	Flow rate Lamp status UV intensity
Calculated Dose Approach	Calculated or Validated dose ¹	Flow rate Lamp status UV intensity UVT

¹ As noted in Section 3.4.1, the calculated dose is estimated using a dose-monitoring equation. For the Calculated Dose Approach, the validated dose is equal to the calculated dose divided by a Validation Factor, which accounts for biases and experimental uncertainty.

3.5.2.1 UV Intensity Setpoint Approach

As indicated by its name, the UV Intensity Setpoint Approach relies upon one or more “setpoints” for UV intensity that are established during validation testing. During operations, the UV intensity, as measured by UV sensors, must meet or exceed the setpoint(s) to ensure delivery of the validated dose. Importantly, reactors must also be operated within the validated range of flow rates and lamp statuses (i.e., the “validated operating conditions”) [40 CFR 141.720(d)(2)].

One key characteristic of the UV Intensity Setpoint Approach is that water systems *need not monitor UVT* during operations to confirm dose delivery. Instead, the approach relies on UV intensity readings by UV sensors to account for changes in UVT. In order for UV sensors to efficiently monitor dose delivery, they should be as close as possible to the “ideal” location. This means that they should be positioned so that the UV intensity is proportional to the UV dose, irrespective of changes in UVT and lamp output. If the sensor is too close to the lamp, changes in lamp output will disproportionately impact the measured UV intensity. If the sensor is too far from the lamp, changes in UVT of the water will disproportionately impact the measured UV

⁵ Systems must monitor flow rate, lamp status, and UV intensity, plus any other parameters required by the state at a minimum to show that a reactor is operating within validated conditions [40 CFR 141.720(d)(3)(i)].

intensity. Water systems can check if sensors are in the ideal location by reviewing validation test data. (See Chapter 5.)

The recommended validation protocol in Chapter 5 will produce conservatively high UV intensity setpoint(s) under many water quality and lamp output conditions if the sensor is not in the ideal location, resulting in overdosing during operations. In some cases, UV manufacturers have developed modifications to the UV Intensity Setpoint Approach to account for non-ideal sensor placement.

Water systems can use one of the following operating strategies for the UV Intensity Setpoint Approach: single-setpoint operation or variable-setpoint operations. Table 3.7 describes these operating strategies and summarizes the advantages and disadvantages of each.

Table 3.7. Advantages and Disadvantages of Single-setpoint and Variable-setpoint Operations for the UV Intensity Setpoint Approach

Operating Strategy	Description	Advantages	Disadvantages
Single-setpoint	One UV intensity setpoint is used for all flow rates that were validated	Simplest to operate and control	When flow rate is variable, not energy efficient under most conditions because reactor is overdosing at low flow rates
Variable-setpoint ¹	The UV intensity setpoint is determined using a lookup table or equation for a range of flow rates	Lamp output can be reduced at low flow conditions to reduce energy costs	More validation data are needed. More complex operation compared to single-setpoint approach. Necessitates more advanced UV reactor monitoring and control.

¹ For the purposes of this guidance manual, variable-setpoint operations refers to variations based on flow rate only, as this is the most common application. In theory, multiple setpoints could also be established for different lamp statuses and UVT ranges.

3.5.2.2 Calculated Dose Approach

The Calculated Dose Approach uses a *dose-monitoring equation* to estimate the UV dose based the parameters measured during reactor operations. The most common operational parameters in dose-monitoring equation are:

- Flow rate,
- UV intensity, and
- UVT

Some manufacturers also consider lamp status as a variable in the dose-monitoring equation.

UV manufacturers may develop a theoretical dose-monitoring equation using numerical models (e.g., computational fluid dynamics [CFD]). Although the theoretical equations can be used as a starting point, EPA strongly recommends that water systems use an empirical dose-monitoring equation developed through *validation testing*. To generate the empirical dose-monitoring equation, validation tests are performed over a wide range of flow rates, UVT values, and lamp power combinations. Regression analysis is used to fit the observed validation data to an equation. Chapter 5 of this manual provides detailed guidance on how to derive an empirical dose-monitoring equation through validation testing.

During reactor operations, the UV reactor control system (i.e., the internal reactor electronics) typically inputs the measured parameters into the dose-monitoring equation to produce a calculated dose. The system operator divides the calculated dose by a Validation Factor that accounts for uncertainties and biases to determine the validated dose.⁶ The operator compares the validated dose to the required dose for the target pathogen and log inactivation level.

3.5.2.3 Advantages and Disadvantages

The principal operating advantage of the UV Intensity Setpoint Approach compared to the Calculated Dose Approach is that UVT monitoring is not needed to confirm dose delivery. Another important advantage is that the UV Intensity Setpoint Approach, single-setpoint operation is straightforward and simple to control with one operational setpoint and one maximum value for flow rate. For these reasons, EPA believes this option is good for small water systems. Other advantages are that the UV Intensity Setpoint requires fewer validation tests than the Calculated Dose Approach and data analyses are relatively straightforward. Data analyses to develop the dose-monitoring equation for the Calculated Dose Approach can be complex.

Water systems may favor the Calculated Dose Approach over the UV Intensity Setpoint Approach because it offers significant flexibility to reduce operating costs by manipulating lamp power (e.g., turning off banks of lamps or powering down lamps when the UVT increases and/or the flow rate decreases). This process is also called “dose pacing.” Another potential advantage is that operations are more intuitive because the calculated dose, adjusted for uncertainties and biases, can be directly compared to the required dose for the target pathogen and log inactivation.

Manufacturers may favor the Calculated Dose Approach because they have more flexibility in UV sensor positioning (i.e., because internal analyzers monitor UVT during operations instead of relying on sensors to respond to changes in UVT, positioning sensors as close as possible to the “ideal” location offers no advantages). As noted in Section 3.5.2.1, UV Intensity Setpoint Approach operations will be more efficient if the UV sensors are at or near the ideal location.

⁶ In some cases, the UV reactor control system will perform this step as well, outputting the validated dose automatically.

3.6 Assessing UV Equipment Validation Issues

For disinfection credit, the LT2ESWTR requires UV reactors to be validated [40 CFR 141.720(d)]. A water system's approach to UV reactor validation and to UV facility design is interrelated. The issues to consider are whether equipment will be validated on-site or off-site and the hydraulic conditions of the UV reactor validation and installation. This section describes how these issues affect the design and the relationship between the validation and hydraulic installation approaches. Chapter 5 details the UV reactor validation guidelines.

3.6.1 Off-site Versus On-site Validation

UV reactors can be validated either off-site or on-site. With off-site validation, the UV reactors are validated before installation (i.e., pre-validated), typically at a third-party validation test center or a UV manufacturer facility. With on-site validation, the UV reactors are validated at the PWS after they have been installed. Many PWSs will use off-site validation to meet the LT2ESWTR requirements. In some cases, however, on-site validation may be appropriate (e.g., when the full UVT range was not tested in off-site validation). The advantages and disadvantages of off-site and on-site validation are presented in Table 3.8.

Table 3.8. Advantages and Disadvantages of Off-site and On-site Validation

	Advantages	Disadvantages
Off-site	<ul style="list-style-type: none"> • Broader ranges of flow and water quality are tested so a reactor can be validated for more than one application • Installation hydraulics are general, allowing for installation at most WTPs • Process is simpler for utilities because testing is conducted at a remote location • Cost is usually lower • Reactor performance is known before facility is designed and constructed 	<ul style="list-style-type: none"> • Re-validation or additional on-site validation testing may be necessary if site-specific hydraulics and water quality are not within the tested ranges • Water quality and hydraulics may not match the installation location, potentially resulting in less efficient operation
On-site	<ul style="list-style-type: none"> • Exact hydraulics of the installation are used • Water quality tested is specific to the installation • Having provisions for on-site testing (e.g., feed and sample ports and static mixers) enables flexibility for future testing to optimize performance 	<ul style="list-style-type: none"> • Facility may be designed and constructed before reactor performance is verified • Water quality is limited to the highest UVT at the facility during the testing period • Testing logistics can be complex, including isolation of the test reactor, assessment of additive mixing, and challenge microorganism stability • Cost may be higher • Disposal of test water may require special permits

The PWS should determine whether off-site or on-site validation will be used to meet the LT2ESWTR requirements. If on-site validation is preferred, the UV facility design should be adapted to enable testing. The UV reactor design should incorporate feed and sample ports, static

mixers, space for tanks near the UV facility for adding the challenge microorganism and UV absorbing chemical, and a method to discharge the validation test water. If off-site validation is preferred, the UV facility need not incorporate provisions for on-site validation testing.

If pre-validated reactors that were validated off-site are chosen, the PWS should confirm that the validation hydraulic recommendations in Section 3.6.2 can be met without additional on-site validation or PWS-specific off-site validation.

3.6.2 Validation and Installation Hydraulics Recommendations

The inlet and outlet piping to the UV reactor in the UV facility should result in a UV dose delivery that is equal to or greater than the UV dose delivered when the UV reactor was validated. If off-site validation is used, the three preferred options for meeting this condition are presented below.

- 1. Minimum five pipe diameters of straight pipe upstream of UV reactor:** The length of straight pipe upstream of each UV reactor at the UV facility is the length of straight pipe used in the validation testing plus a minimum of five (5) pipe diameters. During validation testing, the inlet piping to the reactor consists of either a single 90-degree bend, a “T” bend, or an “S” bend, followed by a length of straight pipe if necessary. See Figure 3.7 for validation and installation configuration options.
- 2. Identical inlet and outlet conditions:** Inlet and outlet conditions used during validation match those used at the WTP for at least ten (10) pipe diameters upstream and five (5) pipe diameters downstream of the UV reactor.
- 3. Velocity profile measurement:** Velocity of the water measured at evenly spaced points through a given cross-section of the flow upstream and downstream of the reactor is within 20 percent of the theoretical velocity with both the validation test stand and the WTP installation (NWRI 2003). The theoretical velocity is defined as the flow rate divided by the cross-sectional area.

Jetting and swirling flow will impact the assumptions for Options 1 and 3. To avoid jetting flow, the inlet piping should have no expansions for at least ten (10) pipe diameters upstream of the reactor. Also, any valves located in that length of straight pipe should always be fully open during UV reactor operation. To avoid swirling flow, the validation piping should not include two out-of-plane 90°-bends in series.

The most suitable validation option depends on the site-specific layout and piping constraints and on the validation data. Option 1 is more generally applicable for validation and installation of UV reactors. For example, the inlet and outlet piping configuration for installations in a new building could be designed based on how the procured UV reactor was validated. Option 2 is most applicable when unique piping configurations are needed or if the inlet and outlet conditions validated in Option 1 cannot be achieved because of site constraints. For example, Option 2 may be the only validation option for an individual filter effluent location, which likely will not have 5 diameters of straight pipe before the UV reactors (Option 1) because

of existing site constraints. Option 3 also provides flexibility but may have the practical limitation of measuring the velocity through a cross-section at the installation.

Figure 3.7. Schematic of Hydraulic Option #1 (90°-Bend, T-Bend, S-Bend Inlet Piping Scenarios)

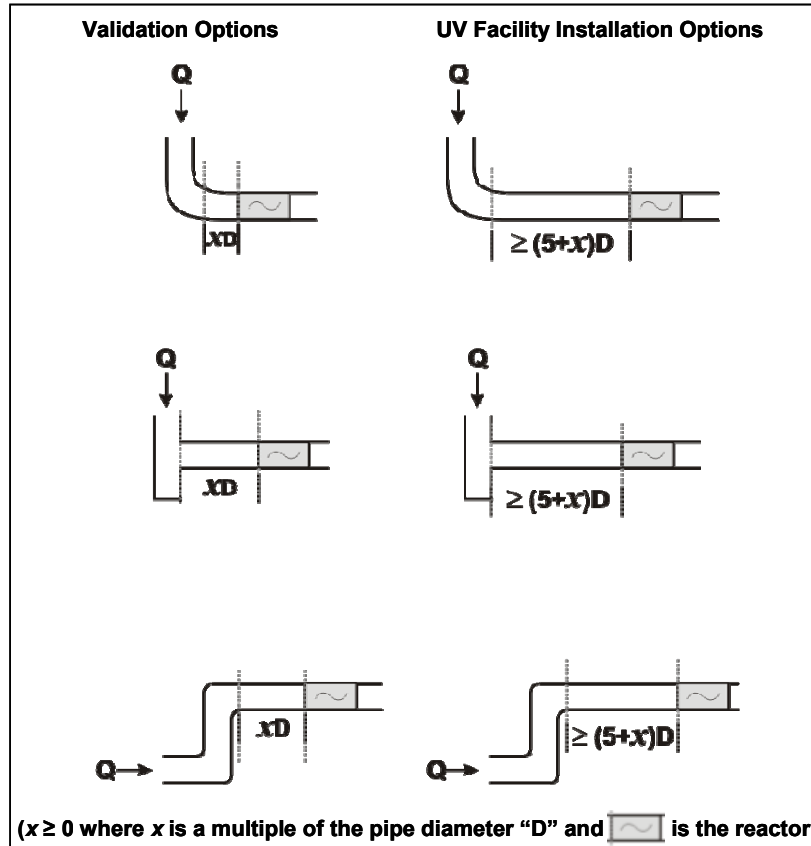

If available, the validation report for pre-validated UV equipment under consideration should be reviewed to determine what the inlet/outlet conditions were during validation, which will help determine if Option 1 is feasible. The method for meeting these recommended inlet/outlet constraints should be determined in the planning stage and considered when developing the UV facility layout (Section 3.8.2).

CFD modeling and CFD-based UV dose modeling of inlet and outlet conditions may be used to assess whether UV dose delivery at the WTP installation is better than UV dose delivery achieved during validation for given conditions of flow rate, UVT, and lamp output. The state should approve such models and their reliability should be properly evaluated before their results are accepted. Appendix D provides guidance on evaluating CFD models.

3.6.3 Selection of Validation and Hydraulic Approach

Whether or not the UV reactor was pre-validated off-site affects the inlet/outlet piping options for the UV facility. Completing on-site validation provides more inlet/outlet piping

flexibility, but on-site validation means additional design considerations and testing at the water treatment plant. If the selected UV equipment is not pre-validated, the PWS can choose either off-site or on-site validation based on their site-constraints and preferences. These options are described in Figure 3.8.

Figure 3.8. UV Reactor Validation Options and How They Affect Installation Hydraulics

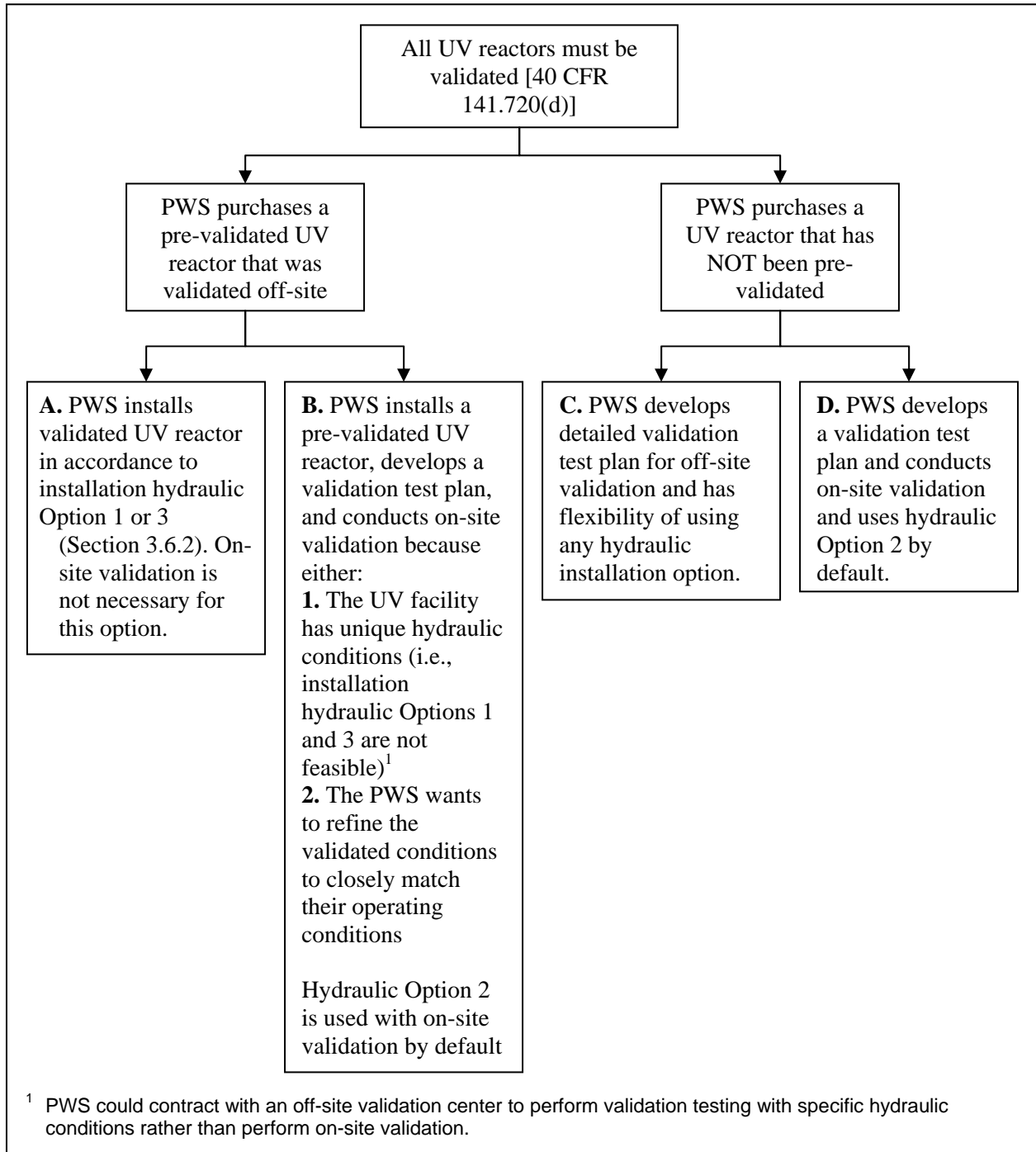

3.7 Assessing Head Loss Constraints

When selecting a feasible location for UV reactors, the hydraulic requirements should be met. Head loss through a UV reactor is specific to the equipment and flow rate and generally varies from 0.5 – 3 feet (UV reactor only). Characteristic head loss data should be obtained from the UV manufacturer(s) for all candidate UV reactors. In addition to the head loss associated with the UV reactor itself, the head loss associated with piping, valves, flow meters, and flow distribution devices (e.g., baffles) should be considered when assessing the feasibility and location of the installation. When selecting a reactor that has been validated off-site (Options A of Figure 3.8), the UV reactor inlet/outlet piping used to estimate the head loss through the facility should be consistent with the validation recommendations described in Section 3.6.2. The head loss through the entire UV facility (i.e., piping, valves, joints, and UV reactors) can be between 1 and 8 feet.

If the head loss through the UV facility is greater than the available head, the plant design or operation, or both, may require modification. Some potential modifications, alone or in combination, that may be considered to address hydraulic limitations are listed below, and details for each are provided in the sections that follow:

- Eliminating existing hydraulic inefficiencies within the facility to improve head conditions (e.g., replacing undersized or deteriorated piping and valves)
- Modifying the operation of the clearwell
- Modifying the operation of the filters
- Installing intermediate booster pumps
- Modifying the operation of the HSPs

3.7.1 Eliminating Existing Hydraulic Inefficiencies

Replacing undersized piping and valves with larger diameter piping and valves may increase the available head for the proposed UV facility. Older piping can also produce excessive head loss if the inner pipe surface is pitted or scaled or if the pipe material has a high coefficient of friction. Slip-lining the interior of existing pipe with material having a lower coefficient of friction (e.g., high-density polyethylene) is one method of reducing friction losses. Re-lining the existing pipe interior with a smooth coating will also reduce head loss.

3.7.2 Modifying Clearwell Operation

A PWS may increase head available to a UV facility by lowering the surface water level of the clearwell. This strategy, however, decreases the storage volume available to meet peak demands, reduces the contact time available in the clearwell for chemical disinfectants, and may affect the pump discharge head and distribution system pressure. Evaluating any potential

reduction in disinfection credit is important if contact time in the clearwell is used for calculating chlorine disinfectant requirements (i.e., CT). The UV facility, however, may reduce the *Giardia* CT requirements sufficiently to offset the reduction in CT.

3.7.3 Modifying Filter Operation

A treatment facility can alter the operation of its filters (e.g., increase the water elevation above the filters) to increase the head available for the UV facility. This approach, however, can reduce filter run times and reduce unit filter run volumes, resulting in a need for more frequent backwashing. If conditions upstream of the filters are such that additional freeboard and hydraulic head are available, a second option is to increase the water surface elevation above the filters to help minimize the reduction in head as the water is filtered.

3.7.4 Installing Intermediate Booster Pumps

When modifications to the existing facility or operations do not provide adequate head for the UV reactors, intermediate booster pumps can be installed. Booster pumping increases flexibility in locating the UV reactors. Installing booster pumps, however, increases facility operation and maintenance costs and space requirements. The reliability of the pumps should also be considered in the evaluation because they become a critical operating component. More information on intermediate booster pumps is presented in Section 4.1.6.

3.7.5 Modifying Operation of HSPs

When UV disinfection is installed close to the HSPs (e.g., after the clearwell in a filtration plant or after an unfiltered reservoir), one option to increase the head available for the UV facility is to modify the pumping operation of the HSPs. Modifications may not be practical, however, if they change the distribution system pressure.

3.8 Estimating UV Facility Footprint

The process footprint should be estimated in the planning phase to help determine feasible UV facility locations. The critical components for estimating the UV facility footprint are UV equipment constraints and UV facility layout.

3.8.1 UV Equipment Constraints

The UV equipment constraints that affect the footprint estimation are the number of UV reactors needed to meet the design criteria, the UV reactor orientation, and the control panel location constraints.

- **Number of UV reactors:** The number of UV reactors depends on the redundancy chosen and the power modulation capabilities of the UV reactor. UV reactor

redundancy should be determined using sound engineering approaches similar to those used for other major equipment (e.g., capacity to provide full treatment with the largest UV reactor out-of-service). The ability of the UV equipment to modulate lamp power or change the number of lamps energized also should be considered, so that energy efficient operation is possible at the operating range of flows and UVTs expected for the UV reactors. The UV manufacturer should be contacted to determine a particular UV reactor's power modulation capabilities.

- **UV reactor orientation:** UV reactors can be oriented either parallel or perpendicular to the ground. Two advantages of vertical orientation (i.e., flow perpendicular to the ground) are that (1) the footprint will be smaller and (2) the potential for lamp breaks due to debris may be reduced (as described in Appendix E).
- **Control panel location constraints:** Maximum allowable separation distance between the UV reactors and electrical controls should be considered in the UV facility layout and footprint estimation. This information is unique to each UV reactor and should be obtained from the UV manufacturer.
- **Validation hydraulic restrictions:** Section 3.6.2 describes how the validation piping configuration can dictate the possible UV facility piping configurations.

3.8.2 Develop UV Facility Layout

The UV facility layout is dictated by site constraints and the UV equipment constraints described in the previous section. The following items should be considered when developing the UV reactor and piping configuration and estimating the UV facility footprint in the planning phase:

- Number, capacity, dimensions, and configuration of the UV reactors (including redundancy and connective piping)
- Vertical or horizontal orientation of the UV reactor
- Maximum allowable separation distance between the UV reactors and electrical controls if distance limitations apply
- Adequate distance between adjacent reactors to afford access for maintenance tasks (e.g., lamp replacement)
- Configuration of the connection piping and the inlet/outlet piping necessary before and after each UV reactor, based on validated hydraulic conditions (see Section 3.6.2) and UV manufacturer recommendations
- Space and piping for booster pumps and wetwells (if necessary)
- Space for electrical equipment, including control panels, transformers, ballasts, backup generators, and possible uninterruptible power supplies

- Room for storing spare parts and chemicals (if needed)
- Lifting capability for heavy equipment
- Provisions for on-site validation (if applicable)

The dimensions of UV reactors and associated electrical equipment vary depending on the UV manufacturer. Installation footprint and layout should therefore be estimated for all UV manufacturers being considered. Once the UV facility footprint is estimated, feasible site locations can be determined based on the available land and buildings.

3.9 Preparing Preliminary Costs and Selecting the UV Facility Option

The amount of analysis necessary to determine the appropriate application point for a UV facility is site-specific. Some options clearly will be infeasible, while others may necessitate a more detailed comparison of the installation options. Once feasible alternatives are identified, development of life-cycle costs and consideration of the non-monetary factors (e.g., ease of UV facility operation) can be useful in selecting among alternatives.

Preliminary life-cycle cost estimates should include capital costs and operation and maintenance (O&M) costs. Capital costs include the cost of the UV reactors; building (if necessary); piping; pumping (if necessary); electrical and instrumentation provisions; site work; contractor overhead and profit; pilot-testing (if necessary); validation costs; and engineering, legal, and administrative costs. The O&M costs should include the estimated labor, energy, and equipment replacement costs. The LPHO equipment and MP equipment have different O&M needs (Section 3.5.1) that should be considered in the O&M costs.

Selection of the best option should be based on the disinfection and design objectives and consideration of the following and other PWS-specific criteria:

- Cost-effectiveness and ability to meet the water system's disinfection and design objectives
- Ease of installation (where applicable)
- Operational flexibility and reliability
- Specific maintenance needs
- Flexibility for future treatment expansion (if applicable)

3.10 Reporting to the State

Interaction with the state throughout the planning and design phases is recommended to ensure that the objectives of both the PWS and the state are met. This interaction may require several months and can have a significant effect on the implementation schedule, particularly when the state requires modifications. Given the relatively limited use of UV disinfection in the

United States to date, drinking water treatment, and the unique technical characteristics of this technology, state agencies may not have developed approval requirements specifically for UV disinfection. As such, PWSs are urged to consult with their state early in their UV disinfection planning process to understand the approvals and documentation that will be required for the use of UV disinfection.

The state may require that a preliminary design report be submitted that summarizes the decision logic used to identify, evaluate, and select UV disinfection. The following items may be addressed in the preliminary design report:

- Disinfection objectives (target organism and inactivation)
- Overall disinfection strategy
- Summary of reasons for incorporating UV disinfection
- Description of the overall process train
- Description of the proposed UV reactors
- Water quality data
- Design criteria
- Validation Test Plan (if performing on-site or off-site validation- See Section 5.11 for guidance on developing a Validation Test Plan)

This page intentionally left blank.

4. Design Considerations for UV Facilities

This chapter presents the key factors that should be considered during the detailed design phase and is written under the premise that the necessary planning and evaluation work discussed in Chapter 3 has been completed. This chapter focuses primarily on the design of UV disinfection applications for filtered surface water. Most of the information presented, however, also applies to unfiltered systems, groundwater under the direct influence (GWUDI), and uncovered finished water reservoirs. Additional design issues specifically associated with unfiltered, GWUDI, and uncovered finished water reservoir systems are also described.

Chapter 4 covers:

- 4.1 UV Facility Hydraulics
- 4.2 Operating Approach Selection
- 4.3 Instrumentation and Control
- 4.4 Electrical Power Consideration and Back-up Power
- 4.5 UV Facility Layout
- 4.6 Elements of UV Equipment Specifications
- 4.7 Final UV Facility Design
- 4.8 Reporting to the State during Design

In the United States, most public water systems (PWSs) purchase or select the UV equipment before the UV facility design is complete. Pre-purchase or pre-selection of the UV equipment enables the designer and the UV manufacturer to coordinate during the detailed, final design phase to consider manufacturer-specific design recommendations. Sometimes the equipment is pre-selected and the UV equipment manufacturer is included in the construction contract. Other procurement methods (e.g., base-bid and contractor selection of equipment) are also used, but these methods are less common.

The process for designing a UV facility is presented as a flowchart in Figure 4.1. The illustrated process is based on pre-purchasing or pre-selecting the UV equipment using a traditional design-bid-build approach. Any of the equipment procurement and contractor selection approaches currently available within the industry, however, can be used to build UV facilities. The PWS and the engineer are responsible for selecting the most appropriate approach for their specific project. The order of the steps for other procurement approaches may differ from that shown in Figure 4.1, but the analyses completed are likely to be very similar. The steps described in this chapter follow the order presented in Figure 4.1. Some states may have design and plan review requirements that could impact the timing or sequence of steps shown in Figure 4.1. The appropriate state regulatory agency should be contacted early in the design process to discuss specific design requirements, plan review fees, and review scheduling.

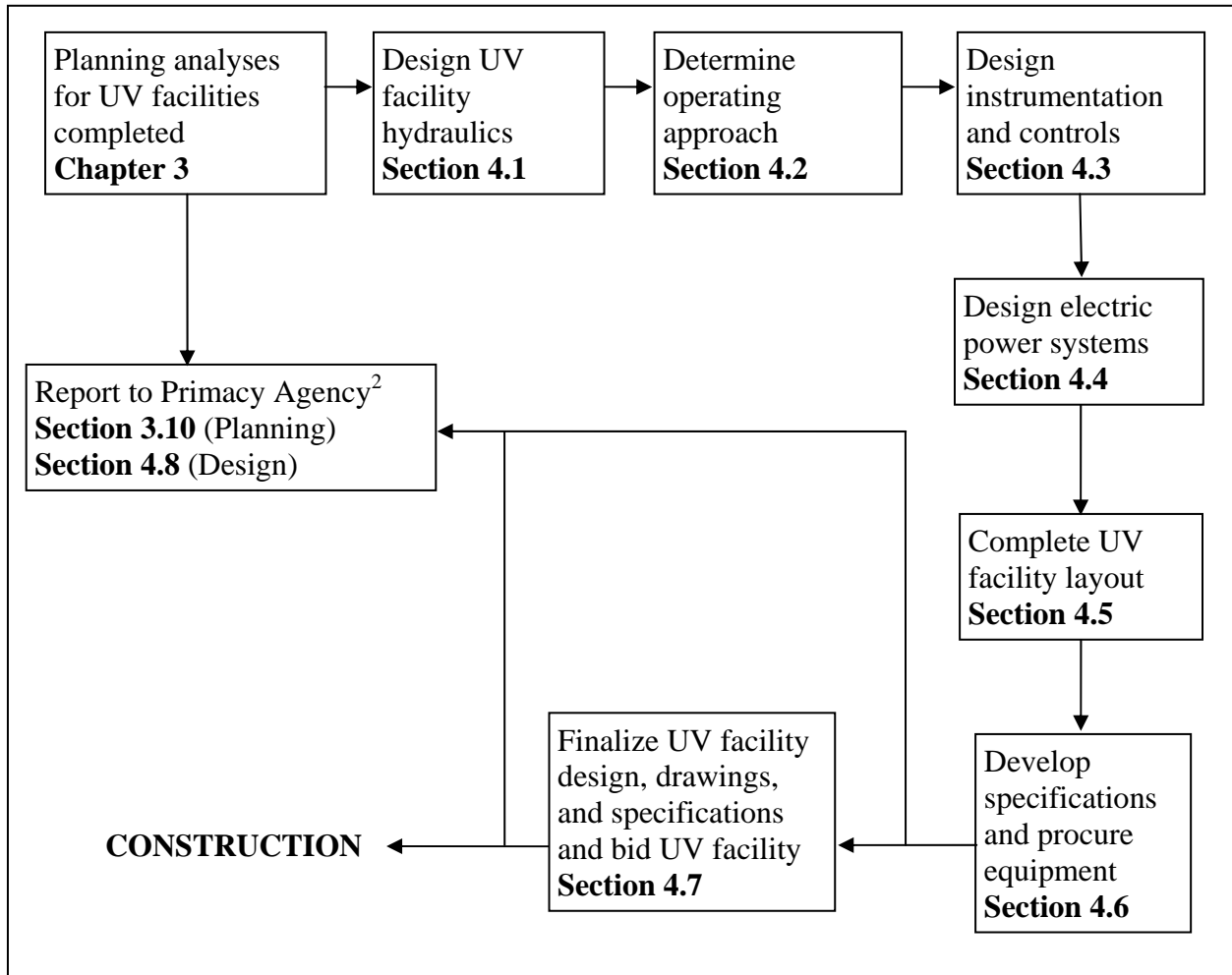
Figure 4.1. Flowchart for Planning, Design, and Construction of UV Facilities¹

¹ Flowchart is based on pre-purchase of UV reactors that have undergone validation testing and equipment installation using a traditional design-bid-build approach.

² Additional state coordination may be necessary.

4.1 UV Facility Hydraulics

After the facility location and UV equipment are selected during the planning phase, a more detailed evaluation of system hydraulics for the UV facility layout developed in Section 3.8 should be conducted. In most cases, the UV facility will be designed with multiple, parallel UV reactor trains of the same capacity. Each train consists of the lateral piping, UV reactor, valves, and flow meter (if applicable) and is joined to the other trains by the distribution and recombination channel or manifold. The hydraulic evaluation should include upstream and downstream processes for free water surfaces, the inlet/outlet piping configuration, flow control and distribution, flow rate measurement, level control, air and pressure controls, valving, and, where applicable, intermediate booster pumps.

4.1.1 Inlet and Outlet Piping Configuration

The recommended inlet and outlet conditions for validation and for the UV facility are described in detail in Section 3.6.2. If validation is conducted at an off-site testing facility, the designer should refer to the validation report to determine the validated inlet and outlet conditions, and then use the recommendations in Section 3.6.2 to determine the recommended inlet and outlet piping for the UV facility. If on-site validation or custom off-site validation is planned, the inlet and outlet hydraulics should be designed according to manufacturer recommendations and to accommodate any site-specific constraints. In addition, to avoid jetting flow, the inlet piping should have no expansions for at least ten (10) pipe diameters upstream of the reactor.

4.1.2 Flow Distribution, Control, and Measurement

Regulations specify flow rate, UV intensity, and lamp status as the minimum operating conditions that a PWS must routinely monitor [40 CFR 141.720(d)(3)]. Accordingly, proper flow distribution and measurement are essential for compliance monitoring of the UV reactors. This section discusses various methods for designing proper flow distribution and measurement through the UV reactors.

4.1.2.1 Flow Distribution and Control

The lateral piping for each UV reactor train should be sized and configured to provide approximately equal head loss through each UV reactor train over the range of flow rates. Importantly, flow rate through each reactor must conform to the validated operating conditions, [40 CFR 141.729(d)] as described in the validation report.

Two approaches for flow distribution and control are generally used. The first is active flow control and distribution, in which a dedicated flow meter and modulating control valve are installed for each UV reactor. Active flow control provides the greatest hydraulic control in applications with widely varying flow rates. The second method is passive flow distribution. For the passive approach, equal flow split is monitored with flow meters.

For PWSs that use distribution and recombination channels (instead of influent and effluent manifolds), designers typically have two basic choices to achieve passive flow distribution (Figure 4.2): (1) a series of individual weirs set at the same elevation or (2) a series of orifices submerged in the individual UV reactor laterals.

4.1.2.2 Flow Rate Measurement

The method of flow rate measurement selected should be based on the variability in plant flow rate, the type of flow split used, and any state requirements. Selection of the flow rate measurement method should be at the discretion of the PWS and the design engineer based on experience and professional judgment. Generally, each UV reactor should have a dedicated flow meter (as described in Table 4.1) to confirm that the reactor is operating within the validated

flow rate. The state, however, may approve other methods (e.g., one flow meter coupled with pressure differential measurements).

Figure 4.2. Open-channel Flow Distribution Options

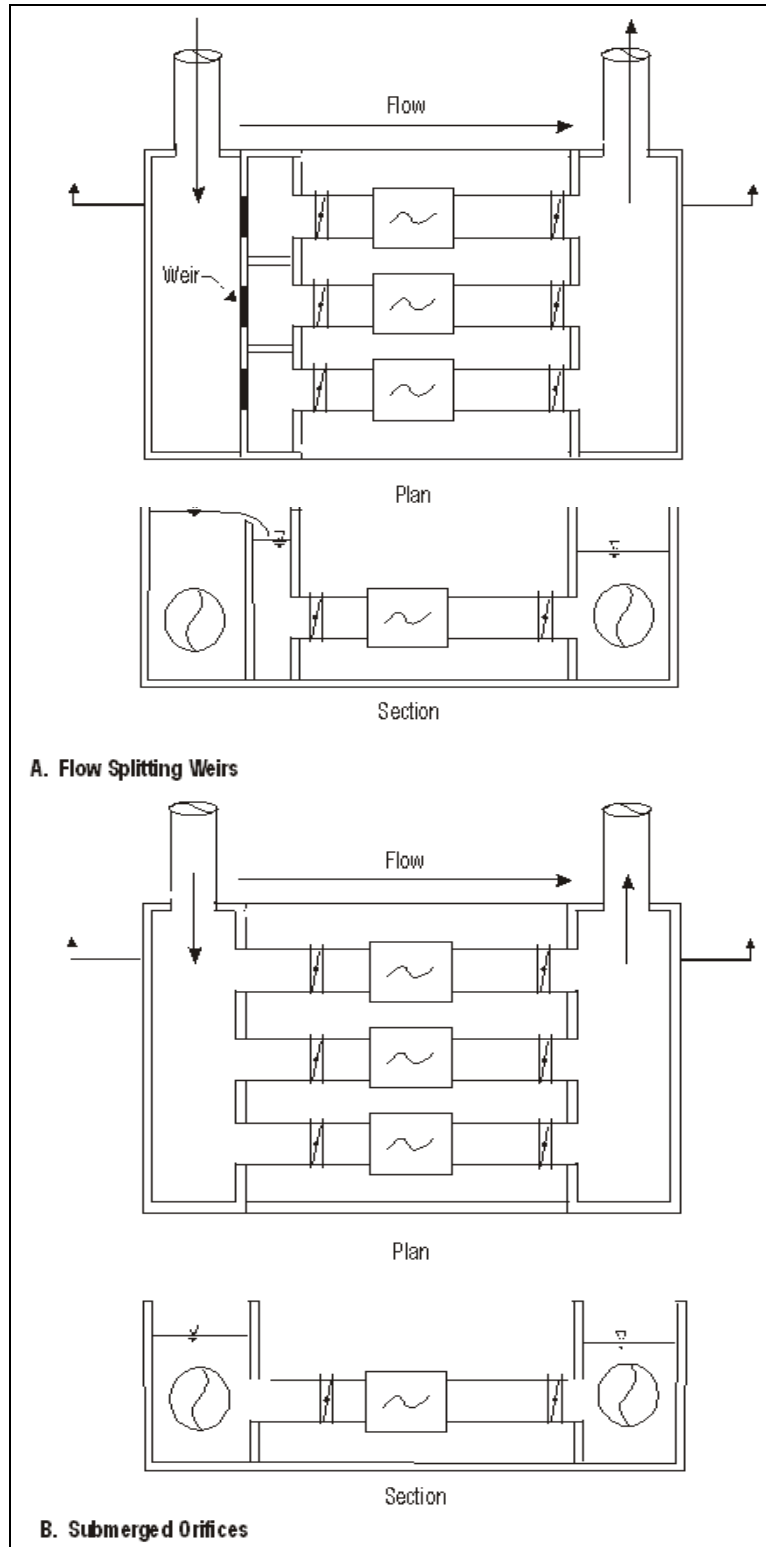

Table 4.1. Comparison of Techniques for UV Facility Flow Rate Measurement for Combined Filter Effluent and Post-clearwell UV Facilities ¹

Flow Rate Measurement Method	Flow Control Method	Advantages	Disadvantages
Individual UV Reactor Flow Rate Measurement	Passive flow control such as a weir or an orifice	<ul style="list-style-type: none"> Measures individual UV reactor flow rates accurately 	<ul style="list-style-type: none"> May have unequal flow distribution Cannot control the UV reactor flow rate
Individual UV Reactor Flow Rate Measurement and Control	Individual flow control (valve) for each UV reactor	<ul style="list-style-type: none"> Measures individual UV reactor flow rates accurately Does not rely on passive flow distribution 	<ul style="list-style-type: none"> Increases capital cost May increase facility footprint due to hydraulics of UV reactor, meter, and valves

¹ For individual filter effluent installations, the flow rate from the filters can be used to determine the flow rate through the UV reactors.

When selecting a flow meter, the flow meter's effect on the inlet/outlet hydraulics of the UV reactor should be considered. Magnetic or other types of flow meters (such as Doppler) that do not protrude into the flow path exert the least effect on the velocity profile, which minimizes the potential effect on reactor inlet or outlet hydraulics.

4.1.3 Water Level Control

The UV lamps in the UV reactor should be submerged at all times to prevent overheating and UV equipment damage. This is accomplished by installing the UV reactors at an elevation below the hydraulic grade line elevation. Two common methods for keeping the UV lamps submerged are to:

1. Install a flow control structure (e.g., weir or orifice) immediately downstream of the UV reactor or at another location that ensures full pipe conditions through the UV reactors.
2. Use flow control valves to monitor and maintain the hydraulic grade line.

Damage to UV lamps caused by operation in air is specific to each lamp type and size. Low-pressure (LP) lamps can typically operate in air for up to 24 hours with minimal damage. Low-pressure high-output (LPHO) lamps will begin experiencing damage as a result of dislodged amalgam or mercury adsorption to the inner surface of the lamps in 6 – 12 hours (Lawal 2006). Medium-pressure (MP) lamps can experience advanced aging or solarization in fewer than 6 hours and can break (see Appendix E).

4.1.4 Air Relief and Pressure Control Valves

UV reactors should be kept free of air to prevent lamp overheating. Negative gauge pressures or surge effects within the UV reactors should also be prevented to avoid damage to the lamps and lamp sleeves. Quartz sleeves are designed to accommodate continuous positive pressures of at least 120 pounds per square inch gauge (psig) but have been shown to break at negative pressures of 1.5 (Roberts 2000, Aquafine 2001, Dinkloh 2001). Negative pressures can result from line breaks or accidental dewatering of the reactor. The use of air release valves, air/vacuum valves, or combination air valves may be necessary to prevent air pockets and negative gauge pressure conditions. The UV manufacturer should be contacted to determine any equipment-specific air release and pressure control valve needs. The valve locations will be dictated by the specific configuration of the facility and should be determined during design.

4.1.5 Flow Control and Isolation Valves

Each UV reactor should be capable of being isolated and removed from service. Isolating or shutting down a UV reactor will require valves, gates, or similar devices upstream and downstream of the UV reactor. Valves are recommended because they provide a tighter seal. During design, the inlet and outlet valve configuration should be discussed with the UV manufacturer to ensure that UV reactor performance will not be adversely affected and that the required inlet conditions used during validation are met, as discussed in Section 3.6.

If the isolation valves are also used for flow control, the flow control valve should be located downstream of the UV reactor to limit the disturbance of the flow entering the UV reactor. Valves downstream of the UV reactor can be equipped with an actuator to open or close automatically on a critical alarm occurrence and to enable start-up sequencing.

Valve seats and other in-pipe seals and fittings within the straight pipe lengths adjacent to the UV reactors should be constructed of materials that are resistant to UV light and chemicals that may be used for reactor cleaning. Resistant materials will help avoid valve degradation.

4.1.6 Installation of Intermediate Booster Pumps

A detailed evaluation and design of a booster pumping system is recommended if head constraints indicate a pumping system is necessary. Pumps common in water treatment plants (i.e., vertical turbine, end-suction centrifugal, and split-case centrifugal pumps) tend to have higher discharge pressures than needed for intermediate pumping applications and are generally not appropriate. Mixed- or axial-flow pumps with high-flow and low-head operating characteristics are usually better choices for intermediate pumping applications because typically only 1 – 8 feet of additional hydraulic head is needed to overcome the head loss through the UV facility.

Pumps can be installed before or after the UV reactors, allowing more flexibility in the UV facility's design elevations and the location of the UV reactors. Regardless of pump location, some form of wetwell should be provided upstream of the pump station. Existing clearwells, recombination channels, or dedicated pump wetwells may be used.

Booster pump operation may be controlled by the water level within the upstream wetwell. The use of variable frequency drives or a rate-of-flow controller with a modulating valve to dampen flow rate peaks is recommended, especially if the pump station is upstream of the UV reactors. By minimizing hydraulic peaks, the UV reactors can be sized to more closely match the flow rate through the water treatment plant (WTP).

4.1.7 Evaluating Existing Pumps and Potential Water Hammer Issues

In some WTPs, the most feasible location for installing the UV reactors may be immediately upstream or downstream of existing high-service pumps (HSPs) (Section 3.3.1.3). The HSP discharge curves should be analyzed to determine the effect of the increased head loss through the UV reactors and whether HSP modifications are necessary.

If pumps are located adjacent to the UV reactors, the impact of surge conditions should be evaluated. Of particular concern is the potential for surge if the pumps are operating and power is lost. Pump start-up procedures should be carefully defined, including procedures for pump control valves. Control of individual UV reactor isolation valves should be coordinated with pump starts and stops and with pump control valves where appropriate. Likewise, the warm-up time associated with the start-up of the UV reactors should be taken into account with the sequencing of the pump operation.

4.1.8 Groundwater System Hydraulic Issues

Common hydraulic issues associated with groundwater systems include high operating pressures, air entrainment, and the potential for water hammer events.

Lamp sleeves are designed to resist high external operating pressures. Before selecting equipment, however, the designer should determine the maximum expected operating pressure, which may occur during a failure event (e.g., downstream valve closes), and confirm that the proposed equipment can withstand that pressure.

Pressure surge events (water hammer) near the UV reactor may be more likely with groundwater systems than surface water systems because of the UV reactor's proximity to the well pumps. Surge events can cause positive or negative pressure transients in the well discharge piping and potentially break the sleeves and lamps. A surge analysis is recommended to determine if surge protection is necessary. Many well sites and distribution systems are already equipped with surge control tanks to dampen surge effects. These tanks may provide sufficient protection for the UV reactors, depending on their location relative to the UV reactors.

Air binding can interfere with the UV disinfection process or cause the lamps to overheat. UV reactors should be located downstream of any existing or planned air removal equipment (if necessary). Otherwise, the UV facility design should include a means for automatically releasing air prior to the UV reactor. The UV reactor may have air release valves or valve ports, or air release valves can be installed in the inlet piping.

4.1.9 Uncovered Finished Water Reservoir Hydraulic Issues

Many uncovered finished water reservoirs serve as distribution storage and are directly affected by the water system demand. Others may be used solely as an emergency supply or may function as both distribution storage and emergency supply. The specific hydraulic considerations that a PWS and designer should consider will vary depending on the function of the uncovered finished water reservoir. Regardless of reservoir function, however, specific hydraulic issues that should be considered when designing UV facilities at uncovered finished water reservoirs include widely varying flow rates, bi-directional flow (under certain piping configurations), and the effect a UV facility will have on system pressure.

- **Variable flow rate:** The methodology described in Section 3.4 should be followed to determine the flow rate and UVT that are used to design the UV facility. Most UV facilities at uncovered finished water reservoirs should be designed to handle the peak instantaneous demand that must be met by the reservoir. The instrumentation and control (I&C) design must consider how the PWS will sequence the UV reactors with highly variable flow conditions, especially warm-up times for UV lamps (Section 2.4.2.3).
- **Bi-directional flow:** In some cases, the inlet and outlet to the uncovered finished water reservoir is the same pipe, and the UV facility should be designed so that disinfection continues when the water is flowing from the uncovered finished water reservoir. The PWS may also consider operating the UV reactors at a minimum level as the water flows into the reservoir so that the UV lamps are energized and ready for UV disinfection if the flow direction changes suddenly. The necessity for this latter approach depends on the number of directional changes per day in the context of meeting off-specification requirements.
- **UV facility effect on system pressure:** As discussed in Section 3.7, head loss through a UV reactor generally varies from 0.5 to 3 feet, with the overall head loss through a UV facility typically about 1 to 8 feet. This head loss could affect the distribution system pressure. As discussed in Chapter 3, a hydraulic assessment should be completed to determine if head loss constraints occur for the UV facility or if booster pumping is needed.

4.2 Operating Approach Selection

The operating approach is the method of operating a UV reactor based on the **dose-monitoring strategy (Section 3.5.2) and validation report data** and should be determined before the I&C design is complete. The operating conditions for each UV reactor must be based on validation testing results [40 CFR 141.720(d)(3)].

As described in Section 3.5.2, this guidance manual focuses on two dose-monitoring strategies: UV Intensity Setpoint Approach and Calculated Dose Approach. The UV Intensity Setpoint Approach can be used with a single or variable setpoint operation; variable setpoint

operation allows for some energy savings. The Calculated Dose Approach typically uses a single setpoint (e.g., the required dose), and the UV equipment automatically compensates based on the UVT, UV sensor measurements, and flow rate, which increases energy savings.

When considering the dose-monitoring strategy and operating approach, the operational complexity should be compared to the potential for energy savings. The UV manufacturer should be contacted to determine the potential energy savings with the available dose-monitoring strategies and operating approaches. For small water systems, the UV Intensity Setpoint Approach with a single setpoint may be the best option because the energy savings with a more complex operating approach may not be worth the additional operational needs. Detailed examples of how to determine the operational setpoints from validation reports for these operating strategies are described in Section 6.1.4.

4.3 Instrumentation and Control

The necessary level of I&C depends on the selected techniques for flow control and distribution, flow rate measurement, and the operating approach. For example, passive flow distribution with the UV Intensity Setpoint Approach that uses a single setpoint is simple and demands limited I&C but may result in reduced operating flexibility and energy efficiency. More complex control strategies, such as the use of dedicated flow meters and flow control valves with the Calculated Dose Approach, necessitate a higher level of I&C, but improve operating flexibility and enable optimization of disinfection performance. The control system complexity and operating flexibility should be balanced to meet the needs of the PWS.

Most of the manufacturers' equipment has similar I&C attributes and alarm conditions incorporated in the UV reactor designs. The designer should identify the

- Elements that are preprogrammed in the UV reactor control panel
- Necessary supplemental controls to coordinate the operations of the UV reactor trains
- Actions necessary for each alarm condition.

At a minimum, UV lamp intensity, flow rate, and lamp status must be monitored (40 CFR 141.720(d)(3)). The final I&C design can be modified as needed after UV equipment is selected. The following sections describe the elements that should be considered in I&C design.

4.3.1 UV Reactor Start-up and Sequencing

This section describes the typical UV reactor start-up protocol, strategies for sequencing the start-up of multiple UV reactors, and considerations for groundwater UV facility start-up.

4.3.1.1 UV Reactor Start-up

The UV reactor start-up sequence depends on whether the UV reactor requires cooling water while the UV lamps warm up. Some reactors require cooling water (Leinberger 2005, Larner 2005) and some do not (Larner 2005, Bircher 2005). Without water flow, some UV lamps may heat the water above the safe operating temperatures of 30 – 49 °C in 2.5 – 15 minutes, causing the reactor’s internal safety devices to shut the reactor off (Leinberger 2005, Bircher 2005). LP and LPHO reactors typically do not and some MP reactors do not need cooling water as the UV lamps are warming up (Haubner 2005). UV lamp breaks (discussed in detail in Appendix E) can occur if the lamps become overheated because of no flow or minimal cooling water flow. **The designer should consult the UV manufacturer to determine whether the UV reactor requires cooling water during start-up.**

The potential start-up sequences for UV reactors that do and do not need cooling water and are starting cold (i.e., previously off as opposed to shut down for a very short period) are summarized below:

- **UV reactors that do not require cooling water:** The potential control sequence will ignite the lamps, get the UV reactor to its validated conditions, and open the isolation valves. With this strategy, the UV reactor will be “on” for some time when no water is flowing through it. Flow should be established in the UV reactor within an hour to prevent fouling of the quartz sleeves.
- **UV reactors that do require cooling water:** The potential control sequence will open the isolation valves to allow the minimal cooling water flow, ignite the lamps, get the UV reactor to its validated conditions, and then fully open the isolation valves to allow the full flow through the UV reactor. The I&C should be designed to reduce the amount of off-specification water by providing the minimal flow necessary to keep the lamps cool during start-up. If the amount of off-specification water should be limited, methods are available to design the UV facility piping to minimize off-specification water (e.g., cooling water being diverted to waste).

For facilities that do not operate continuously, the designer should discuss the specific operating schedule with the manufacturer to identify any special provisions that should be included in the design or the operating procedures (e.g., automatic cleaning before each start-up, draining for extended periods of downtime).

4.3.1.2 UV Reactor Sequencing

UV facilities with multiple UV reactors should develop two types of UV reactor start-up sequences in I&C loop descriptions:

- **Routine operation:** The UV reactor sequencing should be developed based on the validated conditions and the operational approach.
- **Start-up after a power quality event:** The control system should monitor the power input to the UV reactors and the UV reactor status. LPHO and MP reactors have

different start-up characteristics after a power quality event (Section 2.4.2.3) and should have different start-up sequences to minimize warm-up and corresponding off-specification time.

- **LPHO reactors** – UV reactors that were on-line (i.e., operating) before the power quality event and shut-down should be restarted first after normal power is restored.
- **MP reactors** – UV reactors that were off-line before a power quality event that shuts down UV reactors should be started first when normal power is restored.

4.3.1.3 Groundwater Pump Cycling Effects on UV Reactor Start-up

Groundwater well cycling can adversely affect UV reactor performance, causing an increase in off-specification water. An analysis should be performed to estimate off-specification volume based on the current well cycling frequency. The well cycling approach may need to be changed if off-specification requirements cannot be met under current well cycling frequency. Two approaches that can minimize the effects of well cycling, depending on whether the UV reactors require cooling water, are discussed below.

- **UV reactors that do not require cooling water:** A time delay can be incorporated in the I&C loops that prevents the well pump from starting until the UV reactor reaches its validated conditions. As described in Section 4.3.1.1, the UV reactor will be “on” for some time when no water is flowing through it.
- **UV reactors that do require cooling water:** The I&C programming would supply the minimum water flow through the UV reactor until the reactor reaches validated conditions. Then, the groundwater flow can be increased to meet system demand. If desired, the cooling water can be discharged to waste if site conditions permit.

4.3.2 UV Equipment Automation

UV equipment operation can range from manual to fully automatic, depending on the reactor’s size and complexity. Manual operation includes manually initiating lamp start-up and shut-down, and activating the appropriate valves. Various levels and types of automation are typically part of the internal UV equipment controls and can be added to the manual sequence. A first level of automation includes the sequencing of lamp start-up and valve actuation to bring individual UV reactors on-line after manual initiation. Further levels of automation include starting UV reactors, activating rows of lamps, or making lamp intensity adjustments based on UV intensity, UVT, or flow rate. Automatic UV reactor shut-down under critical alarm conditions (e.g., high temperature, lamp or sleeve failure, loss of flow) is essential for all operating approaches, including manual operation.

4.3.3 Alarms and Control Systems Interlocks

Many UV reactor signals and alarms are specific to the UV facility and the level of automation used. Alarms may be designated as minor, major, or critical, depending on the severity of the condition being indicated.

- A **minor alarm** generally indicates that a UV reactor requires maintenance but that the UV reactor is operating in compliance. Minor alarms also can be set for conditions just short of failure conditions so that major alarm conditions are not reached. For example, a minor alarm would occur when the UVT is within 1 percent UVT of the minimum allowed UVT or when the end-of-lamp-life based on hours of operation is reached, indicating the possible need for lamp replacement.
- A **major alarm** indicates that the UV reactor requires immediate maintenance (e.g., the UV sensor value has dropped below the validated setpoint) and that the unit may be operating off-specification. Based on the water system's disinfection objectives, this condition may also be handled as a critical alarm.
- A **critical alarm** typically shuts the unit down until the cause of the alarm condition is remedied. An example of a critical alarm is the UV reactor's temperature exceeding a pre-determined maximum value, resulting in automatic shut-down to prevent overheating and equipment damage.

The same alarm condition may represent a different level of severity depending on the validated conditions, the type of UV reactor, the operating approach, and the disinfection objectives of the PWS. For example, if a UV reactor was validated with one lamp out of service, a single lamp failure alarm may trigger a minor alarm. Had the reactor been validated with all lamps in operation, a single lamp failure may trigger a major alarm. Table 4.2 summarizes typical UV reactor monitoring and alarms that would likely be integral to the UV reactor control panel.

4.3.4 UV Reactor Control Signals

The designer should coordinate with the UV manufacturer to determine what elements of the control system are integral to the UV reactor and what elements should be addressed with supplemental controls and equipment (i.e., supervisory control and data acquisition or SCADA). For installations with multiple UV reactors, a common, master control panel may be necessary to optimize UV reactor operations. Typically, each UV reactor has a dedicated control panel, and the plant's SCADA system receives control signals from each control panel to control the entire UV facility. The SCADA system also monitors and records the process parameters. Recommended monitoring and recording frequencies are provided in Chapter 6, and the designer should coordinate with the state to determine if expected frequencies differ. This section describes the control signals that could be transferred from each reactor's control panel to the SCADA system.

4.3.4.1 UV Intensity

Signals from UV sensors should be displayed locally on the UV reactor control panel and in the plant's SCADA system screen (if applicable).

Table 4.2. Typical Alarm Conditions for UV Reactors ¹

Sensor	Alarm Type	Purpose/Description
Lamp Age	Minor alarm	Run-time for lamp indicates end of defined operational lamp life.
Calibration Check of UV sensor	Minor alarm	UV sensor requires calibration check based on operating time.
Low UV Validated Dose	Major alarm	Indicated validated UV dose (based on UV reactor parameters, i.e., flow rate, UV intensity, and UVT) falls below required UV dose.
Low UV Intensity	Major alarm	Intensity falls below validated conditions.
Low UV Transmittance	Major alarm	UVT falls below validated conditions.
High Flow Rate (Not Integral to UV Reactor—Relies on Flow Meters)	Major alarm ²	Flow rate falls outside of validated range.
Mechanical Wiper Function Failure (If Applicable)	Major alarm	Wipe function fails.
Lamp/Ballast Failure	Major alarm	Single lamp/ballast failure identified. ³
	Critical alarm	Multiple lamp/ballast failures identified.
Low Liquid Level	Critical alarm	Liquid level within the UV reactor drops and potential for overheating increases.
High Temperature	Critical alarm	Temperature within the UV reactor or ballast exceeds a setpoint.

¹ Alarm conditions and relative severity shown above may vary depending on the specific validated conditions, type of UV reactor, manufacturer, dose-monitoring strategy, and disinfection objectives of the PWS.

² Based on measurement from dedicated flow meters or calculated based on total flow rate divided by number of UV reactors operating.

³ Coordinate with UV manufacturer to determine if a lamp/ballast failure could indicate a sleeve and lamp break, which should be classified as a critical alarm.

4.3.4.2 UV Transmittance

If the Calculated Dose Approach is used, the UVT must be known to ensure that it is within the validated range. An on-line UVT analyzer or a bench-top spectrophotometer may be used to monitor UVT. Output from an on-line UVT analyzer can be input directly into a control loop for most UV reactors, a SCADA system, or both. Results from a bench-top spectrophotometer can be manually input into a SCADA system or UV reactor control panel(s).

4.3.4.3 Flow Rate Measurement

To maintain regulatory compliance, the flow rate through a UV reactor must be known to ensure that it is within the validated range [40 CFR 141.720 (d)(2)]. Section 4.1.2 discusses flow rate measurement and control options. The flow rate signal should be displayed locally or be input directly into a control loop for the UV reactor, a SCADA system, or both.

4.3.4.4 Calculated and Validated UV Dose (If Applicable)

If the Calculated Dose Approach is used, the calculated and validated doses should be displayed locally and transmitted to the SCADA system. The validated dose is equal to the calculated dose divided by the Validation Factor (See Section 5.10 for details).

4.3.4.5 Operational Setpoints

The operational setpoints should be displayed locally and remotely in the SCADA system. These setpoints will depend on the specific dose-monitoring strategy, operating approach (Section 4.2), and the validation data, and may include UV intensity, UVT, flow rate, calculated dose, and validated dose.

4.3.4.6 Lamp Age

The operating time of each lamp should be monitored, displayed locally, and transmitted to the SCADA system to facilitate O&M and lamp replacement, as discussed in Section 6.3.2.6.

4.3.4.7 Lamp Power, Lamp Status, and Reactor Status

Water systems must monitor lamp status to verify that UV reactors are operating within validated conditions [40 CFR 141.720(d)(3)]. Lamp status refers to whether the lamp is “on” or “off.” The operating power level should also be monitored and displayed at the control panel and remotely in the SCADA system. Each reactor’s on-line or off-line status should also be monitored and indicated locally and remotely, which can be accomplished by monitoring power and valve status.

4.3.4.8 UV Reactor Sleeve Cleaning

Sleeve cleaning information should be displayed locally and communicated between the local control panels and the SCADA system. This information should include the date and time of the last cleaning for off-line chemical cleaning (OCC) systems and the wiping frequency for on-line mechanical cleaning (OMC) or on-line mechanical-chemical cleaning (OMCC) systems.

4.3.4.9 Alarms

At a minimum, alarm conditions should be displayed locally. The use of visual or audible alarms is also recommended. If the UV facility will frequently be unstaffed or a SCADA system is already in place, provisions should also be included in the design to allow remote monitoring and display through the SCADA system.

4.4 Electrical Power Configuration and Back-up Power

The electrical power configuration should take into account the power requirements of the selected equipment, the disinfection objectives, and power quality issues, if applicable. (See Section 3.4.6.)

4.4.1 Considerations for Electrical Power

The proper supply voltage and total load requirements should be coordinated with the UV manufacturer, considering the available power supply. In addition, the power needs for each UV reactor component may differ. For example, the UV reactor may require 3-phase, 480-volt service, while the on-line UVT analyzer may need single-phase, 110-volt service. Excluding high service pumping, the electrical load from UV reactors will typically be among the larger loads at the WTP.

Due to the varying nature of UV reactor loads, current and voltage harmonic distortion can be induced. Such disturbances can cause electrical system problems, including overheating of some power supply components and can affect other critical systems, such as variable frequency drives (VFDs), programmable logic controllers (PLCs), and computers. Selection of the UV reactors should be based on a thorough analysis of the potential for the equipment to induce harmonic distortion. Additionally, the UV facility design and UV equipment should meet the Institute of Electrical and Electronic Engineers (IEEE) 519 Standard that addresses harmonics.

One method for controlling harmonics is to use a transformer with Delta Wye connections to isolate the UV reactor from the remainder of the WTP power system. The Delta-connected primary feed can be designed and sized to trap and moderate any induced harmonics. The Wye-connected secondary should be solidly grounded so that the ballasts are powered from a grounded source in accordance with electrical code requirements. If a separate transformer for the UV reactors is impractical, harmonic filters can be added to the UV reactor power supply to control distortion.

4.4.2 Back-up Power Supply and Power Conditioning

The continuous operation of the UV reactor is highly dependent on the power supply and its quality (Section 3.4.6). If the power reliability requirements and, consequently, the disinfection objectives cannot be met by relying solely on the commercial power supply, the use of back-up power, power conditioning equipment, or both may be necessary.

4.4.2.1 Back-up Power Supply

A simple backup power supply (e.g., generator) may be sufficient if power quality issues are infrequent. If an existing backup power supply is in place, its load capacity should be assessed to determine whether it can accept the additional load associated with the UV facility. The time necessary for switching from the primary power supply to a backup power supply and how that time affects compliance with the allowable off-specification operation should be determined.

4.4.2.2 Power Conditioning Equipment

Power conditioning equipment may be necessary if the power quality analysis reveals frequent events (Section 3.4.6) that cause the UV facility not to meet disinfection objectives. A site-specific analysis should be completed to determine the most appropriate power conditioning approach (Cotton et al. 2005). Consideration should include off-specification compliance, quality of the power supply, the cost of power conditioning equipment, and site constraints (e.g., land availability).

- **Uninterruptible Power Supply (UPS)** systems provide continuous power in the event of voltage sag or power interruption. The battery capacity is large enough to supply power to all connected equipment until a generator starts. UPS systems can either be on-line or off-line:

On-line UPS: The unit and batteries are installed in series between the incoming power feed and all critical equipment. The incoming power feed charges the UPS batteries, and the batteries supply the electrical load. In this situation, the power feed is completely separated from the electrical load. This alternative is the most costly and has the largest footprint.

Off-line UPS: The unit is installed in parallel with the connection from the incoming power feed to the critical equipment. During normal operations, the electrical load receives power directly from the power feed. When the off-line UPS senses a voltage fluctuation greater than or less than 10 percent of the nominal voltage, the load transfers to the UPS until the electrical feed stabilizes or the generator starts. Off-line UPS systems are less costly and have a smaller footprint than on-line UPS systems.

- **Active Series Compensators** protect electrical equipment against momentary voltage sags and interruptions. These devices boost the voltage by injecting a voltage in series with the remaining voltage during a sag condition. The corrected response time is a fraction of a cycle, preventing the equipment from experiencing a voltage sag. Active series compensators are well suited for instantaneous sags and interruptions; however, they cannot correct sustained sags or interruptions. Active series compensators are the lowest cost and smallest power conditioning option.

4.4.3 Ground Fault Interrupt and Electrical Lockout

Proper grounding and insulation of electrical components are critical for protecting operators from electrical shock and protecting the equipment. When combined with effective lockout/tagout procedures, the risk of electrical shock is further minimized. Ground fault interrupt (GFI) is another important safety feature for any electrical system in contact with water, including UV reactors. All UV reactor suppliers should provide GFI circuits for their lamps, which should be included in the specifications developed for equipment procurement. For a GFI to function properly, the transformer in the UV reactor ballast must not be isolated from the ground. If the UV reactor ballast isolates the output from the ground, ground faults will not be properly detected, and safety can be compromised.

Provisions enabling the UV reactors to be isolated and locked out for maintenance, both hydraulically and electrically, should be included in the design. Control of all lockout systems should remain local; however, when appropriate, the status of local lockouts could be monitored remotely. In all cases, the design must comply with electrical code and policy requirements for equipment lockout.

4.5 UV Facility Layout

Site layout for a UV facility is generally similar to the layout for any treatment process. Access for construction, operation, and maintenance should be considered. Typically, a preliminary layout is developed during project planning (Section 3.8.2). This preliminary layout may be modified to address space constraints or special installation conditions that result from the final equipment selection or based on more extensive site information gathered during detailed design. In addition to those items identified in Section 3.8.2, this section describes the items to be considered in the more detailed layout developed in the design phase.

Components of the UV reactors are typically located inside a building for protection from the weather and to provide a clean, convenient area for maintenance. The UV reactors themselves, associated electrical components and controls, and electrical support equipment should be enclosed. In some installations, UV reactors and control panels are uncovered. Before designing an uncovered facility, however, the state and UV manufacturer should be consulted. Exposed equipment and control panels should be rated for the anticipated environment, and appropriate site security should be in place to restrict public access.

The piping, valve, and flow meter design developed in the hydraulic evaluation (Section 4.1) should be considered in the UV facility configuration. For example, the length of straight-run piping before and after each flow meter to achieve the proper hydraulic conditions for accurate and repeatable flow rate measurement should be considered in the piping layout, depending on the flow control and measurement technique used (Section 4.1.2).

The location of the power and control panels associated with UV reactors should allow adequate space for panel doors to be opened without interference, and to allow unhindered access to the UV reactors when the doors are open. In selecting the location of the power and control panels, UV manufacturer cable length limitations should not be exceeded. The maximum allowable cable length is UV manufacturer-specific and may be less than 30 feet. If power

quality is a concern, room for power conditioning equipment should be provided. Such equipment may be located adjacent to the UV reactors or in a separate control room.

When allotting space for maintenance activities, adequate space to remove the lamps and the lamp wiper assembly should be provided. In some cases, access may be needed on both sides of the UV reactor. In addition, provisions should be included to collect and convey water that is discharged during maintenance activities.

Certain UV reactors need maintenance involving an OCC procedure in which a UV reactor is taken off-line, isolated, drained, filled with a cleaning solution, cleaned, flushed, and returned to service. The OCC equipment is typically self-contained and the cleaning chemical is recirculated. If applicable, sufficient space should be maintained around the UV reactors to provide access for the OCC procedure. Also, the OCC solution often has specific handling requirements. Appropriate drains, storage, and health and safety equipment (e.g., emergency eyewash station) should be provided as recommended by the chemical manufacturer.

Sample taps in the lateral pipe are recommended upstream and downstream of each UV reactor. The sample taps may be used for collecting water quality samples or during validation testing, if on-site validation is necessary. If on-site validation will be conducted, the number and location of sample and feed ports should be coordinated with the UV manufacturer or third-party oversight entity to comply with the recommendations of the selected validation protocol. Additional details on the locations of sample taps and other validation-related appurtenances are provided in Section 5.4.

Drain valves or plugs should be located on each lateral between the two isolation valves. In many cases, the UV manufacturer may have already incorporated a drain into the UV reactor design. Drain valves should also be provided at one or more low points in the UV facility to enable the UV reactor and entire lateral to be fully drained for maintenance activities. These drains should be large enough to drain the reactor and adjacent piping in a reasonable amount of time.

Additionally, the UVT analyzer installation (if necessary) should be considered in the layout. The specific size and operating characteristics of the UVT analyzer will vary depending on the UV manufacturer. If an on-line UVT analyzer is included in the design, adequate space and access to an electrical supply for monitor installation should be provided and appropriate sample taps and drains for withdrawing and discharging sample water should be included in the design. The sample line should be equipped with a valve to isolate the UVT analyzer. A sample pump (e.g., peristaltic) should be installed if insufficient pressure is available in the system. The UVT analyzer should be in a location that minimizes the likelihood of air bubbles (which can cause erroneous readings) passing through the monitor.

4.5.1 Additional Considerations for Unfiltered and Uncovered Reservoir UV Facility Layouts

Site issues that should be considered with unfiltered systems are generally consistent with those for filtered surface water systems. The most significant difference is the increased opportunity for debris to be present in the inflow to UV reactors in unfiltered applications. To

address the increased potential for debris, UV facility designs for unfiltered applications should incorporate features that prevent potentially damaging objects from entering the UV reactor. The optimal approach is site-specific. Such features could include screens, baffles, or low-velocity collection areas. Another option is to install the UV reactors vertically with the inlet closest to the ground, following a low-velocity zone. This arrangement will decrease the momentum of larger debris and reduce the risk of lamp breakage. The effects of lamp breakage and methods for minimizing it are discussed in Appendix E.

4.5.2 Additional Considerations for Groundwater UV Facility Layouts

Site issues that should be considered with groundwater systems are generally consistent with those for post-filtration surface water systems; the most significant difference is access of the site and potential sand particles affecting the UV reactor. Because well sites can be located in remote areas and may be more accessible to the general public or unauthorized individuals, the UV reactor should be installed within a building to protect sensitive equipment. The need to enclose the UV facility will ultimately be based on the manufacturer's recommendations, local regulatory and code requirements, state requirements, environmental conditions, and site-specific constraints. Site security should be appropriate to prevent tampering with the equipment and water supply and to protect people from injury (e.g., electrocution).

In addition, sand or debris flowing through the UV reactor may scratch the lamp sleeves or cause the sleeve wiping mechanisms to jam. Larger sand and debris could break the lamp sleeves and lamps. (See Appendix E for lamp breakage issues.) Intermittently used wells may accumulate sand or other particles; this initial concentration of particles should be discharged before operation and should bypass the UV reactor to avoid scratching the quartz sleeves. A sand/debris trap or other removal equipment prior to UV disinfection may be necessary if evidence suggests that the well pump will pull any sand or particles through the screen during normal well operation.

4.6 Elements of UV Equipment Specifications

When procuring the UV reactors, the UV facility layout and UV reactor specification are typically provided to the UV manufacturer. This section describes the potential elements included in a UV reactor specification and outlines the information that could be requested from the UV manufacturer.

4.6.1 UV Equipment Specification Components

Table 4.3 summarizes the factors that should be considered when developing equipment specifications for the UV equipment. The information included in Table 4.3 is not exhaustive and should be modified to meet the specific needs of the PWS and the requirements for the UV facility.

**Table 4.3. Possible Content for UV Equipment Specifications
(Table Spans Pages 4-20 – 4-22)**

Item	Specification Content
Flow rate	Maximum, minimum, and average flow rates should be clearly identified. The maximum flow rate must be within the validated range documented in the validation report [40 CFR 141.720 (d)(3)]. The minimum flow rate may be important to avoid overheating with MP reactors. One method for determining the maximum flow rate is described in Section 3.4.3.
Target Pathogen(s) and Log Inactivation	The log inactivation for the target pathogen(s)
Required UV Dose	The required UV dose for the target microorganism and log inactivation that must be verified by the validation process. Additional detail is provided in Chapter 5.
Water Quality and Environment	<p>The following water quality criteria should be included:</p> <ul style="list-style-type: none"> - Influent temperature - Turbidity - UV transmittance at 254 nm - UVT scan from 200 – 300 nm (MP reactors only) - Total hardness - pH - Iron - Calcium - Manganese - ORP <p>For some parameters, a design range may be most appropriate.</p>
Operating Flow and UVT Matrix	Appropriate matrix of paired flow and UVT values based on flow and UVT data (Section 3.4.4.1).
Operating Pressure	The expected operating pressures, including the maximum and minimum operating pressure to be withstood by the lamp sleeves and UV reactor housing.
UV Sensors	<p>A germicidal spectral response should be specified (Section 5.4.8). A minimum of one UV sensor should be specified per UV reactor. The actual number should be identical to the UV reactor that was, or will be, validated.</p> <p>The uncertainty of the UV sensors used during validation should meet the criteria described in Section 5.5.4.</p> <p>The uncertainty of the duty UV sensors during operation should meet the criteria described in Section 6.4.1.1.</p> <p>Reference UV sensors should be calibrated against a traceable standard. For example, the following standards are currently being used by UV manufacturers:</p> <ul style="list-style-type: none"> - National Physical Laboratory (NPL) - National Institute of Standards and Technology (NIST) - Deutsche Vereinigung des Gas- und Wasserfaches (DVGW) - Österreichisches Normungsinstitut (ONORM)
Redundancy	The reactor redundancy determined in Section 3.8.1.
Hydraulics	<p>The following hydraulic information should be specified:</p> <ul style="list-style-type: none"> - Maximum system pressure at the UV reactor - Maximum allowable head loss through the UV reactor - Special surge conditions that may be experienced - Hydraulic constraints based on site-specific conditions and validated conditions (e.g., upstream and downstream straight pipe lengths).

**Table 4.3. Possible Content for UV Equipment Specifications
(Table Spans Pages 4-20 – 4-22)**

Item	Specification Content
Size/Location Constraints	Any size constraints or restrictions on the location of the UV reactor or control panels (e.g., space constraints with individual filter effluent installation).
Validation	The range of operating conditions (e.g., flow, UVT) that must be included in the validation testing, and submittal of a validation report (40 CFR 141.720) should be required. The validation testing should be completed in accordance to the procedures and data analysis described in detail in Chapter 5.
Dose-Monitoring Strategy	A description of the preferred dose-monitoring strategy for the UV reactors.
Operating Approach	A description of the intended operating approach for the UV reactors, as described in Section 4.2.
Economic and Non-Economic Factors	The necessary information to thoroughly evaluate the UV equipment based on the PWS's specific goals. As appropriate, this information may include both economic (e.g., energy use, chemical use) and non-economic (e.g., future expansion, manufacturer experience) factors.
Lamp Sleeves	Lamp sleeves should be annealed to minimize internal stress.
Safeguards	<p>At a minimum, the following UV reactor alarms should be specified:</p> <ul style="list-style-type: none"> - Lamp or ballast failure - Low UV intensity or low validated UV dose (depending on dose-monitoring strategy used) - High temperature - Operating conditions outside of validated range - Wiper failure (as applicable) - Other alarms discussed in Section 4.3.3, as appropriate.
Instrumentation and Control	<p>At a minimum the following signals and indications should be specified:</p> <ul style="list-style-type: none"> - UV lamp status - UV reactor status - UV intensity - Lamp cleaning cycle and history - Accumulated run time for individual lamps or banks of lamps - Influent flow rate. <p>At a minimum the following UV reactor controls (as applicable) should be specified:</p> <ul style="list-style-type: none"> - UV dose setpoints, UV intensity setpoints, or UVT setpoints (depending on dose-monitoring strategy used) - UV lamps on/off - UV reactor on/off control - UV reactor manual/auto control - UV reactor local/remote control - Manual lamp power level control - Manual lamp cleaning cycle control - Automatic lamp cleaning cycle setpoint control.

**Table 4.3. Possible Content for UV Equipment Specifications
(Table Spans Pages 4-20 – 4-22)**

Item	Specification Content
Performance Guarantee	<p>The equipment provided should meet the performance requirements stated in the specification for an identified period or during on-site performance testing (Section 6.1.5). The following specific performance criteria may be included:</p> <ul style="list-style-type: none"> - Allowable head loss at each design flow rate - Estimated power consumption under the design operating conditions - Disinfection capacity of each reactor under the design water quality conditions - Sensitivity of equipment to variations in voltage or current - Reference UV sensor, duty UV sensor, and UVT analyzer (if provided) performance compared to specification
Warranties	<p>A physical equipment guarantee and UV lamp guarantee should be specified. The specific requirements of these guarantees will be at the discretion of the PWS and engineer. Significant variation from common commercial standards should be discussed with the manufacturer. Lamps should be warranted to provide the lamp intensity under the design conditions for the fouling/aging factor and a minimum number of operating hours. To limit the UV manufacturer's liability, the guarantee could be prorated after a specified number of operating hours.</p>
UVT Analyzer	<p>During operation, the difference between the UVT analyzer measurement and the UVT measured by a calibrated spectrophotometer should be less than or equal to 2 % UVT.</p>

4.6.2 Information Provided by Manufacturer in UV Reactor Bid

The UV manufacturers should provide adequate information when bidding to enable the designer to conduct a proper, timely review of the proposed equipment. Suggested information to be obtained from the UV manufacturer is presented in Table 4.4.

Table 4.4. Suggested Information to Be Provided by UV Manufacturer

Item	Description of Information
Design Parameters	<p>Demonstration of an understanding of the design parameters for the UV equipment. All UV equipment design parameters from the contract documents should be repeated in the proposed UV equipment submittal information.</p>
Summary of Design	<p>A summary of the equipment proposed (number of UV reactors, lamp type) and specified equipment redundancies.</p>
Reactor Technical Specifications	<p>Ability of proposed UV reactors to meet technical specifications and an explanation of any exceptions taken.</p>
UV Equipment Documentation and Specifications	<p>Documentation that identifies and describes the UV equipment components that were validated, as described in Section 5.11.1.¹</p>
UV Manufacturer's Experience	<p>Information on project experience, including previous facilities and references.</p>
UV Lamps	<p>Detailed description of the lamp dimensions and electrical requirements.</p>

Table 4.4. Suggested Information to Be Provided by UV Manufacturer

Item	Description of Information
UV Sensor	<p>Information on the UV sensor(s), including spectral response, acceptance angle, external dimensions, working range in mW/cm², measurement uncertainty, environmental requirements, linearity, and temperature stability.</p> <p>Data and calculations should be provided showing how the total measurement uncertainty of the UV sensor used during validation meets the criteria established in Section 5.5.4.</p> <p>Data that demonstrate duty UV sensors will meet the criteria described in Section 6.4.1.1 will be met during operation.</p>
Lamp Sleeves	Calculations showing the maximum allowable pressure for the lamp sleeves and the maximum bending stress the lamp sleeves may experience under the maximum specified flow rate conditions.
UVT Analyzer (if applicable)	Data that prove the UVT analyzer used during validation meets the criterion in Section 6.4.1.2 during operation.
Validation Report	UV reactor validation should be provided that includes the elements described in Section 5.11.3. If on-site validation is proposed, validation data for the UV reactors from off-site validation (if completed) should be included to provide a baseline comparison to the proposed conditions.
Upstream and Downstream Hydraulic Requirements	A statement of the length of straight pipe and hydraulic conditions necessary upstream and downstream from the UV reactor to ensure the desired flow profile is maintained and the design conditions are met. If pre-validated equipment is specified, a description of the hydraulic configuration used during validation testing should be provided.
Power Requirements	The power needs of each UV reactor and which elements, including electrical cable and wiring, are included as part of the equipment.
Power Quality Tolerance	The power quality tolerance of the UV equipment for voltage sags, surges, and interruptions.
Cleaning Strategy	The strategy that will be used for cleaning the UV lamps in the UV reactor.
Dose-monitoring Strategy	The proposed UV reactor dose-monitoring strategy, including manual and automatic control schemes and a listing of inputs, outputs, and the types of signals that are available for remote monitoring and control.
Reactor Data	The materials of construction, dimensions of the UV reactors and ancillary equipment, a list of spare parts, and a sample operations and maintenance manual.
Safeguards	The safeguards built into the UV reactor and accompanying equipment, such as high temperature protection, wiper failure alarms, and lamp failure alarms.
Warranties	A statement of the proposed UV reactor guarantees, including the physical equipment, UV lamps, lamp sleeves, fouling/aging factor, and the system performance guarantee. Any exceptions should be indicated and explained.

¹ Key elements of this documentation are also listed in this table.

4.7 Final UV Facility Design

The UV reactors can be selected after all bids have been carefully reviewed. Once the UV reactors are selected, the designer can coordinate with the selected UV manufacturer to develop the final facility design based on the selected UV equipment. The hydraulic design, I&C design, electrical design, and facility layout should be modified based on the selected UV equipment.

Particular emphasis should be given to the integration of the overall dose-monitoring strategy with the alarms, signals, and interlocks that are integral to the UV reactor design. That the final design be coordinated with the validation testing results is critical. The validation results must be sufficient to implement the proposed operations approach and should meet the water supply's disinfection objectives under the specified operating conditions.

4.8 Reporting to the State during Design

Interaction with the state throughout the design phases is recommended and increases the likelihood that the objectives of both the PWS and the state are met. Currently many states have limited experience in the use of this technology; therefore, the appropriate level of state involvement during design should be greater than that for more traditional designs. Early agreement on the specific objectives and requirements of the project can significantly reduce the potential for conflict or costly design changes later in the project. The level of state involvement during design, as well as the specific submittal requirements, will vary by state and may vary by project. PWSs are urged to consult with their state early in their UV disinfection design process to understand what approvals and documentation will be required.

5. Validation of UV Reactors

The purpose of validation testing is to determine the operating conditions under which a UV reactor delivers the validated dose.¹ As noted elsewhere in this guidance document, the validated dose must be greater than or equal to the required dose (presented in Table 1.4) to receive log inactivation credit for a target pathogen. Validation testing also establishes the operational setpoints used during reactor operations to confirm delivery of the validated dose.

This chapter explains the key steps in EPA's recommended validation protocol for UV reactors. It includes recommendations for selecting test conditions, quality assurance/quality control (QA/QC) steps, and data analysis procedures. It provides the rationale for the recommended steps and cites relevant research studies where appropriate.

Chapter 5 covers:

- 5.1 Minimum Requirements for Validation Testing
- 5.2 Overview of the Recommended Validation Protocol
- 5.3 Selecting the Challenge Microorganism
- 5.4 Equipment Needs for Full-scale Reactor Testing
- 5.5 Accuracy of Measurement Equipment
- 5.6 Identifying Test Conditions
- 5.7 Guidelines for Conducting Experimental Tests
- 5.8 Analyzing Experimental Data
- 5.9 Deriving the Validation Factor (VF)
- 5.10 Determining the Validated Dose and Validated Operating Conditions
- 5.11 Documentation
- 5.12 Guidelines for Reviewing Validation Reports
- 5.13 Evaluating the Need for "Re-validation"

Several appendices support this chapter:

- **Appendix A** provides recommendations for preparing stock solutions of and assaying challenge microorganisms.
- **Appendix B** presents validation testing examples for two hypothetical water systems.
- **Appendix C** provides the recommended procedure for conducting collimated beam tests, including test conditions, apparatus design, equipment accuracy, and QA/QC. Appendix C also provides guidelines for using collimated beam test data to develop a UV dose-response curve.

¹ For the purposes of this guidance manual, the validated dose is defined as the UV dose in units of millijoule per centimeter squared (mJ/cm²) delivered by the UV reactor as determined through validation testing. The required dose is defined as the UV dose needed to achieve log inactivation credit. All UV dose terms are included in the glossary at the beginning of this manual.

- **Appendix D** contains the background theory used to support the recommended validation protocol.

The material in this chapter is intended to help water systems and states understand how the validation testing process works. It should be considered as a resource when reviewing validation reports or overseeing validation testing activities. Some of the terms and acronyms used in this chapter are unique to UV reactor validation. EPA has included an extensive glossary and acronyms list at the beginning of this guidance manual to help the reader keep track of new terms.

5.1 Minimum Requirements for Validation Testing

Unlike chemical disinfection, UV light leaves no residual that can be monitored to determine the delivered dose. UV sensors can measure intensity of UV light, but they cannot measure the dose delivered to the microorganisms as they pass through the reactor at different trajectories. Therefore, to receive treatment credit for inactivating *Cryptosporidium*, *Giardia*, or viruses using UV light, the LT2ESWTR requires water systems to use UV reactors that have undergone validation testing.

Section 1.4 of this manual summarizes all LT2ESWTR requirements related to UV disinfection, including minimum dose, validation, monitoring, and reporting requirements. For easy reference Table 5.1 summarizes the regulatory requirements for validation.

Table 5.1. Summary of LT2ESWTR Validation Requirements

Requirement	Conditions	Citation
<i>Validated operating conditions must include</i>	<ul style="list-style-type: none"> • Flow rate • UV intensity as measured by a UV sensor • UV lamp status 	40 CFR 141.720 (d)(2)
<i>Validation testing must include</i> ¹	<ul style="list-style-type: none"> • Full-scale testing of a reactor that conforms uniformly to the UV reactors used by the water system • Inactivation of a test microorganism whose dose-response characteristics have been quantified with a low-pressure mercury vapor lamp 	40 CFR 141.720 (d)(2)(ii)
<i>Validation testing must account for</i>	<ul style="list-style-type: none"> • UV absorbance of the water • Lamp fouling and aging • Measurement uncertainty of on-line sensors • UV dose distributions arising from the velocity profiles through the reactor • Failure of UV lamps or other critical components • Inlet and outlet piping or channel configurations of the UV reactor 	40 CFR 141.720 (d)(2)(i)

¹ The state may approve an alternative approach to validation testing.

The LT2ESWTR does not specifically address “re-validation” if the design of a validated UV reactor changes. If design modifications significantly impact UV dose delivery or monitoring, however, the UV reactor should be considered a different reactor (with unsubstantiated performance) than the one previously validated and as such, must be re-validated [40 CFR 141.720 (d)(2)]. Section 5.13 discusses some of the common types of UV reactor modifications and provides recommendations for which types of changes necessitate re-validation.

5.2 Overview of the Recommended Validation Protocol

EPA’s recommended validation protocol uses *biodosimetry*. Under this approach, the log inactivation of a challenge microorganism is measured during full-scale reactor testing for specific operating conditions of flow rate, UV transmittance (UVT),² and UV intensity. The dose-response equation for the challenge microorganism (relating UV dose to log inactivation) is determined using independent, bench-scale testing. Log-inactivation values from full-scale testing are input into the laboratory derived-UV dose-response relationship to estimate the Reduction Equivalent Dose (RED). The RED value is adjusted for uncertainties and biases to produce the validated dose of the reactor for the specific operating conditions tested. The validated dose is compared to the required dose for compliance purposes.

The protocol can be described in three main steps, as shown in Figure 5.1 and described in more detail in Section 5.2.1. Alternative approaches to validation are discussed in Section 5.2.2. Sections 5.2.3 and 5.2.4 present recommendations for third-party oversight and emerging validation approaches, respectively.

5.2.1 Key Steps in Recommended Validation Protocol

Consistent with other recommendations in this guidance manual, EPA developed the validation protocol working closely with industry representatives and experts in the field of UV disinfection. EPA believes that the approach produces reliable results and can be used to meet microbial treatment requirements of the LT2ESWTR and encourages water systems to use it where applicable. Water systems are not required, however, to follow the protocol as long as they meet the minimum regulatory requirements summarized in Section 5.1. EPA recommends that water systems contact their states early to discuss any additional state-specific requirements for reactor validation.

² In this Chapter, UVT implies UVT measurement specifically at 254 nanometers (nm) and 1 centimeter (cm) pathlength unless otherwise noted. UV absorbance at 254 nm (A_{254}) can be related to UVT using the following equation:

$$A_{254} = -\log\left(\frac{UVT(\%)}{100}\right)$$

Figure 5.1. Overview of Recommended Validation Protocol

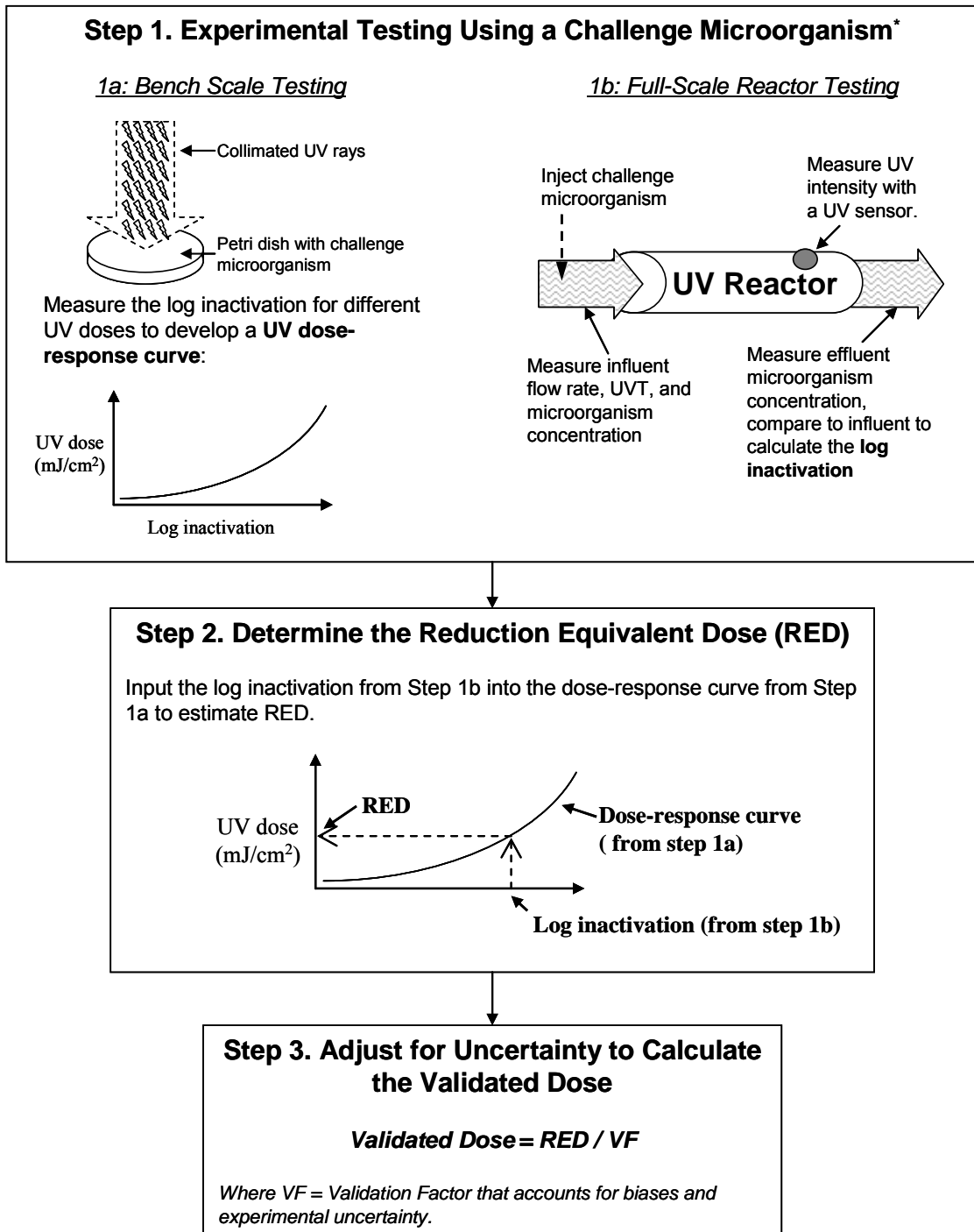

* Simple representations of testing equipment shown. For more details, see Figures C.1 and 5.2.

Step 1: Conduct Experimental Tests Using a Challenge Microorganism

Because handling of the target pathogen during validation testing is neither practical nor in the best interest of public health³, a ***challenge microorganism*** whose sensitivity to UV light is similar to the target pathogen should be used in all experiments. Using a challenge microorganism instead of the target pathogen, however, introduces uncertainty into the testing results. This uncertainty is accounted for by applying a validation factor (see Step 3).

UV reactor validation includes two types of experimental tests, as described below. Importantly, the same stock solution of challenge microorganisms should be used for both tests because UV sensitivity for stock solutions can vary.

1a. Bench-scale testing using a collimated beam apparatus. Collimated beam testing characterizes the UV dose-response relationship of the challenge microorganism. In these experiments, UV light is directed down a collimating tube to dose a sample of challenge microorganisms of a known concentration. After a specified exposure time, the sample is analyzed to determine the log inactivation (where log inactivation in this situation equals the log concentration prior to UV light exposure minus the log concentration after UV light exposure) as a function of UV dose. The UV dose delivered to the microorganisms is calculated based on the UV intensity, exposure time, and other experimental factors. Figure C.1 in Appendix C illustrates a typical collimated beam apparatus.

Collimated beam tests are performed at a range of doses to generate a ***UV dose-response curve*** for the specific challenge microorganism. The functional forms of the equations for UV dose-response curves can vary depending on the results (guidance on developing UV dose-response curves is provided in Section C.3). A quadratic UV dose-response equation is provided below.

$$UV\ Dose = A \times (\log\ inactivation) + B \times (\log\ inactivation)^2 \quad \text{Equation 5.1}$$

For this equation type, the coefficients “A” and “B” would be solved for using the collimated beam testing data.

1b. Full-scale reactor testing. In these experiments, the challenge microorganisms are injected upstream of the UV reactor. Samples are analyzed to determine the ***log inactivation*** (where log inactivation in this situation equals log influent concentration minus log effluent concentration) at the test conditions of flow rate, UVT, lamp status, and UV intensity as measured by UV sensors. Full-scale reactor testing can be performed on-site at a water treatment plant or off-site at a validation test center (see Figure 5.2 in Section 5.4 for a diagram of a typical biodosimetry test stand used for off-site validation).

³ Culturing pathogenic microorganisms introduces additional risks in terms of handling, disposal, and cross connections. Therefore, the industry regularly uses challenge microorganisms as surrogates for pathogenic target microorganisms.

Step 2: Estimate the Reduction Equivalent Dose

Step 2 combines results from the two experimental tests in Step 1. The log inactivation of the challenge microorganism measured during the full-scale testing is entered into the UV dose-response equation (Equation 5.1 if the relationship is quadratic) to calculate the **RED** of the reactor. Another way to conceptualize this step is to consider the RED to be “back-calculated” using the field-measured log inactivation as the input variable. This approach is the opposite of most applications in which UV dose is the independent variable and log inactivation is the dependent variable.

RED values are always specific to the following:

- The challenge microorganism used during experimental testing,
- Validation test conditions during full-scale reactor tests (flow rate, UVT, lamp status, and UV intensity as measured by the UV sensor)

Step 3: Adjust for Uncertainty to Calculate the Validated Dose

In the last step shown in Figure 5.1, the RED is divided by a **Validation Factor (VF)** to produce the Validated Dose. The VF accounts for biases associated with using a challenge microorganism instead of the target pathogen and for experimental uncertainty (Section 5.9 provides a detailed description of how the VF is derived). The Validated Dose is associated with the validation test conditions of flow rate, lamp status, UV intensity as measured by a UV sensor, and in some cases, UVT. As noted previously, the validated dose is compared to the required dose to determine the inactivation credit for the target pathogen.

5.2.2 Alternative Validation Protocols

The Austrian Standards *ÖNORM M 5873-1* and *M 5873-2* (2001 and 2003, respectively) and the German Guideline DVGW W294 (2006) define measured flow rate, UV intensity, and lamp status for a *Bacillus subtilis* RED of 40 mJ/cm². Based on the recommended validation protocol presented in this guidance manual, UV reactors certified by ÖNORM and DVGW for a *B. subtilis* RED of 40 mJ/cm² should be granted 3-log *Cryptosporidium* and 3-log *Giardia* inactivation credit. Validation by *NWRI/AwwaRF Guidelines* and *NSF Standard 55* should be evaluated on a case-by-case basis (NWRI 2003, NSF 2004).

5.2.3 Third Party Oversight

EPA recommends that an independent third party provide oversight to ensure that validation testing and data analyses are conducted in a technically sound manner and without bias. A person independent of the UV reactor manufacturer should oversee validation testing. Individuals qualified for such oversight include engineers experienced in testing and evaluating UV reactors and scientists experienced in the microbial aspects of biosimetry. Appropriate individuals should have no real or apparent conflicts of interest regarding the ultimate use of the UV reactor being tested.

At a minimum, independent oversight should include observing validation testing to verify that the individuals performing the validation follow the documented protocol and reviewing the report for accurate data and results. The independent third party should review the validation report before its release. When appropriate, the third party should rely on additional outside experts to review various aspects of UV validation testing, such as lamp physics, optics, hydraulics, microbiology, and electronics.

5.2.4 Emerging Methods

In recent years, researchers have been working on alternative approaches to biodosimetry for UV reactor validation. Potential model-based approaches use computational fluid dynamics (CFD) to predict microorganism trajectories through a UV reactor, and hence the UV dose delivered to each microorganism. Section D.6 in Appendix D describes certain aspects of using CFD to predict UV dose delivery. A possible approach for verifying and validating hydraulic CFD models is outlined in the AIAA CFD guide (1998). Another emerging experimental approach uses microspheres that undergo a chemical reaction when exposed to UV light (Blatchley et al. 2005). The microspheres are injected upstream of the UV reactor and are collected downstream. The extent of the UV light-induced chemical reaction within each sphere is measured and used to calculate the UV dose delivered to that sphere as it traveled through the reactor.

Although model and experimental-based approaches clearly have potential for use in validating UV reactors, they are still subjects of current research. EPA anticipates that these methods will continue to develop and improve in the future.

5.3 Selecting the Challenge Microorganism

For the reasons stated in Section 5.2.1, the disinfection performance of the UV reactor is measured using a non-pathogenic “challenge” microorganism. Ideally, the challenge microorganism should have the same sensitivity to UV light (i.e., the same microbial dose-response) as the target pathogen.⁴ If medium-pressure (MP) lamps are used, the organism should display a similar action spectrum, which is the relative sensitivity of the organism at other wavelengths compared to its sensitivity at 254 nm. In addition, the challenge microorganism should be:

- Easily cultured and enumerated, with repeatable results,
- Culturable to high concentrations, and
- Stable over long periods of time (to allow for shipment to and from the laboratory, on-site use, and enumeration without loss of viability or change in UV dose-response).

⁴ In this guidance document, the UV sensitivity of the target microorganisms *Cryptosporidium*, *Giardia*, and viruses is defined by the required UV doses as presented in Table 1.4.

- If the challenge microorganism is a phage, the host bacteria used to assay the phage concentration should not be pathogenic to humans.

Male-specific-2 bacteriophage (MS2) phage and *B. subtilis* spores historically have been used for validation testing to receive treatment credit for *Cryptosporidium* and *Giardia*. Because their UV resistance is notably greater than that of *Cryptosporidium* and *Giardia*, other, more sensitive microorganisms such as T1 and T7 phage are gaining favor (Mackey et al. 2006).

To demonstrate 3- or 4-log inactivation for viruses, validation testing would need to demonstrate greater than 6-log inactivation of MS2 phage and *B. subtilis* spores. Such a demonstration requires an extremely high concentration in the reactor influent to allow for enumeration of the organisms in the effluent samples. Because of the need for serial dilutions, these high concentrations are difficult to measure and can introduce error into the experiment. Research to find an alternative challenge microorganism for demonstrating virus inactivation is ongoing.

Other challenge microorganisms that have been used for validation testing include non-pathogenic *Escherichia coli*, *Saccharomyces cerevisiae*, and Q β phage. Table 5.2 summarizes the UV sensitivity of some commonly used and some candidate bioassay microorganisms.

Table 5.2. UV Sensitivity of Challenge Microorganisms

Microorganism	Reported Delivered UV Dose (mJ/cm ²) to Achieve Indicated Log Inactivation				Reference
	1-log	2-log	3-log	4-log	
<i>Bacillus subtilis</i>	28	39	50	62	Sommer et al. 1998
MS2 phage	16	34	52	71	Wilson et al. 1992
Q β phage	10.9	22.5	34.6	47.6	Mackey et al. 2006
PRD-1 phage	9.9	17	24	30	Meng and Gerba 1996
B40-8 phage	12	18	23	28	Sommer et al. 1998
ϕ x174 phage	2.2	5.3	7.3	11	Sommer et al. 1998
<i>E. coli</i>	3.0	4.8	6.7	8.4	Chang et al. 1985
T7	3.6	7.5	11.8	16.6	Mackey et al. 2006
T1	~5	~10	~15	~20	Wright 2006

Some microorganisms, such as *B. subtilis*, exhibit shoulders or tailing in their UV dose-response, meaning that the shape of the UV dose-response curve is flat at either low or high doses. Shoulders and tailing limit the range of UV doses that can be used to validate the reactor. See Section C.6 in Appendix C for an example of shoulders and tailing and limitations of using challenge microorganisms exhibiting this response in developing the UV dose-response curve.

As noted in Section 5.2.1, the validation test results are adjusted by a VF to account for bias and experimental uncertainties. A portion of the VF accounts for the difference in microbial response between the challenge microorganism and target pathogen. Using a challenge organism with significantly higher UV resistance than the pathogen of interest (e.g., using MS2 to earn *Cryptosporidium* inactivation credit) may result in a high VF. To provide a better estimate of the UV dose that a UV reactor can deliver to a target pathogen, a challenge microorganism with similar UV sensitivity to the target pathogen can be used. Alternatively, two challenge

microorganisms whose UV sensitivities bracket that of the target pathogen (i.e., one challenge microorganism is less resistant and the other is more resistant than the target pathogen) can be selected. One advantage to this second approach is that the factor used to account for the difference between the microbial response of the challenge microorganism and target pathogen can be set to 1.0 (see Section 5.9 for discussion of the RED bias factor).

If the UV reactor being validated uses MP lamps and a challenge microorganism other than MS2 Phage or *B. subtilis*, a correction factor should be applied to the test results to account for differences in action spectra between the challenge microorganism and the target pathogen. Section D.4.1 explains how the correction factor is derived and how it should be applied to validation testing results.

5.4 Equipment Needs for Full-scale Reactor Testing

As noted in Section 3.6, full-scale reactor validation can occur on-site at the water treatment plant or off-site at a third-party validation test center or a UV manufacturer's facility. If full-scale reactor testing is performed off-site, tests are often conducted using a ***Biodosimetry Test Stand*** as shown in Figure 5.2. Regardless of the testing location, testing equipment should include (1) injection pumps and ports to introduce the challenge microorganism, the UV-absorbing compound, and, if needed, a disinfectant residual quenching agent into the feed water, (2) rate-of-flow control and a flow meter either upstream or downstream of the reactor, and (3) a strategy to ensure that the water is well mixed before sampling (e.g., static mixers or appropriate number of pipe lengths with good mixing confirmed, see Section 5.4.3 for details). There should also be a state-approved plan for wastewater disposal with any associated required permits.

The next several sections provide detailed recommendations regarding water source, the UV-absorbing chemical to be used to simulate reduced UVT, mixing, sampling ports, configuration of inlet/outlet piping, accounting for non-uniform lamp aging, lamp positioning, UV sensors, and UV sensor port windows.

5.4.1 Water Source

When validation testing is conducted off-site, the source water for experiments is usually a potable water supply with a high UVT. To protect the potable water source, backflow prevention should be provided.

The water passing through the reactor should not contain disinfectant residuals that inactivate the challenge microorganism during testing. If this is a concern, a quenching agent can be injected into the water upstream of the microorganism injection port. When validating UV reactors using MP lamps, the quenching agent should have a minimal impact on the spectral UVT from 200 to 400 nm. Some common quenching agents like sodium thiosulfate can have a significant impact on the UV absorbance spectra if added in high enough concentrations. Testers should use a quenching agent, such as sodium bisulfite, that does not influence UVT.

Figure 5.2. Block Diagram of a Typical Biodosimetry Test Stand for Full-scale Reactor Testing

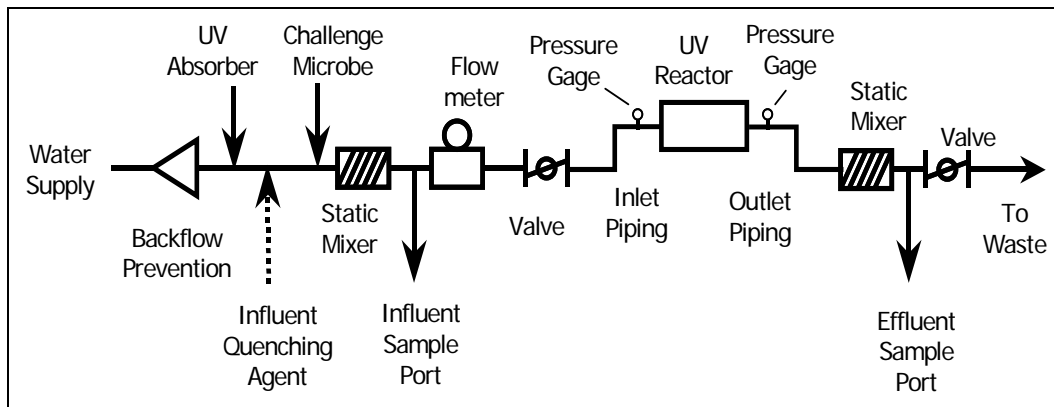

5.4.2 UV Absorbing Chemical

Typically during validation, a UV-absorbing chemical is injected into the flow to produce UVT values that span the required range. Common UV-absorbing compounds include the following:

- Coffee,
- Lignin sulfonic acid (LSA), and
- Humic acids, such as those derived from leonardite shales (Mackey et al. 2006, Bircher 2004).

5.4.3 Mixing

Additives passing through the reactor (e.g., UV-absorbing compound, the challenge microorganism) should be well mixed through the cross-section of the influent pipe prior to the reactor influent sampling port. The challenge microorganisms surviving UV disinfection should be well mixed through the effluent pipe cross-section prior to the reactor effluent sampling port.

Additives to the influent and effluent can be mixed by either using appropriately sized and designed static mixers or relying on the turbulent mixing in the lengths of pipe upstream of the sampling ports. If the water passing through the UV reactor is obtained from a large tank, the additives can be premixed in the tank to obtain a uniform concentration for testing. If pumps are used to inject the additives, the mechanism should provide a pulse-free flow rate or have a cycle time (i.e., time between pulses) an order of magnitude less than the residence time of the reactor. The flow rate generated by the pump should be stable over the time required to take samples.

Adequate mixing at the influent sampling port can be confirmed by comparing the UV absorbance at 254 nm (A_{254}) of water samples collected from various locations across the pipe cross-section. Samples can be collected across a pipe section using a perforated stab tube. The

standard deviation of the A_{254} values measured at different locations should be less than 5 percent of the mean A_{254} value. Another approach is to compare the A_{254} of water samples collected at the influent and effluent sampling ports. The average A_{254} values of the influent and effluent samples should agree within 5 percent and the standard deviation of each should be less than 5 percent of their respective means.

The mixing at the effluent sampling port can be confirmed by injecting a UV-absorbing chemical into the flow at a location immediately downstream of the UV reactor and comparing the A_{254} of water samples collected from various locations across the pipe cross-section. Alternatively, the A_{254} of water samples collected at the effluent sampling port and a second effluent sampling port located five pipe diameters or more downstream of the first can be compared. The water samples should meet the criteria given above for the influent samples.

Mixing tests should be done at the minimum and maximum flow rates with the UVT adjusted to the minimum value that will be used during testing. If the water samples collected during the tests do not meet the above criteria for good mixing, the mixing should be increased and retested.

5.4.4 Sampling Ports

The sampling points for microorganisms should be located far enough from the UV reactor that the germicidal UV intensity at the point of sampling is < 0.1 percent of the germicidal intensity within the UV reactor. If the outlet sample port is located downstream of a 90° bend (or the inlet sample port is upstream of a 90° bend), incident light is not a concern.

To estimate intensity at a certain distance from the reactor, the following equation can be used:

$$I(r) = \frac{P_L}{2\pi r} e^{-\alpha_e r} \quad \text{Equation 5.2}$$

where:

- P_L = UV power emitted per unit arc length of the line source (mW/cm)
- r = Radial distance from the line source (cm)
- α_e = Napierian (base e) absorption coefficient of the media for water, ($\sim 0.015 \text{ cm}^{-1}$)
- $I(r)$ = UV intensity (mW/cm^2) at a distance r from the line source

For example, suppose the outlet sample port at a hypothetical UV test facility is located 10 feet downstream of the last UV lamp in a reactor. The lamp's maximum power per unit arc length is 100 watts per centimeter (W/cm). Using Equation 5.2, the intensity at a radial distance of 10 feet (305 cm) is calculated to be $5.4 \times 10^{-4} \text{ mW}/\text{cm}^2$. Because this intensity is less than 0.1 percent of the intensity within the reactor, the sample port location is acceptable.

Sample taps may draw water from a single point or simultaneously from multiple points across the pipe diameter. Samples taken from multiple points within the flow should have the same concentration of additives and microorganisms (within the measurement error of the analytical method). If samples from different points in the flow have different concentrations, the

flow at the sampling point is either insufficiently mixed or not at steady state. Sampling from multiple points at the same time should not be used to compensate for poor mixing.

5.4.5 Configuration of Inlet and Outlet Piping

Appendix D describes how flow conditions of the water can significantly impact dose delivery inside a UV reactor. Flow conditions are dependent on the velocity of the water and configuration of inlet and outlet piping. If the reactor is validated off-site, the inlet and outlet piping at the water treatment plant should result in a UV dose that is ***the same or greater than*** the dose delivered at the validation test facility. Section 3.6 provides suggestions for inlet and outlet piping design for water treatment plants and validation testing facilities.

Computational fluid dynamics (CFD) is a tool that can be used to assess whether the dose delivery at the treatment plant is the same or greater than the dose delivery at the validation testing facility. Section D.6 in Appendix D provides guidelines on using CFD for the purposes of modeling UV dose delivery.

5.4.6 Accounting for Non-uniform Lamp Aging

As will be discussed in Section 5.6, validation testing of full-scale reactors should account for decreased UV light transmittance caused by sleeve fouling, sleeve aging, lamp aging, and UV sensor window fouling. During design, the engineer and UV manufacturer will typically estimate a “fouling factor” and an “aging factor” for the reactor. The fouling factor is defined as the fraction of UV light passing through a fouled sleeve as compared to a new sleeve. The aging factor is the fraction of UV light emitted from aged lamps and sleeves at the end of the specified useful life compared to UV light emitted from new lamps and sleeves. The “fouling/aging factor” is equal to the fouling factor multiplied by the aging factor and typically ranges from 0.4 to 0.9 (NWRRI 2003). See Section 3.4.5 for a more detailed discussion on determining these factors.

Traditionally, lamp power is turned down to simulate aging and fouling during validation testing. The magnitude of the power reduction (or power turn-down) is determined by calculating the *relative sensor intensity*, which is defined as follows:

$$\text{Relative sensor intensity} = S/S_o \quad \text{Equation 5.3}$$

Where

- S_o = UV intensity measured at 100 percent lamp power
- S = UV intensity measured at reduced lamp power

For example, if the fouling/aging factor is 0.7, the lamp power would be reduced until the relative sensor intensity was 0.7, or 70 percent.

Recent studies have shown, however, that UV lamps and sleeves can exhibit significant non-uniform aging along their length and around their circumference (e.g., Mackey et al. 2005

and 2006). Turning down power during validation testing to simulate aging for lamps that experience non-uniform aging may result in under-dosing when the reactor is operated at the treatment plants, particularly at the end of useful lamp life. This guidance manual recommends that water systems use one of the following three alternatives to account for non-uniform lamp aging:

1. Request data from the manufacturer to verify that the lamps age uniformly. The manufacturer can provide such verification by simulating lamp aging in a test bed, then measuring lamp output at different locations along the length of the lamp and around the circumference. Results from a recently-completed AwwaRF study showed that output at the lamp ends is usually less than in the middle of the lamp when significant non-uniform aging is observed (Mackey et al. 2006). If the manufacturer can show that the lamp aging factor either already accounts for non-uniform aging or that it is not an issue, power turn-down can be used to simulate lamp aging during validation tests.
2. Use aged lamps (i.e., lamps that have been operated under similar conditions to the end of their specified lamp life) for validation testing. Power turn-down to simulate lamp aging during validation tests is not necessary in this approach (although power turn-down should still be considered to simulate lamp fouling).
3. Conduct experimental testing to determine if lamp aging can be simulated by power turn-down:
 - a. Prepare a stock solution of the challenge microorganism.
 - b. Fit the UV reactor with aged lamps and sleeves.
 - c. Pass water through the reactor at a constant UVT, flow rate, and lamp power that will be used during challenge testing.
 - d. Inject the challenge microorganism into the flow passing through the reactor (ensure they are well-mixed prior to entering the reactor).
 - e. Collect at least five (5) microbiological samples spaced one (1) minute apart from the influent and effluent sampling ports for analysis.
 - f. Record the UV sensor measurements.
 - g. Fit the UV reactor with new lamps that have undergone 100-hour burn-in and new sleeves.
 - h. Operate the UV reactor at the flow rate and UVT used in Step c. Lower the lamp power to produce a UV sensor reading equivalent to the reading obtained in Step f. Repeat steps e and f.

If the mean log inactivation achieved with aged lamps is similar to the log inactivation achieved with new lamps with reduced lamp power, power turn-down

can be used to simulate lamp aging. If results show significant differences, Alternative 2 (aged lamps and sleeves) should be used during validation testing.

5.4.7 Lamp Positioning to Address Lamp Variability

Due to manufacturing tolerances and differences in operation and aging, UV output typically varies from lamp to lamp. If a UV reactor has fewer UV sensors than lamps and the lamps are randomly distributed in the reactor, the UV sensors may monitor the lamps with the lowest outputs during validation. If this were to occur, the validation data collected would typically lead to under-dosing at the treatment plant.

To prevent underdosing, the lamps with the highest UV output should be placed closest to the UV sensors during validation testing. Other lamps should be randomly distributed in the lamp array throughout the reactor. This approach is unnecessary if the reactor uses one UV sensor per lamp.

The lamps with the highest UV output can be identified by measuring UV output using either a dedicated test stand or the UV reactor. One approach for determining the UV lamp output using the UV reactor is described below.

Procedure

1. Install a lamp within a lamp sleeve located at the position nearest to one of the reactor's UV sensors.
2. Pass water through the reactor at a constant flow rate and UVT.
3. With only the lamp under evaluation on, record the measured UV intensity.
4. Repeat the test for each lamp and rank the results.
5. For full-scale reactor testing, install the lamps with the highest output closest to the UV sensors. The rest of the lamps should be randomly distributed (with respect to lamp intensity).

5.4.8 UV Sensors

UV sensors are photosensitive detectors that measure UV intensity. UV sensors used in drinking water UV applications, particularly those with MP or other polychromatic lamps, should be *germicidal*. Germicidal sensors are defined as having the following properties:

- A spectral response (i.e., UV intensity measured at various wavelengths) that peaks between 250 and 280 nanometers (nm).
- Less than 10 percent of its total measurement is due to light above 300 nm when mounted on the UV reactor and viewing the UV lamps through the water that will be treated.

Manufacturers should document the spectral response of the UV sensors. Tables 5.3 and 5.4 provide two examples of spectral response for a hypothetical germicidal sensor and a hypothetical non-germicidal sensor, respectively. Figure 5.3 graphically depicts the spectral response for the data in Tables 5.3 and 5.4, respectively.

Table 5.3 shows that nearly 100 percent of the area under the spectral response curve between 200 and 400 nm is at wavelengths below 300 nm - almost none of the sensor reading is due to wavelengths greater than 300 nm. Moreover, the peak spectral response is at 270 nm. Therefore, this UV sensor is classified as germicidal. Conversely, Table 5.4 reveals that only 74 percent of the area under the curve is below 300 nm, which means that 26 percent of the area is measured at wavelengths greater than 300 nm. Because 26 percent is greater than the maximum allowable 10 percent, this UV sensor is classified as non-germicidal.

EPA recognizes that, before the publication of this document, some UV reactors using MP lamps with non-germicidal sensors are in the final design phases, and some have been installed at water treatment plants. These water systems should apply a correction factor to validation test data to account for *polychromatic bias*. Section D.4 in Appendix D explains how polychromatic bias impacts sensor reading and provides guidelines for deriving the correction factor. As noted in Chapter 4, facilities installing new UV treatment systems should use reactors that are equipped with germicidal sensors.

5.4.9 UV Sensor Port Windows

UV sensors often view the lamps through a UV sensor port window. These windows are typically made of quartz and have a UVT greater than 90 percent. The UVT of the sensor port windows should be checked before and after validation testing. If the sensor port windows are fouled or contaminated, UV sensor readings will be low. If this were to occur during validation testing, it could lead to under-dosing at the water treatment plant whenever the sensor port windows are clean. A collimated beam apparatus and a radiometer can be used to measure the sensor port window UVT either before the reactor is shipped to the test site or during validation testing.

5.5 Accuracy of Measurement Equipment

During validation testing, all equipment should be carefully selected and calibrated to minimize uncertainty. All measurements of flow rate, electrical power consumption, and head loss⁵ should be traceable to an independent standard. Moreover, because they are key parameters that affect UV dose delivery, measurements of UVT and UV intensity should be NIST⁶-traceable or equivalent⁷ with a known measurement uncertainty.

⁵ Although not part of UV validation, headloss as a function of flow rate is often measured during validation testing as it offers an opportunity to gather such design data on the system

⁶ National Institute of Science and Technology

⁷ For example, the German national testing and standards agency, Physikalisch Technische Bundesanstalt (PTB), or the United Kingdom's National Weights and Measures Laboratory.

Table 5.3. Hypothetical Example of the Spectral Response of a Germicidal UV Sensor

Wavelength (nm)	Spectral Response ¹ (mW/cm ²)	Area Under the Curve Between Readings	Cumulative Area Under the Curve	Cumulative Area as % of Total Area
200	0.11	–	–	–
210	0.21	1.600 ²	1.6	3%
220	0.30	2.550 ³	4.15	8%
225	0.35	1.625	5.775	11%
230	0.40	1.875	7.65	14%
235	0.48	2.200	9.85	18%
240	0.58	2.650	12.5	23%
245	0.72	3.250	15.75	29%
250	0.88	4.000	19.75	36%
255	1.03	4.775	24.525	45%
260	1.15	5.450	29.975	55%
265	1.23	5.950	35.925	66%
270	1.30	6.325	42.25	77%
275	1.21	6.275	48.525	89%
280	0.30	3.775	52.3	95%
285	0.19	1.225	53.525	98%
290	0.08	0.675	54.2	99%
295	0.03	0.275	54.475	99%
300	0.02	0.125	54.6	100%
310	0.01	0.150	54.75	100%
320	0.00	0.050	54.8	100%
330	0.00	0.000	54.8	100%
340	0.00	0.000	54.8	100%
350	0.00	0.000	54.8	100%
360	0.00	0.000	54.8	100%
370	0.00	0.000	54.8	100%
380	0.00	0.000	54.8	100%
390	0.00	0.000	54.8	100%
400	0.00	0.000	54.8	100%

¹ UV intensity measured by the UV sensor.

² $(0.21 + 0.11) \times (210 - 200) / 2$

³ $(0.30 + 0.21) \times (220 - 210) / 2$

Table 5.4. Hypothetical Example of the Spectral Response of a Non-germicidal UV Sensor

Wavelength (nm)	Spectral Response ¹ (mW/cm ²)	Area Under the Curve Between Readings	Cumulative Area Under the Curve	Cumulative Area as % of Total Area
200	0.12	–	–	–
210	0.30	2.100 ²	2.1	2%
220	0.47	3.850 ³	5.95	6%
225	0.55	2.550	8.5	8%
230	0.63	2.950	11.45	11%
235	0.71	3.350	14.8	14%
240	0.79	3.750	18.55	17%
245	0.87	4.150	22.7	21%
250	0.94	4.525	27.225	25%
255	1.01	4.875	32.1	30%
260	1.07	5.200	37.3	35%
265	1.12	5.475	42.775	40%
270	1.14	5.650	48.425	45%
275	1.15	5.725	54.15	50%
280	1.12	5.675	59.825	56%
285	1.07	5.475	65.3	61%
290	1.00	5.175	70.475	66%
295	0.91	4.775	75.25	70%
300	0.82	4.325	79.575	74%
310	0.63	7.250	86.825	81%
320	0.48	5.550	92.375	86%
330	0.38	4.300	96.675	90%
340	0.31	3.450	100.125	93%
350	0.23	2.700	102.825	96%
360	0.15	1.900	104.725	98%
370	0.10	1.250	105.975	99%
380	0.06	0.800	106.775	99%
390	0.03	0.450	107.225	100%
400	0.00	0.150	107.375	100%

¹ UV intensity measured by the UV sensor.

² $(0.31 + 0.12) \times (210 - 200) / 2$

³ $(0.47 + 0.30) \times (220 - 210) / 2$

Figure 5.3. Hypothetical Examples of the Spectral Response of a Germicidal and a Non-germicidal UV Sensor

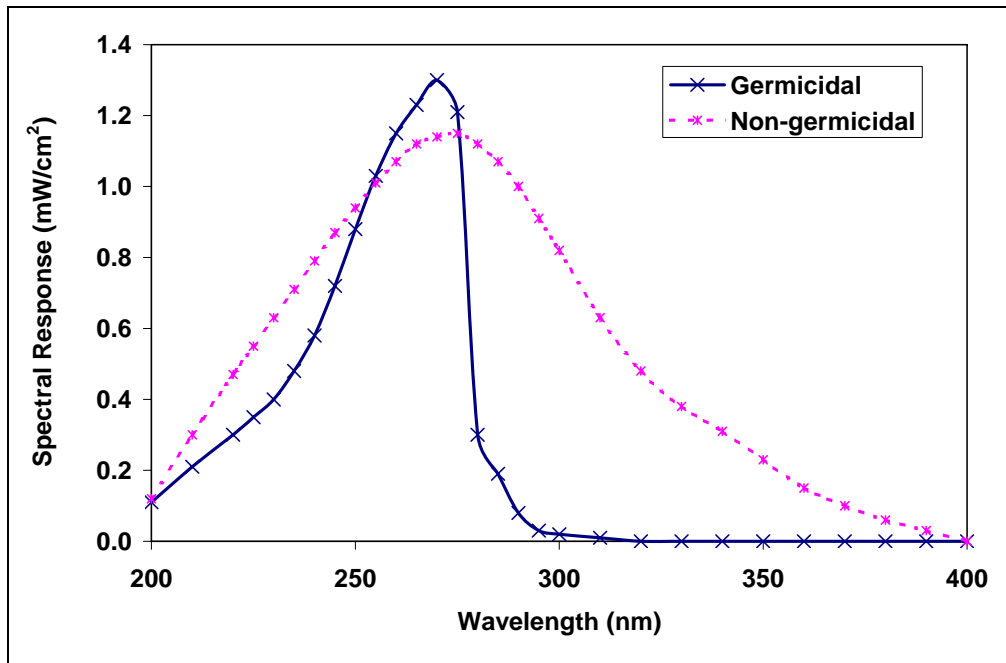

Source: Data from Tables 5.3 (germicidal sensor) and 5.4 (non-germicidal sensor).

The next three sections provide recommendations for verifying measurement uncertainty for flow meters, UV spectrophotometers, and power consumption. Section 5.5.4 provides the recommended approach for determining the measurement uncertainty of UV sensors, which the LT2ESWTR requires. Tests verifying equipment accuracy (particularly UV sensor checks as described in Section 5.5.4) should be documented in the Validation Report (See Section 5.11 for guidance).

5.5.1 Flow Meters

During validation testing, the uncertainty of flow rate measurements should be less than or equal to **5 percent**. The measurement uncertainty of the flow meter can be verified by comparing measured flow rate to a second, calibrated flow meter or a calibrated pitometer.

5.5.2 UV Spectrophotometers

Spectrophotometer measurements of A_{254} should be verified using NIST-traceable potassium dichromate UV absorbance standards and holmium oxide UV wavelength standards. Many UV spectrophotometers have their own internal QA/QC procedures to verify calibration. UV absorbance of solutions used to zero the spectrophotometer should be verified using reagent-grade organic-free water certified by the supplier to have zero UV absorbance.

The measurement uncertainty of the spectrophotometer should be **10 percent or less**. A recommended approach for achieving this goal is as follows:

1. Verify that the spectrophotometer reads the wavelength to within the accuracy of a holmium oxide standard (typically ± 0.11 nm at a 95-percent confidence level),
2. Verify that the spectrophotometer reads A_{254} within the accuracy of a dichromate standard (e.g., 0.281 ± 0.004 cm^{-1} at 257 nm with a 20 mg/L standard), and
3. Verify that the water used to zero the instrument has an A_{254} value that is within 0.002 cm^{-1} of a certified zero absorbance solution.

When the UVT is greater than 90 percent, it is recommended that a 4-cm or greater pathlength cuvette be used (as opposed to the standard 1-cm cuvette). This greatly improves the accuracy of the UVT measurement at values above 90 percent. Measurements made with a 4-cm cuvette can be converted to 1-cm UVT measurements using the following equation:

$$UVT_{1\text{-cm}} = UVT_{4\text{-cm}}^{1/4} \quad \text{Equation 5.4}$$

When validation testing is performed using unfiltered water, the UV spectrophotometer should be equipped with an integrating sphere, which will provide more accurate UV absorbance readings if there are particles in the water.

If the spectrophotometer provides biased readings, the measurements should be corrected to account for that bias, or another instrument with measurement uncertainty of 10 percent or less should be used.

5.5.3 Power Measurements

Voltmeters, ammeters, and power meters used to measure (1) ballast and UV equipment input voltage, and (2) consumed current and power, should bear evidence of being in calibration (e.g., have a tag showing that it was calibrated). The accuracy of the measurements can be verified using a second instrument or a standard measurement. Power meters should provide a measure of true power as opposed to apparent power in units of kilovolt ampere (kVA).

5.5.4 UV Sensors

During validation testing, duty UV sensor measurements should be within **10 percent** of the average of two or more reference sensor measurements.⁸ Duty sensors that do not meet this criterion should be replaced or the measurement uncertainty should be incorporated into the VF (see Section 5.9).

⁸ Note that this error range is smaller than recommended for operations (in Section 6.4.1.1, EPA recommends that sensor readings be within 20 percent of the average of two or more reference sensors). EPA believes that a 10-percent error is easily attainable during validation testing and will help ensure good data quality for developing operational setpoints.

The following procedure can be used to check the uncertainty of the duty and reference UV sensors used during validation (this calculation is also illustrated in the examples in Appendix B).

1. Pass water through the reactor at the maximum UVT and the maximum lamp power setting to be used during validation testing.
2. Using two recently calibrated reference UV sensors (which should agree within the calibration certificate-specified measurement uncertainty⁹), install each sensor on the UV reactor at each port and record the measured UV intensity (S_{ref}). Repeat using each duty UV sensor (S_{duty}). If the UV sensors can be rotated, measure the minimum and maximum sensor readings across the complete range of rotation.
3. Repeat Steps 1 and 2 at either (a) maximum lamp power and UVT decreased to the minimum value expected during validation testing, or (b) maximum UVT and lamp power decreased to the minimum level expected to occur during validation testing. Duty UV sensors can be checked under both conditions, although this is not necessary.
4. For a given lamp output and UVT value, the difference between the reference and duty UV sensor measurements should follow Equation 5.5:

$$\left| \frac{S_{duty}}{S_{Ref,avg}} - 1 \right| \leq 10\% \quad \text{Equation 5.5}$$

where:

- S_{duty} = Intensity measured by a duty UV sensor
 $S_{Avg Ref}$ = Average UV intensity measured by all the reference UV sensors in the same UV sensor port with the same UV lamp at the same UV lamp power.

5. Duty and reference UV sensors that do not meet this criterion should be replaced. Alternatively, measurement uncertainty can be re-stated at the maximum uncertainty observed during validation testing and incorporated into the VF (see Section 5.9).

Duty sensors should be checked prior to full-scale reactor testing to ensure that the data collected during testing will be useful. Sensors are also often spot-checked during and after full-scale testing to verify that they are still within the recommended uncertainty limit.

5.6 Identifying Test Conditions

Numerous combinations of experimental tests can be performed to validate a UV reactor. The number of tests could range from a few tests to a complex matrix spanning a range of UV

⁹ If the reference sensors do not agree with the calibration certificate-specified measurement uncertainty, they should be sent back to the manufacturer.

dose, flow rate, UVT, ballast power, and lamp status combinations. The test design (i.e., number of tests and test conditions) depends on several factors, as summarized in Table 5.5.

Table 5.5. Factors to be Considered in Validation Test Design

Factor	Examples	Section of Manual with Additional Guidance
1. Purpose of validation testing	Validation of new reactor by water system vs. validation to confirm an existing validation equation	3.6 5.6
2. Dose-monitoring strategy of the UV reactor	UV Intensity Setpoint Approach vs. the Calculated Dose Approach ¹	3.5.2
3. Operational strategy (for the UV Intensity Setpoint Approach only)	Single-setpoint operations vs. variable-setpoint operations	3.5.2
4. Predicted lamp aging and fouling	Aging factor of 0.8 vs. using aged lamps used during validation testing (where the aging factor would equal 1.0)	3.4, 5.4.6
5. Target pathogen and target log inactivation	2.0 log inactivation of <i>Cryptosporidium</i> vs. 3.0 log inactivation of viruses	3.1
6. Full operating range of flow rate and UVT	Range of flow = 5 – 20 mgd, Range of UVT = 70 – 90 %	3.4

¹ As noted in Section 3.5.2, there are many dose-monitoring strategies for UV reactors. This guidance manual focuses on two common strategies, the UV Intensity Setpoint Approach and the Calculated Dose Approach.

Although all factors in Table 5.5 influence test design, the total number of experiments is highly dependent on the first three factors. For example, suppose a water system wants to validate a new UV reactor that uses the UV Intensity Setpoint Approach. The system decides to use single-setpoint operations, meaning that it will use one UV intensity setpoint for all operating conditions. Validation testing in this case would be fairly straightforward with a small number of tests. If another water system selects the same reactor but selects variable-setpoint operations to allow it to reduce lamp power at low flow rates, that system would conduct more validation tests to establish different setpoints for the different flow rate ranges. Another common scenario is when a manufacturer decides to validate a new UV reactor over a wide range of flow rates, UVT levels, and lamp status combinations to develop a dose-monitoring equation. This scenario likely would necessitate many tests.

As noted in Section 5.4.6, lamp fouling and aging are important factors that should be accounted for during validation testing. Power turn-down is typically used to simulate lamp aging and fouling at the end-of-lamp life. Instead of reducing power to simulate lamp aging, aged lamps can be used during validation testing (although power-turn down would still be needed to simulate lamp fouling). Section 3.4.5 provides information on how the fouling/aging factors are estimated, and Section 5.4.6 provides guidance on using new versus aged lamps during validation testing.

If a new, un-validated reactor is being tested for a specific water system, the last two items listed in Table 5.5 can help establish validation test conditions. The target pathogen and target log inactivation for the water system define the required dose that is the target for

validation testing. The full range of operating conditions for flow rate and UVT dictate the flow rate and UVT conditions used during validation testing.

Sections 5.6.1 and 5.6.2 discuss the validation test design for the UV Intensity Setpoint Approach and the Calculated Dose Approach, respectively. Test designs for other dose-monitoring strategies that use setpoints should be similar to recommendations in Section 5.6.1 and should be developed using professional judgment. Section 5.6.3 provides considerations for water systems who are confirming an existing dose-monitoring equation (as developed for the Calculated Dose Approach). Section 5.6.4 lists the types of quality control samples that should be collected and analyzed during testing. Appendix C provides guidelines for identifying test conditions for collimated beam testing.

Experimental test conditions should be documented in a *Validation Test Plan*. Section 5.11.2 provides recommendations on what a Validation Test Plan should contain. EPA recommends including the Test Plan into the final Validation Report (see Section 5.11.3).

5.6.1 Test Conditions for the UV Intensity Setpoint Approach

For the UV Intensity Setpoint Approach, the purpose of validation testing is to determine the validated dose corresponding to the UV intensity setpoint for a reactor at a particular flow rate. Typically, the manufacturer determines the UV intensity setpoint for their reactor. If this is the case, water systems should work with the manufacturer to ensure that *the setpoint is defined conservatively low enough* to account for combined conditions of minimum UVT and maximum fouling/aging (commonly represented by the fouling/aging factor). If the manufacturer does not establish the UV intensity setpoint for their reactor, the water system can select a setpoint using the following procedure:

1. Record the UV intensity measurement at conditions of maximum UVT and 100 percent power (S_o)¹⁰.
2. Reduce the lamp power until the measured UV intensity results in the following *relative sensor intensity* (S/S_o per Equation 5.3):
 - a. If aged lamps are used during validation testing, the relative sensor intensity should be equal to the *fouling factor*.
 - b. If new lamps are used during validation testing, the relative sensor intensity should be equal to the *fouling/aging factor*, which is the fouling factor multiplied by the aging factor.
3. Reduce the UVT of the water to the minimum UVT (see Section 3.4 for guidance on determining the minimum UVT).

¹⁰ The impacts of lamp power and UVT on UV sensor readings are not dependent on the specific rate of flow traveling through the reactor. Thus, any flow rate can be used for this procedure.

4. Record the UV Intensity at reduced power and reduced UVT conditions. This intensity is the *UV intensity setpoint*.

The UV Intensity Setpoint approach uses *two validation test conditions*, as specified in Table 5.6. The first involves reducing UVT until UV intensity measured by the UV sensor is equal to the UV intensity setpoint. The second involves testing at high UVT but reducing power until the UV intensity measured by the sensor is equal to the UV intensity setpoint. Additional test conditions should be evaluated if the water system will be using variable setpoint operations (i.e., each test condition in Table 5.6 should be repeated at different flow rates).

Table 5.6. Minimum Test Conditions for the UV Intensity Setpoint Approach¹

Test ID ²	Flow Rate	UVT	Lamp Power
1	Design (highest)	Lowered to give the UV intensity setpoint ³	Maximum (100 %)
2	Design (highest)	Maximum	Lowered to give the UV intensity setpoint ³

¹ Minimum test conditions shown are for single-setpoint operations. Additional tests should be conducted at different flow rates for variable setpoint operations.

² At least three replicate tests with the same stock solution of challenge microorganisms should be performed for each test condition.

³ The UV intensity setpoint is typically established by the manufacturer. Alternatively, it can be established by the water system using the procedure in Section 5.6.1.

Water systems may decide to use two challenge microorganisms with different UV sensitivities for validation testing (see Section 5.3 for additional discussion). In many cases, challenge microorganisms can be tested at the same time if they have been proven not to interfere with each other.

The validation approach described herein produces a UV intensity setpoint and Validated Dose that are independent of UVT. Thus, UVT is not typically monitored during reactor operations.

5.6.2 Test Conditions for the Calculated Dose Approach

For the Calculated Dose Approach, the purpose of validation testing is to develop a dose-monitoring equation relating RED¹¹ to operating parameters such as flow rate, UVT, lamp power (quantified as relative sensor value), and in some cases lamp status. For each operating parameter used in the equation, *at least three conditions* should be evaluated during validation testing. Three data points are needed for interpolation of results because the relationship between RED and operating parameters such as flow rate and UVT is typically non-linear.

¹¹ As a reminder, RED is the reduction equivalent dose, which is determined by inputting the measured log inactivation (observed during full-scale reactor testing) into the UV dose-response curve (generated through collimated beam testing).

In many cases, three operating parameters (UVT, flow rate, and lamp power) are used in the dose-monitoring equation, resulting in a minimum of **27 test conditions** ($3 \times 3 \times 3$). Fewer test conditions are needed when the dose monitoring equation is based on fewer than three parameters, such as when a minimum UVT is assumed for all operating conditions. More than 27 test conditions may be needed when the water system plans to vary lamp status during operations (e.g., UVT, flow rate, and lamp power are used in the dose monitoring equation and individual banks of lamps will be turned off and on to conserve power).

If validation tests are being conducted for a specific water system, the system's operating range of flow rates, UVT, and the required UV dose for their target pathogen and log inactivation help establish test conditions. For flow rate, the water system's maximum and minimum flow rates, as well as one or more intermediate flow rates, should be selected as test conditions. To select intermediate flow rates, EPA recommends using a geometric progression (because the relationship between UV dose and flow is non-linear) using the following equation:

$$Q_n = Q_{Max} \beta^{1-n} \quad \text{Equation 5.6}$$

where:

Q_n = n^{th} flow rate to be tested

Q_{Max} = Maximum flow rate to be tested

β = Constant with a recommended value between 1.5 and 2.0 to achieve good separation of flow measurements

n = Flow rate test # to be evaluated (must be ≥ 3 , if interpolating results)

The value of β should be sufficient to obtain at least three measured data points for developing the dose-monitoring equation. The value of n should be selected to span the range of flow rates. An example using Equation 5.6 is provided below.

Example 5.1. Determining Flow Conditions for Validation Testing. A UV reactor using the Calculated Dose Approach and operating within the range of 5 – 20 mgd is to be validated. The test engineer selects a β value of 1.6, resulting in the following test flow rates:

n	Q (mgd)
1	20
2	12.5
3	7.8
4	4.9

For UVT, test conditions should include the water system's minimum UVT, maximum UVT, and at least one intermediate value. If the dose-monitoring equation will account for specific lamps operating either on or off or other power manipulations, validation test design should include these conditions.

Table 5.7 summarizes the recommended minimum test conditions for the Calculated Dose Approach. Table B.9 in Appendix B presents an example test matrix for a hypothetical water system.

Table 5.7 Minimum Test Conditions for the Calculated Dose Approach¹

Test ID ²	UVT Flow rate ³	Flow Rate ³	Lamp Power ⁴
1	Maximum	Design	Maximum
2	Maximum	Intermediate	Maximum
3	Maximum	Minimum	Maximum
4	Maximum	Design	Minimum expected to occur during operations
5	Maximum	Intermediate	Minimum expected to occur during operations
6	Maximum	Minimum	Minimum expected to occur during operations
7	Maximum	Design	Intermediate
8	Maximum	Intermediate	Intermediate
9	Maximum	Minimum	Intermediate
10	Intermediate	Design	Maximum
11	Intermediate	Intermediate	Maximum
12	Intermediate	Minimum	Maximum
13	Intermediate	Design	Minimum expected to occur during operations
14	Intermediate	Intermediate	Minimum expected to occur during operations
15	Intermediate	Minimum	Minimum expected to occur during operations
16	Intermediate	Design	Intermediate
17	Intermediate	Intermediate	Intermediate
18	Intermediate	Minimum	Intermediate
19	Minimum	Design	Maximum
20	Minimum	Intermediate	Maximum
21	Minimum	Minimum	Maximum
22	Minimum	Design	Minimum expected to occur during operations
23	Minimum	Intermediate	Minimum expected to occur during operations
24	Minimum	Minimum	Minimum expected to occur during operations
25	Minimum	Design	Intermediate
26	Minimum	Intermediate	Intermediate
27	Minimum	Minimum	Intermediate

¹ Assuming validation on a non-validated UV reactor. Minimum test conditions shown are for all lamps turned on. Additional tests should be performed to evaluate other lamp on/off combinations or other power combinations.

² At least three replicate tests with the same stock solution of challenge microorganisms should be performed for each test condition.

³ See Section 3.4 for guidelines on identifying design flow and minimum and maximum UVT.

⁴ Minimum power should include reduction in lamp output caused by fouling and aging.

5.6.3 Test Conditions for Confirming an Existing Validation Equation

Water systems may decide to perform on-site validation testing to show that the hydraulic conditions at the water treatment plant result in a UV dose that is the same or greater than the UV dose delivered at the off-site validation test facility. Test conditions should generally span the range of operating conditions expected at the treatment plant (e.g., minimum and maximum UVT, minimum and maximum flow rate). See Section 3.6.2 for additional discussion on validation testing scenarios.

EPA cautions water systems on combining on-site validation testing data with off-site validation data to develop a new dose-monitoring equation. On-site and off-site testing is often done under different hydraulic conditions and may produce different results. Combining the datasets may result in greater noise about the fit for the dose-monitoring equation and, thus, a higher uncertainty factor (see Section 5.9.2.2 for a discussion of the uncertainty in interpolation factor)

5.6.4 Quality-control Samples

Recommended quality-control samples for full-scale reactor testing are listed below.

- *Reactor controls* – influent and effluent water samples taken with the UV lamps (in the reactor) turned off. The change in log concentration from influent to effluent should correspond to a change in RED (from the UV dose-response curve) that is within the measurement error of the minimum RED measured during validation (typically 3 percent or less).
- *Reactor blanks* – influent and effluent water samples taken with no addition of challenge microorganism to the flow passing through the reactor. Blanks should be collected at least once on each day of testing and the concentration of challenge microorganisms should be negligible.
- *Trip controls* – one sample bottle of challenge microorganism stock solution should travel with the stock solution used for validation testing from the microbiological laboratory to the location of reactor testing and back to the laboratory. The change in the log concentration of the challenge microorganism in the trip control should be within the measurement error. (i.e., the change in concentration over the test run should be negligible. This is typically on the order of 3 to 5 percent.

- *Method blanks* – sample bottle of sterilized reagent grade water that undergoes the challenge microorganism assay procedure. The concentration of challenge microorganism with the method blank should be non-detectable, according to *Standard Methods for the Examination of Water and Wastewater* (APHA et al. 1998).
- *Stability samples* – influent and effluent samples collected at low and high UVT that are used to assess the stability of the challenge microorganism concentration and its UV dose-response over the time period from sample collection to completion of challenge microorganism assay. The challenge microorganism concentrations in the stability samples should be within 5 percent of each other.

5.7 Guidelines for Conducting Experimental Tests

Section 5.7.1 provides general guidelines for preparing the challenge microorganism for testing. Sections 5.7.2 and 5.7.3 provide recommendations for conducting full-scale reactor testing and collimated beam testing, respectively. Appendix C contains more detail on the collimated beam testing methods. Importantly, the recommendations in this section and in Appendix C are not step-by-step procedures, but rather an identification of key steps in the process. Individuals performing full-scale reactor testing and collimated beam testing should work closely with the laboratory personnel and experts in the field of validation testing to ensure that appropriate procedures and QA/QC steps are followed.

5.7.1 Preparing the Challenge Microorganism

The challenge microorganism used to validate UV reactors should be cultured and analyzed by a laboratory staffed by professional microbiologists and equipped to perform microbiological examinations as specified in *Standard Methods for the Examination of Water and Wastewater* (APHA et al. 1998). Protocols for culturing the challenge microorganism and measuring its concentration should be defined and based on published and peer-reviewed methods.

The challenge microorganism concentrations should be stable over the holding time between sampling and completion of the assays. If they are not stable, the data collected will be unusable because distinguishing the sources of inactivation—exposure to UV light and die-off in holding—will be impossible. Instability problems with MS2 phage are well documented in the literature (Petri et al. 2000, Swaim et al. 2003, Hargy et al. 2004). Factors that can impact MS2 phage stability in water include the presence of chlorine, coagulants, ionic strength, surfactants, and UV absorbers (Thompson and Yates 1999, Petri et al. 2000, Hargy et al. 2004). Laboratory methods can also impact the stability of MS2 phage in water (Thompson and Yates 1999). Microbial stability in the test water should be verified before experimental testing begins. Stability verification can help ensure that the bioassay and challenge microorganism samples will be viable and the data useable.

Appendix A provides recommended procedures for preparing stock solutions of MS2 phage and *B. subtilis* spores and assaying their concentrations in water samples. Alternative procedures and challenge microorganisms can be used if they are acceptable to the state.

5.7.2 Full-scale UV Reactor Testing

Three key steps comprise full-scale reactor testing: (1) verifying reactor properties, (2) installing the reactor, and (3) conducting the tests. These steps are summarized below. Note that key steps are based on UV reactor testing at an off-site validation test facility. Additional steps may be necessary for on-site validation.

Verifying UV Reactor Properties

For validation, the UV manufacturer should provide the following:

- A UV reactor that matches the provided specifications.
- Duty and reference UV sensors that match the provided specifications.
- UV lamps that have undergone appropriate burn-in. If new lamps are to be used, the recommended burn-in period is 100 hours. If aged lamps are to be used, the recommended burn-in period is that which will produce lamp output equivalent to the fouling/aging factor. More information on aged lamps is provided in Section 5.4.6.
- For UV reactors with more than one lamp per UV sensor, lamps with the highest output positioned closest to the sensor. (See Section 5.4.7 for additional guidance on sensor positioning to address lamp variability.)
- Provisions to reduce lamp output.
- Provisions to measure the electrical power delivered to the lamps.
- A temperature sensor and safety cut-off switch to prevent overheating if MP lamps are used.

Installing the UV Reactor

The UV reactor and the reactor inlet and outlet connections should be installed at the test facility in accordance with the manufacturer's installation and assembly instructions. If reactors are installed in series, the piping between the reactors should conform to the specifications provided by the UV reactor manufacturer. The piping should be inspected to ensure compliance with the manufacturer's specifications. The configuration of inlet and outlet piping to and from the reactor and its impact on validation testing is discussed in Sections 3.6 and 5.4.5. Good mixing should be confirmed.

The physical integrity of the UV reactor and the test train should be verified before testing. Personnel who operate the UV reactor during all tests should be familiar with its operation and maintenance manual and with any safety requirements.

Measuring UV Dose Delivery

During full-scale reactor testing, the reactor is operated at each of the test conditions for flow rate, UVT, and lamp power (in accordance with the Validation Test Plan) as described in Section 5.6. The following steps should be taken to ensure good results:

- Confirm steady-state conditions before injecting the challenge microorganism by monitoring the UV sensor measurements and the UVT.
- Inject the challenge microorganism, prepared according to Appendix A, into the flow upstream of the reactor.
- Collect at least three (3) influent and three (3) effluent samples for each test condition. Sample volumes should be sufficient for assessing the challenge microorganism concentrations in the influent and effluent (typically 10 – 15 mL).
- Measure and record the flow rate through the reactor, all UV sensor measurements, on-line UVT measurements, and any calculated UV dose values both before and after the samples are collected.
- Measure and record the UVT as measured by the UV spectrophotometer with each influent sample.
- Measure and record the electrical power consumed by the lamp ballasts.
- Repeat the test if the flow rate, UV intensity, lamp power, or UVT changes by more than the recommended error of the measurement over the course of sampling (see Section 5.5).

Sample taps should remain open over the duration of the test. Sample collection should meet standards of good practice as defined by *Standard Methods* Section 9060 (APHA et al. 1998). Samples should be collected in bottles that have been cleaned and sterilized and should be immediately stored on ice, within a cooler, in the dark until analyzed.

The concentrations of the challenge microorganisms before and after exposure to UV light should generally be measured within 24 hours of sample collection, unless stability studies indicate that the samples can reliably be considered stable over longer periods of time. Samples that are not assayed immediately should be stored in the dark at 4 °C. Exposure of samples to visible light should be avoided.

5.7.3 Collimated Beam Testing

Collimated beam tests are performed in microbiological laboratories under controlled conditions. Recommended test procedures are provided in Section C.2.3. Importantly, all collimated beam testing should be conducted using a water sample collected from the influent sampling port of the biosimetry test stand. If the full-scale reactor testing lasts for more than one day, at least one collimated beam test should be conducted for each day of testing. A minimum of two collimated beam tests is always recommended, one each at the highest and lowest UVT values evaluated during full-scale reactor testing.

5.8 Analyzing Experimental Data

Validation testing of UV reactors produces the following types of data for each experimental test:

- Concentration of the challenge microorganism in the influent and effluent sample [e.g., plaque forming units per milliliter (pfu/mL) for MS2 phage, colony forming units per milliliter (cfu/mL) for *B. subtilis* spores]
- UVT of water (percent)
- Flow rate [gallon per minute (gpm) or mgd]
- UV intensity as measured by the UV sensor (mW/cm^2)
- Lamp power [watt (W) or kilowatt (kW)]
- Status (on/off) for each lamp

All experimental data should be documented, preferably in tabular format, and included in the Validation Report. (See Section 5.11.3 for additional guidance on the Validation Report and Appendix B for examples.)

Section 5.8.1 shows how RED is calculated for each experimental test using a combination of full-scale reactor testing data and collimated beam results. Additional analyses of RED data depend on the reactor's UV dose-monitoring strategy. For the UV Intensity Setpoint Approach, RED results are averaged for each test condition and evaluated to identify the minimum value. For the Calculated Dose Approach, all RED values and associated test conditions are used to create a dose-monitoring equation. Sections 5.8.2 and 5.8.3 summarize recommended next steps for evaluating RED data for the UV Intensity Setpoint Approach and Calculated Dose Approach, respectively.

5.8.1 Calculating the Reduction Equivalent Dose (RED)

The RED should be calculated for all full-scale reactor test conditions, individually for each replicate, using the following method:

1. For each test condition replicate (i.e., influent and effluent sample pairs), calculate the log inactivation (log I) using Equation 5.7:

$$\log I = \log\left(\frac{N_o}{N}\right) \quad \text{Equation 5.7}$$

where:

N_o = Challenge microorganism concentration in influent sample (pfu/mL or cfu/mL)

N = Challenge microorganism concentration in corresponding effluent sample (pfu/mL or cfu/mL)

2. Determine the RED, in mJ/cm^2 for each test condition replicate pair using the measured log inactivation (log I) and the UV dose-response curve developed through collimated beam testing (see Appendix C). If individual UV dose-response curves cannot be combined, the curve for a given day of testing should be used to determine RED for full-scale reactor testing data collected that day. If individual dose-response curves developed on the same day of testing cannot be combined, the curve resulting in the most conservative (lowest) RED values should be used.

Note that for the UV Intensity Setpoint Approach, replicates for a given test condition are averaged. For the Calculated Dose Approach, replicates are evaluated separately to develop the UV dose-monitoring equation.

Appendix B shows RED calculations for two hypothetical water systems. Example 5.2 shows the key inputs and results for the hypothetical water system in Section B.1.

Example 5.2. Calculating RED Using Validation Test Data. Collimated beam testing using a challenge microorganism produces the following UV dose-response curve:

$$\text{UV Dose (mJ/cm}^2\text{)} = 2.18(\log I)^2 + 15.30(\log I) \quad (\text{from Figure B.2})$$

Full-scale reactor testing produces the following data for each test condition and replicate test:

Test Condition	Replicate	N_o (pfu/mL)	N (pfu/mL)	Log I	RED (mJ/cm^2)
1	1	5.94	4.57	1.37	25.1
1	2	6.00	4.54	1.46	27.0
1	3	5.84	4.56	1.28	23.2
2	1	6.01	4.10	1.91	37.2
2	2	5.99	4.09	1.9	36.9
2	3	6.04	4.06	1.98	38.8

The RED values for each test are shown in the last column.

If the UV reactor uses MP lamps and validation testing is performed using a challenge microorganism other than MS2 phage or *B. subtilis*, an action spectra correction factor (CF_{as}) may need to be applied to the RED values to account for differences in the action spectra of the target pathogen and challenge microorganism. Section D.4.1 in Appendix D describes this concept and presents the correction factors that should be used for the RED adjustment (i.e., divide RED by the correction factor).

If validation testing is done with two challenge microorganisms whose UV sensitivities bracket the UV sensitivity of the target pathogen (i.e., one microorganism is more resistant and one is less resistant), the following approach can be used to estimate the RED of the target pathogen for each test condition:

1. For each test condition, calculate the UV sensitivity (mJ/cm^2 per log I) of the challenge microorganism using the following equation:

$$UV \text{ sensitivity} = RED / \text{Log } I \quad \text{Equation 5.8}$$

where:

RED = The RED for the test replicate as derived by inputting Log I into the UV dose-response equation

Log I = log inactivation for the test replicate as calculated using Equation 5.7

2. Create a graph with UV sensitivity on the x -axis and RED (mJ/cm^2) on the y -axis for each test condition.
3. For each challenge microorganism, plot paired UV sensitivity and RED values on the graph (2 values).
4. Draw a straight line between the two points.
5. Determine the UV sensitivity for the target pathogen by selecting the UV dose from Table 1.4 for **1 log inactivation** ($\text{log } I = 1$)
6. Using the straight line in the graph created in Step 4, read the corresponding RED value for the UV sensitivity of the target pathogen (as determined in Step 5).

Example 5.3 shows this procedure using hypothetical validation test data. As noted in Section 5.3, the main advantage of testing two challenge microorganisms whose UV sensitivities bracket the sensitivity of the target pathogen is that the factor used to account for challenge microorganism bias (the RED Bias factor) can be set to **1.0**. (See Section 5.9 for discussion of the RED bias factor.)

Example 5.3. Validation Testing Using Two Challenge Microorganisms

Validation testing is performed using MS2 and ϕ x174. The table below summarizes average results for three replicates for one test condition (high UVT).

Challenge Microorganism	Influent Conc. (pfu/mL)	Effluent Conc. (pfu/mL)	UV Sensitivity (mJ/cm ² per log I) ¹	Log I ²	RED (mJ/cm ²) ³
MS2	1×10 ⁶	1×10 ⁴	20	2.0	40
ϕ x174	1×10 ⁴	0	2	≥4.0	≥8.0

¹ As derived from collimated beam testing data for a log inactivation of 2.0 for MS2 and 4.0 for ϕ x174 using Equation 5.9.

² Based on measured influent and effluent microorganism concentrations from validation testing.

³ Determined by inputting log I into the UV dose-response equation.

Paired UV sensitivity and RED values for MS2 and ϕ x174 were plotted on the graph below.

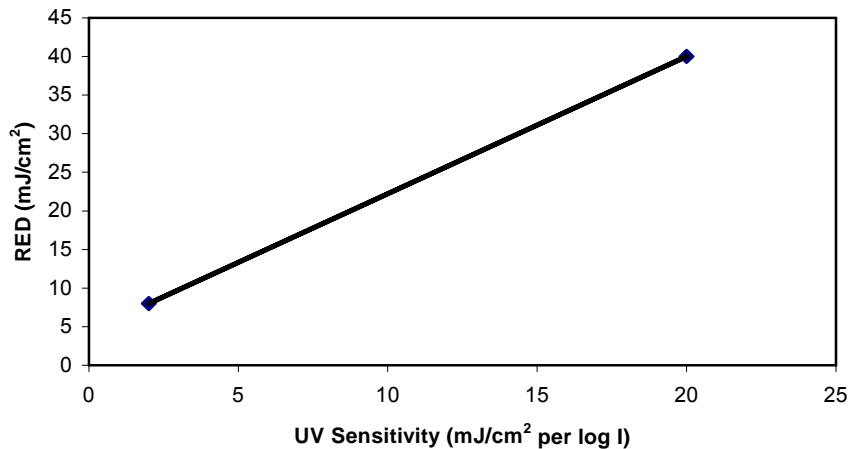

Straight-line interpolation between the two points yields the following equation:

$$RED = 1.78 \times UV \text{ Sensitivity} + 4.44$$

The equation above predicts that the RED delivered to *Cryptosporidium*, defined with a UV sensitivity of 3.9 mJ/cm² per log inactivation (Table 1.4), is:

$$RED = 1.78 \times 3.9 + 4.44 = 11.4 \text{ mJ} / \text{cm}^2$$

Because the RED represents the dose delivered to *Cryptosporidium*, the RED Bias Factor is equal to 1.0.

5.8.2 Selecting the Minimum RED for the UV Intensity Setpoint Approach

Replicate RED values (typically 3 – 5 values) should be averaged to produce one RED for each test condition. From these average values, the *minimum RED* should be selected and used in the validated dose calculation. If variable-setpoint operations will be used at the water treatment plant (i.e., different UV intensity setpoints for different flow rate ranges), the minimum RED value should be identified for each flow rate range.

Table 5.6 in Section 5.6.1 presents the two test conditions that should be evaluated, at a minimum, for the UV Intensity Setpoint Approach. If the UV sensor is in the ideal location (i.e., a location that gives UV dose delivery proportional to the UV sensor reading), the two test conditions should yield the same RED. If the sensor is located farther from the lamp than the ideal location, the minimum RED will be produced under minimum UVT/maximum power conditions (Test 1). If the sensor is located closer to the lamp than the ideal position, the minimum RED will be produced under maximum UVT /minimum power conditions (Test 2). Selecting the minimum RED from these two test conditions accounts for UV reactor designs where the sensor is not in the ideal location. See Section D.2 in Appendix D for additional discussion on UV sensor positioning.

5.8.3 Developing the Dose-monitoring Equation for the Calculated Dose Approach

If the reactor uses the Calculated Dose Approach, validation testing results are used to develop a *dose-monitoring equation* for RED. The variables in the dose-monitoring equation are typically flow rate, UVT, UV intensity, or some subset thereof. The number of operating banks of lamps is also a possible variable for the equation for those water systems that use multiple banks.

EPA recommends using multivariate linear regression to fit an equation to the validation test data. Procedures for multivariate linear regression can be found in standard statistical textbooks such as Draper and Smith (1998). Software packages, such as Microsoft Excel, can also be used to perform the regression analysis and determine the goodness-of-fit. Recommended steps for the analysis are summarized below.

1. **Fit an equation for RED as a function of the operating parameters of interest (using all the replicate inlet-and-outlet pairs) using multivariate linear regression.** The equation used for interpolating validation data may have various forms depending on how it was derived. An empirical equation that can often provide a good fit to validation data has the following form (Wright et al. 2005):

$$RED = 10^a \times A_{254}^b \times \left(\frac{S}{S_o} \right)^c \times \left(\frac{1}{Q} \right)^d \times B^e \quad \text{Equation 5.9}$$

or in linear form,

$$\log(\text{RED}) = a + b \times \log(A_{254}) + c \times \log\left(\frac{S}{S_o}\right) + d \times \log\left(\frac{1}{Q}\right) + e \times B \quad \text{Equation 5.10}$$

where:

- RED = The RED calculated with the dose-monitoring equation, also referred to as the “calculated dose” in this guidance manual
- A_{254} = UV absorbance at 254 nm
- S = Measured UV sensor value
- S_o = UV intensity at 100 percent lamp power, typically expressed as a function of UVT.
- Q = Flow rate
- B = Number of operating banks of lamps within the UV reactor
- a, b, c, d, e = Model coefficients obtained by fitting the equation to the data

Either the full equation or part of the equation can be used for fitting validation data. For example, validation data collected at a constant UVT and lamp power setting can be fitted using:

$$\text{RED} = a \times \left(\frac{1}{Q}\right)^d \quad \text{Equation 5.11}$$

or in linear form,

$$\log(\text{RED}) = \log(a) + d \log\left(\frac{1}{Q}\right) \quad \text{Equation 5.12}$$

The exact form of the relationship will depend on the UV reactor and the functional relationships between RED and each variable.

The equation should pass through the origin (0,0) if the RED is calculated as a function of measured UV intensity or inverse flow rate. A zero measured dose should correspond to a zero calculated dose. A non-zero intercept would introduce a bias.

- Determine the goodness-of-fit.** This can be done using procedures found in standard statistics books or by reviewing variance tables produced by statistical programs. The analysis should determine the p-statistics for the model coefficients. For the fit to be acceptable, the p-statistic for each model coefficient should be ≤ 0.05 .

If the p-statistic for a given model coefficient is greater than 0.05, the coefficient is not statistically significant. The coefficients are calculated with all the variables included. If the p-statistic for any coefficient exceeds 0.05, then, working in reverse, the model coefficient with the highest p-statistic should be dropped from the equation and the multivariate regression repeated until all p-statistics are less than or equal to 0.05. Alternatively, the functional form of the equation could be revised to improve the relationship between RED and the parameters of interest (e.g., use Equation 5.12

instead of Equation 5.10).

3. **Verify that there is no significant bias in the fit.** One way to do this is to test for randomness in residual values (Draper and Smith 1998). The differences between the measured and calculated RED values should be randomly distributed around zero and not dependent on flow rate, UVT, or lamp status.

Because both UVT and UV intensity are part of the dose-monitoring equation, it is not important that the sensor be in the ideal location. If the UV sensor *is* in the ideal location, however, UVT could be removed from the dose-monitoring equation. See Section D.2 for additional discussion of UV sensor positioning.

5.9 Deriving the Validation Factor (VF)

Several uncertainties and biases are involved in using experimental testing to define a validated dose and validated operating conditions. For example, a challenge microorganism may have a different UV sensitivity than the target pathogen. To determine the validated dose, the RED (derived in Section 5.8) is divided by a **VF** to quantitatively account for key areas of uncertainty. The equation for the VF is shown below.

$$VF = B_{RED} \times \left(1 + \frac{U_{val}}{100} \right) \quad \text{Equation 5.13}$$

where:

- VF = Validation Factor
- B_{RED} = RED bias factor
- U_{Val} = Uncertainty of validation expressed as a percentage

In addition to the RED bias factor, a bias factor to account for the influence of non-germicidal light on UV sensor readings (referred to as the “polychromatic bias factor”) should be included in Equation 5.13 for MP reactors that meet either of the following criteria:

- The MP reactor is equipped with a non-germicidal sensor¹²
- The MP reactor is equipped with a germicidal sensor, but the sensor is mounted further than 10 cm from the lamp and the water to be treated has a low UVT (< 80%)

Derivation of the polychromatic bias factor and its inclusion in the VF calculation are addressed in Appendix D, Section D.4.3.

The next two sections provide recommendations for calculating the RED bias factor and uncertainty in validation and determining when each should be applied. Appendix D discusses in greater detail the basis for the uncertainty and bias terms and how they were derived.

¹² EPA recommends that MP reactors be equipped with **germicidal sensors** to more accurately measure UV light in the germicidal range. EPA recognizes, however that reactors with non-germicidal sensors have been installed or are about to be installed at water treatment plants prior to the publication of this document.

Appendix B uses two example case studies to illustrate the calculation of the VF using methods described in this section.

Some areas of experimental uncertainty are not included in the VF equation. Instead, EPA recommends that UV reactor monitoring components meet the performance criteria presented in Chapter 6 and validation test results meet the QA/QC criteria as presented throughout this chapter and summarized in Section 5.12. Section 5.9.2 includes a method for checking key areas of experimental uncertainty and determining when factors should be included in the U_{Val} calculation.

5.9.1 RED Bias Factor

The RED bias is a correction factor that accounts for the difference between the UV sensitivity of the target pathogen and the UV sensitivity of the challenge microorganism. If validation testing is performed using two challenge microorganisms whose UV sensitivities bracket those of the target pathogen (i.e., one challenge microorganism is less resistant than the target pathogen and the other is more resistant than the target pathogen), the RED bias is equal to 1.0 (i.e., it can be corrected for, see Section 5.8.1 for details).

If the UV sensitivities of the challenge microorganism and target pathogen are not the same, the RED delivered under the same reactor operating conditions will differ. The magnitude of this difference depends on the following factors:

- The dose distribution of the UV reactor
- The difference between the inactivation kinetics of the challenge microorganism and the target pathogen

If the challenge microorganism is more resistant to UV light than the target pathogen, the RED measured during validation will be *greater* than the RED that would be measured for the target pathogen. In this case, the RED bias would be greater than 1.0. If the challenge microorganism is less resistant (more sensitive) to UV light than the target pathogen, the RED measured during validation will be *less than* the RED that would be measured for the target pathogen. In this case, the RED bias should be assigned a value of 1.0.

The recommended procedure for determining the RED bias is as follows:

1. For the test condition with the lowest UVT, determine the observed *UV sensitivity* of the challenge microorganism for each test replicate using Equation 5.8.
2. Identify the *maximum* UV sensitivity for all test replicates.
3. Use Tables G.1 – G.17 (in Appendix G) to find the RED bias for the target pathogen and target log inactivation, the maximum UV sensitivity, and the lowest UVT. Note that Tables G.1 – G.17 are for discreet UVT values of 85 percent, 90 percent, and 95 percent. RED bias can be interpolated for intermediate values of UVT.

EPA recommends calculating one RED Bias for the UV facility, based on the site-specific application (i.e., minimum operating UVT and target pathogen log inactivation desired), which results in a constant VF for all conditions. As an alternative, the RED bias can be defined as a function of UVT. This alternative may be advantageous for the Calculated Dose Approach where UVT is continually monitored during operations, which means that the VF and the validated dose would vary along with UVT. The disadvantage of using a variable VF is that the UV reactor control system would need to be designed and programmed to do these calculations and that the VF reported to the state will vary (see Section 6.5 for reporting guidance), making operations and reporting more complex.

Values in Tables G.1 – G.17 are based on theoretical dose distributions (as determined by CFD modeling) for several UV reactor designs. Appendix D, Section D.5 provides additional information on the derivation of values in Tables G.1 – G.17. Example 5.4 shows how the RED bias is determined for hypothetical test conditions.

Example 5.4. Determining the RED Bias factor. A UV reactor is validated using MS2 phage for 3-log *Cryptosporidium* inactivation credit. The maximum MS2 phage UV sensitivity for the validation test condition of lowest UVT (86 percent) is 18.0 mJ/cm² per log inactivation. The RED bias from Table G.3 is **1.92**.

5.9.2 Uncertainty in Validation (U_{Val})

The Uncertainty in Validation (U_{Val}), also referred to as the experimental uncertainty, has between 1 and 3 input variables based on how well the validation testing adhered to recommended QA/QC limits in this guidance manual. At least one input variable, which depends on the dose-monitoring strategy of the UV reactor, should be used in all cases.

Figures 5.4 and 5.5 provide decision trees for selecting the appropriate equation for calculating U_{Val} and provide a description of the input variables used for the calculation. The next two sections provide guidance for deriving two of the input variables for U_{Val} , which are U_{SP} (the uncertainty in the setpoint value, which is always calculated for the UV Intensity Setpoint Approach) and U_{IN} (the uncertainty in interpolation, which is always calculated for the Calculated Dose Approach). U_{S} is the uncertainty in UV sensor measurements, expressed as a fraction (e.g., 15 percent, or 0.15) as described in Section 5.5.4. U_{DR} is the uncertainty of the dose-response fit at a 95-percent confidence level. Note that if individual UV dose-response curves cannot be combined and there is more than one U_{DR} value, the maximum value should be used in the decision tree. Additional guidelines for estimating U_{DR} are provided in Section C.4.

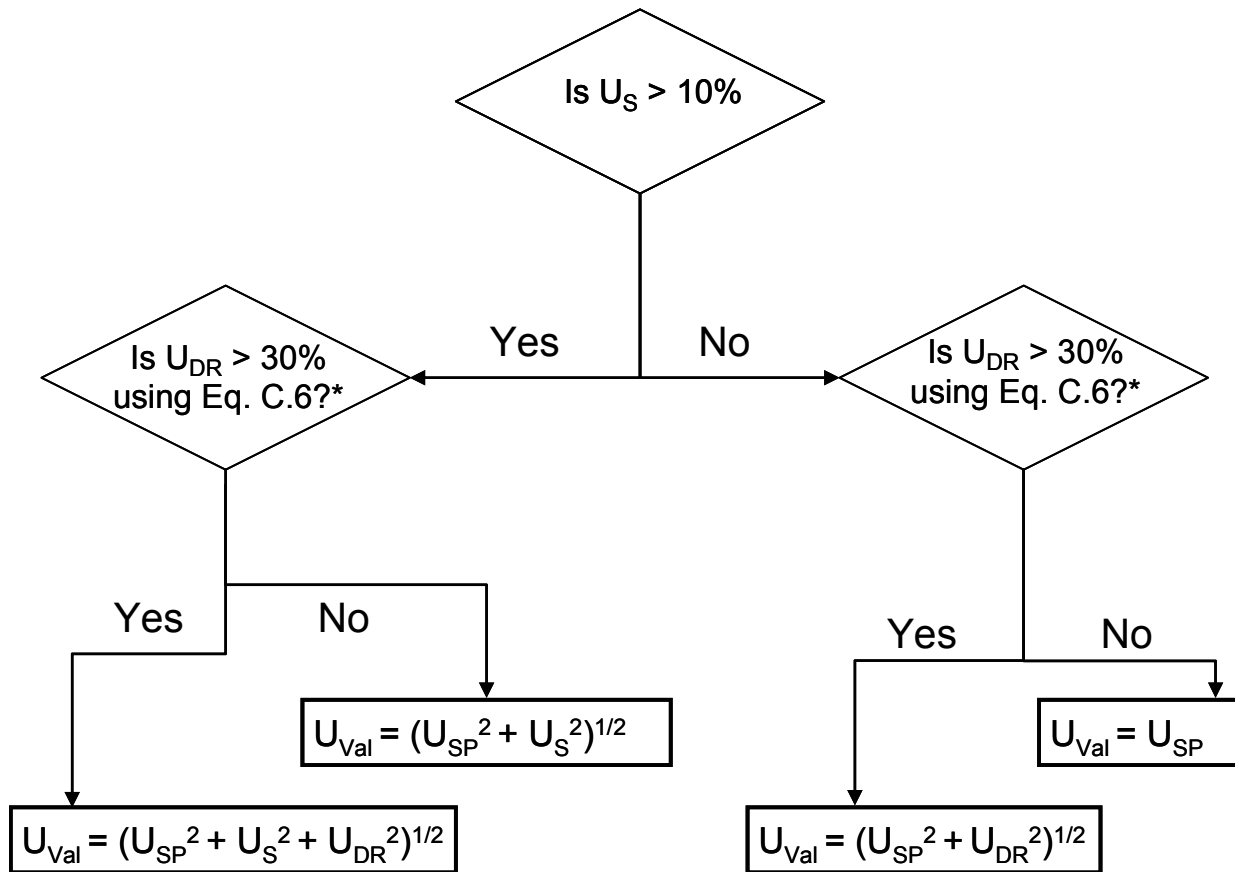
Figure 5.4. U_{VAL} Decision Tree for the UV Intensity Setpoint ApproachWhere:

U_{Val} = Uncertainty of validation (representing experimental uncertainty)

U_S = Uncertainty of sensor value, expressed as a fraction (i.e., if sensor uncertainty = 12%, $U_S = 0.12$. See Section 5.5.4 for guidance on determining sensor uncertainty.)

U_{DR} = Uncertainty of the fit of the dose-response curve, calculated using Equation C.6. If there is more than one U_{DR} value, use the maximum value

U_{SP} = Uncertainty of setpoint, calculated using Equation 5.14 (See Section 5.9.2.1 for additional guidance)

*If U_{DR} is calculated using standard statistical methods instead of using equation C.6, is it > 15%?

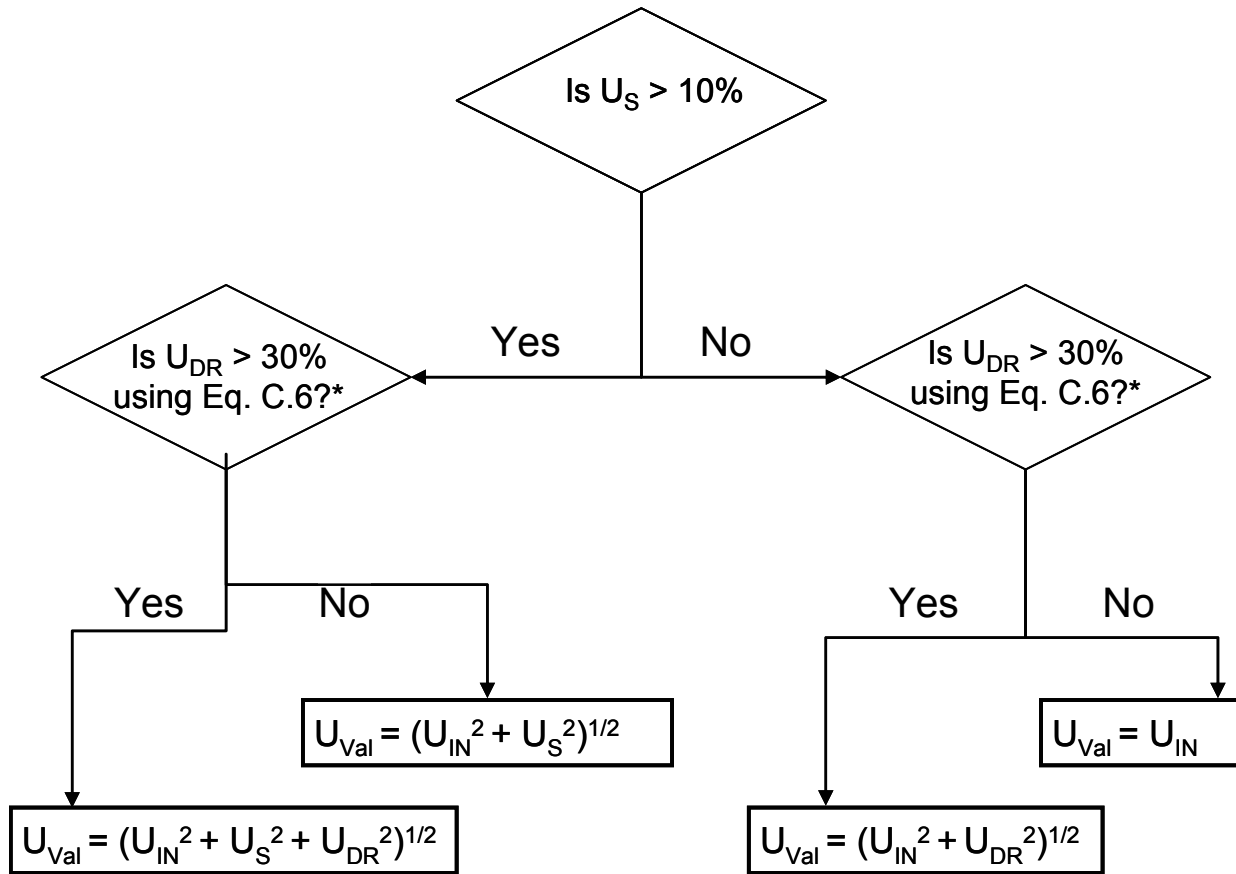
Figure 5.5. U_{VAL} Decision Tree for the Calculated Dose Approach**Where:**

U_{Val} = Uncertainty of validation (representing experimental uncertainty)

U_S = Uncertainty of sensor value, expressed as a fraction (i.e., if sensor uncertainty = 12%, $U_S = 0.12$. See Section 5.5.4 for guidance on determining sensor uncertainty.)

U_{DR} = Uncertainty of the fit of the dose-response curve, calculated using Equation C.6. If there is more than one U_{DR} value, use the maximum value

U_{IN} = Uncertainty of interpolation, calculated using Equation 5.15 (See Section 5.9.2.2 for additional guidance)

*If U_{DR} is calculated using standard statistical methods instead of using equation C.6, is it $> 15\%$?

5.9.2.1 Calculating U_{SP} for the UV Intensity Setpoint Approach

The uncertainty in the setpoint value is based on a prediction interval at a 95-percent confidence level using the following procedure:

1. Calculate the average and standard deviation of RED values for each test condition (typically at least 3 – 5 replicate pairs are generated for each test condition).
2. Calculate the uncertainty of the setpoint RED using:

$$U_{SP} = \frac{t \times SD_{RED}}{RED} \times 100\% \quad \text{Equation 5.14}$$

where:

- RED = Average RED value measured for each test condition
- SD_{RED} = Standard deviation of the RED values measured for each test condition
- t = t-statistic for a 95-percent confidence level defined as a function of the number of replicate samples using the following:

Number of Samples	t
3	3.18
4	2.78
5	2.57

3. Select the highest U_{SP} from all test conditions for calculating the VF.

5.9.2.2 Calculating U_{IN} for the Calculated Dose Approach

For reactors using the Calculated Dose Approach, the uncertainty of interpolation (U_{IN}) is calculated as the lower bound of the 95-percent prediction interval for the dose-monitoring equation. This prediction interval reflects the noise in the data about that fit. In non-statistical terms, the U_{IN} represents the difference between (1) the RED value as derived using measured log inactivation and the UV dose-response curve, and (2) the RED value as calculated using the dose-monitoring equation (also referred to as the “calculated dose” in this manual).

U_{IN} is calculated using the following equation:

$$U_{IN} = \frac{t \times SD}{RED} \times 100\% \quad \text{Equation 5.15}$$

where:

- SD = Standard deviation of the differences between the test RED (based on the observed log inactivation and UV dose-response curve), and the RED calculated using the dose-monitoring equation for each replicate
- RED = The RED as calculated using the dose-monitoring equation
- t = t-statistic at a 95-percent confidence level for a sample size equal to the number of test conditions used to define the interpolation:

Number of Data Points Used to Develop the Dose-Monitoring Equation	t	Number of Data Points Used to Develop the Dose-Monitoring Equation	t
3	3.18	14	2.14
4	2.78	15	2.13
5	2.57	16	2.12
6	2.45	17	2.11
7	2.36	18	2.10
8	2.31	19-20	2.09
9	2.26	21	2.08
10	2.23	22-23	2.07
11	2.20	24-26	2.06
12	2.18	27-29	2.05
13	2.16	≥30	2.04

The value of U_{IN} depends on the calculated RED (or calculated dose), increasing at low calculated RED values. EPA recommends that one U_{IN} be selected that represents the most conservative (largest) uncertainty value calculated for the validated dose operating range (for the lowest calculated RED). Alternatively, U_{IN} can be expressed as a function of the calculated RED.

5.10 Determining the Validated Dose and Validated Operating Conditions

As shown in Figure 5.1 in Section 5.2, the last step in the recommended validation protocol is to adjust the RED results by the VF to determine the Validated Dose for the UV reactor using the following equation:

$$\text{Validated Dose} = \text{RED} / \text{VF} \quad \text{Equation 5.16}$$

Where:

RED = the Minimum RED for the UV Intensity Setpoint Approach; or the RED as calculated using the dose-monitoring equation (also referred to as the calculated dose) for the Calculated Dose Approach

VF = the Validation Factor, as calculated using Equation 5.13

Because the method and assumptions for this step depend on the dose-monitoring strategy of the UV reactor, they are discussed separately below.

5.10.1 Determining the Validated Dose and Operating Conditions for the UV Intensity Setpoint Approach

For the UV Intensity Setpoint Approach, Equation 5.16 produces *one validated dose* for a given UV intensity setpoint corresponding to the minimum RED. When the UV reactor is operating at a UV intensity level above the setpoint, the true UV dose delivered to microorganisms passing through the reactor is always equal to or greater than the validated dose.

The inactivation credit for the target pathogen is determined by comparing the validated dose to the required dose in Table 1.4.

Validated operating conditions are as follows:

- The UV intensity measured by UV sensors must be greater than the UV intensity setpoint.
- The flow rate must be equal to or less than the flow rate tested.
- The lamp status for each lamp (i.e., on/off setting) must be equivalent to the settings used during validation testing.

5.10.2 Determining the Validated Dose and Operating Conditions for the Calculated Dose Approach

For the Calculated Dose Approach, the validated dose varies based on operational parameters. Typically, measured values of UVT, UV intensity, and flow rate are entered into the dose-monitoring equation to calculate RED. RED is divided by the VF to produce the validated dose (Equation 5.16). Although EPA recommends using one VF, an equation may be used for the VF if the RED bias factor is expressed as a function of UVT or if U_{IN} is expressed as a function of RED.

As noted in Section 3.5.2, a key advantage of the Calculated Dose Approach is that water systems can reduce power when UVT is high and/or the flow rate is low as long as the Validated Dose is greater than or equal to the required dose for the target pathogen and log inactivation level. As a reminder, the validated dose must be greater than or equal to the required dose for the target pathogen and target log inactivation level to receive treatment credit.

Validated operating conditions for the Calculated Dose Approach are as follows:

- The operating UVT must be equal to or greater than the minimum UVT evaluated during validation testing.¹³
- The operating flow rate must not exceed the flow rate evaluated during validation testing (*see footnote 13*).

¹³ If the operating UVT measures higher than the maximum UVT evaluated during validation testing, the maximum UVT evaluated during validation testing should be used as the default in the dose-monitoring equation. Similarly, if the operating flow rate measures less than the minimum flow rate evaluated during validation testing, the minimum flow rate evaluated during validation testing should be used as the default in the dose-monitoring equation. See Section 6.1.4 for guidance on setting operational controls.

5.11 Documentation

Prior to validation testing, the water system should work with the manufacturers, third party reviewers, and engineers assisting with or performing validation testing to prepare the following:

- Documentation for the UV reactor
- Validation Test Plan

Once validation testing and the associated data analyses are complete, the UV reactor documentation and Validation Test Plan, along with results of validation testing, should be incorporated into a ***Validation Report***.

The next several sections provide more detailed recommendations on validation testing documentation. Water systems purchasing a pre-validated reactor will not be preparing documentation; however, Sections 5.11.1 through 5.11.3 may be useful as they review validation documentation from manufacturers and consulting engineers. State personnel may also find these sections helpful when reviewing validation reports.

5.11.1 UV Reactor Documentation

Before validation testing, the UV manufacturer should provide the testing party with documentation identifying and describing the UV equipment. Documentation should include all reactor and component information that impacts UV dose delivery and monitoring, as described in Checklist 5.1.

Checklist 5.1 UV Reactor Documentation (Page 1 of 2)**Does UV reactor documentation contain the following elements?****Yes No***General*

- | | | |
|--------------------------|--------------------------|---|
| <input type="checkbox"/> | <input type="checkbox"/> | Technical description of the reactor's UV dose-monitoring strategy, including the use of sensors, signal processing, and calculations (if applicable). |
| <input type="checkbox"/> | <input type="checkbox"/> | Dimensions and placement of all wetted components (e.g., lamps, sleeves, UV sensors, baffles, and cleaning mechanisms) within the UV reactor. |
| <input type="checkbox"/> | <input type="checkbox"/> | A technical description of lamp placement within the sleeve. |
| <input type="checkbox"/> | <input type="checkbox"/> | Specifications for the UV sensor port indicating all dimensions and tolerances that impact the positioning of the sensor relative to the lamps. If the UV sensor port contains a monitoring window separate from the sensor, specifications giving the window material, thickness, and UV transmittance should be provided. |

Lamp specifications

- | | | |
|--------------------------|--------------------------|--|
| <input type="checkbox"/> | <input type="checkbox"/> | Technical description |
| <input type="checkbox"/> | <input type="checkbox"/> | Lamp manufacturer and product number |
| <input type="checkbox"/> | <input type="checkbox"/> | Electrical power rating |
| <input type="checkbox"/> | <input type="checkbox"/> | Electrode-to-electrode length |
| <input type="checkbox"/> | <input type="checkbox"/> | Spectral output of new and aged lamps (specified for 5 nm intervals or less over a wavelength range that includes the germicidal range of 250 – 280 nm and the response range of the UV sensors) |
| <input type="checkbox"/> | <input type="checkbox"/> | Mercury content |
| <input type="checkbox"/> | <input type="checkbox"/> | Envelope diameter |

Lamp sleeve specifications

- | | | |
|--------------------------|--------------------------|--|
| <input type="checkbox"/> | <input type="checkbox"/> | Technical description including sleeve dimensions |
| <input type="checkbox"/> | <input type="checkbox"/> | Material |
| <input type="checkbox"/> | <input type="checkbox"/> | UV transmittance (at 254 nm for LP and LPHO lamps, and at 200 – 300 nm for MP lamps with germicidal sensors) |

Specifications for the reference and the duty UV sensors

- | | | |
|--------------------------|--------------------------|--|
| <input type="checkbox"/> | <input type="checkbox"/> | Manufacturer and product number |
| <input type="checkbox"/> | <input type="checkbox"/> | Technical description including external dimensions |
| <input type="checkbox"/> | <input type="checkbox"/> | Data and calculations showing how the total measurement uncertainty of the UV sensor is derived from the individual sensor properties. (See Table D.1 for an example of the calculation of UV sensor measurement uncertainty from the uncertainty that arises due to each UV sensor property.) |

Checklist 5.1 UV Reactor Documentation (Page 2 of 2)**Does UV reactor documentation contain the following elements?****Yes No***Sensor measurement properties*

- | | | |
|--------------------------|--------------------------|-------------------------------|
| <input type="checkbox"/> | <input type="checkbox"/> | Working range |
| <input type="checkbox"/> | <input type="checkbox"/> | Spectral and angular response |
| <input type="checkbox"/> | <input type="checkbox"/> | Linearity |
| <input type="checkbox"/> | <input type="checkbox"/> | Calibration factor |
| <input type="checkbox"/> | <input type="checkbox"/> | Temperature stability |
| <input type="checkbox"/> | <input type="checkbox"/> | Long-term stability |

Installation and operation documentation:

- | | | |
|--------------------------|--------------------------|---|
| <input type="checkbox"/> | <input type="checkbox"/> | Flow rate, head loss, and pressure rating of the reactor |
| <input type="checkbox"/> | <input type="checkbox"/> | Assembly and installation instructions |
| <input type="checkbox"/> | <input type="checkbox"/> | Electrical requirements, including required line frequency, voltage, amperage, and power |
| <input type="checkbox"/> | <input type="checkbox"/> | Operation and maintenance manuals that include cleaning procedures, required spare parts, and safety requirements. Safety requirements should include information on electrical lockouts, eye and skin protection from UV light, safe handling of lamps, and mercury cleanup recommendations in the event of lamp breakage. |

5.11.2 Validation Test Plan

A validation test plan should document the key components of UV reactor testing. Recommended components of a validation test plan are provided in Checklist 5.2. This list is not meant to be all-inclusive; engineers should document any factors they believe are important for validation testing in their Validation Test Plan.

Checklist 5.2 Key Elements of the Validation Test Plan (Page 1 of 1)**Does the validation test plan contain the following elements?****Yes No**

- Purpose of Validation Testing. General description of why the tests are being done and how the data will be used.
- Roles and Responsibilities. Key personnel overseeing and performing the full-scale reactor testing and collimated beam testing, including their qualifications. This section should include contact names and telephone numbers.
- Locations and Schedule. Location for conducting full-scale reactor testing and collimated beam testing. Planned schedule for conducting the tests and performing the data analyses.
- Challenge Microorganism Specifications. Specifications for the challenge microorganism to be used during validation that include the protocols required for growth and enumeration, the expected UV dose-response, and suitability for use in validation testing.
- Plan for state review (if applicable).

Design of the Biosimetry Test Stand/On-site Testing Facilities

- Inlet/outlet piping design, including backflow prevention
- Mixing
- Sample ports
- Pumps
- Additives (Material Safety Data Sheets for UV-adsorbing chemical, quenching agent)

Collimated Beam Testing Apparatus

- Lamp type
- Collimating tube aperture
- Distance from light source to sample surface
- Radiometer make and model

Monitoring Equipment Specifications and Verification of Equipment Accuracy for the following:

- Flow meters
- UVT analyzers (if used)
- UV Spectrophotometers
- Power measurement
- UV sensors
- Radiometer make, model, and calibration certificates

Experimental Test Conditions including, but not limited to:

- Number of tests, UVT, flow rate, lamp power, and lamp status for each test condition
- Lamp fouling factor, use of new or aged lamps
- Influent concentration of challenge microorganisms for each test condition
- QA/QC Plan

5.11.3 Validation Report

The validation report should provide detailed documentation of all validation testing results. The report should also include all elements of the Validation Test Plan and a summary of the field-verified UV reactor properties.

EPA recommends that the report begin with an executive summary with key information that can be used by states and water systems to assess inactivation credit for the target pathogen(s). The executive summary should include, at a minimum,

- The validated dose or range of validated doses,
- The log credit achieved for the potential target pathogens by the UV reactor, and
- Validated operating conditions (i.e., flow rate, UVT if the Calculated Dose approach is used).

If the UV Intensity Setpoint approach is used, the executive summary should provide the UV intensity setpoint (or setpoints) for the validated dose. If the reactor uses the Calculated Dose Approach as its dose monitoring strategy, the dose-monitoring equation should be provided.

In addition to the items listed above, the executive summary should include the following:

- A brief description of the validated reactor,
- The assumed fouling/aging factors for the reactor and indication if new or aged lamps were used during validation testing,
- A summary of the validation test conditions, including but not limited to the flow rate, UVT, and lamp power for each test condition,
- Key validation test results used to derive the dose, including but not limited to the RED values for each test condition, the UV dose-monitoring equation from collimated beam testing, and the VF,
- A summary of QA/QC checks and results, including UV sensor and radiometer reference checks,
- A description of the validation facilities,
- The organizations conducting the validation test, and
- Names and credentials of the individuals/organizations providing third party oversight.

Recommended contents for the detailed validation report are listed in Checklist 5.3. Note that these recommendations are not intended to be all-inclusive. Engineers should document any test characteristics or outcomes they believe are important in the Validation Report.

Checklist 5.3 Key Elements of the Validation Report (Page 1 of 1)**Does your validation report contain the following elements?****Yes No***General*

- Detailed reactor documentation (see Checklist 5.1), including drawings and serial numbers, and procedures used to verify reactor properties.
- Validation test plan (either a summary of key elements, or the test plan can be attached to the validation report along with documentation of any deviations to the original test plan)

Full-scale reactor testing results, with detailed results for each test condition evaluated. Data should include, but are not limited to:

- Flow rate
- Measured UV intensity
- UVT
- Lamp power
- Lamp statuses
- Inlet and outlet concentrations of the challenge microorganism

Collimated beam testing results, including detailed results for each collimated beam test used to create the UV dose-response equation:

- Volume and depth of microbial suspension
- UV Absorption of the microbial suspension
- Irradiance measurement before and after each irradiation
- Petri factor calculations and results
- Calculations for UV dose
- Derivation of the UV dose-response equation, including statistical methods and confidence intervals (i.e., calculation of U_{DR})

QA/QC Checks:

- Challenge microorganism QA/QC, including blanks, controls, and stability analyses
- Measurement uncertainty of the radiometer, date of most recent calibration, results of reference checks
- Measurement uncertainty of UV sensors and results of reference checks
- Measurement uncertainty of the flow meter, UV spectrophotometer, and any other measurement equipment used during full-scale testing

Calculation of the validated dose, log inactivation credit, and validated operating conditions:

- RED for each test condition
- Calculation of the VF
- Setpoints if the reactor uses the UV Intensity Setpoint Approach
- Dose-monitoring equation if the reactor uses the Calculated Dose Approach
- Log inactivation credit for target pathogens (e.g., *Cryptosporidium*, *Giardia*, and viruses)
- Validated operating conditions (e.g., flow rate, lamp status, UVT)

5.12 Guidelines for Reviewing Validation Reports

State engineers and water systems purchasing pre-validated reactors should review the validation report to confirm the following:

- Validation testing meets the minimum regulatory requirements as summarized in Table 5.1.
- EPA's recommended validation protocol was followed and any deviations from the protocol are adequately justified.
- Validated doses achieved by the UV equipment meet or exceed the target pathogen log inactivation desired.
- QA/QC criteria were met during validation testing.

Checklist 5.4 summarizes the QA/QC recommendations presented throughout this chapter and in Appendix C. If a QA/QC plan was prepared prior to validation, reviewers should request a copy of the plan and make sure it is consistent with industry standards.

Checklist 5.5 contains key elements that should be verified by state or water system personnel when reviewing validation reports. States and systems should keep documentation that these key validation criteria were met.

Checklist 5.4 Review for Quality Assurance/Quality Control (Page 1 of 1)**Yes No***Uncertainty in Measurement Equipment (See Section 5.5 and C.2.2 for more information)*

- Flow Meter:** Is the measurement uncertainty < 5 percent?
- UV Spectrophotometer:** Is the measurement uncertainty \leq 10 percent?
- UV Sensors:** Did duty sensors operate within 10 percent of the average of two or more reference sensors? If not, was uncertainty in sensor measurement incorporated into the VF?
- Radiometer:** (for collimated beam testing only). Do lamp output measurements vary by no more than 5 percent over exposure time? Was the accuracy of the radiometer verified with another radiometer?

QA/QC of Microbial Samples (See Section 5.6.4 for more information)

- Reactor controls:** For influent/effluent samples taken with the UV reactor lamps turned off, does the change in log concentration correspond to a change in RED that is within the measurement error of the minimum RED measured during validation (typically \leq 3 %)?
- Reactor blanks:** For DAILY influent/effluent samples taken with NO challenge microorganisms injected, are the measured concentrations of the challenge microorganism negligible?
- Trip Controls:** For an UNTESTED sample bottle of challenge microorganism stock solution that travels with tested samples between the laboratory and the reactor, is the change in the log concentration of the challenge microorganism within the measurement error. (I.e., the change in concentration over the test run should be negligible. This is typically on the order of 3 to 5%.)
- Method Blanks:** For sterilized reagent grade put through the challenge microorganism assay procedure, is the challenge microorganism concentration non-detectable?
- Stability Samples:** For influent/effluent samples at low and high UVT, are the challenge microorganism concentrations within 5 percent of each other?

Uncertainty in Collimated Beam Testing Data (See Appendix C for more information)

- Do the uncertainties in the terms in the UV dose calculation meet the following criteria:
- Depth of suspension (d) \leq 10 percent
 - Incidence irradiance (E_s) \leq 8 percent
 - Petri factor (P_f) \leq 5 percent
 - $L/(d + L)$ \leq 1 percent
 - Time (t) \leq 5 percent
 - $(1 - 10^{-ad})/ad$ \leq 5 percent
- Is the **uncertainty in dose-response** (U_{DR}), as calculated using equation C.6, less than or equal to 30 percent? If not, was U_{DR} incorporated into the VF?

Checklist 5.5 Review for Key Validation Report Elements (Page 1 of 2)

Yes No

- | | | |
|--------------------------|--------------------------|---|
| <input type="checkbox"/> | <input type="checkbox"/> | Does the validation testing meet QA/QC criteria (see Checklist 5.4)? |
| <input type="checkbox"/> | <input type="checkbox"/> | For full-scale testing, does the mixing and location of sample ports follow recommendations provided in Sections 5.4.3 and 5.4.4, respectively? |
| <input type="checkbox"/> | <input type="checkbox"/> | If the reactor was validated off-site, do inlet/outlet piping conditions at the water treatment plant result in a UV dose-delivery that is the same or greater than the UV dose delivery at the off-site testing facility? (See Section 3.6 for recommended inlet/outlet piping configurations and Section D.6 for considerations for CFD modeling.) |
| <input type="checkbox"/> | <input type="checkbox"/> | Were collimated beam tests and full-scale reactor tests performed on the same day for a given test condition and using the same stock solution of challenge microorganisms? (See Section 5.7 for experimental testing guidelines.) |
| <input type="checkbox"/> | <input type="checkbox"/> | Is the UV sensitivity of the challenge microorganism and the overall shape of the UV dose-response curve consistent with the expected inactivation behavior for that challenge microorganism? See Appendix A of this manual for published UV dose-response curves for MS2 and <i>B. subtilis</i> . |
| <input type="checkbox"/> | <input type="checkbox"/> | Does the validation test design account for lamp fouling and aging, minimum UVT, and maximum flow rate expected to occur at the water treatment plant? (See Section 5.6 for recommended test design.) |

For UV Reactors Using MP Lamps

- | | | |
|--------------------------|--------------------------|---|
| <input type="checkbox"/> | <input type="checkbox"/> | Is the UV reactor equipped with a germicidal sensor? New UV reactors should have germicidal sensors. If an installed reactor uses an MP lamp and a non-germicidal sensor, is a polychromatic bias factor incorporated into the derivation of the VF? (See Section D.4.3 for guidance on the polychromatic bias factor.) |
| <input type="checkbox"/> | <input type="checkbox"/> | Was validation testing conducted using a challenge microorganism other than MS2 or <i>B. Subtilis</i> ? If yes, was the need for a correction factor assessed and was that factor applied based on the outcome? (See Sections 5.3 and D.4.1 for more information) |

For UV Reactors Using the UV Intensity Setpoint Approach

- | | | |
|--------------------------|--------------------------|--|
| <input type="checkbox"/> | <input type="checkbox"/> | Were the minimum test conditions performed as specified in Section 5.6.1? |
| <input type="checkbox"/> | <input type="checkbox"/> | Is the UV intensity setpoint low enough to account for combined conditions of minimum UVT and maximum lamp fouling/aging at the water treatment plant (See Section 5.6.1 for guidance) |
| <input type="checkbox"/> | <input type="checkbox"/> | Was the minimum RED selected for calculating the validated dose? (See Section 5.8.1 for additional guidance.) |
| <input type="checkbox"/> | <input type="checkbox"/> | Does the VF calculation include both the B_{RED} and U_{SP} ? (See Section 5.9 for additional guidance.) |

Checklist 5.5 Review for Key Validation Report Elements (Page 2 of 2)**Yes No***For UV Reactors Using the UV Intensity Setpoint Approach (continued)*

- If U_S and/or U_{DR} did not meet the QA/QC criteria, were they also included in the VF calculation?
- Is the validated dose greater than or equal to the required dose for the water system's target pathogen and log inactivation level?

For UV Reactors Using the Calculated Dose Approach

- Was the minimum number of test conditions evaluated as specified in Section 5.6.2?
- Was the empirical equation developed using standard statistical methods (e.g., multivariate linear regression)? (See Section 5.8.2 for additional guidance.)
- Does the validation report include an analysis of goodness of fit and bias for the dose-monitoring equation? (See 5.8.2 for additional guidance.)
- Does the VF calculation include both the B_{RED} and U_{IN} ? (See 5.9.)
- If U_S and/or U_{DR} did not meet the QA/QC criteria, were they also included in the VF calculation?
- For the range of UVT values and flow rates expected to occur at the water system, is the validated dose greater than or equal to the required dose for the system's target pathogen and log inactivation?

5.13 Evaluating the Need for “Re-validation”

If a UV reactor is modified in a way that significantly impacts UV dose delivery or monitoring (e.g., the wetted geometry changes, the lamp technology changes, the UV sensor characteristics, and/or location change), validation testing should be conducted again (i.e., the UV reactor has been modified enough to be considered a different reactor with unsubstantiated performance). This section discusses some common types of UV reactor modifications and provides guidance on when UV reactors should be “re-validated.”

Lamp Assembly

The relationship between UV dose delivery and monitoring may be impacted by any design change involving modifications to the following lamp components:

- Lamp arc length
- Any reflectors, connectors, and spacers used at the lamp ends
- Lamp envelope diameter
- Lamp envelope UV transmittance from 185 – 400 nm
- Mercury content of the lamp
- Argon content of the lamp

In many cases, UV dose delivery and UV sensor modeling can be used to assess the impacts of changing lamp material and justify the need, or lack of need, for re-validation.

Changes that will modify the UV output so that emitted intensity is uneven along the length of the lamp or around its circumference, however, can have a complex impact on UV dose delivery and would likely warrant re-validation.

Ballasts

Modifications to lamp ballasts include changing the operating voltage, current, frequency, and waveform. Modifications to LP lamps will not impact the relationship between UV dose delivery and UV intensity measurements. With MP lamps, changes in lamp operating temperature and mercury pressure caused by changes in ballast power will impact the spectral distribution of emitted light, resulting in a significant impact on UV reactors with non-germicidal sensors.

If a water system is using non-germicidal sensors, then EPA recommends that the reactor be re-validated if there are modifications to the lamp ballasts that change the operating voltage, current, frequency, and/or waveform.

Lamp Sleeves

Lamp sleeve design changes include changing the sleeve diameter, thickness, and material. Changing the sleeve diameter may significantly impact the hydraulics through the reactor, the measurement of UV intensity, and/or the ideal location of the UV sensors relative to

the lamp. Changing the thickness and material of the lamp sleeve will impact its spectral UV transmittance, thereby impacting both UV dose delivery and UV intensity measurements.

UV dose delivery and UV sensor modeling may be used to assess the impact of lamp sleeve design changes. For example, a design change from a standard sleeve to the ozone-free sleeve described in Figure 5.6 would have a moderate impact on the relationship between UV dose delivery and UV sensor readings with a non-germicidal sensor and a negligible impact with a germicidal sensor. Modeling can also be used to show that the UV dose delivery at a given lamp output, water UVT, and flow rate would be approximately 10 percent greater with the standard sleeve than with the ozone-free sleeve. If the modeling indicates a change in dose delivery of greater than 10 percent as a result of lamp sleeve design changes, EPA recommends that the reactor be re-validated. If it is not possible to model the impact of lamps sleeve design changes, EPA also recommends the UV equipment be re-validated.

Figure 5.6 UVT of Standard and “Ozone-Free” Quartz Assuming Air-Quartz and Quartz-Water Interfaces

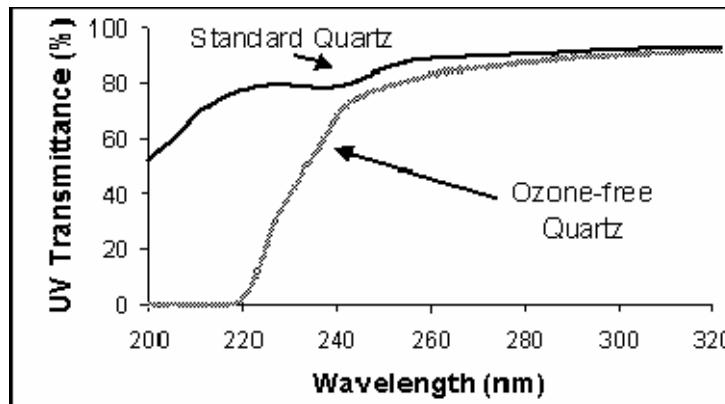

UV Reactor and Component Dimensions

Modifications to the wetted dimensions and positioning of the components within the UV reactor will impact the reactor hydraulics and UV dose delivery. Modifications could also impact the UV intensity field within the reactor and its measurement. Such changes include altering the dimensions of the UV reactor, inlet piping, exit piping, baffles, lamp sleeves, wipers, and/or UV sensors. The impact of such modifications on UV dose delivery and UV intensity measurements can be large or insignificant. Adding a baffle plate will likely have a large impact on UV dose delivery and a small impact on measured UV intensity. Changing the position of a UV sensor will likely have a small impact on UV dose delivery and a large impact on the measured UV intensity.

UV dose delivery and UV intensity modeling may be used to assess the impacts of these modifications. If the modeling indicates a change in dose delivery of greater than 10 percent as a result of changes to the wetted dimensions of the reactor and/or changes in the positioning of components, EPA recommends that the reactor be re-validated. If it is not possible to model the

impact of modification to the wetted dimensions and positioning of components within the UV reactor, EPA recommends the UV equipment be re-validated.

UV Sensors

Modifications to the UV sensors include changes made by the sensor manufacturer to the sensor itself, its housing and its associated optical components, or installation within the reactor. Any modifications that affect the UV sensor response or the flow within the reactor affect should be evaluated to determine their impacts on dose delivery and dose monitoring. For example, if the measurement uncertainty of a new sensor is greater than 10 percent, it should be included in the VF calculations. If the angular response or spectral response of the UV sensor changes, measurements supported by calculations should be used to evaluate the impact of the change on UV dose delivery monitoring.

6. Start-up and Operation of UV Facilities

This chapter describes the start-up activities and routine operational issues associated with a UV disinfection facility. The start-up discussion focuses on the testing performed during the start-up process. The rest of the chapter describes requirements and recommendations for operation, maintenance, monitoring, recording, and reporting for UV facilities. Figure 6.1 illustrates the start-up and routine operation. A detailed description of each activity is provided in this chapter.

Chapter 6 covers:

- 6.1 UV Facility Start-up
- 6.2 Operation of UV Facilities
- 6.3 Maintenance of UV Reactors
- 6.4 Monitoring and Recording of UV Facility Operation
- 6.5 UV Facility Reporting to the State
- 6.6 Operational Challenges
- 6.7 Staffing, Training, and Safety Issues

The guidelines provided in this manual are based on industry experience and manufacturers' recommendations. Because of numerous differences among UV facilities and UV equipment, this document does not address all start-up and operation and maintenance (O&M) issues that may occur.

6.1 UV Facility Start-up

For the purposes of this manual, the start-up of the UV facility is considered as the transition from the construction phase to the operation phase. A start-up plan should be developed in collaboration with the UV facility designer, plant operations staff, and the UV manufacturer. The start-up plans should include O&M manual development, state coordination, functional testing, determination of validated operating parameters, performance testing, and final inspection.

6.1.1 O&M Manual

The O&M manual should be site-specific and based on as-built drawings, manufacturer's shop drawings, operating procedures, operational requirements, recommended maintenance tasks. If performance testing is completed before the O&M manual is finalized, testing results should be included in the manual. If possible, the O&M manual should be developed before performance testing and routine operations. At a minimum, O&M manuals should address the following items:

- Federal and state regulatory requirements and guidelines
- Treatment objectives

Figure 6.1. Start-up and Operation Flowchart¹

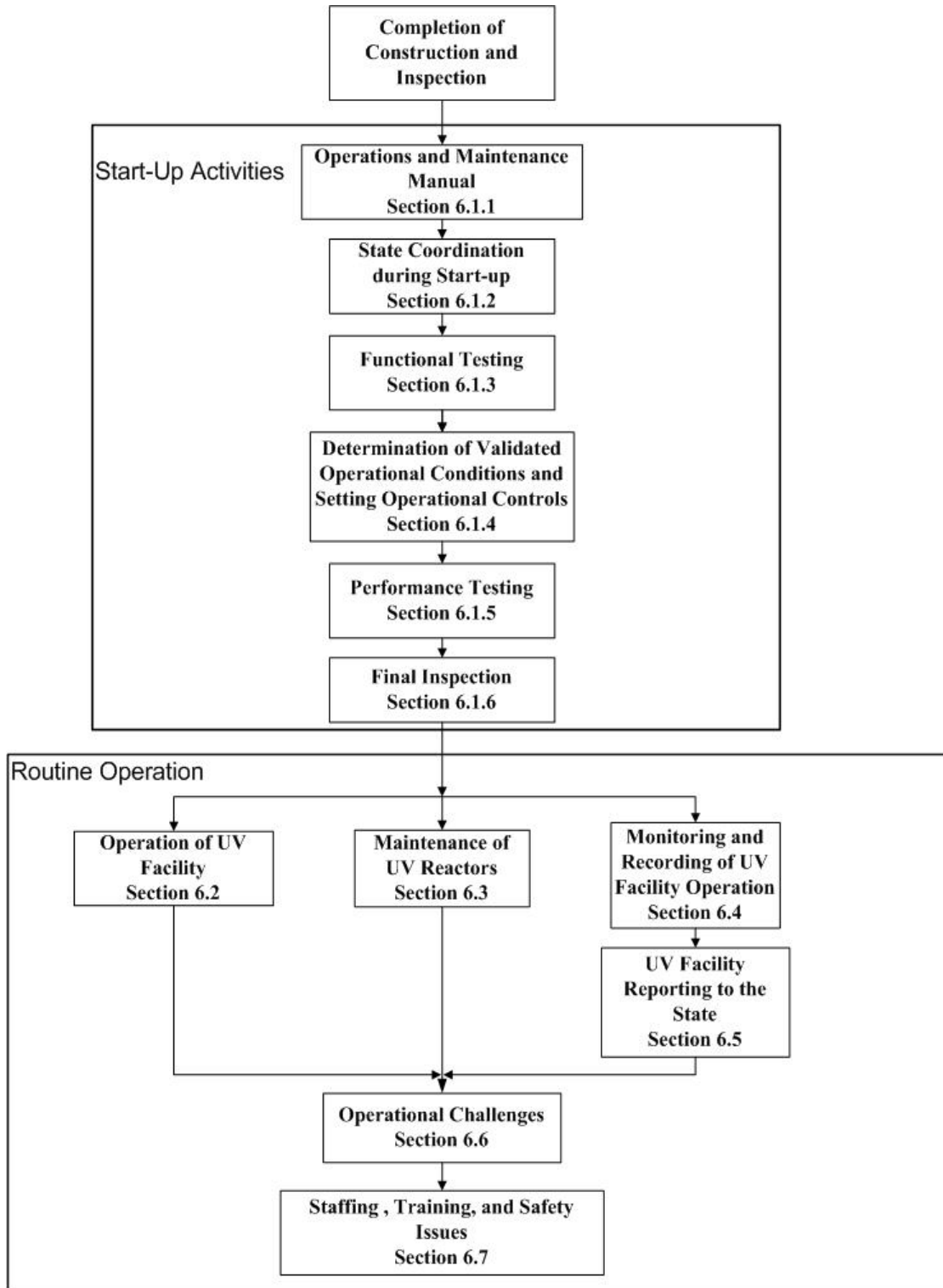

¹ Start-up activities are not necessarily in chronological order.

- General description of UV facility
- Relationship to other unit treatment processes
- UV reactor design criteria
- Validated operational parameters
- Controls and monitoring
- Compliance monitoring, recording, and reporting
- Standard operating procedures
- Start-up procedures
- Shut-down procedures (manual and automatic)
- Safety issues
- Emergency procedures and contingency plan
- Alarm response plans
- Preventive maintenance needs and procedures
- Equipment calibration needs and procedures
- Troubleshooting guide
- Equipment component summary
- Spare parts inventory
- Contact information for equipment manufacturers and technical services

6.1.2 State Coordination during Start-up

States should be contacted during construction to determine the state-specific requirements and submittals. The states may request the record drawings, O&M manual, and an engineer's certificate of completion. In addition, the state may need to visit the site to approve the start-up of the UV facility.

6.1.3 Functional Testing

Functional testing verifies that each component's operation is in accordance with the specifications in the contract documents. It should include verification of UV equipment components, instrumentation and control (I&C) systems, and flow distribution and head loss. Items that are not unique to UV facilities (e.g., valves, flow meters, backup generators, or uninterruptible power supplies) are not described in this manual; however, their functionality should still be verified.

6.1.3.1 Verification of UV Equipment Components

Most functional testing is completed through simulations of specific operating conditions and monitoring UV reactor operation and response. Functional testing entails flooding and energizing UV reactors to confirm the operation of the lamps, ballasts, ballast cooling system, cleaning system, UV sensors, and UVT analyzers.

It is strongly recommended that the UV manufacturer inspect the UV facility before the UV reactors are energized and be present when the UV reactors are first energized. Manufacturers may require the presence of one of their representatives during these activities as a condition of their equipment warranty.

UV Sensor

UV sensors must be included in the UV reactor to verify that the reactor is operating within validated conditions [40 CFR 141.720(d)]. The calibration of the duty and reference UV sensors should be checked during functional testing using the procedure recommended in Section 6.4.1.1. UV sensors that are not in calibration should be returned to the manufacturer for replacement or recalibration.

Lamps, Ballasts, and Ballast Cooling System

The lamps, ballasts, and ballast cooling system operation are verified by energizing the UV lamps, then verifying lamp and ballast operation via the UV sensor measurements and visual verification of the ballast cooling fan operation. In addition, the power [kilowatt (kW)] delivered to the lamps should be verified as the same as documented in the validation report for at least three power settings.

On-line UVT Analyzer

If the dose-monitoring strategy of the UV reactor is the Calculated Dose Approach (see Section 3.5.2 for a description of dose-monitoring strategies), the UV reactor should be equipped with a UVT analyzer. Calibration of the on-line UVT analyzer should be verified. A recommended procedure for verifying calibration is described in Section 6.4.1.2.

Cleaning System

The necessary functional testing depends on the type of cleaning used, and the components to be verified for each cleaning system are summarized in Table 6.1. Cleaning systems are described in Section 2.4.5.

Table 6.1. Functional Testing of Cleaning Systems

Cleaning System	Items to be Verified
On-line mechanical cleaning (OMC)	<ul style="list-style-type: none"> • Smooth movement of the wiper with no jamming or binding of the wiper on the sleeve • Extension of wiper stroke to the full length of the sleeve with no impact at the end of travel that could damage or break the sleeve • Proper operation of the wiper drive mechanism and motor with no slipping or binding
On-line mechanical-chemical cleaning (OMCC)	<ul style="list-style-type: none"> • Same as on-line mechanical cleaning (above) • The chemical injection point is accessible • The seal that contains the chemical solution is intact
Off-line chemical cleaning (OCC)	<ul style="list-style-type: none"> • The chemical injection wand should be connected to the chemical pump to verify that a proper seal is achieved • Outside of the reactor, in a safe location, the chemical pump should be initiated to ensure that the wand is operating properly and an appropriate amount of pressure is achieved • The wand should then be connected to the reactor and turned on to make sure the seal is intact and the wand is functioning properly

6.1.3.2 Verification of Instrumentation and Control Systems

The amount of testing for the instrumentation and control systems depends on the complexity of the dose-monitoring strategy and operations approach used. Testing should include verifying control loops, checking operation functions, and verifying all control actions. As described below, the UV reactors should be run through a series of simulations that represent the possible operating scenarios to confirm that the UV reactor responses are appropriate. A manufacturer representative should be present during the simulations to assist in troubleshooting and addressing any issues that may result from the packaged UV reactor controls.

Typically, the packaged UV reactor control panel contains all the components needed to control and operate the UV reactor. The panel should provide the operating status, lamp status indicators, diagnostic information, and operator interface capability. The panel may also include programmable logic controllers (PLC), ballasts, and lamp starters.

Electronic signal simulations imitate the signals that will be sent to the control system during normal operation. The I&C logic programming should be monitored during simulations to verify the programming is correct. These “dummy” simulations should be used to confirm that UV reactors and all ancillary equipment and instrumentation, including valves, flow meters, and UVT analyzers will operate consistent with the I&C programming. The UV reactors should not operate during these simulations (i.e., water is not flowing and lamps are not energized). As applicable, the following specific operating conditions should be electronically simulated, as well as any other conditions the manufacturer recommends:

- Cold start of the UV reactors
- Cool down and restart of the UV reactor
- Sequencing of the UV reactors in multiple-reactor installations
- Adjustment of lamp intensity or number of lamps on in response to varying water quality and flow rate
- Shut-down of the UV reactors
- Operation of the UV reactors during line power failure (when back-up generators or UPS are available)
- Manual override, safety interlocks, and report generation
- Operation of the UV reactors through the plant SCADA system
- Incorporation of a sensor correction factor

In addition to simulating possible operating conditions, each alarm condition and monitoring function incorporated in the design should be verified. Possible monitoring functions and alarm conditions are discussed in Section 4.3.3 and may include the following conditions:

- Operation outside the validated conditions
 - Low validated dose or UV intensity
 - Low UVT
 - High flow rate
- Lamp age
- Lamp or ballast failure
- Low water level in the UV reactor
- High temperature
- OMC or OMCC system failure
- Loss of control signals

6.1.3.3 Verification of Flow Distribution and Head Loss

A minimum of three flow rates that span the range of operating conditions should be tested. If possible, one condition should be the maximum design flow rate through the UV facility with all duty reactors in operation; the other conditions should consist of combinations of

the reactors operating at their design flow rates (e.g., two of five 10-mgd reactors operating at a total UV facility flow rate of 20 mgd). Clamp-on type flow meters can be used for field verification of the flow split.

The head loss should be measured at these same test conditions for each reactor and compared to the head loss specified in the contract documents (if applicable). Pressure transducers or pressure gauges can be used to measure the head loss.

6.1.4 Determining Validated Operational Conditions and Setting Operational Controls

For each UV reactor, the operating conditions associated with a given level of inactivation credit must be defined based on validation testing results [40 CFR 141.720(d)(2)].

Section 5.10.1 and 5.10.2 describe how the validated dose and validated operating conditions are established for two dose-monitoring strategies, the UV Intensity Setpoint Approach and the Calculated Dose Approach, respectively. Appendix B supports Sections 5.10.1 and 5.10.2 by providing examples of validation testing data analyses. Examples 6.1 and 6.2 expand on guidance in Section 5.10 and Appendix B by showing how the same hypothetical water systems in Appendix B established operational alarms to ensure that they operate within validated conditions.

Example 6.1. Setting Operational Controls for the UV Intensity Setpoint Approach – Single Setpoint Operation (Corresponds to the Validation Example in Section B.1)

Background: System X plans to add UV disinfection to its treatment plant to achieve 2.5-log *Cryptosporidium* inactivation credit. Based on LT2ESWTR UV dose requirements (summarized in Table 1.4 of this manual), the water system needs to meet a required UV dose of 8.5 mJ/cm² to achieve this level of inactivation. During UV facility planning, the water system establishes a design flow of 400 gpm and minimum UVT of 90 percent.

System X selects two low-pressure high-output (LPHO) reactors (one duty and one stand-by) with eight lamps each that use the UV Intensity Setpoint Approach. Because their flow rate and UVT do not vary much, System X decided to use the single setpoint approach that applies to all validated operating conditions.

Summary of Validation Test Results: Validation testing produced a UV intensity setpoint of 11.7 mW/cm² at a maximum flow rate of 394 gpm with a single reactor operating with all lamps turned on. The validated dose at the setpoint is 11.3 mJ/cm², which is greater than the required dose of 8.5 mJ/cm². As long as the UV intensity as measured by the UV sensor is greater than 11.7 mW/cm², the validated dose is greater than the required dose and the reactor is operating within the validated limits.

Operational Controls: As shown in the table below, System X set the UV intensity alarm at 12.5 mW/cm² to provide an operational cushion. System X also set a flow rate alarm at 375 gpm. Because the validation testing protocol for the UV Intensity Setpoint Approach (as described in Chapter 5) accounts for changes in UVT, UVT is not regularly monitored during operations.

Operating Parameter	Validated Operating Conditions	Major Alarm
UV Intensity as measured by the UV sensor	≥ 11.7 mW/cm ²	Sounds if < 12.5 mW/cm ²
Flow rate through the reactor	≤ 394 mgd	Sounds if > 375 gpm

Although this operating strategy is simple and straightforward, System X could have improved efficiency by reducing the UV intensity at lower flow rates, which can only be done if the validation data support UV intensity adjustment with flow. To further improve energy efficiency using the single setpoint approach, the flow could be maximized through one reactor before energizing another reactor for multiple reactor systems.

**Example 6.2. Setting Operational Controls for the Calculated Dose Approach
(Corresponds to the Validation Example in Section B.2)**

Background: System Y plans to add UV disinfection to their treatment plant to achieve 2.0-log *Cryptosporidium* inactivation credit. Based on the LT2ESWTR UV dose requirements (summarized in Table 1.4 of this manual), the water system needs to meet a required UV dose of 5.8 mJ/cm² to achieve this level of inactivation. During UV facility planning, System Y establishes a design flow rate range of 3 to 10 mgd and a minimum operating UVT of 87 percent.

System Y selects three UV reactors (two duty and one stand-by) with six 8-kW medium-pressure (MP) lamps each with power settings ranging from 40 – 100 percent. The reactors have one germicidal UV sensor monitoring each lamp. The reactors were validated for flow ranges of 2.5 – 10 mgd and use the Calculated Dose Approach.

Summary of Validation Test Results: Validation testing as described in Appendix B produced the following dose-monitoring equation (Equation B.14):

$$\log (\text{RED}) = -0.829 - 2.519 \times \log (A_{254}) + 0.166 \times \log \left(\frac{S}{S_o} \right) + 0.409 \times \log \left(\frac{1}{Q} \right)$$

where:

RED = Calculated dose

As noted in the validation report, the Validation Factor (VF) is 2.28. The validated dose is calculated by dividing the calculated dose by the VF. The validated dose must be greater than the required dose of 5.8 mJ/cm² for System Y to receive treatment credit for 2.0 log-inactivation of *Cryptosporidium*.

Operational Controls: The table below summarizes the major alarms that System Y programmed into their PLC to ensure that they operate within validated conditions

Operating Parameter	Validated Operating conditions	Major Alarm ³
Validated Dose (equal to the Calculated Dose / 2.28)	≥ 5.8 mJ/cm ²	Sounds if < 6.3 mJ/cm ²
Flow rate through the reactor	≤ 10 mgd ¹	Sounds if > 9 mgd
UVT as measured by an on-line UVT analyzer	85 - 95% ²	Sounds if <87%

¹ If the flow rate is less than 2.5 mgd, the PLC will default to 2.5 mgd in the dose-monitoring equation.

² If the UVT measured is higher than 95 percent, which is the highest validated UVT, the PLC will default the UVT to 95 percent in the dose-monitoring equation.

³ Note the major alarms are set at a conservative level compared to the validation conditions to give the operators more time to respond to low validated dose, high flows, and low UVTs.

6.1.5 Performance Testing

Performance testing is intended to assess the operating performance of the UV facility as a whole and is generally accomplished through extensive monitoring during the early stages of continuous operation. Note that performance testing is not intended to validate disinfection performance, which is completed during validation testing (as described in Chapter 5). However, performance testing can be used to confirm that the actual operating conditions are within the constraints established during validation testing as described in Section 6.1.4.

Because performance testing should compare operating conditions to validated conditions, the lamps should be operated as they were during validation testing. Therefore, UV lamps should be burned-in before performance testing, which typically takes 100 hours of continuous operation (Section 5.7.2). The actual required burn-in time should be discussed with the manufacturer and confirmed through documented operating experience at other UV facilities.

The scope and duration of performance testing will be project-specific and should be established by the PWS and designer based on the objectives of the performance testing. The duration of performance testing should be adequate to demonstrate to the PWS and the state that the UV facility can continually perform according to specifications in uninterrupted operation. This could be as little as 48 hours, but may be longer, depending upon the nature of the installation, the variability of the source, and any specific state and PWS requirements. Similarly, the scope of the testing may range from an increased monitoring frequency that confirms operation within validated limits to an extensive testing protocol aimed at optimizing reactor performance and establishing long-term operating procedures. During performance testing, treated water may be sent to the distribution system if upstream treatment has not changed, meets existing regulations, and is approved by the state.

Performance testing may include the following items:

- Operation of each UV reactor in automatic mode to verify that the control system is identical to that established during validation testing
- Demonstration of UV reactor start-up and switchover sequences that result from water quality and/or flow rate changes
- Observation of operation, including periods of off-specification operation that arise from alarm conditions and any power quality problems
- Measurement of electrical service voltage, current, and power consumption with different flow and water quality combinations to optimize energy use within the constraints established during validation
- Assessment of the effectiveness of the cleaning system by inspecting sleeve clarity and condition at regular intervals throughout the test period

- Confirmation that the programmed cleaning frequency correlates with the actual frequency of cleaning
- Confirmation of duty UV sensor accuracy using reference UV sensors. (See Section 6.4.1.1.)
- Observation of ballast temperature and cooling system performance
- Verification of the calibration of the on-line UVT analyzer (if applicable). (See Section 6.4.1.2.)
- Confirmation of backup generator and/or UPS power transfer to the UV equipment

The performance testing should be tailored to the specific UV facility. An example monitoring program for a 4-week performance test is shown in Table 6.2.

Any off-specification time and flow volume should be recorded during all performance tests, and these results should be evaluated to verify that off-specification limitations are not exceeded. Off-specification volume during performance testing does not need to be reported to the state. Recording of the off-specification time and volume is meant to identify operational problems to be addressed. During performance testing, any component that is not operating properly should be corrected and retested to confirm satisfactory operation. This step may require manufacturer involvement, especially if specifications in the contract documents were not met. Following performance testing, ongoing monitoring and recording of reactor operation should continue at a reduced frequency as discussed in Section 6.4 and as required by the state.

Table 6.2. Example Monitoring During a Four Week Performance Test

Frequency	Task	Notes
Continuous	Confirm the validated setpoint(s)	Monitor reactor operation to confirm compliance with the setpoint(s) established during validation (Section 6.1.4).
	Develop energy efficient operation	Monitor the power consumption. Test the automatic operation and power consumption under the flow and water quality variations to determine if energy efficiency improvements can be made within the validation constraints.
	Log off-specification occurrences	Log alarms and indicate whether the reactor is off-specification according to validation criteria. Record off-specification time and volume.
Weekly	Monitor UV sensor calibration	Check the duty UV sensor against a reference UV sensor, using the recommended protocol (Section 6.4.1.1) to determine whether the duty UV sensor is in calibration.
	Monitor the on-line UVT analyzer calibration	Monitor calibration of the on-line UVT analyzer (Section 6.4.1.2).
Twice during testing period	Switch to standby reactor	Monitor the time necessary to switch to a standby reactor to determine if operation will be off-specification during switch-over.
	Switch to standby power or UPS	Monitor the time necessary to switch to the standby power supply to determine if operation will be off-specification because of power transfer. Test the backup power supply for a minimum of one hour.
After 4 weeks, 100 OMC or OMCC cycles, or one OCC event	Inspect lamp sleeves for fouling	Remove a sleeve from the reactor and inspect as recommended in Section 6.3.2.1.

OMC = on-line mechanical cleaning; OMCC = on-line mechanical chemical cleaning; and OCC = on-line chemical cleaning.

6.1.6 Final Inspection

As the last step in the start-up process, a detailed inspection of the UV facility should be completed. The inspection should include a visual assessment to verify that all components meet the technical specifications of the UV equipment specification and validation report and that the UV facility was completed in accordance with the construction documents. All UV facility components and associated valves and piping should be thoroughly cleaned and disinfected prior to service.

6.2 Operation of UV Facilities

The operation of UV facilities will vary based on the UV manufacturer, the UV reactor configuration, and the dose-monitoring strategy. This section discusses required and recommended operational and routine start-up and shut-down procedures common to most UV equipment and is general in nature. The site-specific operational procedures should be developed

in coordination with the manufacturer, UV facility designer, and facility operators, and should be described in the O&M manual (Section 6.1.1). Small systems should consider discussing operations with the state to determine if simplified operations are possible.

6.2.1 Operational Requirements

To receive inactivation credit, the UV reactors must operate within the validated limits [40 CFR 141.720(d)]. When a UV reactor is operating outside of these limits, the UV reactor is operating off-specification as described in Section 3.4.1. Filtered and unfiltered systems that use UV disinfection to meet the *Cryptosporidium* treatment requirement of the LT2ESWTR must demonstrate that at least 95 percent of the water delivered to the public during each month is treated by UV reactors operating within validated limits [40 CFR 141.720(d)(3)]. Guidance on determining validated operating conditions is in Section 5.10. The specific monitoring requirements associated with off-specification operation are described in Section 6.4.1.

6.2.2 Recommended Operational Tasks

UV equipment typically uses automatic control systems and does not need significant manual attention for routine operation. Even when UV equipment is operated manually, the only parameter that typically can be controlled is lamp power, and some UV reactors can also vary the number of lamps energized. Therefore, even manual operation does not result in significant operator interaction. Table 6.3 summarizes recommended operational tasks. Recommended maintenance tasks are discussed in Section 6.3.

Table 6.3. Recommended Operational Tasks for the UV Reactor

Frequency	Recommended Tasks
Daily	<ul style="list-style-type: none"> • Perform overall visual inspection of the UV reactors. • Confirm that system control is on automatic mode (if applicable). • Check control panel display for status of system components and alarm status and history. • Verify that all on-line analyzers, flow meters, and data recording equipment are operating normally. • Review 24-hour monitoring data to confirm that the reactor has been operating within validated limits during that period. • Verify that ballast cooling fans are operational and that ballasts are not overheated.
Weekly	<ul style="list-style-type: none"> • Initiate manual operation of wipers (if provided) to verify proper operation.
Monthly	<ul style="list-style-type: none"> • Check lamp run time values. Consider changing lamps if operating hours exceed design life.
Semi-annually	<ul style="list-style-type: none"> • Check ballast cooling fans for unusual noise. • Check operation of automatic and manual valves.

6.2.3 Start-up and Shut-down of UV Reactors

This section describes start-up procedures, shut-down procedures, and winterization of the UV reactors.

6.2.3.1 Routine Start-up

The following routine start-up procedure serves as an example approach. The UV reactors should be operating within validated conditions once the start-up sequence is complete.

1. Initiate the UV reactors' start-up sequence. [Note: Some UV reactors may need reduced water flow to cool the lamps during start-up, which would normally be initiated automatically. The cooling water exiting the reactor is not disinfected and is considered off-specification unless it is diverted to waste.]
2. Check the SCADA panel or other display to verify that the necessary numbers of lamps are on and all of the monitoring parameters are being displayed.
3. Check and resolve any system alarms being displayed.
4. Confirm that all on-line analyzers (UV sensors and UVT analyzers, if applicable) and flow meters are operating within calibration.
5. After the lamp warm-up period, increase flow to the validated range (if flow is not automatically adjusted with UV reactor control sequence).
6. Verify correct flow split between parallel UV reactors using flow meters and/or differential pressure gauges if these devices are available.
7. Verify that the UV reactor is operating within validated limits (e.g., flow rate, UV intensity, lamp status, validated dose).

6.2.3.2 Start-up Following Maintenance

The following additional steps should be taken before completing Steps 1 – 7 described in the example routine start-up procedure (Section 6.2.3.1) when maintenance has been performed on the reactor:

1. Follow site-specific safety procedures for the power supply and control panel (e.g., removing lockouts and tagouts).
2. Confirm that all lamp and ground connections are properly made. Verify that all incoming power conductors, including ground conductors, are properly terminated.
3. Verify that the lamp ends and all other reactor ports are covered and/or sealed to eliminate the potential for operator exposure to UV light.

4. Confirm the breakers are turned on, and all electrical cabinets and equipment are clear and closed.
5. Perform Steps 1 – 5 of Section 6.2.3.1.
6. Verify that all air is purged from the reactors (i.e., the reactor is completely flooded). Check the top of the reactor for heat buildup, which indicates an air pocket.
7. Perform Steps 6 and 7 of Section 6.2.3.1.

6.2.3.3 Routine Shut-down

UV reactors are shut down periodically because of water quality or flow changes. The main steps involved in shutting reactors down are as follows:

1. Throttle the effluent valve (if not part of the control sequence) to close it.
2. De-energize the reactor immediately after the effluent valve is closed.

6.2.3.4 Shut-down Prior to Maintenance

UV reactors are also shut down periodically for maintenance (e.g., cleaning). The following steps should be taken following the routine shut-down steps (Section 6.2.3.3) to prepare a reactor for maintenance:

1. Follow lockout and tagout procedures for the facility.
2. Drain the reactor if necessary for the specific maintenance task.
3. Inspect and repair or replace any necessary equipment.

If extended shut-down time is planned, the reactor should be drained to avoid excessive fouling. After an extended shut-down period (more than 30 days), the operator should perform a cleaning and then inspect the lamp sleeves for fouling. Manual or more extensive cleaning may be necessary before start-up, as described in Section 6.3.2.1.

6.2.3.5 Winterization

In most drinking water applications, the UV reactors will be located within a building. However, in some instances, the reactors may be located in unheated concrete vaults or outside. When shutting down a UV reactor for an extended period of time is necessary and damage from freezing is possible, the UV reactors should be winterized according to the manufacturer's recommendations.

6.3 Maintenance of UV Reactors

No specific regulatory requirements exist for maintaining a UV reactor; however, the UV reactors should be maintained so that disinfection requirements are met. Poor maintenance may cause the UV reactors to operate off-specification for extended periods of time. As part of the maintenance tasks, UV reactor components will need to be replaced; therefore, an inventory of spare parts is necessary. These tasks are described in this section.

6.3.1 Summary of Recommended Maintenance Tasks

Table 6.4 summarizes the recommended maintenance tasks and refers to the general guidelines for those tasks that are discussed in Section 6.3.2. The frequency of performing the maintenance tasks in this section are recommendations and likely will be specific to the UV equipment installed. Therefore, the UV manufacturer should be contacted to determine the appropriate frequency. Items that are not unique to UV facilities (e.g., valves, flow meters, uninterruptible or backup power supplies) are not described; however, maintenance on such items should also be performed per the manufacturer's recommendation. Before maintenance is performed, the operator should wait at least 5 minutes (or as recommended by the UV manufacturer) for the lamps to cool and the energy to dissipate. Lockout and tagout protocol should be followed if the main electrical supply to the UV reactors needs to be disconnected for the maintenance task.

Table 6.4. Recommended Maintenance Tasks¹

Frequency	Task General Guideline & Section Reference	Action
Monthly (no cleaning or OCC) Semi-annually (OMC or OMCC)	Check cleaning efficiency <i>Section 6.3.2.1</i>	<ul style="list-style-type: none"> Record UV sensor reading. Extract one sleeve per reactor (or one sleeve per bank of lamps) for inspection. If fouling is observed on the first sleeve, check remaining sleeves and all UV sensor windows. Manually clean sleeve(s) and UV sensor windows if fouling is observed. Record UV sensor reading after cleaning and compare to original reading.
Monthly	Check reactor housing, sleeves, and wiper seals for leaks	Replace housing, sleeve, or wiper seals if damaged or leaking.
Bimonthly (MP lamps) Quarterly (LP and LPHO lamps)	Check intensity of UV lamps <i>Section 6.3.2.2</i>	If UV sensors monitor more than one lamp, verify that the lamp with the lowest intensity value is closest to the UV sensor by replacing the lamp closest to the UV sensor with one-fourth of the lamps in each row/bank (minimum of three). Place the lowest intensity lamp next to UV sensor.
Semi-annually	Check cleaning fluid	Replenish solution if the reservoir level is low. Drain and

Table 6.4. Recommended Maintenance Tasks¹

Frequency	Task General Guideline & Section Reference	Action
(OMCC)	reservoir (if provided) <i>Section 6.3.2.1</i>	replace solution if the solution is discolored.
Annually	Calibrate reference UV sensor <i>Section 6.3.2.3</i>	Send the reference UV sensor to a qualified facility (e.g., manufacturer) for calibration. Calibration should use a traceable standard (e.g., National Institute of Standards and Technology (NIST), National Physical Laboratory (NPL), Österreichisches Normungsinstitut (ÖNORM), or Deutsche Vereinigung des Gas- und Wasserfaches (DVGW)).
Annually	Test-trip GFI <i>Section 6.3.2.4</i>	Maintain GFI breakers in accordance with manufacturer's recommendations.
When duty UV sensors fail calibration	Replace or recalibrate duty UV sensors <i>Section 6.4.1.1</i>	Send the duty UV sensors to a qualified facility (e.g., manufacturer) for calibration, or replace the duty UV sensors.
Manufacturer's recommended frequency	Check thermometer and/or water level indicator <i>Section 6.3.2.5</i>	Visually inspect thermometer and/or water level monitor and replace at the manufacturer's recommended frequency.
Lamp/ manufacturer specific	Replace lamp <i>Section 6.3.2.6</i>	Replace lamps when any one of the following conditions occurs: <ul style="list-style-type: none"> • Initiation of low UV intensity or low validated dose alarm (UV intensity or validated dose equal to or less than setpoint value) after verifying that this condition is caused by low lamp output. • Initiation of lamp failure alarm after verifying it is not a nuisance alarm.
When lamps are replaced	Properly dispose of lamps <i>Section 6.3.2.6</i>	Send spent lamps to a mercury recycling facility or back to the manufacturer.
Sleeve/ Manufacturer specific	Replace sleeve <i>Section 6.3.2.7</i>	Replace sleeve when damage, cracks, or irreversible fouling significantly decreases UV intensity of an otherwise acceptable lamp to the minimum validated intensity level. Adjust the replacement frequency based on operational experience.
Manufacturer's recommended frequency	Clean UVT analyzer and replace parts <i>Section 6.3.2.8</i>	Clean and replace parts according to manufacturer's recommended procedure.
Manufacturer's recommended frequency	Inspect OMC or OMCC drive mechanism	Inspect and maintain OMC or OMCC drive routinely as recommended by the manufacturer.
Manufacturer's recommended frequency	Inspect ballast cooling fan <i>Section 6.3.2.4</i>	Check the ballast cooling fans for dust buildup and damage. Replace if necessary. Replace air filters (if applicable).

OMC = on-line mechanical cleaning; OMCC = on-line mechanical chemical cleaning; and OCC = on-line chemical cleaning.

¹ Maintenance activities should be consistent with manufacturer's instructions.

6.3.2 General Guidelines for UV Reactor Maintenance

This section describes general guidelines for UV reactor components that relate to maintenance tasks summarized in Table 6.4.

6.3.2.1 Fouling

As discussed in Chapters 2 and 3, the lamp sleeves and UV sensors/windows will likely foul over time, depending on the water quality, lamp type, and cleaning regime. This section describes possible cleaning techniques and provides some specific recommendations for addressing fouling issues.

Sleeve and UV Sensor Surface/Window Fouling

Three types of sleeve cleaning techniques, as discussed in Section 2.4.5, are used: off-line chemical cleaning (OCC), on-line mechanical cleaning (OMC), and on-line mechanical-chemical cleaning (OMCC) methods. The frequency of cleaning is site-specific. An appropriate sleeve cleaning frequency (manual or automatic) can be determined based on the rate of fouling during the start-up period, which can be assessed by monitoring over time the UV sensor measurement or validated dose (Calculated Dose Approach). For routine operation, the cleaning frequency should be increased or decreased based on the amount of fouling left on the sleeves determined from the sleeve inspections and the loss of UV intensity before cleaning.

Sleeves should initially be inspected for fouling every six months if OMC or OMCC is used and every month if OCC or no cleaning is used. This frequency should be adjusted, if necessary, after operating data are available. A decrease in UV intensity or validated dose at a consistent UVT may indicate sleeve fouling, and sleeves should be inspected if fouling is the suspected cause of the UV intensity drop (Section 6.6.1). Additionally, the UV sensor windows (if applicable) should be inspected for fouling and supplemental cleaning should be conducted if necessary, according to the manufacturer's recommendation.

For sleeve inspection, one sleeve per reactor (or one sleeve per bank of lamps for reactors with multiple rows/banks of lamps) should be inspected. The sleeves should be handled as described in Section 6.3.2.7. If damage or fouling is observed, the remaining sleeves should be inspected. External sleeve fouling can be difficult to identify. Sleeve discoloration is more easily seen by placing the sleeve on a clean, white, lint-free cloth next to a new sleeve. The presence of streaks may indicate that the OMC or OMCC wiper material is worn, damaged, or misaligned; therefore, the wiper should also be inspected. If fouling is observed, the cleaning frequency should be increased, and supplemental manual cleaning should be conducted as necessary. The UV reactors need to be drained for sleeve inspection, and the inside of the UV reactor should also be inspected. Any algae that has grown on the surface or any other surface fouling that has occurred should be manually cleaned according to the UV manufacturer's recommended procedure.

Manual cleaning (i.e., beyond routine OCC, OMC, or OMCC cleaning) of lamp sleeves, if necessary, should be according to manufacturer recommendations and procedures. Abrasive

cleaners or pads that might scratch the lamp sleeve should not be used. Also, the inside of the sleeve should be dry before re-installation because water or cleaning solutions could cause a coating to form during operation. One method of drying the sleeve is to use isopropyl alcohol and a lint-free cloth; however, no alcohol should remain inside the sleeve after this procedure. As noted earlier, when the sleeves are re-installed after inspection, the manufacturer's procedure should be closely followed to avoid over-tightening of the compression nuts.

If OMC or OMCC cleaning is used, the wipers should be checked for deformation or degradation at the same time the sleeves are checked. The cleaning solution reservoir in OMCC systems should be checked every six months to determine whether more solution should be added. The solution should be replaced if it is discolored or if the OMCC system is not effectively cleaning the sleeve.

Fouling While Out-of-service

When the UV reactors are out-of-service and full of water, the sleeves may foul (Toivanen 2000). The rate of fouling is site-specific and depends on the water quality. UV reactors equipped with OMC or OMCC should continue to clean the sleeves, potentially at a lower frequency, even though the UV reactor is off-line, which should prevent fouling of the sleeves. For UV reactors that do not include OMC or OMCC, the PWS should consider draining the UV reactor if it is off-line for more than one week. However, this period could be shorter or longer, depending on the water quality. After a shut-down period of more than 30 days, the operator should perform a cleaning (OCC, OMC, or OMCC) and then inspect the lamp sleeves for fouling. Extraction and manual cleaning of sleeves may be necessary before start-up after extended periods of standby.

6.3.2.2 Lamp Output Variability

UV lamp output differs for each lamp, depending on lamp age and lot. As discussed in Section 2.4.6, a UV sensor measures the changes in UV intensity at its location in the UV reactor. However, a UV sensor cannot measure lamp output variability unless each lamp has a UV sensor. PWSs that have UV reactors with a UV sensor monitoring more than one lamp should assess the UV lamp variability every 2 months for MP lamps or every 3 months for LP and LPHO lamps. If all the lamps monitored by a UV sensor are close in age (i.e., their age varies by less than 20 percent), it is not necessary to check the output of each lamp. In this case, the oldest lamp should be placed in the position nearest the UV sensor. The recommended procedure for evaluating the lamp output variability is to:

1. Identify the lamps that can be used to evaluate the lamp variability (one-fourth of the lamps in each row/bank or a minimum of 3 lamps, whichever is greater)
2. Place each evaluation lamp in the position nearest the UV sensor and record the intensity value
3. Repeat Steps 1 and 2 until one-fourth of the lamps (3 minimum) have been assessed

4. Place the lamp with the lowest UV intensity value in the position nearest the UV sensor for routine operation

6.3.2.3 Reference UV Sensors

Accurate UV sensors are necessary to verify adequate UV dose delivery during operation. Two types of UV sensors are available: duty and reference. Duty UV sensors are on-line sensors that continuously monitor UV intensity. Reference UV sensors are off-line sensors used to assess the duty UV sensor performance. Both types of UV sensors need to be maintained. Monitoring of duty UV sensor calibration is described in Section 6.4.1.1.

The reference UV sensor should be calibrated at least once per year at a qualified facility (e.g., manufacturer) to confirm that it is calibrated properly. The reference UV sensor should be calibrated against a traceable standard. For example, UV manufactures are currently using NIST, NPL, ÖNORM, and DVGW standards. The reference UV sensor should be exposed to UV light for a period no longer than necessary to perform the UV intensity measurement. When not in use, the reference UV sensor should be stored under conditions that will maintain its integrity and accuracy as recommended by the manufacturer. Some PWSs may choose to have multiple reference UV sensors to help determine if one reference UV sensor is out of calibration, as a replacement reference UV sensor, or to allow multiple duty UV sensors to be checked simultaneously. Having multiple reference sensors is helpful if the reference and duty sensor measurements do not match because the operator can easily determine which one is in error. If the reference UV sensor is found to be out of calibration, the period between calibrations should be decreased.

6.3.2.4 Electrical Concerns

Typically, power to the UV reactors is provided via a distribution transformer, a circuit breaker, a disconnect switch at the UV reactor, and related wires and conduits. If maintenance on the control panel is necessary, the main electrical supply should be disconnected and the PWS's safety procedures should be followed.

The power to the lamps is typically delivered through individual GFI circuit breakers and ballasts. The GFI breakers should be test-tripped at least once per year and should be maintained in accordance with the manufacturer's recommendations. Ballast output should be monitored through the UV reactor's control panel. Irregularities or instabilities in ballast output may indicate a problem with the electrical feed or the ballast itself.

A ballast cooling system is normally provided with LPHO and MP reactors to maintain the ballast temperature below the maximum specified limit. LP reactors typically do not need ballast cooling. This cooling system should be inspected and maintained as recommended by the manufacturer.

6.3.2.5 UV Reactor Temperature and Water Level

The water temperature or water level in the reactor should be monitored because UV lamps may break if they become overheated (Appendix E). The thermometer and/or water level monitor should be visually inspected and replaced at the manufacturer's recommended frequency. Reactor temperature monitoring and/or water level monitoring are typically included in the packaged control systems for MP reactors, although they may not be included in packaged control systems for LP and LPHO reactors (due to their much lower operating temperatures).

6.3.2.6 UV Lamp Replacement

UV lamp output decreases over time. UV lamps therefore should be replaced periodically to maintain sufficient UV dose delivery. Lamp manufacturers should provide documentation of lamp output decay characteristics and guaranteed life. This information will help the PWS determine the lamp replacement frequency.

The frequency of UV lamp replacement can be based on a PWS-determined schedule, lamp operating hours, or the UV intensity or validated dose reduction. During replacement, the lamps and sleeves should be handled in accordance with manufacturer recommendations, using clean cotton, powder-free latex, or vinyl gloves, because fingerprints can inhibit proper operation.

Because spent UV lamps contain mercury, they are usually considered hazardous waste under Subtitle C of the Resource Conservation and Recovery Act (RCRA) (40 CFR parts 260, 261, 264, and 273). Expended lamps should therefore be sent to a mercury recycling facility where the mercury is recovered and lamp components are recycled. Some UV reactor and lamp manufacturers will accept spent or broken lamps for recycling or proper disposal (Dinkloh 2001, Lienberger 2002, Gump 2002). PWSs should contact the UV manufacturer to determine if they accept spent lamps, or contact their state or local agencies for a list of local mercury recycling facilities.

Replacement lamps should be identical to those used during reactor validation with respect to arc length, internal and external diameter, spectral output, and placement within the quartz sleeve. If the supplied lamps are not equivalent to the lamps used during validation, the UV reactor is not operating as validated and will be considered off-specification. The manufacturer should provide independent data verifying the lamp aging curve over the entire lamp life to show that the new lamps are equal to or better than the validated lamps. However, if a PWS replaces the lamps with higher power lamps to receive higher log inactivation credit, validation testing should be completed to confirm performance.

6.3.2.7 Lamp Sleeves

Lamp sleeves degrade over time due to solarization (Section 2.4.4) and internal sleeve fouling, resulting in cloudiness and loss of UV transmittance. Abrasion of the sleeve surface during handling or mechanical cleaning may also contribute to the loss of UV transmittance. Reduced sleeve transmittance loss is reflected in the UV sensor reading and, therefore, does not

have to be monitored. However, a low UV sensor reading may be due to reduced sleeve transmittance and should be considered when troubleshooting this problem (as discussed in Section 6.6.2).

Sleeves should be replaced when damage, cracks, or staining diminish UV intensity to the point where the minimum validated intensity level or validated dose cannot be met. Sleeves in MP equipment should typically be replaced every 3 to 5 years, although sleeves in LP or LPHO equipment may not need to be replaced as frequently. This replacement frequency should be increased or decreased based on operational experience. Replacement sleeves should be identical to the sleeves used during validation in terms of length, inside and outside diameter, and UV transmittance, and should meet the design and UV manufacturer's material and construction specifications. If the replacement sleeves differ from those used in validation, UV dose delivery and UV sensor modeling can be used to assess the impact of the changes as described in Section 5.13.

The sleeves should be handled in accordance with manufacturer recommendations, using clean cotton, powder-free latex, or vinyl gloves because fingerprints can damage the sleeves during operation. When sleeves are replaced, the manufacturer's procedure should be closely followed because the lamp sleeve can crack and break from over-tightening of the compression nuts that hold it in place.

6.3.2.8 On-line UVT Analyzer

On-line UVT analyzers should be cleaned and maintained according to the UV manufacturer recommendation. On-line UVT analyzer calibration is evaluated periodically as part of compliance monitoring (Section 6.4.1.2).

6.3.3 Spare Parts

The actual life of a component is a function of many variables, including operating conditions, maintenance practices, the quality of the construction materials, and fabrication practices. Consequently, estimating the actual life of every component is impossible. To overcome the operational impacts of this uncertainty, an adequate inventory of critical spare parts should be maintained to ensure reliable and consistent performance of the UV equipment and to avoid the delivery of off-specification water.

All UV equipment components have both a design life and a guaranteed life. The design life is the expected duration of operation. The guaranteed life incorporates the risk, assumed by the manufacturer, to account for the uncertainties associated with the quality of materials used, production, and operating conditions. Generally, guarantees are conditional and are valid under specified operating conditions. For example, guaranteed lamp life is normally linked to the lamp power setting or the number of on/off cycles per 24-hour period. If equipment failure occurs during the warranty period and if all of the warranty conditions are satisfied, the manufacturer will typically replace the component and charge the owner a prorated fee for the use of the replaced component.

Table 6.5 provides typical design and guaranteed lives for major UV reactor components. These represent current industry trends at the time of publication and are likely to change as more O&M information becomes available and technological advances occur. Manufacturers should be contacted directly for details specific to their equipment.

Table 6.5. Typical Design and Guaranteed Lives of Major UV Components (Based on Manufacturers' Input)

Component	Design Life ¹	Guaranteed Life ²
Low-pressure Lamps (LP And LPHO)	12,000 hours	8,000 – 12,000 hours
MP Lamps	8,000 hours	4,000 – 8,000 hours
Sleeve	8 – 10 years	1 – 3 years
Duty And Reference UV Sensors	3 – 10 years	1 year
UVT Analyzer	3 – 5 years	1 year
Cleaning Systems	3 – 5 years	1 – 3 years
Ballasts	10 – 15 years	1 – 5 years

¹ Expected duration of operation

² Accounts for variability of material quality, production, and operating conditions

Following is a suggested minimum inventory of spare parts, expressed as a percentage of the installed number. The complete list of spare parts will vary depending on the specific equipment installed and should be coordinated with the UV manufacturer. The number of spare parts needed depends on the guaranteed life of the specific equipment. For example, a higher percentage of spare MP lamps may be appropriate compared to LP lamps because they need to be replaced more frequently.

- UV lamps – 10 percent with a minimum of two lamps
- Sleeves – 5 percent with a minimum of one sleeve
- O-ring seals – 5 percent with a minimum of two seals
- OMC or OMCC wipers – 5 percent with a minimum of two wipers
- OMC or OMCC wiper drive mechanisms – 2 percent with a minimum of one drive
- Ballasts – 5 percent with a minimum of one unit
- Ballast cooling fan – 1 unit
- Duty UV sensor – minimum of 2 units (adjust number based on operating experience)
- Reference UV sensor – 2 units (more may be needed if wet duty UV sensor are used as described in Section 6.4.1.1)
- On-line UVT analyzer – 1 unit (if used for dose-monitoring strategy)

6.4 Monitoring and Recording of UV Facility Operation

This section discusses the required and recommended monitoring and recording activities for UV facilities. PWSs should always contact their state to identify any state-specific monitoring and reporting requirements and determine when violations of these reporting requirements would occur.

6.4.1 Monitoring and Recording for Compliance Parameters

PWSs must monitor their UV reactors to determine if the reactors are operating within validated conditions. This monitoring must include UV intensity as measured by a UV sensor, flow rate, lamp status, and other parameters designated by the state [40 CFR 141.720 (d)(3)]. UV reactors should also be regularly monitored to diagnose operating problems, determine when maintenance is necessary, and maintain safe operation. In addition to monitoring operational parameters, PWSs must verify the calibration of UV sensors in accordance with a protocol that the state approves [40 CFR 141.720 (d)(3)]. This section describes the requirements for each of these items.

Because UVT is a critical parameter for the Calculated Dose Approach, EPA believes that calibration of UVT analyzers is necessary to determine if reactors are operating within validated conditions. Therefore, this section also includes a discussion of calibration of UVT analyzers.

6.4.1.1 Monitoring of Duty UV Sensor Calibration

Manufacturers will calibrate the UV sensors prior to installation. However, over time the UV sensors will drift out of calibration. Because UV sensors are vital to assessing disinfection performance, water systems *must* verify the calibration of UV sensors with a protocol that the state approves [40 CFR 141.720 (d)(3)]. If a UV reactor is turned on and the calibration of the UV sensors has not been verified, the UV reactor is operating off-specification.

EPA recommends that calibration of UV sensors be verified with a reference UV sensor *at least monthly*. As noted in Section 6.3.2.3, reference UV sensors are off-line UV sensors that should be at least as accurate as the duty UV sensors and should be constructed identically (with any exceptions to the reference sensor to make it more accurate).

Water systems should designate in their protocol whether only the UV sensors in use will be monitored, or if all duty and standby sensors will be monitored to confirm calibration. Verifying calibration of all duty and stand-by UV reactors has the advantage of rendering all UV sensors ready for use at any time if they are needed.

This section describes the recommended procedure to verify UV sensor calibration and the options available if the duty UV sensor fails the recommended calibration criterion. Section 6.6 supports this section by presenting a flowchart of the calibration check procedure to facilitate decisions if the duty UV sensor fails the calibration criterion.

Duty UV Sensor Calibration Evaluation Procedure

To assess the calibration, the following protocol should be followed:

1. Because the calibration of the UV sensor is sensitive to the power level of the lamps (Swaim et al. 2002), set the lamp power to the level typically used during routine operation.
2. Measure the UV intensity with the duty UV sensor and record the measurement result.
3. Replace the duty UV sensor used in Step 2 with the reference UV sensor in the same location (i.e., port).
4. Measure and record the reference UV sensor measurement.
5. Calculate the UV sensor calibration ratio (Equation 6.1). If desired, Steps 2-5 can be repeated, and a mean calibration ratio can be calculated.

$$\text{Calibration Ratio} = \left(\frac{S_{Duty}}{S_{Ref}} \right) \quad \text{Equation 6.1}$$

where:

$$S_{Duty} = \text{Intensity measured with the duty UV sensor (mW/cm}^2\text{)}$$

$$S_{Ref} = \text{Intensity measured with the reference UV sensor (mW/cm}^2\text{)}$$

6. Determine if the UV sensor calibration criterion (Equation 6.2) is met for the two UV sensor readings or the mean calibration ratio.

$$\text{Calibration Ratio} \leq 1.2^{\text{(see footnote 2)}} \quad \text{Equation 6.2}$$

7. If the relationship in Equation 6.2 does not hold true, verify that the reference UV sensor is accurate with a different reference UV sensor (i.e., verify that the duty UV sensor truly failed the calibration check) by inserting a second reference UV sensor and repeating Steps 3 – 6. If a second reference UV sensor is unavailable, the sensor calibration can be checked against two duty sensors (as opposed to another reference sensor).
8. If Step 7 confirms the duty UV sensor is out of calibration, replace the duty UV sensor with a calibrated UV sensor or apply a UV sensor correction factor (described after Example 6.3).

² This calibration ratio is higher than the ratio recommended for validation testing (1.1, or 10%, as presented in Section 5.5.4). A recommended calibration ratio of 1.2 during operations is based on experience with existing UV equipment during routine operations.

9. If a duty UV sensor was replaced, check the replaced UV sensor one hour later by repeating steps 2-6 (or based on UV manufacturer's recommendation) to confirm that the replaced duty UV sensor is operating properly.

Issues to Consider when Monitoring UV Sensor Calibration

The above UV sensor criteria allow the UV facility to operate out of calibration if duty sensor reads conservatively low values compared to the reference sensor. Operating in this manner is not energy efficient, however, and the PWS would benefit from having the UV sensor recalibrated.

When re-inserting a duty UV sensor, the rotational alignment of the UV sensor within the UV sensor port can affect its sensitivity. This effect may be due to the UV sensor configuration (e.g., acceptance angle). The UV sensors should be rotated until the lowest UV intensity reading is obtained for routine monitoring purposes with the UV sensor completely inserted into the UV sensor port. This affect may not be an issue if the UV sensor is keyed in place or another method is used to prevent adjusting the alignment of the sensor.

Wet UV sensors are in direct contact with the water; therefore, the water in the UV reactor needs to be drained before the duty sensors are replaced with reference sensors (Step 3 above). To reduce the number of times the UV reactor needs to be drained, PWSs should own at least the same number of reference sensors as the duty UV sensors in one UV reactor. For example, a UV reactor has six duty wet sensors in each UV reactor; therefore, the PWS owns a minimum of 6 reference UV sensors to reduce the number of times the UV reactor has to be drained during the calibration check procedure.

Example 6.3. Duty UV Sensors are Verified using Reference Sensor (Corresponds to Example 6.1 in Section 6.1.4)

System X has one duty UV reactor and one standby reactor. Each reactor has two banks of four 200-W LPHO lamps with one germicidal UV sensor per bank (i.e., two UV sensors per reactor). The data from a monthly calibration check as presented below show that all of the UV sensors meet the UV sensor calibration criterion. Therefore, the duty UV sensors are in calibration, and no further action is necessary for the UV sensors this month.

Reactor Number	Bank Number for UV Sensor	Duty UV Sensor Reading (mW/cm²)	Reference UV Sensor Reading (mW/cm²)	Calibration Ratio $\left(\frac{S_{Duty}}{S_{Ref}}\right)$	Within UV Sensor Calibration Criterion? $\left(\frac{S_{Duty}}{S_{Ref}}\right) \leq 1.2$
1	1	13.4	14.6	0.9	Yes
1	2	12.6	11.8	1.1	Yes
2	1	11.9	12.5	1.0	Yes
2	2	15.2	13.7	1.1	Yes

Use of UV Sensor Correction Factor

A failed duty UV sensor should be replaced with a calibrated duty UV sensor or the UV reactor is off-specification (if operated). However, replacement may not be an option if multiple UV sensors fail and/or no additional UV sensors are immediately available. PWSs that cannot immediately replace a duty UV sensor that failed the UV sensor calibration criterion (Equation 6.2) should implement a UV sensor correction factor (CF). In this approach, a CF is selected and applied to either the intensity setpoint or required dose setpoint (depending on the dose-monitoring strategy) for the affected UV reactor(s). Operating with a CF is not energy efficient; however, this method enables the UV facility to remain in operation while the UV sensor problem is resolved. The selected CF should not be changed until the failed UV sensors are replaced with factory calibrated UV sensors. **This approach is not recommended for long-term operation, and the UV sensor problem should be resolved as quickly as possible.**

The specific steps for the UV sensor CF approach are summarized below:

1. Use the calibration data to determine the correction factor for each failed UV sensor (Equation 6.3). Note that twenty percent is subtracted from the calibration ratio to account for the acceptable UV sensor error of 20 percent (i.e., Equation 6.2 shows an allowable error of 20 percent). For example, if $S_{Duty} = 138 \text{ W/m}^2$ and $S_{Ref} = 100 \text{ W/m}^2$, the calibration factor is 1.18.

$$\text{Sensor CF} = \left(\frac{S_{Duty}}{S_{Ref}} - 0.2 \right) \quad \text{Equation 6.3}$$

2. Determine the maximum Sensor CF for the failed UV sensors (Equation 6.3) (Example 6.4 below presents an example of how to select a Sensor CF).
3. Multiply the UV intensity setpoint or the required dose (depending on the dose-monitoring strategy) by the UV sensor CF to determine the corrected setpoint or required dose (Equations 6.4 and 6.5) that account for the UV sensor errors.

$$\text{Corrected UV intensity setpoint} = \text{UV intensity setpoint} \times \text{Sensor CF} \quad \text{Equation 6.4}$$

$$\text{Corrected required dose} = D_{Req} \times \text{Sensor CF} \quad \text{Equation 6.5}$$

4. The sensor CF and the corrected UV intensity setpoint or corrected D_{Req} setpoint should be included in the report to the state for the affected reactor(s). These corrected setpoints are now the basis for off-specification operation until the UV sensor calibration problem is resolved.
5. If the failed UV sensor(s) has not been replaced before the next monthly calibration check, the UV reactors with the corrected setpoints should use Equation 6.6 to evaluate whether any sensor exceeds the current Sensor CF. The Sensor CF should be increased if in any UV sensors fail the previous month's CF, as described in Equation 6.6.

$$\left(\frac{S_{Duty}}{S_{Ref}}\right) \leq UV \text{ Sensor } CF + 0.2 \quad \text{Equation 6.6}$$

Example 6.4 shows how a hypothetical water system addressed calibration checks that result in multiple UV sensors that are out of calibration.

**Example 6.4. Duty UV Sensors that Do Not Meet Calibration Criteria
(Corresponds to Example 6.2 in Section 6.1.4)**

System Y has two duty reactors and one standby reactor. Each reactor has six germicidal UV sensors. System Y developed a sensor calibration protocol whereby on a monthly basis, system operators verify that sensors are calibrated using Equation 6.2 of this guidance manual. Their protocol was approved by the state.

Data from the UV sensor calibration check for the month of March are presented below:

Reactor Number	Duty UV Sensor Reading (mW/cm ²)	Reference UV Sensor Reading (mW/cm ²)	Calibration Ratio $\left(\frac{S_{Duty}}{S_{Ref}}\right)$	Within Calibration? $\left(\frac{S_{Duty}}{S_{Ref}}\right) \leq 1.20$	Correction Factor $\left(\frac{S_{Duty}}{S_{Ref}} - 0.2\right)$	Duty UV Sensor Replaced?
1	259.4	247.8	1.1	Yes	NA	No
1	303.8	268.5	1.1	Yes	NA	No
1	284.1	303.5	0.9	Yes	NA	No
1	400.5	387.1	1.0	Yes	NA	No
1	263.2	258.9	1.0	Yes	NA	No
1	258.2	266.6	1.0	Yes	NA	No
2	368.7	250.6	1.5	No	1.3	No
2	404.1	311.5	1.3	No	1.1	No
2	287.9	314.2	0.9	Yes	NA	No
2	299.8	214.9	1.4	No	1.2	No
2	321.3	287.4	1.1	Yes	NA	No
2	265.4	347.5	0.8	Yes	NA	No
3	379.6	284.6	1.3	No	1.1	No
3	357.3	303.9	1.2	Yes	NA	No
3	258.2	281.5	0.9	Yes	NA	No
3	565.5	321.3	1.8	No	1.6	Yes
3	244.4	147.7	1.7	No	1.5	Yes
3	238.9	268.1	0.9	Yes	NA	No

Example 6.4. Duty UV Sensors that Do Not Meet Calibration Criteria (continued)

Six sensors failed calibration with calibration ratios between 1.3 and 1.8; however, System Y has only three spare duty UV sensors. The two worst UV sensors were replaced (i.e., the UV sensors with a calibration ratio of 1.8 and 1.7), and one of the spare UV sensors was retained as a back-up, leaving four UV sensors that failed the calibration criterion. System Y applied the UV sensor CF approach to enable their facility to continue operating until the UV sensor problem could be resolved with the manufacturer.

System Y applied the CF to the individual reactors, not the entire UV facility. For Reactor 2 the highest calibration ratio was 1.5, resulting in a CF of 1.3 (using Equation 6.3). The highest calibration ratio for Reactor 3 (after the two sensors with the calibration ratios of 1.7 and 1.8 were replaced) was 1.3, giving a CF of 1.1.

System Y's required dose is 5.8 mJ/cm^2 for 2.0 log inactivation of *Cryptosporidium*. The corrected required doses for Reactors 2 and 3 are as follows:

- The corrected required dose for Reactor 2 is **7.5 mJ/cm^2** (5.8 mJ/cm^2 multiplied by a CF of 1.3).
- The corrected required dose for Reactor 3 is **6.4 mJ/cm^2** (5.8 mJ/cm^2 multiplied by a CF of 1.1).

System Y maintained a validated dose (i.e., the calculated dose from the dose-monitoring equation divided by the Validation Factor) of 7.5 mJ/cm^2 and 6.4 mJ/cm^2 for Reactors 2 and 3 respectively, until the four duty UV sensors were replaced the following week. If the validated dose had fallen below the corrected required dose, the reactors would have been off-specification. Any off-specification events and the volume of water treated during the event must be reported to the state as described in Section 6.5.

In this example, System Y applied a correction factor for two UV reactors with sensors that failed calibration. Another option for System Y would have been to move all of the UV sensors that require a CF to one UV reactor (i.e., switching out UV sensors between Reactors 2 and 3). In this case, the CF would have only been applied to one of the UV reactors instead of both Reactors 2 and 3.

6.4.1.2 Monitoring of UVT Analyzer Calibration

Compliance monitoring of UVT analyzer calibration is required only when UVT is an integral part of the dose-monitoring strategy, such as with the Calculated Dose Approach. If the UV Intensity Setpoint Approach is used, UVT analyzer calibration checks are not required because UVT is not used to verify UV dose delivery (Section 6.4.1.4).

EPA recommends that on-line UVT analyzers be evaluated *at least weekly* by comparing the on-line UVT measurements to UVT measurements using a bench-top spectrophotometer. The bench-top spectrophotometer should be maintained and calibrated at the frequency required by the manufacturer. The calibration monitoring frequency should be decreased or increased based on the performance demonstrated over a one-year period if approved by the state. For example, the frequency could be reduced to once per month if the UVT analyzer is consistently within the allowable calibration error for more than a month during the first year of monitoring.

To monitor the calibration, the following UVT calibration check protocol should be followed:

1. Record the reading of the on-line UVT analyzer ($UVT_{on-line}$).
2. Collect a grab sample from a location close to the on-line UVT analyzer sampling point.
3. Measure the UVT of the grab sample on a calibrated bench-top spectrophotometer (UVT_{bench}).
4. Compare the on-line UVT ($UVT_{on-line}$) reading to the bench-top spectrophotometer UVT reading using Equation 6.7.

$$\left| UVT_{on-line}(\%) - UVT_{bench}(\%) \right| \leq 2 \text{ percent UVT}^3 \quad \text{Equation 6.7}$$

5. Recalibrate the on-line UVT analyzer if Equation 6.7 is not met. If the UVT analyzer is not recalibrated, the UV facility is operating off-specification unless mitigation steps are taken.

If recalibration is necessary in four consecutive weeks, water system operators should check the calibration daily for 1 week to determine the rate of calibration decay (i.e., the amount the UVT analyzer drifts from the UVT_{bench} per day over the week period). Use these data to establish a more frequent recalibration frequency that will enable the on-line UVT analyzer to stay within the acceptable calibration error. If these data indicate that calibration cannot be maintained for at least 24 hours, water systems should consider one of the two options described below. The UV facility is off-specification until one of these options is followed or until the UVT analyzer meets the criterion shown in Equation 6.7.

Option 1 - Take manual UVT measurements with a calibrated bench-top spectrophotometer every 4 hours and enter the UVT into the PLC. The UVT_{bench} entered should be used for the following 4 hours in the monitoring strategy.

Option 2 - Enter the design UVT value into the PLC and verify daily that the design UVT does not exceed the actual UVT with a grab sample.

³ The absolute value of the difference between the UVT analyzer and bench measurement should be used because both conservative and non-conservative UVT errors can cause inaccuracies with the dose monitoring strategy.

Although these options allow the UV facility to continue operating if the calibration error is exceeded while the on-line UVT analyzer is being repaired or replaced, these options are not intended for long-term operation. These options should not be employed for longer than six months.

Example 6.5 shows how a hypothetical water system confirmed that they met the calibration criteria listed above.

**Example 6.5. UVT Analyzer Calibration Check
(Corresponds to Example 6.2 in Section 6.1.4)**

System Y has a UVT analyzer that shows a $UVT_{\text{on-line}}$ of 93.5 percent. The PWS took a grab sample from the influent line to the UVT analyzer and brought it back to the laboratory. The sample was analyzed for UV absorbance at 254 nm (A_{254}) using a bench-top spectrophotometer that has been properly calibrated. The sample A_{254} is 0.032 cm^{-1} . The grab sample A_{254} was converted to UVT using Equation 2.2, which yields a UVT_{bench} value of 92.9 percent. The absolute difference between the on-line reading and bench spectrophotometer reading was 0.6 percent UVT. This difference was within the calibration error range of 2 percent UVT, and the UVT analyzer did not need to be recalibrated.

6.4.1.3 Off-specification Events

Off-specification operation occurs when the UV facility operates outside of the validated limits (Section 6.1.4), a UV sensor is not in calibration (Section 6.4.1.1), the UVT analyzer is not in calibration (Section 6.4.1.2) (and it is part of the dose-monitoring strategy), or UV equipment is not equivalent or better than the equipment validated.

Validated Parameters

PWSs must monitor each reactor to determine whether it is operating within validated conditions [40 CFR 141.720(d)(3)]. The validated parameters to monitor depend on the dose-monitoring strategy used and the validation results. Table 6.6 presents the monitoring parameters for the monitoring approaches and their off-specification triggers.

Calibration of UV Sensors

A UV reactor is producing off-specification water if all three of the following conditions occur:

1. Any of the duty UV sensors did not meet the calibration criteria in the state-approved protocol (Section 6.4.1.1) and
2. The duty UV sensors were **not** replaced with calibrated duty UV sensors and
3. UV sensor correction factor was **not** applied.

Table 6.6. Off-specification Examples for Each Monitoring Approach

Dose-monitoring strategy	Parameters Monitored	Off-specification Examples
UV Intensity Setpoint Approach	UV intensity, flow rate, lamp status	1. UV intensity below minimum value 2. Flow rate above validated limit
Calculated Dose Approach	calculated dose, VF, validated dose, flow rate, UVT, lamp status	1. Validated dose below D_{Req} 2. Flow rate above validated limit 3. UVT below minimum value

VF = Validation factor

D_{Req} = Required UV dose (Table 1.4)

$$\text{Validated Dose} = \frac{\text{Calculated Dose}}{VF}$$

Calibration of UVT Analyzers

Similarly, the UV facility is off-specification if the UVT analyzer is found to be out of calibration and the remedial actions described in Section 6.4.1.2 are not completed.

UV Equipment Components

The LT2ESWTR requires that water systems use reactors that have undergone validation testing [40 CFR 141.720 (d)(2)]. It follows, therefore, that installed and replaced components should be equal to or better than the components used during validation testing. If not, the UV facility is off-specification unless the UV equipment is re-validated. The need for re-validation and when the UV facility would be off-specification because of UV equipment components is described in Section 5.13.

6.4.1.4 Monitoring and Recording Frequency of Required Parameters

The required dose-monitoring parameters (flow rate, UV intensity, number of banks on, etc.) should be continuously monitored (i.e., at least every 5 minutes) for each UV reactor, and these values should be recorded at least once every 4 hours. Very small systems (e.g., systems serving fewer than 500 people) that cannot record reactor status every 4 hours (e.g., manual recording is practiced) could consider a reduced recording frequency; however, the frequency should not be less than once per day and should be discussed with the state.

All water systems should record off-specification alarms at a minimum of 5-minute intervals until the alarm condition has been corrected. The off-specification volume will start as soon as the flow is found to be outside of the validated range. The measurement of off-specification volume will stop as soon as the flow is shown to be within the validated limits.

The EPA recognizes that the off-specification event may begin before the off-specification alarm is monitored. The off-specification event may also end before the off-specification alarm is cancelled and recorded. It is assumed that over time the underestimation of off-specification water before the alarm is activated and the overestimation of off-specification water before the alarm is cancelled will minimize any errors in the calculation of off-

specification water. If a facility monitors more frequently than the minimum recommended 5-minute intervals, the off-specification volume will start as soon as the reactor is monitored as operating off-specification and the off-specification volume will stop as soon as the reactor is monitored as being on-specification. More frequent off-specification alarm monitoring may more accurately account for the off-specification volume.

These off-specification alarm records should be used to determine the percentage of flow volume that is off-specification. The compliance with the off-specification limits is based on the off-specification percentage for the UV facility, not for individual reactors. The monitoring guidelines are summarized in Table 6.7, and Example 6.6 illustrates the routine and off-specification recording recommendations.

Table 6.7. Recommended Recording Frequency for Required Monitoring Parameters

Parameter	Recommended Recording Frequency	Notes
Off-specification Alarm	Minimum of every 5 minutes	Recording should continue until the alarm condition has been corrected.
UV Intensity	Every 4 hours	The UV intensity must be greater than or equal to the validated setpoint.
UVT ¹	Every 4 hours	The UVT must be greater than or equal to the minimum UVT validated.
Validated Dose ¹	Every 4 hours	The validated dose must be greater than or equal to the D_{Req} .
Lamp Status	Every 4 hours	Lamps should be energized if water is flowing through the UV reactor.
Flow Rate	Every 4 hours	The flow rate should be less than or equal to the maximum flow tested in validation.
Production Volume	Off-specification events and monthly total	The production volume needs to be recorded so the off-specification compliance calculation can be completed.
Calibration of UV Sensors	Monthly	The calibration of the UV sensor should be monitored as described in Section 6.4.1.1.
Calibration of On-line UVT Analyzer ¹	Weekly ²	The calibration of the UVT analyzer should be monitored as described in Section 6.4.1.2. ¹

¹ Required only if necessary for the dose-monitoring strategy (i.e., the Calculated Dose Approach).

² Frequency could be reduced as described in Section 6.4.1.2.

**Example 6.6 Routine and Off-specification Recording
(Corresponds to Example 6.2 in Section 6.1.4)**

This example illustrates System Y's daily monitoring and recording of UV equipment operation to verify that it is operating within validated limits. The System Y has two duty reactors and one standby. Reactor 1 is used only for part of the day; Reactor 2 is used 24 hours a day; and Reactor 3 is off-line in the 24-hour period. System Y monitors the off-specification alarms every 5 minutes, which is the minimum recommended.

At 1:08 PM the flow at System Y went above the validated range because an upstream filter was taken off-line for backwashing. At 1:10 PM, the flow through Reactor 2 **was recorded** as being above the validated limit of 10 mgd as an off-specification alarm. This resulted in the reactor operating off-specification while the flow split between the reactors was adjusted. The flow returned to within the validated range at 1:17 PM when the backwashed filter was placed back on-line. System Y recorded that the off-specification alarm was remedied at 1:20 PM

The off-specification recording started when the first off-specification alarm occurred (1:10 PM) and continued at 5-minute intervals until the reactor was monitored as being on-specification again (1:20 PM) when the data recording reverted back to every 4 hours. This event is illustrated in the table below. During this 24-hour period, no other off-specification events occurred. If System Y monitors the off-specification alarms at 1 minute intervals, the off-specification operation would have been more accurately recorded.

Example 6.6 Routine and Off-specification Recording (continued)

Monitoring	Reactor 1		Reactor 2		Reactor 3	
Time	Reactor Status	Data Recorded	Reactor Status	Data Recorded	Reactor Status	Data Recorded
12:00 AM	Off	Off-line	On-specification	On-specification	Off	Off-line
...	Off	None	On-specification	None	Off	None
4:00 AM	Off	Off-line	On-specification	On-specification	Off	Off-line
...	Off	None	On-specification	None	Off	None
8:00 AM	On-specification	On-specification	On-specification	On-specification	Off	Off-line
...	On-specification	None	On-specification	None	Off	None
12:00 PM	On-specification	On-specification	On-specification	On-specification	Off	Off-line
...	On-specification	None	On-specification	None	Off	None
1:05 PM	On-specification	None	On-specification	None	Off	None
1:10 PM	On-specification	None	<i>Off-specification</i>	<i>Off-specification</i>	Off	None
1:15 PM	On-specification	None	<i>Off-specification</i>	<i>Off-specification</i>	Off	None
1:20 PM	On-specification	None	On-specification	On-specification	Off	None
...	On-specification	None	On-specification	None	Off	None
4:00 PM	On-specification	On-specification	On-specification	On-specification	Off	Off-line
...	On-specification	None	On-specification	None	Off	None
8:00 PM	On-specification	On-specification	On-specification	On-specification	Off	Off-line
...	On-specification	None	On-specification	None	Off	None
12:00 AM	On-specification	On-specification	On-specification	On-specification	Off	Off-line
Daily total off-specification events		0 events		1 event lasting 10 minutes		0 events

Note shaded areas indicate data that were recorded.

Example 6.6 Routine and Off-specification Recording (continued)

The off-specification volume of water must be determined for compliance reporting (Section 6.5). The table below provides the flow and volume monitoring and recording for this example day. The volume was calculated using a flow totalizer in the PLC programming for each 5-minute off-specification period.

Monitoring Time	Reactor 1			Reactor 2		
	Flowrate ¹	Volume ²	Total Daily Volume	Flowrate ¹	Volume ²	Total Daily Volume
	(mgd)	(gal)	(gal)	(mgd)	(gal)	(gal)
12:00 AM	0	-	-	9.2	1,526,782	9,144,269
...						
4:00 AM	0	-	-	9	1,358,972	1,358,972
...						
8:00 AM	7.2	1,120,254	1,120,254	9.3	1,534,682	2,893,654
...						
12:00 PM	7.4	1,225,897	2,346,151	9.5	1,510,036	4,403,690
...						
1:10 PM	NR ³	NR ³		12.2		4,870,357
1:15 PM	NR ³	NR ³		11.3	38,452	4,908,809
1:20 PM	NR ³	NR ³		9.7	37,522	4,946,331
...						
4:00 PM	7	1,102,564	3,448,715	9.4	1,551,123	5,954,813
...						
8:00 PM	7.2	1,025,951	4,474,666	9.2	1,520,321	7,475,134
...						
12:00 AM	7.3	1,159,951	5,634,617	9.3	1,536,987	9,012,121
Total Daily Off-specification volume (gal)		-			75,974	
Total Daily Volume (gal)		5,634,617			9,012,121	

Note shaded areas indicate data that were recorded.

¹ Maximum flow rate was recorded to show the flow was within validated limits.

² Volume was estimated in the PLC using the flow rate.

³ NR indicates that data were not recorded

Example 6.6 is based on the flow rate's increasing beyond the validated range. Off-specification recording would follow the same procedure for any problem resulting in off-specification time (e.g., UV sensor failure or the UVT decreased beyond the validated range).

6.4.2 Monitoring and Recording for Operational Parameters Not Related to Compliance

To minimize operational problems, facilitate regulatory compliance, and evaluate UV reactor performance, parameters in addition to those required for regulatory compliance should be monitored. Table 6.8 presents these suggested parameters and the recommended recording frequency. These parameters and their monitoring frequency should be adjusted based on site-

specific operating experience. For example, if sleeve fouling is a maintenance issue and supplemental cleaning is frequent (e.g., monthly), the fouling parameters should be monitored daily as shown in Table 6.7 rather than weekly.

Table 6.8. Recommended Monitoring Parameters and Recording Frequency

Parameter	Monitoring Frequency	Recording Frequency	Notes
Power Draw	Continuous	Every 4 hours	This information can be used to determine the most energy efficient operation strategies.
Water Temperature (Only Necessary for MP Reactors)	Continuous	Daily	Monitoring is important to verify that the high temperature limit is not exceeded (often part of packaged UV control system).
UV Lamp On/Off Cycles	Continuous	Weekly (Total cycles in a week)	The number of on/off cycles can help assess lamp aging.
Turbidity (In Addition to Monitoring Otherwise Required Under Subpart H)	Daily	Weekly	Recommended only if chemicals (e.g., lime) are added prior to UV disinfection. Monitoring may not be necessary for many UV facilities.
pH, Iron, Calcium, Alkalinity, Hardness, ORP	Weekly (reduce if fouling is not prevalent)	Weekly	These parameters will help assess fouling issues if necessary.
UVT Analyzer Calibration ¹	Weekly (reduce if appropriate based on operational experience)	Weekly	This information can assist in planning scheduled maintenance and the O&M budget.
Operational Age ² of the Following Equipment: <ul style="list-style-type: none"> • Lamp • Ballast • Sleeve • UV Sensor 	Monthly	Monthly	This information can assist in planning scheduled maintenance and the O&M budget.
Calibration of Flow Meter	Monthly	Monthly	This information can assist in planning scheduled maintenance and the O&M budget.

¹ Recommended if not being monitored as discussed in Section 6.4.1.2

² Operational age is the amount of time the equipment has been operated (e.g., lamp hours)

6.5 UV Facility Reporting to the State

Monthly reports must be prepared and submitted to the state (CFR 141.721). This section describes the required reporting and provides example reporting forms.

6.5.1 Required Reporting

The report must include the percentage of off-specification water for the UV facility and the UV sensor calibration monitoring [CFR 141.721(f)].

The percentage of off-specification water should be calculated on a volume basis. The percentage should be calculated by totaling the 5-minute off-specification alarm records and associated volume released during those periods for each reactor. The volume released during the off-specification event can be determined by:

- Using a flow totalizer that automatically records the volume when an off-specification event occurs.
- The PLC calculating the volume based on flow rate in one-minute (or shorter) intervals during the off-specification event.
- The PLC calculating the volume based on the maximum flow during the off-specification period multiplied by the length of time of the off-specification event.

Off-specification time can be used a surrogate for off-specification volume only if the flow is constant and this method is approved by the state.

The total off-specification volume for all UV reactors should be divided by the total volume produced by the UV facility that month and multiplied by 100 percent (See Example 6.7). PWSs with constant flows may use off-specification time as an indicator for off-specification volume (i.e., total off-specification divided by time in operation multiplied by 100 percent). SCADA and PLC interfaces can be designed to automatically calculate off-specification based on the required monitoring, recording, and reporting.

**Example 6.7. Off-specification Computation
(Corresponds to Example 6.6 in Section 6.4.1.4)**

This example illustrates the computation of monthly percent off-specification operation for System Y in Example 6.6. System Y had no other off-specification events this month; therefore, the table in Example 6.6 captures all off-specification volume for the month. To determine percent off-specification volume, monthly production volume totals were obtained from the SCADA system. The table below shows the data used for the computation. In this example, 0.02 percent (75,974 gal / 305,683,189 gal × 100%) of the volume of water System Y treated was off-specification, which is within the allowable regulatory limit of 5 percent.

Reactor No.	Monthly Total Off-specification for UV Facility		Monthly Total Production for UV Facility		Monthly Percent Off-specification ²
	Time (hr)	Volume (gal) ¹	Time (hr)	Volume (gal)	
1	0.00	0	168	17,568,080	
2	0.17 ³	75,974	720	288,115,109	
3	0.00	0	0	0	
Totals	0.17³	75,974	888	305,683,189	

¹ Off-specification volumes are from Example 6.6.

² Total monthly off-specification volume divided by total volume produced in the month multiplied by 100 percent

³ Total monthly off-specification time was shown in Example 6.6 to be 10 minutes (0.17 hr).

The percentage of UV sensors that were checked for calibration must be reported monthly. All UV sensors in operation that month should be checked. Additionally, the daily low validated dose or daily low UV intensity, depending on the dose-monitoring strategy, should be reported to the state monthly. The state may also have additional reporting requirements and should be contacted to determine the specific content of the monthly reports and to coordinate with other reporting requirements.

6.5.2 Example Reporting Forms and Calculation Worksheets

Example forms and calculation sheets are shown in Figures 6.2 through 6.8. The state should be contacted to determine whether these forms will be acceptable. The forms are described in greater detail below. Two calculation worksheets are also provided that can assist with completing the compliance forms; these forms need not be submitted to the state.

Figure 6.2 is an example of a summary report that would be completed by the PWS and submitted to the state on a monthly basis.

Figures 6.3 and 6.4 are example operating logs that would be completed on a daily basis for the calculated dose and UV Intensity Setpoint Approach, respectively. The forms would be used to record the operating status of the UV equipment and to record the volume of water discharged during off-specification operation each day. The state may request that this information is submitted on a monthly basis.

Figure 6.5 is an off-specification calculation worksheet that can assist PWSs with calculating the off-specification percentage for the daily logs (Figures 6.3 and 6.4); this form need not be submitted to the state.

Figure 6.6 is an example duty UV sensor calibration log. This log would be completed whenever UV sensor calibration checks are performed. The log would be used to record the results of the calibration testing and to track any UV sensor recalibration or repair work that was completed. The state may request this information to be submitted on a monthly basis.

Figure 6.7 is a UV sensor CF calculation worksheet that can help PWSs determine the appropriate UV sensor CF when the PWS needs to use this approach to stay in compliance. This form need not be submitted to the state.

Figure 6.8 is an example on-line UVT analyzer calibration log. This log would be completed only by those PWSs that have included on-line UVT analyzers as part of their dose-monitoring strategies. The log would be completed whenever UVT analyzer calibration checks are performed. The log would be used to record the results of the calibration testing and to track any recalibration or repair work that was completed. The state may request this information to be submitted on a monthly basis.

Figure 6.2. Example Summary Monthly Report

Reporting Period: _____ System/Treatment Plant: _____ PWSID: _____ Signature of Principal Executive: _____ Officer or Authorized Agent: _____	Date: _____ Date: _____	Off-Specification Data		
Unit Number	Total Run Time (hrs)	Total Production (MG)	Number of Off-Specification Events	Total Off-Specification Volume (MG)
Total				
Compliance Certification				
Total Volume of Off-Specification Water Produced (MG) [A] _____				
Total Volume of Water Produced (MG) [B] _____				
Total Off-Specification Water Produced (% of Volume of Water Produced) $([A]/[B]*100)$ _____				
Facility Meets Off-Specification Requirement (< 5% of Volume on a Monthly Basis) (Y/N) _____				
Of the _____ sensors, _____ have been checked for calibration and _____ were within the acceptable range of tolerance.				
The Following Reactors had a Sensor Correction Factor				
Reactor Number	Sensor Correction Factor			

Figure 6.3. Example Daily Operating Log for Calculated Dose Approach

Reporting Period: _____

System/Treatment Plant: _____

PWSID: _____

UV Reactor: _____

Process Train: _____

Operator Signature: _____

Date: _____

Maximum Validated Flow Rate: _____

Minimum Validated UVT: _____

Target Log Inactivation: _____

Target Pathogen: _____

Dose Required (D_{req'd}): _____

Validation Factor (VF): _____

Calculated Dose

$$\text{Validated Dose} = \frac{\text{Calculated Dose}}{\text{VF} \times \text{CF}}$$

Calculated Dose = Dose that is calculated by validated PLC algorithm

VF = Validation factor

CF = UV intensity sensor correction factor.

The CF is only applied if sensors do not meet recommended criteria (NOTE – a CF will not be needed in most cases)

Operational Data		Dose Requirements		Data at Daily Minimum Validated Dose				UV Dose Adequacy Determination	Total Off-Specification	
Day	Run Time (hrs)	Total Production (MG)	D _{req'd} ¹ (mJ/cm ²)	Sensor Correction Factor ² [B]	Calculated Dose ³ (mJ/cm ²) [C]	Daily Minimum Validated Dose ⁴ (C)/[VF]/[B] (mJ/cm ²) [D]	Flow Rate (MGD)	UVT (%)	Validated Dose > (D) > [A] (Y/N)	Total Off-Specification Volume (MG)
1										
2										
3										
4										
5										
6										
7										
8										
9										
10										
11										
12										
13										
14										
15										
16										
17										
18										
19										
20										
21										
22										
23										
24										
25										
26										
27										
28										
29										
30										
31										
Min										
Max										
Total										

¹ D_{req'd} is the dose required for the target log inactivation without a VF or Sensor CF applied and can be found in the UVDSM Table 1.4.

² Sensor CF will be 1 if no CF is used

³ Calculated dose is calculated using the dose algorithm in the PLC.

⁴ The Validated Dose is the dose based on the calculated dose that is normalized on the Validation Factor and Correction Factor

⁵ Off-specification worksheet (Figure 6.5) should be used to calculate daily off-specification volume. If UVT, flowrate, and/or Validated Dose off-specification occur simultaneously, the off-specification time should only be counted once

Figure 6.4. Example Daily Operating Log for UV Intensity Setpoint Approach

Reporting Period: _____

System/Treatment Plant: _____

PWSID: _____

UV Reactor: _____

Process Train: _____

Operator Signature: _____

Date: _____

Maximum Validated Flow Rate: _____

Minimum Validated UVT: _____

Target Log Inactivation: _____

Target Pathogen: _____

Intensity Setpoint: _____

Day	Operational Data			Intensity Requirements			Daily Minimum Intensity		Total Flow Off-Specification
	Run Time (hrs)	Total Production (MG)	Flow Rate	Intensity Setpoint (W/m ²) [A]	Sensor Correction Factor ¹ [B]	Adjusted Intensity Setpoint (W/m ²) ([A] * [B]) [C]	Daily Minimum Intensity (W/m ²) [D]	Minimum Daily Intensity > Adjusted Intensity Setpoint (D) > [C] (Y/N) [E]	
1									
2									
3									
4									
5									
6									
7									
8									
9									
10									
11									
12									
13									
14									
15									
16									
17									
18									
19									
20									
21									
22									
23									
24									
25									
26									
27									
28									
29									
30									
31									
Min									
Max									
Total									

¹ Sensor CF will be 1 if no CF is used.

² UVT measurements are not required but could be useful in addressing operational issues.

³ Off-specification worksheet (Figure 6.5) should be used to calculate daily off-specification volume. If UV intensity or flowrate off-specification occur simultaneously, the off-specification time should only be counted once.

Figure 6.5. Example Off-specification Calculation Worksheet

Reporting Period: _____
 System/Treatment Plant: _____
 PWSID: _____

Operator Signature: _____
 Date: _____

Off-Specification Calculation Worksheet (Note - This sheet should only be used when an off-specification event occurs):

Date ¹	Reactor Number	Process Train Number	Off-Specification Event Description ²	Flow Rate ³ (MGD) [A]	Time (days) [B]	Off-Specification Volume (MG) ([A]*[B])
Total Off-Specification Flow for the Day³						

¹ This worksheet should only be used for one date and one reactor.
² This worksheet assumes that the flowrate is constant during the off-specification event. Off-specification volume can also be obtained from a flow totalizer.
³ Off-Specification event can be caused by UVT, flowrate, intensity, or validated dose being out of the validated range.
⁴ The total off-specification flow should be transferred to Figure 6.3 or 6.4 if any off-specification events occurred.

Figure 6.8. Example Monthly UVT Analyzer Calibration Check Log

$|UVT_{on-line}(\%) - UVT_{bench}(\%)| \leq 2\% UVT$

Reporting Period: _____
 System/Treatment Plant: _____
 PWSID: _____
 UVT Analyzer Number: _____
 Operator Signature: _____
 Date: _____

UVT Analyzer Calibration Report (Make Additional Copies of Form as Necessary)

UVT Analyzer Number	Week Number	Dates	On-line Reading (%) [A]	Grab Sample Result (%) [B]	Difference (%) ([A]-[B])	Difference $\leq 2\%$ UVT? (Y/N)
	1					
	2					
	3					
	4					
	5					

Certification:

All calibration checks were within the acceptable tolerance during this month.

Recalibration was required and is documented below.

On-Site Calibration. Manufacturer Calibration.

UVT Analyzer Calibration:

UVT Analyzer Number	On-site or manufacturer recalibration?	Date Recalibration Performed	Recalibration Successful? (Y/N)	Initials (On-site Calibration Only)

6.6 Operational Challenges

An excursion from validated operating limits can be caused by low UV intensity, low validated dose, low UVT, high flow rate, poor UV sensor calibration, poor UVT analyzer calibration, or a combination of these conditions. These conditions should be resolved quickly to verify regulatory compliance because they can result in prolonged off-specification operation. Additionally, the evaluations described in this section should be initiated before validated criteria are exceeded and off-specification occurs. This section discusses some of the potential operational challenges and suggests corrective measures.

6.6.1 Low UV Intensity or Validated Dose Below the Setpoint

Low UV intensity or validated dose may cause a reactor to operate outside of validated limits. Although UV intensity limits are not explicitly set in the Calculated Dose Approach, a low UV intensity will reduce the validated dose that is delivered, along with low UVT or high flow rate. Therefore, approaches for addressing either a low UV intensity or low validated dose readings are often the same.

The output of the UV lamps, UV transmittance of the sleeves, status of the UV sensor, and fouling of both lamp sleeves and UV sensor windows affect UV sensor readings and validated dose. Figure 6.9 presents a decision tree for evaluating low UV intensity or low validated dose. If strategies in Figure 6.9 cannot be implemented or are not successful in getting the UV intensity or validated dose above the required setpoint, the UV manufacturer or UV facility designer should be contacted to investigate the problem further. The PWS should activate any backup disinfection, shift production to another WTP or source of supply, or consider shutting down the WTP until the UV intensity or validated dose is within the validated limits. Any time that the UV intensity or validated dose is lower than the validated limit, it should be recorded as off-specification (Section 6.4.1.3).

6.6.2 Low UV Transmittance

This evaluation of low UVT presumes that either the low intensity evaluation (Section 6.6.1) has been completed and either (1) the cause of the low UV intensity was low UVT or (2) the operational staff has observed low UVT. If the reactor uses the Calculated Dose Approach, it may be programmed to increase lamp output or number of lamps in service to accommodate a decrease in UVT if the UVT is still within the validated range. If the UV equipment does not sufficiently compensate, or if the UV reactor cannot adjust lamp output, the UV intensity or validated dose may fall below the validated limits.

Figure 6.9. Low UV Intensity or Low Validated Dose Decision Chart

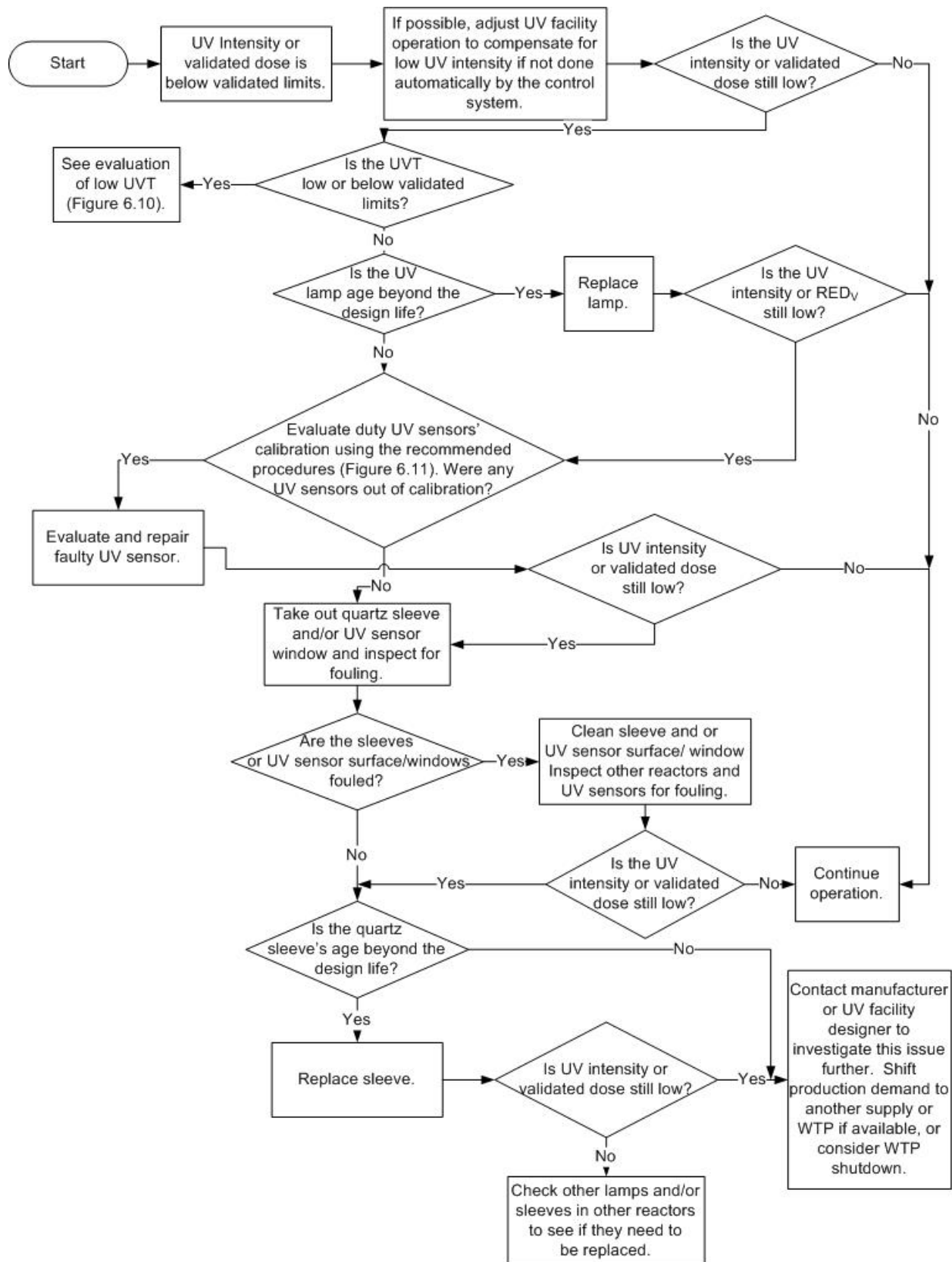

The UVT analyzer or bench-top spectrophotometer equipment should be evaluated to determine if the instruments are operating properly as described in Section 6.4.1.2. If the low UVT is not due to faulty instruments and is below the validated UVT, the following WTP operational changes should be considered:

- Vary the source water blending ratio (if available) to increase UVT.
- Where applicable, evaluate whether the coagulation process has been optimized for natural organic matter (NOM) removal and whether the coagulant dose should be increased. Poor coagulation caused by coagulant under-dosing can lead to increased NOM concentration and an associated decrease in UVT.
- Increase the oxidant dose prior to the UV facility if possible. However, this strategy may increase DBP formation or increase fouling, which should be evaluated before this option is used.
- Investigate potential upstream chemical interferences from a process failure or upset. For example, if the ozone quenching system failed, the UVT would decrease.

A decision tree that summarizes the approach for troubleshooting low UVT is shown in Figure 6.10. If the strategies presented in Figure 6.10 and described above cannot be implemented or are not successful in correcting the low UVT, the UV manufacturer or UV facility designer should be contacted to investigate the problem further. The PWS may consider shutting down the WTP or activating a backup disinfection system, if available, until the UVT is within the validated limits. The low UVT condition must be recorded as off-specification (Section 6.4.1.3) when the UVT is lower than the validated limit **and** the Calculated Dose Approach is used.

6.6.3 Failure to Meet UV Sensor Calibration Criterion

Unreliable UV sensor readings can be due to UV sensor malfunction, condensation in the UV sensor or between the UV sensor and UV sensor window, lamp malfunction, poor grounding, degradation of UV sensor electronics, or electronic short-circuits. Monitoring the UV sensor calibration will identify poor performance.

The integrated procedure of monitoring multiple UV sensor calibrations and evaluating failures of the calibration criterion can be complex, especially if multiple UV sensors fail the calibration criterion. A decision tree (Figure 6.11) can assist with the monitoring of UV sensor calibration and determining whether UV sensors should be replaced or whether a UV sensor CF is needed.

6.7 Staffing, Training, and Safety Issues

To provide consistent and reliable operation of UV reactors, the PWS must have appropriate staffing, training, and safety measures in place. This section discusses these issues.

Figure 6.10. Low UV Transmittance Decision Chart

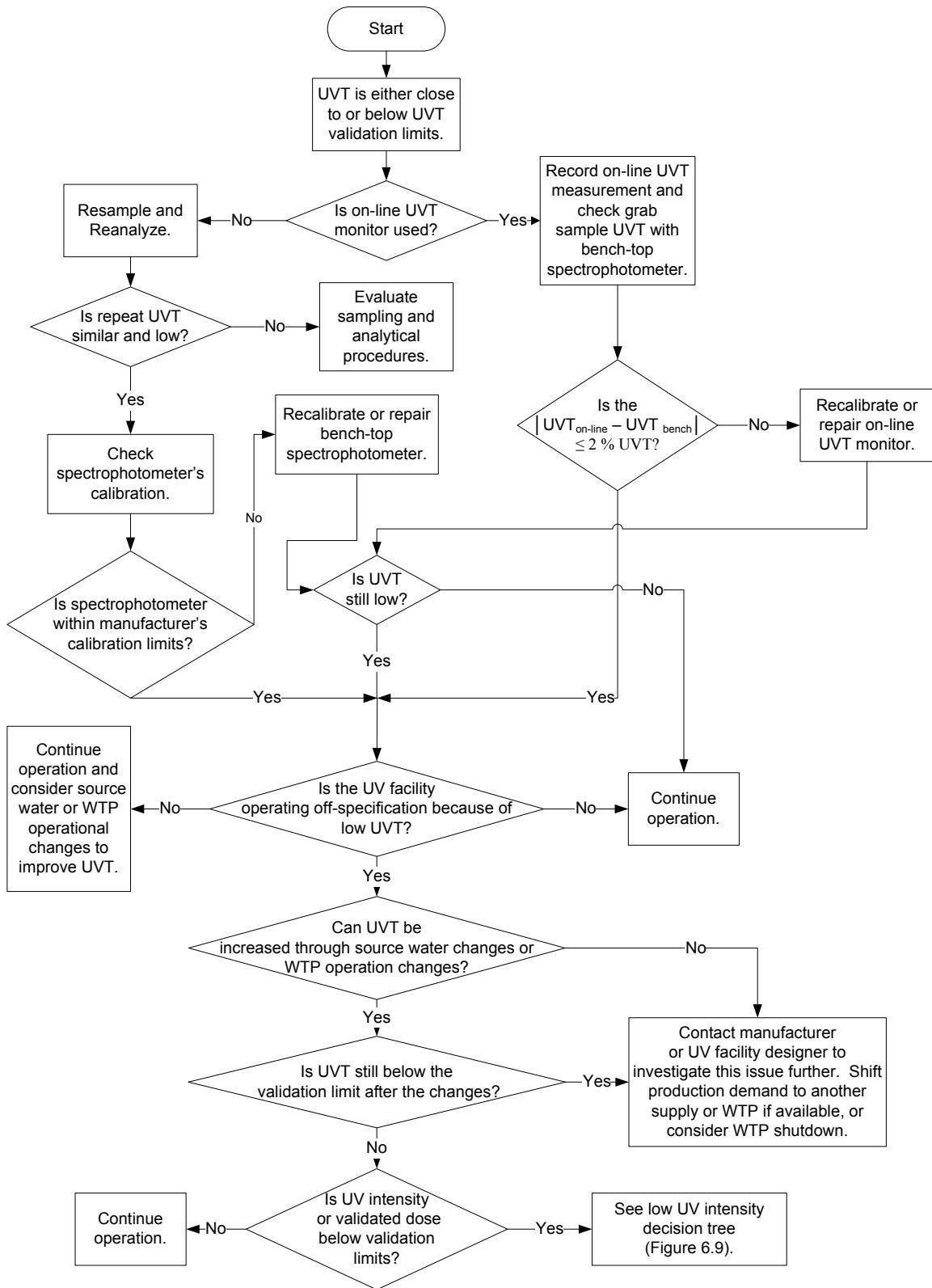
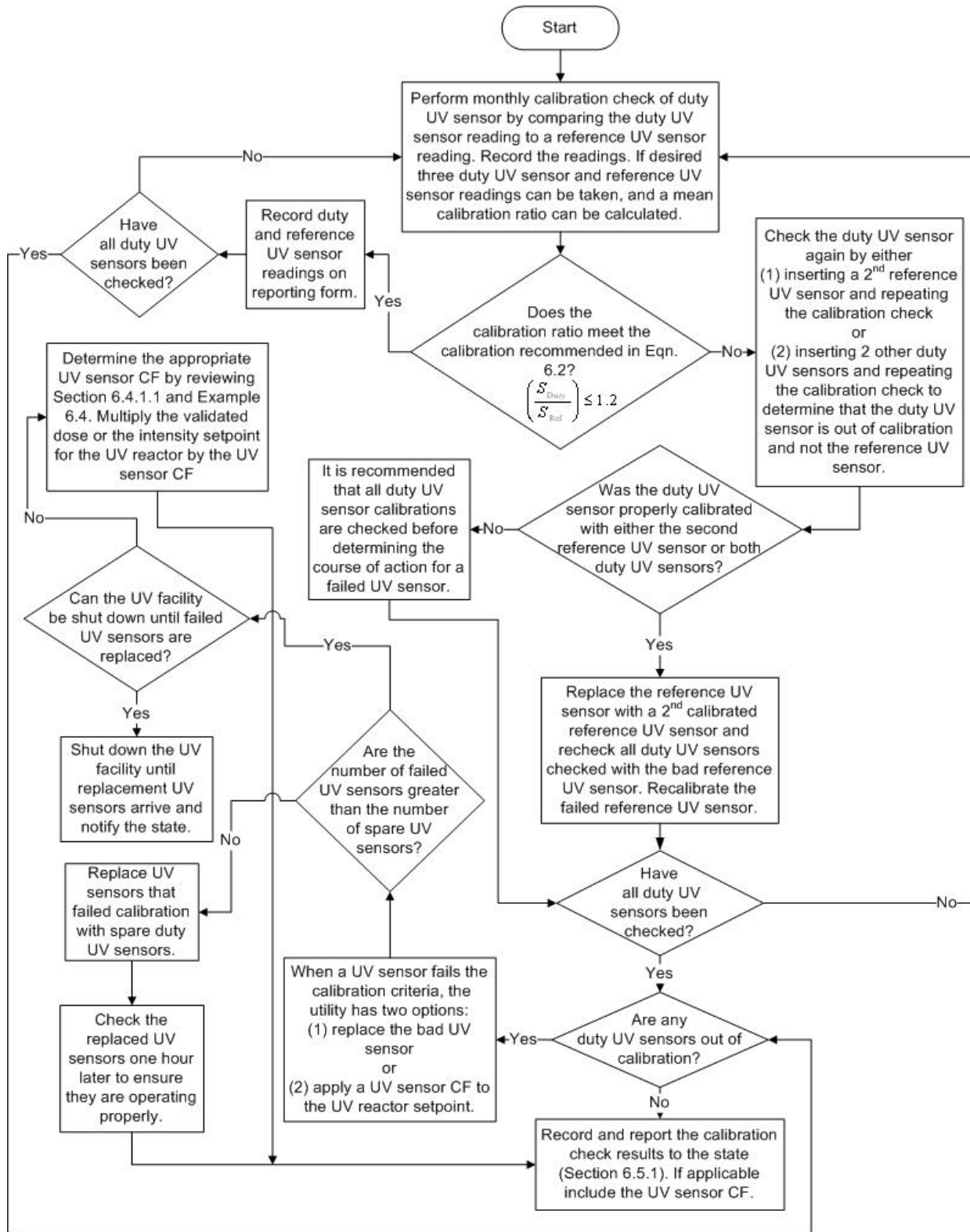

Figure 6.11. Monitoring of UV Sensor Calibration Flowchart



6.7.1 Staffing Levels

During initial start-up operation, more operator attention will be needed to assist with functional and performance testing and to establish site-specific O&M procedures (described in Section 6.1.1). However, depending on the level of automation, a typical UV facility requires minimal operator attention during normal operation. Generally, UV facilities use PLCs to monitor operating parameters, control the UV reactor, and generate alarms. Increased automation (e.g., remote monitoring capability) may be incorporated to further reduce operator requirements. Table 6.9 describes how various site-specific factors affect staffing needs for a UV facility.

Table 6.9. Factors Impacting Staffing Needs

Factor	Impact on Staffing
Type of UV Reactor	LP and LPHO reactors may require more maintenance than an MP reactor because they have more lamps and typically are cleaned off-line (i.e., OCC cleaning). However, MP lamps generally need to be replaced more often than LP lamps.
Instrumentation and Monitoring Strategy	More automated control strategies will result in lower staffing levels due to enhanced remote operation and monitoring capability.
Water Quality	Water quality and UV reactor design affect sleeve fouling and cleaning frequency. These factors, in turn, impact the staffing needs for manual cleaning for OCC systems and for maintaining the OMC or OMCC system.

6.7.2 Training

Training is necessary for all personnel who are associated with the UV facility, including operators, maintenance workers, instrumentation technicians, electricians, laboratory staff, custodial staff, engineers, and administrators. The training program should incorporate any state requirements and should emphasize both normal and emergency operating procedures, safety issues, process control and alarm conditions, validated operation, monitoring, instrumentation, and responses to operational issues.

The UV manufacturer and UV facility designer should provide training on the UV reactors, UV facility design, and O&M activities. Training should include both classroom instruction and field training. Additionally, actively involving the operators during start-up will provide another opportunity to reinforce classroom instructions. Continued training should be provided when new employees are hired or when a process or control is altered.

6.7.3 Safety Issues

This section provides some recommended safety precautions for UV reactor operations. The recommended precautions in this section should be considered in addition to manufacturer's recommended safety precautions and procedures, Occupational Safety and Health

Administration (OSHA) regulations, and state guidance and regulations for UV reactor operations.

In addition to the standards and procedures established for WTP operations, the following safety issues pertain specifically to UV reactors:

- UV light exposure
- Electrical safety
- Burns from hot lamps or equipment
- Abrasions or cuts from broken lamps or sleeves
- Potential exposure to mercury from broken lamps

Threshold limit values (TLVs) for UV light apply to occupational exposure to UV incident on the skin or eyes. The recommended TLVs depend on the lamp wavelengths emitted and the UV intensity (mW/cm^2). The PWS can determine the appropriate TLVs for their UV reactors, using *TLVs for Chemical Substances and Physical Agents and Biological Exposure Indices* (ACGIH 2006). These values are not enforceable standards, but should be considered when establishing operational procedures. To limit or prevent operator exposure to the UV light, UV reactors should have interlocks that deactivate the lamps when reactors are accessed. Viewing ports, if provided, should be fitted with UV filtering windows, or operators should wear a UV-resistant face shield when working in the UV reactor. To minimize the danger of exposure, warning signs also should be posted.

To reduce the risk of electrical shock, the main electrical supply to the UV reactors should be disconnected and the operator should wait at least 5 minutes for the lamps to cool and the energy to dissipate before maintenance is performed in areas where electric shock may be a risk. All safety and operational precautions required by the National Electric Code (NEC), OSHA, local electric codes, and the UV manufacturer should be followed and include the following precautions:

- Proper grounding
- Lockout, tagout procedures
- Use of proper electrical insulators
- Installation of safety cut-off switches

The ballasts and the reactor chamber can also become hot during operation. The temperatures of these components should be checked before touching them.

Broken lamps pose two potential safety hazards. The lamps and sleeves are constructed of quartz tubing, which can fracture and cause serious cuts or injury, and broken lamps may release mercury. Operators should be trained in proper mercury cleanup and disposal procedures to prevent mercury inhalation or absorption through the skin. Appendix E discusses lamp breakage and cleanup procedures.

7. Bibliography

- Adams, M.H. 1959. *Bacteriophage*. New York: Interscience Publishers.
- Adler, H.I. 1966. The genetic control of radiation sensitivity in microorganisms. *Advances in Radiation* 2:167–191.
- AIAA. 1998. *Guide for the Verification and Validation of Computational Fluid Dynamics Simulations*. G-077-1998, American Institute of Aeronautics and Astronautics, Reston, VA.
- Akhlaq, M.S., H.P. Schuchmann, and C. von Sonntag. 1990. Degradation of the polysaccharide alginic acid: A comparison of the effects of UV light and ozone. *Environmental Science and Technology* 24:379–383.
- Altena, F.W., J.B.J. van Overveld, and H. Giller. 2001. Technological advances in disinfection lamps leading to more compact UV sources. Presented at the First International Congress on Ultraviolet Technologies, Washington, DC, June 14 – 16.
- ACGIH. 2006. *TLVs and BEIs Based on the Documentation of the Threshold Limit Values for Chemical Substances and Physical Agents and Biological Exposure Indices*. American Conference of Governmental Industrial Hygienists. Cincinnati, OH.
- APHA-AWWA-WEF. 1998. *Standard Methods for the Examination of Water and Wastewater*, 20th ed. Washington, DC. American Public Health Association, American Water Works Association, Water Environment Federation.
- Aquafine Corporation. 2001. *CSL series: Installation, maintenance and operation manual*. Part No. 115-1.
- Ballester, N.A., J.P. Malley, J. North, T. Meyers, and M. Duben. 2003. Synergistic disinfection of Adenovirus Type 2. Presented at the Second International Congress on Ultraviolet Technologies, Vienna, Austria, July 9 – 11.
- Bircher, K. 2004. Large Scale UV Reactor Design and Validation. Proceedings of the American Water Works Association Water Quality Technology Conference, San Antonio, TX, November 14 – 18.
- Bircher, K. 2005. Calgon Carbon Corporation. Personal communication with James Collins. November 23 – 28.
- Bircher, K., Gaithuma, D.R., Rennecker, J.L., and Wright, H.B. 2005. Using CFD to Optimize Off-Site UV Reactor Validation for a Drinking Water Plant with a Unique Piping Configuration. Poster presented at the American Water Works Association 2005 Water Quality Technology Conference, Quebec City, Quebec, Canada, November 6 – 10.

- Blatchley, E.R., III. 1997. Numerical modeling of UV intensity: Application to collimated-beam reactors and continuous-flow systems. *Water Research* 31:2205–2218.
- Blatchley, E.R., III, C. Shen, Z. Naunovic, L. Lin, D.A. Lyn, J.P. Robinson, K. Ragheb, G. Grégori, D.E. Bergstrom, S. Fang, Y. Guan, K. Jennings, and N. Gunaratna. 2005. Dyed microspheres for quantification of UV dose distributions: Photochemical reactor characterization by Lagrangian actinometry. Proc. of Disinfection 2005, Sharing Disinfection Technologies: Water, Wastewater, and Biosolids, Mesa, AZ, February 6 – 9.
- Bolton, J.R. 2000. Calculation of ultraviolet fluence rate distributions in an annular reactor: Significance of refraction and reflection. *Water Research* 34:3315–3324.
- Bolton, J.R., and K. Linden. 2003. Standardization of methods for fluence (UV dose) determination in bench-scale UV experiments. *Journal of Environmental Engineering* 129(3):209–216.
- Bolton, J.R., M.I. Stefan, R.S. Cushing, and E. Mackey. 2001. The importance of water absorbance/transmittance on the efficiency of ultraviolet disinfection reactors. Proc. First International Congress on Ultraviolet Technologies, Washington, DC, June.
- Bolton Photosciences, Inc. 2004. <http://www.boltonuv.com/reactors/940/>.
- Brandt, C.L., and A.C. Giese. 1956. Photoreversal of nuclear and cytoplasmic effects of short ultraviolet radiation on *Paramecium caudatum*. *Journal of General Physiology* 39:735–751.
- Brodkorb, T., and D. Richards. 2004. UV disinfection design to avoid chlorine destruction in high UVT waters. Presented at Ontario Water Works Association, Niagara Falls, Ontario, Canada, May.
- Cabaj, A., R. Sommer, W. Pribil, and T. Haider. 2001. What means “dose” in UV-disinfection with medium pressure lamps? *Ozone Science and Engineering* 23:239–244.
- Cabaj, A., R. Sommer, W. Pribil, and T. Haider. 2002. The spectral UV sensitivity of microorganisms used in biodosimetry. *Water Science and Technology: Water Supply* 2(3):175–181
- Cabaj, A., R. Sommer, and D. Schoenen. 1996. Biodosimetry: Model calculations for U.V. water disinfection devices with regard to UV dose distributions. *Water Research* 30:1003–1009.
- Cairns, B. 2000. Comments on USEPA questions about the risk of using UV disinfection technologies in the potable water industry. Trojan Technologies Inc., London, Ontario, Canada, May 24.
- Calgon Carbon Corporation. 2006. <http://www.calgoncarbon.com/uv/>.

- Chang, J.C.H., S.F. Osoff, D.C. Lobe, M.H. Dorfman, C.M. Dumais, R.G. Qualls, and J.D. Johnson. 1985. UV inactivation of pathogenic and indicator microorganisms. *Applied and Environmental Microbiology* 49:1361–1365.
- Chiu, K.-P., D.A. Lyn, P. Savoye, and E.R. Blatchley, III. 1999. Effect of UV system modifications on disinfection performance. *Journal of Environmental Engineering* 125(5):459–469.
- Christensen, J., and K. Linden. 2002. New findings regarding the impacts of suspended particles on UV disinfection of drinking water. Proceedings of the Annual Conference of the American Water Works Association, New Orleans, LA, June 16–20.
- Clancy, J., Fallon, K., and Hargy, T. 2004. Development of nonpathogenic surrogates for large scale UV reactor validation. Proceedings of the Water Quality Technology Conference, San Antonio, November 14 – 18
- Clear, R., and S. Berman. 1994. Environmental and health aspects of lighting: Mercury. *Journal of Illuminating Engineering Society* 23(2):138–156.
- Collins, J., and J.P. Malley. 2005. The use of native biosimetry to validate MPHO and LPHO UV reactors. Presented at the 3rd International Congress on Ultraviolet Technologies, Whistler, BC, Canada, May 24 – 27.
- Coronell, O., M. Page, and B. Marinas. 2003. Sequential disinfection strategies with UV, ozone, and chlorine for optimum control of viruses, spores, and *Cryptosporidium parvum* oocysts. Presented at the AMERICAN WATER WORKS ASSOCIATION Water Quality Technology Conference, Philadelphia, PA, November 2 – 6.
- Cotton, C. 2002. Confidential communication with major water municipality. June.
- Cotton, C., R. Cushing, and D. Owens. 2002. The impacts of LT2ESWTR requirements on UV disinfection design and operation. Proceedings of the Annual Conference and Exhibition of the American Water Works Association, New Orleans, LA, June 16 – 20.
- Cotton, C.A., L. Passantino, D.M. Owen, M. Bishop, M. Valade, W. Becker, R. Joshi, R. Hubel, and M. LeChevallier. 2005. *Integrating UV Disinfection into Existing Water Treatment Plants*. American Water Works Association Research Foundation, Denver, CO.
- Crozes, G., R. Cushing, J. Rennecker, C. Cleveland, and H. Wright. 2003. Synergies of UV disinfection and ozone in water treatment. Proceedings of the 2nd International Congress on Ultraviolet Technologies, Vienna, Austria, July 9 – 11.
- DeMers, L.D., and R.C. Renner. 1992. *Alternative Disinfection Technologies for Small Drinking Water Systems*. Chapter 5, Denver, CO, American Water Works Association Research Foundation.

- Derrick, B. 2005. Inorganic Fouling and Effects on Intensity in Groundwater Applications of Ultraviolet Photoreactors. M.S. Thesis, School of Civil Engineering, Purdue University, West Lafayette.
- Derrick, B., and E.R. Blatchley, III. 2005. Field investigation of inorganic fouling of UV systems in groundwater applications. Presented at the 3rd International Congress on Ultraviolet Technologies, Whistler, BC, Canada, May 24 – 27.
- Dinkloh, L. 2001. WEDECO-ITT (Formerly WEDECO-Ideal Horizons). Personal communication with Malcolm Pirnie staff, regarding UV reactors. Tucson AZ, May 10, August 10, and August 15.
- Downes, A., and T.P. Blunt. 1877. Researches on the effect of light upon bacteria and other organisms. *Proceedings Royal Society London* 26.
- Draper, N., and H. Smith. 1998. *Applied Regression Analysis*, Third Edition. New York: Wiley.
- Dulbecco, R. 1950. Experiments on photoreactivation of bacteriophages inactivated with ultraviolet radiation. *Journal of Bacteriology* 59:329–347.
- DVGW. 2006. UV Disinfection Devices for Drinking Water Supply—Requirements and Testing. DVGW W294-1, -2, and -3. German Gas and Water Management Union (DVGW), Bonn, Germany.
- Dzurny, T., Reddy, S.P., and Wright, H.B. CFD Modeling of UV Reactors - A Critical Review. Paper presented at the International Ultraviolet Association 2003 Annual Conference, Vienna, Austria, July 9-11, 2003.
- Gaithuma, D.R. UV Reactor Validation. 2006. Paper presented at the Ultraviolet Association Mid-South UV technology one-day workshop, Rice University, Houston, TX, May 24.
- Gaithuma, D.R. 2006. Validation Field Testing: From Planning, Sampling, QA/QCing to Analyzing: Essential ‘ings’ for Getting Good Bioassay Data. Paper presented at the American Water Works Association 2006 Annual Conference and Exposition, San Antonio, TX, June 11-15.
- Gates, F.L. 1929. A study of the bactericidal action of ultraviolet light. *Journal of General Physiology* 13:231–260.
- GE Quartz. 2004a. <http://www.gequartz.com/en/tools/trans/transmission.htm>.
- GE Quartz. 2004b. <http://www.gequartz.com/en/help.htm>.
- Giese, A.C., C.L. Brandt, C. Jacobson, D.C. Shephard, and R.T. Sanders. 1954. The effects of starvation on photoreactivation in *Colpidium colpoda*. *Physiological Zoology* 71:71–78.

- Glew, D.N., and D.A. Hames. 1971. Aqueous nonelectrolyte solution: Mercury solubility in water. *Canadian Journal of Chemistry* 49:3114–3118.
- Grebe, T.E., D.D. Sabin, and M.F. McGranaghan. 1996. An Assessment of Distribution System Power Quality. Electric Power Research Institute (EPRI), Project 3908, Final Report.
- Greene, D.J., H.B. Wright, T.M. Dzurny, and E.D. Mackey. 2004. UV reactor optimization using CFD and UV intensity models. Presented at the AMERICAN WATER WORKS ASSOCIATION 2004 Annual Conference & Exposition, Orlando, FL, June 13 – 17.
- Gump, D. 2002. Severn Trent. Personal communication with Jennifer Hafer, Malcolm Pirnie, Inc., regarding UV reactors. Tucson, AZ, November 6.
- Halliday, D., and R. Resnick. 1978. *Physics*. John Wiley & Sons, New York.
- Haas, C.N., and G.P. Sakellaropoulos. 1979. Rational analysis of ultraviolet disinfection. National Conference on Environmental Engineering, Proc. American Society of Chemical Engineers (ASCE) Specialty Conf., San Francisco, CA, July 9 – 11.
- Hargy, T., J. Clancy, K. Fallon, H.B. Wright, and K. Bircher. 2004. Stability of MS2 in groundwaters. Proceedings of the AMERICAN WATER WORKS ASSOCIATION Water Quality Technology Conference. San Antonio, Texas, November 14 – 18.
- Haubner, K. 2005. WEDECO-ITT (Formerly WEDECO-Ideal Horizons). Personal communication from James Collins. November 23 – December 1.
- Havelaar, A.H., C.C.E. Meulemans, W.M. Pot-Hogebom, and J. Koster. 1990. Inactivation of bacteriophage MS2 in wastewater effluent with monochromatic and polychromatic ultraviolet light. *Water Research* 24(2):1387–1393.
- Hoyer, O. 1998. Testing performance and monitoring of UV systems for drinking water disinfection. *Water Supply* 16(1–2):424–429.
- Hoyer, O. 2002. DVGW Test Facility for UV Disinfection Devices at Wahnbachtalsperrenverband Siegelsknippen, Germany, personal communication with Harold Wright of Carollo Engineers.
- Ijpelaar, G.F., B. van der Veer, G.J. Medema, and J.C. Kruithof. 2003. By-product formation during UV disinfection of a pre-treated surface water. Proceedings of the 2nd International Congress on Ultraviolet Technologies, Vienna, Austria, July 9 – 11.
- Infilco Degremont. 2005. <http://www.infilcodegremont.com>.
- Jagger, J. 1967. *Introduction to Research in Ultraviolet Photobiology*. Englewood Cliffs, NJ: Prentice-Hall, Inc.

- Jeffcoat, S. 2005. CH2M Hill, Inc. Personal communication with Christine Cotton, Malcolm Pirnie, Inc., regarding fouling in Clayton County. Tucson, AZ, December.
- Kashimada, K., N. Kamiko, K. Yamamoto, and S. Ohgaki. 1996. Assessment of photoreactivation following ultraviolet light disinfection. *Water Science & Technology* 33:261–269.
- Kashinkunti, R., K.G. Linden, G. Shin, D.H. Metz, M.D. Sobsey, M. Moran, and A. Samuelson. 2003. Achieving multi-barrier inactivation in Cincinnati: UV, byproducts, and biostability. *Journal of the American Water Works Association* 96(6):114–127.
- Kawar, K., J. Jenkins, B. Srikanth, and A. Shurtleff. 1998. Ultraviolet light deterioration of the light transmittance of quartz sleeves due to continuous exposure to UV radiation. *Ultrapure Water* (October) 67–71.
- Kelner, A. 1950. Light-induced recovery of microorganisms from ultraviolet radiation injury, with special reference to *Escherichia coli*. *Bulletin of the New York Academy of Medicine* 26:189–199.
- Knudson, G.B. 1985. Photoreactivation of UV-irradiated *Legionella pneumophila* and other *Legionella* species. *Applied and Environmental Microbiology* 49:975–980.
- Kolch, A. 2001. Assessing the Risk of Mercury Release from Ultraviolet Discharge Lamps in Drinking Water. WEDECO AG Water Technology.
- Kruithof, J.C., and R.C. van der Leer. 1990. Practical experiences with UV-disinfection in The Netherlands. Proceedings of the AMERICAN WATER WORKS ASSOCIATION seminar on emerging technologies in practice, Annual Conference of the American Water Works Association, Cincinnati, OH, June 17 – 21.
- Kubik, D. 2005. Lethbridge WTP. Personal communication with Christine Cotton, Malcolm Pirnie, Inc., regarding chlorine residual loss in UV reactors. Tucson, AZ, September.
- Larason T.C., and C.L. Cromer. 2001. Source of error in UV radiation measurements. *Journal of Research of the National Institute of Standards and Technology* 106(4):649–656.
- Larason, T.C., S.S. Bruce, and A.C. Parr. 1998. *Spectroradiometric Detector Measurements*. NIST Special Publication 250-41. U.S. Government Printing Office, Washington, DC.
- Larner, S. 2005. Hanovia Corporation. Personal communication by James Collins (Malcolm Pirnie). November 23 – 25.
- Lawal, O. 2006. WEDECO ITT (Formerly known as WEDECO Ideal Horizon). Personal communication by Laurel Passantino. March 23 – April 25.
- Leinberger, J. 2002. Trojan Technologies. Personal communication with Jennifer Hafer, Malcolm Pirnie, Inc, regarding UV reactors. November 5.

- Leinberger, J. 2005. Trojan Technologies. Personal communication with James Collins. November 23 – December 1.
- Lin, L.S., C.T. Johnston, and E.R. Blatchley, III. 1999a. Inorganic fouling at quartz:water interfaces in ultraviolet photoreactors. I: Chemical characterization. *Water Research* 33:3321–3329.
- Lin, L.S., C.T. Johnston, and E.R. Blatchley, III. 1999b. Inorganic fouling at quartz:water interfaces in ultraviolet photoreactors. II: Temporal and spatial distribution. *Water Research* 33:3330–3338.
- Linden, K.G. 2002. Personal email communication with Laurel Passantino, Malcolm Pirnie, Inc. April 24 – May 6.
- Linden, K.G., and J.L. Darby. 1998. UV disinfection of marginal effluents: Determining UV absorbance and subsequent estimation of UV intensity. *Water Environment Research* 70(2).
- Linden, K.G., G.A. Shin, and M.D. Sobsey. 2001. Comparative effectiveness of UV wavelengths for the inactivation of *Cryptosporidium parvum* oocysts in water. *Water Science & Technology* 43:171–174.
- Linden, K.G., G.A. Shin, G. Faubert, W. Cairns, and M.D. Sobsey. 2002a. UV disinfection of *Giardia lamblia* cysts in water. *Environmental Science and Technology* 36:2519–2522.
- Linden, K.G., L. Batch, and C. Schulz. 2002b. UV disinfection of filtered water supplies: Water quality impacts on MS2 dose-response curves. Proceedings of the Annual Conference of the American Water Works Association, New Orleans, LA, June 16 – 20.
- Linden, K.G., C. Sharpless, P. Neofotistos, B. Ferran, and S. Jin. 2004. MP lamp aging: Spectral shifts and irradiance changes. Presented at the Annual Conference of the American Water Works Association UVDGM stakeholder workshop, Orlando, FL, June 2004.
- Liu, W., S.A. Andrews, J.R. Bolton, K.G. Linden, C. Sharpless, and M. Stefan. 2002. Comparison of disinfection byproduct (DBP) formation from different UV technologies at bench scale. *Water Science Technology – Water Supply* 2(5–6):515–521.
- Logsdon, G., and J. Symons. 1973. Mercury removal by conventional water-treatment techniques. *Journal of the American Water Works Association* 65:554–562.
- Lotierzo, M., C. Feliars, N. Faure, L. LeGrand, S. Saby, and P. Cervantes. 2003. Synergistic effects of sequential treatment by UV irradiation and chemical disinfectant for drinking water. Proceedings of the 2nd International Congress on Ultraviolet Technologies, Vienna, Austria, July 9 – 11.

- Mack, J., and J.R. Bolton. 1999. Photochemistry of nitrite and nitrate in aqueous solution: A review. *Journal of Photochemistry and Photobiology* 128:1 – 13.
- Mackey, E.D., R.S. Cushing, and H.B. Wright. 2001. Effect of water quality on UV disinfection of drinking water. Proceedings of the First International Ultraviolet Association Congress, Washington, DC, June 14 – 16.
- Mackey, E.D., R.S. Cushing, M.L. Janex, N. Picard, J.M. Laine, and J.P. Malley. 2004. Bridging pilot-scale testing to full-scale design of UV disinfection systems. American Water Works Association Research Foundation, Denver, CO.
- Mackey, E.D., H. Wright, T. Hargy, A.C. Fonseca, and A. Cabaj. 2004. Reducing UV design safety factors, optimization of UV reactor validation. Proceedings of the American Water Works Association Water Quality Technology Conference, San Antonio, TX, November 14 – 18.
- Mackey, E.D., H.B. Wright, and A.C. Fonseca. 2005. Improving UV validation: Mimicking real-world conditions. Presented at the Water Environment Foundation Disinfection Conference, Phoenix, AZ, February 6 – 9.
- Mackey, E.D., H.B. Wright, T. Hargy, J. Clancy, and A. Cabaj. 2006 (in press). *Optimization of UV Reactor Validation*. American Water Works Association Research Foundation, Denver, CO.
- Malley, J. 2000. The state of the art in using UV disinfection for waters and wastewaters in North America. Proceedings of ENVIRO 2000 – Australian Water Association (AWA), Sydney, Australia, April 9 – 13.
- Malley, J. 2001. Addressing concerns over mercury releases from UV lamps. *IUVA News* 3(3):28–29.
- Malley, J.P. 2002. Historical perspective of UV use. Presented at the AMERICAN WATER WORKS ASSOCIATION Water Quality Technology Conference, Seattle, WA, November 10 – 14.
- Malley, J.P., J.P. Shaw, and J.R. Ropp. 1996. Evaluation of by-products produced by treatment of groundwaters with ultraviolet irradiation. American Water Works Association Research Foundation, Denver, CO.
- Malley, J., B.A. Petri, G.L. Hunter, D. Moran, M. Nadeau, and J. Leach. 2001. Full-scale Implementation of UV in Groundwater Disinfection Systems. American Water Works Association Research Foundation Final Report, Denver, CO.
- Malley, J.P., N. Ballester, S. Farabaugh, and D. Gaithuma. 2003. Multiple disinfectant barriers within a multiple barrier system: A new drinking water paradigm for public health protection. Proceedings of the 2nd International Congress on Ultraviolet Technologies, Vienna, Austria, July 9 – 11.

- Malley, J.P., N.A. Ballester, A.B. Margolin, K.G. Linden, A. Mofidi, J.R. Bolton, G. Crozes, B. Cushing, E. Mackey, J. M Laine, and M-L. Janex. 2004. Inactivation of Pathogens with Innovative UV Technologies. American Water Works Association Research Foundation.
- Mamane-Gravetz, H., and K.G. Linden. 2004. Impact of particle aggregated microbes on UV disinfection. Presented at the American Water Works Association Water Quality Technology Conference, San Antonio, TX, November 14 – 18.
- McClellan, J. 2001a. Hanovia Corporation. Personal communication with Doug Owen and Christine Cotton, Malcolm Pirnie, Inc., regarding UV reactors. Slough, England, April 9.
- McClellan, J. 2001b. Hanovia Corporation. Personal communication with Christine Cotton, Malcolm Pirnie, Inc., regarding UV reactors. Tucson, AZ, May 4.
- Meng, Q.S., and C.P. Gerba. 1996. Comparative inactivation of enteric adenovirus, poliovirus and coliphages by ultraviolet irradiation. *Water Research* 30(11):2665–2668.
- Merck & Co., Inc. 1983. *The Merck Index 10th Edition*, edited by M. Windholz. Rahway, NJ.
- Meulemans, C.C.E. 1986. The basic principles of UV-sterilization of water. In: Ozone + Ultraviolet Water Treatment, Aquatec Amsterdam, Paris: International Ozone Association. B.1.1–B.1.13.
- Morton, R.A., and R.H. Haynes. 1969. Changes in the ultraviolet sensitivity of *Escherichia coli* during growth in batch cultures. *Journal of Bacteriology* 97(3):1379–85
- Moss, L. 2002a. Personal communication with Jennifer Hafer, Malcolm Pirnie, Inc., regarding UV reactors. Tucson, AZ, April 29.
- Moss, L. 2002b. Personal communication with Jennifer Hafer, Malcolm Pirnie, Inc., regarding UV reactors. Tucson, AZ, November 18.
- Munakata, N., and C.S. Rupert. 1972. Genetically controlled removal of “spore photoproduct” from deoxyribonucleic acid of ultraviolet-irradiated *Bacillus subtilis* spores. *Journal of Bacteriology* 111:192–198.
- Munakata, N., M. Daito, and K. Hieda. 1991. Inactivation spectra of *Bacillus subtilis* spores in extended ultraviolet wavelengths (50 – 300 nm) obtained with Synchrotron radiation. *Photochemistry and Photobiology* 54:761–768.
- Mutti, D. 2004. Personal communication with Amy Samuelson, Malcolm Pirnie, Inc., regarding UV reactors. Indianapolis, IN, October 26.
- Nieuwstad, T.J., and A.H. Havelaar. 1994. The kinetics of batch ultraviolet inactivation of bacteriophage MS2 and microbiological calibration of an ultraviolet pilot plant. *Journal of Environmental Science and Health* A29(5):1993–2007.

- NSF. 2003. NSF/ANSI 60, *Drinking Water Treatment Chemicals—Health Effects*. Ann Arbor: National Sanitation Foundation
- NSF. 2004. NSF/ANSI 55, *Ultraviolet Microbiological Water Treatment Systems*. Ann Arbor: National Sanitation Foundation.
- NWRI. 2003. *Ultraviolet Disinfection Guidelines for Drinking Water and Water Reuse*. Second Edition. National Water Research Institute, Fountain Valley, CA, in collaboration with American Water Works Association Research Foundation.
- OSHA. 2006. *Mercury Vapor in Workplace Atmospheres*.
<http://www.osha.gov/dts/sltc/methods/inorganic/id140/id140.html>
- Oguma K., H. Katayama, H. Mitani, S. Morita, T. Hirata, and S. Ohgaki. 2001. Determination of pyrimidine dimers in *Escherichia coli* and *Cryptosporidium parvum* during UV light inactivation, photoreactivation, and dark repair. *Applied and Environmental Microbiology* 67:4630–4637.
- Oguma, K., H. Katayama, and S. Ohgaki. 2002. Determination of pyrimidine dimers in the genomic DNA of *Escherichia coli* during photoreactivation following inactivation by medium–pressure UV lamp. Presented at the 2nd IWA International Congress, Melbourne, Australia.
- Oliver, B.G., and E.G. Cosgrove. 1975. The disinfection of sewage treatment plant effluents using ultraviolet light. *Canadian Journal of Chemical Engineering* 53:170–174.
- ÖNORM. 2001. Plants for the disinfection of water using ultraviolet radiation—Requirements and testing—Part 1: Low pressure mercury lamp plants. ÖNORM M 5873-1. Österreichisches Normungsinstitut, Vienna, Austria.
- ÖNORM. 2003. Plants for the disinfection of water using ultraviolet radiation—Requirements and testing—Part 2: Medium pressure mercury lamp plants. ÖNORM M 5873-2. Österreichisches Normungsinstitut, Vienna, Austria.
- Oppenheimer, J.A., J.E. Hoagland, J.-M. Laine, J.G. Jacangelo, and A. Bhamrah. 1993. Microbial inactivation and characterization of toxicity and by-products occurring in reclaimed wastewater disinfected with UV radiation. Water Environment Federation (WEF) Specialty Conference: Planning, Design & Operation of Effluent Disinfection Systems. Whippany, NJ.
- Oppenheimer, J., T. Gillogly, G. Stolarik, and R. Ward. 2002. Comparing the efficiency of low and medium pressure UV light for inactivating *Giardia muris* and *Cryptosporidium parvum* in waters with low and high levels of turbidity. Proceedings of the Annual Conference and Exhibition of the American Water Works Association, New Orleans, LA, June 16 – 20.

- Oppenheimer, J., M. Heath, and B. Gallagher. 2003. Impact of chemical disinfectant residuals on UV inactivation of viruses. Presented at the American Water Works Association Water Quality Technology Conference, Philadelphia, PA, November 2 – 6.
- Örmeci, B., and K.G. Linden. 2003. Inactivation and detection of particle-associated microorganisms. Proceedings of the 2nd International Congress on Ultraviolet Technologies, July 9 – 11, Vienna, Austria.
- Örmeci, B., J.J. Ducoste, and K.G. Linden. 2005. UV disinfection of chlorinated water: Impact on chlorine concentration and UV dose delivery. *Journal of Water Supply, Research, and Technology – Aqua* 54(3).
- Parker, J.A., and J.L. Darby. 1995. Particle-associated coliform in secondary effluents: Shielding from ultraviolet light disinfection. *Water Environment Research* 67:1065–1075.
- Passantino, L., J. Malley, M. Knudson, R. Ward, and J. Kim. 2004. Effect of low turbidity and algae on UV disinfection performance. *Journal of the American Water Works Association* 96:128–137.
- Peldszus, S., S.A. Andrews, R. Souza, F. Smith, I. Douglas, J. Bolton, and P.M. Huck. 2004. Effect of medium-pressure UV irradiation on bromate concentrations in drinking water, a pilot-scale study. *Water Research* 38:211–217.
- Petri, B.M., G. Fang, J.P. Malley, D.C. Moran, and H. Wright. 2000. Ground water UV disinfection: Challenges and solutions. Proceedings of the American Water Works Association Water Quality Technology Conference. Salt Lake City, UT, November 5 – 9.
- Pfeifer, G.P. 1997. Formation and processing of UV photoproducts: Effects of DNA sequence and chromatin environment. *Photochemistry & Photobiology* 65:270–283.
- Phillips, R. 1983. *Sources and Applications of Ultraviolet Radiation*. New York: Academic Press Inc.
- Polymicro Technologies. 2004. http://www.polymicro.com/catalog/2_21.htm
- Powell, W.F. 1959. Radiosensitivity as an index of *Herpes simplex* virus development. *Virology* 9:1–19.
- Primarc Limited. 2001. Primarc UV Technology. September 5. www.primarc.com
- Qualls, R.G., and J.D. Johnson. 1983. Bioassay and UV dose measurement in UV disinfection. *Applied and Environmental Microbiology* 45(3):872–877.
- Rauth, A.M. 1965. The physical state of viral nucleic acid and the sensitivity of viruses to ultraviolet light. *Biophysical Journal* 5:257–273.
- Region of Waterloo. 2004. Personal communication with Amy Samuelson, Malcolm Pirnie, Inc., regarding UV reactors. Indianapolis, IN, November 3.

- Rice, J.K., and M. Ewell. 2001. Examination of peak power dependence in the UV inactivation of bacterial spores. *Applied and Environmental Microbiology* 67:5830–5832.
- Roberts, A. 2000. Hanovia Corporation. Letter to Dan Schmelling, U.S. Environmental Protection Agency. April 10.
- Schulz, C.R. 2004. Camp, Dresser, & McKee. Personal communication with Laurel Passantino, Malcolm Pirnie, Inc., regarding UV installations. Phoenix, AZ, October 22.
- Setlow, J.K. 1967. Comprehensive Biochemistry. Chapter 5 in *The Effects of Ultraviolet Radiation and Photoreactivation*. 27:157–209.
- Severin, B.F., M.T. Suldan, and R.S. Englebrecht. 1983. Effects of temperature on ultraviolet light disinfection. *Environmental Science and Technology* 17:717–721.
- Severn Trent Services. 2006. <http://www.severntrentservices.com>.
- Sharpless, C.M., and K.G. Linden. 2001. UV photolysis of nitrate: Effects of natural organic matter and dissolved inorganic carbon, and implications for UV water disinfection. *Environmental Science and Technology* 35:2949–2955.
- Shin, G.A., K.G. Linden, M.J. Arrowood, G. Faubert, and M.D. Sobsey. 2001. DNA repair of UV-irradiated *Cryptosporidium parvum* oocysts and *Giardia lamblia* cysts. Proceedings of the First International Ultraviolet Association Congress, Washington, DC, June 14 – 16.
- Snowball, M.R., and I.S. Hornsey. 1988. Purification of water supplies using ultraviolet light. In *Developments in Food Microbiology*, ed. R.K. Robinson. New York: Elsevier Applied Science. 171–191.
- Sommer, R., and A. Cabaj. 1993. Evaluation of the efficiency of a UV plant for drinking water disinfection. *Water Science and Technology* 27(7-8):357–362.
- Sommer, R., A. Cabaj, D. Schoenen, J. Gebel, A. Kolch, A.H. Havelaar, and F.M. Schets. 1995. Comparison of three laboratory devices for UV-inactivation of microorganisms. *Water Science and Technology* 31:147–156.
- Sommer, R., A. Cabaj, and T. Haider. 1996. Microbiocidal effect of reflected UV radiation in devices for water disinfection. *Water Science and Technology* 34(5–6):173–177.
- Sommer, R., T. Haider, A. Cabaj, W. Pribil, and M. Lhotsky. 1998. Time dose reciprocity in UV disinfection of water. *Water Science and Technology* 38:145–150.
- Sommer, R., T. Haider, A. Cabaj, W. Pribil, and M. Lhotsky. 1998. Time UV dose reciprocity in UV disinfection of water. International Association of Water Quality (IAWQ) Vancouver 1998 Poster.

- Srikanth, B. 2001a. Aquafine Corporation. Letter to James Malley, University of New Hampshire, regarding accidental UV lamp breakage and potential scenarios and prevention strategies. June 13.
- Srikanth, B. 2001b. Aquafine Corporation. Personal communication with Jennifer Hafer, Malcolm Pirnie, Inc., regarding UV reactors. Tucson, AZ, June 21.
- Stantec Consulting Ltd. 2004. Mannheim UV Emergency Response Procedure. Prepared for the Regional Municipality of Waterloo.
- Swaim, P.D., M.A. Morine, R.G. Brauer, M.A. Neher, J.L. Gebhart, and W.D. Bellamy. 2002. Operating data from Henderson's full-scale UV disinfection facility. Proceedings from the American Water Works Association Water Quality Technology Conference, November 10 – 14, Seattle, WA.
- Swaim, P.D., S.B. Jeffcoat, M.L. Gaylor, and W.D. Bellamy. 2003. New challenges of on-site UV validation at a WTP with multiple disinfection barriers. American Water Works Association Water Quality Technology Conference, Philadelphia, PA, November 2 – 6.
- Taylor, J.R. 1982. *An Introduction to Error Analysis*. 2nd Edition, University Science Books, Sausalito, CA.
- Templeton, M., R. Hofmann, R. Andrews, and E. Whitby. 2003. UV inactivation of floc-associated MS-2 coliphage. American Water Works Association Water Quality Technology Conference, Philadelphia, PA, November 2 – 6.
- Templeton, M., R.C. Andrews, and R. Hoffman. 2004. Particle characteristics influencing the UV disinfection of drinking water. Presented at the American Water Works Association Water Quality Technology Conference, San Antonio, TX, November 14 – 18.
- Thompson, S.S., and M.V. Yates. 1999. Bacteriophage inactivation at the air-water-solid interface in dynamic batch systems. *Applied and Environmental Microbiology* 65(3):1186–1190.
- Toivanen, E. 2000. Experiences with UV disinfection in Helsinki water. *IUVA News*. 2(6):4–8.
- Tramposch, W. 2004. Personal communication with Amy Samuelson, Malcolm Pirnie, Inc., regarding UV reactors. Indianapolis, IN, October 14.
- Tree, J.A., M.R. Adams, and D.N. Lees. 1997. Virus inactivation during disinfection of wastewater by chlorination and UV irradiation and the efficacy of f+ bacteriophage as a viral indicator. *Water Science and Technology* 35:227–232.
- Trojan Technologies. 2003. <http://www.trojanuv.com/en/homeframe.htm>

- USEPA. 1992. *Characterization of Products Containing Mercury in Municipal Solid Waste in the United States, 1970 – 2000*. EPA 530-R-92-013, U.S. Environmental Protection Agency, Office of Solid Waste, Washington, DC.
- USEPA. 1996. (2-1)
- USEPA. 1997a. *Mercury – Emergency Spill & Release Facts*. 540-K-97-004, OSWER 9378.0-10FS, PB97-963405, U.S. Environmental Protection Agency, Office of Emergency and Remedial Response, Washington, DC.
- USEPA. 1997b. *Mercury Emissions from the Disposal of Fluorescent Lamps*. F-97-FLEA-S0002, U.S. Environmental Protection Agency, Office of Solid Waste, Washington, DC.
- USEPA. 2003. *Proposal Draft Ultraviolet Disinfection Guidance Manual*. EPA 815-D-03-007. U.S. Environmental Protection Agency, Office of Groundwater and Drinking Water, Washington, DC
- USEPA. 2006. *Source Water Monitoring Guidance Manual for Public Water Systems for the Final Long Term 2 Enhanced Surface Water Treatment Rule*. EPA 815-R06-005, U.S. Environmental Protection Agency, Office of Water, Washington, DC.
- Venkatesan, N., G. Hua, and D.A. Reckhow. 2003. Impact of UV disinfection on DBP formation from subsequent chlorination. Proceedings of the American Water Works Association Water Quality Technology Conference, Philadelphia, PA, November 2 – 6.
- von Sonntag, C., and H.P. Schuchmann. 1992. UV disinfection of drinking water and by-product formation: Some basic considerations. *Journal of Water Supply Research and Technology* 41:67– 4.
- Wait, I., C. Johnston, A. Schwab, and E. Blatchley, III. 2005. The influence of oxidation-reduction potential on inorganic fouling of quartz surfaces in UV disinfection systems. Presented at the American Water Works Association Water Quality Technology Conference, Quebec City, Quebec, Canada, November 6 – 10.
- Walitsky, P. Philips Lighting. 2001. Personal communication with Jennifer Hafer, Malcolm Pirnie, Inc., regarding UV reactors. Tucson AZ, May 14.
- WEDECO UV Systems. 2003. <http://www.uvsystems.co.uk/water/index.html>.
- Wilczak, A. and H. Lai. 2006. Preliminary bench and pilot evaluation of UV-irradiation for nitrification control. Proceedings of the American Water Works Association Annual Conference. June 11 – 16, San Antonio, TX.
- Wilson, B.R., P.F. Roessler, E. Van Dellen, M. Abbaszadegan, and C.P. Gerba. 1992. Coliphage MS-2 as a UV water disinfection efficacy test surrogate for bacterial and viral pathogens. Proceedings of the Water Quality Technology Conference, Toronto, November 15 – 19, pgs. 219 – 235.

- Wobma, P.C., W.D. Bellamy, J.P. Malley, and D.A. Reckhow. 2004. *UV Disinfection and Disinfection By-product Characteristics of Unfiltered Water*. Denver, CO, American Water Works Association Research Foundation.
- Wright, H. 2005. Personal communication with Christine Cotton, Malcolm Pirnie, Inc, regarding lamp breaks. January 24.
- Wright, H.B. 2006. Carollo Engineers. Internal communication with Erin Mackey, Carollo Engineers.
- Wright, H.B., and Y.A. Lawryshyn. 2000. An assessment of the bioassay concept for the UV reactor validation. *Disinfection 2000: Disinfection of Wastes in the New Millennium*, New Orleans, LA, March 15 – 18; Water Environment Federation, Alexandria, VA.
- Wright, N.G., and D.M. Hargreaves. 2001. The use of CFD in the evaluation of UV treatment systems. *Journal of Hydroinformatics* 3:59–70.
- Wright, H.B., and E.D. Mackey. 2003. Rational approaches for defining safety factors for UV disinfection. Paper presented at the International Ultraviolet Association 2003 Annual Conference, Vienna, Austria, July 9 – 11.
- Wright, H.D., and S.P. Reddy. 2003. Factors impacting the precision of CFD-based modeling of UV reactor performance. Proceedings of the AMERICAN WATER WORKS ASSOCIATION Annual Conference & Exposition, Anaheim, CA, June 15 – 19.
- Wright, H.B., E.D. Mackey, and R.S. Cushing. 2002. Impact of UV intensity sensor properties of dose delivery compliance monitoring for monochromatic and polychromatic UV disinfection systems. Paper presented at the Water Environment Foundation/American Water Works Association 2002 Conference, St. Petersburg, FL, February 17 – 20.
- Wright, H.B., E. Mackey, and P. White. 2002. UV disinfection compliance monitoring for drinking water applications. Proceedings of the Water Quality Technology Conference and Exhibition, Seattle, WA, November 10 – 14.
- Wright, H.B., T.M. Dzurny, and D.J. Greene. 2004. Impact of UV sensor properties on dose delivery monitoring by UV disinfection systems: Number of UV sensors in a multi-lamp UV reactor. Paper presented at the International Ultraviolet Association 2004 European Conference on UV Radiation, Karlsruhe, Germany, September 22 – 24.
- Wright, H.B., T.M. Dzurny, and A.T. Salveson. 2005. Cost and efficiency of dose pacing strategies used by drinking water and wastewater UV systems. Proceedings of the Water Environment Federation Disinfection 2005 Conference, Phoenix, AZ, February 6 – 9.
- Wright, H., Gaithuma, D., Bircher, K., and Trampusch, W. 2005. Analyzing UV Reactor Validation Data to Verify UV Dose Delivery Using the UV Disinfection Guidance

- Manual. Proceedings of American Water Works Association 2005 Water Quality Technology Conference, Quebec City, Quebec, Canada, November 6 – 10.
- Wright, H.B., D. Gaithuma, T. Dzurny, C. Schulz, A. Cabaj, and A. Schmalweiser. 2006. Design and performance guidelines for UV sensor systems. American Water Works Association Research Foundation, Denver, CO (in preparation).
- Yahya, M.T., T.M. Straub, and C.P. Gerba. 1992. Inactivation of coliphage MS-2 and poliovirus by copper, silver, and chlorine. *Canadian Journal of Microbiology* 38(6):430–435.
- Yip, R.W., and D.E. Konasewich. 1972. Ultraviolet sterilization of water: Its potential and limitations. *Water and Pollution Control* 14:14–18.
- Zheng, M., S.A. Andrews, and J.R. Bolton. 1999. Impacts of medium pressure UV on THM and HAA formation in pre-UV chlorinated drinking water. American Water Works Association Water Quality Technology Conference, October 31 – November 3, Tampa, FL.

Appendix A

Preparing and Assaying Challenge Microorganisms

This page intentionally left blank.

Sections A.1 through A.4 describe procedures that can be used for preparing stock solutions of male-specific-2 bacteriophage (MS2 phage) and *Bacillus subtilis* spores and assaying the concentration of those microorganisms in water samples. Procedures for preparing stock solutions can be scaled to provide the volumes needed for UV reactor validation. Alternative procedures and challenge microorganisms can be used if they are acceptable to the state.

A.1 MS2 Phage Stock Preparation

MS2 phage (American Type Culture Collection [ATCC] 15597-B1) can be propagated using a variety of host bacteria, including *Escherichia coli* C3000 (ATCC 15597); *E. coli* Famp (ATCC 700891); and others (Meng and Gerba 1996, Oppenheimer et al. 1993, NWRI (2003). The following propagation method was adapted from NWRI (2003).

Procedure:

1. Inoculate sterile tryptic soy broth (TSB) (Difco, Detroit, Michigan) with host bacteria transferred from a single colony grown on a nutrient agar plate. Incubate the culture with constant stirring at 35 to 37 degrees Centigrade (°C) for 18 to 24 hours.
2. Transfer 0.5 milliliter (mL) of the host bacterial culture to 50 mL of fresh TSB and incubate at 35 to 37 °C for 4 to 6 hours with continuous shaking at 100 Hertz (Hz) to obtain a culture in its log growth phase ($\sim 3 \times 10^8$ cfu/mL, where cfu = colony forming unit).
3. Dilute stock MS2 phage using Tri-buffered saline (pH 7.3) to a concentration of ~ 100 pfu/mL (pfu = plaque forming unit).
4. Add 1 mL of diluted MS2 phage stock solution to the 50-mL volume of *E. coli* in TSB and incubate overnight at 35 to 37 °C.
5. Centrifuge the MS2-*E. coli* culture at $8,000 \times G$ [$G = 9.82$ meter per second squared (m/s^2)] for 10 minutes at 4 °C to remove cellular debris.
6. Filter the supernatant by passing it through a 0.45-micrometer (μm) low protein-binding filter.
7. Assay the concentration of MS2 phage in the stock solution as described in Section A.2.
8. Collect and refrigerate the filtrate at 4 °C, and use within one month.

Propagation should result in a highly concentrated stock solution of essentially mono-dispersed phage whose UV dose-response follows second-order kinetics with minimal tailing. Figure A.1 presents the UV dose-response of MS2 phage as reported in the literature. Over the range of reduction equivalent dose (RED) values demonstrated during validation testing, the

mean UV dose-response of the MS2 phage stock solution should lie within the 95-percent prediction interval of the mean response in Figure A.1. Over a UV dose range of 0 to 120 millijoule per centimeter squared (mJ/cm^2), the prediction intervals of the data shown in Figure A.1 may be defined using the following equations:

$$\text{Upper Bound: } \log I = -1.4 \times 10^{-4} \times \text{UV Dose}^2 + 7.6 \times 10^{-2} \times \text{UV Dose} \quad \text{Equation A.1}$$

$$\text{Lower Bound: } \log I = -9.6 \times 10^{-5} \times \text{UV Dose}^2 + 4.5 \times 10^{-2} \times \text{UV Dose} \quad \text{Equation A.2}$$

Figure A.1. UV Dose-response of MS2 Phage

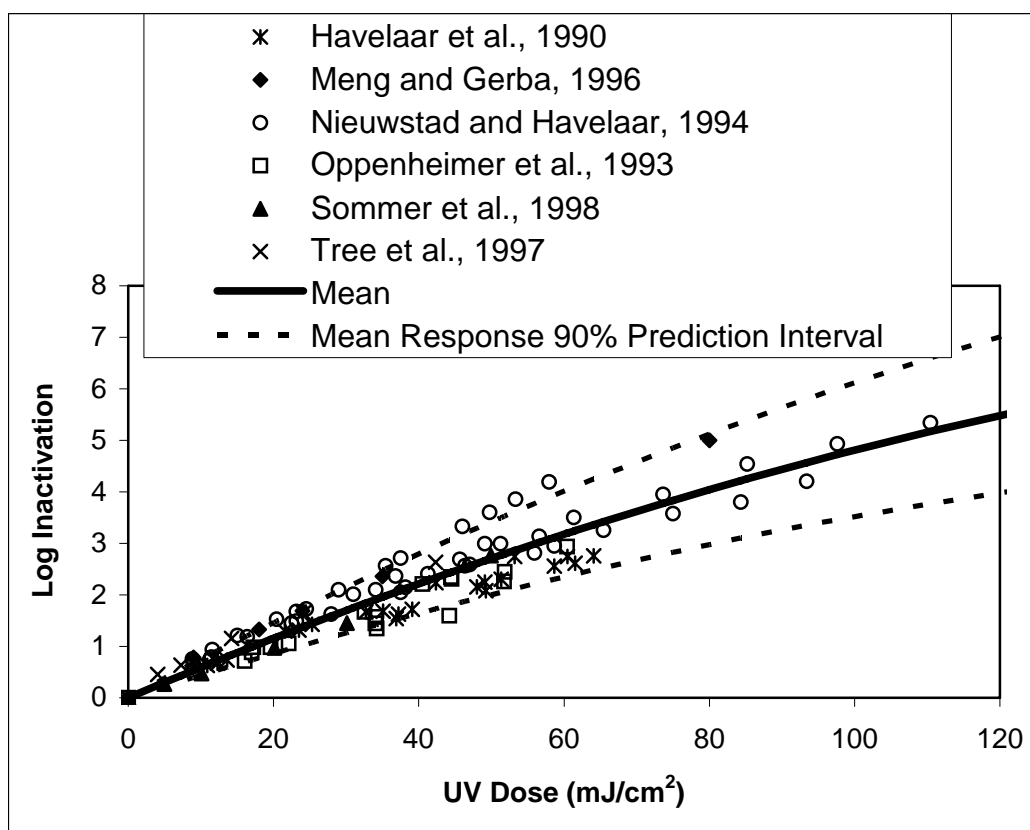

A.2 MS2 Phage Assay

The concentration of MS2 phage (ATCC 15597-B1) in water samples can be assayed using agar overlay technique with *E. coli* (ATCC 15597) as a host bacterium [(Adams (1959), Yahya et al. (1992), Oppenheimer et al. (1993), and Meng and Gerba (1996)]. Each test sample should be assayed in triplicate and the sample concentration calculated as the arithmetic average of the three measured values. The following procedure can be used.

Procedure:

1. Inoculate sterile TSB (Difco, Detroit, Michigan) with the host bacterium and incubate at 35 to 37 °C for 18 to 24 hours to obtain an approximate concentration of 10^8 cfu/mL.
2. Transfer 1 mL of the host bacterial culture to 50 mL of fresh TSB and incubate at 35 to 37 °C for 4 to 6 hours with continuous shaking at 100 Hz to obtain a culture in its log growth phase.
3. Obtain serial dilutions of the MS2 phage sample using a 0.001-molar (M) phosphate-saline buffer or TSB.
4. Combine and gently stir 1 mL of host cell solution, 0.1 mL of diluted MS2 phage sample, and 2 to 3 mL of molten tryptic soy agar (TSA) (0.7 percent agar, 45 to 48 °C) (Difco).
5. Pour the mixture onto solidified TSA (1.5 percent agar) contained in petri dishes. The time between mixing the MS2 phage sample with the *E. coli* host and plating the top agar layer should not exceed 10 minutes. After plating, the agar should harden in less than 10 minutes.
6. After the top agar layer hardens, cover and invert the petri dishes, and incubate 16 to 24 hours at 35 to 37 °C.
7. Count the plaques with the aid of a colony counter. Plaques are identified as clear circular zones 1 to 5 millimeter (mm) in diameter in the lawn of host bacteria.
8. Record the number of plaques per dish and the MS2 phage sample volume and dilution. If individual plaques cannot be distinguished because of confluent growth, record the plate counts as “TNTC” (too numerous to count).
9. Calculate the MS2 phage concentration in the water samples:

$$Concentration = \sum 10^{F_D} \frac{n_{i,avg}}{V_i} \quad \text{Equation A.3}$$

where:

- F_D = Dilution factor
 n_i = Number of counts on each plate (cfu or pfu)
 V_i = Volume of diluted sample used with each plate (mL)

Example A.1. A water sample containing MS2 phage was diluted 10-, 100-, and 1,000-fold using a 0.1-mL aliquot dilution of the sample for each. Each dilution was assayed in triplicate and the average count from these three plate counts is the challenge microorganism corresponding to the applied UV dose. Plaque forming units observed on the plates were 2, 5, and 6 for the 1,000-fold diluted sample and 32, 40, and 47 for the 100-fold diluted sample. With the 10-fold dilution, plate counts were too numerous to count. The concentration in the original sample is calculated as:

$$\text{Conc.} = \frac{\left(10^3 \times \frac{(2 + 5 + 6) \text{ pfu} / 3}{0.1 \text{ mL}} \right) + \left(10^2 \times \frac{(32 + 40 + 47) \text{ pfu} / 3}{0.1 \text{ mL}} \right)}{2} = 4.15 \times 10^4 \text{ pfu/mL}$$

A.3 *Bacillus subtilis* Spore Preparation

B. subtilis spores (ATCC 6633) can be propagated using Schaeffer's medium [Munakata and Rupert (1972), Sommer et al. (1995), and DVGW (2006)]. The following propagation method was adapted from DVGW (2006).

Procedure:

1. Prepare 1 liter (L) of Columbia agar (Oxoid CM 331) using 23.0 grams (g) special peptone (Oxoid L 72), 1.0 g starch, 5.0 g NaCl, and 10.0 g agar (Oxoid L 11) in phosphate-buffered (to pH 7) water. Autoclave for 15 minutes at 121 °C.
2. Prepare 1 L of sporulation medium using 280 milligrams (mg) MgSO₄·H₂O, 1.11 g KCl, 3.1 mg FeSO₄·7H₂O, and 8.9 g nutrient broth (Oxoid CM 67) in phosphate-buffered (to pH 7) water. Autoclave for 15 minutes at 121 °C.
3. Inoculate Columbia agar (Oxoid CM 331) plates with three smears of *B. subtilis* and incubate 24 hours at 37 °C.
4. Inoculate 300 mL of sporulation medium with three colonies collected from the agar plates that were prepared in Step 3.
5. Incubate the sporulation medium for 72 hours at 37 °C on a shaker operating at 2 Hz.
6. Sonicate the resulting culture for 10 minutes at 50,000 Hz and 10 °C.
7. Harvest the spores by centrifuging 80-mL aliquots at 5,000 × G and 10 °C for 10 minutes.

8. Wash the spores 3 times by re-suspending the pellet in 20 mL of distilled water and centrifuging at $5,000 \times G$ for 10 minutes at 10°C .
9. Re-suspend the washed spores in 100 mL of 0.001-M phosphate-saline buffer.
10. Inactivate the vegetative *B. subtilis* by heating at 80°C for 10 minutes.
11. Sonicate the resulting culture for 10 minutes at 50,000 Hz and 10°C .
12. Collect the resulting stock solution and assay the *B. subtilis* spore concentration as described in Section A.4.
13. Refrigerate at 4°C and use within one month (unless stability over longer periods of time can be substantiated). Sonicate for 10 minutes at 50,000 Hz and 10°C before use.

Propagation should result in a highly concentrated stock solution of mono-dispersed *B. subtilis* spores with a UV dose-response that follows the UV dose-response curves reported in the literature and presented in Figure A.2. Over the range of RED values demonstrated during validation testing, the mean UV dose-response of the *B. subtilis* stock solution should lie within the 90-percent prediction interval of the mean response provided in Figure A.2. Over a UV dose range of 0 to 70 mJ/cm^2 , the prediction intervals of the data shown in Figure A.2 are defined using the following equations:

$$\text{Upper Bound: } \log I = -2.0 \times 10^{-5} \times UV \text{ Dose}^3 + 2.7 \times 10^{-3} \times UV \text{ Dose}^2 - 5.3 \times 10^{-2} \times UV \text{ Dose} \quad \text{Equation A.4}$$

$$\text{Lower Bound: } \log I = 5.7 \times 10^{-4} \times UV \text{ Dose}^2 + 4.3 \times 10^{-2} \times UV \text{ Dose} \quad \text{Equation A.5}$$

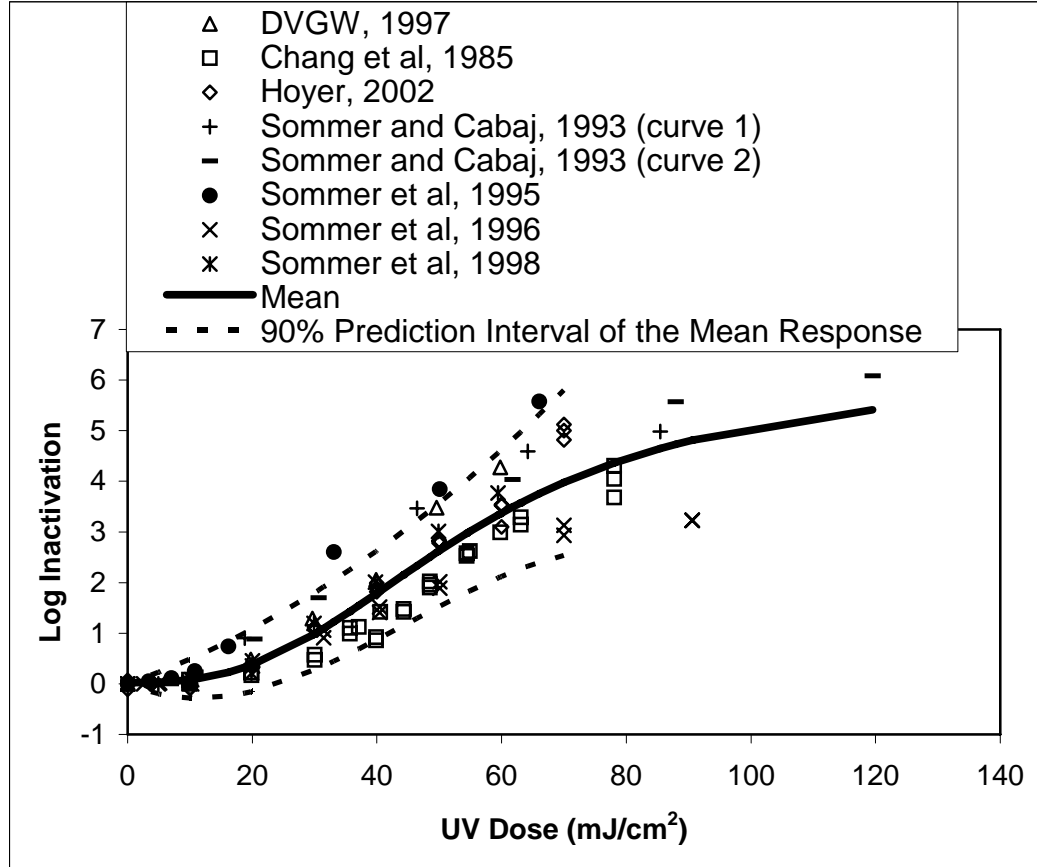
Figure A.2. UV Dose-Response of *B. subtilis* Spores

A.4 *Bacillus subtilis* Spore Assay

The concentration of *B. subtilis* spores (ATCC 6633) in water samples can be assayed using plate count agar. As with MS2 phage, each test sample should be assayed in triplicate and the sample concentration calculated as the arithmetic average of the three measured values. The following procedure was adopted from DVGW (2006).

Procedure:

1. Prepare 1 L of plate-count agar (Oxoid CM 325) using 5.0 g casein peptone (Oxoid L 42), 2.5 g yeast extract (Oxoid L 21), 1.0 g glucose, and 9.0 g agar (Oxoid L 11) in distilled water. Adjust the pH to 6.8 ± 0.2 and autoclave for 15 minutes at 121 °C.
2. Obtain serial dilutions of the *B. subtilis* spore sample using 0.001-M phosphate-saline buffer.
3. Vacuum filter 100 mL of diluted sample through a 47-mm 0.45- μ m membrane filter.
4. Place filter on a petri dish containing hardened agar and cover plates.

5. Incubate plates 24 ± 2 hours at 37 ± 1 °C.
6. Count the number of colonies formed with the aid of a colony counter.
7. Record the number of colonies per dish, and the *B. subtilis* spore sample volume and dilution. If individual colonies cannot be distinguished because of confluent growth, record the plate counts as TNTC.
8. Calculate the *B. subtilis* spore concentration in the original samples in units of cfu/mL using Equation A.3.

This page intentionally left blank

Appendix B

UV Reactor Testing Examples

This page intentionally left blank

This appendix presents two validation data analysis examples. Section B.1 presents an example for the UV Intensity Setpoint Approach using single-setpoint operations. Section B.2 presents a more complex example for a UV reactor that uses the Calculated Dose Approach. These two examples bracket a wide range of complexities that UV reactor validation testing can encompass. All information and data are hypothetical but are representative of real validation data in terms of selection of test conditions and variability in measured values.

B.1 Example 1 – Validation for the UV Intensity Setpoint Approach (a Single Setpoint and a Single Disinfection Goal)

System X plans to add UV disinfection to their treatment process to earn 2.5-log *Cryptosporidium* inactivation credit. Based on the LT2ESWTR dose requirements as summarized in Table 1.4 of this manual, System X needs to deliver a minimum required dose of 8.5 mJ/cm² to receive this level of inactivation credit. The hypothetical proposed installation has the following design specifications:

Design flow rate	400 gpm
Minimum UVT	90 %
Lamp aging factor	80 %
Fouling factor	85 %
Fouling/aging factor	68 % (80 % × 85 %)
Disinfection goal	2.5-log <i>Cryptosporidium</i> inactivation credit

The water system’s engineer selected a UV reactor (illustrated in Figure B.1) with the following characteristics:

UV Reactor	<ul style="list-style-type: none"> - 2 banks of lamps - 4 300-W LPHO lamps per bank - Rated for flow rates of 50 – 500 gpm - 1 UV sensor/bank positioned equidistant from Lamps 2 & 3
UV Dose-Monitoring Approach	UV Intensity Setpoint Approach with one alarm setpoint

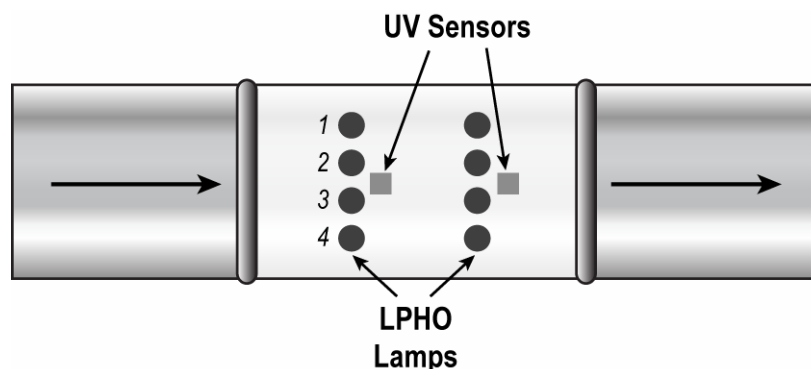
Figure B.1 Schematic of Hypothetical UV Reactor for Example 1

B.1.1 Validation Test Plan

The validation test plan was developed using Checklist 5.2 in Chapter 5. Key elements defined in the validation test plan include:

- The UV manufacturer provided three reference UV sensors for calibrating the duty sensors during validation. These reference sensors had been calibrated by an independent, qualified sensor testing laboratory before validation and had a documented measurement uncertainty of 10 percent (Section 5.5.4)
- Because the number of UV sensors was less than the number of lamps, the highest-output lamps were identified prior to testing and were positioned closest to the sensors at lamp positions 2 and 3 (Section 5.4.7). New lamps were used during validation testing (after a 100 hour burn-in period).
- The validation testing was conducted over a one-day period. The UV dose-response of the challenge microorganism (measured via a laboratory collimated beam test) was evaluated with 1-L influent water samples collected at high and low UVT values (Section C.1).
- All recommended testing protocols as listed in Section 5.7 and Appendix C were followed.

The UV manufacturer had already identified a target setpoint (**11.7 mW/cm²**) using numerical modeling. System X confirmed with the manufacturer that this setpoint is low enough to account for their combined conditions of minimum UVT and maximum lamp fouling and aging. The following two UVT–lamp power operating conditions were tested:

1. The UVT was lowered to produce the target UV sensor setpoint (in this case, the resultant UVT was 89.9%), while the lamp power was kept at 100%.

2. The UVT was raised back to its maximum value (no UV-absorbing chemical added), and the lamp power was reduced to produce the same UV sensor value (in this case, the resultant lamp power was 66%).

B.1.2 Test Data

The data collected during validation testing are presented in Tables B.1 through B.5 and are described below:

- Table B.1 presents the UV dose-response data measured on the influent water collected during field validation testing for the laboratory collimated beam test.
- Tables B.2 through B.4 present the data from full-scale reactor testing
 - Table B.2 presents the flow rate, UVT, lamp power, and UV sensor readings measured for each test condition.
 - Table B.3 presents the measured challenge microorganism concentrations for the influent and effluent samples collected (in triplicate) from the UV reactor for each test condition.
 - Table B.4 presents the UV output of the eight lamps used during validation testing measured at the same lamp location (Lamp #2 in Row #1) adjacent to the same UV sensor (#1), which was used to identify the highest output lamps.
- Table B.5 presents data comparing the three reference UV sensor measurements to the duty UV sensors used during validation.

Sections B.1.3 to B.1.8 show how the data will be used to determine whether QA/QC criteria are met, to calculate the necessary correction factors, and to determine the validated operating conditions for the target log inactivation.

Table B.1 Challenge Microorganism UV Dose-response Measured Using a Collimated Beam Apparatus

UV Dose (mJ/cm ²)	90% UVT				97% UVT				
	Replicate #1		Replicate #2		UV Dose (mJ/cm ²)	Replicate #1		Replicate #2	
	N (pfu/mL)	Log N	N (pfu/mL)	Log N		N (v/mL)	Log N	N (pfu/mL)	Log N
0	882329	5.95	944980	5.98	0	1148154	6.06	1300460	6.11
10	180120	5.26	198394	5.30	10	316328	5.50	257749	5.41
20	64217	4.81	69438	4.84	20	113644	5.06	74396	4.87
30	20622	4.31	20100	4.30	30	34679	4.54	25189	4.40
40	7257	3.86	8145	3.91	40	12624	4.10	9226	3.97
60	1274	3.11	1399	3.15	60	1980	3.30	1722	3.24
80	188	2.27	261	2.42	80	387	2.59	211	2.32
100	80	1.90	90	1.95	100	80	1.90	100	2.00

Table B.2 Flow Rate, UVT, Lamp Power, and UV Sensor Data Measured during Validation Testing

Test ID	Banks On	Flow Rate (gpm)	UVT (%)	Relative Lamp Output (%)	S _{duty, #1} (mW/cm ²)	S _{duty, #2} (mW/cm ²)
1	1, 2	394	89.9	100%	11.7	11.7
2	1, 2	403	97.0	66%	11.6	11.7

Table B.3 Measured Influent and Effluent Challenge Microorganism Concentrations

Test ID	Influent Challenge Microorganism Log Concentration			Effluent Challenge Microorganism Log Concentration		
	Replicate #			Replicate #		
	1	2	3	1	2	3
1	5.94	6.00	5.84	4.57	4.54	4.56
2	6.01	5.99	6.04	4.10	4.09	4.06

Table B.4 Sensor #1 Measurements with Lamp #2 Operated at 100-percent Ballast Power

Lamp ID	S _{duty #1} (mW/cm ²)	Lamp ID	S _{duty #1} (mW/cm ²)
1	13.6	5	13.9
2	14.6	6	13.3
3	14.2	7	14.5
4	13.4	8	14.3

Table B.5 Reference UV Sensor Checks

Before/After Validation Testing	UVT (%)	Relative Lamp Power (%)	Sensor ID	S _{duty} (mW/cm ²)	S _{ref, #1} (mW/cm ²)	S _{ref, #2} (mW/cm ²)	S _{ref, #3} (mW/cm ²)
Before	97	100	1	11.3	11.7	12.1	11.4
Before	97	68	1	5.1	5.5	5.7	5.3
Before	90	100	2	3.7	4.0	4.1	3.8
Before	90	68	2	2.0	1.9	1.9	1.8
After	97	100	1	11.6	11.8	12.2	11.4
After	97	68	1	5.1	5.4	5.6	5.3
After	90	100	2	3.9	4.0	4.1	3.9
After	90	68	2	1.9	1.8	2.0	1.8

B.1.3 Develop the UV Dose-response Curve from the Collimated Beam Data

Figures B.1(a) and (b) present the UV dose-response data from Table B.1 at UVT values of 90 and 97 percent, respectively. The data have been fitted to quadratic equations that show log N as a function of UV dose. The fits were used to identify log N₀ values of 5.91 and 6.05 (i.e.,

log N_0 where the curves intersect the y-axes) from Figures B.1(a) and (b), respectively. Using these values, Table B.6 presents the UV dose-response data defined as UV dose versus log I, where $\log I = \log(N_0/N)$.

The UV dose-response data described in Table B.6 were analyzed to determine if the two datasets could be combined using the method referred to in Section C.5 (Draper and Smith 1998).¹ A statistical analysis of the collimated beam data is recommended to determine which terms are significant, $p\text{-value} \leq 0.05$, using a standard regression tool. The process is iterative, and each time the regression tool is used, one term is dropped until all of the coefficients are deemed significant ($p\text{-values} \leq 0.05$). In this example, three iterations were needed.

The regression analysis showed that the two measured UV dose-response curves were statistically similar ($p < 0.05$) and could be combined. Figure B.2 presents the plot of UV dose as a function of log inactivation for the combined dataset and the resultant UV dose-response equation.

¹ The datasets should be combined whenever possible to develop one UV dose-response equation for calculating all RED values. The inability to combine datasets indicates a problem may have occurred with either the calculation or the test. Details are provided in Section C.5.

Figure B.1 Log N Versus UV Dose Using the Data in Table B.1 at (a) 90 Percent UVT and (b) 97 Percent UVT

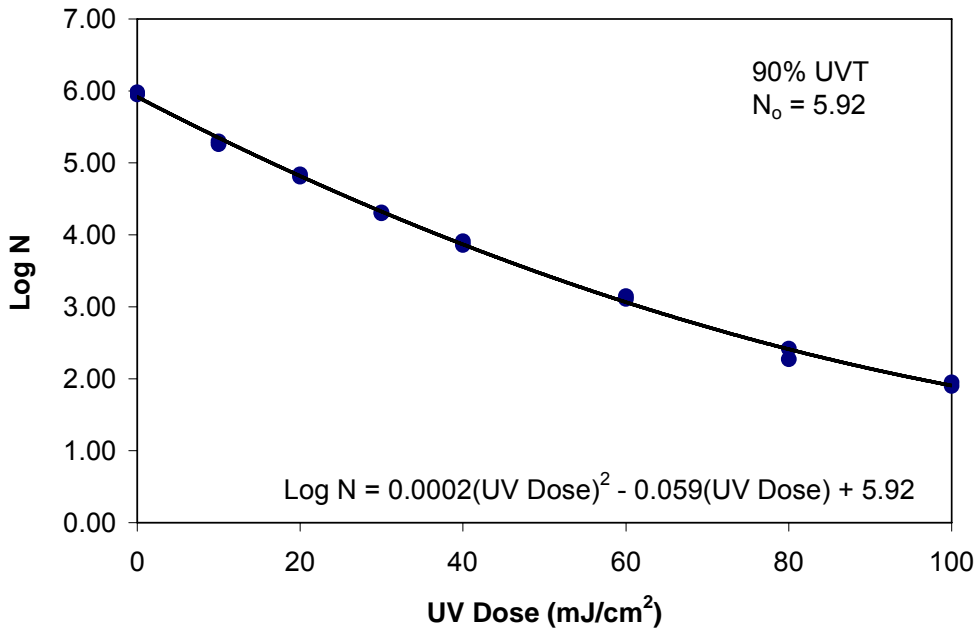

(a)

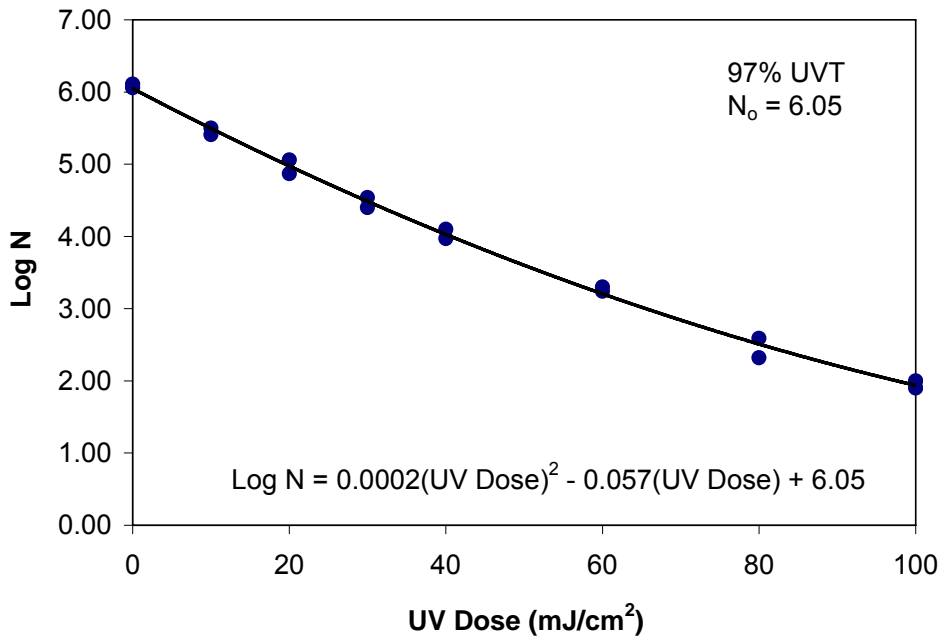

(b)

Table B.6 Challenge Microorganism UV Dose-response Defined as UV Dose Versus [Log (N₀/N)] (i.e., Log I)

UV Dose (mJ/cm ²)	90% UVT		UV Dose (mJ/cm ²)	97% UVT	
	Replicate			Replicate	
	#1	#2		#1	#2
	5.92 - Log N			6.05 - Log N	
0	-0.03	-0.06	0	-0.01	-0.06
10	0.66	0.62	10	0.55	0.64
20	1.11	1.08	20	0.99	1.18
30	1.61	1.62	30	1.51	1.65
40	2.06	2.01	40	1.95	2.08
60	2.81	2.77	60	2.75	2.81
80	3.65	3.5	80	3.46	3.73
100	4.02	3.97	100	4.15	4.05

Figure B.2 Log I Versus UV Dose Using the Data in Table B.6

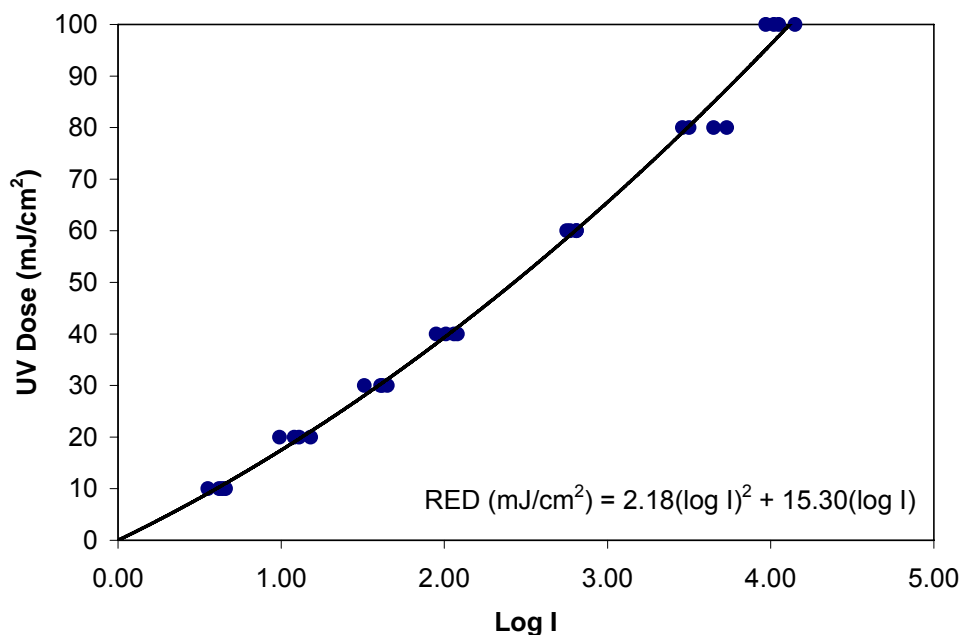

B.1.4 Verify That QA/QC Criteria Are Met

Checklist 5.4 was used to ensure that recommended QA/QC criteria were met. Calculations of key uncertainties are provided in the next two subsections.

B.1.4.1 Collimated Beam Data Uncertainty

The uncertainty in the UV dose calculation using the collimated beam data is calculated according to Equation C.6, shown below as Equation B.1:

$$U_{DR} = t \frac{SD}{UV Dose_{CB}} \times 100\% \quad \text{Equation B.1}$$

where

- U_{DR} = Uncertainty of the UV dose-response fit at a 95-percent confidence level
 $UV Dose_{CB}$ = UV dose calculated from the UV dose-response curve in Figure B.2
 SD = Standard deviation of the difference between the calculated UV dose-response and the measured values from Table B.1
 t = t-statistic at a 95-percent confidence level for a sample size equal to the number of test condition replicates used to define the dose-response

In this case, $SD = 2.2$ at 1-log inactivation and $t = 2.04$ for 32 test condition replicates as shown in Table B.6. Equation B.1 can then be used to determine U_{DR} at various log inactivation values from Table B.1. The graph below shows the relationship between log inactivation and U_{DR} . The value of U_{DR} should not exceed 30 percent at the UV dose corresponding to 1-log inactivation of the challenge organism. In this case, $U_{DR} = 25$ percent at 1.0-log inactivation. This value is less than the recommended limit of 30 percent.

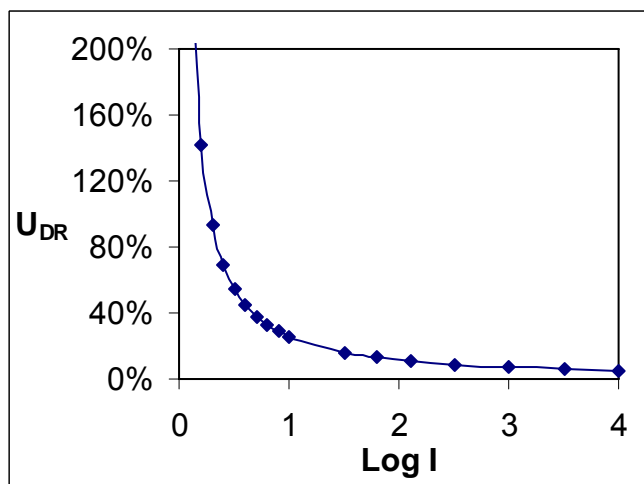

B.1.4.2 UV Sensor Uncertainty

Guidance in Section 5.5.4 recommends that the manufacturer's reported sensor uncertainty be confirmed as being less than 10 percent. Three reference sensors were used to confirm duty sensor measurements. Data analyses are shown in the table on the next page (using the data in Table B.5). The two duty UV sensors were within 10 percent of the average readings from three reference sensors.

Before/ After Validation n Testing	UVT (%)	Lamp Power (kW)	Sensor ID	S _{duty} (W/m ²)	S _{Ref,#1} (W/m ²)	S _{Ref,#2} (W/m ²)	S _{Ref,#3} (W/m ²)	S _{Ref,avg} (W/m ²)	$\left \frac{S_{duty}}{S_{Ref,avg}} - 1 \right $
Before	97	100	1	11.3	11.7	12.1	11.4	11.7	4%
Before	97	68	1	5.1	5.5	5.7	5.3	5.5	7%
Before	90	100	2	3.7	4	4.1	3.8	4.0	7%
Before	90	68	2	2	1.9	1.9	1.8	1.9	7%
After	97	100	1	11.6	11.8	12.2	11.4	11.8	2%
After	97	68	1	5.1	5.4	5.6	5.3	5.4	6%
After	90	100	2	3.9	4	4.1	3.9	4.0	3%
After	90	68	2	1.9	1.8	2.0	1.8	1.9	2%

Source of sensor data: Table B.5

B.1.5 Calculate Log Inactivation and RED

Table B.7 shows the measured log inactivation through the UV reactor and the associated RED values for each validation test condition. The log inactivation values were determined from the field inactivation data in Table B.3. The RED values are determined by inputting the log inactivation into the UV dose-response equation. For example, for a log inactivation of 1.37 (Test No. 1, Replicate 1), the RED is equal to $[2.18 \times (1.37)^2] + [15.30 \times 1.37]$, or 25.1. Note that the average and standard deviations for each test condition are also calculated for later use in computing the Validation Factor (VF).

Table B.7 Measured Log I and RED Values for Each Test Condition in Table B.2

Test ID #	UVT	Log I			RED (mJ/cm ²)				
		Replicate #			Replicate #			Avg.	SD _{RED}
		1	2	3	1	2	3		
1	89.9	1.37	1.46	1.28	25.1	27.0	23.2	25.1	1.9
2	97.0	1.91	1.9	1.98	37.2	36.9	38.8	37.6	1.0

B.1.6 Determine the Validation Factor

The VF is defined according to Equation 5.13², shown below as Equation B.2:

$$VF = B_{RED} \times \left(1 + \frac{U_{val}}{100} \right) \quad \text{Equation B.2}$$

B.1.6.1 Calculate the RED Bias

² If the UV reactor was equipped with MP lamps instead of LPHO lamps, the potential for polychromatic bias would need to be evaluated using the guidelines in Section 5.9.

Per guidance provided in Section 5.9.1, The UV sensitivity (RED / Log I) for each test replicate was calculated for the test with the lowest UVT value (in this case, Test 1). The RED bias for 2.5-log *Cryptosporidium* inactivation credit at the minimum UVT of 90 percent was determined to be 1.79 using Table G.4. Data for this analysis are summarized below.

Test #	RED (mJ/cm ²)	Log I	UVT ¹	Sensitivity (mJ/cm ² per log I)	B _{RED}
1.1	25.1	1.37	89.9	18.3	1.79
1.2	27.0	1.46	89.9	18.5	
1.3	23.2	1.28	89.9	18.1	

¹ Note: rounding off to match the number of significant figures in Table G.4, to determine the value of B_{RED} the UVT value measured for Test #1 becomes 90 percent.

B.1.6.2 Calculate the Uncertainty of Validation

The decision tree in Figure 5.4 was used to identify the correct equation for U_{VAL}. As shown in Section B.1.4.1, U_{DR} is less than or equal to 30 percent. As noted in Section B.1.4.2, U_S is less than or equal to 10 percent. Therefore, the equation for U_{VAL} is as follows:

$$U_{Val} = U_{SP} \tag{Equation B.3}$$

U_{SP} is defined by Equation 5.14

$$U_{SP} = \frac{t \times SD_{RED}}{RED} \times 100\% \tag{Equation B.4}$$

where

- t = t-statistic for the number of replicates
- SD_{RED} = the standard deviation for the RED calculations (Table B.7)
- RED = the RED at the specific test condition used for the SD_{RED}

The value for t is 3.18 for 3 test replicates. The highest SD_{RED} and associated RED should be used in this calculation. Using data from Table B.7, data from test condition #1 should be used as follows:

$$U_{SP} = \frac{3.18 \times 1.9}{25.1} \times 100\% = 24.1\%$$

Using Equation B.3, U_{VAL} = 24.1%

B.1.6.3 Calculate the Validation Factor

The value of VF can now be calculated using Equation B.2:

$$VF = 1.79 \times (1 + 24.1/100) = 2.22$$

B.1.7 Calculate the Validated Dose

In the step, the minimum RED (in this case, the average RED from test condition #1, shown in Table B.7) is divided by the VF to calculate the validated dose using Equation 5.16:

$$D_{Val} = \frac{RED}{VF} \quad \text{Equation B.5}$$

$$D_{Val} = \frac{25.1}{2.22} = 11.3 \text{ mJ} / \text{cm}^2$$

B.1.8 Assign Log Inactivation Credit Based for the Validated Dose

The validated dose must be greater than or equal to the required UV dose (D_{req}) to achieve a given level of pathogen inactivation credit:

$$D_{Val} \geq D_{req} \quad \text{Equation B.6}$$

In this case, 11.3 mJ/cm² is greater than the required dose of 8.5 mJ/cm² for 2.5-log inactivation of *Cryptosporidium*. The UV reactor can receive 2.5-log inactivation credit for an installation (with adequate inlet/outlet hydraulics, see Section 5.4.5) that operates under the following criteria (Table B.8):

Table B.8 Validated Dose and Operating Conditions for 2.5-log *Cryptosporidium* Inactivation Credit Using the Hypothetical UV Reactor Tested in Example 1

UV Sensor Setpoint	Lamp Status	Flow Rate Range	D_{Val}
11.7 mW/cm ²	All lamps should be turned on during reactor operations	$Q \leq 394 \text{ gpm}$	$\geq 11.3 \text{ mJ/cm}^2$

B.2 Example 2 – Validation for the Calculated Dose Approach

System Y plans to add UV disinfection to their treatment plant to earn 2.0-log *Cryptosporidium* inactivation credit. Based on the LT2ESWTR UV dose requirements as summarized in Table 1.4 of this manual, System Y needs a minimum germicidal dose of 5.8

mJ/cm² to receive this level of inactivation credit. The hypothetical proposed installation has the following design specifications:

Design flow range	3 – 10 mgd
Design UVT range	87 – 93 %
Lamp aging factor	80 %
Fouling factor	85 %
Fouling/Aging factor	68 % (80 % × 85 %)
Disinfection goal	2.0-log <i>Cryptosporidium</i> inactivation credit

The water system’s engineer selected a UV reactor with the following characteristics:

UV Reactor	<ul style="list-style-type: none"> - 1 bank of lamps - 6 8-kW MP lamps per bank - Ballast power settings range from 40 – 100 % - Rated for flow rates of 2.5 – 10 mgd - 1 germicidal UV sensor per lamp
UV Dose-Monitoring Approach	Calculated Dose Approach with dose pacing

B.2.1 Validation Test Plan

The test plan was developed using Checklist 5.2 in Chapter 5 to identify a range of target RED values at different flow rate-lamp output-UVT combinations for 1.0- to 3.0-log *Cryptosporidium* inactivation credit (depending on water quality and operating conditions). The UV manufacturer used modeled predictions of UV reactor performance to develop the desired validation test conditions. The UV manufacturer selected test conditions that target RED values ranging from approximately 4 – 43 mJ/cm² at UVT values of 85, 90, and 95 percent. Lamp power was to be adjusted during testing of the UV reactor to give RED values within the target range. Test flow rates of 2.5 – 10 mgd were selected in order to test the full design flow range of the UV reactor. This information is summarized in Table B.9 below.

Table B.9 Validation Test Conditions

Test ID	UVT (%)	Flow Rate (mgd)	Relative Lamp Output (%)	Predicted RED ³ (mJ/cm ²)
1	95	10	100	14.1
2	95	5	100	24.6
3	95	2.5	100	42.8
4	95	10	70	11.8
5	95	5	70	20.6
6	95	2.5	70	35.8
7	95	10	40	8.9
8	95	5	40	15.6
9	95	2.5	40	27.1
10	90	10	100	7.9
11	90	5	100	13.8
12	90	2.5	100	24.1
13	90	10	70	6.6
14	90	5	70	11.6
15	90	2.5	70	20.1
16	90	10	40	5.0
17	90	5	40	8.7
18	90	2.5	40	15.2
19	85	10	100	4.5
20	85	5	100	7.8
21	85	2.5	100	13.5
22	85	10	70	3.7
23	85	5	70	6.5
24	85	2.5	70	11.3
25	85	10	40	2.8
26	85	5	40	4.9
27	85	2.5	40	8.6

Other key test elements in the validation test plan include:

- The UV manufacturer provided three reference UV sensors for calibrating the duty UV sensors during validation. These reference UV sensors had been calibrated previously by an independent, qualified sensor testing laboratory and had a documented measurement uncertainty of 10 percent (Section 5.5.4).
- New lamps were used during validation testing (after a 100 hour burn-in period).
- The validation testing was conducted over a two-day period (Test Conditions 1 – 18 on Day 1 and Test Conditions 19 – 27 on Day 2). The UV dose-response of the challenge microorganism (measured via a collimated beam test) was evaluated with 1-L influent water samples at 95 percent UVT, collected on Day 1 of testing and at 85 percent UVT, collected on Day 2 of testing (Section C.1).

³ From the numerical model predictions developed by the manufacturer.

- All recommended testing protocols as listed in Section 5.7 and Appendix C were followed.

B.2.2 Test Data

The data collected during validation testing are presented in Tables B.10 through B.13 and are described below:

- Table B.10 presents the UV dose-response data measured on the influent water collected during field validation testing for the laboratory collimated beam test.
- Tables B.11 presents the flow rate, UVT, lamp power, and UV sensor readings measured for Test Conditions 1 – 9 (95 percent UVT). Testing was also conducted at 90 and 85 percent UVT. For simplicity, only the results of testing at 95 percent UVT are reported here.
- Table B.12 presents measured challenge microorganism concentrations for the influent and effluent samples collected (in triplicate) from the reactor for several test conditions. A total of 27 tests (one for each condition described in Table B.9) were run. For simplicity, only the first tests at UVT measurements of 95, 90, and 85 percent, respectively, are shown.
- Table B.13 presents data comparing the three reference UV sensor measurements to UV Duty Sensor #1 used during validation. Comparisons were made to all six duty sensors, but for simplicity only the results for Sensor #1 are reported here.

Sections B.2.3 to B.2.8 show how the data will be manipulated to determine whether QA/QC criteria are met, to calculate the necessary correction factors, and to determine the validated operating conditions for the target log inactivation.

Table B.10 Challenge Microorganism UV Dose-response Measured Using a Collimated Beam Apparatus

UV Dose (mJ/cm ²)	95% UVT				85% UVT				
	Replicate #1		Replicate #2		UV Dose (mJ/cm ²)	Replicate #1		Replicate #2	
	N (PFU/mL)	Log N	N (PFU/mL)	Log N		N (PFU/mL)	Log N	N (PFU/mL)	Log N
0	65560	4.82	67000	4.83	0	70440	4.85	70000	4.85
10	13270	4.12	15000	4.18	10	14400	4.16	16120	4.21
20	2790	3.45	2400	3.38	20	2590	3.41	2560	3.41
29	640	2.81	591	2.77	30	693	2.84	529	2.72
39	159	2.20	153	2.18	40	173	2.24	191	2.28
59	23	1.36	19	1.28	60	28	1.45	20	1.30

Table B.11 Flow Rate, UVT, Lamp Power, and UV Sensor Data Measured during Validation Testing (for UVT = 95% only)

Test ID	Banks On	Flow Rate (mgd)	UVT (%)	Lamp Power (kW)	Lowest Measured S _{duty} (W/m ²)
1	1	10	95	8.0	303.1
2	1	5	95	8.0	307.9
3	1	2.5	95	8.0	297.9
4	1	10	95	5.6	183.1
5	1	5	95	5.6	180.2
6	1	2.5	95	5.6	190.3
7	1	10	95	3.2	91.8
8	1	5	95	3.2	93.5
9	1	2.5	95	3.2	89.4

Table B.12 Measured Influent and Effluent Challenge Microorganism Conc. for Three Test Conditions (Three UVTs at 10 mgd and 100% Lamp Power)

Test ID	Influent Challenge Microorganism Log Concentration			Effluent Challenge Microorganism Log Concentration		
	Replicate			Replicate		
	#1	#2	#3	#1	#2	#3
1	4.92	4.8	4.87	3.79	3.69	3.70
10	4.88	4.89	4.83	3.94	4.01	3.94
19	4.93	4.90	4.91	4.24	4.28	4.29

Table B.13 Reference UV Sensor Checks for Duty Sensor #1

Before/After Validation Testing	UVT (%)	Lamp Power (kW)	Sensor ID	S _{duty #1} (W/m ²)	S _{ref, #1} (W/m ²)	S _{ref, #2} (W/m ²)	S _{ref, #3} (W/m ²)
Before	95	8	1	304.5	339.5	330.7	339.9
Before	95	3.2	1	80.2	90.9	86.2	82.7
Before	85	8	1	100.9	96.1	91.5	91.0
Before	85	3.2	1	23.2	20.9	21.3	20.9
After	95	8	1	320.2	301.1	315.0	330.4
After	95	3.2	1	69.6	76.5	76.3	78.3
After	85	8	1	99.4	99.4	93.2	91.3
After	85	3.2	1	19.3	20.4	20.4	20.0

B.2.3 Develop the UV Dose-response Curve from the Collimated Beam Data

Figures B.3(a) and (b) present the UV dose-response data from Table B.10 at UVT values of 85 and 95 percent, respectively. The data have been fitted to quadratic equations that show $\log N$ as a function of UV dose. The fits were used to identify $\log N_0$ values for the UV dose-response curves measured at 85 and 95 percent UVT (4.89 and 4.86, respectively). Table B.14 presents the UV dose-response data defined as UV dose versus $\log I$ ($\log [N_0/N]$).

The UV dose-response data described in Table B.14 were analyzed to determine if the two datasets could be combined using the method referred to in Section C.5 (Draper and Smith 1998).⁴ A statistical analysis of the collimated beam data is recommended to determine which terms are significant, $p\text{-value} \leq 0.05$, using a standard regression tool. The process is iterative, and each time the regression tool is used, one term is dropped until all coefficients are deemed significant, $p\text{-value} \leq 0.05$. In this example, three iterations were required.

The multiple regression analysis showed that the two measured UV dose-response curves were statistically similar and could be combined [i.e., they could each be expressed with only two variables, as $A \log I + B(\log I)^2$]⁵. Figure B.4 presents the plot of UV dose as a function of \log inactivation for the combined dataset and the resultant UV dose-response equation.

⁴ The datasets should be combined whenever possible to develop one dose-response equation for calculating all RED values. The inability to combine datasets indicates a problem may have occurred with either the calculation or the test. Details are provided in Section C.5

⁵ If the regression analysis had shown that the UV dose-response curves *could not* be combined, separate curves would have been used to calculate RED values for data collected on each day of testing (i.e., the curve for 95% UVT would be used to calculate RED for full-scale reactor testing data collected on Day 1, and the curve for 85% UVT would be used to calculate RED for full-scale reactor testing data collected on Day 2)

Figure B.3 Log N Versus UV Dose Using the Data in Table B.10 at (a) 85 Percent UVT and (b) 95 Percent UVT

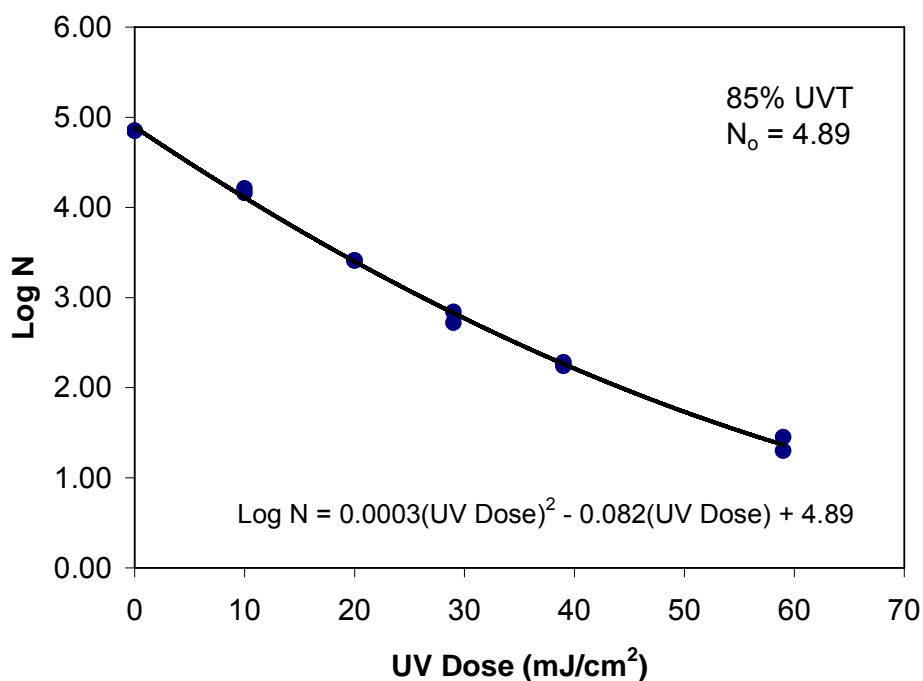

(a)

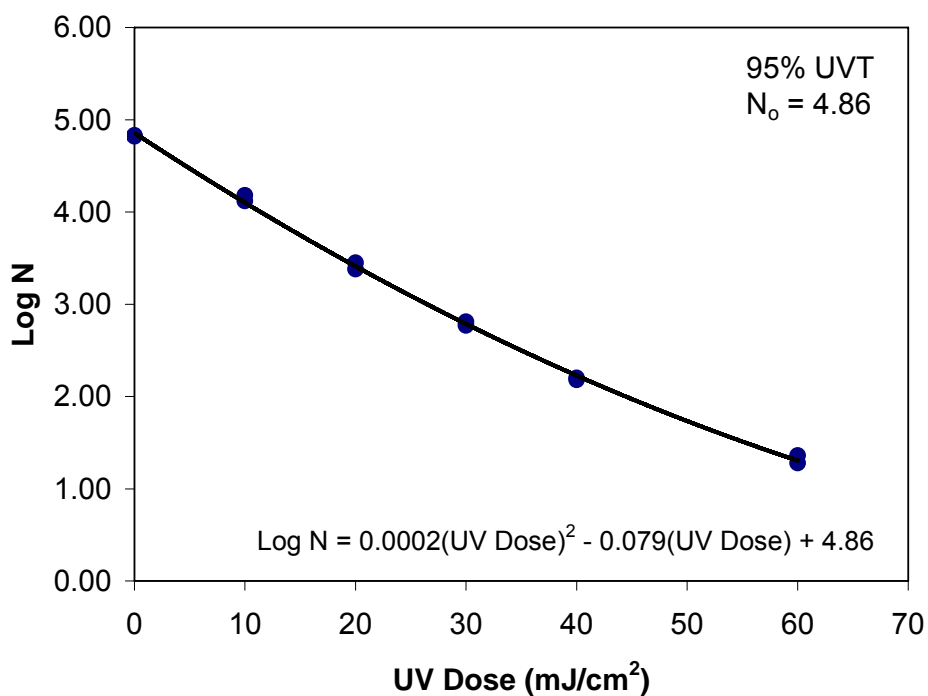

(b)

Table B.14 Challenge Microorganism UV Dose-Response Defined as UV Dose Versus Log(N/N₀) (i.e., Log I)

UV Dose (mJ/cm ²)	85% UVT		UV Dose (mJ/cm ²)	95% UVT	
	Replicate			Replicate	
	#1	#2		#1	#2
	4.89 - Log N			4.86- Log N	
0	0.04	0.04	0	0.04	0.03
10	0.73	0.68	10	0.74	0.68
20	1.48	1.48	20	1.41	1.48
29	2.05	2.17	30	2.05	2.09
39	2.65	2.61	40	2.66	2.68
59	3.44	3.59	60	3.50	3.58

Figure B.4 Log I Versus UV Dose Using the Data in Table B.14

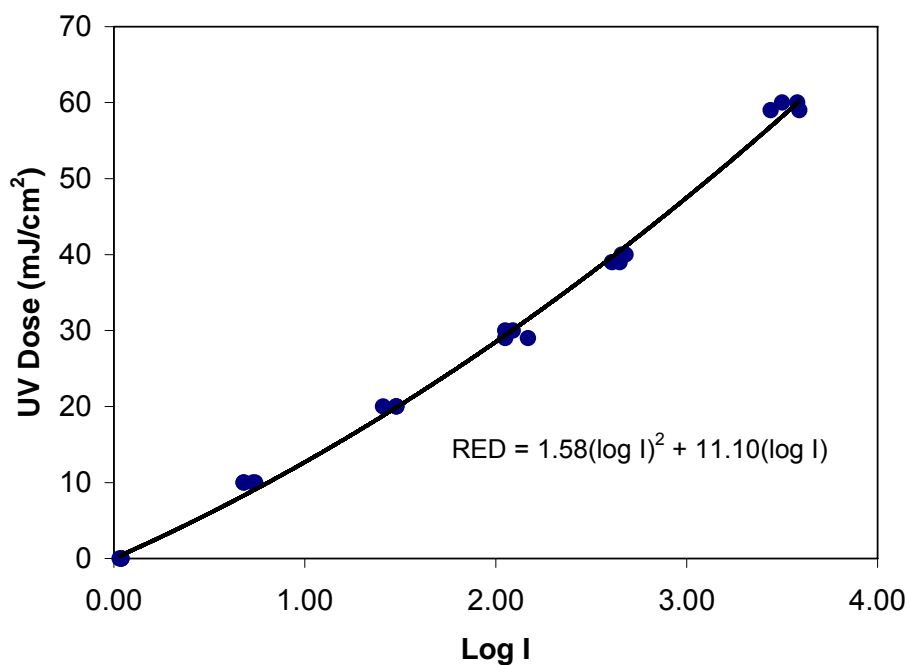

B.2.4 Verify That QA/QC Criteria Are Met

Checklist 5.4 was used to ensure that recommended QA/QC criteria were met. Calculations of key uncertainties are provided in the next two subsections.

B.2.4.1 Collimated Beam Data Uncertainty

The uncertainty in the UV dose calculation using the collimated beam data is calculated using Equation C.6, shown below as Equation B.7:

$$U_{DR} = t \frac{SD}{UV Dose_{CB}} \times 100\% \quad \text{Equation B.7}$$

where

- U_{DR} = Uncertainty of the UV dose-response fit at a 95-percent confidence level
- $UV Dose_{CB}$ = UV dose calculated from the UV dose-response curve in Figure B.4
- SD = Standard deviation of the difference between the calculated UV dose-response and the measured value from Table B.10
- t = t-statistic at a 95-percent confidence level for a sample size equal to the number of test conditions replicates used to define the dose-response

In this case, $SD = 1.2$ at 1.0-log inactivation and $t = 2.06$ for 24 test conditions from Table B.14. Equation B.7 can then be used to determine U_{DR} at various log inactivation values from Table B.10. The graph below shows the relationship between log inactivation and U_{DR} . As shown in the figure below, **$U_{DR} = 19\text{percent}$** at 1.0-log inactivation. This value is less than the recommended limit of 30 percent.

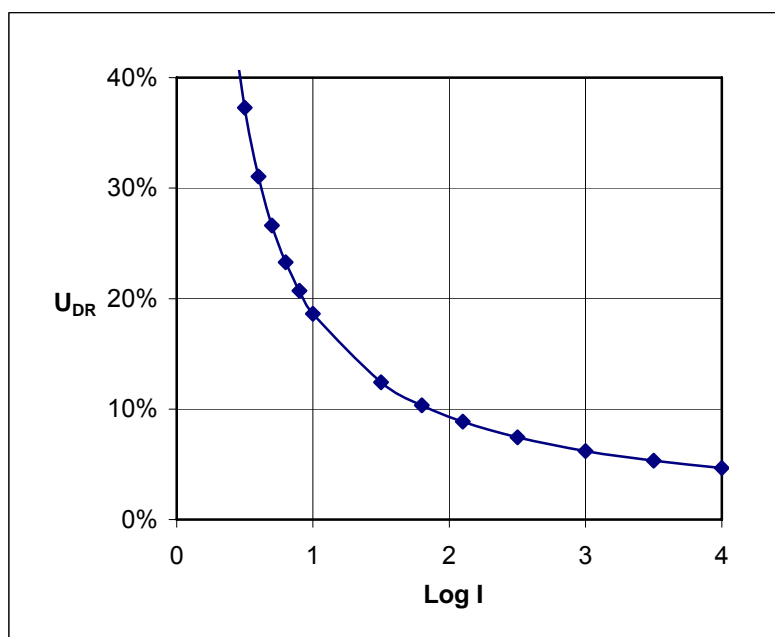

B.2.4.2 UV Sensor Uncertainty

Guidance in Section 5.5.4 recommends that the manufacturer's reported sensor uncertainty be confirmed as being less than 10 percent. Three reference sensors were used to confirm duty sensor measurements. Data analyses are shown below. The two duty UV sensors were within 10 percent of the average readings from three reference sensors.

Before/ After Validation Testing	UVT (%)	Lamp Power (kW)	S _{duty #1} (W/m ²)	S _{Ref,#1} (W/m ²)	S _{Ref,#2} (W/m ²)	S _{Ref,#3} (W/m ²)	S _{Ref,avg} (W/m ²)	$\left \frac{S_{duty}}{S_{Ref,avg}} - 1 \right $
Before	95	8.0	304.5	339.5	330.7	339.9	336.7	10%
Before	95	3.2	80.2	90.9	86.2	82.7	86.6	7%
Before	85	8.0	100.9	96.1	91.5	91.0	92.9	9%
Before	85	3.2	23.2	20.9	21.3	20.9	21.0	10%
After	95	8.0	320.2	301.1	315.0	330.4	315.5	1%
After	95	3.2	69.6	76.5	76.3	78.3	77.0	10%
After	85	8.0	99.4	99.4	93.2	91.3	94.6	5%
After	85	3.2	19.3	20.4	20.4	20.0	20.3	5%

Source of UV sensor data: Table B.13

B.2.5 Calculate Log Inactivation and RED

Table B.15 shows the measured log inactivation through the UV reactor and the associated RED values (determined from the UV dose-response equation) for each validation test condition. The log inactivation values were determined from the field inactivation data (excerpted in Table B.12).

Table B.15 Measured Log I and RED Values for Each Test Condition in Table B.11

Test ID	UVT	Log I			RED (mJ/cm ²)		
		Replicate #			Replicate #		
		1	2	3	1	2	3
1	95.1	1.13	1.11	1.17	15.7	15.4	16.3
2	94.8	1.36	1.35	1.34	19.2	19.0	19.0
3	94.8	1.66	1.63	1.67	23.9	23.5	24.1
4	95.4	1.03	1.09	1.12	14.2	15.2	15.6
5	94.6	1.28	1.27	1.35	18.0	17.8	19.1
6	94.8	1.55	1.56	1.59	22.2	22.4	22.9
7	94.7	0.91	0.92	0.90	12.5	12.6	12.4
8	94.5	1.16	1.17	1.20	16.2	16.3	16.8
9	95.5	1.39	1.39	1.44	19.7	19.7	20.4
10	90.0	0.94	0.88	0.89	12.8	12.0	12.1
11	89.9	1.13	1.11	1.14	15.7	15.3	15.9
12	90.1	1.35	1.42	1.39	19.1	20.1	19.6

Table B.15 Measured Log I and RED Values for Each Test Condition in Table B.11 (cont.)

Test ID	UVT	Log I			RED (mJ/cm ²)		
		Replicate #			Replicate #		
		1	2	3	1	2	3
13	90.1	0.85	0.81	0.86	10.6	10.0	10.7
14	90.1	1.05	1.03	1.07	13.4	13.1	13.7
15	89.8	1.30	1.29	1.34	17.1	17.0	17.7
16	89.6	0.67	0.73	0.74	8.2	8.9	9.0
17	89.6	0.91	0.94	0.95	11.5	11.8	12.0
18	90.0	1.21	1.17	1.22	15.7	15.2	15.9
19	84.6	0.68	0.62	0.62	8.3	7.5	7.5
20	84.7	0.87	0.91	0.87	10.9	11.4	10.9
21	84.6	1.17	1.17	1.18	15.1	15.1	15.3
22	84.7	0.56	0.55	0.54	6.7	6.6	6.4
23	85.4	0.84	0.76	0.77	10.4	9.4	9.5
24	85.3	1.07	1.03	1.07	13.7	13.1	13.7
25	85.1	0.42	0.47	0.44	4.9	5.6	5.1
26	85.4	0.64	0.67	0.67	7.8	8.1	8.1
27	85.5	0.93	0.94	0.95	11.7	11.8	11.9

B.2.6 Develop an Equation to Calculate RED as a Function of the Control Variables

To define an equation to calculate RED as a function of the operating conditions, the validation data were fitted for a 1-bank configuration using Equations 5.8 and 5.10, shown below as Equations B.8 and B.9 (there is only one bank of lamps, so it is not included as a variable here):

$$RED = 10^a \times A_{254}^b \times \left(\frac{S}{S_o}\right)^c \times \left(\frac{1}{Q}\right)^d \quad \text{Equation B.8}$$

Or in linear form,

$$\log(RED) = a + b \times \log(A_{254}) + c \times \log\left(\frac{S}{S_o}\right) + d \times \log\left(\frac{1}{Q}\right) \quad \text{Equation B.9}$$

where

- RED = The RED calculated with the UV dose-monitoring equation, also referred to as the “calculated dose” in this guidance manual
- A₂₅₄ = UV absorbance at 254 nm
- S = Measured UV sensor value
- S_o = UV intensity measured at 100 percent lamp power.
- Q = Flow rate
- a, b, c, d = Model coefficients obtained by fitting the equations to the data

Remember that the validation goal pursued in Example 2 is somewhat different from that in Example 1. In Example 1, the simplest possible method (Single Intensity Setpoint Approach) was desired. In Example 2, UV dose delivery will be paced to the operating conditions, so the goal is to develop an equation that provides the **best fit** of the data. In some validations, the user may try several different equation forms in an effort to find the best fit. The equation forms presented here were selected because they have been used successfully at full-scale for numerous UV reactors and operating conditions (Wright et al. 2005).

To develop a best-fit equation for RED in the form shown in Equation B.8 (or B.9 in linear form), a theoretical equation for S_0 should first be developed using validation test data to capture the variation in S_0 as a function of UVT. A strong goodness-of-fit as determined through statistical analysis allows the equation for S_0 to be used in development of the best-fit equation for RED.

1. Develop an expression for S_0 .

The term S_0 is the UV sensor measurement made with a new lamp operating at 100 percent power in a new, unfouled sleeve being monitored by a calibrated UV sensor through a new, unfouled UV sensor port window. S_0 varies with UVT. This relationship can be measured during validation or determined from the validation test conditions. In this example, S_0 is determined by fitting the validation data using the following relationship. As with Equations B.8 and B.9, this approach has proven successful for several validation tests (Wright 2005):

$$S = e^f e^{g \times UVT} P^h \tag{Equation B.10}$$

Equation B.10 can be expressed as:

$$\ln(S) = f + g \times UVT + h \times \ln(P) \tag{Equation B.11}$$

where P is the lamp power in units of kW and f , g , and h are model coefficients to be determined in the subsequent analysis. Fitting this equation to the data in Table B.11 at a 95-percent confidence level (UVT and P) using the regression tool within spreadsheet software gives the following values:

Term	Value	p-Statistic
f	-8.402	2.15×10^{-11}
g	0.115	1.61×10^{-13}
h	1.578	6.97×10^{-16}

Inputting these calculated values into Equation B.10 results in the following relationship (8 kW is the UV reactor’s maximum power setting, so $S = S_0$ when P is equal to 8 kW):

$$S = e^{-8.402} e^{0.115 \times UVT} P^{1.578} \tag{Equation B.12}$$

and

$$S_o = e^{-8.402} e^{0.115 \times UVT} 8^{1.578} \quad \text{Equation B.13}$$

The goodness of fit was evaluated by determining the p-statistic for the model coefficients in Equation B.13 (see Draper and Smith 1998 or similar for procedure). The p-statistic of each model coefficient was determined and found to be ≤ 0.05 .

2. Calculate $\log(S/S_o)$.

By defining S as the measured UV sensor readings in Table B.11, Equation B.13 is then used to predict S_o and to produce the data that will be fit to Equation B.9. The UVT (measured as A_{254} values and converted to UVT units), S_{duty} and Q values are from the measured data (Tables B.9 and B.15).

3. Calculate an expression for RED.

As with the UV dose-response equations (shown in Figure B.4) and the sensor equations (Equations B.12 and B.13), the interpolation equation (Equation B.9) is fitted to the data in Table B.15 using a regression tool in spreadsheet software (at a 95-percent confidence level). The goodness-of-fit was again evaluated by determining the p-statistic for the model coefficients in Equation B.14 (Draper and Smith, 1998). The p-statistic of each model coefficient was determined to be ≤ 0.05 (i.e., all were significant). The results of this analysis are shown below with the following results:

Term	Value	p-Statistic	Term	Value	p-Statistic
a	-0.829	7.76×10^{-16}	c	0.166	1.21×10^{-19}
b	-2.519	3.71×10^{-42}	d	0.409	9.35×10^{-42}

Inputting these calculated values into Equation B.9 results in the following:

$$\log(\text{RED}) = -0.829 - 2.519 \times \log(A_{254}) + 0.166 \times \log\left(\frac{S}{S_o}\right) + 0.409 \times \log\left(\frac{1}{Q}\right) \quad \text{Equation B.14}$$

Equation B.14 can be used to calculate RED values as a function of the operating conditions (measured UVT, flow rate, and UV intensity) provided S_o is calculated using Equation B.13.

This equation can be programmed within the UV reactor's program logic controller (PLC) to calculate the delivered RED as a function of the current operating conditions for UV dose-monitoring. The equation can be used for interpolation over the validated range of flow rates (2.5 – 10 mgd), UVT values (85 – 95 percent), and RED values (8.5 – 24.1 mJ/cm²). If the flow rate falls below 2.5 mgd, the PLC should default to 2.5 mgd in the dose-monitoring

equation. If the UVT reads above 85 percent, the PLC should default to 95 percent in the dose-monitoring equation.

B.2.7 Determine the Validation Factor

The Validation Factor (VF) is defined according to Equation 5.13, shown below as Equation B.15:

$$VF = B_{RED} \times (1 + U_{val} / 100) \quad \text{Equation B.15}$$

B.2.7.1 Calculate the RED Bias

Per guidance provided in Section 5.9.1, the UV sensitivity for the test condition with the lowest UVT (85 percent) was calculated to range from 13 – 14 mJ/cm² per log inactivation. From Table G.5 (for a 2.0-log *Cryptosporidium* inactivation credit), the RED bias for the maximum UV sensitivity of 14 mJ/cm² is 2.01.

B.2.7.2 Calculate the Uncertainty of Validation

The decision tree in Figure 5.5 was used to determine the correct equation for U_{VAL}. As shown in B.2.4.1, U_{DR} is less than or equal to 30 percent. As noted in B.2.4.2, U_S is less than or equal to 10 percent. Therefore, the equation for U_{VAL} is as follows:

$$U_{val} = U_{IN} \quad \text{Equation B.16}$$

U_{IN} is defined by Equation 5.15:

$$U_{IN} = \frac{t \times SD}{RED} \times 100\% \quad \text{Equation B.17}$$

where

- SD = Standard deviation of the differences between the test RED (based on the observed log inactivation and UV dose-response curve), and the RED calculated using the dose-monitoring equation for each replicate
- RED = The RED as calculated using the dose-monitoring equation

The value of U_{val} (i.e., U_{IN}) can be expressed in one of two ways:

1. As a single value, the most conservative (largest) uncertainty value calculated for the validated range. This is typically based on the lowest calculated RED value.
2. As a function of the calculated RED, that is, as a variable number.

In this example, more than 30 test measurements were made for RED, so the t-statistic is 2.04. The standard deviation was determined from the RED values recorded during testing and the RED values calculated using the dose-monitoring equation (equation B.14). The value of SD was determined to be 0.97.

The water system does not plan to operate below a calculated RED value of 15 mJ/cm², so a single value of U_{IN} can be calculated as $(2.04 \times 1.0) / 15 = 0.136$. The following equation can be used if U_{IN} is calculated as a function of RED at another location (of the same UV reactor):

$$U_{IN} = \frac{t \times \sigma}{RED} \times 100\% = \frac{2.04 \times 0.97}{RED} = \frac{1.98}{RED} \quad \text{Equation B.18}$$

where

RED = the RED calculated from the dose-monitoring equation (equation B.14)

B.2.7.3 Calculate the Validation Factor

If the user prefers to use one U_{IN} value, a single VF is determined using the following equation:

$$VF = 2.01 \times \left(1 + \frac{1.98}{15} \right) = 2.28 \quad \text{Equation B.19}$$

If a user at another water system preferred to use U_{IN} as a function of the calculated RED, the following equation would be used for calculating the VF:

$$VF = 2.01 \times \left(1 + \frac{U_{Val}}{100} \right) = 2.01 \times \left(1 + \frac{1.98}{RED} \right) = 2.01 + \frac{3.98}{RED} \quad \text{Equation B.20}$$

B.2.8 Calculate the Validated Dose

In the last step, the calculated RED associated with the operating conditions is divided by the VF to produce the validated dose:

$$D_{Val} = \frac{RED}{VF} \quad \text{Equation B.21}$$

where

RED = RED calculated from the dose-monitoring equation (Equation B.14)

VF = Validation Factor (either Equation B.19 or Equation B.20)

To calculate D_{VAL} using a point estimate for the VF, use Equation B.22:

$$D_{Val} = \frac{RED}{2.28} \quad \text{Equation B.22}$$

To calculate a general expression with VF as a function of RED, to determine D_{Val} , Equation B.20 would be substituted into Equation B.21:

$$D_{Val} = \frac{RED}{2.01 + \frac{3.98}{RED}} \quad \text{Equation B.23}$$

B.2.9 Assign Log Inactivation Credit for the Validated Dose(s)

The validated dose must be greater than or equal to the required UV dose in Table 1.4 (D_{req}) to achieve a given level of pathogen inactivation credit:

$$D_{Val} \geq D_{req} \quad \text{Equation B.24}$$

or

$$D_{Val} \geq 5.8 \text{ mJ/cm}^2 \quad \text{Equation B.25}$$

System Y is in the validated range when the calculated RED from the dose monitoring equation is greater than or equal to $5.8 \text{ mJ/cm}^2 \times 2.28$ or 13.4 mJ/cm^2 . (A similar calculation would follow if a different water system preferred VF to vary with RED.)

The UV reactor can receive 2.0-log *Cryptosporidium* inactivation credit for an installation (with adequate inlet/outlet hydraulics, see Section 5.4.5) that operates under the criteria outlined in Table B.18:

Table B.18 Validated Dose and Operating Conditions for 2.0-log *Cryptosporidium* Inactivation Credit Using the Hypothetical Reactor Tested in Example 2

Validated Conditions			
Flow Rate Range ¹	UVT Range ²	Lamp Power Range	RED ³
≤10 mgd	≥ 85%	3.2 – 8 kW	≥ 13.4 mJ/cm ²

¹ At flow rates below 2.5 mgd, this value (2.5 mgd) should be used as the default value in the RED calculation.

² At UVT values above 95 %, this value (95% UVT) should be used as the default value in the RED calculation.

³ Calculated using equations B.13 and B.14.

Appendix C

Collimated Beam Testing to Develop a UV Dose-response Curve

This page intentionally left blank.

The LT2ESWTR requires that validation testing be conducted using “a test microorganism whose dose-response characteristics have been identified with a low pressure mercury vapor lamp” [40 CFR 141.720 (d)(2)(ii)]. To accomplish this, EPA recommends using a collimated beam study of the test (or challenge) microorganism, as described in this appendix. The procedure involves placing sample water with the challenge microorganism in an open cylindrical container (e.g., a petri dish) and exposing the sample to collimated UV light for a predetermined amount of time. The UV dose is calculated using the measured intensity of the UV light, UV absorbance of the water, and exposure time. The measured concentration of microorganisms before and after exposure provides the “response,” or log inactivation of the microorganisms from exposure to UV light. Regression analysis of measured log inactivation for a range of UV doses produces the dose-response curve (sometimes expressed as a “dose-response equation”).

This appendix describes the recommended collimated beam testing procedure and recommended data analyses for developing the UV dose-response curve. Section C.1 provides guidelines for identifying test conditions. Section C.2 discusses all aspects of experimental testing for the collimated beam study. Data analyses are discussed in Section C.3, followed by a discussion of data uncertainty in Section C.4. Specific recommendations for combining dose-response curves and limitations on applying results when the challenge microorganism exhibits a shoulder or tailing are presented in Sections C.5 and C.6, respectively. Documentation of test conditions and all results should be included in the Validation Report (see Section 5.11 for guidance).

C.1. Identifying Test Conditions

At least two water quality conditions should be tested by collimated beam analysis:

1. The highest UV transmittance (UVT) used in the full-scale reactor test
2. The lowest UVT used in the full-scale test

Because UVT is accounted for in the UV dose calculation, the test conditions should produce similar results that can be combined to produce one UV dose-response curve. (Performing two tests instead of one test verifies that the UV dose is independent of UVT.)

UV doses should be selected to cover the range of targeted values, using a minimum of five data points plus a control [zero (0) UV dose]. The selected UV doses should result in challenge microorganism inactivation ranging from 0.5 – 1 log unit higher than the highest log inactivation to be demonstrated by the UV reactor. Table C.1 shows a sample test matrix.

At least one collimated beam test should be conducted on each day of full-scale reactor testing.

Table C.1. Sample Collimated Beam Test Matrix for Target of 2.0-Logs Inactivation of *Cryptosporidium* and MS2 Phage as the Challenge Microorganism

Sample ¹	Test Condition ²	Log Inactivation	Target UV Doses (mJ/cm ²) ³
Lowest UVT	1	0 (control)	0
	2	0.5	10
	3	1.5	30
	4	2.0	40
	5	2.5	50
	6	3.0	60
Highest UVT	7	0 (control)	0
	8	0.5	10
	9	1.5	30
	10	2.0	40
	11	2.5	50
	12	3.0	60

¹ The sample should represent the influent water used in full-scale reactor tests. One sample should reflect the lowest UVT tested, and one should reflect the highest UVT tested. Dose-response curves should be developed separately for each water quality condition tested and compared to determine if they can be combined (see Section C.5).

² Each test condition should be repeated at least twice (resulting in a minimum of two test condition replicates), and three test condition replicates will likely improve the quality of the fit for the dose-response curve.

³ Based on UV sensitivity of MS2 Phage

C.2 Measuring the UV Dose-response of the Challenge Microorganism

The challenge microorganism's UV dose-response should be measured using a low-pressure (LP) collimated beam apparatus (Figure C.1). This apparatus comprises an enclosed UV lamp and a tube with a non-reflective inner surface. The UV light enters the suspension with a near zero-degree angle of incidence and is relatively homogenous across the surface area. The UV dose delivered to the suspension is calculated using measurements of incident UV intensity, exposure time, suspension depth, and the absorption coefficient of the suspension.

Section C.2.1 provides a physical description of the collimated beam apparatus and recommendations for operational controls. Accuracy of monitoring equipment is addressed in Section C.2.2. Section C.2.3 provides the recommended test procedure, followed by equations for UV dose calculations in C.2.4.

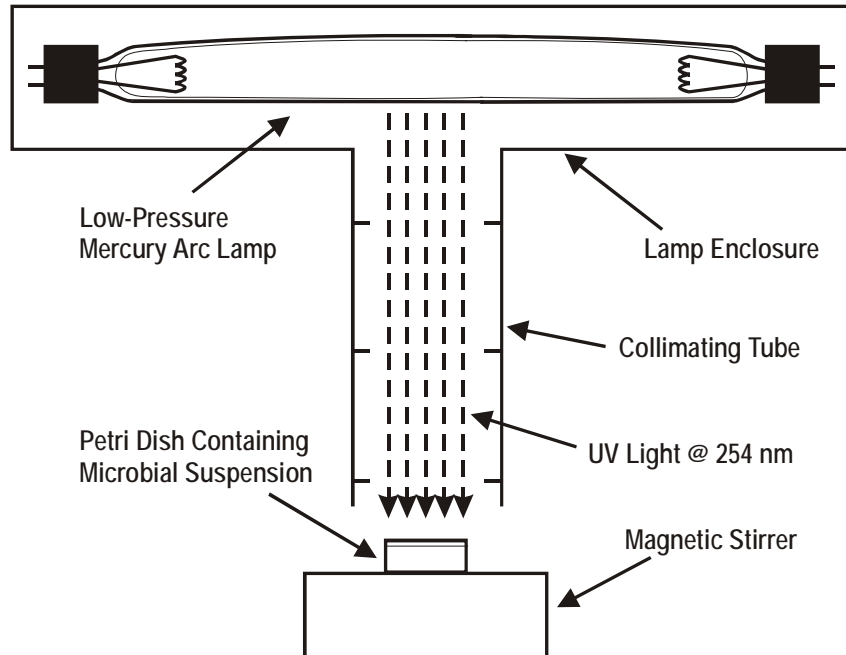
Figure C.1. Collimated Beam Apparatus

Note: To measure intensity of UV light, a calibrated radiometer is positioned below the column in place of the petri dish.

C.2.1 Apparatus Design and Operation

Because UV dose requirements are based on the pathogen inactivation achieved using 254-nm light, the collimated beam apparatus should use a lamp that emits germicidal UV light only at 254 nm (i.e., a LP lamp). To prevent ozone formation, lamps that emit 185-nm light should not be used. The output from the lamp measured using a radiometer should vary by no more than 5 percent over the exposure time. A stable lamp output can be obtained by driving the lamp with a constant power source and maintaining the lamp at a constant operating temperature. If the line voltage is not sufficiently stable, a voltage regulator may be used to obtain a stable power supply. A stable temperature can be obtained by controlling the airflow around the lamp.

The UV lamp should be located far enough above the surface of the microbial suspension so that uniform irradiance is obtained across the sample's surface and UV light enters the suspension with a near zero-degree angle of incidence (Blatchley 1997). A recommended minimum distance from the lamp to the suspension is six times the longest distance across the suspension's surface. In order to vary the UV intensity incident on the suspension, the distance between the suspension and the lamp can be adjusted.

The uniformity of the intensity field across the sample's surface should be assessed by measuring the "Petri Factor," defined as the ratio of the average irradiance across the suspension surface to the irradiance measured at the center (Bolton and Linden 2003). The average irradiance is determined by averaging radiometer measurements taken at each point in a 5-mm spaced grid across an area defined by the suspension's surface. If the radiometer's sensing

window is wider than 5 mm, it should be reduced using a cover slip with a small hole. The collimated beam apparatus should have a Petri Factor greater than 0.9.

The lamp and the light path from the lamp to the suspension should be enclosed to protect the user from exposure to UV light. A box-like enclosure made of aluminum is often used. A length of pipe is often used to enclose the light path from the lamp to the microbial suspension. The inside surface of the pipe should have a low UV reflectance and incorporate apertures to improve UV light collimation (Blatchley 1997). A shutter mechanism is sometimes used to control the exposure of the suspension to UV light. The exposure times should be measured with an uncertainty of 5 percent or less. Exposure times less than 20 seconds are not recommended.

The microbial suspension should be irradiated in an open cylindrical container (e.g., petri dish). The diameter of the container should be smaller than the diameter of the light beam incident on the container. Sample depth should be 0.5 – 2 cm. The material of the container should not adsorb the challenge microorganism enough to impact its measured UV dose-response.

Sample volumes irradiated in the container should be sufficient for measuring the challenge microorganism's concentration after irradiation. The microbial suspension should be mixed using a stir bar and a magnetic stirrer at a rate that does not induce vortices. The volume and diameter of the stir bar should be small relative to the volume and depth of the sample.

The irradiance at the center of the suspension's surface before and after exposure to UV light should be measured using a UV radiometer calibrated at 254 nm. During measurement, the radiometer's calibration plane should match the height of the suspension's surface and be perpendicular to the incident UV. The calibration plane of the radiometer should be specified in the radiometer's calibration certificate.

C.2.2 Accuracy of Monitoring Equipment

Similar to the recommended procedures for full-scale reactor testing in Chapter 5, spectrophotometer measurements of A_{254} should be verified using NIST¹-traceable potassium dichromate UV absorbance standards and holmium oxide UV wavelength standards. The measurement uncertainty of the spectrophotometer should be **10 percent or less**. See Section 5.5.2 for additional guidance on spectrophotometer use and the recommended procedure for verifying spectrophotometer measurements.

Radiometers should be calibrated according to the following procedure to ensure that the UV intensity is measured with an uncertainty of **8 percent or less** at a 95-percent confidence level:

1. The radiometers used in the collimated beam tests should come from the manufacturer with a certified uncertainty of 8 percent or less at a 95-percent confidence level at the intervals suggested by the manufacturer.

¹ National Institute of Standards and Technology

2. At minimum, the accuracy of the radiometer used to measure the UV intensity should be verified at least at the beginning and the end of each collimated beam test session using a second radiometer.
3. The two radiometers should read within 5 percent of each other. If the two radiometers do not read within 5 percent of each other, a third radiometer should be used to identify which radiometer is out of specification. The two radiometers with readings within 5 percent of each other should be used. If none of the radiometer readings match, at least two of them are likely out of calibration.

If the above criteria are met, the average radiometer measurement can be used in calculations. Alternatively, the radiometer that provides the lowest reading could be used. If these criteria are not met, the radiometers should be recalibrated. The radiometers should also be checked to be sure that the irradiance measurement does not differ by more than 5 percent before and after UV exposure.

C.2.3 Recommended Collimated Beam Test Procedure

Researchers should collect a sample from the influent sampling port of the biosimetry test stand (or the influent sample for on-site reactor testing to be used for collimated beam testing) for collimated beam testing. Typically, a 1 liter sample is sufficient. If the testing extends over more than one day, at least one collimated beam test should be conducted for each day of testing. If different batches of challenge microorganisms are used, a UV dose-response curve should be generated for each batch.

Personnel who perform collimated beam tests should be experienced with the use and safety requirements of the equipment. Safety goggles and latex gloves should be worn. Skin should be shielded from exposure to UV light. Personnel should follow recommended procedures for challenge microorganism preparation and analysis as presented in Appendix A of this guidance manual or use an alternative peer-reviewed method.

The following procedure is recommended for collimated beam testing of a water sample containing challenge microorganisms:

1. Measure the A_{254} of the sample using a spectrophotometer that has a measurement uncertainty of 10 percent or less (see guidance on spectrophotometer measurements in Sections C.2.2 and 5.5.2).
2. Place a known volume from the water sample into a petri dish and add a stir bar. Measure the water depth in the petri dish.
3. Measure the UV intensity delivered by the collimated beam with no sample present using a calibrated radiometer (see Section C.2.2 for guidance on calibrating monitoring equipment).
4. Calculate the required exposure time to deliver the target UV dose using Equation C.2 (described in the next section).

5. Block the light from the collimating tube using a shutter or equivalent.
6. Center the petri dish with the water sample under the collimating tube.
7. Unblock the light from the collimating tube and start the timer.
8. When the target exposure time has elapsed, block the light from the collimating tube.
9. Remove the petri dish and collect the sample for measurement of the challenge microorganism concentration. If the sample is not assayed immediately, store in the dark at 4 °C. Each sample should be plated in triplicate and the average microbial value for the sample calculated from the three plate replicates.
10. Re-measure the UV intensity and calculate the average of this measurement and the measurement taken in Step 3. The value should be within 5 percent of the value measured in Step 3.
11. Using Equation C.1 (described in the next section), calculate the UV dose applied to the sample based on experimental conditions (this should be similar to the target dose).
12. Repeat steps 1 through 11 for each replicate and target UV dose value (see Table C.1). Repeat all steps for each water test condition replicate

C.2.4 UV Dose Calculation

The UV dose delivered to the sample is calculated using:

$$D_{CB} = E_s P_f (1 - R) \frac{L}{(d + L)} \frac{(1 - 10^{-A_{254}d})}{A_{254}d \ln(10)} t \quad \text{Equation C.1}$$

where:

- D_{CB} = UV dose (mJ/cm²)
- E_s = Average UV intensity (measured before and after irradiating the sample) (mW/cm²)
- P_f = Petri Factor (unitless)
- R = Reflectance at the air-water interface at 254 nm (unitless)
- L = Distance from lamp centerline to suspension surface (cm)
- d = Depth of the suspension (cm)
- A_{254} = UV absorbance at 254 nm (unitless)
- t = Exposure time (s)

Alternatively, given a target UV dose, the required exposure time may be calculated by rearranging Equation C.1.

$$t = D \frac{1}{E_s P_f (1 - R)} \frac{d + L}{L} \frac{A_{254} d \ln(10)}{(1 - 10^{-A_{254} d})} \quad \text{Equation C.2}$$

The term $L/(d + L)$ accounts for the divergence of the UV light from the collimated beam as it passes through the suspension. The reflectance at the air-water interface (R) can be estimated using Fresnel's Law as $1.000/1.372$, or 0.025 (the index of refraction of air divided by the index of refraction for water).

To control for error in the UV dose measurement, the uncertainties of the terms in the UV dose calculation should meet the following criteria:

Depth of suspension (d)	≤ 10%
Average incident irradiance (E_s)	≤ 8%
Petri Factor (P_f)	≤ 5%
$L/(d + L)$	≤ 1%
Time (t)	≤ 5 %
$(1 - 10^{-ad})/ad$	≤ 5%

The uncertainty in incident irradiance can be determined by the procedure for evaluating uncertainty of radiometer measurements as presented in Section C.2.2. The remaining uncertainties listed above should be estimated by laboratory personnel and documented in the Validation Report (See Section 5.11 for guidance).

C.3 Developing the UV Dose-response Curve

Collimated beam tests produce the following types of experimental data:

- UV Dose in units of mJ/cm^2 ,
- Concentration of microorganisms in the petri dish prior to UV exposure (N_o) in units of pfu/mL, and
- Concentration of microorganisms in the petri dish after UV exposure (N) in units of pfu/mL.

One UV dose-response curve should be developed for each UVT condition tested (typically high and low). If full-scale reactor testing spans more than one day, at least one UV dose-response curve should be developed for each day of testing.

EPA recommends using *regression analysis* to develop each UV dose-response curve using the following steps:

1. For each test condition and replicate, plot log N vs. UV dose to identify a common N_0 as the intercept of the curve at UV dose = 0 (an example is illustrated in Figure C.2).²

Figure C.2. Fitting Effluent Concentration vs. UV Dose to Determine a Common Influent Concentration Value

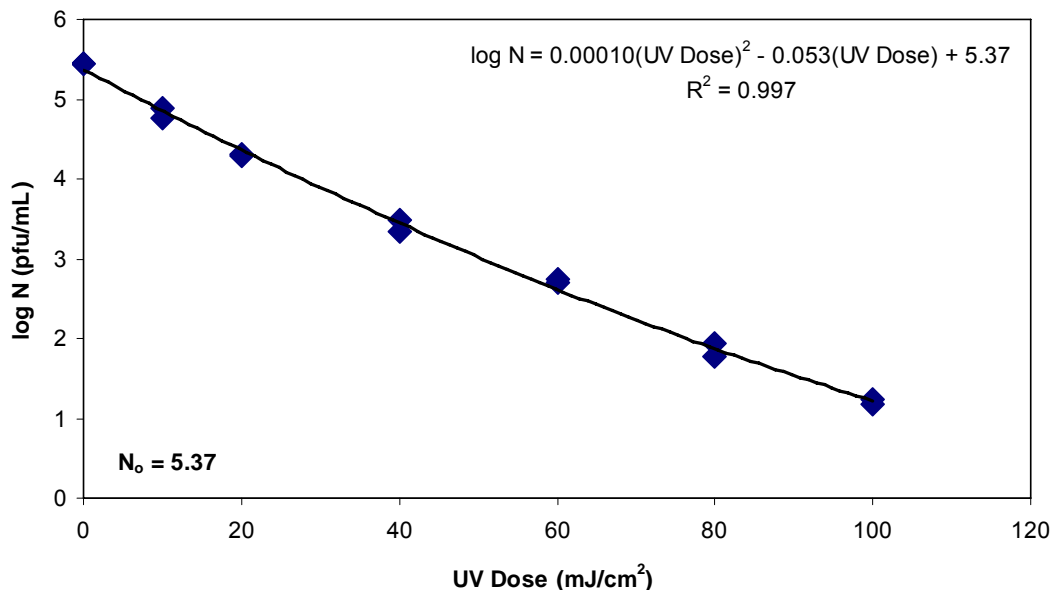

2. Calculate log I for each measured value of N (including zero-dose) and the common N_0 identified in Step 1 using the following equation:

$$\log I = \log\left(\frac{N_0}{N}\right) \quad \text{Equation C.3}$$

where:

- N_0 = The common N_0 identified in Step 1 (pfu/mL)
- N = Concentration of challenge microorganisms in the petri dish after exposure to UV light (pfu/mL)

The log inactivation for each replicate should be averaged to produce one value of log I per test condition.

3. Plot UV dose as a function of log I for each test condition.
4. Use regression analysis to derive an equation that best fits the data, forcing the fit through the origin. The equation will have different forms depending on the data. For challenge microorganisms exhibiting first-order kinetics, a linear equation should be used:

² If the measured value of N_0 is used for this calculation, any experimental or analytical error in the measured value is carried to all the data points, adding an unrelated bias to each measurement. Therefore, using the y-intercept of the curve is recommended.

$$UV \text{ Dose} = A \times \log I \quad \text{Equation C.4}$$

See Figure C.3 for an example of a linear UV dose-response curve.

Figure C.3. Typical *E. coli* UV Dose-response Curve

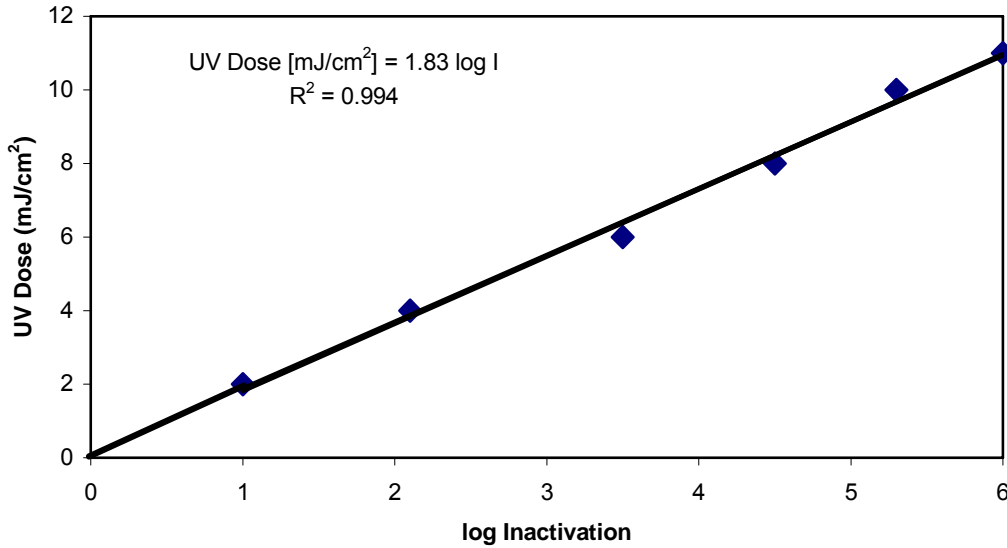

A quadratic equation can also be used, as illustrated in the example in Figure C.4:

$$UV \text{ Dose} = A \times \log I + B \times (\log I)^2 \quad \text{Equation C.5}$$

Figure C.4. Typical MS2 UV Dose-response Curve

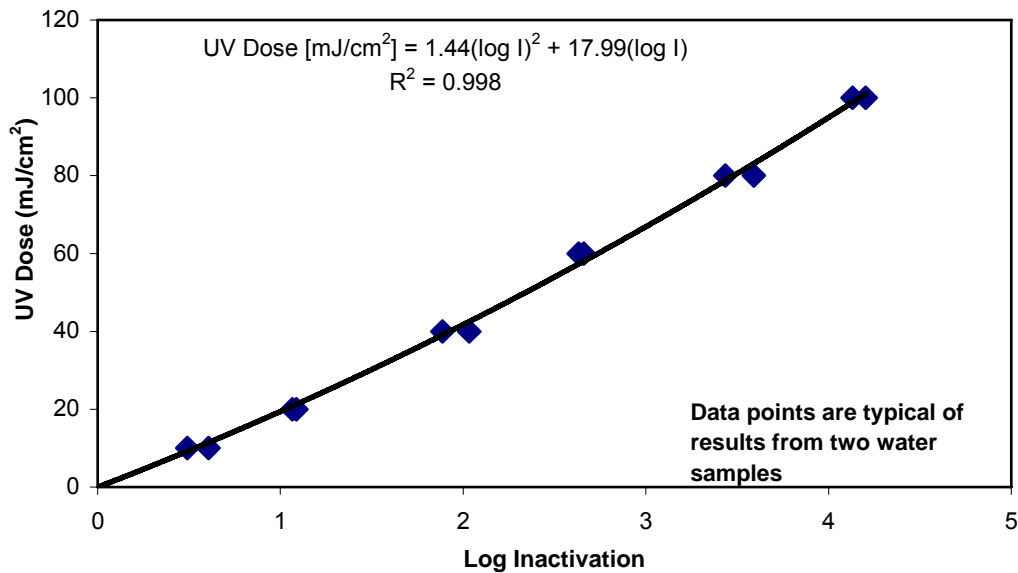

5. Evaluate the equation's goodness-of-fit—the differences between the measured UV dose values and those predicted by the equation should be randomly distributed around zero and not be dependent on UV dose. The goodness of the fit can be examined by standard statistical tests, such as examining the p-statistics for the regression coefficients.

Note that the resulting equation should not be used for extrapolation outside of the measured range of UV dose.

C.4 Collimated Beam Data Uncertainty

As noted in Section C.3, collimated beam data will often be fit to a linear or a polynomial regression. The 95-percent confidence interval (U_{DR}) can be calculated using standard statistical methods, such as those described in Draper and Smith 1998, or can be conservatively estimated using Equation C.6.

$$U_{DR} = t \frac{SD}{UV \text{ Dose}_{CB}} \times 100\% \quad \text{Equation C.6}$$

where:

- U_{DR} = Uncertainty of the UV dose-response fit at a 95-percent confidence level
- $UV \text{ Dose}_{CB}$ = UV dose calculated from the UV dose-response curve for the challenge microorganism
- SD = Standard deviation of the difference between the calculated UV dose-response and the measured value
- t = t-statistic at a 95-percent confidence level for a sample size equal to the number of test condition replicates used to define the dose-response³

Number of Data Points Used to Develop the Dose-Response Equation	t	Number of Data Points Used to Develop the Dose-Response Equation	t
10	2.23	17	2.11
11	2.20	18	2.10
12	2.18	19-20	2.09
13	2.16	21	2.08
14	2.14	22-23	2.07
15	2.13	24-26	2.06
16	2.12	27-29	2.05
		≥30	2.04

If UV dose-response curves can be combined (as described in the next Section, C.5), the combined dataset should be used to calculate U_{DR} . If individual dose-response curves cannot be combined, U_{DR} should be calculated separately for each curve.

³ For example, one test condition evaluated twice (two test condition replicates) with five UV dose points each would have a total of ten points.

EPA recommends that the value of U_{DR} (calculated by Equation C.6) not exceed **30 percent** at the UV dose corresponding to 1-log inactivation of the challenge organism (e.g., 18 mJ/cm² for MS2). If the 95-percent *confidence interval* is calculated using standard statistical methods, U_{DR} should not exceed **15 percent** at the UV dose corresponding to 1-log inactivation of the challenge organism.⁴ If there is more than one estimate of U_{DR} (i.e., UV dose-response curves cannot be combined), the maximum U_{DR} should be used to determine if it meets this criterion.

If the U_{DR} value calculated by Equation C.6 is greater than 30 percent (15 percent if the standard statistical method is used), it should be added to the total uncertainty of validation [e.g., $U_{Val} = (U_{IN}^2 + U_{DR}^2)^{1/2}$, see Section 5.9.2]. This allows for a validation plan that is sufficiently flexible to continue using the dose-response curve at low values, but will increase the U_{Val} accordingly. Similarly, if UV dose-response curves cannot be combined and one or more of the individual curves exhibits a U_{DR} value greater than 30%, the maximum value should be used in calculating the total uncertainty of validation [$U_{Val} = (U_{IN}^2 + U_{DR}^2)^{1/2}$].

C.5 Combining UV Dose-response Curves

Analysis of regression coefficients indicates whether or not UV dose-response curves developed using different water samples can be combined. In order for the UV dose-response curves to be combined, differences between the regression coefficients should not be statistically significant at a 95-percent confidence level.⁵ If differences in the coefficients are statistically significant, the reason for this difference should be documented in the Validation Report. Differences between measured UV dose-response curves for different water samples could indicate one or more of the following:

1. The UV dose-responses of different batches of the challenge microorganism differ. In this case, the UV dose-response curve specific to each cultured batch of the challenge microorganism should be used to assess UV dose delivery for the validation test conditions using that batch.
2. Interferences due to water quality, such as coagulation or inactivation of the challenge microorganism. In this case, mitigate the cause of the interference or account for the interference when assessing UV dose delivery for the validation test conditions.
3. Errors calculating the UV dose delivered by the collimated beam apparatus. Mismeasuring the incident UV intensity or the UV absorbance of the water sample could introduce such errors.

If differences between UV dose-response curves cannot be resolved, a single curve corresponding to one day's worth of full scale reactor testing can be used to calculate RED values for that day (i.e., there will be one UV dose-response curve per day of full-scale reactor validation testing). If two or more UV dose-response curves from the same day of testing cannot be combined, the curve resulting in the most conservative (lowest) UV dose should be used for

⁴ This criterion (15 percent) differs from the criterion of 30 percent applied to Equation C.6 due to simplifications incorporated into Equation C.6.

⁵ A good description for performing this test is provided in Draper and Smith, 1998.

calculating RED values. If different curves are used for RED calculations, the UV sensitivity of the challenge microorganism and shape of each UV dose-response curve should be consistent with expected inactivation behavior for that challenge microorganism.

C.6 Using Challenge Microorganisms with Shoulders or Tailing

In the case of a challenge microorganism with a shoulder or tailing in the UV dose-response, the UV sensitivity should be defined as the sensitivity over the region of linear log inactivation that occurs between the shoulder and the onset of tailing. The shoulder of the UV dose-response is defined as the point of intersection of the exponential region with the UV dose axis (see Figure C.5). The UV dose-response of the challenge microorganism should not demonstrate a shoulder at a UV dose beyond 50 percent of the demonstrated (measured) RED range, and should not demonstrate tailing until at least one log inactivation beyond the demonstrated (measured) inactivation range.

Figure C.5. UV Dose-response of *B. subtilis* Spores

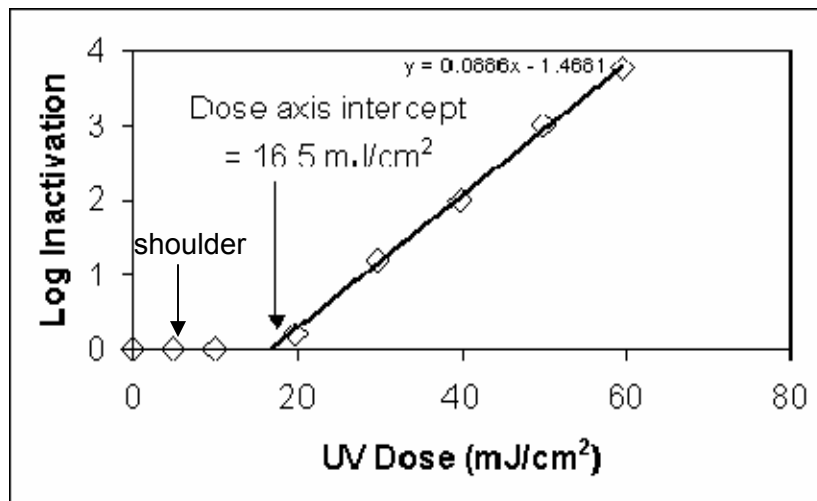

(Adapted from Sommer et al. 1998)

Example C.1. The UV dose-response of *B. subtilis* spores has a shoulder at low UV dose values (Figure C.5). Because the measured UV dose-response has a shoulder of 16.5 mJ/cm², the *B. subtilis* spores should only be used to demonstrate RED values greater than or equal to $2 \times 16.5 \text{ mJ/cm}^2 = 33 \text{ mJ/cm}^2$.

Appendix D

Background to the UV Reactor Validation Protocol

This page intentionally left blank.

This appendix provides background material for the validation protocol given in Chapter 5. The background material is organized into the following six sections.

- **UV dose delivery by UV reactors.** Section D.1 describes why a correction factor (termed the “RED bias”) should be applied in the Validation Factor calculation to account for systematic errors that arise if the challenge microorganism is more resistant to UV light than the target pathogen.
- **UV dose monitoring.** Section D.2 provides background information on the impact of UV sensor placement on UV dose monitoring (whether it is at, closer to, or farther from the lamp than the ideal position). It provides a rationale for defining test conditions to validate UV reactors using a given UV dose-monitoring approach and explains why sensor position is important.
- **UV sensors.** Section D.3 provides the basis for the UV sensor calibration criterion recommended in Chapter 5. It describes the properties of UV sensors, how those properties impact the sensor’s measurement uncertainty, and how that measurement uncertainty can be determined.
- **Polychromatic considerations.** Section D.4 describes systematic errors that can occur with the validation of UV reactors that use medium-pressure (MP) UV lamps (1) equipped with non-germicidal UV sensors and/or (2) validated with a challenge microorganism that has a UV action spectrum significantly different from that of the target pathogen. This section provides a rationale for assessing those errors.
- **Uncertainty of validation.** Section D.5 provides a rationale for defining a validation factor that accounts for the random uncertainty associated with UV reactor validation and monitoring.
- **CFD modeling.** Section D.6 provides guidance on using Computational Fluid Dynamics (CFD) to model UV dose delivery.

D.1 UV Dose Delivery by UV Reactors

UV dose delivery by UV reactors to be used at water treatment plants (WTPs) is currently measured using biodosimetry (Qualls and Johnson 1983). With biodosimetry, inactivation of a challenge microorganism passed through the UV reactor is measured and related to a single dose value based on the known UV dose-response of that microorganism. This dose is termed the “reduction equivalent dose,” or RED.

D.1.1 Using RED to Demonstrate Target Pathogen Inactivation

If the UV dose-response of the challenge microorganism does not match the target pathogen’s, and the UV dose distribution of the UV reactor is not known, biodosimetry can only be used to estimate the target pathogen inactivation within a range bounded by the inactivation expected assuming “ideal” and “worst-case” hydraulics. Figure D.1 provides a comparison of the

UV dose distributions of reactors with ideal and worst-case hydraulics to a UV dose distribution that might be seen with a real reactor.

Figure D.1. UV Dose Distributions of Ideal, Realistic, and Worst-case UV Reactors

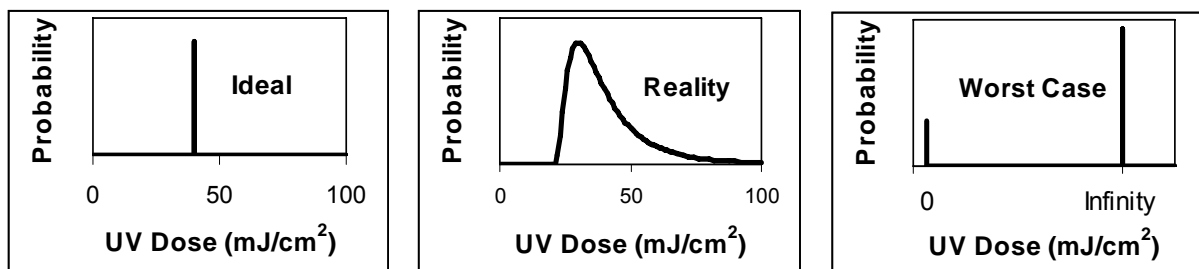

D.1.1.1 Ideal Reactor Hydraulics

A UV reactor with ideal hydraulics delivers the same UV dose to all the microorganisms passing through the reactor. Its UV dose distribution is represented by a single value. Examples of a UV reactor with ideal hydraulics include the stirred suspension irradiated during the measurement of UV dose-response with a collimated beam device and an ideal plug-flow reactor. In both cases, the delivered dose is the product of the average UV intensity within the reactor and the residence time. Accordingly, with an ideal reactor, the RED measured with a challenge microorganism is a measure of the RED delivered to all microorganisms that pass through the reactor because all the microorganisms receive the same dose.

D.1.1.2 Worst-case Hydraulics

For a reactor with worst-case hydraulics and a measurable RED, an infinite UV dose is delivered to one fraction of the flow rate, and zero UV dose is delivered to the other fraction (i.e., one of two UV dose values is delivered to each respective microorganism). The net inactivation achieved is constant, equal to the fraction receiving the infinite UV dose, and hence independent of the microorganism's inactivation kinetics. With a worst-case UV reactor, the measured inactivation is that which would occur with any microorganism regardless of its UV sensitivity.

D.1.1.3 Real-world Hydraulics

Using the above definitions of an ideal and a worst-case UV reactor, the log inactivation of a pathogen estimated from biosimetry results will have a value between $\log(N_{o,c}/N_c)$ and $[\text{RED}/D_p]$,¹ that is, a “real” UV reactor will have a UV dose distribution that falls somewhere between ideal and worst-case (Wright and Lawryshyn 2000).

¹ $N_{o,c}$ is the influent challenge organism (c) concentration and N_c is the effluent challenge microorganism concentration. D_p is the UV sensitivity of the pathogen (p) in units of mJ/cm^2 per log inactivation.

If the inactivation of the pathogen must be known with absolute confidence, the lower bound of that range should be used (assume worst-case hydraulics). When the challenge microorganism is more resistant to UV light than the target pathogen, the lower bound is the log inactivation of that challenge organism, $\log [N_{o,c}/N_c]$. In other words, if a UV reactor is validated with a challenge microorganism that is less sensitive to UV light than the target microorganism, one cannot know with certainty that the reactor achieved more than the log inactivation demonstrated during validation. For example, if 2-log MS2 inactivation is measured, one can conclude only that the water system attained ≥ 2 -log inactivation for any organism less resistant to UV light.

If the challenge microorganism is less resistant to UV light than the target pathogen, the lower bound is the RED measured with the *challenge* organism divided by the sensitivity of the *target* pathogen, $[RED/D_p]$. For example, if one measures a ϕ x-174 RED of 12 mJ/cm², corresponding to 4-log inactivation, one cannot assume that the reactor achieved 4.0-log inactivation of *Cryptosporidium*; one can assume only that the water system attained $[12 \text{ mJ/cm}^2] / [4.0 \text{ mJ/cm}^2 \text{ per log I}] = 3.0$ -log inactivation.

But both of these assumptions are extreme. For this reason, the “RED Bias” correction factor used in the VF is based on the UV dose distribution of a defined “real-world worst-case” UV reactor. The RED delivered to a pathogen by a given UV reactor can be estimated from the measured RED of the challenge microorganism using Equation D.1:

$$RED_p = RED_c \times \frac{RED_{p,wc}}{RED_{c,wc}} = \frac{RED_c}{B_{RED}} \quad \text{Equation D.1}$$

where:

- RED_p = Pathogen RED estimated for the UV reactor of interest (mJ/cm²)
- RED_c = Challenge microorganism RED measured during biosimetry (mJ/cm²)
- RED_{p,wc} = Pathogen RED estimated from Figure D.2, the “worst-case” UV reactor (mJ/cm²)
- RED_{c,wc} = Challenge microorganism RED estimated from Figure D.2, the “worst-case” UV reactor (mJ/cm²)
- B_{RED} = RED Bias, the ratio of the RED of the pathogen to the RED of the challenge microorganism for a given set of operating conditions

The development of this factor (RED Bias, or B_{RED}) is discussed below.

Defining a Realistic Conservative UV Dose Distribution

Because UV manufacturers strive to optimize the hydraulic design of their UV reactors, using the worst-case UV dose distribution represented in Figure D.1 to define the lower bound of pathogen inactivation is overly conservative. An alternative approach is to use the UV dose distribution of a commercial UV reactor that is representative of plausibly poor UV reactor hydraulics.

Figure D.2. The UV Dose Distributions Used to Determine RED Bias Values Tabulated in Appendix G

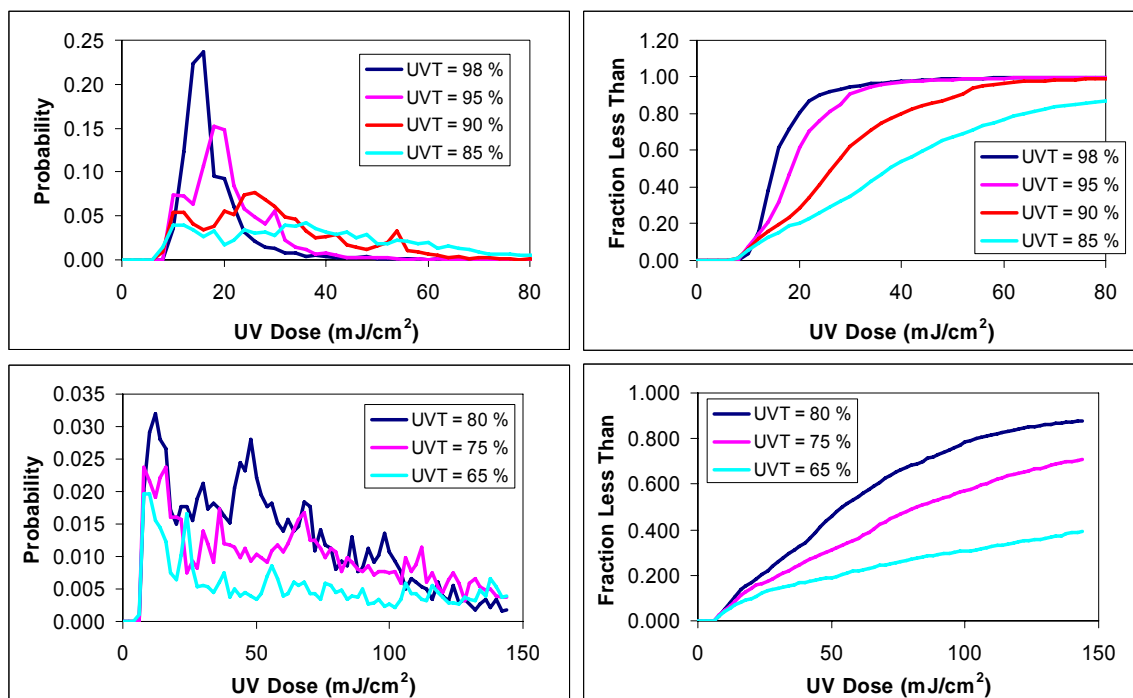

UV dose modeling based on CFD was used to predict dose distributions for commercial low-pressure high-output (LPHO) and medium-pressure (MP) UV reactors. Details on the approach are provided in Wright and Reddy (2003) and Dzurny et al. (2003). CFD was used to predict the trajectories of approximately 3,000 microbes through the UV reactors. UV intensity fields within the reactor were modeled using the methods described by Bolton (2000). The UV dose delivered to each microbe was predicted by integrating the total UV dose delivered over its trajectory through the reactor. The REDs delivered to the target pathogens were calculated assuming first-order kinetics with a UV sensitivity defined as the required dose in Table 1.4 divided by the associated log inactivation credit. The dose distributions were scaled to give pathogen REDs equal to the required dose for a given level of log inactivation credit plus an uncertainty factor of 25 percent (i.e., for 3-log *Cryptosporidium* inactivation credit, dose distribution was scaled to give a *Cryptosporidium* RED = $12 + [0.25 \times 12] = 15 \text{ mJ/cm}^2$). This approach assumes that the UV reactor uses dose pacing² to deliver the required RED without overdosing. REDs were estimated for test microbes of various UV sensitivities assuming first-order kinetics. The RED bias was calculated as the ratio of the test microbe RED to the pathogen RED ($B_{\text{RED}} = \text{RED}_{\text{test microbe}} / \text{RED}_{\text{pathogen}}$).

The commercial reactor that resulted in the most conservative RED bias values was used to develop the RED Bias values in Appendix G. Figure D.2 shows the scaled UV dose

² The UV reactor maintains the delivered dose at or near the target value by adjusting the lamp power or turning "on" or "off" banks of UV lamps or whole UV reactors to respond to changes in UV absorbance, lamp intensity, and/or flow rate.

distributions used to estimate the RED bias for 3-log inactivation credit with *Cryptosporidium*. Figure D.3 shows predictions of RED and log inactivation for those dose distributions as a function of the test microbe's UV sensitivity. Figure D.4 shows the RED bias for 3-log *Cryptosporidium* credit as a function of the test microbe's UV sensitivity obtained using the data in Figure D.2.

Figure D.3. RED as a Function of Microorganism UV Sensitivity for the UV Reactor Represented in Figure D.2

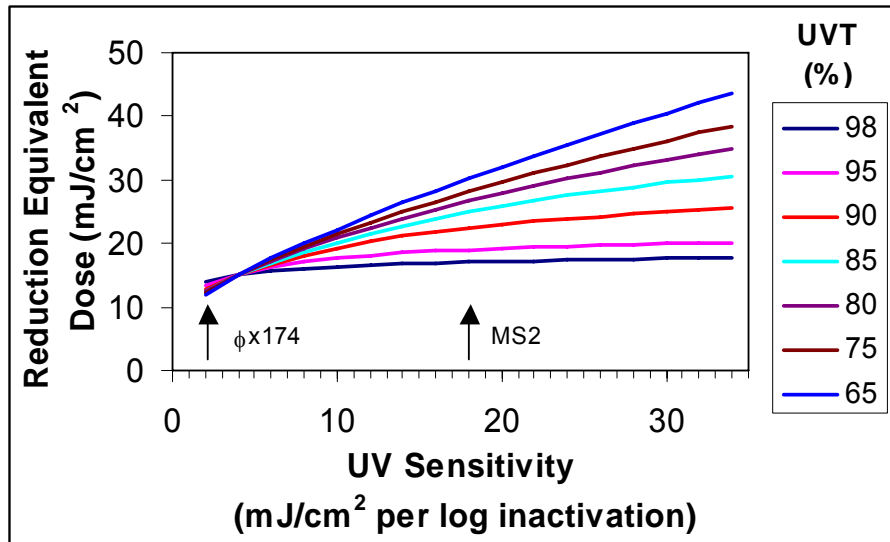
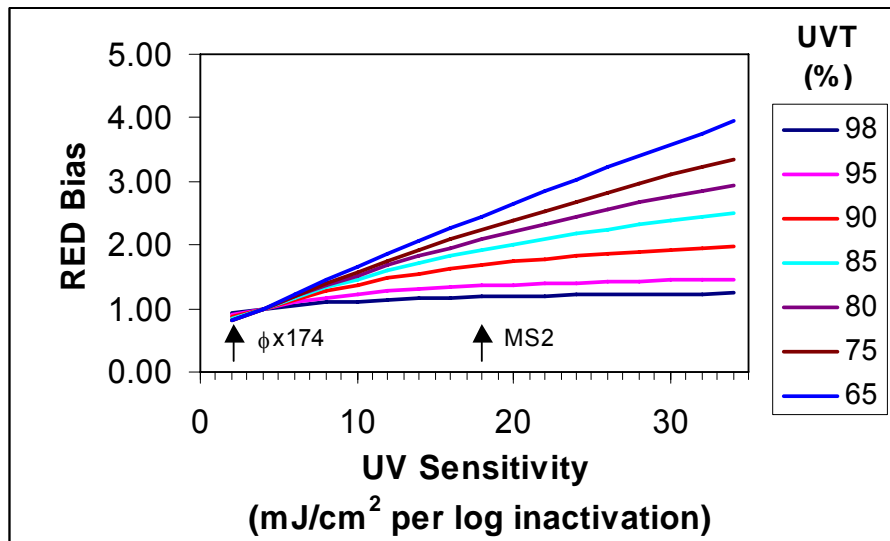

Figure D.4. RED Bias for 3-log *Cryptosporidium* Credit as a Function of Test Microbe UV Sensitivity



Example D.1. A UV reactor is challenged using MS2 with a UV sensitivity of 18 mJ/cm² per log inactivation. The UVT of the water is 85 percent. Two-log inactivation is measured, corresponding to an MS2 RED of $2\text{-log} \times 18 \text{ mJ/cm}^2\text{-log I} = 36 \text{ mJ/cm}^2$. These results are used to estimate the log inactivation of two pathogens, one with a UV sensitivity of 10 mJ/cm² per log inactivation and the other with a UV sensitivity of 25 mJ/cm² per log inactivation.

In Figure D.3, the RED delivered to the microorganisms with a UV sensitivity of 10, 18, and 25 mJ/cm² per log inactivation would be 20, 25, and 28 mJ/cm², respectively. The RED Bias values for MS2 relative to the first pathogen is $25/20 = 1.25$ while the RED Bias for MS2 relative to the second pathogen is $25/28 = 0.89$. Assuming the reactor has a UV dose distribution that is better than the dose distribution used to develop Figure D.2, the RED of the first pathogen has a value between 36 and $36/1.25 = 29 \text{ mJ/cm}^2$ and the RED of the second pathogen has a value between 36 and $36/0.89 = 40 \text{ mJ/cm}^2$.

D.2 The Impact of UV Sensor Positioning on UV Dose Monitoring

This guidance manual focuses on two commonly used UV dose-monitoring strategies, the UV Intensity Setpoint Approach and the Calculated Dose Approach, which are summarized below. Sections D.2.1 and D.2.2 discuss the impact of UV sensor positioning for the UV Intensity Setpoint Approach and Calculated Dose Approach, respectively.

1. **UV Intensity Setpoint Approach.** UV dose delivery is indicated by the measured flow rate and UV intensity. Minimum UV dose delivery is verified when the measured UV intensity is above an alarm (minimum) setpoint value defined as a function of the flow rate through the reactor. In a variation of this method, the minimum UV dose can be verified when the measured relative UV intensity (calculated as a function of UVT) is above an alarm (minimum) setpoint value defined as a function of the flow rate through the reactor.
2. **Calculate Dose Approach.** Minimum UV dose delivery is verified when the calculated UV dose (using an equation dependent on flow rate, relative UV intensity, UVT, and sometimes other parameters such as lamp status) is above an alarm (minimum) setpoint value.

D.2.1 UV Intensity Setpoint Approach

With the UV Intensity Setpoint Approach, dose monitoring is impacted by UV sensor positioning (Wright et al. 2002). To illustrate this impact, Figure D.5 presents the relationship between UV dose and measured UV intensity for a simple annular reactor containing a single low-pressure (LP) lamp. UV intensity was calculated using a radial UV intensity model and UV dose was calculated assuming ideal hydraulics (Haas and Sakellaropoulos 1979). UV intensity and dose were calculated for a fixed flow rate of 140 gpm. Simulated UVT values ranged from 70 to 98 percent, and simulated relative lamp outputs (characterized by relative sensor values) ranged from 20 to 100 percent. In each figure, the data are presented as plots of UV dose as a function of the UV sensor reading for a range of UVT values. Each point at a given UVT represents, in order of increasing UV dose, operation at 20, 40, 60, 80, and 100 percent relative

lamp power. The differences between these figures are due to differences in sensor-to-lamp distance (i.e., UV sensor placement).

1. The UV Sensor Is Located at the “Ideal Position”

Figure D.5a presents the relationship between delivered UV dose and sensor reading obtained when the UV sensor is located at the sensor-to-lamp distance where the relationships between UV dose and measured UV intensity at different UVTs overlap. Because these relationships overlap, **a given UV intensity can be related to a specific level of dose delivery.**

Example D.2. The UV reactor characterized in Figure D.5a is used in a disinfection application where the target dose is 20 mJ/cm^2 . A UV sensor value S of 18 mW/cm^2 is used as an alarm setpoint to indicate the UV reactor delivers a dose of 20 mJ/cm^2 across the entire operating range—the ideal placement of the sensor ensures that an alarm setpoint value of 18 mW/cm^2 will indicate a dose of 20 mJ/cm^2 .

2. The UV Sensor Is Located Closer to the Lamp Than the “Ideal Position”

Figure D.5b presents the relationship between delivered UV dose and sensor reading when the UV sensor is placed closer to the lamp than the ideal position (i.e., a smaller sensor-to-lamp distance than in Figure D.5a). Because the sensor views the lamp through a relatively thin water layer, its response to changing UVT is small compared to that in Figure D.5a. Accordingly, the relationship between dose delivery and measured UV intensity cannot be described by a single relationship for all values of UVT. Unlike the situation depicted in Figure D.5a, the delivered dose will decrease at lower UVTs for a given UV sensor reading. Accordingly, the **measured UV intensity should only be used to indicate dose delivery at the lower end of that range, which occurs under conditions of maximum lamp power and reduced UVT.**

Example D.3 The UV reactor characterized in Figure D.5.b is used in an application where the target dose is 20 mJ/cm^2 . The UV manufacturer states that a UV sensor value S of 80 mW/cm^2 will indicate a dose of 20 mJ/cm^2 under design conditions of 85% UVT and 60% relative lamp output. However, as shown in Figure D.5.b, a UV intensity of 80 mW/cm^2 corresponds to a dose ranging from 10 mJ/cm^2 (for 70% UVT) to 37 mJ/cm^2 (for 98% UVT). For a UV intensity alarm setpoint to ensure a delivered dose of 20 mJ/cm^2 under *all* possible conditions of water UVT and lamp output, a sensor setpoint value S' of 157 mW/cm^2 would need to be used.

Figure D.5. Relationship between UV Dose and Intensity for a UV Sensor Located (a) at the “Ideal Position,” (b) Close to the Lamp, and (c) Far from the Lamp

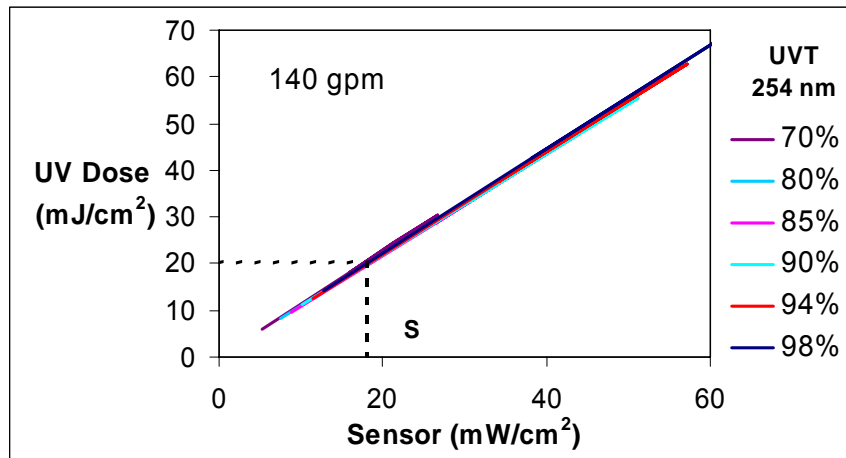

(a)

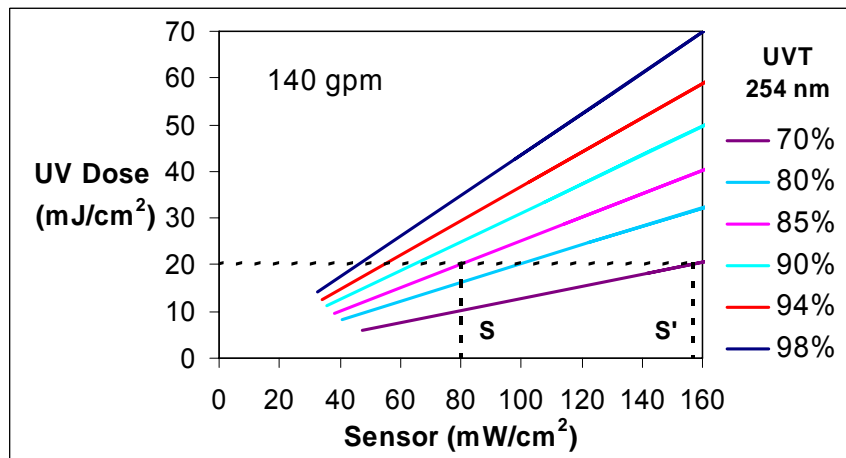

(b)

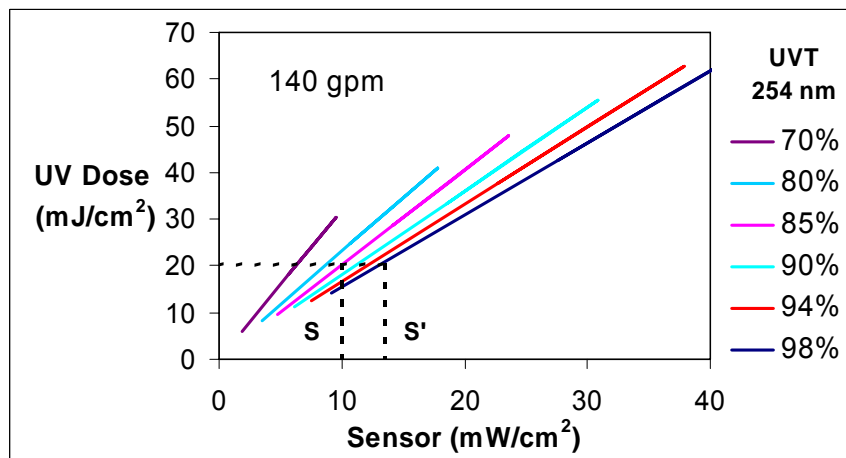

(c)

3. The UV Sensor Is Located Farther from the Lamp Than the “Ideal Position”

Figure D.5c presents the relationship between delivered UV dose and sensor reading when the UV sensor is located farther from the lamp than the ideal position (i.e., a greater sensor-to-lamp distance than in Figure D.5a). Because the sensor views the lamp through a relatively thick water layer, its response to changing water transmittance is greater at this position than at either the ideal or closer-than-ideal positions. Again, the relationship between UV dose delivery and measured UV intensity cannot be described by a single relationship for different values of UVT. However, unlike Figure D.5b, the UV dose delivered at a given measured UV intensity increases as UVT decreases. Thus, **the measured UV intensity should only be used to indicate UV dose delivery at the lower end of that range, which occurs under conditions of reduced lamp power and maximum UVT** (the opposite of what is observed with the closer-than-ideal UV sensor position).

Example D.4. The UV reactor characterized in Figure D.5c is used in an application where the target dose is 20 mJ/cm^2 . A UV intensity alarm setpoint value S of 10 mW/cm^2 is proposed based on the UV intensity measured under design conditions of 85 percent UVT and 60 percent relative lamp output. However, a sensor value of 10 mW/cm^2 indicates a UV dose ranging from 15 to 32 mJ/cm^2 . To ensure a delivered dose of 20 mJ/cm^2 under *all* possible conditions of water UVT and lamp output, a setpoint value S' of 14 mW/cm^2 would need to be used.

The manufacturer of the UV reactor selects the location of the UV sensor within a UV reactor. If the UV reactor uses the UV Intensity Setpoint Approach for UV dose monitoring, it is to the manufacturer's advantage to optimize the UV sensor's location to obtain overlapping relationships between UV dose delivery and measured UV intensity for different UVT values, similar to the example given in Figure D.5a.

If the UV manufacturer does not optimize the UV sensor's location, a given UV intensity will correspond to a range of UV dose values as opposed to a single value. While this does not prevent the UV reactor from using the UV Intensity Setpoint Approach, the monitoring approach will be significantly less efficient than with an ideally located UV sensor because the UV reactor will be overdosing at many UVT-lamp power combinations that give rise to operation at the setpoint. When this occurs, the manufacturer may opt to supplement measurements of UV intensity with measurements of UVT to enable more efficient UV dose monitoring (this is sometimes referred to in the literature as the “UV Intensity-UVT Setpoint Approach”). The UV reactor is verified to be delivering the required UV dose when both the measured UV intensity and UVT are above the minimum validated setpoint values (S/S_o , UVT_{setpoint} , and UVT_{setpoint}), both defined for a specified range of flow rates. With this approach, there are no requirements for UV sensor positioning.

D.2.2 Calculated Dose Approach

Measurements of flow rate, UV intensity, and UVT can be incorporated into theoretical, empirical, or semi-empirical calculations of UV dose delivery. For example, the relationships represented in Figure D.5a – c could be defined experimentally and used in an empirical manner

to calculate UV dose (e.g., Equation 5.8). Relationships could also be defined using advanced numerical modeling approaches to relate measured intensity to UV dose delivery as a function of flow rate and UVT.

In theory, the UV dose calculation does not necessitate that the UV sensor be placed at any one location within the reactor. However, if the UV sensor were placed at the ideal position (a location that gives UV dose delivery proportional to the UV sensor reading), the UV dose calculation would not require UVT as an input parameter.

D.3 UV Sensors

UV sensors are photosensitive detectors that are used to indicate UV dose delivery by providing information related to UV intensity at different points in the UV reactor. Reference UV sensors are used to check that the measurements made by the on-line, or “duty” sensors are valid.

UV sensors include the following components, arranged as shown in Figure D.6:

- **Monitoring windows** and **light pipes** deliver light to the photodetector. Monitoring windows are typically quartz discs and light pipes are cylindrical probes made of quartz (quartz silica probe).
- **Diffusers** and **apertures** reduce the UV light incident on the photodetector to slow UV sensor degradation. Diffusers also modify the UV sensor’s angular response.
- **Diffusers** and **apertures** reduce the UV light incident on the photodetector to slow UV sensor degradation. Diffusers also modify the UV sensor’s angular response.
- **Filters** limit the light delivered to the photodiode, typically restricting it to germicidal UV wavelengths (~200 – 300 nm).
- **Photodetectors** are solid-state devices that produce a current proportional to the irradiance on the detector’s active surface. The responsiveness of a typical photodetector to UV light is on the order of 0.1 – 0.4 mA/mW.
- **Amplifiers** convert the output of the photodetector from a low-level current to a standardized output proportional to the incident UV intensity.
- The **housing** of the UV sensor protects the components from the external environment. The housing should be electrically grounded to shield the photodetector and amplifier, thereby reducing electrical noise and bias.

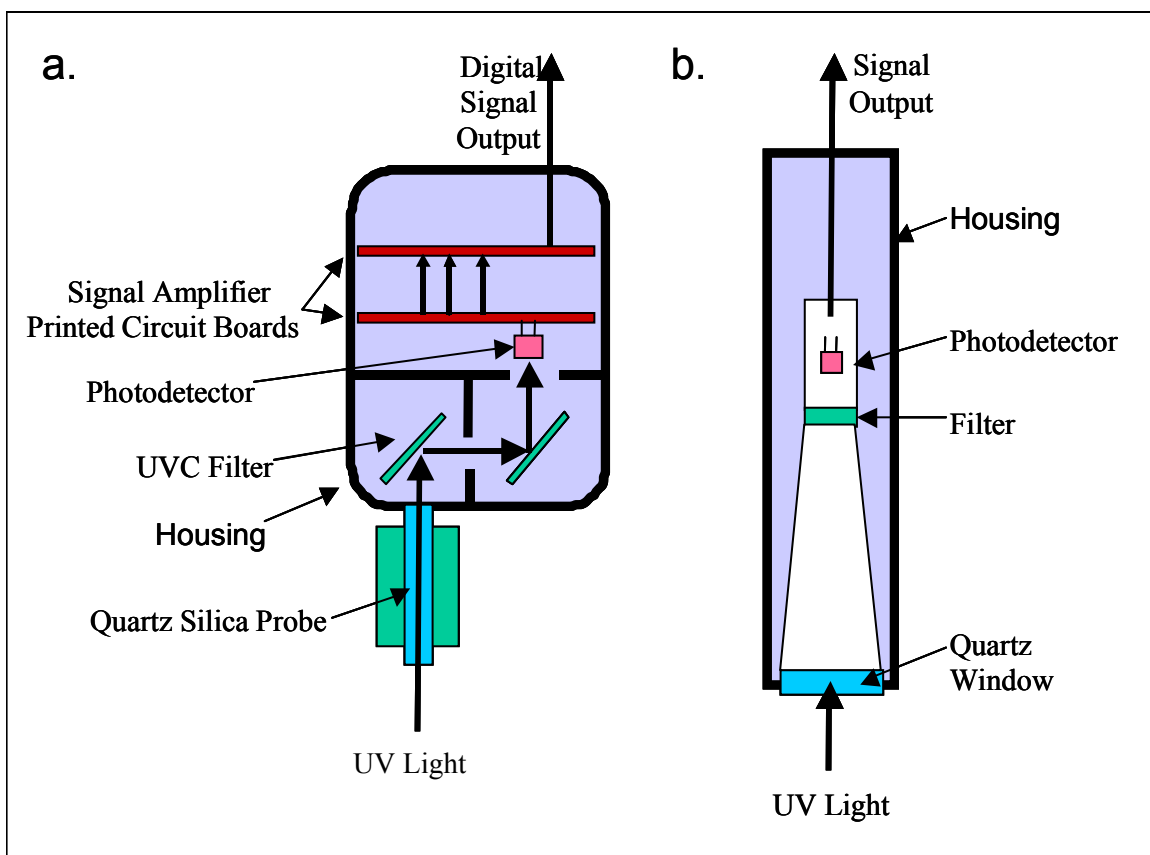
Figure D.6. Interior UV Sensor Schematics³

D.3.1 UV Sensor Properties

The UV sensor should detect germicidal UV radiation and produce a standardized output signal proportional to the incident UV irradiance (e.g., 4 – 20 mA). A UV sensor may or may not measure the UV light through a monitoring window that is separate from the sensor body. Monitoring windows should have a high UVT over the sensor's spectral response range.

UV sensor properties that impact the measurement of UV intensity and dose delivery monitoring include angular response, acceptance angle, spectral response, working range, detection limit and resolution, linearity, temperature response, long term drift, calibration factor, and measurement uncertainty. An ideal UV sensor would have the following properties:

- A linear response to incident UV light, independent of water temperature and stable over time.
- A fixed angular response and a wavelength response that mimics the germicidal response of the target microorganism(s).

³ Figure courtesy of (a) Aquionics and (b) WEDECO UV Technologies; UVC light is 200 – 280 nm (the germicidal range).

- Has zero measurement noise and bias.
- Responds only to germicidal UV light.
- Has zero measurement uncertainty.

The properties of an ideal UV sensor are presented here to illustrate the benchmark UV sensor manufacturers strive to approximate as closely as possible, that is, zero measurement error.

Angular response is a plot of the UV sensor measurement as a function of the incident angle of light on the sensor's window. Angular response is affected by the UV sensor's aperture size, the size of the photodetector's active surface, the distance between the aperture and the active surface, and the impact of any diffusers and reflecting surfaces within the sensor. An ideal UV sensor has a "cosine response" (Equation D.2), which results in an accurate measure of the light incident on the surface of the photodetector. In practice, UV sensors deviate from the cosine response; some potential responses are shown in Figure D.7.

$$S_m = S_i \cos \theta \quad \text{Equation D.2}$$

where:

S_m = Intensity measured by the UV sensor's photodetector [watt per centimeter squared (W/cm^2)]

S_i = Intensity incident on the UV sensor's photodetector's surface (W/cm^2)

θ = Incident angle at the UV sensor's photodetector surface ($^\circ$)

Figure D.7. Angular Response of Two UV Sensors Relative to the Ideal Cosine Response

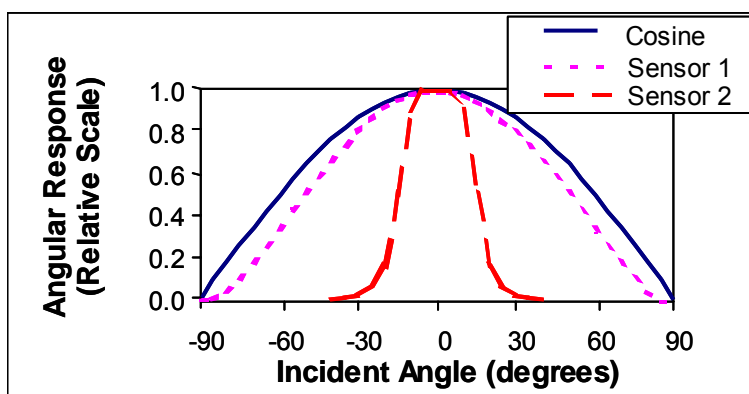

The opening or **acceptance angle** of the UV sensor is the angle over which the sensor detects UV light. The opening angle is typically measured by either the threshold detection of UV light or detection at some percentage of the maximum value (e.g., 50 percent). The acceptance angle is a characteristic of the sensor but does not affect its performance.

The **spectral response** is a measure of the output of the UV sensor as a function of wavelength. It depends on the response of the photodetector and filters and the UV transmittance of the monitoring windows, light pipes, and filters.

The **working range** of the UV sensor is the intensity range that the sensor is able to measure. The low end of the working range is defined by the detection limit of the measurement. The high end of the working range is limited by the saturation of the photodetector and the amplifier. Saturation is the point at which the UV sensor can no longer respond to an increase in intensity.

The **detection limit** of the UV sensor is the lowest UV intensity that can be detected and quantified at a known confidence level. The detection limit is calculated based on repeated measurements of low intensity UV light, usually at a specific percentage confidence interval.

The **measurement resolution** is the smallest difference in UV intensity that can be differentiated at a given confidence level. The detection limit and the resolution depend on the measurement noise and on any digitalization of the analog output from the UV sensor by the system's electronics. Measurement bias and noise of a photodetector are increased by electromagnetic fields within the UV reactor if the sensor is not properly shielded and grounded.

An ideal UV sensor (a sensor with an ideal cosine response) responds proportionally to the intensity incident on the sensor (Figure D.7). The **linearity** of the UV sensor is a measure of the adherence of the sensor response to that proportional relationship. It is reported as the ratio of the measured response to the known incident intensity, usually at a specific confidence level. Linearity is affected by bias and saturation.

D.3.1.1 Calibration and Quantification of UV Sensor Properties

UV sensors used to monitor monochromatic lamps are often calibrated using the substitution method of Larason et al. (1998). With this approach, the intensity of a collimated beam of UV light at 254 nm is measured using the UV sensor; the measured value is then compared to that made using a standard measurement, such as a NIST⁴-traceable UV sensor or chemical actinometer. The ratio of the standard measurement to the UV sensor output is the calibration factor. With UV sensors designed to measure the output of MP lamps, the sensor can be calibrated at 254 nm, calibrated as a function of wavelength, or calibrated using polychromatic light from an MP lamp with a known spectral output.

UV sensor **linearity** is determined by comparing the sensor output as a function of incident irradiance to standard measurements of that irradiance. UV sensor **temperature response** is determined by measuring the dependence of sensor output on the sensor's operating temperature with the sensor measuring a constant irradiance. The **angular response** of a UV sensor is determined by measuring the dependence of the UV sensor reading on the incident angle of a beam of fixed-intensity, collimated UV light.

⁴ National Institute of Science and Technology, Boulder, Colorado.

The **spectral response** of a UV sensor is determined by measuring the dependence of the sensor output on the wavelength of monochromatic light of known irradiance incident on the sensor. Spectral response is typically presented as a plot of the ratio of sensor output to incident irradiance as a function of the wavelength of light.

The **measurement accuracy** of UV sensors changes over time due to mechanical wear and environmental exposure. Temperature cycling, exposure to UV light, mechanical vibration, and other factors will impact the linear, spectral, angular, and temperature response of a sensor. Long-term sensor stability is best determined using field data, but may be estimated using accelerated life-cycle testing.

D.3.1.2 Recommendations for Calibration and Quantification of UV Sensor Properties

UV sensors provided by the manufacturer should be individually calibrated. The manufacturer should determine linearity and temperature-response over the expected operation range of lamp intensity and water temperature expected during operation at WTPs. Because it may be affected by infrared transmission of glass filters and fluorescence of diffusers that are part of the UV sensor (Larason and Cromer 2001), the sensor spectral response should be evaluated from 200 to 1,000 nm. The sensor response should be “germicidal” (see Section 5.4.8 for the definition of a “germicidal” UV sensor response).

UV sensor manufacturers should conduct regular testing on their UV sensors to develop a database on the effect of long-term use on sensor properties. While some UV sensor properties may be measured with each sensor (e.g., calibration), other properties, such as long-term stability and angular and spectral response, can practically be measured only on a representative sample from a lot. The UV sensor manufacturer should have available for inspection the following information:

- A description of the measured UV sensor properties.
- A description of the system used to measure each property.
- A description of the measurement standards used.
- The documented uncertainty associated with each measurement.
- A description of the QA/QC procedures used to ensure that the measurements were traceable to a standard.
- Data that demonstrates that the properties of the manufactured UV sensors are within specifications over time.

D.3.2 UV Sensor Measurement Uncertainty

UV sensor measurement uncertainty quantifies how the UV intensity value measured with a duty UV sensor (mounted on the UV reactor) compares to the true value. For the purposes of this manual, UV sensor uncertainty should be determined by summing the uncertainties that arise from calibration, linearity, angular and spectral response, temperature response, and long-term stability (see Table D.1 for an example of this calculation):

- Uncertainty in the UV sensor calibration arises from the uncertainties associated with the standards and instrumentation used to calibrate the sensor (e.g., voltmeters and amplifiers).
- Uncertainty in the UV sensor's linearity and temperature response arises because sensor calibration factors, determined at one temperature and UV irradiance, are used over a range of temperatures and irradiances during operations at a WTP.
- Uncertainty in angular response arises because UV sensors are used in UV reactors to measure UV light impacting from different directions but are calibrated with collimated light (i.e., light is incident to the surface from only one angle).
- Variability in spectral and angular response from UV sensor-to-UV sensor results in an additional measurement uncertainty not accounted for in calibration. The impact of spectral and angular response variability on UV sensor measurement uncertainty can be determined either by calculation or by measurement.

In the calculation approach, UV sensor spectral and angular response, measured on a representative sample from a lot, is used as an input to a numerical model that predicts sensor readings in a reactor. The variability in the readings predicted by the model is used to define an uncertainty term that is included in the calculation of the total sensor uncertainty. In the measurement approach, the variability in measurements made by a representative number of UV sensors mounted on the reactor is used to define the uncertainty.

- Uncertainty in spectral response arises in MP systems because sensors, calibrated at a fixed wavelength, are used in UV reactors equipped with polychromatic lamps.
- Additional uncertainty arises from long-term UV sensor drift.

The information described above should be provided by the manufacturer for each duty sensor as part of the UV reactor documentation. The purpose of this information is to indicate the ability of the manufacturer to quantify the uncertainty for important sensor properties and to demonstrate whether the sensor can meet sensor specifications prepared by the system purchaser. This information should *not* be used to verify sensor performance during validation testing or operations. Instead, sensor uncertainty should be field-verified by comparing duty sensor measurements to calibrated reference sensors, as described in Sections 5.5.4 and 6.4.1.1.

Table D.1. Example of a UV Sensor Uncertainty Calculation Datasheet

Property	Uncertainty (%)
Spectral response	4
Angular response	3
Linearity	3
Calibration	5
Temperature response	3
Long term drift	12
Total Uncertainty¹	15

¹ Total uncertainty is calculated as:
 $(1^2+3^2+3^2+5^2+3^2+10^2)^{1/2} = 15\%$.

Example D.7. A UV sensor manufacturer calibrates each UV sensor at 20°C with an uncertainty of ±1 percent. Linearity, temperature response, angular response, and spectral response are evaluated on every tenth sensor manufactured. Linearity ranges from 1 – 5 percent over the measurement range of the sensor. Temperature response ranges from 0.1 – 0.2 percent per °C—an uncertainty of 5 percent over the temperature range 0 – 40 °C. Models predict that the variability in angular and spectral response from sensor-to-sensor will cause uncertainties of 8 percent and 3 percent, respectively. A laboratory evaluation of UV sensors returned from the field indicates that the long-term drift over a one-year period is 11 percent. The measurement uncertainty of the UV sensors is calculated as the square root of the sum of the squares of the individual percent uncertainties:

$$\text{Measurement uncertainty} = \sqrt{1^2 + 5^2 + 5^2 + 8^2 + 3^2 + 11^2} = 16\%$$

D.3.3 Number of UV Sensors

Lamp-to-lamp variability in UV output impacts both UV dose delivery and monitoring (Wright et al. 2004). If a lamp has a lower output than the other lamps in a UV reactor, it will deliver lower UV doses to microorganisms passing in its vicinity, thereby shifting the UV dose distribution to lower values and reducing the net performance (UV dose delivery) of the reactor. The shift in the UV dose distribution will be more pronounced in a reactor with fewer lamps.

If the number of UV sensors is less than the number of lamps and the sensors do not monitor the lamps with the lowest output, the monitoring system will overestimate UV dose delivery. Sections 6.3.2.2 and 5.4.7 provide guidance on dealing with this issue in operations and validation, respectively.

D.4 Polychromatic Light Considerations

LP and LPHO lamps are monochromatic, with UV output at a single wavelength, 254 nm. MP lamps are polychromatic, with UV output at multiple wavelengths. UV dose delivery and monitoring in MP reactors involves UV light from 200 to 320 nm. The output from the UV

sensor is an integrated response to UV light over wavelengths spanning the sensor's spectral response. If the spectral properties of the UV reactor that influence UV dose delivery and monitoring during operation at a WTP are the same as during validation, then the characterized UV dose delivery will occur at the WTP. However, if the spectral properties are significantly different, UV dose delivery at the WTP can differ substantially from UV dose delivery measured during validation for the same measured operating values. The following spectral properties may differ:

- Action spectra of the challenge microorganism and of the target pathogen.
- Spectral UV absorbance of the water used during validation and at the WTP.
- UV output of the lamps during validation and at the WTP (see 5.4.6 for details).
- UVT of the lamp sleeves during validation and at the WTP (see 5.4.6 for details).

Section D.4.1 describes approaches for assessing the impact of differences in microbial action spectrum properties. Section D.4.2 describes an approach for developing a correction factor for polychromatic bias for MP reactors when the challenge microorganism is something other than MS2 or *Bacillus subtilis*. Derivation of the polychromatic bias factor for MP UV reactors with non-germicidal sensors is presented in Section D.4.3.

D.4.1 Impact of Microorganism UV Action Spectra Differences

The dependence of microorganism inactivation kinetics on wavelength can be described using an action spectrum – the UV inactivation sensitivity of a microorganism as a function of wavelength (Figure D.8). Ideally, the action spectrum of the challenge microorganism used to validate a polychromatic UV reactor would either match that of the target microorganism or provide a conservative estimate of inactivation.

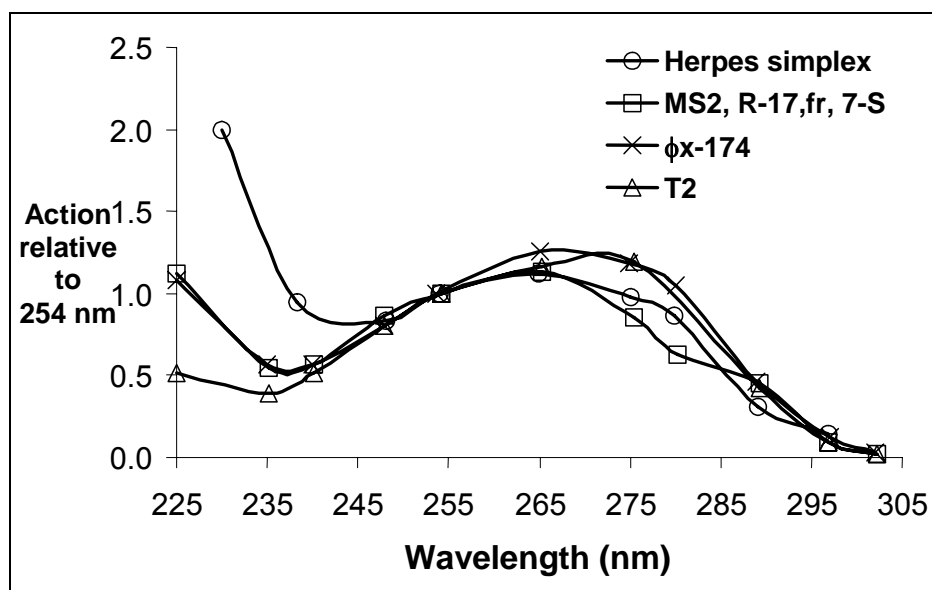
Figure D.8. Action Spectra for Various Microorganisms

(Adapted by H. Wright from Rauth 1965.)

The impact of various action spectra on UV dose delivery may be estimated by calculating the germicidal lamp output using Equation D.3:

$$P_G = \sum_{\lambda=200}^{320} P(\lambda)G(\lambda)\Delta\lambda \quad \text{Equation D.3}$$

where:

P_G = Germicidal output of the MP lamp (W/cm)

λ = Wavelength (nm)

$P(\lambda)$ = Lamp output at wavelength λ , measured over 1-nm increments [watt per nanometer (W/nm)]

$G(\lambda)$ = Relative UV sensitivity of the microorganism at wavelength λ (cm^{-1})

$\Delta\lambda$ = 1-nm wavelength increment (nm)

Using the published action spectra of fourteen microorganisms (Cabaj et al. 2002, Linden et al. 2001, Rauth 1965), Table D.2 presents the germicidal lamp output calculated for a commercial MP lamp and the ratio of that output to that of *Cryptosporidium*. A ratio greater than one (1) indicates that the microorganism receives more germicidal output compared to *Cryptosporidium*. If a challenge microorganism with a ratio greater than 1.05 is used to validate a MP reactor for *Cryptosporidium* inactivation, the ratio should be used as a correction factor (called the “action spectra correction factor,” or CF_{as}) to account for the greater proportional inactivation of the challenge microorganism that arises from the differences in the two action spectra. In the case of MS2 and *B. subtilis*, the ratio is close to one (1) and the correction is small (< 0.06). However, based on the data in Table D.2, if $\phi x174$ was used to show *Cryptosporidium* inactivation, an action spectra correction factor of 1.16 would be needed with MP reactors. In other words, the $\phi x174$ RED would be divided by 1.16 to determine the RED used to calculate the validated dose (see Section 5.8).

Table D.2. Germicidal Output Delivered to 14 Microorganisms by an MP Lamp

Microorganism	Type / Nucleic acid (SS = single strand, DS = double strand)	Germicidal Output (W/cm)	Germicidal Output Relative to <i>Cryptosporidium</i> (Action Spectra Correction Factor)
<i>Cryptosporidium</i> oocysts	Protozoa / DS DNA	5.64	1.00
Vaccinia	Animal virus / DS DNA	5.46	0.98
<i>B. subtilis</i> spores	Aerobic spore / DS DNA	5.58	0.99
VSV	Animal virus / RNA	5.53	0.99
MS-2, R-17, fr, 7-S	Bacteriophage / SS RNA	5.78	1.04
T2	Phage / DS DNA	6.05	1.07
EMC	Animal virus / SS RNA	5.98	1.07
φx-174	Bacteriophage / DS DNA	6.53	1.16
Polyoma	Animal virus / DS DNA	6.74	1.18
Herpes simplex	Human virus / DS DNA	7.00	1.26
Reovirus-3	Animal virus / DS RNA	7.46	1.32

The germicidal output of the MP lamp calculated using the action spectra of *B. subtilis* spores and MS2 is equal to or less than that of most of the 14 microorganisms listed in Table D.2. Thus, it is reasonable to assume that these microorganisms are acceptable as challenge microorganisms for many pathogens whose action spectra are not known, like adenovirus and *Giardia*. However, if an alternative challenge microorganism is to be used, its action spectra should be assessed for suitability.

As an alternate approach to measuring the action spectrum, the correction factor can also be estimated by comparing the UV dose-response of the challenge microorganism to that of MS2 measured with a LP and a MP lamp. The correction factor would be defined as:

$$CF_{as} = 1.04 \left(\frac{\left(\frac{k_{MP}}{k_{LP}} \right)_{challenge}}{\left(\frac{k_{MP}}{k_{LP}} \right)_{MS2}} \right) \quad \text{Equation D.4}$$

Where:

- CF_{as} = Correction factor for the difference in action spectra between the challenge microorganism and MS2 (unitless)
- k_{MP} = Slope of the UV dose-response measured with a MP collimated beam (cm^2/mJ)
- k_{LP} = Slope of the UV dose-response measured with a LP collimated beam (cm^2/mJ)
- 1.04 = Germicidal output of MS2 relative to *Cryptosporidium*, from Table D.2 (unitless)

Example D.8. A UV reactor is validated with the virus ϕ x-174 (germicidal output relative to *Cryptosporidium* is 1.14). The reactor uses the UV Intensity Setpoint Approach and measures an RED of 25 mJ/cm² at the setpoint. In calculating the validated dose for *Cryptosporidium* or *Giardia* inactivation credit, the measured RED used to calculate the Validated Dose (discussed in Section 5.8.2) would have to be adjusted to $25 \text{ mJ/cm}^2 / 1.14 = 22 \text{ mJ/cm}^2$.

NOTE: The correction factor described in this section is applicable *only to MP reactors*. It should be used if $CF_{as} \geq 1.06$. The correction factor that accounts for differences in the action spectra is not the same correction factor that accounts for differences in the microorganism UV sensitivities described in Section D.1 (UV dose-distribution impacts). The correction factor described in Section D.1, the “RED Bias,” applies to all UV reactors regardless of lamp type.

D.4.2 Water Absorption of UV Light

During UV reactor validation, a UV-absorbing chemical is added to the bulk flow passing through the reactor in order to simulate high-UV absorbance (low-UVT) events that could occur at a WTP. Common UV-absorbing chemicals currently in use for validation testing include lignin sulfonate, sodium thiosulfate, fluorescein, coffee, concentrated humic acids, tea, and parahydroxybenzoic acid. Ideally, the spectral absorption of the water used to validate UV reactors equipped with MP lamps should match the spectral absorption of the water at the WTP over the wavelength range associated with UV dose delivery and monitoring. Figure D.9 illustrates UV spectra measured in waters at several different WTPs.

Figure D.10 compares the UV absorbance spectra of coffee and lignin sulfonate to those of two drinking water sources (“Water A” and “Water B”). For a given UVT, the UV absorption at wavelengths above and below 254 nm is greater with coffee and lignin sulfonate than with the drinking water sources. If those chemicals are used during validation of a MP reactor, the RED and UV intensity values measured at a given flow rate, lamp output, and water UVT will be lower during validation than at the WTP (Wright et al. 2002).

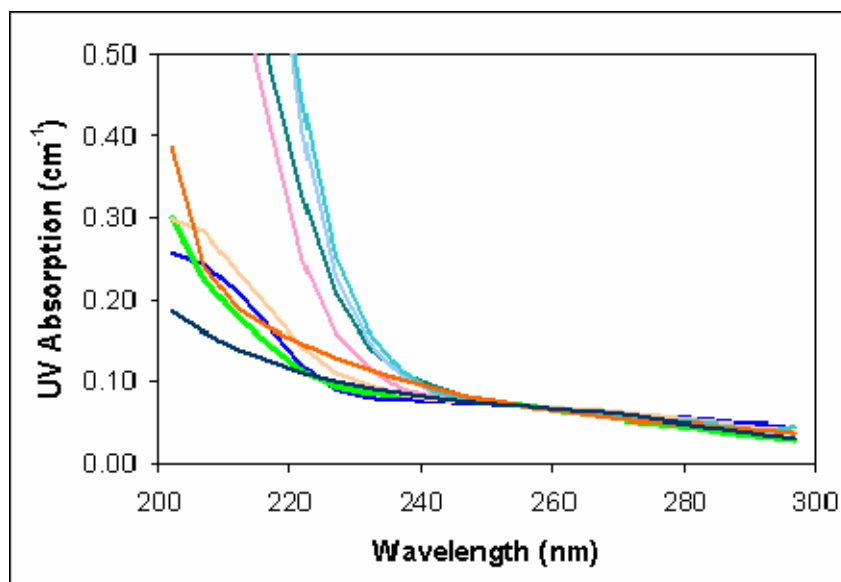
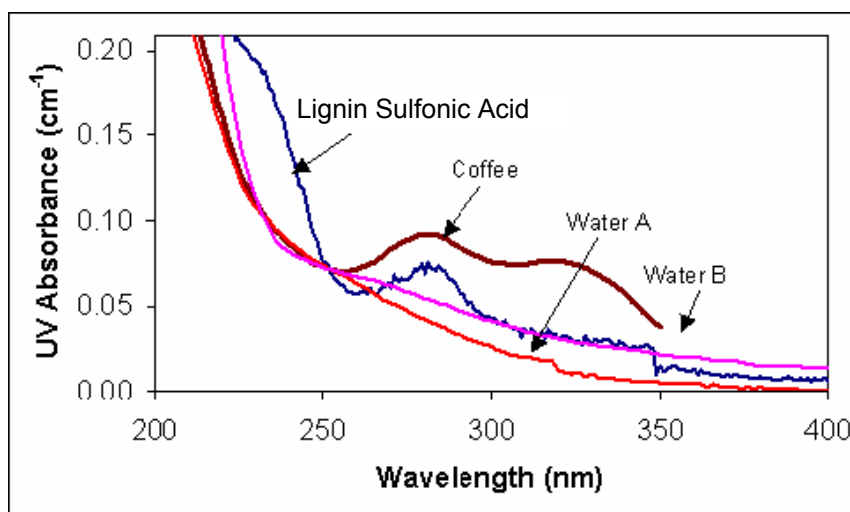
Figure D.9. Spectral UV Absorption of Water at Various WTPs**Figure D.10. Comparison of the UV Absorbance Spectra of Additives Used during UV Reactor Validation to the UV Absorbance of Two Finished Waters**

The magnitude of the impact of this difference in the UV absorbance spectra on the measured UV intensity will depend on the location of the UV sensors relative to the lamps (Wright et al. 2002). Any new or alternative chemical used to alter UVT in the validation test should have its UV absorbance spectra evaluated and compared to natural waters. Significant differences will result in a proportionally large impact on RED and intensity readings during validation.

D.4.3 Determining the Polychromatic Bias Factor (B_{Poly})

The term “polychromatic bias” refers to polychromatic differences between validation and operation of a UV reactor. UV reactors with MP lamps that were installed prior to the publication of this document may use *non-germicidal sensors* and, thus, may exhibit polychromatic bias. To account for polychromatic bias during validation testing, a polychromatic bias factor (B_{poly}) should be incorporated into the Validation Factor:

$$VF = B_{RED} \times B_{Poly} \times \left(1 + \frac{U_{Val}}{100}\right) \quad \text{Equation D.5}$$

See Section 5.9 for a complete discussion of the Validation Factor.

Tables D.2 and D.3 should be used to estimate B_{Poly} using the following validation testing information:

- The UV-absorbing compound (coffee or LSA)
- The minimum UVT tested (for all validation tests)
- The lamp sleeve-to-sensor distance (i.e., water layer)

Note that Tables D.2 and D.3 are for discreet values of UVT and lamp sleeve-to-sensor distance. The Polychromatic Bias Factor can be interpolated for intermediate values.

Example D.9. An MP UV reactor with a non-germicidal sensor located 5 cm from the lamp sleeve is validated using coffee as a UV-absorbing chemical. The UV reactor is validated at a minimum UVT value of 85%. Using Table D.4, the polychromatic bias values at 85% UVT values is **1.12**.

Table D.3. Polychromatic Bias Values for an MP UV Reactor Using a Non-germicidal UV Sensor and Validated with LSA

Water Layer (cm)	Polychromatic Bias Values for a UVT of:					
	70%	80%	85%	90%	95%	98%
2	1.00	1.00	1.00	1.00	1.00	1.00
5	1.22	1.08	1.04	1.00	1.00	1.00
10	1.74	1.38	1.25	1.13	1.05	1.02
15	2.28	1.71	1.48	1.27	1.12	1.05
20	2.76	2.07	1.74	1.42	1.18	1.07
25	3.19	2.41	1.99	1.58	1.25	1.10

Note: water layer = sensor to lamp distance

Table D.4. Polychromatic Bias Values for an MP UV Reactor Using a Non-Germicidal UV Sensor and Validated with Coffee

Water Layer (cm)	Polychromatic Bias Values for a UVT of:					
	70%	80%	85%	90%	95%	98%
2	1.01	1.00	1.00	1.00	1.00	1.00
5	1.57	1.22	1.12	1.05	1.01	1.00
10	3.70	1.99	1.56	1.29	1.11	1.04
15	9.42	3.42	2.25	1.61	1.22	1.08
20	24.6	6.11	3.34	2.04	1.35	1.12
25	64.3	11.0	5.11	2.61	1.50	1.16

Note: water layer = sensor to lamp distance

In addition to the polychromatic bias that can occur from the use of non-germicidal sensors, polychromatic bias can occur when a germicidal sensor in an MP UV reactor is farther away from the lamp than the ideal location. In this case, the water layer can act as an optical filter, preferentially absorbing lower wavelength light and introducing polychromatic bias. The polychromatic bias exhibited by germicidal UV sensors that are further away from the lamp than the ideal location is not expected to be significant as long as the sensor is 10 cm or closer to the lamp (or further if the water being tested exhibits a UVT greater than 90%). This criterion is met for most MP reactors on the market at the time of manual publication and thus is not addressed in this manual.

D.5 Analytical Foundation for UV Dose Monitoring and Defining Uncertainty

UV installations should be sized and operated in a manner that accounts for the measurement uncertainty associated with UV dose delivery monitoring. The objective of UV dose delivery monitoring is to indicate the level of inactivation of the target pathogen. This section derives a measurement equation for UV dose monitoring (Wright and Mackey 2003). This equation is used in this manual as the analytical foundation for defining the uncertainty of UV dose monitoring.

Consider a UV installation operating at a WTP. Assuming first-order kinetics, the log inactivation of a target pathogen achieved by the UV reactor at some point in time can be expressed using Equation D.6:

$$\log I_p = \frac{RED_p}{D_{10p}} \quad \text{Equation D.6}$$

where:

$\log I_p$ = Log inactivation of the pathogen

RED_p = RED of the pathogen (mJ/cm^2)

D_{10p} = UV sensitivity of the pathogen (mJ/cm^2 per log I)

If the UV reactor delivers a UV dose distribution, the log inactivation of the pathogen is related to the inactivation of a challenge microorganism by substituting Equation D.1 into Equation D.6:

$$\log I_p = \frac{1}{B_{RED}} \frac{RED_c}{D_{10p}} \quad \text{Equation D.7}$$

where:

RED_c = RED of the challenge microorganism (mJ/cm²)

Assuming the challenge microorganism RED is proportional to the measured UV intensity ($RED_c \propto S$), the log inactivation of the pathogen can be expressed according to Equation D.8:

$$\log I_p = \frac{1}{B_{RED}} \frac{\alpha S}{D_{10p}} \quad \text{Equation D.8}$$

where:

S = UV intensity measured at the WTP with a duty UV sensor (mW/cm²)

α = Constant relating challenge microorganism inactivation to measured intensity (mJ/mW)

The constant α is determined during validation as the ratio of the measured RED of the challenge microorganism to the measured UV intensity (RED_c/S). Assuming that inactivation is proportional to flow rate ($\log N_p \propto Q$), Equation D.9 can be used:

$$\log I_p = \frac{1}{B_{RED}} \frac{RED_c}{D_{10p}} \frac{S}{S_v} \frac{Q_v}{Q} \quad \text{Equation D.9}$$

where:

S_v = UV intensity measured during validation (W/cm²)

Q_v = Flow rate measured during validation (mgd)

Q = Flow rate measured at the WTP (mgd)

Assuming the UV dose-response of the challenge microorganism follows first-order kinetics, the challenge microorganism RED during validation is calculated using the log inactivation of the challenge microorganism measured through the reactor:

$$RED_c = D_{10c} \log\left(\frac{N_{oc}}{N_c}\right) \quad \text{Equation D.10}$$

where:

D_{10c} = UV sensitivity of the challenge microorganism (mJ/cm² per log inactivation)

$N_{o,c}$ = Challenge microorganism concentration measured at the reactor influent (organisms/mL)

N_c = Challenge microorganism concentration measured at the reactor effluent (organisms/mL)

The UV sensitivity of the challenge microorganism (D_{10c}) can be calculated according to Equation D.11 from the UV dose-response measured using the collimated beam apparatus:

$$D_{10c} = \frac{D_{CB}}{\log I_C} \quad \text{Equation D.11}$$

where:

D_{CB} = UV dose delivered by the collimated beam apparatus (mJ/cm²)
 $\log I_C$ = Log inactivation of the challenge microorganism observed with a UV dose of D_{CB}

Substitution of Equations D.10 and D.11 into equation D.9 gives the equation for dose monitoring using the UV Intensity Setpoint Approach:

$$\log I_p = \frac{1}{B_{RED}} \frac{D_{CB}}{D_{10p}} \frac{S}{S_v} \frac{Q_v}{Q} \frac{\log(N_{0,c}/N_c)}{\log I_C} \quad \text{Equation D.12}$$

The uncertainty of dose monitoring arises from the uncertainties associated with each term in the measurement equation (Wright and Mackey 2003, Taylor 1982) and is accounted for by application of the validation factor (VF) in Section 5.9 and the application of quality assurance/quality control during operation of the reactor at the WTP.

D.6 Considerations for CFD Modeling

CFD UV dose modeling of the impact of UV reactor inlet and outlet conditions on RED could be used in conjunction with one of the approaches outlined in Section 3.6. to assess whether UV dose delivery at the WTP installation is equal to or better than UV dose delivery achieved during validation. However, several issues with a CFD-based approach should be considered:

- There is little agreement on appropriate procedures for assessing the credibility of CFD models.
- CFD models for prediction of UV dose delivered by a reactor comprise coupled sub-models for turbulent flow, microbial transport, UV intensity, and microbial inactivation. Many options and approaches are available for each sub-model. Currently, no consensus has been reached for which approaches are most suitable for predicting UV dose delivery in a full-scale reactor.
- CFD modeling of UV dose delivery requires a multi-disciplinary approach. Knowledge of fluid mechanics, light physics, microbial inactivation, numerical modeling, and UV process engineering is essential for credible CFD modeling of UV

dose delivery. The pool of this type of integrated expertise is currently limited, which presents a challenge for states tasked to review CFD modeling reports.

A generalized modeling approach for predicting UV dose delivery involves the following:

1. Construct a 3-D computational model of the UV system, including all major components that influence the flow patterns in the reactor. This includes resolution of all wetted surfaces in the reactor and the upstream/downstream piping systems.
2. Perform a steady-state CFD simulation by solving governing flow equations (i.e., Navier-Stokes and turbulence equations). This results in a prediction of point velocities across the interior of the UV system for the specified inlet flow rate.
3. Perform a UV intensity simulation for the UV system using a UV light intensity model. This results in a prediction of point UV intensity values across the interior of the UV system for specified values of UV lamp intensity and UVT.
4. Perform a particle tracking simulation using the combined numerical flow/UV intensity field. A random walk or particle physics model may be employed. Hundreds of numerical particles are randomly “injected” at the model inlet, and their x,y,z-coordinates are predicted as a function of time. The result is a predicted path line for each injected particle, which represents a random microbial path through the reactor.
5. Calculate the estimated UV dose for each injected particle by summing the cumulative UV dose at a series of points along the predicted particle path. The result is a UV dose distribution.
6. Determine the log inactivation and RED for a microorganism with known UV inactivation kinetics based on the UV dose distribution calculated in Step 5.

If CFD is applied for simulation of UV dose delivery, it should adhere to the following guidelines:

1. Only a qualified party with appropriate expertise should develop a CFD-based hydraulic or full UV reactor performance model. Such parties could include a professional engineer with extensive modeling experience, a CFD consulting firm, or a manufacturer with review by an independent CFD consultant.
2. The same overall modeling approach and sub-models should be used for both the validation site model and the WTP model. At a minimum, the following QA/QC procedures should be used during CFD model development and execution:
 - The density of the numerical grid and size of the time step used in simulations affect CFD results. In general, results become more accurate as the grid becomes finer and the time step becomes smaller. Grid and time-step convergence analysis should be performed to verify that grid and time-step sizes are sufficiently resolved such that smaller grid and time step sizes do not change predicted results.

Procedures for this analysis are presented in the *Guide for the Verification and Validation of Computational Fluid Dynamics Simulations* (AIAA 1998).

- Numerical convergence and consistency of the CFD models should be verified and documented. Procedures for this analysis are presented in the above-referenced AIAA guide.
 - A sensitivity analysis of the major parameters that affect UV-dose prediction should be conducted. Examples include (but are not limited to) boundary conditions for lamp UV output and reactor wall reflection, number of particles used in a microbial transport simulation, and UV dose-response inactivation constants.
3. CFD models should not be calibrated with experimental RED data for the purposes of obtaining agreement between model predictions and field measured values. Calibration to RED data for a limited set of conditions does not necessarily improve the accuracy of future predictions, particularly because hydraulic conditions can greatly differ between the validation site and the WTP installation.
 4. Error estimates and confidence intervals for the CFD model predictions should be developed for both the validation site and the WTP installation. This could be performed by comparing CFD model predictions and experimental data for the validation site, then assuming the same level of error for the CFD model prediction for the WTP installation.

Following the above guidelines, CFD can be used to predict the relative difference in RED between a validation site and a WTP installation. If analysis indicates that UV dose delivery is better at the WTP, RED credit should only be granted for the experimentally measured RED from the validation site.

CFD-based UV dose modeling should not be used in lieu of validation for prediction of the actual RED magnitude as a means of granting pathogen inactivation credit. As discussed previously, CFD is still an emerging technology, and CFD models for UV dose delivery are complex. Uncertainty and error ranges for these models are not known. CFD-based UV dose delivery models would need to undergo a formal industry-wide verification and validation process before they could be considered suitable for extrapolation of data for establishing inactivation credit. A possible approach for verification and validation of hydraulic CFD models is outlined in the AIAA CFD guide (1998).

It is anticipated that CFD models for UV dose prediction will develop and improve in the future. This manual is not intended to be the final word on CFD modeling for UV disinfection. Engineers, regulators, and manufacturers should also consult with the AIAA manual and future CFD guidance that may arise in the water industry.

This page intentionally left blank.

Appendix E

UV Lamp Break Issues

This page intentionally left blank.

The lamps in most UV reactors designed for water disinfection contain mercury or an amalgam of mercury and another element, such as indium or gallium. Mercury has properties that allow for cost-effective generation of UV light. These properties include a sufficient vapor pressure at ambient temperatures to provide for efficient production of resonance radiation and a low ionization energy to facilitate starting a lamp (Phillips 1983). Lamp manufacturers are continuing to reduce the mercury content of UV lamps (USEPA 1997b; Walitsky 2001). However, mercury-free lamps, such as pulsed UV lamps containing xenon, are not widely used for water disinfection at present.

The mercury contained within a UV lamp is isolated from exposure to water by the lamp envelope (referred to as the “lamp” in this appendix for simplification) and a surrounding lamp sleeve (Figure 2.13). However, breakage of a UV lamp creates the risk of exposure to mercury, which can cause adverse health effects (USEPA 2006).

Although UV disinfection utilizes UV lamps with mercury, UV disinfection is an important disinfection technology that provides additional public health protection. To date, there have been few lamp breaks at existing UV facilities. The risk to human health and the environment from the mercury in UV lamps used in the treatment of drinking water is very small. It can be addressed through engineering and administrative methods used to prevent UV lamp breaks and exposure to mercury if breaks do occur, as described in this appendix.

This appendix discusses the issues associated with breaks of UV lamps used for drinking water disinfection. Lamp breaks are divided into off-line and on-line breaks. Off-line breaks occur when the lamps are not installed in the reactor or when the reactor is not in operation. On-line lamp breaks occur when the lamp and lamp sleeve break during reactor operation.

Sections E.1.1, E.2.1, and E.2.2 address potential causes of lamp breaks (including known occurrences) and corresponding preventive measures. Sections E.2.3 and E.2.4 address containment of mercury after a break and suggest components of a lamp-break response plan. Regulatory issues associated with lamp breaks, including lamp disposal, are discussed in Section E.3. Mercury in UV disinfection facilities and documented mercury reactions in PWS, is discussed in Sections E.4 and E.5. A summary of the information presented in this appendix is located in Section E.6. References for this appendix are presented in Chapter 7.

E.1 Off-line Lamp Breaks

Off-line breaks occur when a lamp breaks during shipping, handling, storage, or maintenance. Off-line breaks also can occur when the lamp and the lamp sleeve break in a UV reactor that is **not** in operation. Because water is not flowing through the reactor, off-line breaks do not pose a hazard to the water consumer but may be a hazard to operators or employees in the vicinity of the break.

E.1.1 Potential Causes of Off-line Lamp Breaks and Corresponding Prevention Measures

Off-line lamp breaks are caused by improper handling. The UV manufacturer should train operators in proper handling and maintenance of UV lamps. In addition, lamps should be stored horizontally in individual packaging to reduce the potential for lamp breaks. Lamps should not be stacked unpackaged or propped vertically in corners (Dinkloh 2001).

E.1.2 Off-line Mercury Release Cleanup Procedures

Water systems should have a lamp break response plan for containing and cleaning the off-line spills. The local poison control center, fire department, or public health board can assist in determining appropriate responses for different spill sizes and in developing a plan.

Small spills can be contained and collected with commercially available mercury spill kits. Small spills are defined as the amount of mercury in a broken thermometer, or less than 2.25 grams (g) (USEPA 1992, USEPA 1997a). Given that the mercury content in a single UV lamp typically ranges from 0.005 – 0.4 g (discussed in Section E.4.2), a single lamp break and multiple lamp breaks that result in release of less than 2.25 g are categorized as small spills.

Mercury and materials used during the cleanup procedure are regulated as hazardous wastes and should be disposed of properly as described in Section E.3.3. EPA's Office of Superfund Remediation and Technology Innovation (formerly the Office of Emergency and Remedial Response) recommends that "...[in] the event of a large mercury spill (more than a broken thermometer's worth), immediately evacuate everyone from the area, seal off the area as well as possible, and call your local authorities for assistance..." (USEPA 1997a).

E.2 On-line Lamp Breaks

On-line lamp breaks occur when a lamp and lamp sleeve break while water is flowing through the reactor. These breaks may have the potential to pose a hazard to the water consumer, as well as to operators or employees in the vicinity of the break. This section discusses potential causes of on-line lamp breaks, prevention measures, and documented occurrences of on-line lamp breaks and mercury release.

E.2.1 Potential Causes of On-line Lamp Breaks and Corresponding Prevention Measures

Lamp breaks can be caused by debris in the water, improper UV reactor orientation, water temperature variations, exceeding positive or negative pressure limits (water hammer), electrical surges, or improper maintenance. Lamps may also break as a result of manufacturing defects in the lamp or improper selection of the lamp or sleeve material.

E.2.1.1 Debris

Debris may originate from the raw water or from treatment process equipment. Although most UV reactors will be installed after the filters in the treatment train, upstream equipment may release parts or fragments such as nuts or bolts that can break the lamp sleeves or UV lamps. Unfiltered systems may be more prone to debris because there is minimal upstream treatment to UV disinfection, which should be considered in the UV facility design. Groundwater systems have the potential to pull stones or gravel from wells that can enter UV reactors and break lamps (Malley 2001, Roberts 2000).

The consideration of prevention measures may be beneficial if debris historically has occurred prior to installation of the UV facility. Placement of screens, baffles, or low velocity collection areas upstream of UV reactors or vertical orientation (i.e., vertical flow of water through the UV reactor) may reduce the risk of debris entering the reactor (Cairns 2000, Malley 2001, McClean 2001b). Note that the lamps should be oriented horizontally relative to the ground even if the UV reactor is installed with water flowing vertically as discussed in Section E.2.1.2. The extent of containment these safety measures provide is unknown. Water systems and designers should determine the applicability of these techniques on a site-specific basis.

E.2.1.2 Improper UV Lamp Orientation

The orientation of UV lamps within a UV reactor can also increase the potential for lamp breaks. Orienting lamps perpendicular to the ground can result in differential heating of the lamp and the sleeve, which can lead to eventual cracking of the lamp and sleeve. As such, regardless of the direction of water flow relative to the ground, UV lamps should be oriented parallel and not perpendicular to the ground (Figure E.1).

Figure E.1. Example of Proper Horizontal and Improper Vertical UV Lamp Orientation in Reactors Relative to the Ground

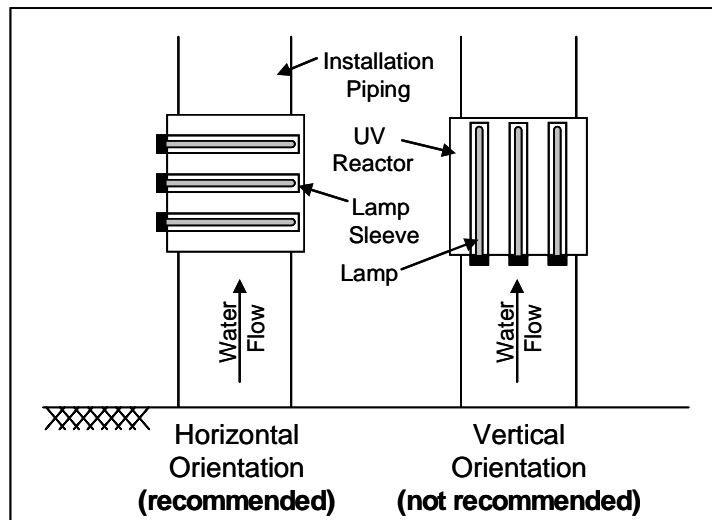

E.2.1.3 Loss of Water Flow and Temperature Increases

UV lamps are designed to operate within a specific temperature range to maximize UV light output. Without flowing water to cool the lamp, the lamp temperature can rise above the maximum operating temperature and break (Dinkloh 2001, Malley 2001, Srikanth 2001a, Srikanth 2001b). There are two conditions that may cause overheating of lamps:

- Operating UV lamps while there is no water in the UV reactor (i.e., the lamp is in air)
- Operating UV lamps while water is not flowing through the UV reactor (i.e., the water in the UV reactor is stagnant)

Overheating occurs much faster in air than in stagnant water and is more likely to occur with medium-pressure (MP) than low-pressure (LP) lamps (due to lamp operating temperatures). If UV lamps are energized in air, the lower temperature water entering the reactor may cause the lamp sleeve and the lamp to break due to temperature differentials (Dinkloh 2001, Malley 2001), even if upper temperature levels are not exceeded. Lamp overheating and temperature differentials could, therefore, break all the lamps within the affected reactor.

Operating a UV lamp in stagnant water can also cause lamps to overheat and break. Water flow during UV start-up (i.e., cooling water) cools the lamps and prevents lamps from overheating and breaking. However, cooling water may not be necessary with low-pressure high-output (LPHO) lamps (Haubner 2005). Whether cooling water is needed depends on the specific MP reactor manufacturer, and the manufacturer should be contacted to determine this (Leinberger 2005, Lerner 2005, Bircher 2005).

To prevent lamp breaks, operating procedures should ensure that the following conditions are met:

- The lamps are not operating while the reactor is not full (i.e., while air is in the reactor).
- If recommended by the UV manufacturer, water should be flowing through the UV reactor if the UV lamps are operating.

Hydraulics should be designed so that lamps are submerged at all times during reactor operation. UV facility designs should also incorporate low flow alarms, air relief valves, or other devices to ensure that lamps are operating only when the reactor is completely flooded and water is flowing. UV equipment should and typically does include temperature sensors and alarms that automatically shut down the reactor before critical temperatures are exceeded (Leinberger 2005, Lerner 2005, Bircher 2005, Dinkloh 2001, Malley 2001, Srikanth 2001b).

E.2.1.4 Pressure-related Events

Hydraulic pressures that exceed the operating limits of the lamp sleeves may break them. Although breaking the lamp sleeve does not automatically break the lamp, the lamp is more vulnerable when the sleeve has been damaged, potentially allowing the hot lamp to come into direct contact with colder surrounding water.

Most lamp sleeves are designed to withstand continuous positive pressures of at least 120 pounds-force per square inch gauge (psig) (Roberts 2000, Aquafine 2001, Dinkloh 2001, Srikanth 2001a, Srikanth 2001b). However, negative gauge pressures below -1.5 psig have been shown to adversely affect lamp sleeve integrity (Dinkloh 2001). The pressure tolerance of the quartz lamp sleeve varies and depends on the quality, thickness, and length of the sleeve. Positive and negative pressures that exceed these levels, such as those associated with water hammer, may cause the lamp sleeve to crack or break.

Thus, water hammer can potentially break all lamps within an affected reactor. The water system should perform a surge analysis to determine if water hammer is a potential problem, and the UV facility designer should specify the pressure and flow ranges expected. The manufacturer should provide lamp sleeves with the appropriate material, thickness, geometry, and seals for the specified pressure and should provide the water system with the lamp sleeve pressure tolerances.

E.2.1.5 Handling and Maintenance Errors

A lamp or lamp sleeve damaged by improper off-line handling or maintenance may break when the UV reactor is returned to service. For example, over-tightening compression nuts when securing the lamp sleeve can cause a fracture of the lamp sleeve or a leak around the sleeve or compression nut cavity (Aquafine 2001, Dinkloh 2001, Srikanth 2001a, Srikanth 2001b, Swaim et al. 2002). This problem may not become apparent until after start-up of the UV reactor and may cause a lamp break. Operation and maintenance training can help prevent these types of lamp breaks.

E.2.1.6 UV Reactor Manufacturing Problems

The UV reactor manufacturer should design the UV reactor to reduce the possibility of lamp breaks. This section describes UV manufacturing problems that may cause lamp breaks if not properly addressed. Addressing these UV reactor manufacturing issues is typically the responsibility of the manufacturer. However, some causes of lamp breaks can be mitigated during the design of the UV facility.

Electrical Considerations

If the UV facility electrical support system is improperly designed (e.g., inadequate circuit breakers and ground fault indicator circuits), electrical surges can cause short-circuiting and lamp socket damage (Srikanth 2001a, Srikanth 2001b). In addition, system electronics that can produce voltages exceeding lamp ratings (overdriving lamps) may also cause the lamp to break (Malley 2001).

To reduce the likelihood of these problems, the UV facility designer should specify circuit/ground fault interrupters (GFI) in the UV facility electrical design. In addition, replacement UV lamps should be electrically compatible with the UV equipment.

Cleaning Mechanism Considerations

The cleaning mechanism may break the lamp sleeve and lamp if the mechanism is not aligned properly. Although the cleaning mechanism closely surrounds the lamp sleeve for cleaning, manufacturers should ensure that the mechanism is flexible and able to adjust to minor misalignment of the lamp sleeves.

At high lamp temperatures, the cleaning mechanism in some UV reactors may fuse to the lamp sleeve when not in use. As a result, during the next cleaning event, the lamp sleeve may crack when the cleaning mechanism is activated or when the cleaning mechanism passes back over the residual left on the lamp sleeve (Dinkloh 2001). Some UV reactors are not subject to this problem because the wipers rest away from the lamp sleeve when not in use and an alarm sounds when the wiper stops along the lamp sleeve.

Once the UV facility is in operation, the operators should perform routine inspections of the inside of the UV reactors to ensure that the cleaning mechanism is not fused to the sleeve.

Thermal Expansion and Contraction

Other potential causes of lamp breaks include improper matching of lamp materials with respect to thermal expansion characteristics. Manufacturers should use compatible materials within the lamp to avoid stress and damage from thermal expansion and contraction differences between materials that can occur under various operating, shipping, or handling conditions (Cairns 2000). In addition, improper seal design or lamp swelling can cause water leaks around the seals that can result in electrical shorts and cracking of lamps (Cairns 2000).

The UV facility designer should specify the temperature ranges likely to be encountered during shipping, storage, and lamp operation in the UV equipment procurement documents so the manufacturer can select the appropriate materials.

E.2.1.7 Summary of Potential Causes and Methods of Prevention of On-line UV Lamp Breaks

Table E.1 summarizes the potential causes of on-line lamp breaks and briefly describes the preventive measures that UV facility designers and operators can implement to reduce each risk. Documented cases of on-line lamp breaks are discussed in Section E.2.2.

E.2.2 On-line Lamp Break Incidents

Relatively few incidents of on-line lamp breaks with mercury release have been documented. A literature review was conducted to compile information on UV lamp breaks in operating UV facilities. Several facilities were contacted for more information about the incidents. Although all documented lamp breaks involved MP lamps, some of the causes reported for the lamp breaks are independent of the lamp type (Malley 2001). The documented lamp break incidents, categorized according to the cause of the incident, are summarized in Table E.2.

Table E.1. Summary of Potential Causes and Methods of Prevention of On-line UV Lamp Breaks

Potential Cause	Description	Preventive Measure
Debris	<ul style="list-style-type: none"> Physical impact of debris on lamp sleeves may cause lamp breaks. 	<ul style="list-style-type: none"> Installation of screens, baffles, or low velocity collection areas upstream of UV reactors or vertical installation of UV reactors will help prevent debris from entering the reactor.
Lamp Orientation	<ul style="list-style-type: none"> Vertical installation relative to the ground may cause overheating and lamp breaks. 	<ul style="list-style-type: none"> Install reactors with lamps oriented parallel to the ground to reduce differential heating.
Loss of Water Flow and Temperature Increases	<ul style="list-style-type: none"> Lamps may overheat and break. The temperature differential between stagnant water or air and flowing water (upon resumption of flow) may cause lamp breaks. 	<ul style="list-style-type: none"> Reactors should always be completely flooded and flowing during lamp operation. Temperature and flow sensors that are linked to an alarm and automatic shutoff system can be used to indicate irregular temperature or flow conditions.
Pressure-related Events	<ul style="list-style-type: none"> Excessive positive or negative pressures may exceed lamp sleeve tolerances and break the lamp sleeve. 	<ul style="list-style-type: none"> A surge analysis should be completed during design to determine the occurrence of water hammer. Pressure relief valves or other measures can be used to reduce pressure surges. Applicable pressure ranges should be specified for lamp sleeves.
Maintenance and Handling Errors	<ul style="list-style-type: none"> Improper handling or maintenance may compromise the integrity of the lamp sleeve and/or lamp. 	<ul style="list-style-type: none"> Operators and maintenance staff should be trained by the manufacturer.
UV Reactor Manufacturing Problems	<ul style="list-style-type: none"> Electrical surges can cause short-circuiting and lamp socket damage. 	<ul style="list-style-type: none"> Adequate circuit breakers/GFI should be specified to prevent damage to the reactor.
	<ul style="list-style-type: none"> Applying power that exceeds design rating of lamps can cause lamps to burst from within. 	<ul style="list-style-type: none"> Replacement lamps should be electrically compatible with reactor design.
	<ul style="list-style-type: none"> Misaligned or heat-fused cleaning mechanism may break or damage the lamp sleeve and lamp. 	<ul style="list-style-type: none"> Operators and maintenance staff should perform routine inspection and maintenance according to manufacturers' recommendations.
	<ul style="list-style-type: none"> Thermally incompatible materials do not allow for expansion and contraction of lamp components under required temperature range. 	<ul style="list-style-type: none"> Designers should specify temperature ranges likely to be encountered during shipping, storage, and operation of lamps to aid the manufacturer in the selection of thermally compatible materials.

Table E.2. Mercury Release Incidents Involving UV Lamp Breaks

Identified Cause	Number of Incidents	Description of Incident
Debris	5	(4) Stones entered the reactors and struck the lamps. ¹ (1) Gravel entered the reactor through the booster pump and struck the lamp. ²
Loss of Water Flow and Temperature	2	(2) Lamps were left on and allowed to reach high temperatures [600 degrees Centigrade (°C)] in empty non-operating reactors. ¹ Restoration of flow caused cooler water (20 °C) to break the lamps.
Operator Error	1	(1) Forklift collided with on-line reactor. ³
Manufacturer Design	7	(1) Applied power exceeded the tolerances of the lamp, causing the lamp to burst from within. ¹ (2) Vertical orientation of lamps in the reactor resulted in differential heating and eventual cracking of the lamp and sleeve because heat accumulated at the tops of the lamp and sleeve. ¹ (1) High operating temperatures resulted in deformation of the lamp sleeve. The lamp sleeve sagged and on contact with the lamp, both the lamp and lamp sleeve broke. ⁴ (1) Manufacturing defect. Lamps exploded after approximately 300 hours of operation. ⁵ (2) Contaminated quartz material used by lamp manufacturer. ⁶

¹ Survey of European water and domestic wastewater and hazardous waste treatment systems (Malley 2001)

² European drinking water systems (Roberts 2000)

³ European brewery (Roberts 2000)

⁴ UV-peroxide groundwater remediation reactor (Moss 2002a)

⁵ Drinking water system (Region of Waterloo 2004)

⁶ Drinking water system (Wright 2005)

Impacts from debris caused five of the documented lamp breaks. In four of the five incidents reported, UV lamps were oriented perpendicular to the flow of water, indicating that lamps in this orientation may be more vulnerable to lamp breaks. However, the lamps in one instance were parallel to the flow of water, so orientation alone will not prevent lamp breaks.

An additional incident involving debris occurred when a bolt from the filter underdrain broke a lamp sleeve. The lamp was not broken by the bolt, and mercury was not released because the UV equipment was immediately shut down to respond to the sleeve break (McClellan 2001a). Because no mercury was released, the incident is not included in Table E.2; however, this incident indicates that equipment debris can also be hazardous.

Loss of water flow and the resulting increase in lamp temperature caused two of the documented lamp breaks. In these cases, the operating lamps reached extremely high temperatures (> 600 °C) in air. When water flow resumed, the cooler water (20 °C) caused the lamps to break (Malley 2001). These incidents can be prevented if UV equipment has a safety mechanism that will shut down the UV lamps if flow decreases or lamp temperature significantly increases (Malley 2001).

Operator error caused one of the documented lamp breaks. A forklift was driven into an operating reactor and physically damaged the UV reactor. The event activated an alarm and pneumatic valve closure, which contained the mercury release (Roberts 2000).

The seven remaining lamp breaks are attributed to improper manufacturer design. In one of the lamp breaks, 30-kilowatt (kW) power was specified for the application. However, a manufacturing error resulted in a higher power being applied and caused the lamp to burst from within (Malley 2001).

Another manufacturer design problem that resulted in two breaks was vertical orientation of the lamps within the UV reactor. The vertical orientation allowed heat to accumulate at the tops of the lamp and sleeve, which caused them to break (Malley 2001). It is worth noting that modern UV reactors do not mount lamps vertically, even in vertically oriented reactors such as those discussed in Section E.2.1.2.

Another lamp break attributed to a manufacturer design flaw resulted from deformation of the lamp sleeve at operating temperatures. The incident occurred in a UV-peroxide reactor designed for well-head treatment of tetrachloroethene-contaminated groundwater (Moss 2002a). The UV reactor was positioned between the groundwater extraction pump and the distribution system booster pumps. The 7-foot long MP lamp sleeve sagged and came into contact with the lamp. The lamp and lamp sleeve broke, releasing mercury. The lamp failure triggered an alarm, shutting down both the groundwater extraction and distribution system booster pumps. Liquid mercury was found on the bottom of the reactor. Water samples taken at a nearby fire hydrant were positive for mercury but were below the maximum contaminant level (MCL) of 2 micrograms per liter ($\mu\text{g/L}$) (Moss 2002a, Moss 2002b).

Similar to the prior incident, a manufacturing defect in an MP lamp caused several lamps at a WTP to explode after approximately 300 hours of operation, releasing mercury into the water (Tramosch 2004). The break occurred in a large 47-inch diameter horizontal reactor. The lamp failure alarm triggered closure of the reactor isolation valves within 90 seconds and initiated automatic flushing of the clearwell. The quartz fragments and 64 percent of the mercury were recovered in the bottom of the reactor. The baffles within the reactor appear to have prevented the mercury and quartz from leaving the reactor after the break. The flushed clearwell water was sent to an on-site holding tank where it was tested for mercury, which was not detected. Mercury was also not detected in the piping between the UV reactors and the clearwell and in the UV reactor drain water. The water system believes that the remainder of the mercury was fused to the reactor walls because mercury was not discovered downstream, and mercury vapor was detected in the UV reactor when the hazardous materials (HazMat) contractor was cleaning the UV reactor.

Twenty four hours after the reactor was drained in response to the lamp break, mercury vapor concentrations within the reactor exceeded health and safety limits (Section E.3.2), although mercury vapor concentrations in the ambient air surrounding the UV reactor were not above these safety limits. During all stages of the cleanup operation, the HazMat contractor ensured that the area was well-ventilated and monitored for mercury vapor. As a result of this incident, the water system observed that cleaning the reactor quickly is imperative because mercury vapor can accumulate in the reactor (Region of Waterloo 2004).

The two final documented lamp breaks occurred because of the use of contaminated quartz material by the lamp manufacturer. The contamination weakened the protective quartz sleeve and the lamp, resulting in breaks at two water treatment plants (WTP).

E.2.3 Design Considerations for Containment after a Lamp and Sleeve Break

This section briefly describes potential methods to contain mercury from a lamp break. However, the extent of containment provided by these measures is unknown. Water systems and designers should determine the applicability of these isolation techniques on a site-specific basis and include the specific steps to be taken in the water system's response plan.

To isolate the mercury in the reactor or downstream, water systems may install spring-return actuated valves with a short closure time on the reactor inlet and outlet piping (McClellan 2001b). Given the short residence time of many MP reactors, the outlet-side valve should be located far enough downstream so that the valve has time to close and isolate the mercury upstream. UV facility designers should evaluate valve closure times with respect to the potential for water hammer.

Condensed mercury and quartz fragments may be contained and collected in areas of low water velocity such as the bottom of a shut-down reactor, sumps, or a clearwell. To prevent quartz fragments from entering the water system, a strainer can be installed on the reactor outlet piping (McClellan 2001b, Srikanth 2001a, Srikanth 2001b). Another option is to include a mercury trap in the design (Figure E.2). A mercury trap could include a tee fitting after the UV reactor. Flow will enter the tee and flow upward. The tee may also include an elbow that is sealed but accessible. If the water velocity in the tee fitting and following pipe is low enough, some of the mercury and quartz fragments may settle out in bottom of the elbow (Mutti 2004). The head loss associated with such measures should be considered in the hydraulic profile. Designers should also consider installation of drains and piping to allow disposal of potentially contaminated water from the reactor or trap to a waste container or truck. **The effectiveness of a strainer and mercury trap has not been evaluated and is unknown.**

E.2.4 On-line Lamp Break Response Plan

On-line lamp breaks should be preventable with appropriate design and operation of UV reactors. However, water systems should develop a written lamp break response plan in case an on-line UV lamp break occurs. Water systems should coordinate with their state when developing the following plan components:

- Identification of a lamp break
- Site-specific containment measures
- Mercury sampling and compliance monitoring
- Site-specific cleanup procedures
- Reporting requirements
- Public notification requirements

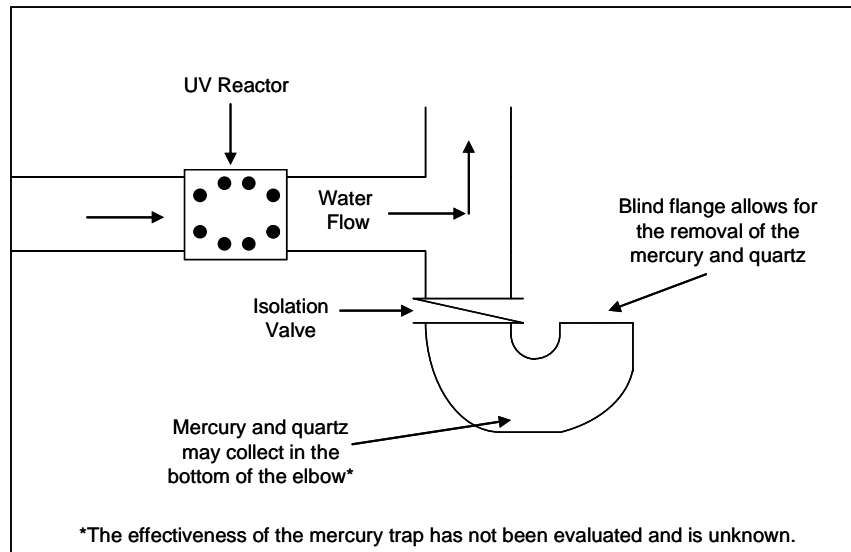
Figure E.2. Example of a Potential Mercury Trap*

Identification of a Lamp Break

UV reactors should be equipped with alarms that are activated when a lamp fails. A lamp failure alarm may be due to a lamp break or to another problem. Because alarms associated with lamp failure and GFIs may be due to lamp and sleeve breaks, the UV equipment should be shut down, isolated in response to these alarms, and inspected to determine whether a lamp break occurred.

Site-specific Containment Measures

In the event of a lamp failure alarm, the UV reactor should be immediately shut down, and operators should assume a lamp break has occurred and implement the procedures to contain the mercury while determining the cause of the alarm. The containment procedures should be outlined in detail in the water system's response plan based on the specific UV facility and any containment measures included in the design.

Mercury Sampling

Mercury sampling should be implemented after an on-line UV lamp break. Sampling procedures should specify sample locations, frequencies, and analysis methods. Sampling frequencies should consider flow rate, detention time, and travel time to the first potential consumer. Sample locations should be chosen based on where the mercury may settle (e.g., low velocity areas) and where mercury vapor may accumulate (e.g., a drained UV reactor). Table E.3 lists some possible sample locations (Region of Waterloo 2004, Stantec 2004).

Table E.3. Mercury Sampling Locations

Media	Location	Purpose
Water	<ul style="list-style-type: none"> • Reactor drain • Piping downstream of the UV reactor, including the distribution system entry point at a minimum • Low velocity areas, such as clearwells 	<ul style="list-style-type: none"> • Assess the extent of mercury contamination and identify areas requiring cleanup.
Air ¹	<ul style="list-style-type: none"> • Reactor or other locations where mercury vapor may collect • Ambient air 	<ul style="list-style-type: none"> • Assess whether it is safe to access mercury-contaminated equipment and piping for cleanup. The UV reactor interior may be accessible through an air vent. • Assess whether adequate ventilation is provided to safely proceed with mercury cleanup.

¹ Methods for air sampling are available from the Occupational Safety and Health Administration (OSHA) at <http://www.osha.gov/dts/sltc/methods/inorganic/id140/id140.html>.

Site-specific Cleanup Procedures

Site-specific cleanup procedures should be incorporated into the water system's response plan. Issues to consider are assessment of mercury contamination in the air, water, or on surfaces, disposal of any isolated or condensed mercury, potential disposal or treatment of contaminated water, cleanup responsibilities (by water system staff or contracted hazardous materials team), and Federal or state cleanup or disposal requirements.

An example of a currently operating UV facility's site-specific clean-up procedures is summarized below. The procedure includes the following major steps (Stantec 2004):

1. Hydraulically isolate the UV reactor.
2. Ventilate the area and shut down ventilation equipment that circulates air to other parts of the building.
3. Wear personal protective equipment, including gloves, eye protection, suits, shoe covers, and breathing protection.
4. Drain water from the reactor through a mesh filter into a tank for disposal.
5. Measure the mercury vapor concentration within the reactor and ensure that it is at an acceptable level (limits shown in Section E.3.2).
6. Open the reactor and remove quartz and mercury from the reactor using a mercury spill kit.
7. Perform a mass balance to assess how much mercury has been recovered.

Reporting and Public Notification Requirements

The water system should determine any reporting and public notification requirements by coordinating with the state. If reporting or public notification is required, the response plan should include the information that must be reported to the state and the notification procedures. Reporting requirements may include a description of the release, estimated quantity of the release, shut-down or containment procedures, cleanup or disposal methods, and sampling procedures (including sampling locations, frequencies, and results).

E.3 Regulatory Review

This section presents a review of regulations that may apply if UV lamp breaks occur at a WTP.

E.3.1 Safe Drinking Water Act

Under the Safe Drinking Water Act (SDWA), EPA established a primary MCL of 2 µg/L for inorganic mercury [40 CFR 141.62(b)] and the associated monitoring requirements. The limit was designed to protect against mercury contamination in the source water and not a transient event like lamp breaks. Consequently, the water system should contact the state to determine whether additional mercury monitoring will be required in response to lamp breaks.

E.3.2 Operator Health and Safety – Exposure Limits

Mercury exposure to employees in WTPs falls under the regulatory authority of OSHA. The exposure limits set by OSHA focus on exposure through inhalation. OSHA regulations have established permissible exposure limits (PELs) for mercury compounds and organo alkyls containing mercury. A PEL is a time-weighted average concentration that is not to be exceeded for an 8-hour workday during a 40-hour workweek. When a PEL is designated as a ceiling level (cPEL), the concentration cannot be exceeded during any part of the workday. PELs and cPELs are enforceable standards. The National Institute for Occupational Safety and Health (NIOSH) also publishes Immediately Dangerous to Life or Health (IDLH) concentrations for a variety of compounds. IDLH concentrations represent the maximum concentrations that one could escape within 30 minutes without symptoms of impairment or irreversible health effects. These values are not enforceable, but can be used as guidance for safety procedures. Table E.4 lists the PELs, cPELs, and IDLHs for mercury compounds and organo alkyls containing mercury.

In the event of a spill, the volatilization and the resultant mercury vapor concentration depends on air currents, temperature, surface area/dispersion of mercury droplets, and time. If a mercury spill is not cleaned up promptly, the levels in Table E.4 may be exceeded where mercury vapor collects (e.g., drained UV reactor). For example, in the lamp break described in Section E.2.2, these limits were exceeded within the reactor 24 hours after the reactor was drained. However, prompt response and proper cleanup procedures (e.g., ventilation and other measures described in Section E.2.4) should prevent exposure levels over these standards.

Table E.4. Health and Safety Standards for Mercury Compounds in Air

Compound	OSHA PEL (mg-Hg/m ³) ¹	OSHA cPEL (mg-Hg/m ³)	NIOSH IDLH (mg-Hg/m ³)
Mercury compounds	NR	0.1	10
Organo alkyls containing mercury	0.01	0.04	2

NR – not reported

¹ milligrams mercury per meter cubed

E.3.3 UV Lamp Disposal Regulations

UV lamps must be disposed of properly, as described in Section 6.3.2.6 and should be recycled. Some UV reactor and lamp manufacturers will accept spent or broken lamps for recycling or proper disposal (Dinkloh 2001, Leinberger 2002, Gump 2002). Alternatively, water systems should contact their state primacy agency or other local or state resource agencies for a list of local mercury recycling facilities.

E.3.4 Clean Water Act

Mercury discharges to water bodies in the United States are regulated under the Clean Water Act. Mercury-contaminated water from a lamp break should not be discharged to the environment through storm sewers or other means; discharges should be coordinated with the state and the local wastewater authority for proper treatment and disposal.

E.4 Mercury in UV Disinfection Facilities

Understanding the type of mercury and amount of mercury present in UV disinfection facilities can help determine the potential dispersion and transport of mercury through a WTP. However, the fate and transport of mercury after a lamp break has not been assessed by the drinking water industry.

E.4.1 Type of Mercury in UV Disinfection Facilities

Characterizing the form of mercury in an operating lamp is important because this form represents the starting point for mercury dispersion, speciation, and reaction chemistry in the water following a lamp break. Mercury in an LP or MP UV lamp is pure elemental mercury while LPHO lamps use a mercury amalgam, which typically is an alloy with indium.

Elemental mercury is usually a liquid at ambient temperature and pressure. However, given its vapor pressure (Table E.5), elemental mercury can vaporize at ambient temperatures. Other physical and chemical properties of elemental mercury that affect its fate and transport are given in Table E.5.

Table E.5. Physical and Chemical Properties of Elemental Mercury (Merck & Co., Inc. 1983)

Property ¹	Value
Density (g/mL ¹ at 25 °C)	13.534
Solubility (g/L ² at 25 °C)	0.06 ²
Vapor pressure (mm Hg at 25 °C)	0.002

¹ grams per milliliter; grams per liter

² Further information regarding mercury solubility in water can be found in Glew and Hames (1971).

In operating lamps, elemental mercury (from pure or amalgamated mercury) is vaporized in the presence of an inert gas. The concentration of mercury in the vapor phase is controlled predominantly by temperature. At typical LP and LPHO lamp operating temperatures, only a small portion of the liquid (pure) or solid (amalgam) mercury is vaporized. However, at typical MP lamp temperatures (600 to 900 °C; Table 2.1), mercury is present primarily in the vapor phase due to the high operating temperatures (Phillips 1983).

The relative proportion of mercury in the liquid/amalgam phase and in the vapor phase in an operating lamp may affect the fate of the mercury. (See Section E.5.) Liquid-phase elemental mercury is considerably denser than water (density = 13.5 g/mL; Table E.5).

As the UV lamp is operating, mercury-containing compounds can be formed on the internal lamp surface (Altena et al. 2001). After a break, these deposits may dissolve in water, releasing mercury into the water (Merck & Co. 1983).

Figure E.3 illustrates the expected forms of mercury in an operating lamp. Note that much of the elemental mercury will volatilize in an operating MP lamp and that amalgams are only used in LPHO lamps.

E.4.2 Amount of Mercury in UV Disinfection Facilities

The amount of mercury in a UV disinfection facility is site-specific and can be calculated using the amount of mercury per lamp, the number of lamps per reactor, and the number of reactors in the facility. This section contains information on the amount of mercury in UV lamps and uses this information in example calculations showing the amount of mercury contained in hypothetical UV facilities. This information is provided as an order of magnitude range of mercury levels that could be present in UV facilities.

Mercury content within lamps depends on type (LP, LPHO, or MP), length, and power rating. Although mercury content data are specific to manufacturer and lamp, longer lamps and lamps with higher pressures and power ratings typically contain more mercury. Table E.6 summarizes the quantities of elemental mercury added to lamps during manufacturing based on information provided by manufacturers and published literature values.

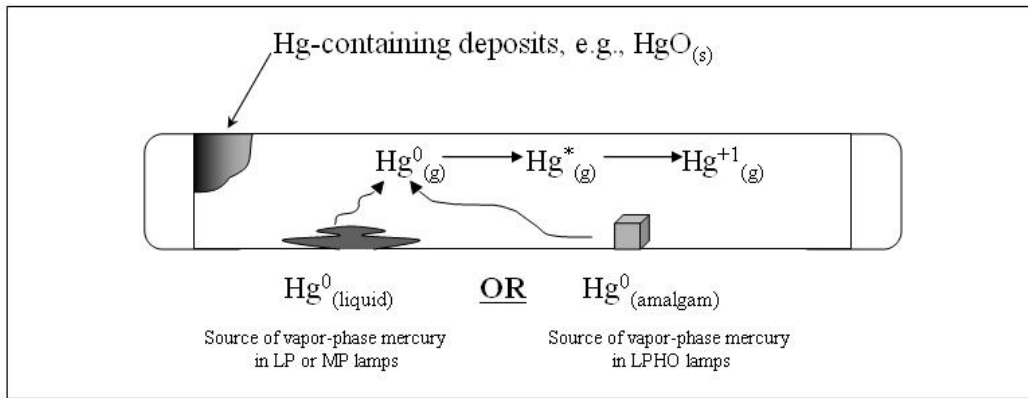
Figure E.3. Mercury Speciation in Operating UV Lamps**Table E.6. Elemental Mercury Content in UV Lamps**

Lamp Type	Electrical Power Rating [Watt (W)]	Mercury Content (mg per lamp)		
		Phillips (1983)	Clear and Berman (1994)	Manufacturer Survey
LP	15 – 70	“a single drop” ⁽¹⁾	20 ⁽²⁾	5 – 50
LPHO	120 – 260	NR	26, ⁽³⁾ 36 ⁽⁴⁾	150
	400	NR	75.5	NR
MP	1000	NR	250	NR
	1 – 25 kW	1.4 – 14.5 mg/cm ⁽⁵⁾	NR	200 – 400, 0.3 – 7.9 mg/cm length

¹ Phillips (1983)

² 75 – W mercury vapor lamp

³ 175 – W mercury vapor lamp

⁴ 250 – W mercury vapor lamp

⁵ milligram per centimeter (mg per cm) of lamp length, reported lamp lengths are 6 – 300 cm (Primarc Limited 2001)

NR – Not Reported

The amount of mercury in a UV facility can be estimated using the values in Table E.6 as a guide. In order to develop these estimates, two UV reactor manufacturers established design parameters for three treatment flowrates [0.18, 3.5, and 210 million gallons per day (mgd)] with a specified water quality and required UV dose and validation reduction equivalent dose (RED) target (Table E.7). Design parameters included the number of lamps needed to obtain an MS2 phage RED of 40 millijoule per centimeter squared (mJ/cm^2)¹ during validation testing and the total number of reactors for each of the three design flows. Calculations assume 50, 150, and 400 milligrams (mg) of mercury per LP, LPHO, and MP lamp, respectively. When determining the amount of mercury at a specific UV facility, water systems should contact the lamp manufacturer for updated information because mercury content varies with lamp type and manufacturer.

¹ Corresponds approximately to a 3 log *Cryptosporidium* inactivation (depending on validation testing and associated Validation Factor)

Table E.7. Mercury Quantity in Example UV Facilities^{1, 2}

Design Flow (mgd)	Average Flow (mgd)	Lamp Type	Average Number of Reactors	Average Number of Lamps (per reactor)	Total Hg in UV Facility ³ (g)
0.18	0.054	LP	1	2	0.1
		LPHO	1	1	0.2
		MP	1	1	0.4
3.5	1.4	LPHO	1	30	4.5
		MP	1	4	1.6
210	120	LPHO	6	72	64.8
		MP	6	7	16.8

¹ Target MS2 phage RED of 40 mJ/cm², which corresponds approximately to a 3 log *Cryptosporidium* inactivation (depending on validation testing and associated Validation Factor)

² Water quality criteria: Ultraviolet transmittance (UVT) = 89% ($A_{254} = 0.05 \text{ cm}^{-1}$), Turbidity = 0.1 nephelometric turbidity units (NTU), Alkalinity = 60 mg/L as CaCO₃, Hardness = 100 mg/L as CaCO₃

³ Values given represent the amount of elemental mercury added to lamps during manufacturing.

E.5 Documented Mercury Reactions in PWSs

Currently the fate of mercury following a lamp break has not been experimentally determined. This section describes documented mercury reactions in water systems.

Liquid elemental mercury and solid mercury amalgams have high densities (Table E.5) and will probably settle in areas of low water velocity, providing an opportunity for containment and removal. In prior cases when liquid mercury was released from water treatment equipment, such as manometers, flow instrumentation, or pump seals, mercury was found to have settled in the clearwell, but whether all of the released mercury was recovered is not known (Cotton 2002). Smaller particles from the vapor phase mercury may be transported farther or be more readily dissolved in water than liquid elemental mercury and solid mercury amalgams. However, in sampling following a recent on-line MP lamp break (described in Section E.2.2), mercury was not detected in any of the downstream sample locations, which could indicate that the mercury was contained by the UV reactor. The water system theorized that the remaining mercury was potentially attached to the UV reactor walls.

Liquid-phase elemental mercury does not readily dissolve in water. Kolch (2001) monitored the mercury concentrations in a 50-L batch reactor following the destruction of one LPHO lamp (containing approximately 150 mg Hg). Mercury concentrations reached approximately 2.5 µg/L in the batch reactor water, and amalgamated mercury was found settled on the bottom of the reactor (Dinkloh 2001). The low concentration of dissolved mercury in the water is likely an indication that little, if any, of the mercury amalgam dissolved into the water.

E.6 Summary and Conclusions

UV disinfection is an important disinfection technology that provides additional public health protection. To date, there have been few lamp breaks at existing UV facilities. The risk to human health and the environment from the mercury in UV lamps used in the treatment of drinking water is very small. Procedures and actions can be taken to reduce the chances of a lamp break and mitigate mercury release that UV lamp breaks cause. In addition, monitoring of mercury after known lamp breaks indicates that most of the mercury is contained, and concentrations in the water downstream of the UV reactor do not exceed the SDWA MCL. However, more research is needed to understand the fate of mercury in a drinking water environment following a UV lamp break and to evaluate the dispersion and transport of mercury through a WTP and distribution system.

Lamp breaks are divided into off-line and on-line breaks. Off-line lamp breaks typically occur during storage, handling, or maintenance and cause small spills. Small spills should be contained, cleaned up, and disposed of properly. Monitoring of mercury vapor concentration in the ambient air is important to protect personnel during the clean-up procedures.

On-line breaks occur when the lamp sleeve and lamp break while the UV reactor is in operation. Incidents have been reported of on-line UV lamp breaks associated with impact from debris, improper UV reactor orientation, loss of water flow, temperature differentials, faulty UV equipment design, procedural errors, and manufacturing defects. However, on-line lamp breaks are largely preventable with appropriate design, operation, maintenance, and operator care. The following engineering and administrative methods may help prevent UV lamp breaks:

- Screens, baffles, or low-velocity collection areas prior to the reactor influent to prevent entrance of debris
- UV reactor installation with lamps oriented parallel to the ground to reduce differential heating
- Temperature and flow sensors and alarms to detect critical conditions and to shut down the UV reactors and water flow
- Surge analysis to determine if water hammer may be a potential problem or whether pressure relief valves need to be installed
- Comprehensive operator training and UV equipment maintenance program
- Adequate circuit breakers/GFIs should be specified to prevent damage to the reactor.
- Operators and maintenance staff should perform routine inspection and maintenance according to manufacturers' recommendations.
- Designers should specify temperature ranges likely to be encountered during shipping, storage, and operation of lamps to aid the manufacturer in the selection of thermally compatible materials.

In the event of a mercury release, the following engineering controls are additional precautions that may aid in the containment and collection of mercury:

- Strainers and low velocity collection areas downstream of the reactor
- Isolation valves activated by an alarm to attempt to isolate potentially contaminated water

The extent of containment and prevention these measures provide is unknown. Water systems and designers should consider the applicability of these isolation techniques on a site-specific basis. Water systems should prepare a lamp break response plan in preparation for a potential UV lamp break and mercury release. This plan should address sampling and cleanup procedures as well as compliance with the SDWA, OSHA health and safety standards, and Clean Water Act. Water systems are encouraged to recycle or return all mercury-containing lamps to mercury re-generating facilities or the lamp manufacturer.

This page intentionally left blank.

Appendix F
Case Studies

This page intentionally left blank.

This appendix provides examples of how various utilities have implemented UV disinfection in their water systems. The UV facilities described in the following case studies were selected because they represent a broad range of UV facility conditions. They represent medium-pressure (MP) and low-pressure high-output (LPHO) reactor installations; on-site and off-site validation testing; installation on filtered water, unfiltered water, and an uncovered reservoir; and other varying goals and design issues.

The purpose of this appendix is to provide an overview of the manner in which UV disinfection has recently been implemented for drinking water disinfection in North America. The case studies describe issues and approaches used to implement UV disinfection technology. Specific step-by-step procedures for selecting design criteria and validation are not described. Rather, each case study provides a summary of the reasons for implementing UV disinfection, the design issues that were considered, and how implementation was approached. They are meant to be instructive as examples of how UV disinfection can be applied across a range of source waters, equipment types, and retrofit locations. It is important to follow the specific step-by-step guidance and examples provided in the previous sections of this manual to ensure that the final guidance is appropriately applied to any new installations.

The organization of each case study generally follows the organization of this manual. Each study provides introductory information about the water system and a discussion of the planning, design, validation, and operation and maintenance steps completed by each public water system (PWS). The first two case studies (Albany, New York and Weber Basin Water Conservancy District, Utah) feature in-depth descriptions, and the remaining three case studies contain briefer summaries of similar information.

When reading these case studies, it is important to recognize that these facilities were implemented before the Long Term 2 Enhanced Surface Water Treatment Rule (LT2ESWTR) and the guidance provided in this manual were finalized. Although drafts of this manual were available, some of the guidance has changed over time. In particular, the validation approaches and testing programs have changed since these projects were implemented.

Following are some of the highlights from each case study:

- Section F.1 – Albany, New York. MP reactors installed on an uncovered finished water reservoir that experiences bi-directional flow.
- Section F.2 – Weber Basin Water Conservancy District, Utah. LPHO reactors validated off-site at the Portland Validation Facility.
- Section F.3 – Clayton County Water Authority, Georgia. LPHO reactors in which challenge microorganism die-off problems were resolved to allow for on-site validation to proceed.
- Section F.4 – Newark, Ohio. MP reactors installed at a lime-softening facility on individual filter effluent pipes.
- Section F.5 – Winnipeg, Manitoba. MP reactors installed on an unfiltered source.

F.1 Albany, New York – MP Facility on a Finished Water Reservoir with On-site Validation

The City of Albany (City) owns and operates a 32-million gallons per day (mgd) conventional surface water treatment plant (WTP), serving over 100,000 people. The Feura Bush WTP operates at a relatively constant treatment rate (typically about 20 mgd). The Loudonville Reservoir, a finished water reservoir on the opposite side of the City, floats on the distribution system, filling and emptying throughout the day as distribution system demand fluctuates.

Loudonville Reservoir has two functions—distribution storage and emergency/backup supply. The reservoir is a 200-million gallon, uncovered, finished water storage facility, consisting of three basins. The reservoir has two inlets/outlets to the distribution system, and reservoir effluent water is automatically rechlorinated before delivery to the distribution system. In addition to rechlorinating the water as it re-enters the City’s distribution system, the City periodically batch chlorinates the reservoir to maintain water quality.

The City expanded its water quality enhancement program at the Loudonville Reservoir, which consisted of a series of water system improvements, including UV disinfection, being made under the direction of Albany’s Mayor Gerald Jennings to ensure that customers receive the best possible water quality at all times.

Early in the project planning phase, the City and its consultant determined that UV disinfection offers the most flexible and holistic solution for improving the reservoir water quality. UV disinfection provides the City with an additional disinfection barrier that is compact, relatively simple to operate, free from regulated disinfection byproducts (DBP), and effective against chlorine-resistant pathogens.

Few data were available on the water quality at the reservoir. Therefore, the reservoir water quality was assumed to be similar to the Feura Bush WTP finished water quality, which is summarized in Table F.1.

F.1.1 Planning

This section discusses key planning decisions made for Albany’s UV facility. Figure F.1 is a timeline of the process the City used to implement UV disinfection.

Table F.1. Summary of Feura Bush WTP Finished Water Quality (2000)

Parameter	Units	Average	Minimum	Maximum
UV Absorbance ⁽¹⁾	cm ⁻¹	0.03	0.011	0.054
UV Transmittance ⁽¹⁾	percent	93	88	98
Turbidity	NTU ⁽²⁾	0.23	0.12	0.54
pH	–	8.40	7.80	9.20
Alkalinity	mg/L ⁽³⁾ -CaCO ₃	40.9	35.7	48.3
Temperature	°C	10.4	1.1	20.0
Total Hardness	mg/L-CaCO ₃	54.2	50.0	58.0
Iron	mg/L	<0.03	<0.03	0.03
Manganese	mg/L	<0.03	<0.03	<0.03
Aluminum	mg/L	0.07	0.07	0.07
Specific Conductance	m-mhos/cm ⁽⁴⁾	176	148	211

¹ Data collected January 2001 – September 2001.

² nephelometric turbidity units

³ milligrams per liter

⁴ millimhos per centimeter

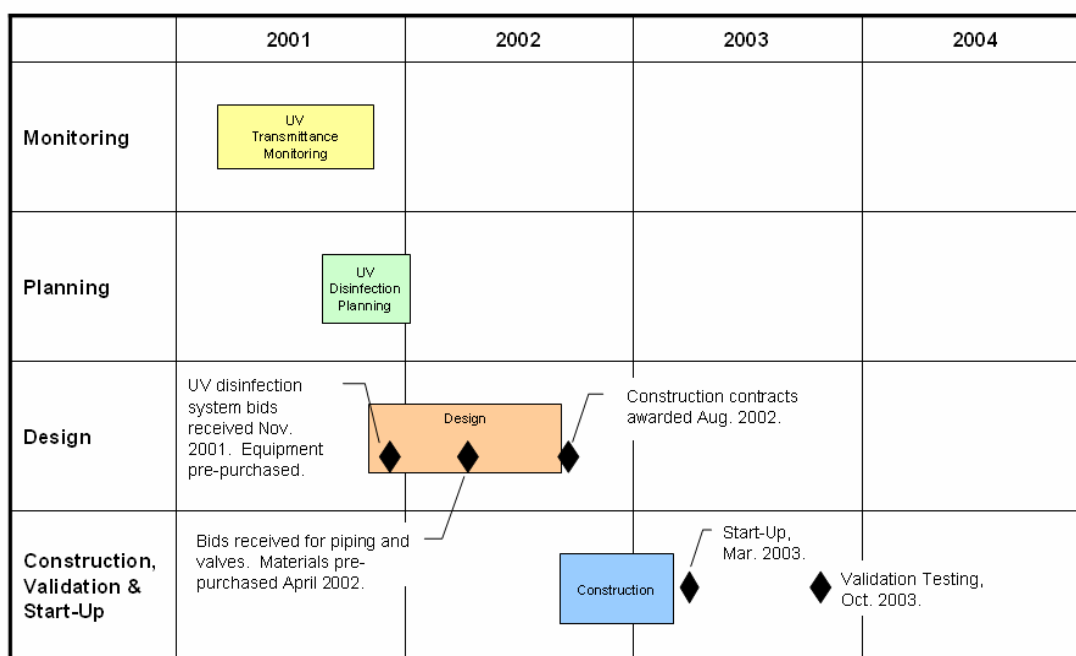
Figure F.1. Albany UV Implementation Timeline

F.1.1.1 UV Disinfection Goals

The City chose a multiple-barrier approach for disinfection at the reservoir, incorporating both UV disinfection and chlorination, to provide a greater level of protection. The City's UV

light and chlorine disinfection systems provide more effective inactivation of viruses and chlorine-resistant pathogens than the former chlorine-only system, while minimizing DBP formation. Additionally, the UV facility provides an additional level of protection to facilitate the City's compliance with the LT2ESWTR inactivation requirements for uncovered storage (Section 1.3.3).

F.1.1.2 UV Retrofit Location

The UV facility is located at the reservoir rather than at the WTP. Flow from each of the three reservoir basins is routed through the UV disinfection facility (Figure F.2) before it enters the City's distribution system.

Figure F.2. UV Retrofit Location at Loudonville Reservoir

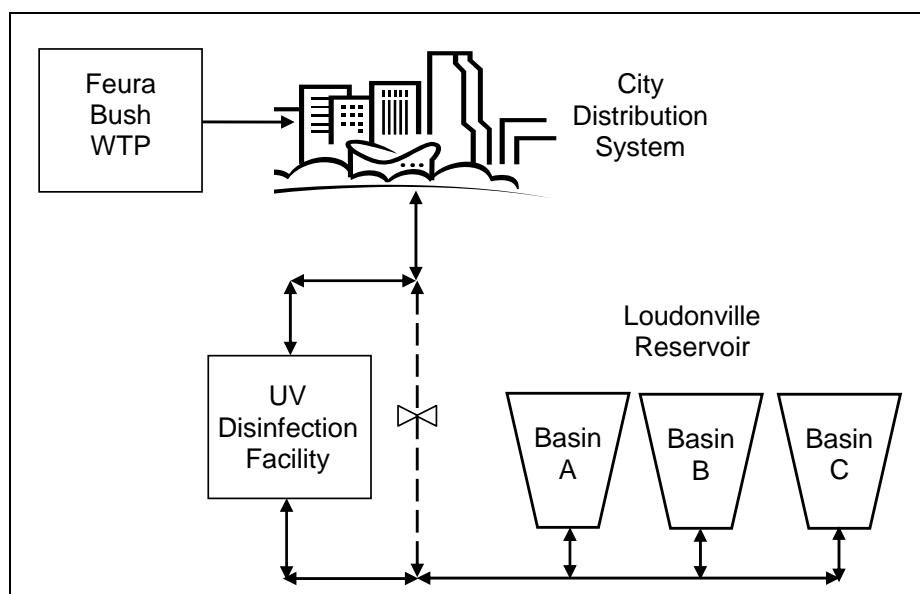

F.1.1.3 Key Design Parameters

Water quality, the fouling/aging factor, and flow rate are key parameters to be considered during the planning phase. Table F.2 summarizes key preliminary design parameters for the UV facility design.

Table F.2. UV Facility Preliminary Design Parameters

Criterion	Unit	Value
UV Transmittance	percent	88
Fouling/Aging Factor	percent	60
Peak Flow Rate	mgd	40

Water Quality

Several water quality parameters affect UV dose delivery and, therefore, UV equipment design (Table F.1). The most important is ultraviolet transmittance (UVT), which is calculated from A_{254} as described in Section 3.4.4.1. Reservoir UVT data were collected for approximately 3 months prior to design, but long-term UVT data were not available for the reservoir. The minimum UVT of 88 percent (A_{254} of 0.054) measured in the WTP finished water, therefore, was used to conservatively estimate UVT at the reservoir (Figures F.3 and F.4).

Figure F.3. UVT Data for Feura Bush WTP Finished Water

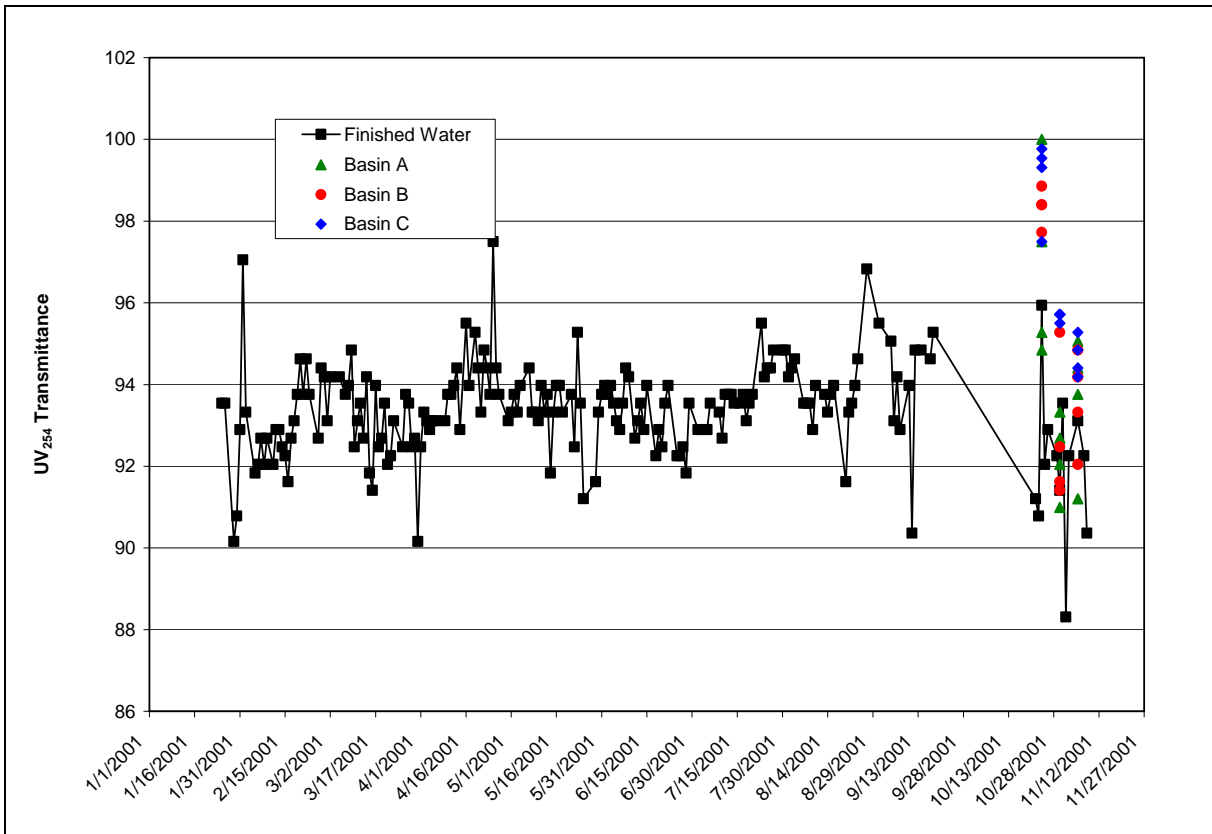

Fouling/Aging Factor

A fouling/aging factor of 0.6 was selected for Albany's UV equipment to be conservative. Because of the low hardness, iron, and manganese concentrations, fouling was not considered a significant issue. Nevertheless, the selected fouling/aging factor does reduce the necessary frequency of lamp replacement.

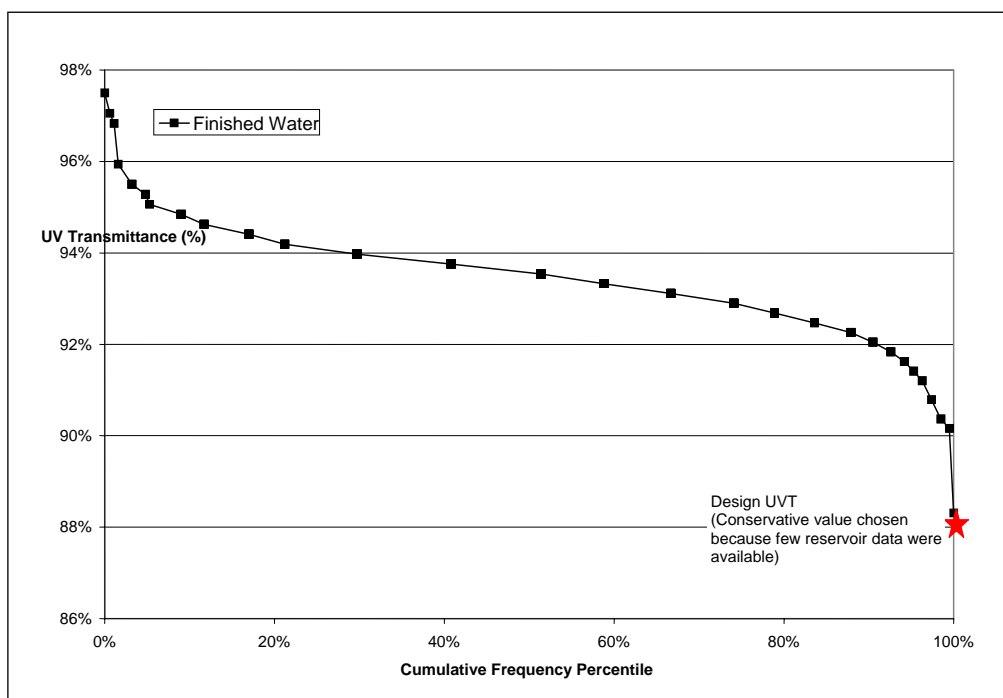
Figure F.4. Cumulative UVT Data for Feura Bush WTP Finished Water

¹ Note: 190 samples collected between January 2001 and November 2001.

Flow Rate

The UV facility was sized for 40 mgd (10 mgd per unit) for emergency or backup conditions when the reservoir and UV facility must be able to satisfy the entire system demand (30 mgd maximum). Under normal operating conditions, the UV facility maximum flow is 10 mgd.

Power Quality

The electric service provider for the proposed location of the UV facility was contacted regarding the availability and quality of power at the site. It was determined that high quality power was available, and power conditioning equipment was therefore unnecessary.

F.1.1.4 Equipment and Monitoring Strategy

Both MP and LPHO UV equipment were considered during the planning phase. MP UV equipment was selected for the design because of the smaller footprint and because, at that time, there was more experience with MP equipment in the United States. Another benefit of MP equipment was the use of the calculated dose-monitoring strategy, which allowed the City to address the anticipated variability in flow rate and direction.

F.1.1.5 UV Equipment Validation Options

The City of Albany chose on-site validation testing because no UV validation centers were operating in the United States at that time and because on-site testing would allow for:

- Testing under the exact piping configuration of the UV facility.
- Optimizing UV facility operations throughout the life of the facility.

Space requirements, injection and sample ports, and other elements required for on-site validation were coordinated with the UV equipment supplier and included in the UV facility design.

F.1.1.6 Hydraulics

No modifications to existing hydraulics were required for the UV facility at the reservoir. Installation of the UV facility did slightly reduce the full operating capacity of the reservoir. However, during an extended emergency condition, the UV facility can be bypassed to allow use of the entire reservoir volume.

F.1.1.7 Selected Configuration

The selected configuration of the UV equipment is summarized in Table F.3. The target male-specific-2 bacteriophage (MS2) reduction equivalent dose (RED) to be verified during validation was 40 millijoules per centimeter squared (mJ/cm^2) and was chosen to target high-level inactivation of various pathogens during emergency operation. The MS2 RED was based on best practices in North America and Europe at the time.

Table F.3. UV Equipment Configuration

Criterion	Unit	Value
UV Lamp Type	–	MP
Target MS2 RED	mJ/cm^2	40 ⁽¹⁾
Number of UV Units (Duty + Standby)	number	4 + 0 ⁽²⁾
Design Flow Rate per Unit	mgd	10
Number of Lamps per Unit	number	8
Lamp Power (Each)	$\text{kW}^{(3)}$	10

¹ 40 mJ/cm^2 is the target MS2 RED to be proven during validation testing and to be used when the reservoir is operating in its emergency mode. The target MS2 RED used during the normal distribution function of the reservoir is 240 mJ/cm^2 for virus inactivation.

² 40 mgd is needed for emergency and not normal operation; therefore, a standby unit was not provided.

³ kilowatt (kW)

F.1.2 Design

Given the wide range of UV equipment available, pre-purchase of the UV equipment by the owner was selected as the best way to proceed. Pre-purchase documents were issued in November 2001. Two suppliers bid on the UV equipment, and the contract was awarded to the low bidder, Trojan Technologies, Inc., in December 2001. By selecting the equipment early in the project, the project team was able to work closely with the manufacturer during the design of the system and support facilities (e.g., instrumentation and control) for the 24-inch UVSwift™ units. The following sections describe Albany's UV facility design.

F.1.2.1 Facility Hydraulics

Four parallel treatment trains of equal capacity (10 mgd) comprise the UV facility (Figure F.5). Water enters and exits the UV facility via 48-inch diameter influent and effluent manifolds. Each parallel treatment train consists of a 24-inch diameter lateral, influent and effluent modulating isolation valves, strap-on ultrasonic flow meter, and an MP UV unit. The UV units are installed in vertical piping to minimize the footprint of the UV facility and to promote settling of debris, if any, in the inlet piping to protect the lamps.

Figure F.5. UV Disinfection Facility at the Loudonville Reservoir



Although water hammer and surge conditions were determined to be minimal, a combination air/vacuum release valve was incorporated into each UV treatment train. The valves provide protection from adverse pressure conditions and facilitate the release of trapped air during start-up.

The UV facility was designed to handle large flow variations. The facility can treat typical daily flows with one or two 10-mgd units in service. With all four units in service, the

facility can also treat the City's full system demand during WTP or transmission main shut-downs or during an emergency condition.

The UV facility was also designed to handle bi-directional flow through the UV equipment because water passes through the UV units during both the reservoir fill and the draw cycles. The bi-directional flow design (described below) enables the City to maintain the UV facility in a constant state of readiness to deliver disinfected water to the distribution system whenever the reservoir switches to a draw cycle (i.e., when treated water is sent to customers).

Operation in Fill Mode

When WTP production exceeds distribution system demand, the reservoir fills (fill mode). All flow passes through the UV facility to the reservoir, and the UV equipment operates at minimum intensity because disinfection of the influent water is not needed. The primary objective of operating the UV facility during the fill mode is to ensure that the UV equipment is on and ready to provide adequate disinfection when the reservoir switches to draw mode.

Operation in Draw Mode

When distribution system demand is greater than WTP production, water drains from the reservoir to the distribution system (draw mode). Because a UV unit is always on, there is no time delay for disinfection of outgoing water when the flow direction changes.

F.1.2.2 Operational Strategy, Instrumentation and Control

The UV equipment was designed so that at least one UV train is in service at all times to ensure that a UV unit is ready to disinfect the reservoir water whenever flow into the distribution system occurs. When system demand matches the WTP production rate, however, very little flow into or out of the reservoir occurs. To prevent high lamp temperature (and automatic shut-down), a cooling water bypass line was installed downstream of the UV equipment and upstream of each isolation valve to allow a nominal flow through the unit [approximately 80 gallons per minute (gpm)]. The cooling water line is equipped with a motor-actuated valve for automatic opening when the water temperature exceeds a set value [90 degrees Fahrenheit (°F)] or when a start-up or shut-down signal is received. During start-up of a UV unit, the cooling water flow is discharged to waste. Following start-up, all flow enters the distribution system.

The UV equipment is controlled by a central programmable logic controller (PLC) using the calculated dose-monitoring strategy. The central PLC uses flow rate and direction data from each of the four treatment trains to control the overall operation of the UV equipment and to sequence the operation of individual UV units. Input for controlling the UV equipment is provided by a strap-on flow meter on each UV treatment train, two on-line UVT analyzers in the piping header, and eight UV sensors in each UV unit. The individual control panel for each UV unit adjusts the lamp power and calculated dose of each UV unit in response to the flow rate, UVT, and UV intensity, to ensure an appropriate level of disinfection.

As the distribution system demand increases, the central PLC initiates start-up of the next UV unit once the flow rate through the first unit reaches a manually entered percentage of its rated capacity. After the second unit has warmed up (approximately 5 minutes), the central PLC

opens the modulating valve for that train and brings the unit on-line. Flow is then split between the two active UV trains. This scenario continues with the other two UV units as necessary based upon distribution system demand.

F.1.2.3 Electrical Power Configuration

Power quality was not expected to be an issue at the reservoir. Therefore, power conditioning equipment for the UV equipment was not necessary. An uninterruptible power supply (UPS) was included for the UV control panel to convey alarms and other critical UV facility information. A backup diesel generator, capable of providing backup power for all elements of the UV facility, and an automatic transfer switch were also included in the design. Because the UV equipment is not on a UPS, a brief interruption of the UV disinfection occurs when the UV facility switches to the backup generator. Disinfection is reinitiated once backup power is active and the UV lamps have restarted. To minimize the number of power transfers and resulting UV lamp power interruptions, retransfer of the facility back to grid power is done manually to allow an operator to determine when conditions are appropriate for a transfer back to grid power (e.g., when the reservoir is inflowing).

F.1.2.4 Capital Costs

Bids were received upon completion of the final design, and the construction contract was awarded. The approximate cost of the UV facility at the time of construction was \$3,125,000, which, when adjusted to 2006 dollars (ENR BCI = 4356), equates to approximately \$3,805,000. Major cost components (in 2006 dollars) included:

- \$680,000 for the UV equipment
- \$2,410,000 for a new UV building and yard piping
- \$360,000 for ancillary piping, valves, and controls
- \$355,000 for electrical.

F.1.3 Validation

On-site validation of the UV equipment was completed in October 2003, which was prior to the promulgation of the LT2ESWTR. The validation was based on a previous draft of this guidance document. Because the guidance has changed, any new installations should follow the validation protocol described previously in this manual and not follow the example given in this section.

Two validation tests were performed at this facility. Contract validation testing was conducted to confirm that the equipment met the design criteria specified in the UV equipment procurement document. Expanded validation testing was also conducted to assess whether energy efficiency could be improved by modifying the lamp operating strategies and UV facility maintenance. The expanded validation testing was co-funded by the City of Albany and the New York State Energy Research and Development Authority (NYSERDA).

Trojan Technologies, Inc. conducted the validation testing with Dr. James Malley, Jr. (University of New Hampshire, Durham) providing third-party oversight for the contract validation testing. Christine Cotton of Malcolm Pirnie, Inc., provided third-party oversight for the NYSERDA validation testing.

F.1.3.1 Contract Validation Conditions

The validation testing procedures were based on the UV Disinfection Guidance Manual (UVDGM) Proposal Draft (USEPA 2003). The validation testing procedures in this manual and the protocol followed for Albany's on-site validation testing did not significantly differ. However, the data analysis and Validation Factor calculations do differ from those in this manual.

The validation testing was conducted at the reservoir. The challenge microorganism used in the testing was MS2 phage. Dissolved instant coffee, a UV absorber, was used to adjust the UV transmittance to the desired test conditions. There was no residual chlorine in the water; therefore, the water did not need to be dechlorinated.

Following is a summary of the range of validation conditions:

- Lamps were operated at 0 percent (off), 60 percent (to account for lamp aging and fouling effects), or 100 percent (full power) of their nominal output during the validation testing.
- Flow rates ranged from 2.0 – 10.3 mgd.
- UVT ranged from 88 – 99 percent.
- Target MS2 RED values ranged from 0 to 150 mJ/cm².

The test conditions and results for the validation tests are summarized in Table F.4. The UV equipment passed the contract validation testing.

F.1.3.2 NYSERDA Validation Conditions

The validation testing procedures used in the NYSERDA validation testing were the same as in the contract validation testing. The NYSERDA testing conditions follow:

- Four or six (of eight possible) lamps in the unit were energized.
- Lamps were operated at 0 percent, 60 percent, 80 percent, or 100 percent of their nominal output.
- Flow rates ranged from 2.0 – 10.0 mgd.
- UVT ranged from 87 – 100 percent.
- Target MS2 RED values ranged from 0 – 150 mJ/cm².

Table F.4. Validation Testing Conditions and Results for Contract Validation

Run No.	Flow (mgd)	Configuration	UVT Modifier	Test Organism	Lamp Power (%)	UVT (%)	Influent MS2 ⁽¹⁾ (log PFU/mL ⁽²⁾)	Effluent MS2 ¹ (log PFU/mL)	Log Reduction	MS2 RED (mJ/cm ²)
1	9.8	8 lamps on	None	None	0	98.5	0	3.15	0.00	0
2	9.7	8 lamps on	None	MS2	0	98.3	6.16	6.25	-0.09	-9.4
3	9.9	8 lamps on	None	MS2	100	98.5	6.14	0	6.14	150.3
4	9.8	8 lamps on	None	MS2	60	98.6	6.08	0	6.08	148.7
5	9.7	8 lamps on	Coffee	MS2	60	87.4	6.19	4.37	1.82	39.4
6	9.9	8 lamps on	Coffee	MS2	100	87.5	6.21	3.28	2.93	68.0
7	5.0	8 lamps on	None	MS2	60	98.5	5.78	0	5.78	141.0
8	4.9	8 lamps on	Coffee	MS2	60	87.8	5.66	3.10	2.56	58.4
9	2.0	8 lamps on	None	MS2	60	98.1	5.83	0.37	5.44	132.5
10	2.0	8 lamps on	Coffee	MS2	60	88.0	5.79	1.11	4.68	112.7
11	10.3	8 lamps on	None	None	0	98.6	0	2.99	0.00	0

¹ The value shown represents the average of three replicate samples.

² plaque forming units per milliliter

The collimated beam dose-response results for an example day of testing (Day 1) are shown in Figure F.6.

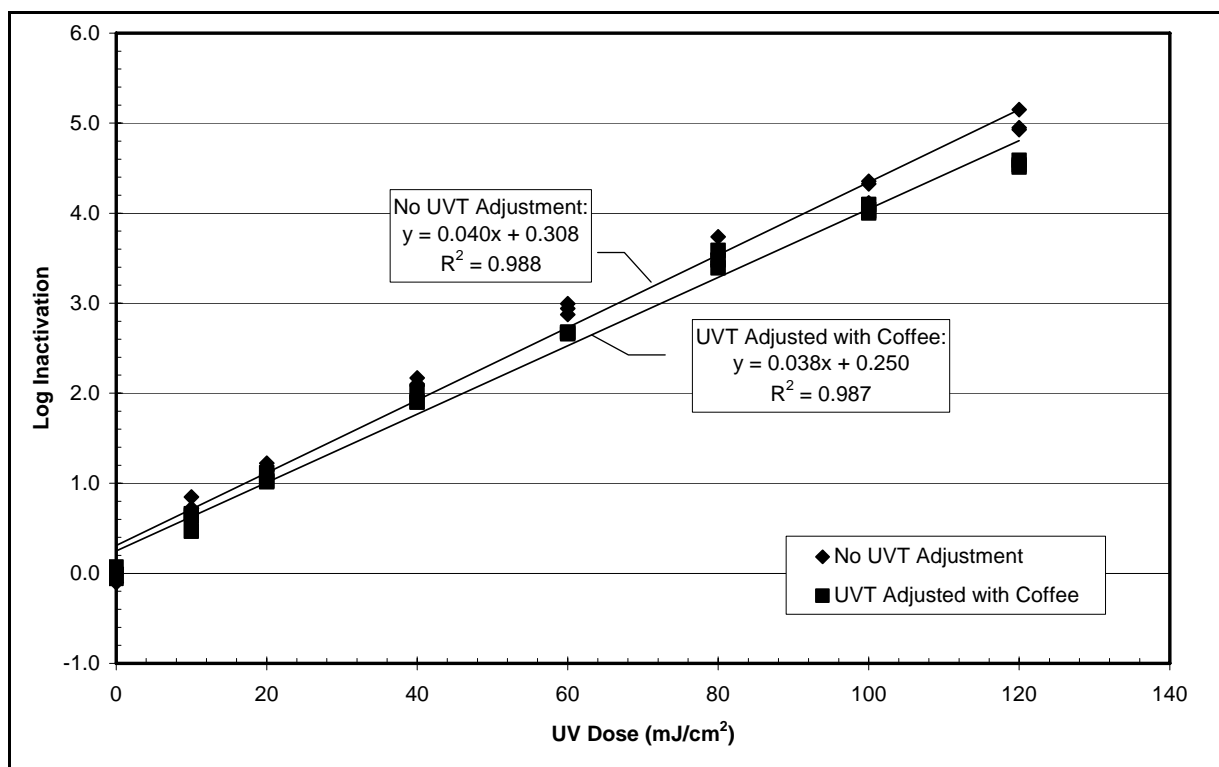
Figure F.6. Collimated Beam UV Dose-response Curve

The test conditions and results for the validation tests are summarized in Table F.5. The implications of the NYSERDA validation testing results on operation and maintenance (O&M) are described in Section F.1.3.4. Additional validation data analysis may be completed in the future to determine the validation factor and validated dose in accordance with the validation data analyses described in this manual (Chapter 5).

Table F.5. Validation Testing Conditions and Results for NYSERDA Validation

Run No.	Flow (mgd)	Configuration	UVT Modifier	Test Organism	Lamp Power (%)	UVT (%)	Influent MS2 ¹ (log PFU/mL)	Effluent MS2 ¹ (log PFU/mL)	Log Reduction	MS2 RED (mJ/cm ²)
1	10.0	6 lamps on	None	None	0	99.0	0	0	0.00	0.00
2	9.9	6 lamps on	None	MS2	0	99.2	6.25	6.18	0.06	-4.7
3	9.9	6 lamps on	None	MS2	60	99.1	5.85	0.30	5.59	140.8
4	9.9	6 lamps on	Coffee	MS2	80	87.5	5.98	3.93	2.04	47.4
5	2.0	6 lamps on	Coffee	MS2	60	87.2	6.55	2.40	4.12	102.1
6	2.0	4 lamps on	Coffee	MS2	60	87.4	6.34	3.89	2.45	58.1
7	10.1	4 lamps on	None	MS2	80	99.0	5.83	0.37	5.83	147.1
8	10.0	4 lamps on	Coffee	None	100	88.7	0	0.60 ²	0.00	0.00
9	10.0	4 lamps on	None	None	0	99.9	0	2.75 ²	0.00	0.00

¹ The value shown represents the average of three replicate samples.

² Test microorganisms injected in prior tests had pooled in a deadspace upstream of the UV reactor and later bled back into the main flow stream.

F.1.3.3 Issues Encountered During Validation Testing

During validation testing, the following issues were encountered:

- Ultrasonic flow meter uncertainty.** Before the start of the contract validation testing, a discrepancy between a flow meter installed on the UV unit to be tested and an existing flow meter farther downstream was noted. The meter manufacturer was contacted, and a representative was sent to the site. A portable strap-on flow meter was installed next to the test unit flow meter; the portable meter was consistent with the test unit meter. The downstream flow meter was determined to be in error, having been set to the diameter of the casing pipe and not the diameter of the internal carrier pipe. Upon resolution of the investigation, the validation testing continued using the test unit flow meter to measure the flow rate.
- Test organism not injected.** In the test plan, Run No. 8 of the NYSERDA validation testing should have had organisms injected. However, during the testing, no organisms were injected. Instead of re-doing the testing, Run No. 8 was used as an additional control.

F.1.3.4 Validation Implications for Operation and Maintenance

The NYSERDA validation testing results indicated that the UV equipment can achieve (and exceed) the 40 mJ/cm² target MS2 RED when operating in a power saving mode with only 4 or 6 (of a possible 8) lamps on and with UVT between 87 and 99 percent. When the data were analyzed in accordance with the UVDGM Proposal Draft (USEPA 2003) guidelines that were available at the time, the testing indicated that 3-log *Cryptosporidium* inactivation and 1.5-log virus inactivation, if desired, could be achieved under expanded lamp control conditions. Validation of the alternative lamp operating configuration is expected to result in cost savings from reduced power usage.

F.1.4 Start-up and Operation of the UV Facility

Construction of the facility was completed in February 2003. Full-scale operation began in March 2003.

F.1.4.1 Start-up and Construction Issues

Although some problems occurred upon initial start-up of the UV equipment, all parties involved worked to resolve the issues to the City's satisfaction. The problems and resolutions are briefly discussed below:

- **Control system.** The manufacturer's control system does not calculate the UV dose correctly during the "fill mode" conditions. Because flow is bi-directional in the inlet/outlet pipe, a negative value for flow was used in the fill condition (a positive value for the "draw mode"). It could be corrected by changing the programming to use an absolute value of the flow input in the calculation.
- **UVT analyzers.** The on-line UVT analyzers initially reported inconsistent readings. Samples were taken at the midpoint and top of the pipe. The samples taken at the top of the pipe were found to be occasionally erroneous due to air bubbles in the sample. To correct the problem, the sample ports for the on-line UVT analyzers were adjusted so that all samples were taken from the midpoint of the pipe.
- **Cleaning system.** The wiper cleaning mechanism originally provided with the UV equipment frequently jammed due to grit entering and binding the threads of a wiper system rod. The UV manufacturer refined the design and provided a replacement wiper drive system with a self-cleaning traversing nut and a rod with a larger thread pitch and depth.
- **Intensity sensors.** In several instances, the coating on the intensity sensors degraded. The UV manufacturer improved the design and provided new UV sensors for the UV reactors. The new sensors were provided prior to validation testing, so re-validation was not necessary.

- **UV lamp failure.** At start-up, approximately thirty percent of the lamps failed to energize. A similar percentage also failed to start in a second shipment of lamps. The UV manufacturer tracked the problem to a batch of lamps with manufacturing defects. The manufacturer corrected the problem and installed a new batch of lamps.

F.1.4.2 Operation and Maintenance

The following operational tasks are regularly performed at Albany's UV facility. These tasks take approximately one hour per day, seven days per week.

- Daily overall visual inspection of the UV equipment.
- Daily check of the control system to ensure it is in automatic mode.
- Daily check of the control panel display for status of UV equipment components and alarms.
- Daily check of on-line analyzers, flow meters, and data recording equipment.
- Daily review of 24-hour monitoring data to ensure that the equipment has been operating properly.
- Daily check of cleaning mechanism operation.
- Daily check of lamp run time.
- Daily check of ballast cooling fans for unusual noise.
- Weekly check of valve operation.

The City of Albany also performs regular maintenance tasks at the UV facility. Due to budget cut-backs, the original maintenance frequencies for several tasks have been reduced. The current scheduled maintenance tasks include the following:

- Monthly calibration check of UV sensors.
- As-needed calibration check of UVT analyzers. Due to the sensitivity of these analyzers and re-calibration difficulties described in Section F.1.4.3, the calibration of these analyzers is checked only when problems are evident (every few months). The calibration was formerly checked weekly.
- Quarterly to annual check of equipment housing, sleeves, and wiper seals for leaks.
- As-needed replacement of the duty sensor with a calibrated back-up sensor. To date, replacement has been unnecessary.

- Annual check of the cleaning system efficiency by inspecting and manually cleaning the sleeves. This maintenance was previously performed quarterly.
- Quarterly check of the cleaning fluid reservoir.
- Annual calibration of the reference sensor by the manufacturer.
- As-needed replacement of lamps that have broken or are at the end of their lamp life (currently replaced after 4,000 hours). Approximately 20 lamps have been replaced in the first 2 years of operation.
- As-needed replacement of sleeves that have broken or fouled. To date, approximately 3 sleeves have been broken and replaced.
- As-needed cleaning of UVT analyzers.
- As-needed inspection of cleaning system drive mechanism.
- As-needed inspection of ballast cooling fan.

Performance of these tasks is currently estimated to take approximately two hours per week per unit (8 hours per week total). An additional 8 hours per month is spent on troubleshooting. Before the cut-backs, performance of these tasks at the recommended frequency (Sections 6.3.1 and 6.4.1.4) took an estimated eight hours per week per unit (32 hours per week total).

F.1.4.3 Operational Challenges

Although the City generally has found the facility to be relatively simple to operate, a few challenging conditions have been encountered:

- **UVT analyzers.** Due to the very high UVT of the water (typically 95 percent), the City's maintenance personnel have difficulty calibrating the UVT analyzers.
- **Wiping collar maintenance.** The City's maintenance personnel have had problems re-aligning the cleaning system's wiper collars on the sleeves when the collars have been completely removed from the equipment for maintenance. Difficulties with this maintenance task have resulted in several broken sleeves.
- **UV equipment draining.** Inadequately sized drains in the UV unit delay maintenance because of the excessive time needed to drain water.

F.1.5 Future UV Facility Plans

Because very few data were available on the water quality at the reservoir, a conservative UVT of 88 percent was selected for the design of the UV equipment. However, full-scale operating data indicate that the UVT of the water at the reservoir is actually much greater

(approximately 95 percent), which enables the City of Albany to target virus inactivation with its UV facility over a larger range of flow rates when the reservoir is functioning as distribution storage. Albany's validation data indicate that the facility can achieve 1.5-log virus inactivation and could likely be validated for greater virus inactivation if an appropriate challenge organism can be identified. Therefore, credit for greater than 1.5-log virus inactivation may be sought in the future.

F.2 Weber Basin Water Conservancy District – LPHO Facility with Off-site Validation

The Weber Basin Water Conservancy District (District) was established in 1950 to provide for the conservation and development of the water resources within the District boundaries and to use these resources to the greatest benefit of the public. The District is currently a drinking water wholesaler, serving a total population of approximately 400,000 people.

The District's Weber WTP No. 3 is a 46-mgd conventional WTP with settled water ozonation for taste and odor control and UV light for enhanced disinfection (Figure F.7). The plant was expanded to its present capacity and other improvements were made in 2001.

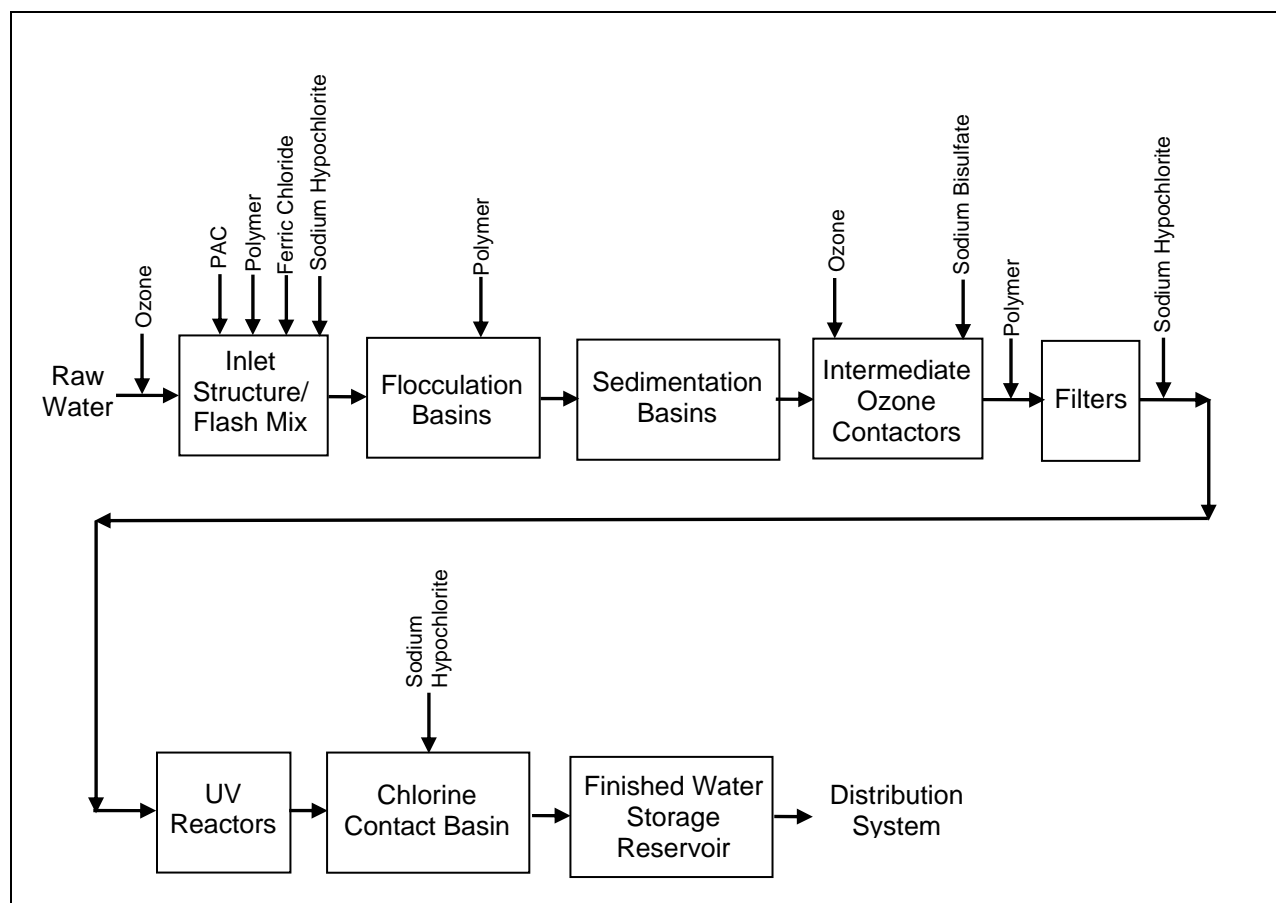
Figure F.7. Weber WTP No. 3 Process Flow Diagram

The primary raw water supply for the Weber WTP No. 3 is the Weber River, delivered through the Davis Aqueduct to the plant. Miscellaneous side creeks can also be used by the District to supplement irrigation water or for a raw water supply for the Weber WTP No. 3. The creeks are diverted directly to the plant intake without any upstream storage. There are no independent water quality data on these two supplies.

The raw water quality at the Weber WTP No. 3 can vary significantly throughout the year. Storm events and spring run-off can increase turbidity rapidly. Algal blooms cause taste and odor problems, especially in the late summer and fall. Raw water quality data for 1996 to 1998 is summarized in Table F.6, and Table F.7 summarizes Weber WTP No. 3 filtered water quality.

Table F.6. Summary of Raw Water Quality (1996 – 1998)

Parameter	Units	Average	Minimum	Maximum
Turbidity	NTU	29.2	0.3	3,800
pH	-	7.5	6.6	8.5
Alkalinity	mg/L as CaCO ₃	177	58	268
Temperature	°C	10.4	2.0	19.6
Total Hardness	mg/L as CaCO ₃	215	142	264
Calcium Hardness	mg/L as CaCO ₃	N/A	N/A	N/A
Iron	mg/L	N/A	N/A	N/A
Manganese	mg/L	N/A	N/A	N/A
Total Organic Carbon	mg/L	3.2 ⁽¹⁾	1.1	7.6

¹ Data collected at Weber WTP No. 3.

Table F.7. Summary of Filtered Water Quality (2002 – 2004)

Parameter	Units	Average
Turbidity	NTU	< 0.15
pH	-	7.40
Alkalinity	mg/L-CaCO ₃	180
Temperature	°C	10.7
Total Hardness	mg/L-CaCO ₃	225
Calcium Hardness	mg/L-CaCO ₃	N/A
Iron	mg/L	< 0.02
Manganese	mg/L	Below detection limit
Total Organic Carbon	mg/L	< 3

F.2.1 Planning

This section discusses key planning decisions made for Weber Basin's UV facility. Figure F.8 is a timeline of the process the District used to implement UV disinfection.

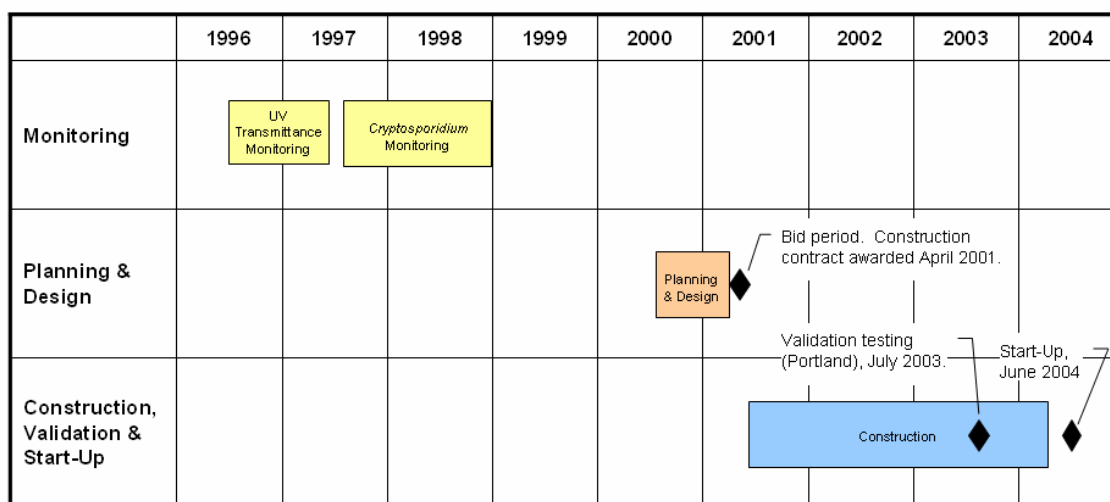
Figure F.8. Weber WTP No. 3 UV Implementation Timeline

F.2.1.1 UV Disinfection Goals

Raw water monitoring by the District indicated that the water system could be classified as a Bin 2 or Bin 3 system under the LT2ESWTR. (See Section 1.3.1.) For the purposes of the preliminary design, it was assumed that the water system could either initially or ultimately be classified as a Bin 3 system, which would require the UV facility to provide 2.0-log additional *Cryptosporidium* inactivation.

As part of the preliminary design process for the UV facility and other plant improvements, the District reevaluated its *Giardia* treatment. Before the 2001 improvements, the Weber WTP No. 3 used free chlorine for disinfection of *Giardia* and viruses. Following the 2001 improvements, the finished water reservoirs had sufficient capacity to continue to provide the required level of *Giardia* and virus inactivation. However, the use of free chlorine for 3-log *Giardia* inactivation in the finished water reservoirs was discontinued for the following reasons:

- The UV reactors could easily be designed for both *Giardia* and *Cryptosporidium* inactivation.
- Incorporating *Giardia* disinfection with the proposed *Cryptosporidium* disinfection process would make a significant portion of the existing finished water reservoirs available for operational storage to benefit the distribution system.

Table F.8 summarizes the treatment goals for the Weber WTP No. 3.

F.2.1.2 UV Retrofit Location

Because of existing hydraulic constraints, the UV reactors could be installed only downstream of the filters (see Figure F.7).

Table F.8. Disinfection Goals

Process	<i>Cryptosporidium</i>	<i>Giardia</i>	Virus
Filters	3.5 ⁽¹⁾	2.5	2.0
UV Light	2.0	2.0	–
Chlorine	–	1.0	4.0
Total Provided	5.5	5.5	6.0

¹ Combined filter effluent turbidity 0.15 NTU in 95 percent of samples each month to provide a second barrier.

F.2.1.3 Key Design Parameters

Water quality, fouling/aging factor, and flow rate are critical parameters to be considered during the planning phase. Table F.9 summarizes key preliminary design parameters for the UV reactor design.

Table F.9. UV Facility Preliminary Design Parameters

Criterion	Unit	Value
UV Transmittance	percent	90
Fouling/Aging Factor	percent	67
Flow Rate	mgd	15.3

Water Quality

Several water quality parameters affect UV dose delivery and, therefore, UV reactor design. (See Table F.7.) The most important is UVT, which is calculated from the UV absorbance at 254 nm (A_{254}) as described in Section 3.4.4.1. Based on the available UV absorbance data, a design UVT of 90 percent (A_{254} of 0.046 cm^{-1}) was selected (Figures F.9 and F.10).

Fouling/Aging Factor

A fouling/aging factor of 67 percent was selected during planning. The factor was incorporated into the design to account for the reduction in lamp output at the end of lamp life and the reduction in lamp output due to irreversible sleeve fouling.

Flow Rate

The UV facility capacity was designed to match the 46-mgd WTP capacity with three units in operation and one unit out of service. Therefore, the design flow rate through each reactor was 15.3 mgd.

Power Quality

To ensure operation of the UV equipment, standby power was provided with a new backup generator. No other power conditioning equipment was needed.

Figure F.9. UVT Data for Weber WTP No. 3 Finished Water

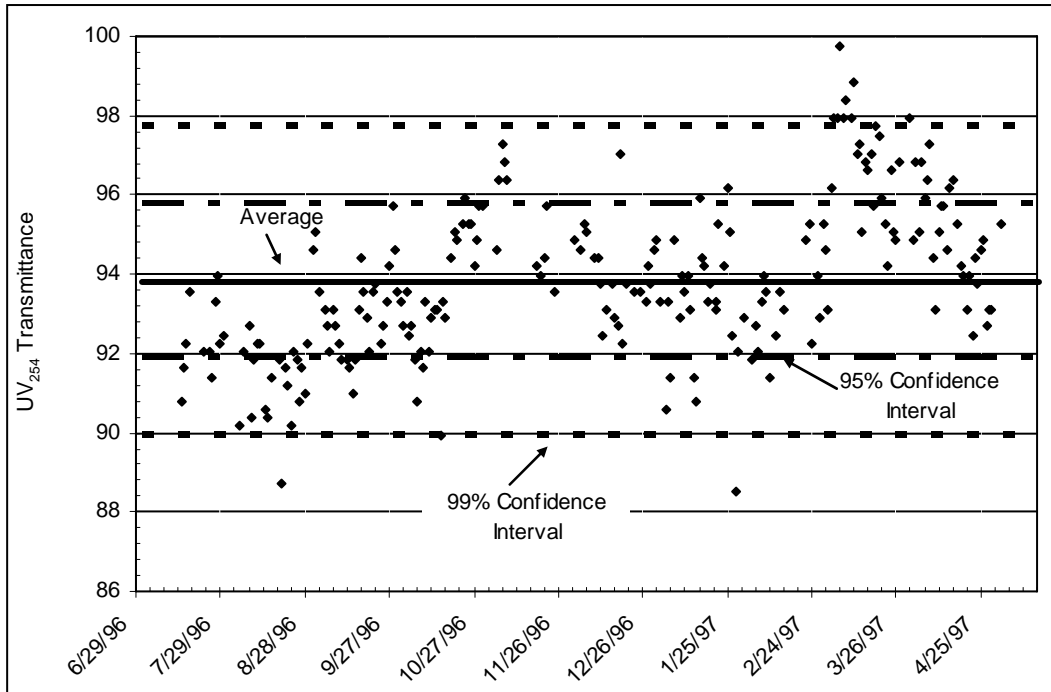
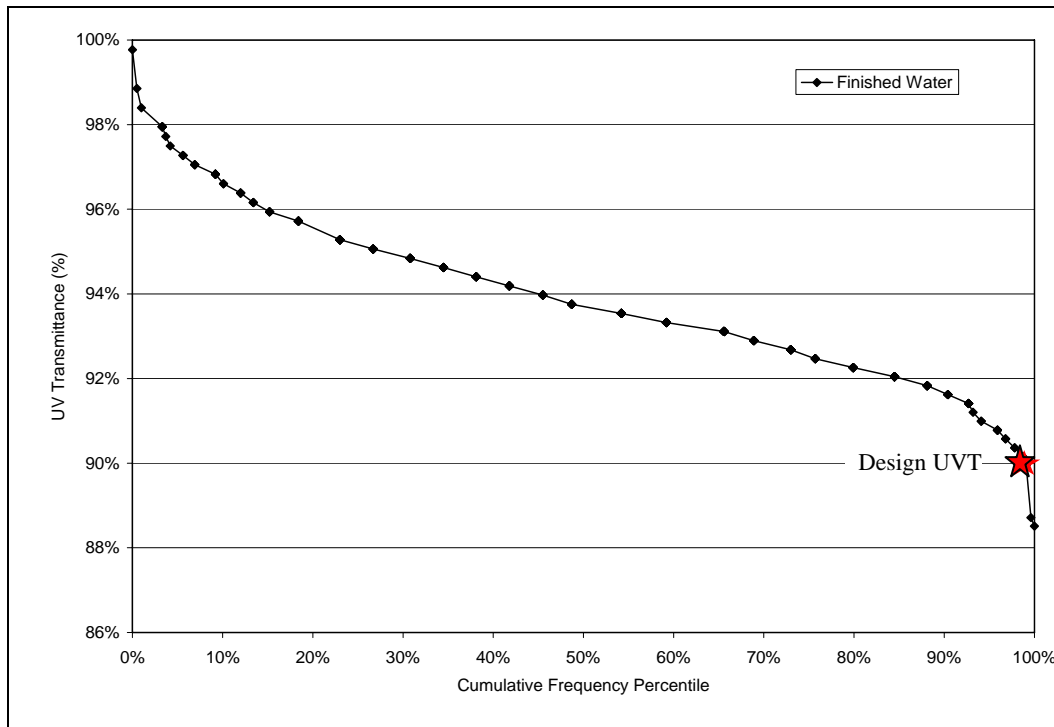

Figure F.10. Cumulative UVT Data for Weber WTP No. 3 Finished Water



F.2.1.4 Equipment and Monitoring Strategy

Because both MP and LPHO reactors were considered for the design, the footprint for the larger LPHO reactors was used for planning. The District selected variable setpoint operation based on flow rate for the UV equipment to conserve power.

F.2.1.5 UV Reactor Validation Options

Off-site validation was selected for the following reasons:

- Discharge of validation test water from on-site validation testing was not feasible.
- At the time, UV disinfection was an innovative process without references for potable water applications in the United States. Therefore, off-site validation prior to delivery was deemed a reasonable validation option.

F.2.1.6 Hydraulics

Changes to the plant's hydraulic profile were made as part of the overall plant expansion and improvements in 2001. The UV reactors fit into the plant's new hydraulic profile at the combined filter effluent without need for additional modifications or intermediate pumping.

F.2.1.7 Selected Configuration

Only UV reactor manufacturers that had validated a reactor were considered for the design, but pre-validation of the proposed UV reactor was not required. A bid specification was written before design of the UV facility. The base bid was for LPHO reactors with alternate bids allowed for MP reactors. Although the UV equipment was not pre-purchased, bids were evaluated, and the detailed design was based on the selected manufacturer (WEDECO Inc.). The selected configuration of the UV reactors is summarized in Table F.10. The target MS2 RED to be verified in validation was selected to target high-level inactivation of various pathogens based on best practices in North America and Europe at the time. The selected configuration has one sensor for every bank of lamps and has one UVT analyzer.

Table F.10. UV Reactor Configuration

Criterion	Unit	Value
UV Lamp Type	–	LPHO
MS2 RED ¹	mJ/cm ²	40
Number of UV Units (Duty + Standby)	number	3 + 1
Design Flow Rate per Unit	mgd	15.3
Number of Banks per Unit	number	6
Number of Lamps per Bank	number	12
Lamp Power (Each)	W	360

¹ The MS2 RED to be proven during validation testing.

F.2.2 Design

The following sections describe the UV facility design in more detail.

F.2.2.1 Facility Hydraulics

The UV reactors were installed on the combined filter effluent to fit into the plant's hydraulic profile. Filtered water from a common header is passively divided into four 30-inch influent pipes to the UV reactors. To compensate for a possible uneven flow split, upstream isolation valves can be manually throttled. The head loss through the UV reactors, ancillary piping, and valves is 2.3 feet of water at maximum plant capacity (46 mgd). Effluent weirs are installed to ensure that the reactors remain submerged.

F.2.2.2 Operational Strategy, Instrumentation and Control

The UV supplier provided a variable setpoint control strategy based on a UV Intensity Setpoint Approach. In this approach, the minimum UV intensity values determined during validation can be set for several flow rate ranges. The UV ballast system has 50 to 100 percent variable power capabilities, allowing the UV reactor to automatically adjust based on relative sensor intensity and flow rate to conserve power (see section F.2.3.1 for details). For the UV reactor to stay in compliance (i.e., to ensure minimum UV dose delivery), the UVT must remain at or above the minimum value (90 percent), the flow rate through the reactor must be less than or equal to the maximum validated flow rate, and the UV sensor values must all be at or above the UV intensity setpoint for that flow rate and number of lamp banks on as determined by the validation data (See Section F.2.3.).

Flow meters and flow control valves were not provided for each reactor. However, each reactor was provided with UV sensors. Additionally, a motorized valve downstream of each reactor remains closed during start-up until the reactor is on and warmed up. Therefore, off-specification water is not delivered to consumers and does not need to be wasted during reactor start-up.

F.2.2.3 Electrical Power Configuration

An electrical engineer reviewed power fluctuations and quality at the WTP and determined that power conditioning equipment was not needed. However, standby power was provided with a new backup generator to ensure continuous UV equipment operation.

F.2.2.4 Capital Costs

The UV facility construction was part of a larger expansion and improvement project. The portion of the construction cost attributed to the UV facility was \$2,230,000 in 2006 (ENR BCI = 4356) dollars. Major cost components included:

- \$1,210,000 for the UV equipment.

- \$400,000 for a new UV building.
- \$250,000 for ancillary piping, valves, and controls.
- \$370,000 for electrical improvements.

F.2.3 Validation

Off-site validation testing was originally conducted at the Deutsche Vereinigung des Gas- und Wasserfaches (DVGW) facility in Germany. However, validation testing at the DVGW facility proved problematic because the strict DVGW requirements do not allow flexibility in validation or operation setpoints. As such, further validation testing at the Portland Validation Facility was conducted in July 2003. The second validation was in accordance with the U.S. guidelines based on the UVDGM Proposal Draft (USEPA 2003).

The Portland Validation Facility is located at the City of Portland, Oregon Bureau of Water's Groundwater Pumping Station of the Columbia Southshore Wellfield, Portland, Oregon. The Columbia Wellfield is a 90-mgd supplemental drinking water supply that the Portland Water Bureau owns and operates. The wellfield provides up to 43 mgd of continuous flow to the UV reactor test train. Typical water quality of the groundwater is shown in Table F.11

Table F.11. Southshore Wellfield Water Quality Characteristics

Parameter	Unit	Value
UVT	%	96.8 – 98.6 (98.3 average)
Hardness	mg/L	38 – 144
Alkalinity	mg/L CaCO ₃	34 – 169
pH	unitless	5.8 – 8.8
Chlorine	mg/L	none

The high UVT allowed testing of the full range of operating UVT conditions, and the zero chlorine residual eliminated the need to quench the chlorine prior to adding chlorine-sensitive challenge microorganisms.

Carollo Engineers conducted the validation testing. Clancy Environmental Consultants (CEC), St. Albans, Vermont, supervised the injection and sampling of the challenge microorganism. CEC prepared all stock solutions of the challenge microorganism, measured challenge microorganism UV dose-response using the collimated beam apparatus, and assayed challenge microorganism concentrations. WEDECO Inc. (Charlotte, North Carolina) operated the UV reactor during biosimetry testing with oversight by Carollo.

F.2.3.1 Validation Conditions

The Portland Validation Facility allowed testing conditions (e.g., piping configuration) to be defined for each validation test, which allowed the testing to be optimized to US guidelines based on the UVDGM Proposal Draft (USEPA 2003). The Weber WTP No. 3 reactor was validated with inlet piping that included a 90-degree bend located three pipe diameters upstream of the reactor and another 90-degree bend less than three pipe diameters downstream of the reactor. This configuration did not represent the actual piping arrangement at the Weber WTP No. 3 but, instead, represented the “worst case” flow conditions through the UV reactor.

The high UVT of the Columbia Wellfield water allowed the full range of UVT conditions to be tested. Lignin sulfonic acid (LSA), a UV absorber, was used to reduce the UVT as needed. The challenge microorganism used in the validation testing was MS2 phage. Static mixers were used to ensure that additives were well mixed upstream of the reactor inlet sampling port and the reactor exit sampling port. The testing configuration is shown in Figure F.11.

Figure F.11. Validation Testing Configuration

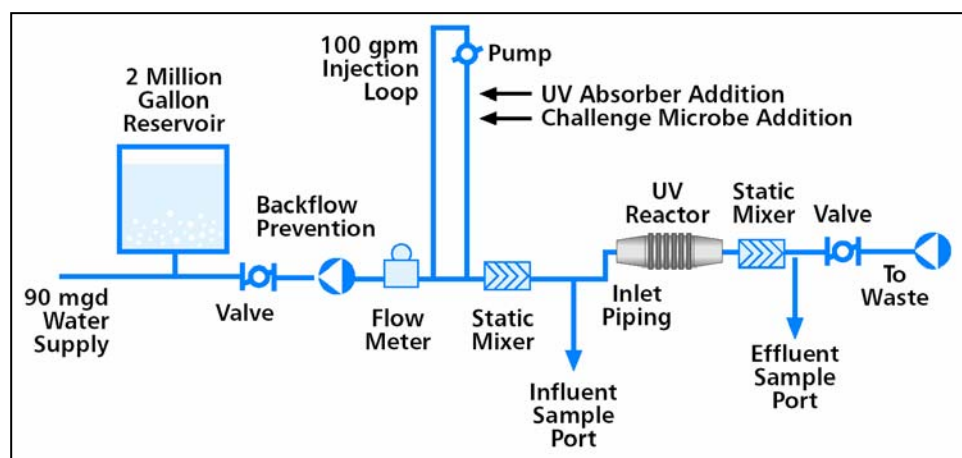

The UV reactor was tested using a range of flow rate, UVT, and operating lamp combinations to validate UV dose delivery and UV sensor measurements. The experimental matrix was designed to validate the vendor’s UV intensity setpoint approach with variable setpoint operation for a range of water quality conditions within the defined design criteria. The experimental matrix also was intended to enable the PWS to optimize performance (i.e., deliver the target MS2 RED with a minimal number of lamp banks in operation at a minimum power level).

Following is a summary of the range of validation conditions:

- All lamps were operated at 67 percent of their nominal output during the validation testing to account for lamp aging and fouling effects.
- Flow rates ranged from 0.94 – 20 mgd.

- UVT ranged from 85 – 95 percent.
- The number of lamp banks that were on was 1, 2, 4, 5, and 6 (all banks).
- Target MS2 RED values ranged from 20 – 100 mJ/cm².

The test conditions and results for several of the 34 validation tests that were conducted are summarized in Table F.12.

Table F.12. Excerpt of Test Conditions for Validation Testing at the Portland Validation Facility (Total No. of Tests = 34)

Run No.	Flow Rate (mgd)	No. Banks On	UVT (%)	UVT Modifier	Test Organism	Lamp Power (%)
12	2.07	2	84.7	LSA	MS2	67
9	2.36	1	95.0	LSA	MS2	67
3	0.94	1	84.7	LSA	MS2	67
16	17.61	2	94.8	LSA	MS2	67
36	19.57	6	94.8	LSA	MS2	67
22	20.00	4	89.9	LSA	MS2	67
38	14.49	5	90.1	LSA	MS2	67
19	15.65	4	85.0	LSA	MS2	67
29	12.07	6	85.3	LSA	MS2	67

The collimated beam dose-response results for an example day of testing are shown in Figure F.12, and Table F.13 summarizes validation testing results.

UV transmittance measurements were checked using National Institute of Standards and Technology (NIST)-traceable UV absorbance standards. Flow measurements were checked by comparison of manufacturer calibration to internal settings. The UV dose-response of the MS2 phage met bounds described by the UVDGM Proposal Draft (2003) and NWRI (2003). Bidosimetry and sensor testing and data analysis were based on the June 2003 Draft UVDGM recommendations (Tier 2 analysis).

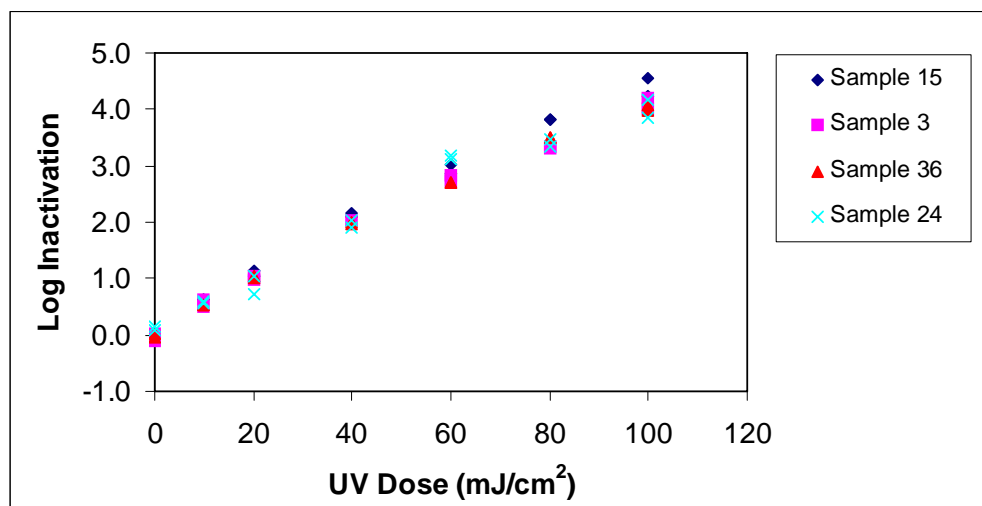
Figure F.12. Collimated Beam UV Dose-response Data**Table F.13. Validation Testing Results**

Run No.	Flow Rate (mgd)	No. Banks On	Lamp Power (%)	UVT (%)	Log Infl. MS2 (pfu/mL)	Log Effl. MS2 (pfu/mL)	Log I	MS2 RED (mJ/cm ²)
12	2.07	2	67	84.7	5.04	2.16	2.88	57.9
9	2.36	1	67	95.0	5.29	0.97	4.32	96.0
3	0.94	1	67	84.7	5.38	2.41	2.97	66.9
16	17.61	2	67	94.8	4.69	3.23	1.46	28.4
36	19.57	6	67	94.8	5.32	2.00	3.32	76.7
22	20	4	67	89.9	4.69	3.45	1.24	23.6
38	14.49	5	67	90.1	4.81	2.73	2.07	42.9
19	15.65	4	67	85.0	4.76	3.53	1.23	23.4
29	12.07	6	67	85.3	4.67	2.57	2.09	41.6

The measured relationship between UV sensor measurements and UVT at the 80 percent intensity turn-down reflecting end-of-lamp-life (EOLL) was described using a power function (A and B are constants):

$$UV \text{ Sensor } (UVT, EOLL) = e^A e^{B \times UVT} \quad \text{Equation F.1}$$

The functions describing the UV sensor measurements as a function of ballast power setting and UVT were obtained using new lamps, sleeves, and UV sensors in a clean UV reactor. The functions can be compared to measurements made at a WTP to assess the relative output of the lamps compared to the data measured during validation.

The test results were evaluated by plotting measured MS2 RED (mJ/cm²) as a function of number of operating banks divided by flow rate (Q in mgd), again based on a specific UVT value

and at the intensity turn-down reflecting end-of-lamp-life. Statistical analysis was used to determine if data sets obtained with different rows could be combined. The relationship was fitted by a polynomial function (A and B are constants):

$$RED (UVT, EOLL) = A \left(\frac{Banks}{Q} \right) + B \left(\frac{Banks}{Q} \right)^2 \quad \text{Equation F.2}$$

Based on these equations, an automatic UV dose-monitoring strategy was developed that determined the necessary number of banks/rows in operation and the ballast power, so that a selected target MS2 RED (e.g., 40 mJ/cm²) is met.

F.2.3.2 Validation Implications for O&M

The validation testing data were used to develop equations that would automatically determine the needed number of banks in operation and ballast power so that the selected target MS2 RED (e.g., 40 mJ/cm²) could be provided.

F.2.4 Start-Up and Operation of the UV Facility

Full-scale operation of the facility began in June 2004. Photos of the UV equipment are shown in Figures F.13 and F.14.

**Figure F.13. UV Reactors at the Weber WTP No. 3
(3 duty + 1 standby reactor in parallel)**



**Figure F.14. UV Reactor Electrical Cabinets at the Weber WTP No. 3
(the floor above the UV reactors)**



F.2.4.1 Start-up and Construction Issues

Since start-up, the UV facility has been operating as intended (no frequent UV unit shut-downs, lamp failures, or similar mechanical problems). However, as with any new unit process, some problems have been experienced, including the following:

- **UV-monitoring system.** Not all of the low-level alarm settings and controls in the monitoring system software worked properly in the first version of software provided. The vendor subsequently updated the software.
- **Manganese fouling.** Sleeve and sensor fouling was a serious problem when the UV equipment was first started. Although dissolved manganese concentrations were not measured, the problem began when the District began adding ferric chloride for coagulation. Analysis of the foulant indicated that manganese, an impurity present in the coagulant, caused the fouling. To control this problem, hypochlorite was fed upstream of the filters to oxidize the manganese, which was then removed by the filters. The District plans to discontinue the hypochlorite feed once the intermediate ozonation system is fully operational.
- **Cleaning system.** The phosphoric acid chemical cleaning system originally intended for use with the UV reactors was installed on a cart on the upper level of the UV disinfection room. A long hose with a spray-nozzle attachment was to be hand-carried to the lower level and inserted into the UV reactors for cleaning. However, the cleaning system could not provide enough suction to work properly with the cart located on the upper level, and the cart could not be moved to the lower level due to mobility constraints. Therefore, a new chemical cleaning system that could provide appropriate pumping power was constructed on the lower level adjacent to the UV reactor.

- **Control panel.** The UV equipment was designed with one transformer for each ballast enclosure. During the first summer of operation, the enclosures overheated and had to be opened so the transformers could be cooled with box fans. The manufacturer recommends that the temperature in the control room not exceed 100 °F. The temperature in this room was not measured during the first summer of operation, so whether the overheating was due to an inadequate or faulty control panel cooling system or to high temperatures in the control room is unknown. The source of this problem remains under investigation.
- **Training.** The manufacturer did not provide on-site operator training on UV reactor O&M until after the UV equipment had been operating for several months.

F.2.4.2 Operation and Maintenance Requirements

The UV sensors are calibrated monthly, and no sensor drift has been observed since the facility has been operational. Similarly, the online UVT analyzer is also checked monthly and no drift has been observed. No lamps have been replaced since the UV facility began operations, and no chemical cleaning has been performed. Inspections of some of the lamps, however, reveal no signs of fouling. Information on the amount of labor required to perform these O&M tasks was not readily available. No information was readily available on power usage.

F.2.4.3 Operational Challenges

Except for resolving the start-up and construction issues (Section F.2.4.1), the District has generally found the facility to be relatively simple to operate.

F.2.5 Future UV Facility Plans

The District plans to apply to the Utah Department of Environmental Quality for approval of the UV disinfection system for *Cryptosporidium* and *Giardia* credit in the future.

The District may target different *Cryptosporidium* and *Giardia* inactivation levels in the future to respond to future regulatory requirements. The UV manufacturer has provided curves showing flow rate versus number of UV lamp banks in operation for three different MS2 RED (20, 30, and 40 mJ/cm²) to enable future operational flexibility.

F.3 Clayton County Water Authority – LPHO Facility with On-site Validation

The Clayton County Water Authority (CCWA) owns and operates three WTPs, which serve more than 250,000 people in Clayton County, Georgia. The Freeman Road WTP is a 12-mgd conventional surface WTP. Chlorine dioxide is applied prior to the rapid mix process to oxidize taste and odor compounds and iron and manganese, and free chlorine is applied to the filtered water for disinfection. In 2002 the plant was upgraded to include a UV disinfection

facility. The filtered water quality characteristics that were the basis for the UV reactor design are summarized in Table F.14.

Table F.14. Summary of Freeman Road WPP Filtered Water Quality

Parameter	Units	Design Value
Turbidity	NTU	0.18
pH	–	8.1
Alkalinity	mg/L-CaCO ₃	29
Iron	mg/L	0.1
Manganese	mg/L	0.02
Total Organic Carbon	mg/L	< 2

F.3.1 Planning and Design

This section discusses the key planning and design decisions made for CCWA's UV facility.

F.3.1.1 UV Disinfection Goals

The UV equipment was installed at the Freeman Road WTP to provide an additional pathogen barrier. The basis for the facility design was 2.5-log *Cryptosporidium* inactivation. UV disinfection was selected over other disinfection technologies because of its effectiveness against pathogens and its cost-effectiveness.

F.3.1.2 UV Retrofit Location

The UV reactors were installed on the combined filter effluent piping in a new stand-alone building. As part of the UV retrofit, chemical feeds for lime, fluoride, phosphoric acid, and chlorine were relocated to follow the UV reactors.

F.3.1.3 Key Design Parameters

The UV reactors for the Freeman Road WTP were bid and selected before detailed design of the facility. The bid was open to LPHO and MP reactors. A life cycle cost analysis that incorporated the capital costs and the anticipated energy and maintenance costs was used to select the UV reactors. Ultimately, LPHO reactors were selected for the Freeman Road WTP. After selecting the reactors, one set of plans and specifications was developed for the design. The UV facility consisted of three WEDECO Series K reactors. Key design parameters for the UV reactors are shown in Table F.15. A conservative MS2 RED (50 mJ/cm²) to be verified during

validation testing was selected because the design was to be completed while the LT2ESWTR and this manual were still under development.

Table F.15. UV Reactor Design Parameters

Criterion	Unit	Value
UV Transmittance	percent	91
Fouling/Aging Factor	percent	60
Total Flow Rate	mgd	12
Target MS2 RED ¹	mJ/cm ²	50
Number of UV Units (Duty + Standby)	number	2 + 1
Design Flow Rate per Unit	mgd	6
Number of Lamps per Unit	number	30
Lamp Power (Each)	W	275

¹ The MS2 RED to be proven during validation testing.

Facility Hydraulics

No modifications to the plant hydraulics were required at the Freeman Road WTP because the available head between the filter effluent control weir and the clearwell was sufficient for the UV reactors.

Operational Strategy, Instrumentation and Control

A magnetic flow meter is installed in the piping upstream of each UV reactor to monitor the flow split between the reactors. Each UV reactor is equipped with three UV sensors, one for each bank of lamps. Additionally, an on-line UVT analyzer enables the UV reactors to be operated with either a (1) UV Intensity Setpoint Approach or (2) Calculated Dose Approach. However, the UV equipment has not yet been validated for operation in calculated dose mode.

Electrical Power Configuration and Power Quality

A UPS was provided at the Freeman Road WTP to ensure that the UV equipment remains in continuous operation. No power quality or outage issues have been experienced at the facility.

Capital Cost

The total capital cost for the UV facility at the Freeman Road WTP was approximately \$2,170,000 in 2006 (ENR BCI = 4356) dollars. The cost includes all elements related to the UV facility, the building, UV reactors, piping, valves, electrical system, instrumentation and controls, and other ancillary equipment.

F.3.2 Validation

Validation testing was conducted in February 2003. On-site rather than off-site validation was selected to maximize flexibility in selecting the specific operating conditions for testing and in allowing potential future testing as EPA requirements are established.

One of the three reactors was designed to serve as a test reactor for on-site validation. The inlet and outlet piping to the test reactor can be isolated, and the outlet piping allows flow to be routed to waste. The other two UV reactors and their upstream and downstream piping are identical in design to the test reactor, so the testing was representative of each of the other reactors.

Preliminary testing before validation indicated that nearly complete die-off of the MS2 phage had occurred in both the influent and effluent samples from the UV reactor. Although the chlorine dioxide preoxidation system had been shut down several days before testing, jar test results indicated that low levels of chlorate or chlorine dioxide caused the die-off. The jar tests also indicated that the effect of the chlorate or chlorine dioxide on the MS2 could be alleviated by adding LSA, a compound commonly used during validation to reduce UVT. The problem was therefore resolved by spiking the microbial samples with LSA before shipping them to the laboratory for analysis.

The challenge microorganism used in the testing was MS2 phage. A dilute LSA solution was used to reduce the UVT as needed in the filtered water and to prevent die-off in the MS2 samples. The results of the validation testing are shown in Table F.16.

Table F.16. Validation Testing Conditions and Results for CCWA's Freeman Road WTP

Run No.	Flow (mgd)	Configuration ¹	UVT Modifier	Test Organism	Lamp Power (%)	UVT (%)	Influent MS2 (log PFU/mL)	Effluent MS2 (log PFU/mL)	Log Reduction	MS2 RED (mJ/cm ²)
1F	5.41	3 banks on	LSA	MS2	50	91.2	5.35	2.76	2.59	57.2
2F	5.95	3 banks on	LSA	MS2	50	90.8	5.44	2.96	2.48	54.1
3F	6.49	3 banks on	LSA	MS2	50	90.7	5.43	3.30	2.13	44.6
4F	7.29	3 banks on	LSA	MS2	50	91.9	5.48	3.46	2.02	41.7
5F ²	7.39	3 banks on	LSA	MS2	–	–	5.54	5.57	-0.04	–

¹ Each reactor contains 3 banks with 10 lamps per bank.

² Control run

F.3.3 Start-up and Operation of the UV Facility

Construction of the UV facility at the Freeman Road WTP was completed in December 2002, and full-scale operation began in April 2003. At the time of publication, operations and maintenance data were not made available for the Freeman Road WTP.

Although the UV equipment has generally operated well since start-up, an issue requiring a minor change did arise in the first year. In October 2003 after several months of operation,

WEDECO replaced the UV lamps in the reactors with a new production model. The new lamps were tested to ensure that the UV intensity of the replacement lamps (following a 100-hour burn-in period) was equal to or better than the intensity of the lamps that had been replaced. However, comparison of the intensity data for the replacement lamps to the data that had been collected during validation indicated that the intensity of the replacement lamps was less than that of the previous lamps.

An investigation of the problem determined that microbubbles in the water passing through the UV reactor were causing the measured decrease in UV intensity, not the replacement lamps. The existing air release valve on each reactor did not sufficiently release entrained air from the water, particularly in colder months due to the higher dissolved oxygen concentration in the water. To alleviate the problem, two additional air release valves were installed on the influent header between the filter control weir (the source of the entrained air) and the UV reactors. The additional air release capability minimized the formation of microbubbles during periods of low water temperature.

F.4 Newark Water Treatment Plant – MP Reactors on Each Filter Effluent Pipe

The Newark WTP, located in Newark, Ohio, is a 15-mgd surface WTP. The Newark WTP has an average daily flow rate of approximately 8 mgd and serves a population of more than 47,500 people. Treatment processes at the Newark WTP include preoxidation with potassium permanganate and powdered activated carbon for removal of taste- and odor-causing contaminants, lime softening, sedimentation, recarbonation, rapid sand filtration, and disinfection with UV light and chlorine.

The filtered water quality characteristics that were the basis for the UV reactor design are summarized in Table F.17.

Table F.17. Summary of Newark WTP Filtered Water Quality

Parameter	Units	Average	Minimum	Maximum
pH	–	7.6	7.2	8.2
Turbidity	NTU	0.23	0.18	0.53
Total Alkalinity	mg/L-CaCO ₃	60	40	100
Total Hardness	mg/L-CaCO ₃	120	90	160
Calcium Hardness	mg/L-CaCO ₃	67.4	75	60
Iron	mg/L	0.03	0.01	0.10
Manganese	mg/L	0.02	0.01	0.03
Temperature	°F	60	33	80
Total Organic Carbon	mg/L	1 – 2	No data	No data

F.4.1 Planning and Design

This section discusses the key planning and design decisions made for Newark's UV facility.

F.4.1.1 UV Disinfection Goals

UV disinfection was installed at the Newark WTP to provide an additional treatment barrier against pathogens and to ensure public health protection in the event of high turbidity in the raw water. The City's water source has historically experienced turbidity spikes following rainfall events.

F.4.1.2 UV Retrofit Location

Three locations were considered for the UV reactors. Two locations were on the combined filter effluent at the plant's chlorine contact basin that is used to achieve chlorine disinfection requirements. This basin is located prior to the clearwell and finished water pump station. The third location considered was on each of the ten individual filter effluents (IFE). The IFE location was selected because both the capital and O&M costs were less than the costs for the other alternatives. Additionally, the IFE location provided a high degree of redundancy and O&M enhancements due to the number of reactors.

To accommodate the retrofit, filter effluent piping had to be rearranged on four filters to provide the desired straight piping runs upstream and downstream of the reactor. Also, existing valves on two filters had to be rotated 90 degrees to provide sufficient clearance to service the reactors. Figure F.15 illustrates the UV reactor installation on one of the filter effluent pipes.

Figure F.15. UV Reactor at the Newark WTP



F.4.1.3 Key Design Parameters

The UV reactor specification allowed MP reactors only because LPHO reactors could not meet the space constraints of this application. The competitive bid resulted in the selection of Trojan's 12-inch UVSwift™ reactor because the other bidder could not meet the head loss requirement. The UV equipment was selected prior to design and purchased as part of the UV facility construction contract.

Key design parameters for the UV reactor are shown in Table F.18. The target MS2 RED of 40 mJ/cm² to be verified in validation was selected based on best practices in North America and Europe at the time to inactivate a range of pathogens.

Table F.18. UV Reactor Design Parameters

Criterion	Unit	Value
UV Transmittance	percent	85
Fouling/Aging Factor	percent	80
Total Flow Rate	mgd	15
MS2 RED ¹	mJ/cm ²	37
Number of UV Units	number	10
Design Flow Rate per Unit	mgd	1.5
Number of Lamps per Unit	number	4
Lamp Power (Each)	kW	1.26

¹ The MS2 RED to be proven during validation testing.

Facility Hydraulics

The head losses created by the UV reactors and the necessary piping modifications were less than 6 inches at the maximum flow rate through the reactors. Therefore, no additional pumping or other hydraulic modifications were required for the addition of the UV reactors. Each reactor was rated for a maximum flow rate of 1.5 mgd, which corresponded to the rated maximum filter capacity of 4 gallons per minute per square foot (gpm/sf).

Operational Strategy, Instrumentation, and Control

The UV equipment operates using the Calculated Dose Approach. The UV reactors automatically adjust to changing conditions to ensure that the calculated dose does not fall below the dose setpoint. Each reactor normally operates for 4 days followed by a day out of operation, corresponding to the normal filter service times. When UV reactors are returned to operation, an isolation valve located upstream of the UV reactor is closed, and plant service water flowing at approximately 20 gpm is used to cool the lamps while the reactor is started up and the lamps return to full power (approximately 10 to 15 minutes). After passing through the reactor, the cooling water enters the process train and is sent to the contact time (CT) basin for primary disinfection and then to the finished water clearwell. Once the lamps reach full power, the

upstream isolation valve is opened, and filtered water flows through the UV reactors. The advantage of using plant service water as cooling water during reactor start-up is that because it has previously been treated by UV disinfection, the cooling water does not have to be included in the calculation of off-specification water.

Each reactor was located downstream of an existing flow control valve and flow meter. New isolation valves were installed downstream of each reactor. In addition to UV sensors, each reactor has a level sensor and temperature sensor. The level and temperature sensors protect the UV reactor from running dry or overheating or both. Each reactor was also provided with an auxiliary potable water supply connection to maintain a minimum flow rate of 15 gpm to prevent overheating during reactor start-up and shut-down. Each reactor has a UVT analyzer located on the filter effluent pipe to provide UVT measurements for dose monitoring.

Electrical Power Configuration and Power Quality

Power quality at Newark WTP was assessed over a fifteen-month period (March 2003 – June 2004) as part of an American Water Works Association Research Foundation Project (Cotton et al. 2005). During this time, 240 power quality events occurred. The frequency and classification of the power quality events at the WTP for this fifteen-month period are shown in Table F.19.

Table F.19. Power Quality at Newark WTP

Power Quality Event	City of Newark		
	Total	Monthly Average	Maximum Month
Instantaneous Voltage Sag	215	14.33	75
Momentary Voltage Sag	6	0.4	2
Temporary Voltage Sag	0	0	0
Instantaneous Swell	0	0	0
Instantaneous Interruption	0	0	0
Momentary Interruption	8	0.53	4
Temporary Interruption	3	0.2	1
Sustained Deep Undervoltage	1	0.07	1
Sustained Interruption	7	0.47	4
Total Estimated Time (minutes)	NA	168	775
Estimated % Off-specification Time	NA	0.38	1.74

Approximately 90 percent of the power quality events were instantaneous voltage sags (i.e., voltage sags lasting between 0.5 and 30 cycles). The UV reactors were not operational until May 2004, so the off-specification time shown in Table 4.19 is an estimate calculated by assuming 10 minutes of off-specification time for each voltage sag lasting more than 2 cycles. Although a UPS system was not installed at the Newark WTP, the UV equipment's ballast and electrical design prevents the UV reactors from losing power in many cases. As a result, the WTP is not having trouble meeting the off-specification requirements proposed in this guidance manual.

Capital Cost

The capital cost for adding the UV equipment to the Newark WTP was \$1,135,000 (2006 dollars – ENR BCI = 4356). The cost includes modifications to the existing building and piping, UV reactors, piping, valves, instrumentation and controls, and other ancillary equipment.

F.4.2 Validation

No validation testing had been performed at the time of publication because no disinfection credit was needed. Newark may choose to validate the reactors in the future.

F.4.3 Start-up and Operation of the UV Facility

Construction of the UV facility was substantially complete and full-scale operation began in May 2004. The project was completed in July 2004. Overall, the UV equipment has operated smoothly, and only minor issues were encountered during start-up.

Minor issues with the control panels and wiring were resolved by the factory representative and the contractor. Additionally, the automatic backwash sequence programming had to be rewritten to accommodate the UV reactor cooling water. During the reprogramming, problems with existing valve actuators were uncovered that required some actuator limit switches to be adjusted.

Operations and maintenance costs were not readily available at the time of publication.

F.5 City of Winnipeg Water Treatment Plant – MP Facility with On-site Validation

The City of Winnipeg's water supply is obtained from a surface water source and is currently unfiltered. Water is chlorinated, and fluoride and phosphate are also added before it is distributed to the 630,000 people served by the water system.

A new WTP is currently under construction for the City of Winnipeg, which will use the following processes: rapid mix, coagulation, flocculation, dissolved air flotation, ozone, biological activated carbon filtration, UV disinfection, and chloramination. The UV facility was constructed before the rest of the treatment plant (scheduled for completion in 2007) to minimize the risk posed by *Cryptosporidium* and other waterborne pathogens. The UV facility will be integrated within the new WTP when it is constructed.

The raw water quality characteristics that were the basis for the UV reactor design are summarized in Table F.22.

Table F.22. Summary of Raw Water Quality (1989 – 1994)

Parameter	Units	Average	Minimum	Maximum
pH	–	8.2	7.4	9.1
Turbidity	NTU	1.0	0.3	5.3
Total Organic Carbon	mg/L	9.3	5	17
Dissolved Organic Carbon	mg/L	8.3	4	15
Plankton	cells/mL	39,700	200	666,000
Total Alkalinity	mg/L-CaCO ₃	81	72	95
Total Hardness	mg/L-CaCO ₃	83	68	97
Color (true)	TCU ¹	< 5	< 5	10

¹ True color units

F.5.1 Planning and Design

This section discusses the key planning and design decisions made for the City of Winnipeg's UV facility.

F.5.1.1 UV Disinfection Goals

The UV reactors were designed to provide 2-log *Cryptosporidium* inactivation in the Deacon Reservoir raw water. The goal will remain unchanged when the UV facility is later used to treat filtered water, even though the facility will be able to treat higher flow rates (at higher UVT).

F.5.1.2 UV Retrofit Location

The UV facility currently treats unfiltered raw water. In 2007 when the WTP is expected to be complete, the UV facility will be located downstream of the combined filter effluent. The equipment was installed in an existing pump station building on the site.

F.5.1.3 UV Reactor Selection

Because of space limitations in the existing building, MP reactors were selected. The MP reactors were selected in a competitive pre-selection/proposal process prior to completion of the final design. A cost/benefit model was used to evaluate the two pre-selected UV equipment alternatives (a typical model summary is shown in Figure F.16). Benefit scores (example values shown in stacked bars in Figure F.16) for non-monetary evaluation criteria were developed in advance of bids for each alternative by assigning relative weights to each criterion and then scoring each alternative against the criteria. The present worth costs for each alternative (example values shown in the line plot in Figure F.16) were then divided by the corresponding benefit score to calculate the cost/benefit ratio (example values shown in line plot in Figure F.16). The supplier that had the lowest cost/benefit ratio (i.e., low cost and high benefit), was then selected.

F.5.1.4 Key Design Parameters

Six Calgon Sentinel® 48-inch UV reactors comprise the UV facility. Key design parameters for the UV reactors are shown in Table F.23. The target MS2 RED to be verified in validation was based on criteria from the UVDGM Proposal Draft (USEPA 2003) for 2-log inactivation of *Cryptosporidium*.

Following construction of Winnipeg's WTP, the design UVT will be increased to 90 percent. The design flow rate per reactor will also be increased; however, the total design flow rate through the facility will be reduced to 106 mgd as reactors are changed to stand-by and other measures are taken to improve UV facility redundancy.

Figure F.16. Cost-Benefit Comparison for Winnipeg's UV Reactors

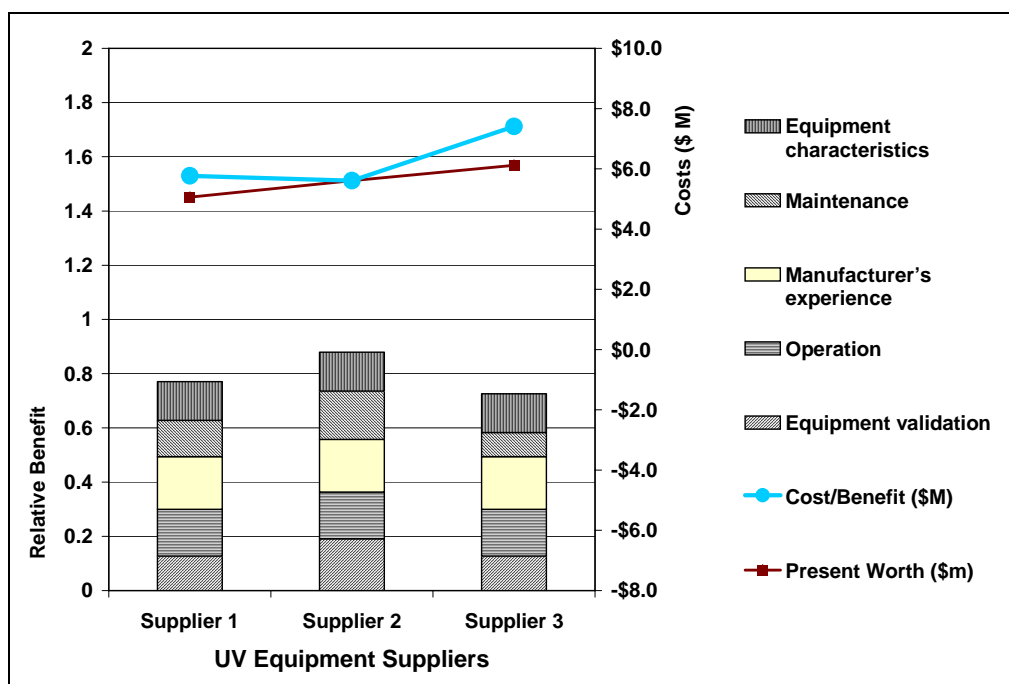

Table F.23. UV Reactor Design Parameters

Criterion	Unit	Value
UV Transmittance	percent	75
Fouling/Aging Factor	percent	70
Total Flow Rate	mgd	130
MS2 RED ¹	mJ/cm ²	28
Number of UV Units (All Duty)	number	6
Design Flow Rate per Unit	mgd	22
Number of Lamps per Unit	number	9
Lamp Power (Each)	kW	21.6

¹ The MS2 RED to be proven during validation testing.

Facility Hydraulics

No modifications to the facility hydraulics were required for the addition of the UV facility at the existing building. Furthermore, the hydraulics of the future WTP will be designed to incorporate the UV facility.

Operational Strategy, Instrumentation, and Control

Control of the UV reactors is based on the UV intensity setpoint (i.e., UV Intensity Setpoint Approach). A UV sensor was provided for each lamp in each reactor to monitor performance. Flow meters and modulating valves on each reactor are used to distribute the water among operating reactors, and isolation valves are located upstream of each reactor.

As the system demand increases and reactors approach their maximum capacities, additional reactors are started up as needed. The procedure is followed in reverse as system demand decreases.

Electrical Power Configuration and Power Quality

Power quality problems are not common at the location of Winnipeg's UV facility, so a UPS was not provided. For initial (unfiltered) operation, a back-up generation system was not provided for the UV facility; therefore, the UV facility is not operational during power outages. A back-up power system will be provided for long-term operation when the WTP is constructed.

Capital Cost

The total capital cost for the City of Winnipeg's UV facility was approximately \$5,885,000 in 2006 U.S. dollars (ENR BCI = 4356). The cost includes the UV reactors, piping, valves, instrumentation and controls, and other ancillary equipment.

F.5.2 Validation

Although the UV reactors had been validated off-site before installation, the off-site testing had focused mainly on typical UVT levels, and only a limited number of runs had tested UVT levels below 80 percent. Therefore, the City of Winnipeg made on-site validation testing a bidding requirement. The on-site validation testing focused on lower UVT levels (70 – 78 percent), consistent with the raw water to be treated by the UV facility. The on-site testing included tests at a range of flow rates (6 – 25 mgd) and lamp settings.

The on-site testing was conducted in February 2005. The challenge microorganism was MS2, and SuperHume™ (potassium humate salts) was used to adjust the UVT of the test water. Thirty-eight tests were run, and additional blanks and other quality control samples were also taken. An excerpt of the validation testing conditions and results are shown in Table F.24.

F.5.3 Start-up and Operation of the UV Facility

Construction of the UV facility was completed in December 2004. Although validation has been completed, full-scale operation of the facility will be started up after functional testing has been completed.

Table F.24. Excerpt of the Validation Testing Conditions and Results for the City of Winnipeg

Run No.	Flow (mgd)	Configuration ¹	UVT Modifier	Test Organism	UV Intensity (W/m ²)	UVT (%)	Influent MS2 (log PFU/mL)	Effluent MS2 (log PFU/mL)	Log Reduction	MS2 RED (mJ/cm ²)
1	24.9	3 banks on	SH	MS2	138.0	74.9	4.94	3.18	1.76	32.6
2	25.1	3 banks on	SH	MS2	97.0	74.9	5.02	3.21	1.80	33.4
3	25.0	3 banks on	SH	MS2	155.0	77.5	5.26	3.31	1.94	36.5
4	24.9	3 banks on	SH	MS2	63.0	77.5	5.27	4.27	1.00	17.3
13	25.3	3 banks on	SH	MS2	30.0	70.2	5.35	4.77	0.58	9.4
14	25.0	2 banks on	SH	MS2	87.0	70.0	5.44	4.24	1.21	20.5
16	12.5	3 banks on	SH	MS2	117.0	77.5	5.25	2.84	2.41	48.3
17	12.6	2 banks on	SH	MS2	63.0	77.8	5.26	3.67	1.59	29.7
30	6.3	2 banks on	SH	MS2	63.0	77.7	5.28	3.59	1.70	31.9
31	6.3	3 banks on	SH	MS2	48.0	74.8	5.36	3.22	2.14	41.9

¹ Each reactor contains 3 banks with 3 lamps per bank.
SH – SuperHume™

This page intentionally left blank.

Appendix G

Reduction Equivalent Dose Bias Tables

This page intentionally left blank.

Tables G.1 – G.17 present RED Bias as a function of water ultraviolet transmittance (UVT) and challenge microorganism UV sensitivity for various log inactivation levels (ranging from 4.0 – 0.5) for *Cryptosporidium*, *Giardia*, and viruses. Tables G.1 – G.8 present RED Bias values for *Cryptosporidium*, Tables G.9 – G.16 present RED Bias values for *Giardia*, and Table G.17 presents RED Bias values for viruses. The RED Bias values for intermediate UVT values (e.g., UVT between 85 and 90 percent) can be interpolated from the values in the table, if desired.

Index of Tables

Table No.	Table Title	Page
G.1	RED Bias Values for 4.0-log <i>Cryptosporidium</i> Inactivation Credit as a Function of UVT and UV Challenge Microorganism Sensitivity	2
G.2	RED Bias Values for 3.5-log <i>Cryptosporidium</i> Inactivation Credit as a Function of UVT and UV Challenge Microorganism Sensitivity	3
G.3	RED Bias Values for 3.0-log <i>Cryptosporidium</i> Inactivation Credit as a Function of UVT and UV Challenge Microorganism Sensitivity	4
G.4	RED Bias Values for 2.5-log <i>Cryptosporidium</i> Inactivation Credit as a Function of UVT and UV Challenge Microorganism Sensitivity	5
G.5	RED Bias Values for 2.0-log <i>Cryptosporidium</i> Inactivation Credit as a Function of UVT and UV Challenge Microorganism Sensitivity	6
G.6	RED Bias Values for 1.5-log <i>Cryptosporidium</i> Inactivation Credit as a Function of UVT and UV Challenge Microorganism Sensitivity	7
G.7	RED Bias Values for 1.0-log <i>Cryptosporidium</i> Inactivation Credit as a Function of UVT and UV Challenge Microorganism Sensitivity	8
G.8	RED Bias Values for 0.5-log <i>Cryptosporidium</i> Inactivation Credit as a Function of UVT and UV Challenge Microorganism Sensitivity	9
G.9	RED Bias Values for 4.0-log <i>Giardia</i> Inactivation Credit as a Function of UVT and UV Challenge Microorganism Sensitivity	10
G.10	RED Bias Values for 3.5-log <i>Giardia</i> Inactivation Credit as a Function of UVT and UV Challenge Microorganism Sensitivity	11
G.11	RED Bias Values for 3.0-log <i>Giardia</i> Inactivation Credit as a Function of UVT and UV Challenge Microorganism Sensitivity	12
G.12	RED Bias Values for 2.5-log <i>Giardia</i> Inactivation Credit as a Function of UVT and UV Challenge Microorganism Sensitivity	13
G.13	RED Bias Values for 2.0-log <i>Giardia</i> Inactivation Credit as a Function of UVT and UV Challenge Microorganism Sensitivity	14
G.14	RED Bias Values for 1.5-log <i>Giardia</i> Inactivation Credit as a Function of UVT and UV Challenge Microorganism Sensitivity	15
G.15	RED Bias Values for 1.0-log <i>Giardia</i> Inactivation Credit as a Function of UVT and UV Challenge Microorganism Sensitivity	16
G.16	RED Bias Values for 0.5-log <i>Giardia</i> Inactivation Credit as a Function of UVT and UV Challenge Microorganism Sensitivity	17
G.17	RED Bias Values for Virus Inactivation Credit as a Function of UV Challenge Microorganism Sensitivity	18

Table G.1. RED Bias Values for 4.0-log *Cryptosporidium* Inactivation Credit as a Function of UVT and UV Challenge Microorganism Sensitivity

<i>Cryptosporidium</i> log inactivation credit		4.0						
Required UV dose (mJ/cm ²)		22						
<i>Cryptosporidium</i> UV sensitivity (mJ/cm ² /log I)		5.5						
UVT (%)		≥ 98	≥ 95	≥ 90	≥ 85	≥ 80	≥ 75	≥ 65
Challenge UV sensitivity (mJ/cm ² /log I)		RED Bias						
Lower	Upper							
0	≤ 2	1.00	1.00	1.00	1.00	1.00	1.00	1.00
> 2	≤ 4	1.00	1.00	1.00	1.00	1.00	1.00	1.00
> 4	≤ 6	1.01	1.02	1.03	1.03	1.03	1.03	1.04
> 6	≤ 8	1.05	1.09	1.12	1.14	1.16	1.17	1.18
> 8	≤ 10	1.08	1.15	1.21	1.25	1.27	1.30	1.33
> 10	≤ 12	1.11	1.20	1.29	1.34	1.38	1.42	1.46
> 12	≤ 14	1.13	1.24	1.37	1.44	1.49	1.53	1.60
> 14	≤ 16	1.15	1.28	1.44	1.53	1.59	1.65	1.73
> 16	≤ 18	1.16	1.31	1.50	1.61	1.69	1.76	1.86
> 18	≤ 20	1.17	1.34	1.55	1.69	1.78	1.87	1.99
> 20	≤ 22	1.18	1.36	1.61	1.77	1.87	1.97	2.11
> 22	≤ 24	1.19	1.38	1.66	1.84	1.96	2.08	2.24
> 24	≤ 26	1.20	1.40	1.70	1.91	2.05	2.18	2.36
> 26	≤ 28	1.21	1.41	1.74	1.98	2.14	2.28	2.48
> 28	≤ 30	1.22	1.43	1.78	2.04	2.22	2.38	2.60
> 30	≤ 32	1.22	1.44	1.81	2.10	2.30	2.47	2.73
> 32	≤ 34	1.23	1.45	1.85	2.16	2.38	2.57	2.84

Table G.2. RED Bias Values for 3.5-log *Cryptosporidium* Inactivation Credit as a Function of UVT and UV Challenge Microorganism Sensitivity

<i>Cryptosporidium</i> log inactivation credit		3.5						
Required UV dose (mJ/cm ²)		15						
<i>Cryptosporidium</i> UV sensitivity (mJ/cm ² /log I)		4.3						
UVT (%)		≥ 98	≥ 95	≥ 90	≥ 85	≥ 80	≥ 75	≥ 65
Challenge UV sensitivity (mJ/cm ² /log I)		RED Bias						
Lower	Upper							
0	≤ 2	1.00	1.00	1.00	1.00	1.00	1.00	1.00
> 2	≤ 4	1.00	1.00	1.00	1.00	1.00	1.00	1.00
> 4	≤ 6	1.05	1.08	1.11	1.13	1.14	1.16	1.17
> 6	≤ 8	1.09	1.16	1.23	1.27	1.30	1.33	1.36
> 8	≤ 10	1.11	1.22	1.33	1.40	1.44	1.49	1.55
> 10	≤ 12	1.14	1.27	1.43	1.52	1.58	1.64	1.73
> 12	≤ 14	1.15	1.30	1.51	1.63	1.71	1.79	1.90
> 14	≤ 16	1.17	1.33	1.58	1.73	1.84	1.94	2.07
> 16	≤ 18	1.18	1.36	1.64	1.83	1.96	2.08	2.24
> 18	≤ 20	1.19	1.38	1.70	1.92	2.08	2.21	2.41
> 20	≤ 22	1.20	1.40	1.75	2.01	2.19	2.35	2.58
> 22	≤ 24	1.21	1.42	1.79	2.09	2.30	2.48	2.74
> 24	≤ 26	1.22	1.43	1.83	2.16	2.40	2.61	2.90
> 26	≤ 28	1.23	1.45	1.87	2.23	2.50	2.73	3.07
> 28	≤ 30	1.23	1.46	1.91	2.30	2.60	2.86	3.23
> 30	≤ 32	1.24	1.47	1.94	2.36	2.69	2.98	3.38
> 32	≤ 34	1.24	1.48	1.97	2.42	2.78	3.09	3.54

Table G.3. RED Bias Values for 3.0-log *Cryptosporidium* Inactivation Credit as a Function of UVT and UV Challenge Microorganism Sensitivity

<i>Cryptosporidium</i> log inactivation credit		3.0						
Required UV dose (mJ/cm ²)		12						
<i>Cryptosporidium</i> UV sensitivity (mJ/cm ² /log I)		4.0						
UVT (%)		≥ 98	≥ 95	≥ 90	≥ 85	≥ 80	≥ 75	≥ 65
Challenge UV sensitivity (mJ/cm ² /log I)		RED Bias						
Lower	Upper							
0	≤ 2	1.00	1.00	1.00	1.00	1.00	1.00	1.00
> 2	≤ 4	1.00	1.00	1.00	1.00	1.00	1.00	1.00
> 4	≤ 6	1.05	1.10	1.15	1.17	1.19	1.21	1.23
> 6	≤ 8	1.09	1.18	1.27	1.32	1.36	1.40	1.45
> 8	≤ 10	1.12	1.23	1.38	1.47	1.52	1.58	1.66
> 10	≤ 12	1.14	1.27	1.47	1.59	1.68	1.75	1.86
> 12	≤ 14	1.16	1.31	1.55	1.71	1.82	1.92	2.06
> 14	≤ 16	1.17	1.33	1.62	1.82	1.96	2.08	2.26
> 16	≤ 18	1.18	1.36	1.68	1.92	2.09	2.24	2.45
> 18	≤ 20	1.19	1.38	1.73	2.01	2.22	2.39	2.65
> 20	≤ 22	1.20	1.39	1.78	2.10	2.34	2.54	2.84
> 22	≤ 24	1.21	1.41	1.82	2.18	2.45	2.69	3.03
> 24	≤ 26	1.22	1.42	1.85	2.25	2.56	2.83	3.21
> 26	≤ 28	1.22	1.43	1.89	2.32	2.66	2.96	3.40
> 28	≤ 30	1.23	1.44	1.92	2.38	2.76	3.10	3.58
> 30	≤ 32	1.23	1.45	1.95	2.44	2.86	3.23	3.76
> 32	≤ 34	1.24	1.46	1.97	2.50	2.95	3.35	3.94

Table G.4. RED Bias Values for 2.5-log *Cryptosporidium* Inactivation Credit as a Function of UVT and UV Challenge Microorganism Sensitivity

<i>Cryptosporidium</i> log inactivation credit		2.5						
Required UV dose (mJ/cm ²)		8.5						
<i>Cryptosporidium</i> UV sensitivity (mJ/cm ² /log I)		3.4						
UVT (%)		≥ 98	≥ 95	≥ 90	≥ 85	≥ 80	≥ 75	≥ 65
Challenge UV sensitivity (mJ/cm ² /log I)		RED Bias						
Lower	Upper							
0	≤ 2	1.00	1.00	1.00	1.00	1.00	1.00	1.00
> 2	≤ 4	1.02	1.04	1.06	1.07	1.07	1.08	1.09
> 4	≤ 6	1.07	1.14	1.22	1.27	1.30	1.33	1.37
> 6	≤ 8	1.11	1.21	1.36	1.44	1.50	1.56	1.63
> 8	≤ 10	1.13	1.26	1.46	1.60	1.69	1.77	1.89
> 10	≤ 12	1.15	1.30	1.55	1.74	1.87	1.98	2.15
> 12	≤ 14	1.17	1.32	1.63	1.87	2.03	2.18	2.39
> 14	≤ 16	1.18	1.35	1.69	1.98	2.19	2.37	2.64
> 16	≤ 18	1.19	1.37	1.74	2.08	2.34	2.56	2.88
> 18	≤ 20	1.20	1.38	1.79	2.17	2.47	2.74	3.12
> 20	≤ 22	1.21	1.40	1.83	2.26	2.60	2.91	3.35
> 22	≤ 24	1.21	1.41	1.87	2.33	2.72	3.07	3.58
> 24	≤ 26	1.22	1.42	1.90	2.40	2.84	3.23	3.81
> 26	≤ 28	1.23	1.43	1.93	2.47	2.95	3.39	4.03
> 28	≤ 30	1.23	1.44	1.95	2.53	3.05	3.54	4.26
> 30	≤ 32	1.23	1.45	1.97	2.58	3.15	3.68	4.48
> 32	≤ 34	1.24	1.45	1.99	2.63	3.24	3.82	4.70

Table G.5. RED Bias Values for 2.0-log *Cryptosporidium* Inactivation Credit as a Function of UVT and UV Challenge Microorganism Sensitivity

<i>Cryptosporidium</i> log inactivation credit		2.0						
Required UV dose (mJ/cm ²)		5.8						
<i>Cryptosporidium</i> UV sensitivity (mJ/cm ² /log I)		2.9						
UVT (%)		≥ 98	≥ 95	≥ 90	≥ 85	≥ 80	≥ 75	≥ 65
Challenge UV sensitivity (mJ/cm ² /log I)		RED Bias						
Lower	Upper							
0	≤ 2	1.00	1.00	1.00	1.00	1.00	1.00	1.00
> 2	≤ 4	1.04	1.08	1.12	1.14	1.16	1.18	1.20
> 4	≤ 6	1.09	1.17	1.30	1.37	1.42	1.47	1.54
> 6	≤ 8	1.12	1.23	1.43	1.57	1.66	1.75	1.87
> 8	≤ 10	1.14	1.27	1.53	1.74	1.88	2.00	2.19
> 10	≤ 12	1.16	1.31	1.62	1.88	2.08	2.25	2.50
> 12	≤ 14	1.17	1.33	1.68	2.01	2.26	2.48	2.80
> 14	≤ 16	1.18	1.35	1.74	2.12	2.43	2.70	3.10
> 16	≤ 18	1.19	1.37	1.78	2.22	2.58	2.91	3.40
> 18	≤ 20	1.20	1.38	1.82	2.30	2.73	3.11	3.69
> 20	≤ 22	1.21	1.39	1.85	2.38	2.86	3.31	3.97
> 22	≤ 24	1.21	1.40	1.88	2.45	2.98	3.49	4.25
> 24	≤ 26	1.22	1.41	1.91	2.51	3.09	3.66	4.53
> 26	≤ 28	1.23	1.42	1.93	2.57	3.20	3.83	4.80
> 28	≤ 30	1.23	1.42	1.95	2.62	3.30	3.99	5.06
> 30	≤ 32	1.23	1.43	1.97	2.67	3.39	4.14	5.33
> 32	≤ 34	1.24	1.44	1.99	2.71	3.48	4.29	5.59

Table G.6. RED Bias Values for 1.5-log *Cryptosporidium* Inactivation Credit as a Function of UVT and UV Challenge Microorganism Sensitivity

<i>Cryptosporidium</i> log inactivation credit		1.5						
Required UV dose (mJ/cm ²)		3.9						
<i>Cryptosporidium</i> UV sensitivity (mJ/cm ² /log I)		2.6						
UVT (%)		≥ 98	≥ 95	≥ 90	≥ 85	≥ 80	≥ 75	≥ 65
Challenge UV sensitivity (mJ/cm ² /log I)		RED Bias						
Lower	Upper							
0	≤ 2	1.00	1.00	1.00	1.00	1.00	1.00	1.00
> 2	≤ 4	1.05	1.10	1.17	1.21	1.24	1.26	1.30
> 4	≤ 6	1.10	1.18	1.34	1.46	1.54	1.60	1.71
> 6	≤ 8	1.12	1.23	1.47	1.66	1.80	1.92	2.10
> 8	≤ 10	1.14	1.27	1.56	1.83	2.04	2.21	2.48
> 10	≤ 12	1.16	1.30	1.63	1.97	2.25	2.49	2.85
> 12	≤ 14	1.17	1.32	1.68	2.09	2.43	2.74	3.21
> 14	≤ 16	1.18	1.33	1.73	2.18	2.60	2.98	3.56
> 16	≤ 18	1.19	1.35	1.77	2.27	2.75	3.21	3.90
> 18	≤ 20	1.20	1.36	1.80	2.35	2.89	3.42	4.24
> 20	≤ 22	1.20	1.37	1.83	2.41	3.01	3.62	4.57
> 22	≤ 24	1.21	1.37	1.85	2.47	3.13	3.80	4.89
> 24	≤ 26	1.21	1.38	1.87	2.53	3.23	3.98	5.21
> 26	≤ 28	1.22	1.39	1.89	2.57	3.33	4.15	5.52
> 28	≤ 30	1.22	1.39	1.90	2.62	3.42	4.31	5.82
> 30	≤ 32	1.22	1.40	1.92	2.66	3.51	4.46	6.12
> 32	≤ 34	1.23	1.40	1.93	2.69	3.59	4.60	6.41

Table G.7. RED Bias Values for 1.0-log *Cryptosporidium* Inactivation Credit as a Function of UVT and UV Challenge Microorganism Sensitivity

<i>Cryptosporidium</i> log inactivation credit		1.0						
Required UV dose (mJ/cm ²)		2.5						
<i>Cryptosporidium</i> UV sensitivity (mJ/cm ² /log I)		2.5						
UVT (%)		≥ 98	≥ 95	≥ 90	≥ 85	≥ 80	≥ 75	≥ 65
Challenge UV sensitivity (mJ/cm ² /log I)		RED Bias						
Lower	Upper							
0	≤ 2	1.00	1.00	1.00	1.00	1.00	1.00	1.00
> 2	≤ 4	1.05	1.10	1.18	1.24	1.28	1.32	1.37
> 4	≤ 6	1.09	1.17	1.34	1.49	1.60	1.69	1.83
> 6	≤ 8	1.12	1.21	1.45	1.68	1.87	2.04	2.28
> 8	≤ 10	1.14	1.24	1.52	1.83	2.10	2.35	2.71
> 10	≤ 12	1.15	1.26	1.58	1.95	2.30	2.63	3.12
> 12	≤ 14	1.16	1.28	1.62	2.05	2.47	2.89	3.53
> 14	≤ 16	1.17	1.29	1.66	2.13	2.63	3.12	3.91
> 16	≤ 18	1.18	1.30	1.69	2.20	2.76	3.34	4.29
> 18	≤ 20	1.18	1.31	1.71	2.26	2.88	3.54	4.66
> 20	≤ 22	1.19	1.32	1.73	2.32	2.99	3.73	5.01
> 22	≤ 24	1.19	1.33	1.75	2.36	3.09	3.90	5.36
> 24	≤ 26	1.20	1.33	1.76	2.40	3.18	4.06	5.69
> 26	≤ 28	1.20	1.34	1.78	2.44	3.26	4.22	6.02
> 28	≤ 30	1.20	1.34	1.79	2.47	3.33	4.36	6.33
> 30	≤ 32	1.21	1.35	1.80	2.50	3.40	4.49	6.64
> 32	≤ 34	1.21	1.35	1.81	2.53	3.47	4.62	6.94

Table G.8. RED Bias Values for 0.5-log *Cryptosporidium* Inactivation Credit as a Function of UVT and UV Challenge Microorganism Sensitivity

<i>Cryptosporidium</i> log inactivation credit		0.5						
Required UV dose (mJ/cm ²)		1.6						
<i>Cryptosporidium</i> UV sensitivity (mJ/cm ² /log I)		3.2						
UVT (%)		≥ 98	≥ 95	≥ 90	≥ 85	≥ 80	≥ 75	≥ 65
Challenge UV sensitivity (mJ/cm ² /log I)		RED Bias						
Lower	Upper							
0	≤ 2	1.00	1.00	1.00	1.00	1.00	1.00	1.00
> 2	≤ 4	1.02	1.04	1.07	1.10	1.13	1.15	1.18
> 4	≤ 6	1.06	1.10	1.19	1.30	1.40	1.49	1.62
> 6	≤ 8	1.08	1.13	1.27	1.44	1.61	1.78	2.04
> 8	≤ 10	1.10	1.15	1.32	1.55	1.79	2.03	2.42
> 10	≤ 12	1.11	1.17	1.36	1.63	1.93	2.24	2.79
> 12	≤ 14	1.12	1.18	1.39	1.69	2.04	2.43	3.13
> 14	≤ 16	1.12	1.19	1.41	1.74	2.15	2.60	3.45
> 16	≤ 18	1.13	1.20	1.43	1.79	2.23	2.75	3.76
> 18	≤ 20	1.14	1.21	1.45	1.83	2.31	2.89	4.06
> 20	≤ 22	1.14	1.21	1.46	1.86	2.38	3.02	4.33
> 22	≤ 24	1.14	1.22	1.47	1.89	2.44	3.13	4.60
> 24	≤ 26	1.15	1.22	1.48	1.91	2.49	3.24	4.86
> 26	≤ 28	1.15	1.23	1.49	1.93	2.54	3.33	5.10
> 28	≤ 30	1.15	1.23	1.50	1.95	2.58	3.43	5.34
> 30	≤ 32	1.16	1.23	1.51	1.97	2.62	3.51	5.56
> 32	≤ 34	1.16	1.23	1.51	1.98	2.66	3.59	5.78

Table G.9. RED Bias Values for 4.0-log *Giardia* Inactivation Credit as a Function of UVT and UV Challenge Microorganism Sensitivity

<i>Giardia</i> log inactivation credit		4.0						
Required UV dose (mJ/cm ²)		22						
<i>Giardia</i> UV sensitivity (mJ/cm ² /log I)		5.5						
UVT (%)		≥ 98	≥ 95	≥ 90	≥ 85	≥ 80	≥ 75	≥ 65
Challenge UV sensitivity (mJ/cm ² /log I)		RED Bias						
Lower	Upper							
0	≤ 2	1.00	1.00	1.00	1.00	1.00	1.00	1.00
> 2	≤ 4	1.00	1.00	1.00	1.00	1.00	1.00	1.00
> 4	≤ 6	1.00	1.00	1.00	1.00	1.00	1.00	1.00
> 6	≤ 8	1.01	1.02	1.03	1.03	1.03	1.03	1.04
> 8	≤ 10	1.05	1.09	1.12	1.14	1.16	1.17	1.18
> 10	≤ 12	1.08	1.15	1.21	1.25	1.27	1.30	1.33
> 12	≤ 14	1.11	1.20	1.29	1.34	1.38	1.42	1.46
> 14	≤ 16	1.13	1.24	1.37	1.44	1.49	1.53	1.60
> 16	≤ 18	1.15	1.28	1.44	1.53	1.59	1.65	1.73
> 18	≤ 20	1.16	1.31	1.50	1.61	1.69	1.76	1.86
> 20	≤ 22	1.17	1.34	1.55	1.69	1.78	1.87	1.99
> 22	≤ 24	1.18	1.36	1.61	1.77	1.87	1.97	2.11
> 24	≤ 26	1.19	1.38	1.66	1.84	1.96	2.08	2.24
> 26	≤ 28	1.20	1.40	1.70	1.91	2.05	2.18	2.36
> 28	≤ 30	1.21	1.41	1.74	1.98	2.14	2.28	2.48
> 30	≤ 32	1.22	1.43	1.78	2.04	2.22	2.38	2.60
> 32	≤ 34	1.22	1.44	1.81	2.10	2.30	2.47	2.73

Table G.10. RED Bias Values for 3.5-log *Giardia* Inactivation Credit as a Function of UVT and UV Challenge Microorganism Sensitivity

<i>Giardia</i> log inactivation credit		3.5						
Required UV dose (mJ/cm ²)		15						
<i>Giardia</i> UV sensitivity (mJ/cm ² /log I)		4.3						
UVT (%)		≥ 98	≥ 95	≥ 90	≥ 85	≥ 80	≥ 75	≥ 65
Challenge UV sensitivity (mJ/cm ² /log I)		RED Bias						
Lower	Upper							
0	≤ 2	1.00	1.00	1.00	1.00	1.00	1.00	1.00
> 2	≤ 4	1.00	1.00	1.00	1.00	1.00	1.00	1.00
> 4	≤ 6	1.05	1.08	1.11	1.13	1.14	1.16	1.17
> 6	≤ 8	1.09	1.16	1.23	1.27	1.30	1.33	1.36
> 8	≤ 10	1.11	1.22	1.33	1.40	1.44	1.49	1.55
> 10	≤ 12	1.14	1.27	1.43	1.52	1.58	1.64	1.73
> 12	≤ 14	1.15	1.30	1.51	1.63	1.71	1.79	1.90
> 14	≤ 16	1.17	1.33	1.58	1.73	1.84	1.94	2.07
> 16	≤ 18	1.18	1.36	1.64	1.83	1.96	2.08	2.24
> 18	≤ 20	1.19	1.38	1.70	1.92	2.08	2.21	2.41
> 20	≤ 22	1.20	1.40	1.75	2.01	2.19	2.35	2.58
> 22	≤ 24	1.21	1.42	1.79	2.09	2.30	2.48	2.74
> 24	≤ 26	1.22	1.43	1.83	2.16	2.40	2.61	2.90
> 26	≤ 28	1.23	1.45	1.87	2.23	2.50	2.73	3.07
> 28	≤ 30	1.23	1.46	1.91	2.30	2.60	2.86	3.23
> 30	≤ 32	1.24	1.47	1.94	2.36	2.69	2.98	3.38
> 32	≤ 34	1.24	1.48	1.97	2.42	2.78	3.09	3.54

Table G.11. RED Bias Values for 3.0-log *Giardia* Inactivation Credit as a Function of UVT and UV Challenge Microorganism Sensitivity

<i>Giardia</i> log inactivation credit		3.0						
Required UV dose (mJ/cm ²)		11						
<i>Giardia</i> UV sensitivity (mJ/cm ² /log I)		3.7						
UVT (%)		≥ 98	≥ 95	≥ 90	≥ 85	≥ 80	≥ 75	≥ 65
Challenge UV sensitivity (mJ/cm ² /log I)		RED Bias						
Lower	Upper							
0	≤ 2	1.00	1.00	1.00	1.00	1.00	1.00	1.00
> 2	≤ 4	1.01	1.02	1.03	1.03	1.03	1.03	1.04
> 4	≤ 6	1.07	1.12	1.18	1.21	1.23	1.25	1.28
> 6	≤ 8	1.10	1.20	1.31	1.37	1.41	1.45	1.51
> 8	≤ 10	1.13	1.25	1.42	1.52	1.58	1.65	1.74
> 10	≤ 12	1.15	1.29	1.51	1.65	1.74	1.83	1.95
> 12	≤ 14	1.16	1.32	1.59	1.77	1.90	2.01	2.17
> 14	≤ 16	1.18	1.35	1.66	1.89	2.04	2.18	2.38
> 16	≤ 18	1.19	1.37	1.72	1.99	2.18	2.34	2.59
> 18	≤ 20	1.20	1.39	1.77	2.08	2.31	2.51	2.79
> 20	≤ 22	1.21	1.41	1.81	2.17	2.43	2.66	2.99
> 22	≤ 24	1.22	1.42	1.85	2.25	2.55	2.81	3.19
> 24	≤ 26	1.22	1.44	1.89	2.32	2.66	2.96	3.39
> 26	≤ 28	1.23	1.45	1.92	2.39	2.77	3.11	3.59
> 28	≤ 30	1.24	1.46	1.95	2.46	2.87	3.25	3.78
> 30	≤ 32	1.24	1.47	1.98	2.52	2.97	3.38	3.98
> 32	≤ 34	1.25	1.47	2.00	2.57	3.06	3.52	4.17

Table G.12. RED Bias Values for 2.5-log *Giardia* Inactivation Credit as a Function of UVT and UV Challenge Microorganism Sensitivity

<i>Giardia</i> log inactivation credit		2.5						
Required UV dose (mJ/cm ²)		7.7						
<i>Giardia</i> UV sensitivity (mJ/cm ² /log I)		3.1						
UVT (%)		≥ 98	≥ 95	≥ 90	≥ 85	≥ 80	≥ 75	≥ 65
Challenge UV sensitivity (mJ/cm ² /log I)		RED Bias						
Lower	Upper							
0	≤ 2	1.00	1.00	1.00	1.00	1.00	1.00	1.00
> 2	≤ 4	1.03	1.06	1.09	1.11	1.12	1.13	1.14
> 4	≤ 6	1.08	1.16	1.26	1.32	1.35	1.39	1.44
> 6	≤ 8	1.12	1.23	1.40	1.50	1.57	1.63	1.73
> 8	≤ 10	1.14	1.28	1.51	1.67	1.77	1.87	2.00
> 10	≤ 12	1.16	1.32	1.60	1.81	1.96	2.09	2.27
> 12	≤ 14	1.18	1.34	1.67	1.94	2.13	2.30	2.54
> 14	≤ 16	1.19	1.37	1.74	2.06	2.29	2.50	2.80
> 16	≤ 18	1.20	1.39	1.79	2.16	2.45	2.70	3.06
> 18	≤ 20	1.21	1.40	1.83	2.25	2.59	2.88	3.31
> 20	≤ 22	1.22	1.42	1.87	2.34	2.72	3.07	3.56
> 22	≤ 24	1.22	1.43	1.91	2.41	2.85	3.24	3.81
> 24	≤ 26	1.23	1.44	1.94	2.48	2.97	3.41	4.05
> 26	≤ 28	1.23	1.45	1.97	2.55	3.08	3.57	4.30
> 28	≤ 30	1.24	1.46	1.99	2.61	3.18	3.73	4.53
> 30	≤ 32	1.24	1.46	2.01	2.66	3.28	3.88	4.77
> 32	≤ 34	1.25	1.47	2.03	2.71	3.38	4.02	5.00

Table G.13. RED Bias Values for 2.0-log *Giardia* Inactivation Credit as a Function of UVT and UV Challenge Microorganism Sensitivity

<i>Giardia</i> log inactivation credit		2.0						
Required UV dose (mJ/cm ²)		5.2						
<i>Giardia</i> UV sensitivity (mJ/cm ² /log I)		2.6						
UVT (%)		≥ 98	≥ 95	≥ 90	≥ 85	≥ 80	≥ 75	≥ 65
Challenge UV sensitivity (mJ/cm ² /log I)		RED Bias						
Lower	Upper							
0	≤ 2	1.00	1.00	1.00	1.00	1.00	1.00	1.00
> 2	≤ 4	1.05	1.11	1.17	1.20	1.22	1.24	1.27
> 4	≤ 6	1.10	1.20	1.35	1.44	1.50	1.56	1.64
> 6	≤ 8	1.13	1.26	1.48	1.65	1.76	1.85	1.99
> 8	≤ 10	1.15	1.30	1.59	1.82	1.99	2.13	2.34
> 10	≤ 12	1.17	1.33	1.67	1.97	2.19	2.39	2.67
> 12	≤ 14	1.18	1.36	1.74	2.10	2.39	2.64	3.00
> 14	≤ 16	1.20	1.37	1.79	2.21	2.56	2.87	3.32
> 16	≤ 18	1.21	1.39	1.84	2.31	2.72	3.09	3.64
> 18	≤ 20	1.21	1.40	1.87	2.40	2.87	3.30	3.95
> 20	≤ 22	1.22	1.41	1.91	2.48	3.01	3.51	4.25
> 22	≤ 24	1.23	1.42	1.94	2.55	3.13	3.70	4.55
> 24	≤ 26	1.23	1.43	1.96	2.61	3.25	3.88	4.85
> 26	≤ 28	1.24	1.44	1.98	2.67	3.36	4.06	5.14
> 28	≤ 30	1.24	1.45	2.01	2.72	3.46	4.22	5.43
> 30	≤ 32	1.24	1.45	2.02	2.77	3.56	4.38	5.71
> 32	≤ 34	1.25	1.46	2.04	2.81	3.65	4.54	5.98

Table G.14. RED Bias Values for 1.5-log *Giardia* Inactivation Credit as a Function of UVT and UV Challenge Microorganism Sensitivity

<i>Giardia</i> log inactivation credit		1.5						
Required UV dose (mJ/cm ²)		3.0						
<i>Giardia</i> UV sensitivity (mJ/cm ² /log I)		2.0						
UVT (%)		≥ 98	≥ 95	≥ 90	≥ 85	≥ 80	≥ 75	≥ 65
Challenge UV sensitivity (mJ/cm ² /log I)		RED Bias						
Lower	Upper							
0	≤ 2	1.00	1.00	1.00	1.00	1.00	1.00	1.00
> 2	≤ 4	1.08	1.16	1.28	1.35	1.40	1.45	1.51
> 4	≤ 6	1.13	1.25	1.47	1.63	1.75	1.84	1.99
> 6	≤ 8	1.15	1.30	1.60	1.86	2.05	2.21	2.45
> 8	≤ 10	1.17	1.33	1.69	2.04	2.31	2.55	2.89
> 10	≤ 12	1.19	1.36	1.77	2.19	2.54	2.86	3.32
> 12	≤ 14	1.20	1.38	1.82	2.31	2.75	3.15	3.75
> 14	≤ 16	1.21	1.39	1.87	2.42	2.93	3.42	4.16
> 16	≤ 18	1.22	1.41	1.91	2.51	3.10	3.68	4.56
> 18	≤ 20	1.23	1.42	1.94	2.59	3.25	3.92	4.96
> 20	≤ 22	1.23	1.43	1.96	2.66	3.39	4.14	5.34
> 22	≤ 24	1.24	1.43	1.99	2.72	3.51	4.35	5.72
> 24	≤ 26	1.24	1.44	2.01	2.78	3.63	4.55	6.08
> 26	≤ 28	1.25	1.45	2.03	2.83	3.74	4.74	6.44
> 28	≤ 30	1.25	1.45	2.04	2.87	3.84	4.92	6.80
> 30	≤ 32	1.25	1.46	2.06	2.91	3.93	5.09	7.14
> 32	≤ 34	1.26	1.46	2.07	2.95	4.01	5.25	7.48

Table G.15. RED Bias Values for 1.0-log *Giardia* Inactivation Credit as a Function of UVT and UV Challenge Microorganism Sensitivity

<i>Giardia</i> log inactivation credit		1.0						
Required UV dose (mJ/cm ²)		2.1						
<i>Giardia</i> UV sensitivity (mJ/cm ² /log I)		2.1						
UVT (%)		≥ 98	≥ 95	≥ 90	≥ 85	≥ 80	≥ 75	≥ 65
Challenge UV sensitivity (mJ/cm ² /log I)		RED Bias						
Lower	Upper							
0	≤ 2	1.00	1.00	1.00	1.00	1.00	1.00	1.00
> 2	≤ 4	1.07	1.14	1.26	1.34	1.40	1.45	1.52
> 4	≤ 6	1.11	1.21	1.42	1.61	1.75	1.86	2.04
> 6	≤ 8	1.14	1.25	1.53	1.82	2.04	2.24	2.53
> 8	≤ 10	1.16	1.28	1.61	1.98	2.29	2.58	3.01
> 10	≤ 12	1.17	1.30	1.67	2.10	2.51	2.89	3.47
> 12	≤ 14	1.18	1.32	1.72	2.21	2.70	3.17	3.91
> 14	≤ 16	1.19	1.33	1.75	2.30	2.86	3.43	4.35
> 16	≤ 18	1.20	1.34	1.78	2.37	3.01	3.67	4.77
> 18	≤ 20	1.20	1.35	1.81	2.44	3.14	3.89	5.17
> 20	≤ 22	1.21	1.36	1.83	2.49	3.25	4.10	5.57
> 22	≤ 24	1.21	1.37	1.84	2.54	3.36	4.29	5.95
> 24	≤ 26	1.22	1.37	1.86	2.58	3.46	4.47	6.32
> 26	≤ 28	1.22	1.38	1.87	2.62	3.55	4.63	6.68
> 28	≤ 30	1.22	1.38	1.89	2.66	3.63	4.79	7.03
> 30	≤ 32	1.22	1.38	1.90	2.69	3.70	4.94	7.38
> 32	≤ 34	1.23	1.39	1.91	2.72	3.77	5.08	7.71

Table G.16. RED Bias Values for 0.5-log *Giardia* Inactivation Credit as a Function of UVT and UV Challenge Microorganism Sensitivity

<i>Giardia</i> log inactivation credit		0.5						
Required UV dose (mJ/cm ²)		1.5						
<i>Giardia</i> UV sensitivity (mJ/cm ² /log I)		3.0						
UVT (%)		≥ 98	≥ 95	≥ 90	≥ 85	≥ 80	≥ 75	≥ 65
Challenge UV sensitivity (mJ/cm ² /log I)		RED Bias						
Lower	Upper							
0	≤ 2	1.00	1.00	1.00	1.00	1.00	1.00	1.00
> 2	≤ 4	1.03	1.05	1.09	1.14	1.17	1.20	1.24
> 4	≤ 6	1.06	1.11	1.22	1.34	1.45	1.55	1.70
> 6	≤ 8	1.09	1.14	1.29	1.49	1.67	1.85	2.13
> 8	≤ 10	1.10	1.16	1.35	1.59	1.85	2.11	2.54
> 10	≤ 12	1.11	1.18	1.39	1.68	2.00	2.34	2.92
> 12	≤ 14	1.12	1.19	1.42	1.74	2.12	2.54	3.28
> 14	≤ 16	1.13	1.20	1.44	1.80	2.23	2.72	3.63
> 16	≤ 18	1.14	1.21	1.46	1.84	2.32	2.88	3.95
> 18	≤ 20	1.14	1.22	1.48	1.88	2.40	3.02	4.26
> 20	≤ 22	1.15	1.22	1.49	1.91	2.47	3.15	4.56
> 22	≤ 24	1.15	1.23	1.50	1.94	2.53	3.28	4.84
> 24	≤ 26	1.15	1.23	1.51	1.97	2.59	3.39	5.11
> 26	≤ 28	1.16	1.24	1.52	1.99	2.64	3.49	5.37
> 28	≤ 30	1.16	1.24	1.53	2.01	2.69	3.58	5.62
> 30	≤ 32	1.16	1.24	1.53	2.03	2.73	3.67	5.86
> 32	≤ 34	1.16	1.25	1.54	2.04	2.77	3.76	6.09

Table G.17. RED Bias Values for Virus Inactivation Credit as a Function of UV Challenge Microorganism Sensitivity

Virus log inactivation credit		0.5	1.0	1.5	2.0	2.5	3.0	3.5	4.0
Required UV dose (mJ/cm ²)		39	58	79	100	121	143	163	186
Virus UV sensitivity (mJ/cm ² /log I)		78	58	53	50	48	48	47	47
Challenge UV sensitivity (mJ/cm ² /log I)		RED Bias							
Lower	Upper								
> 1	≤ 25	1.00	1.00	1.00	1.00	1.00	1.00	1.00	1.00
> 25	≤ 50	1.00	1.00	1.00	1.00	1.01	1.01	1.01	1.01
> 50	≤ 60	1.00	1.00	1.02	1.03	1.03	1.03	1.04	1.04
> 60	≤ 70	1.00	1.02	1.04	1.05	1.05	1.05	1.06	1.06
> 70	≤ 80	1.00	1.04	1.05	1.06	1.07	1.07	1.07	1.07
> 80	≤ 90	1.01	1.05	1.06	1.07	1.08	1.08	1.08	1.08
> 90	≤ 100	1.02	1.06	1.07	1.08	1.09	1.09	1.09	1.09
> 90	≤ 100	1.02	1.06	1.07	1.08	1.09	1.09	1.09	1.09